

TECHNICAL MANUAL

**OPERATOR'S, UNIT, AND DIRECT SUPPORT
MAINTENANCE MANUAL
(INCLUDING REPAIR PARTS AND SPECIAL TOOLS LIST)
FOR**

**REPLACEMENT FREQUENCY
MODULATED ORDERWIRE (RFMOW)**

**(AN/GSC-69(V)1, NSN: 5895-01-522-2119 (85 Terminal),
NSN: 5975-01-529-3943 (Rack Adapter Kit for 85 Terminal),
AN/GSC-69(V)2, NSN: 5895-01-522-2117 (93 Terminal))
EIC: N/A**

VERIFIED DRAFT

Rev. 01 March 20, 2007

Distribution authorized to the Department of Defense and DOD contractors only for official use or for administrative or operational purposes. This determination was made on 15 MAY 2004. Other requests for this document will be referred to Commander, US Army Communications-Electronics Command and Fort Monmouth, ATTN: AMSEL-LC-COM-T- SLEP, Fort Monmouth, New Jersey 07703-5007.

HANDLING AND DESTRUCTION NOTICE – Comply with distribution statement and destroy by any method that will prevent disclosure of contents or reconstruction of the document.

This page left blank intentionally.



5

**SAFETY STEPS TO FOLLOW IF SOMEONE
IS THE VICTIM OF ELECTRICAL SHOCK**

1

DO NOT TRY TO PULL OR GRAB THE INDIVIDUAL

2

IF POSSIBLE, TURN OFF THE ELECTRICAL POWER

3

**IF YOU CANNOT TURN OFF THE ELECTRICAL
POWER, PULL, PUSH, OR LIFT THE PERSON TO
SAFETY USING A DRY WOODEN POLE OR A DRY
ROPE OR SOME OTHER INSULATING MATERIAL**

4

SEND FOR HELP AS SOON AS POSSIBLE

5

**AFTER THE INJURED PERSON IS FREE OF
CONTACT WITH THE SOURCE OF ELECTRICAL
SHOCK, MOVE THE PERSON A SHORT DISTANCE
AWAY AND IMMEDIATELY START ARTIFICIAL
RESUSCITATION**

SAFETY SUMMARY

Warnings, Cautions, and Notes which appear in this manual are defined as follows:

WARNING

An operating or maintenance procedure, practice, condition, statement, etc., which, if not strictly observed, could result in injury to or death of personnel.

CAUTION

An operating or maintenance procedure, practice, condition, statement, etc., which, if not strictly observed, could result in damage to, or destruction of, equipment or loss of mission effectiveness or long term health hazards to personnel.

NOTE

An essential operating or maintenance procedure, condition, or statement which must be highlighted.

WARNING

Proper grounding is an important safety feature, and must be a primary consideration in all electrical and electronic equipment installations. Ensure that all grounding connections are secure and that all grounding cables are kept out of vehicle and personnel paths.

WARNING

Use extreme care when working around electrical equipment to avoid the possibility of severe or fatal electrical shock. Remove all jewelry (i.e. rings, necklaces, etc.) before working with the RFMOW.

WARNING

Ensure that all power connections are properly insulated, clean, and mechanically secure to prevent personnel injury when the RFMOW is powered up and operated. When the RFMOW power cables are installed, carefully inspect all connectors and wiring for worn or broken parts. Make any necessary repairs before powering up the RFMOW. If any cable or connector damage is discovered while the RFMOW is operating, the RFMOW should be powered down and the damage repaired immediately.

WARNING

Even with covers removed, lethal voltages may still be present inside the RFMOW. Failure to exercise caution could result in fatal or serious injury to personnel.

WARNING

High voltage, 120 VAC, is present in this equipment. Use extreme caution and ensure that at least two people are present while performing inspection, test, and maintenance procedures. Failure to comply may result in fatal or serious injury to personnel.

WARNING

Ensure that power is removed during the performance of equipment replacement and cleaning procedures. Do not open equipment enclosures when cleaning. Use of damp cleaning materials can cause shock, resulting in fatal or serious injury to personnel.

WARNING

Hazardous voltages are present. Use care when measuring for voltage. Failure to do so can result in fatal or serious injury to personnel.

WARNING

RFMOW weight in the crate is approximately 180 lbs. (81.65 kg). A forklift or equivalent is required to move the crate. Individual weights of items in the crate are listed in section 1.15.1 (not including shipping materials). Two persons are required to install the RFMOW Rack, which is approximately 74 lbs. (33.57 kg). Failure to comply may result in fatal or serious injury to personnel, and/or damage to the equipment.

CAUTION

This equipment contains static-sensitive devices. Always follow ESD handling procedures when working on this equipment.

FOREWORD

PURPOSE:

This manual provides operation and maintenance information for the Replacement Frequency Modulated Orderwire (RFMOW).

HOW TO USE THIS MANUAL:

Step-by-step procedures with illustrations give all the necessary information to setup, operate, and maintain this equipment at unit levels only. Do not attempt any procedure before first becoming familiar with the entire procedure.

For general information, use the table of contents in the front of this book to locate chapters and sections containing this information.

SCOPE:

This technical manual covers procedures and supporting information required for operating and maintaining the RFMOW. Coverage includes operating, maintenance instructions, troubleshooting, test, and repair data. The material presented in this manual is written for experienced operator and maintenance personnel responsible for the RFMOW. Standard shop practices used during maintenance are not described.

ARRANGEMENT:

This manual is arranged into five chapters and five appendixes. A brief description of each chapter follows:

- | | |
|-------------------|---|
| Chapter 1 | Equipment Description and Data – Provides general information and brief description of the RFMOW including system description, technical characteristics, equipment supplied, and equipment required but not supplied. |
| Chapter 2 | Operating Instructions – Provides identification of all operating controls, indicators, connectors, and operating procedures. Operating procedures for power up, system initialization, preliminary checkout, operation and power down are included. |
| Chapter 3 | Troubleshooting – Provides information on troubleshooting the RFMOW, as well as pin out diagrams and schematics. |
| Chapter 4 | Maintenance Instructions - Contains maintenance concept, preventive and corrective maintenance procedures, and removal and replacement procedures. |
| Chapter 5 | Repair Parts and Special Tools List - Provides part lists for the RFMOW. |
| Appendix A | Reference Publications – Provides information on reference documentation related to the RFMOW. |
| Appendix B | Maintenance Allocation Charts – Provides the Maintenance Allocation Chart (MAC) for the RFMOW 41700-8593. |
| Appendix C | Components of End Item and Basic Issue Items – Lists items required to enable safe and efficient operation of the RFMOW. |
| Appendix D | Expendable/Durable Items List – Lists items needed to operate and maintain the RFMOW. |
| Appendix E | Manual Equipment Configuration Procedures – Lists items needed to be manually configured. |
| Appendix F | Power Balance/Alignment Procedure – Provides procedure for aligning the terminal. |
| Appendix G | Software Operation – Provides procedures to power up and to conduct normal network operations. |
| Appendix H | Glossary – Lists acronyms and abbreviations used in this manual. |

DEFINITIONS:

The word "shall" is used in this manual to express a provision that is binding. The word "will" is used to express a mandatory declaration of purpose or when it is necessary to express a future event. The words "should" and "may" are used when it is necessary to express non-mandatory provisions.

WARRANTY INFORMATION.

The following instructions are for the RFMOW 41700-8593 equipment requirements. The Raven Electronics Corporation equipment, RFMOW, includes a factory warranty of 24 months. All warranties are tracked by serial number. Please contact our Repair Department for warranty expiration date. Failures resulting from material/workmanship defects will be repaired under the warranty.

Warranty Claims: All warranty claims must be initiated by the organization using the equipment. This process will start with the user notifying the contractor, Raven Electronics Corporation. Log onto Raven Electronics Corporation website at:

<http://www.ravencomm.com/RMA>

Complete worksheet and select "Submit". Raven personnel will assign a Repair Maintenance Authorization (RMA) number, followed by response via telephone or email within 48 hours. Upon assignment of RMA number, return equipment to Raven Electronics Corporation. Raven Electronics Corporation will respond with replacement or repair of equipment upon verification of failure.

RETURN SHIPPING ADDRESS.

Raven Electronics Corporation
400 Edison Way
Reno, NV 89502

Attn: Repair Department

HOTLINE: (866) 329-2363 Toll-free
(775) 858-2400 Outside the continental United States

**OPERATOR'S, UNIT, AND DIRECT SUPPORT
MAINTENANCE MANUAL
(INCLUDING REPAIR PARTS AND SPECIAL TOOLS LIST)
FOR**

REPLACEMENT FREQUENCY MODULATED ORDERWIRE (RFMOW)

**(AN/GSC-69(V)1, NSN: 5895-01-522-2119 (85 Terminal),
NSN: 5975-01-529-3943 (Rack Adapter Kit for 85 Terminal),
AN/GSC-69(V)2, NSN: 5895-01-522-2117 (93 Terminal))
EIC: N/A**

REPORTING ERRORS AND RECOMMENDING IMPROVEMENTS

You can help improve this manual. If you find any mistakes, or if you know of a way to improve the procedures, please let us know. Mail your letter or comments directly to: Commander, US Army Communications-Electronics Command and Fort Monmouth, ATTN: AMSEL-LC-COM-T-SLEP, Fort Monmouth, New Jersey 07703-5000. The fax number is 732-532-4525, DSN 992-4628. You may also e-mail your recommendations to Charles.J.Genere@us.army.mil.

In either case a reply will be furnished direct to you.

This page left blank intentionally.

TABLE OF CONTENTS

<u>Chapter</u>	<u>Title</u>	<u>Page</u>
	SAFETY SUMMARY	A
	LIST OF EFFECTIVE PAGES	E
	FOREWORD	F
	TABLE OF CONTENTS	i
	LIST OF ILLUSTRATIONS	vii
	LIST OF TABLES	xi
CHAPTER 1	GENERAL INFORMATION, EQUIPMENT DESCRIPTION AND THEORY OF OPERATION	1-1
1.1	SCOPE	1-1
1.2	MAINTENANCE FORMS, RECORDS, AND REPORTS	1-2
1.3	REPORT EQUIPMENT IMPROVEMENT RECOMMENDATIONS (EIR)	1-2
1.4	CORROSION PREVENTION AND CONTROL (CPC)	1-2
1.5	DESTRUCTION OF ARMY ELECTRONICS MATERIAL	1-2
1.6	PREPARATION FOR STORAGE OR SHIPMENT	1-2
1.7	WARRANTY INFORMATION	1-3
1.8	LIST OF ABBREVIATIONS/ACRONYMS	1-4
1.9	QUALITY OF MATERIAL	1-4
1.10	SAFETY, CARE, AND HANDLING	1-4
1.11	EQUIPMENT DESCRIPTION AND DATA	1-4
1.12	EQUIPMENT CHARACTERISTICS, CAPABILITIES, AND FEATURES	1-4
1.12.1	Earth Segment	1-4
1.12.1.1	Subscriber	1-4
1.12.1.2	Satellite Earth Terminal	1-5
1.12.1.2.1	Baseband Equipment Group	1-5
1.12.1.2.2	Modem Equipment Group	1-5
1.12.1.2.3	Transmitter Equipment Group	1-5
1.12.1.2.4	Receiver Equipment Group	1-5
1.12.1.2.5	Antenna Equipment Group	1-5
1.12.2	Description	1-6
1.13	LOCATION AND DESCRIPTION OF MAJOR COMPONENTS	1-6
1.14	DIFFERENCES BETWEEN MODELS	1-29
1.15	TECHNICAL CHARACTERISTICS	1-29
1.15.1	Physical Characteristics	1-29
1.15.2	Electrical Characteristics	1-32
1.15.3	Environmental Characteristics	1-32
1.16	EQUIPMENT SUPPLIED	1-32
1.17	EQUIPMENT REQUIRED BUT NOT SUPPLIED	1-32
1.18	INITIAL INSTALLATION AND SETUP	1-33
1.19	EQUIPMENT LOCATION AND MOUNTING	1-33
1.20	POWER DISTRIBUTION AND GROUNDING	1-33
1.20.1	Power Distribution	1-33
1.20.2	Grounding	1-33
1.21	RFMOW UNPACKING	1-34
1.22	SETUP AND PREPARATION FOR USE: ALL MODELS	1-34
1.23	COOLING SYSTEM	1-34
CHAPTER 2	OPERATING INSTRUCTIONS	2-1
2.1	INTRODUCTION	2-1
2.2	PRINCIPLES OF OPERATION	2-1
2.2.1	Subsystems – Servers and Clients	2-1
2.2.2	Subnets	2-2
2.2.3	Network Messages	2-2
2.2.3.1	Network Control Messages	2-3

TABLE OF CONTENTS (Cont.)

<u>Chapter</u>	<u>Title</u>	<u>Page</u>
CHAPTER 2	OPERATING INSTRUCTIONS	<u>2-1</u>
2.2.3.2	Network Login/Logout Messages	2-4
2.2.3.3	Equipment Control Messages.....	2-4
2.2.3.4	Network Data Messages.....	2-4
2.2.3.5	Secure Voice Configuration Messages	2-5
2.2.4	Forward Orderwire (FOW) Channel.....	2-5
2.2.5	Return Orderwire (ROW) Channel.....	2-5
2.2.5.1	ROW Structure.....	2-5
2.2.5.2	ROW Utilization.....	2-6
2.2.6	Network Modes of Operation	2-7
2.2.7	Maintenance of Control Link Quality	2-8
2.2.8	Operation of Text Orderwire	2-9
2.2.9	Operation of the Secure Voice Orderwire.....	2-10
2.2.10	File Transfer	2-11
2.2.11	Network Control Handover	2-11
2.2.12	File Management	2-11
2.2.13	Equipment States.....	2-11
2.3	EQUIPMENT THEORY OF OPERATION	2-12
2.3.1	Device Control	2-12
2.3.2	“A/B” Switch Operation	2-12
2.3.3	Sonalert Operation.....	2-12
2.3.4	Data Communications	2-12
2.3.5	Voice Communications	2-12
2.3.6	Enable Auto TX Off Switch on Interface Unit.....	2-13
2.4	CONTROLS AND INDICATORS	2-13
2.4.1	SDM-300A Controls and Indicators	2-13
2.4.2	Interface Unit Controls and Indicators	2-14
2.5	EQUIPMENT DESCRIPTION	2-15
2.6	EQUIPMENT POWER-UP	2-17
2.7	EQUIPMENT POWER-DOWN	2-17
2.8	NT INSTALLATION, CONFIGURATION, AND CHECKOUT	2-18
2.8.1	Equipment List	2-18
2.8.2	Installation Procedures	2-18
2.8.3	Equipment Configuration	2-20
2.8.4	Equipment Checkout Procedures	2-20
2.8.5	RFMOW Software Installation	2-20
2.8.5.1	Un-Zip Procedures.....	2-20
2.8.5.2	Install RFMOW Software	2-21
2.8.6	RFMOW Software Un-Installation.....	2-23
CHAPTER 3	TROUBLESHOOTING	3-1
3.1	INTRODUCTION	3-1
3.2	TROUBLESHOOTING	3-1
3.3	CONNECTOR PIN OUTS	3-23
3.3.1	Enclosure Panel.....	3-23
3.3.2	SDM-300A Modem	3-25
3.3.3	Fan Panel.....	3-27
3.3.4	Computer	3-28
3.3.5	Keyboard/Monitor/Mouse.....	3-33
3.3.6	Interface Unit.....	3-35

TABLE OF CONTENTS (Cont.)

<u>Chapter</u>	<u>Title</u>	<u>Page</u>
CHAPTER 4	MAINTENANCE AND INFORMATION	4-1
4.1	INTRODUCTION	4-1
4.2	MAINTENANCE CONCEPT	4-1
4.3	PREVENTATIVE MAINTENANCE	4-1
4.3.1	Tools Required	4-1
4.3.2	Maintenance Tasks	4-2
4.3.3	Exterior Hardware Inspection	4-3
4.4	GENERAL REMOVAL AND REPLACEMENT PROCEDURES	4-3
4.4.1	Installation of the RFMOW	4-4
4.4.2	Removal and Replacement of the SDM-300A	4-6
4.4.3	Removal and Replacement of the RFMOW Fan Panel	4-7
4.4.4	Removal and Replacement of the RFMOW Computer	4-7
4.4.5	Removal and Replacement of the RFMOW Keyboard/Video/Monitor	4-8
4.4.6	Removal and Replacement of the RFMOW Interface Unit	4-9
CHAPTER 5	REPAIR PART AND SPECIAL TOOLS LIST	5-1
5.1	INTRODUCTION	5-1
5.2	LIST OF MANUFACTURERS	5-1
5.3	PARTS LIST	5-1
APPENDIX A	REFERENCE PUBLICATIONS	A-1
APPENDIX B	MAINTENANCE ALLOCATION CHART	B-1
B-1	THE ARMY MAINTENANCE SYSTEM MAC	B-1
B-2	MAINTENANCE FUNCTIONS	B-1
B-3	EXPLANATIONS OF COLUMNS IN THE MAC	B-3
B-4	EXPLANATION OF THE COLUMNS IN TOOLS AND TEST EQUIPMENT	B-4
B-5	EXPLANATION OF COLUMNS IN REMARKS	B-4
APPENDIX C	COMPONENTS OF END ITEMS AND BASIC ISSUE ITEMS LIST	C-1
APPENDIX D	EXPENDABLE/DURABLE ITEMS LIST	D-1
D-1	SCOPE	D-1
D-2	EXPLANATION OF COLUMNS	D-1
APPENDIX E	MANUAL EQUIPMENT CONFIGURATION PROCEDURES	E-1
E-1	KIV-7HSB CONFIGURATION	E-1
E-2	KIV-7 AND KIV-7HS CONFIGURATION	E-3
E-3	STE (TACTICAL) CONFIGURATION	E-6
E-4	SDM-300A CONFIGURATION AND OPERATION	E-8
APPENDIX F	POWER BALANCE/ALIGNMENT PROCEDURE	F-1
F-1	OVERVIEW OF POWER BALANCE/ALIGNMENT	F-1
F-2	THE ALIGNMENT PROGRAM	F-1
F-3	ALIGNMENT PROCEDURE FOR THE AN/TSC-85D(V)1 AND AN/TSC-93D(V)1 TERMINALS	F-1
APPENDIX G	RFMOW SOFTWARE OPERATION	G-1
G-1	OVERVIEW OF TERMINAL INITIALIZATION	G-1
G-2	CONTROL CIRCUIT CONFIGURATION	G-1
G-3	POWER UP	G-1
G-3.1	Connect to Server	G-2

TABLE OF CONTENTS (Cont.)

<u>Chapter</u>	<u>Title</u>	<u>Page</u>
APPENDIX G	RFMOW SOFTWARE OPERATION	G-1
G-3.2	Initialization	G-3
G-3.3	Hardware Test Diagnostics.....	G-4
G-3.4	Power and Frequency Configuration Screen.....	G-4
G-3.4.1	Hardware Initialization Error Dialog	G-6
G-3.5	Main Menu	G-7
G-4	OPERATION UNDER USUAL CONDITIONS	G-9
G-4.1	Standby.....	G-9
G-4.2	Network Login.....	G-12
G-4.2.1	Login Multiple Clients.....	G-13
G-4.3	Operate State.....	G-13
G-4.3.1	Composing, Sending and Receiving Text Orderwire Messages	G-13
G-4.3.1.1	Reading a Message.....	G-13
G-4.3.1.2	Composing and Sending a Message.....	G-15
G-4.3.1.3	Viewing Text Message Logs.....	G-16
G-4.3.1.4	Cut and Paste Into Compose Window.....	G-18
G-4.3.1.5	Favorite Groups	G-18
G-4.3.2	Requesting and Conducting a Secure Call.....	G-19
G-4.3.2.1	Requesting a Call.....	G-19
G-4.3.2.2	Call Setup and Answering	G-19
G-4.3.2.3	Viewing the Secure Voice Call Queue.....	G-20
G-4.3.3	Sending and Receiving Files	G-21
G-4.3.3.1	Send File Screen	G-21
G-4.3.3.2	Get File Screen.....	G-23
G-4.3.4	Viewing Network Data	G-24
G-4.3.4.1	The Event Log.....	G-24
G-4.3.4.1.1	Opening the Live Event Log	G-24
G-4.3.4.1.2	Archived Events Screens.....	G-26
G-4.3.4.1.3	Opening an Archived Event Log.....	G-27
G-4.4	Terminal Configuration	G-29
G-4.4.1	Local Terminal Configuration.....	G-29
G-4.4.2	Viewing the Network Terminal Status.....	G-29
G-4.4.3	ROW TDMA and ROW Measurement Sequencing.....	G-31
G-4.4.4	Control Link Status.....	G-31
G-4.4.5	Manually Commanding and Viewing Status	G-35
G-4.5	Maintaining Network Operations.....	G-36
G-4.5.1	Turning Interface Unit Audio Alarm On and Off.....	G-36
G-4.5.2	Monitoring and Maintaining the Control Links	G-36
G-4.5.3	Manually Adjusting Control Modem Power During Operation	G-36
G-4.5.4	Manually Adjusting ROW Link Frequency Offset	G-37
G-4.5.5	Setting Min and Max Eb/No	G-37
G-4.5.6	Detach From Server/Stop Server	G-38
G-4.5.7	Server Control Handover	G-38
G-5	OPERATION UNDER UNUSUAL CONDITIONS	G-38
G-5.1	DISCONNECT	G-38
G-5.1.1	Entering and Recovering From a DISCONNECT State	G-39
G-5.1.1.1	NT Recovery From Loss of ROW or FOW	G-39
G-5.2	Terminal Logout.....	G-40
G-5.2.1	Logging Out of the RFMOW Network.....	G-40
G-5.2.2	NT Emergency Logout.....	G-40
G-5.3	Additional Functions	G-41
G-5.3.1	Packet Statistics.....	G-41
G-5.3.2	Information Message Boxes	G-42
G-5.3.3	Error Message Boxes	G-42

TABLE OF CONTENTS (Cont.)

<u>Chapter</u>	<u>Title</u>	<u>Page</u>
APPENDIX G	RFMOW SOFTWARE OPERATION	G-1
G-5.3.4	Alert Message Boxes	G-42
G-5.3.5	Manually Saving and Deleting Log Files.....	G-42
APPENDIX H	GLOSSARY	H-1

This page left blank intentionally.

LIST OF ILLUSTRATIONS

Figure Number	Title	Page
Figure 1-1	RFMOW for AN/TSC-85D(V)1 Terminal NSN: 5895-01-522-2119.....	1-1
Figure 1-2	Rack Adapter Kit for AN/TSC-85(V)1 Terminal NSN: 5975-01-529-9343	1-1
Figure 1-3	RFMOW for AN/TSC-93D(V)1 Terminal NSN: 5895-01-522-2117.....	1-2
Figure 1-4	Satellite Communications System Block Diagram	1-4
Figure 1-5	Satellite Terminal Block Diagram	1-5
Figure 1-6	Functional Architecture of the RFMOW	1-6
Figure 1-7	RFMOW (Front)	1-7
Figure 1-8	RFMOW (Rear)	1-8
Figure 1-9	RFMOW (Top Panel).....	1-9
Figure 1-10	Enclosure Panel (Front Panel).....	1-10
Figure 1-11	SDM-300A Modem (Front Panel).....	1-11
Figure 1-12	SDM-300A Modem (Rear Panel)	1-12
Figure 1-13	Fan Panel (Front Panel).....	1-13
Figure 1-14	Fan Panel (Rear Panel).....	1-14
Figure 1-15	Computer (Front Panel).....	1-15
Figure 1-16	Computer (Front Panel without Front Cover)	1-16
Figure 1-17	Computer (Rear Panel)	1-17
Figure 1-18	Power Distribution (Front Panel).....	1-18
Figure 1-19	Power Distribution (Rear Panel).....	1-19
Figure 1-20	Monitor Clamp (Front Panel).....	1-20
Figure 1-21	Monitor (Front Panel)	1-21
Figure 1-22	Keyboard/Monitor/Mouse (Rear Panel).....	1-22
Figure 1-23	Interface Unit (Front Panel).....	1-23
Figure 1-24	Interface Unit (Rear Panel).....	1-24
Figure 1-25	RFMOW Patch Panel (Front)	1-25
Figure 1-26	RFMOW Patch Panel (Rear).....	1-26
Figure 1-27	Combiner/Divider Panel(85D) (Front)	1-27
Figure 1-28	Combiner/Divider Panel(93D) (Rear)	1-28
Figure 2-1	RFMOW System Network Node Architecture	2-1
Figure 2-2	Network Message Format	2-2
Figure 2-3	Typical FOW Sequence of Messages	2-5
Figure 2-4	Typical ROW Sequence of Messages	2-5
Figure 2-5	ROW Details	2-6
Figure 2-6	Modem Controls and Indicators	2-13
Figure 2-7	Interface Unit Controls and Indicators.....	2-14
Figure 2-8	RFMOW Functional Block Diagram	2-16
Figure 2-9	NT Equipment Connections	2-19
Figure 2-10	RFMOW Executable Files.....	2-20
Figure 2-11	RFMOW Software Unzip File Path.....	2-21
Figure 2-12	InstallShield Wizard for RFMOW	2-22
Figure 2-13	Terminal Setup Type	2-22
Figure 2-14	Control Panel Location	2-23
Figure 2-15	Add/Remove Programs Location	2-24
Figure 2-16	RFMOW Unistallation Selection.....	2-24
Figure 3-1	RS485 Connector.....	3-23
Figure 3-2	RS232 Connector.....	3-24
Figure 3-3	37-Pin Connector for SDM-300A Modem	3-25
Figure 3-4	Remote Connector (J6) for SDM-300A Modem.....	3-26
Figure 3-5	Fan Power Connector (J1).....	3-27
Figure 3-6	PS/2 Mouse and Keyboard Connectors.....	3-28
Figure 3-7	VGA Serial Port.....	3-29
Figure 3-8	COM1 and COM2 Serial Ports.....	3-30
Figure 3-9	COM3 RS485 Port	3-31

LIST OF ILLUSTRATIONS (Cont.)

<u>Figure Number</u>	<u>Title</u>	<u>Page</u>
Figure 3-10	COM4 RS232 Port	3-32
Figure 3-11	VGA Serial Port	3-33
Figure 3-12	PS/2 Mouse and Keyboard Connectors.....	3-34
Figure 3-13	STU III/STE Telephone Connector (J1)	3-35
Figure 3-14	Primary and Secondary Modem Path Connectors (J2 and J3)	3-36
Figure 3-15	PC Control Signals Connector (J4)	3-37
Figure 3-16	Control Signals to the Modem (J5)	3-38
Figure 3-17	Data From/To the PC (J6).....	3-39
Figure 3-18	Optional Power for External Equipment (J7).....	3-40
Figure 3-19	Schematic Interface Unit	3-42
Figure 3-20	RFMOW Wiring Diagram	3-44
Figure 5-1	Replacement Frequency Modulated Orderwire Parts Location (85 Terminal)	5-4
Figure 5-2	Rack Adapter Kit	5-5
Figure 5-3	Replacement Frequency Modulated Orderwire Parts Location (93 Terminal)	5-6
Figure F-1	Server Screen	F-2
Figure F-2	AN/TSC-85D(V)1 and AN/TSC-93D(V)1 RFMOW Alignment Screen.....	F-3
Figure F-3	System Values Screen	F-4
Figure F-4	U/C Converter Selection	F-5
Figure F-5	MD-1340 Communications Modem Selection.....	F-6
Figure F-6	Communications Link Power Dialog	F-6
Figure F-7	Weather Handicap Dialog	F-7
Figure F-8	Orderwire Link Power Dialog	F-7
Figure F-9	Message Dialog	F-8
Figure F-10	RSL and Eb/No Level Indications	F-9
Figure F-11	RFMOW Output Attenuator.....	F-10
Figure G-1	Server (Executive) Screen	G-2
Figure G-2	Connect To Server Screen.....	G-3
Figure G-3	NT Network and Terminal Identification Information Screen	G-3
Figure G-4	Hardware Diagnostic Error Dialog.....	G-4
Figure G-5	AN/TSC-85D(V)1 and AN/TSC-93D(V)1 Power and Frequency Configuration Screen...G-5	
Figure G-6	Hardware Initialization Error Dialog	G-6
Figure G-7	Main Menu.....	G-7
Figure G-8	NT PC/Controller Screen	G-9
Figure G-9	NT Status Line	G-10
Figure G-10	ROW Granted Dialog	G-12
Figure G-11	Login Successful Dialog.....	G-13
Figure G-12	NT Text Messages Screen.....	G-14
Figure G-13	NT Destinations Screen	G-15
Figure G-14	Urgent Message Dialog.....	G-15
Figure G-15	NT Archived Text Messages Screen	G-17
Figure G-16	Favorite Groups Screen	G-18
Figure G-17	Secure Voice Request Cancel Dialog.....	G-19
Figure G-18	NT Terminal Status Screen.....	G-21
Figure G-19	NT Send File Screen.....	G-22
Figure G-20	NT Get File Screen	G-23
Figure G-21	NT Live Events Screen	G-25
Figure G-22	NT Archived Server Events Screen	G-26
Figure G-23	NT Archived Client Events Screen.....	G-27
Figure G-24	NT Terminal Status Screen.....	G-30
Figure G-25	NT Link Status Screen	G-32
Figure G-26	FOW Link Parameters Screen	G-34
Figure G-27	ROW Link Parameters Screen.....	G-34

LIST OF ILLUSTRATIONS (Cont.)

<u>Figure Number</u>	<u>Title</u>	<u>Page</u>
Figure G-28	ROW Control Modem TX Parameters Screen	G-34
Figure G-29	Send Native HW Command Screen.....	G-35
Figure G-30	Control Modem TX Parameters Screen	G-37
Figure G-31	Packet Statistics Screen.....	G-41
Figure G-32	Information Message Box.....	G-42
Figure G-33	Error Message Box.....	G-42
Figure G-34	Alert Boxes	G-42

This page left blank intentionally.

LIST OF TABLES

<u>Table Number</u>	<u>Title</u>	<u>Page</u>
Table 1-1	RFMOW (Front).....	1-7
Table 1-2	RFMOW (Rear)	1-8
Table 1-3	Top RFMOW Cover.....	1-9
Table 1-4	Enclosure Panel	1-10
Table 1-5	SDM-300A Modem (Front).....	1-11
Table 1-6	SDM-300A Modem (Rear).....	1-12
Table 1-7	Fan Panel (Front)	1-13
Table 1-8	Fan Panel (Rear).....	1-14
Table 1-9	Computer (Front).....	1-15
Table 1-10	Computer (Front without front cover)	1-16
Table 1-11	Computer (Rear)	1-17
Table 1-12	Power Distribution (Front)	1-18
Table 1-13	Power Distribution (Rear).....	1-19
Table 1-14	Monitor Clamp	1-20
Table 1-15	Monitor (Front Panel)	1-21
Table 1-16	Keyboard/Monitor/Mouse (Rear).....	1-22
Table 1-17	Interface Unit (Front)	1-23
Table 1-18	Interface Unit (Rear).....	1-24
Table 1-19	RFMOW Patch Panel (Front)	1-25
Table 1-20	RFMOW Patch Panel (Rear).....	1-26
Table 1-21	Combiner/Divider Panel (Front).....	1-27
Table 1-22	Combiner/Divider Panel (Rear)	1-28
Table 1-23	RFMOW Physical Data	1-29
Table 1-24	Electrical Data	1-32
Table 1-25	Environmental Data	1-32
Table 1-26	Government Furnished Equipment	1-32
Table 2-1	Network Message Fields	2-2
Table 2-2	ROW Usage During Normal and Access Network Modes	2-6
Table 2-3	ROW TDMA Slot Elements	2-7
Table 2-4	Modem Controls and Indicators	2-13
Table 2-5	Interface Unit Controls and Indicators	2-14
Table 2-6	NT RFMOW Terminal Equipment List.....	2-18
Table 3-1	Troubleshooting.....	3-2
Table 3-2	RS485 From RFMOW Computer Connector Pin Out	3-23
Table 3-3	RS232 From RFMOW Computer Connector Pin Out	3-24
Table 3-4	37-Pin Connector Pin Out for SDM-300A Modem	3-25
Table 3-5	Remote Connector (J6) Pin Out (EIA-485)	3-26
Table 3-6	Fan Panel Power Connector (J1) Pin Out.....	3-27
Table 3-7	PS/2 Mouse and Keyboard Connectors Pin Outs	3-28
Table 3-8	VGA Serial Port Pin Out.....	3-29
Table 3-9	COM1 and COM2 Serial Ports Pin Outs	3-30
Table 3-10	COM3 RS485 Serial Port Pin Out	3-31
Table 3-11	COM4 RS232 Serial Port Pin Out	3-32
Table 3-12	VGA Serial Port Pin Out.....	3-33
Table 3-13	PS/2 Mouse and Keyboard Connectors Port Pin Outs	3-34
Table 3-14	Parallel Port Connector (J1) Pin Out.....	3-35
Table 3-15	37-Pin Connectors (J2 & J3) Pin Out.....	3-36
Table 3-16	PC Control Signals Connector (J4) Pin Out.....	3-37
Table 3-17	Control Signals to the Modem Connector (J5) Pin Out.....	3-38
Table 3-18	Data From/To the PC Connector (J6) Pin Out	3-39
Table 3-19	Optional Power Connector (J7) Pin Out.....	3-40
Table 4-1	Tools Required Index	4-1
Table 4-2	Maintenance Tasks	4-2

LIST OF TABLES (Cont.)

<u>Table Number</u>	<u>Title</u>	<u>Page</u>
Table 5-1	Replacement Frequency Modulated Orderwire Parts List (85 Terminal)	5-4
Table 5-2	Rack Adapter Kit Parts List (85 Terminal).....	5-5
Table 5-3	Replacement Frequency Modulated Orderwire Parts List (93 Terminal)	5-6
Table B-1	MAC for RFMOW	B-5
Table B-2	Tools and Test Equipment Requirements for RFMOW	B-7
Table B-3	Remarks for RFMOW.....	B-8
Table D-1	Expendable/Durable Items List	D-1
Table E-1	KIV-7, KIV-7HS, and KIV-7HSB Configuration	E-5
Table E-2	STE (Tactical) Configuration	E-7
Table E-3	SDM-300A Remote Interface Settings.....	E-10
Table G-1	NT Power Up.....	G-1
Table G-2	Executing the RFMOW Server and Client	G-2
Table G-3	Connect to Server	G-3
Table G-4	Basic Node Configuration	G-4
Table G-5	Power and Frequency Configuration Screen Value Ranges	G-5
Table G-6	Power and Frequency Configuration	G-6
Table G-7	Main Menu Functions.....	G-7
Table G-8	NT Status Line Fields.....	G-10
Table G-9	NT Network Login	G-12
Table G-10	Reading a Text Orderwire Message	G-13
Table G-11	Composing and Sending a Message	G-15
Table G-12	Viewing Archived Messages	G-17
Table G-13	Filtering Messages From a Message Log	G-17
Table G-14	Cutting and Pasting Text.....	G-18
Table G-15	Favorite Groups Screen.....	G-18
Table G-16	Requesting a Secure Call	G-19
Table G-17	Cancelling a Secure Call Request	G-19
Table G-18	Receiving a Call	G-19
Table G-19	Displaying the Terminal Status Screen.....	G-20
Table G-20	Transferring a File	G-22
Table G-21	Retrieving a File From the Server Computer	G-24
Table G-22	Displaying, Filtering, Saving, and Printing the Live Event Log	G-25
Table G-23	Displaying, Filtering, Saving, and Printing the Archived Event Log	G-28
Table G-24	Displaying the Power and Frequency Configuration Screen	G-29
Table G-25	Displaying the Terminal Status Screen.....	G-29
Table G-26	Terminal Status Screen Fields.....	G-30
Table G-27	Displaying the Link Status Screen	G-31
Table G-28	Link Status Screen Fields	G-32
Table G-29	Sending Native Hardware Commands.....	G-35
Table G-30	Turning On and Off The Interface Unit Audio Alarm	G-36
Table G-31	Manually Adjusting Control Modem Power During Operation	G-36
Table G-32	Manually Adjusting ROW Link Frequency Offset During Operation	G-37
Table G-33	Setting Min or Max Eb/No Alarm Thresholds for a Link.....	G-37
Table G-34	Detach from Server/Stop Server	G-38
Table G-35	Server Control Handover	G-38
Table G-36	Logging Out of the Network	G-40
Table G-37	Viewing Packet Statistics	G-41
Table G-38	Saving Log Files to an External Medium and Deleting Them from the Hard Disk.....	G-43

CHAPTER 1

GENERAL INFORMATION, EQUIPMENT DESCRIPTION & THEORY OF OPERATION

1.1 SCOPE

This technical manual covers procedures and supporting information for operating and maintaining the RFMOW. Coverage includes operation, troubleshooting, and maintenance procedures. The material presented in this manual is written for an experienced operator/maintenance personnel responsible for the RFMOW. Standard shop practices used during maintenance are not described.



Figure 1-1 RFMOW for AN/TSC-85D Terminal NSN: 5895-01-522-2119



Figure 1-2 Rack Adapter Kit for AN/TSC-85D Terminal NSN: 5975-01-529-3943

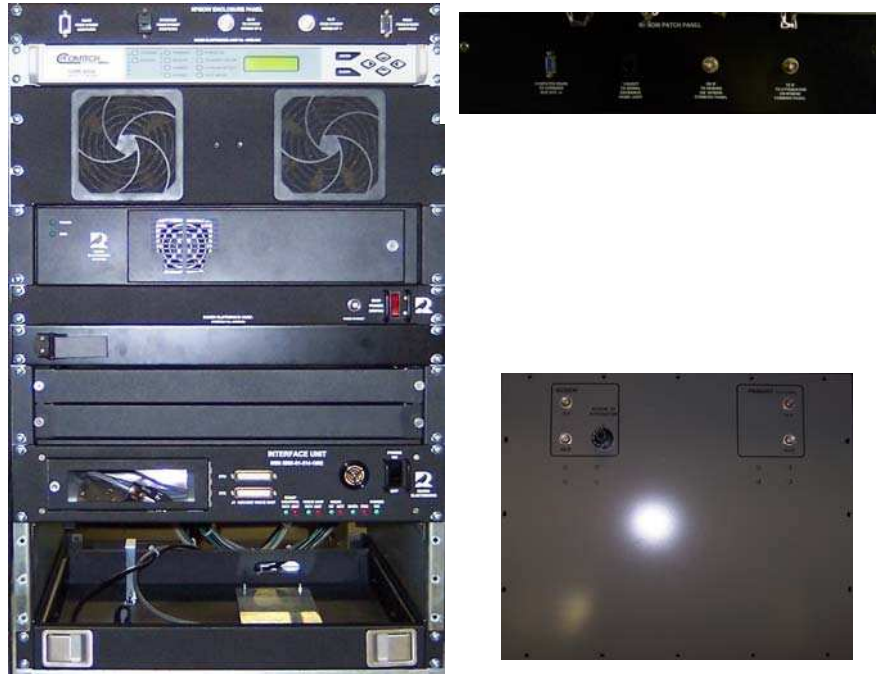

Figure 1-3 RFMOW for AN/TSC-93D Terminal NSN: 5895-01-522-2117

1.2 MAINTENANCE FORMS, RECORDS, AND REPORTS

Reports of Maintenance and Unsatisfactory Equipment. Department of the Army forms and procedures used for equipment maintenance will be those prescribed by DA Pam 738-750, as contained in Maintenance Management Update.

1.3 REPORTING EQUIPMENT IMPROVEMENT RECOMMENDATIONS (EIR)

Army. If your equipment needs improvement, let us know. Send us an EIR. You, the user, are the only one who can tell us what you don't like about your equipment. Let us know why you don't like the design or performance. Put it on an SF 368 (Product Quality Deficiency Report). Mail it to: Commander, US Army Communications-Electronics Command and Fort Monmouth, ATTN: AMSEL-LC-COM-T-SLEP, Fort Monmouth, New Jersey 07703-5006. We'll send you a reply.

1.4 CORROSION PREVENTION AND CONTROL (CPC)

The RFMOW is intended for use only inside a shelter.

1.5 DESTRUCTION OF ARMY ELECTRONICS MATERIAL

Destruction of Army electronics material to prevent enemy use shall be in accordance with TM 750-244-2.

1.6 PREPARATION FOR STORAGE OR SHIPMENT

Administrative storage of equipment issued to and used by Army activities will have Preventive Maintenance Checks and Services (PMCS) performed before storing (see Section 4.3). When removing the equipment from administrative storage, the PMCS checks should be performed to assure operational readiness.

1.7 WARRANTY INFORMATION

The following instructions are for the RFMOW 41700-8593 equipment requirements. The Raven Electronics Corporation equipment, RFMOW, includes a factory warranty of 24 months. All warranties are tracked by serial number. Please contact our Repair Department for warranty expiration date. Failures resulting from material/workmanship defects will be repaired under the warranty.

Warranty Claims: All warranty claims must be initiated by the organization using the equipment. This process will start with the user notifying the contractor, Raven Electronics Corporation. Log onto Raven Electronics Corporation website at:

<http://www.ravencomm.com/RMA>

Complete worksheet and select "Submit". Raven personnel will assign an RMA number, followed by response via telephone or email within 48 hours. Upon assignment of RMA number, return equipment to Raven Electronics Corporation. Raven Electronics Corporation will respond with replacement or repair of equipment upon verification of failure.

RETURN SHIPPING ADDRESS.

Raven Electronics Corporation
400 Edison Way
Reno, NV 89502

Attn: Repair Department

HOTLINE: (866) 329-2363 Toll-free
(775) 858-2400 Outside the continental United States

1.8 LIST OF ABBREVIATIONS/ACRONYMS

See Appendix H, Glossary, for a complete list of abbreviations and acronyms.

1.9 QUALITY OF MATERIAL

The RFMOW contains no user-serviceable parts inside each unit (chassis) contained in the rack. Opening the units voids the warranty.

1.10 SAFETY, CARE, AND HANDLING

The safety of people working with hazardous voltage is of paramount importance. The fully enclosed chassis protects personnel from inadvertently coming in contact with dangerous voltages. There are no user-serviceable parts in this assembly, so therefore it should not be opened.

1.11 EQUIPMENT DESCRIPTION AND DATA

This document provides operating, maintenance, and troubleshooting instructions for the Replacement Frequency Modulated Orderwire (RFMOW) Network Terminal (NT).

1.12 EQUIPMENT CHARACTERISTICS, CAPABILITIES, AND FEATURES

The RFMOW equipment provides satellite communications terminal operators and satellite communications network managers with an over-the-satellite text message and secure voice orderwire capability to support the establishment and maintenance of mission communications.

A satellite communication system is comprised of an Earth Segment, consisting of ground terminals, a Space Segment composed of one or more satellites and a Control Segment containing terminal operation and control equipment.

1.12.1 Earth Segment

The earth segment contains the satellite terminals as well as all of the interconnecting land-line facilities. A ground terminal normally communicates with only one satellite at a time, but it has the capability to change from one satellite to another as required. The earth segment of the satellite system can be divided into two functional groups; the subscriber or user and the satellite earth terminal. A satellite communications system between two subscribers is shown in Figure 1-4. The subscriber and switching equipment are not actually a part of the satellite communications system but are included to show its relationship to the total system.

1.12.1.1 Subscriber

The subscriber or user is the ultimate destination of information transferred over a satellite communication system. An interconnecting link usually exists between the satellite terminal and the subscriber. This interconnection link transfers the data to a switching center or to the actual user. This link could be either a simple landline cable or an elaborate radio or microwave link. Subscriber or switching center equipment provides the proper input/output signal levels and signal processing for data transferred to the satellite terminal.

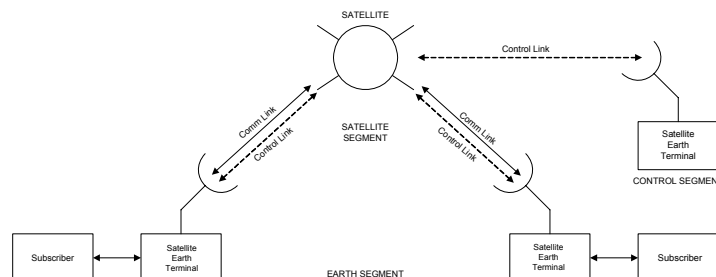

Figure 1-4 Satellite Communications System Block Diagram

1.12.1.2 Satellite Earth Terminal

The function of the satellite earth terminal is to provide the means to communicate with another earth terminal through a satellite link. Major components of an earth terminal include an antenna and associated transmitting, receiving, telemetry, modulating, demodulating and multiplexing equipment. Functionally, a satellite terminal is divided into five basic equipment groups. Figure 1-5 illustrates the major functional equipment groups of a satellite terminal.

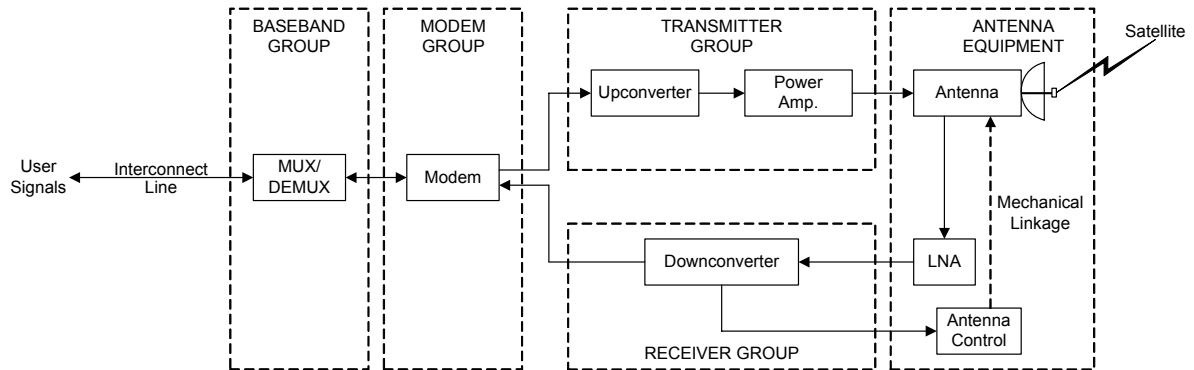

Figure 1-5 Satellite Terminal Block Diagram

1.12.1.2.1 Baseband Equipment Group

The baseband equipment group provides an interface for the interconnection link from the user for the transfer of data and voice signals to the terminal. When multiple signals are to be sent during transmission, they are formatted and combined into a single data stream by a multiplexer/demultiplexer (mux/demux) unit and sent to the modem equipment group. During reception, multiplexed signals from the modem equipment group are demultiplexed, conditioned and sent to the user.

1.12.1.2.2 Modem Equipment Group

This equipment group contains one or more modems that use the multiplexed data to modulate an intermediate frequency (IF) carrier during transmit or demodulate a received IF signal during receive.

1.12.1.2.3 Transmitter Equipment Group

The transmitter equipment group contains upconverters to translate the modulated IF to the operating frequency and a high power amplifier (HPA) to boost the amplitude of the signal.

1.12.1.2.4 Receiver Equipment Group

The receiver equipment group contains downconverters to translate the received signal to an IF signal for the modem.

1.12.1.2.5 Antenna Equipment Group

The antenna equipment group provides the ability to transmit the signal to or receive from the satellite. This equipment group includes the antenna containing the satellite dish and feedhorn, low noise amplifier (LNA) for amplifying the received signal, switches, waveguides and antenna control unit. The antenna control unit determines the elevation and azimuth angle corrections to move the antenna so that it continues to point directly at the satellite.

1.12.2 Description

The RFMOW is a command and control voice and messaging system. In this specification, the terms "RFMOW" and "system" shall be synonymous. The system shall provide functions to allow users to create, edit, transmit, archive, retrieve, and receive messages. The system shall consist of a variety of hardware and software components and shall support multiple tactical terminal users. The RFMOW architecture shall support operations over a DSCS satellite network. The system shall be modular to support expansion beyond the current order wire mission capability to include: additional users and multiple satellite subnets. The functional architecture of the RFMOW shall be as depicted in Figure 1-6.

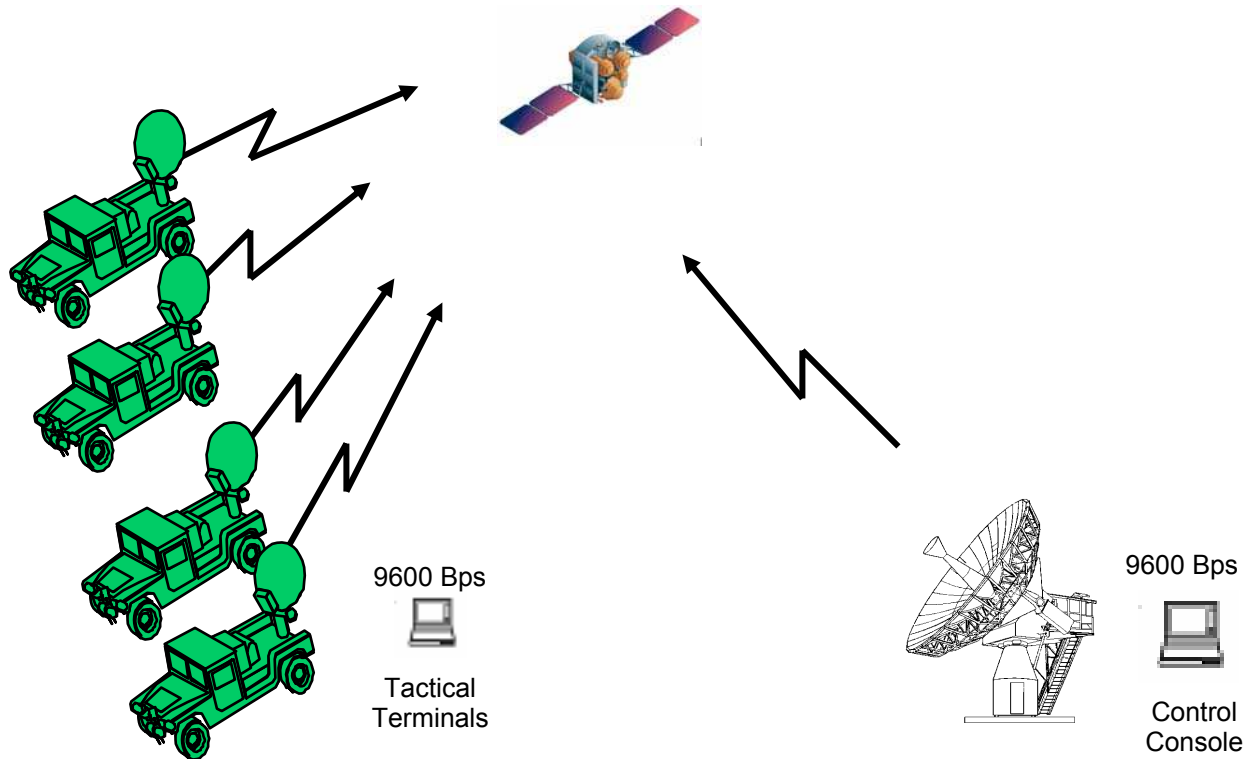

Figure 1-6 Functional Architecture of the RFMOW

The RFMOW network shall incorporate pre-existing legacy AN/TSC-85D(V)1 and AN/TSC-93D(V)1, AN/TSC-152 AND AN/USC-59 terminal and control equipment units and newly acquired Tactical Terminal Units (T2U).

The T2U shall include the EF Data SDM300A satellite modem, a Pentium IV class computer, Personal Computer (PC) operator interface, STE, interface unit, rack insertable enclosure, internal enclosure cabling, Intermediate Frequency (IF) signal combiner/divider panel and external connectors. The combiner/divider panel shall be provided separate from the enclosure.

1.13 LOCATION AND DESCRIPTION OF MAJOR COMPONENTS

The major components on the front and rear panels of the RFMOW are identified in the following illustrations and tables.

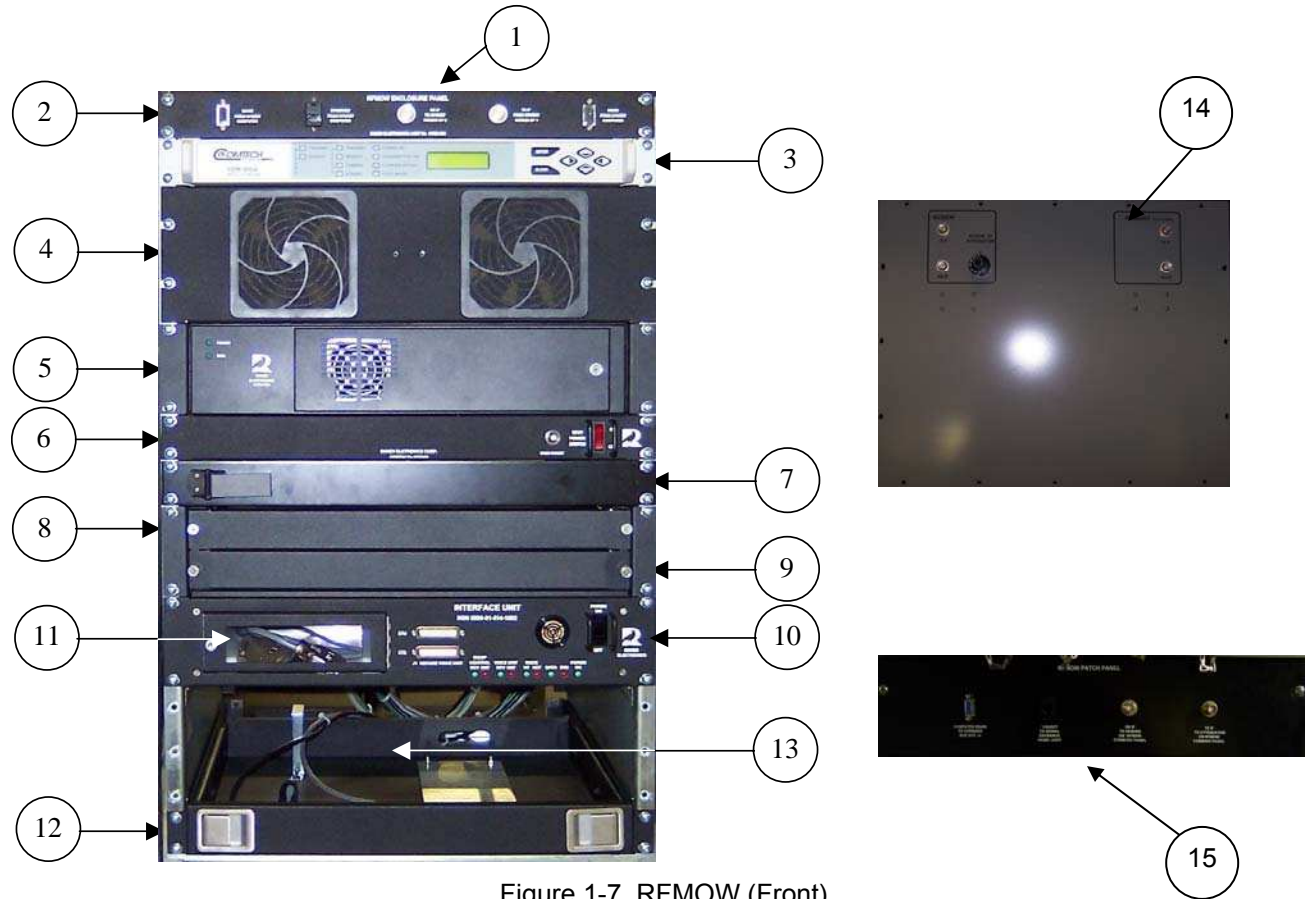

Figure 1-7 RFMOW (Front)

Table 1-1 RFMOW (Front)	
ITEM	COMPONENT
1	Enclosure
2	Enclosure Panel
3	Modem
4	Fan Panel
5	Computer
6	Power Distribution Panel
7	Monitor Clamp Panel
8	Monitor Drawer
9	Keyboard and Mouse Drawer
10	Interface Unit
11	KIV-7
12	STU/STE Telephone Drawer
13	STE
14	Combiner/Divider Panel
15	Patch Panel

(Note: Secure Telephone and KIV is not shown)

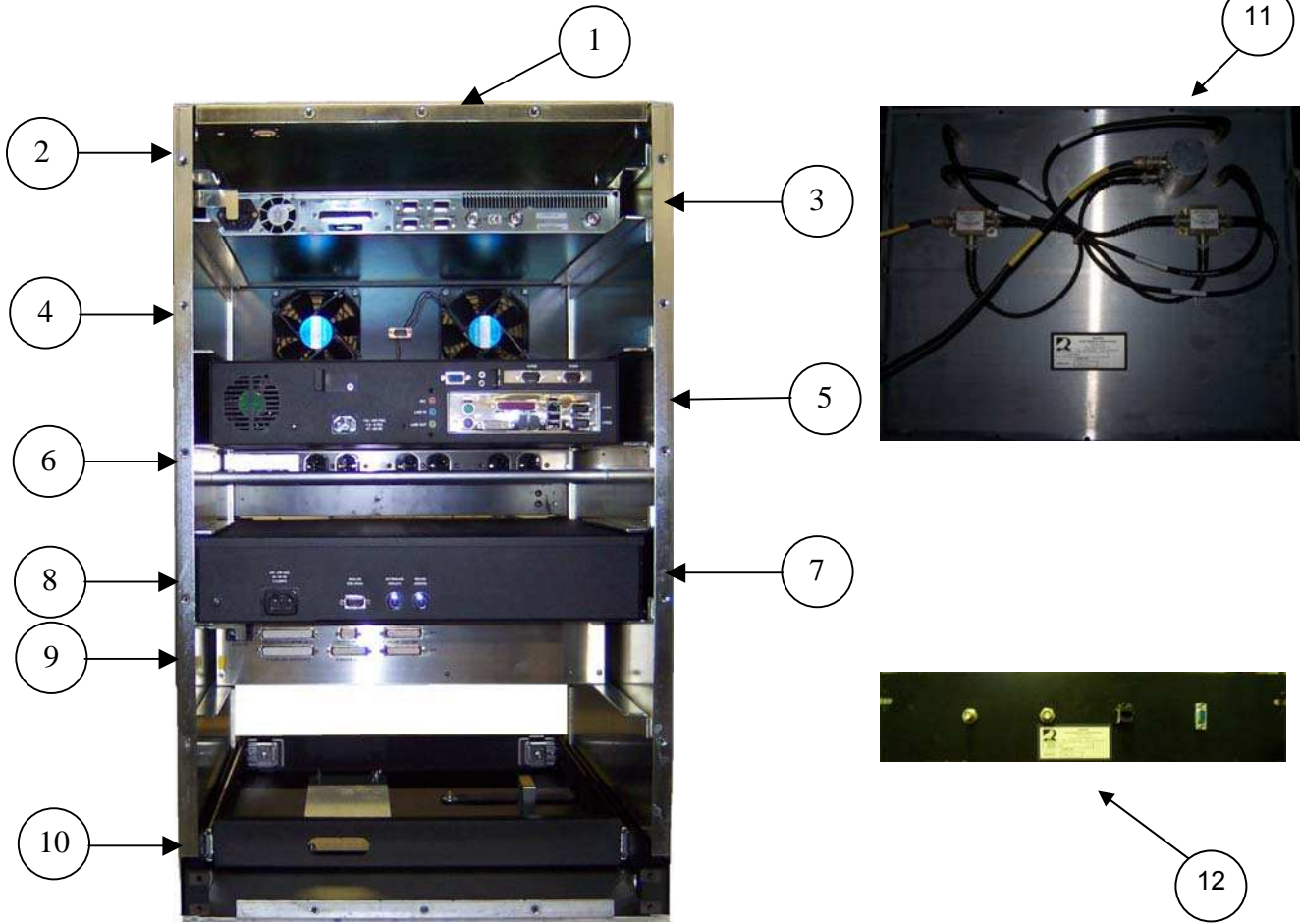

Figure 1-8 RFMOW (Rear)

Table 1-2 RFMOW (Rear)	
ITEM	COMPONENT
1	Enclosure
2	Enclosure Panel
3	Modem
4	Fan Panel
5	Computer
6	Power Distribution Panel
7	Monitor Clamp Panel
8	Keyboard, Monitor, and Mouse
9	Interface Unit
10	STU/STE Telephone Drawer
11	Combiner/Divider Panel
12	Patch Panel

(Note: Interconnect Cables are not shown)

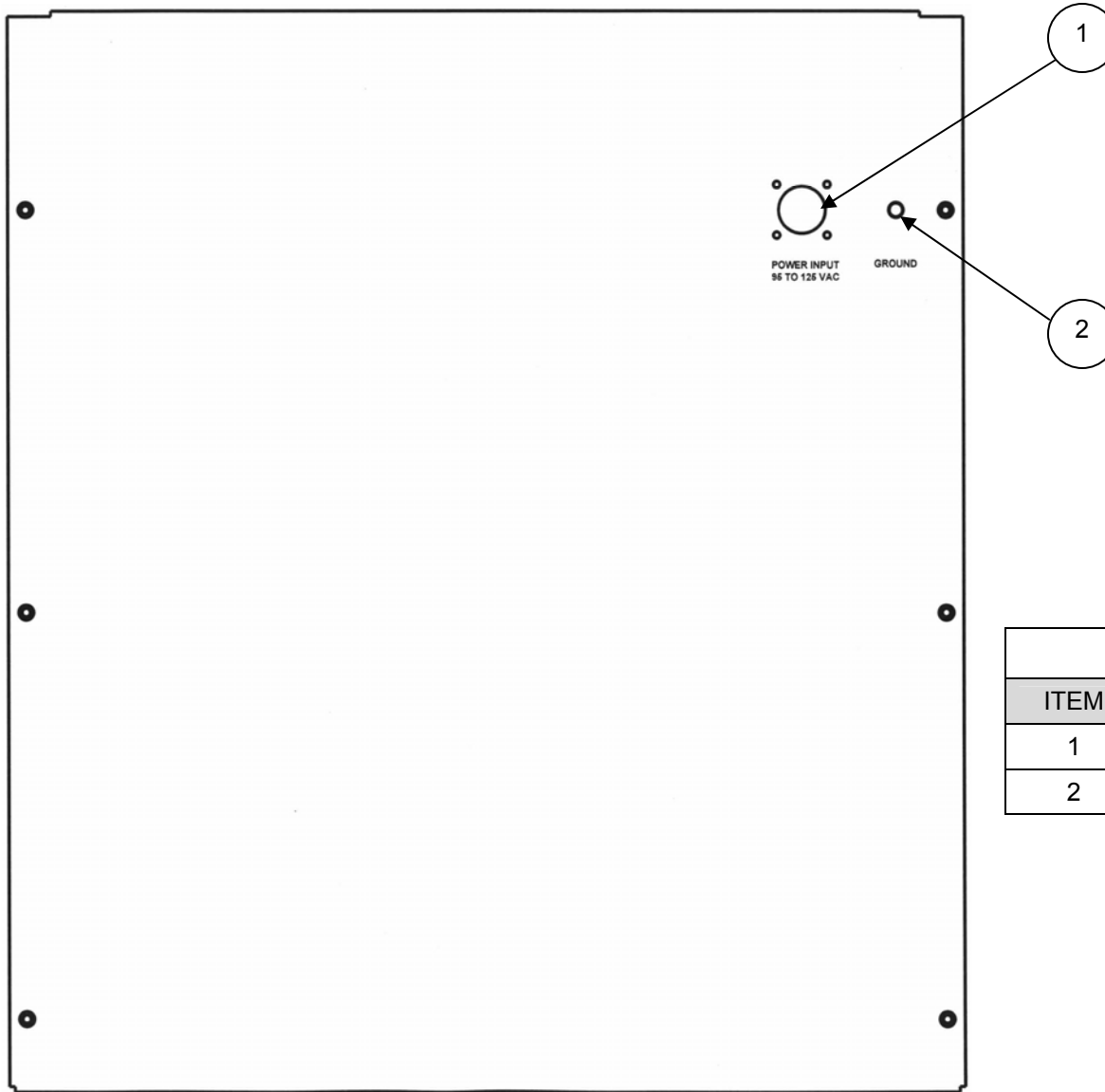

Table 1-3 Top RFMOW Cover	
ITEM	COMPONENT
1	Power Input Connector
2	Ground Connector

Figure 1-9 RFMOW (Top Panel)

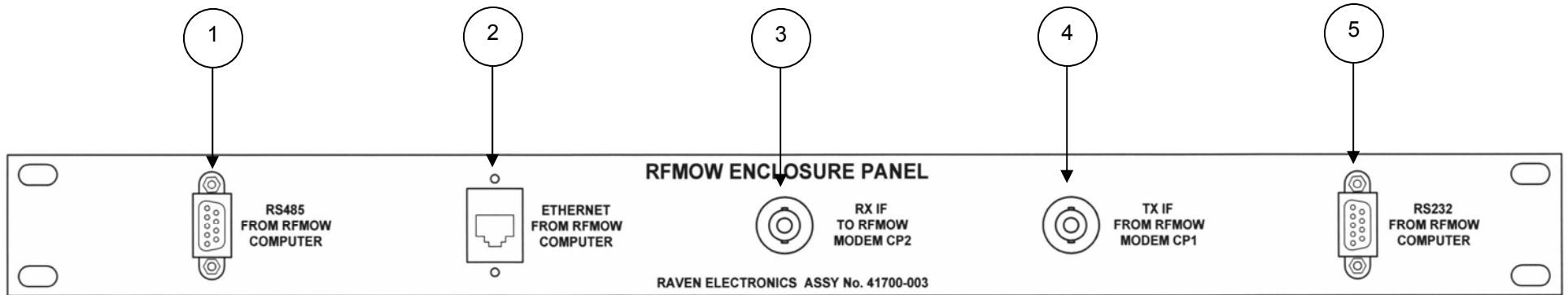

Figure 1-10 Enclosure Panel (Front Panel)

Table 1-4 Enclosure Panel	
ITEM	COMPONENT
1	RJ485 From RFMOW Computer Connector
2	Ethernet From RFMOW Computer Connector
3	RX IF to RFMOW Modem CP2 Connector
4	TX IF to RFMOW Modem CP1 Connector
5	RS232 From RFMOW Computer Connector

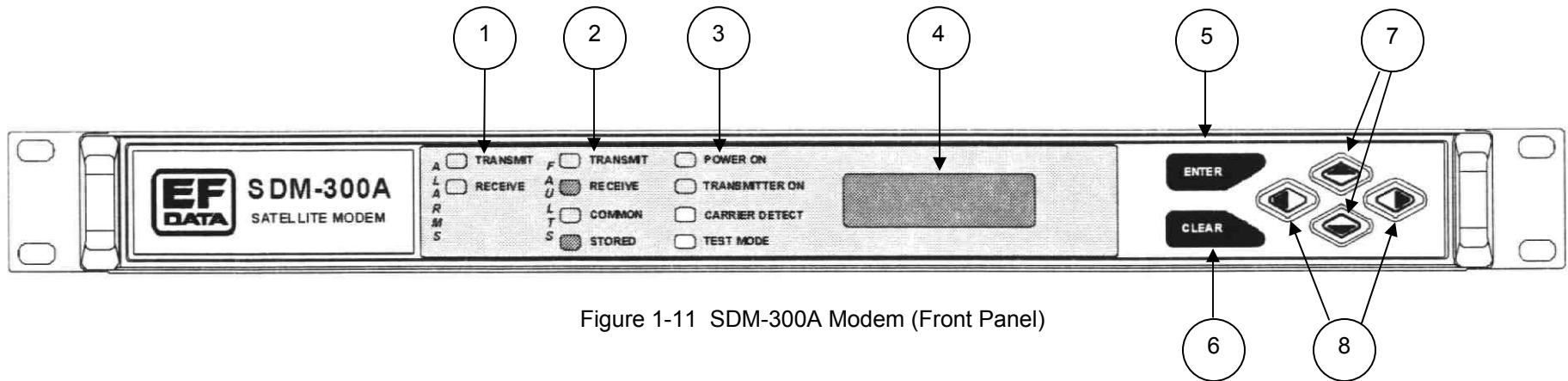

Figure 1-11 SDM-300A Modem (Front Panel)

Table 1-5 SDM-300A Modem (Front)	
ITEM	COMPONENT
1	Alarm Status LEDs
2	Fault Status LEDs
3	Status LEDs
4	32-character, 2-line Liquid Crystal Display (LCD)
5	Enter Button
6	Clear Button
7	Up and Down Select Keys
8	Left and Right Select Keys

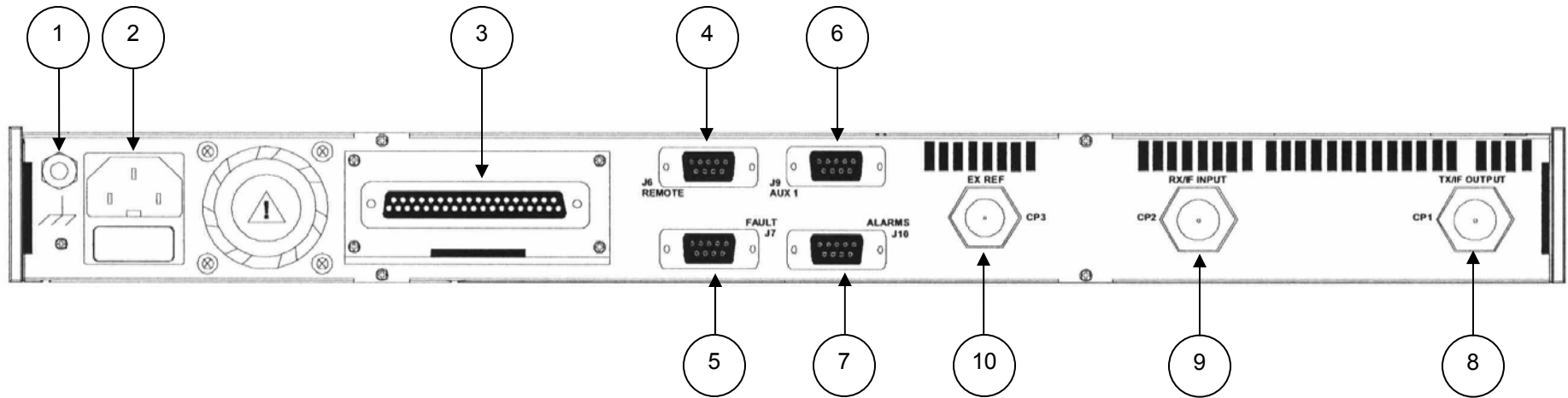

Figure 1-12 SDM-300A Modem (Rear Panel)

Table 1-6 SDM-300A Modem (Rear)	
ITEM	COMPONENT
1	Grounding Stud
2	AC Power Input Connector
3	J8 Data I/O Connector (37-pin D)
4	J6 Remote Connector (9-pin D)
5	J7 Fault Connector (9-pin D) (Not used)
6	J9 AUX1 Connector (9-pin D) (Not used)
7	J10 Alarms Connector (9-pin D) (Not used)
8	CP1 TX/IF Output BNC Connector
9	CP2 RX/IF Input BNC Connector
10	CP3 External Ref BNC Connector (Not used)

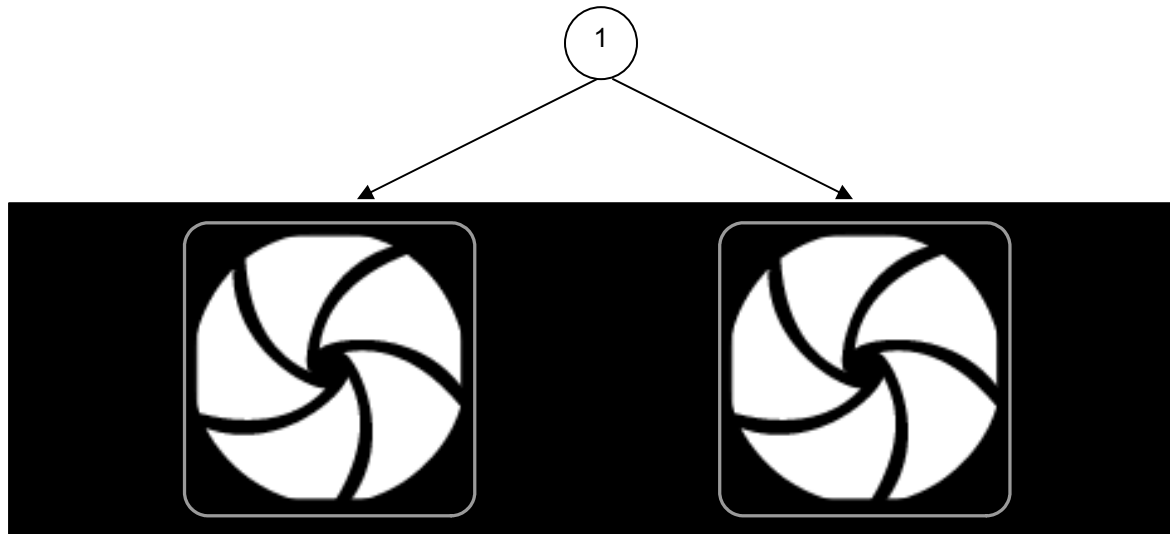

Figure 1-13 Fan Panel (Front Panel)

Table 1-7 Fan Panel (Front)	
ITEM	COMPONENT
1	Air Intake Filters

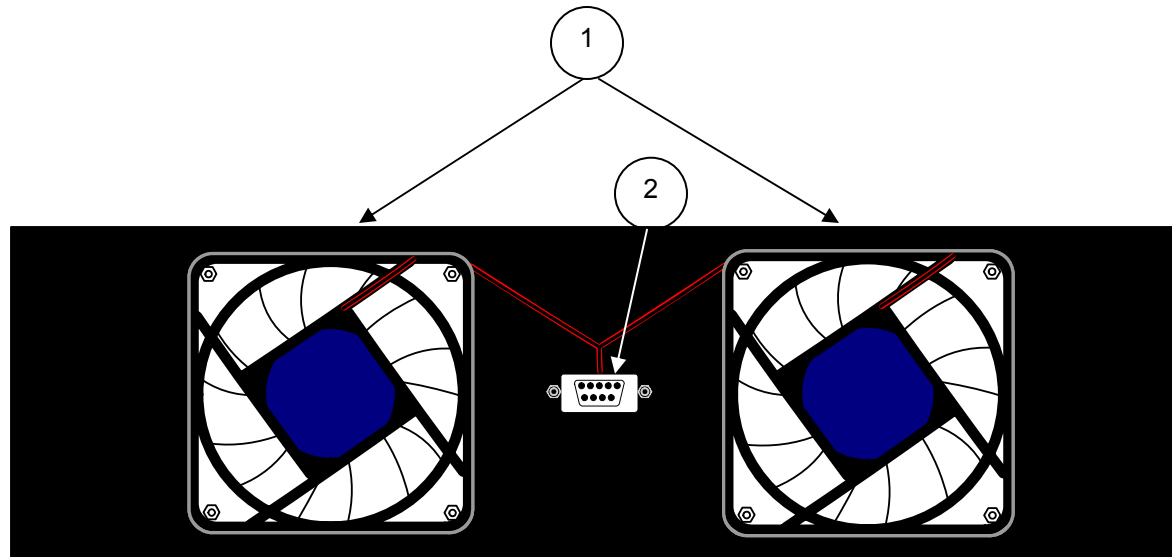

Figure 1-14 Fan Panel (Rear Panel)

Table 1-8 Fan Panel (Rear)	
ITEM	COMPONENT
1	DC Cooling Fans
2	Power Connector (9-pin D)

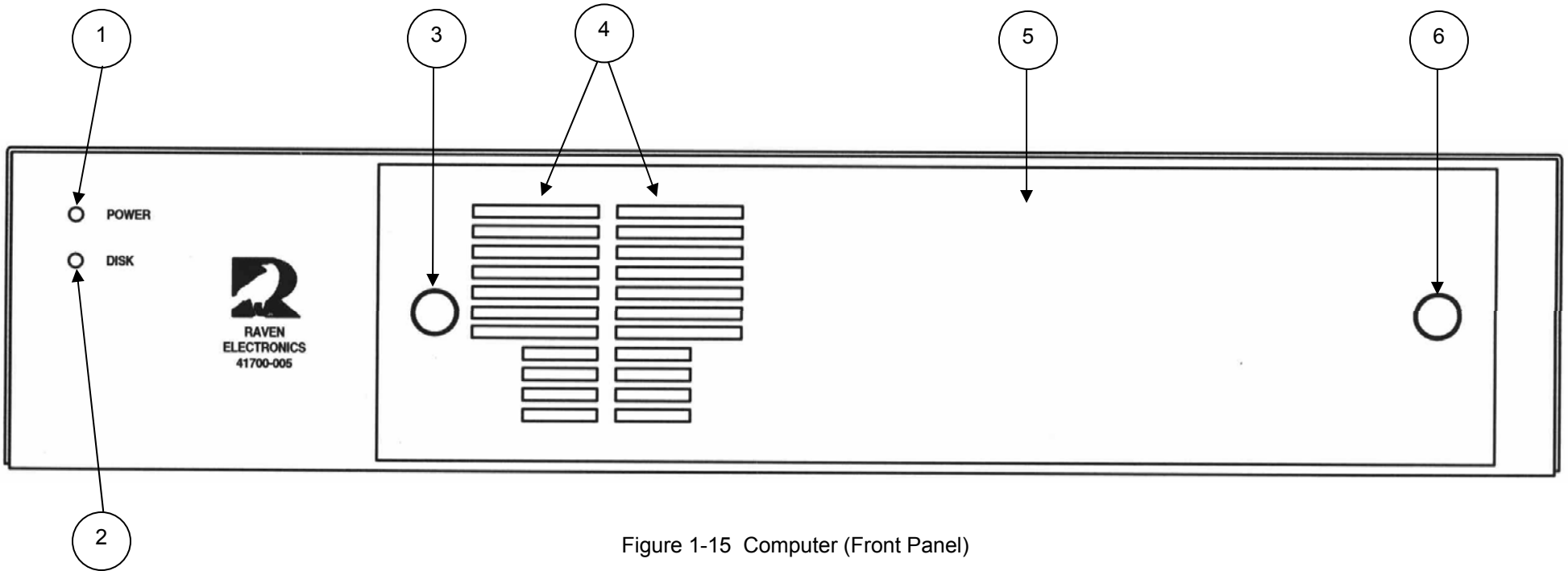

Figure 1-15 Computer (Front Panel)

ITEM	COMPONENT
1	Power LED
2	Disk LED
3	Thumb Screw
4	Intake Air Filter
5	Front Panel Access
6	Thumb Screw

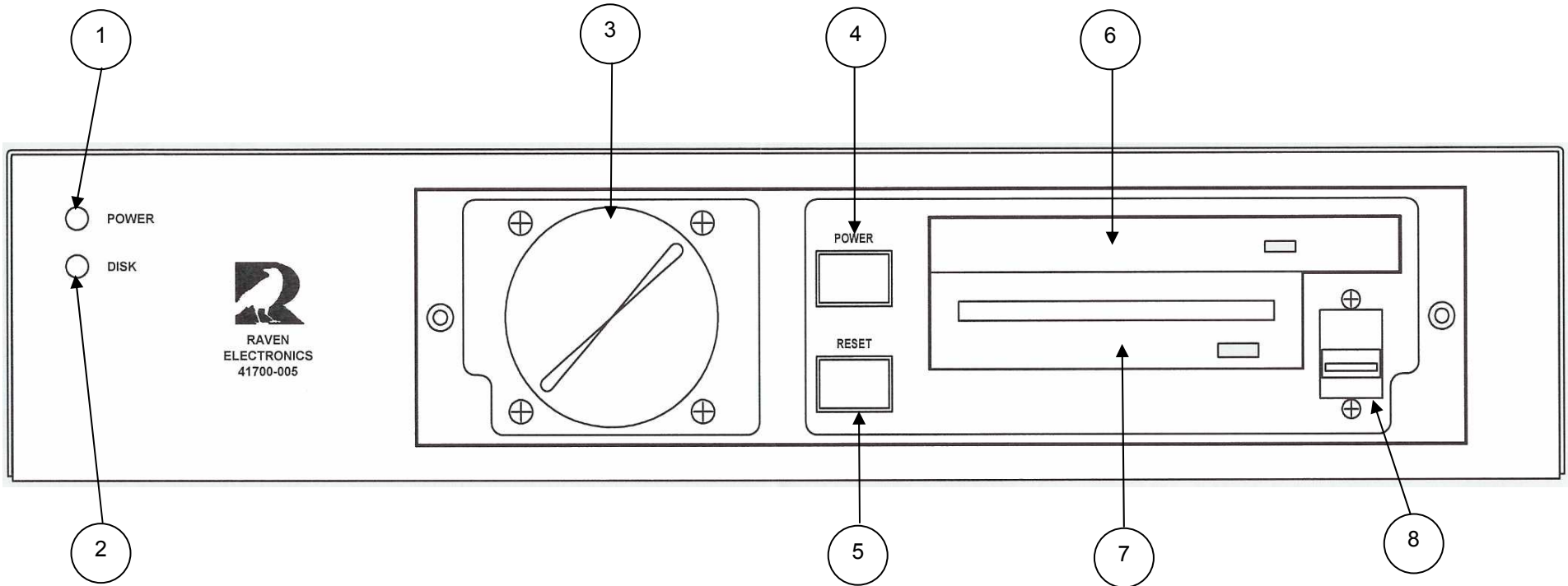

Figure 1-16 Computer (Front Panel without Front Cover)

Table 1-10 Computer (Front without Front Cover)			
ITEM	COMPONENT	ITEM	COMPONENT
1	Power LED	5	Reset Button
2	Disk LED	6	DVD/CD-RW Drive
3	Fan Input Filter	7	3.5" Floppy Drive
4	Soft Power Button	8	USB Port

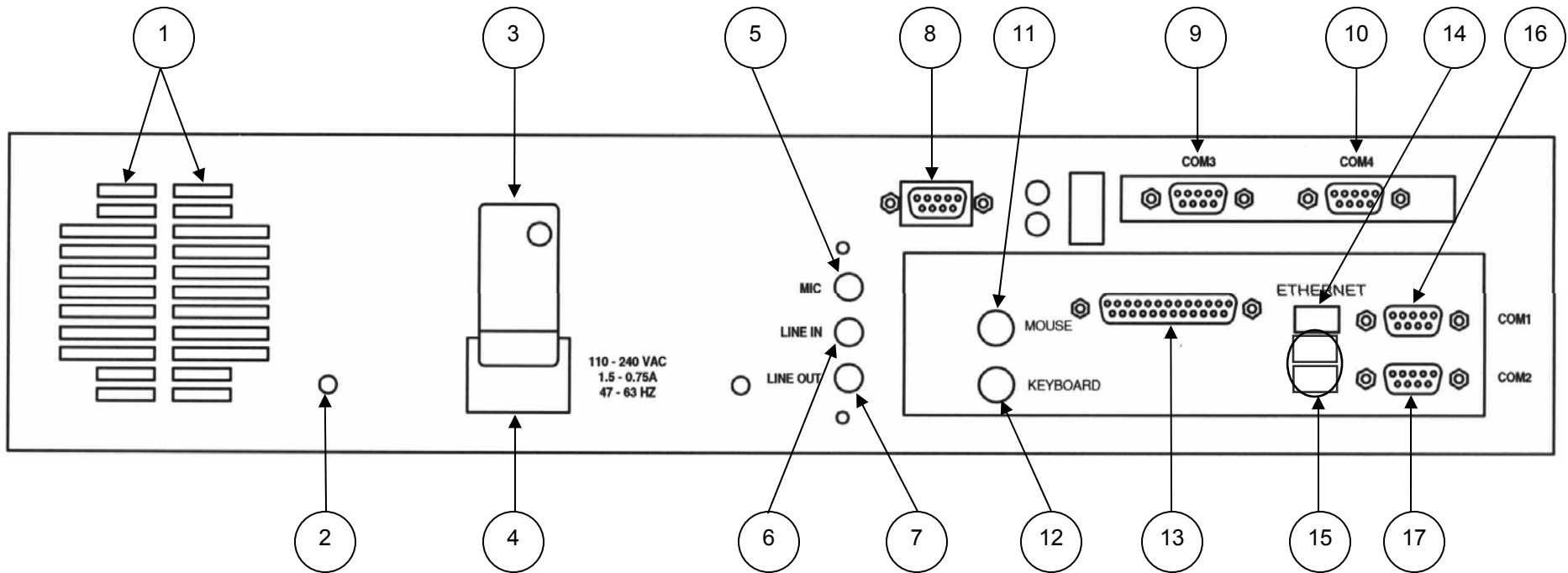

Figure 1-17 Computer (Rear Panel)

ITEM	COMPONENT	ITEM	COMPONENT
1	Air Exhaust Filter	10	Com Port 4 Connector
2	Grounding Stud	11	Mouse Connector
3	Power Connector Retainer	12	Keyboard Connector
4	Power Connector	13	Printer Connector
5	Microphone In (Not used)	14	Ethernet Connector
6	Line In (Not used)	15	USB Port Connectors
7	Line Out (Not used)	16	Com Port 1 Connector
8	VGA Serial Port Connector	17	Com Port 2 Connector
9	Com Port 3 Connector		



Figure 1-18 Power Distribution (Front Panel)

Table 1-12 Power Distribution (Front)	
ITEM	COMPONENT
1	Circuit Breaker
2	On / Off Power Switch

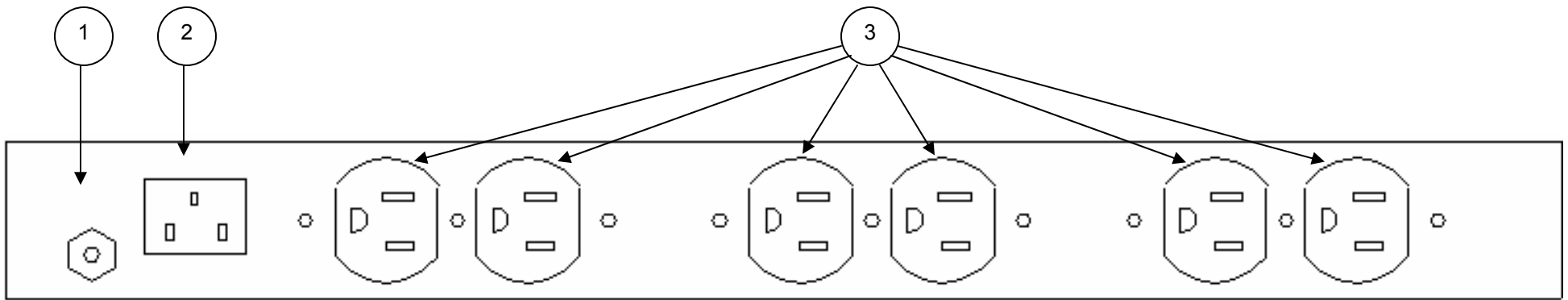

Figure 1-19 Power Distribution (Rear Panel)

Table 1-13 Power Distribution (Rear)	
ITEM	COMPONENT
1	Grounding Stud
2	AC Power Input
3	AC Power Output Strip



Figure 1-20 Monitor Clamp (Front Panel)

Table 1-14 Monitor Clamp	
ITEM	COMPONENT
1	Monitor Clamp

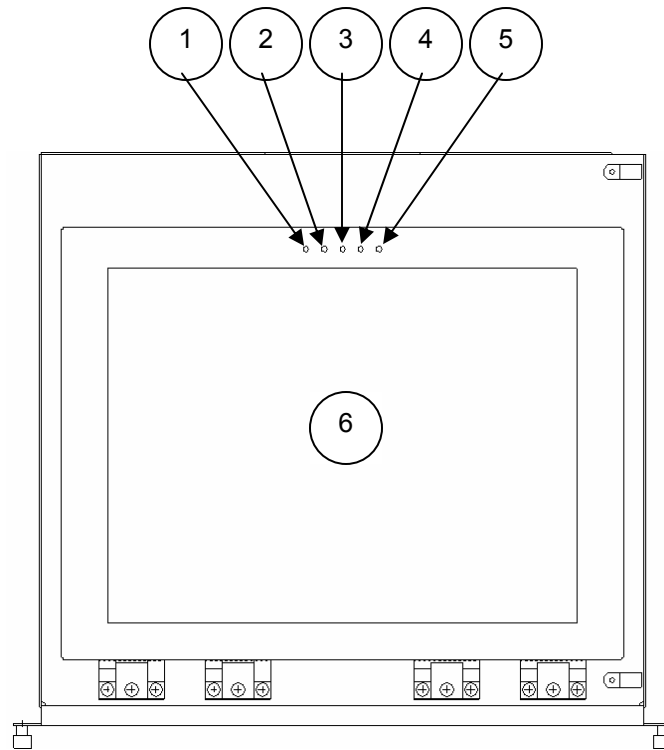

Figure 1-21 Monitor (Front Panel)

Table 1-15 Monitor (Front)	
ITEM	COMPONENT
1	Exit Button
2	Left Button
3	Right Button
4	Menu Button
5	Power Button
6	Monitor Screen

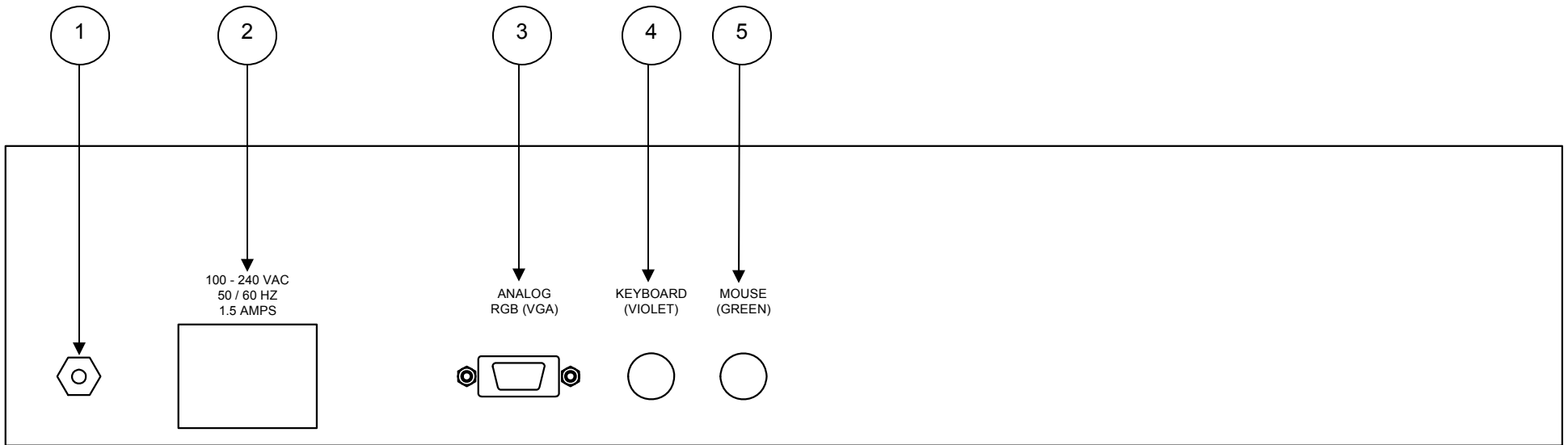

Figure 1-22 Keyboard/Monitor/Mouse (Rear Panel)

Table 1-16 Keyboard/Monitor/Mouse (Rear)	
ITEM	COMPONENT
1	Grounding Stud
2	Power Connector
3	Monitor Connector
4	Keyboard Connector
5	Mouse Connector

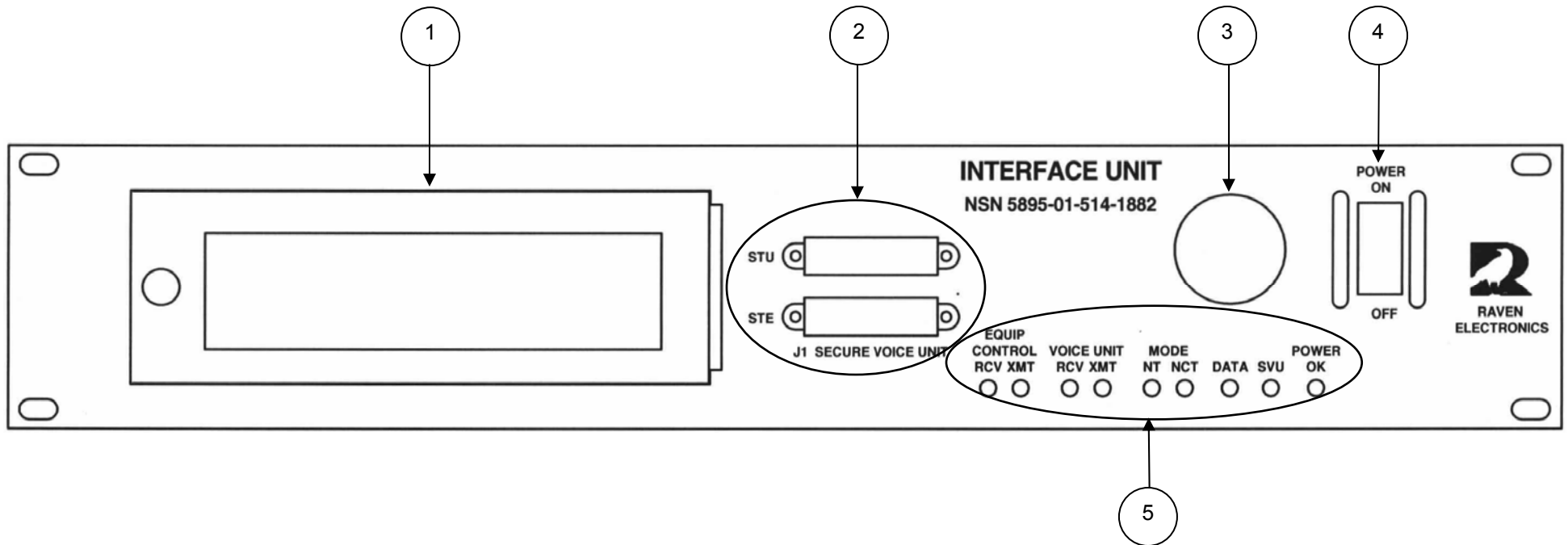

Figure 1-23 Interface Unit (Front Panel)

Table 1-17 Interface Unit (Front)	
ITEM	COMPONENT
1	Housing Enclosure for the KIV-7 Device
2	J1 Connectors for the STU/STE
3	Alarm Horn
4	On / Off Power Switch
5	Status and Mode LEDs

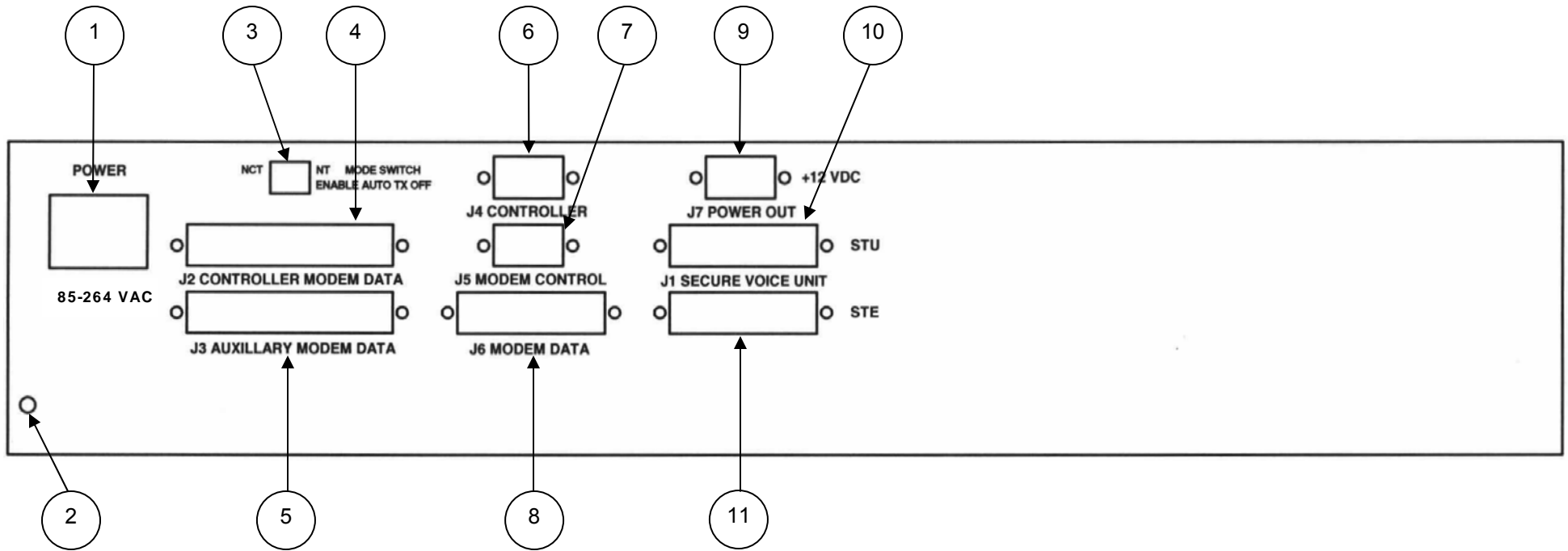

Figure 1-24 Interface Unit (Rear Panel)

Table 1-18 Interface Unit (Rear)			
ITEM	COMPONENT	ITEM	COMPONENT
1	Power Connector	7	J5 Modem Control Connector
2	Grounding Stud	8	J6 Modem Data Connector
3	Mode and Enable Auto TX Switches	9	J7 Power Out Connector
4	J2 Controller Modem Data Connector	10	J1 STU Connector
5	J3 Auxiliary Modem Data Connector	11	J1 STE Connector
6	J4 Controller Connector		

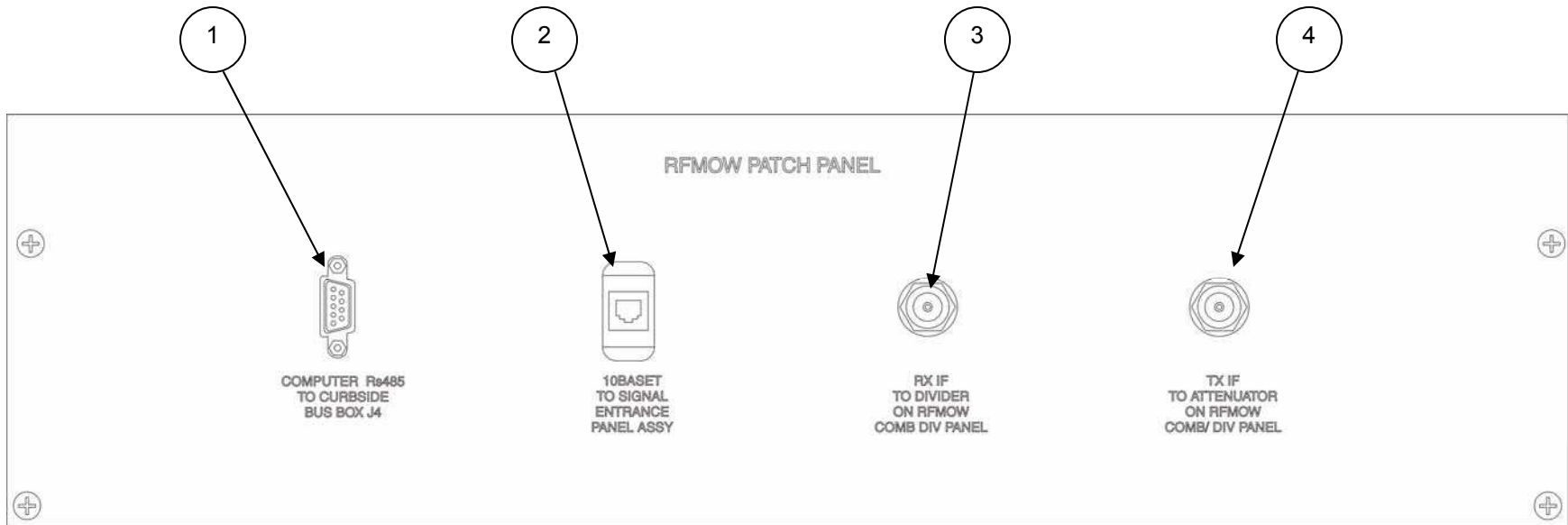

Figure 1-25 RFMOW Patch Panel (Front)

Table 1-19 RFMOW Patch Panel (Front)	
ITEM	COMPONENT
1	RS485 connection to curbside J4
2	Ethernet connection to Signal Entrance Panel
3	RX IF connection from Combiner/Divider Panel
4	TX IF connection to Combiner/Divider Panel

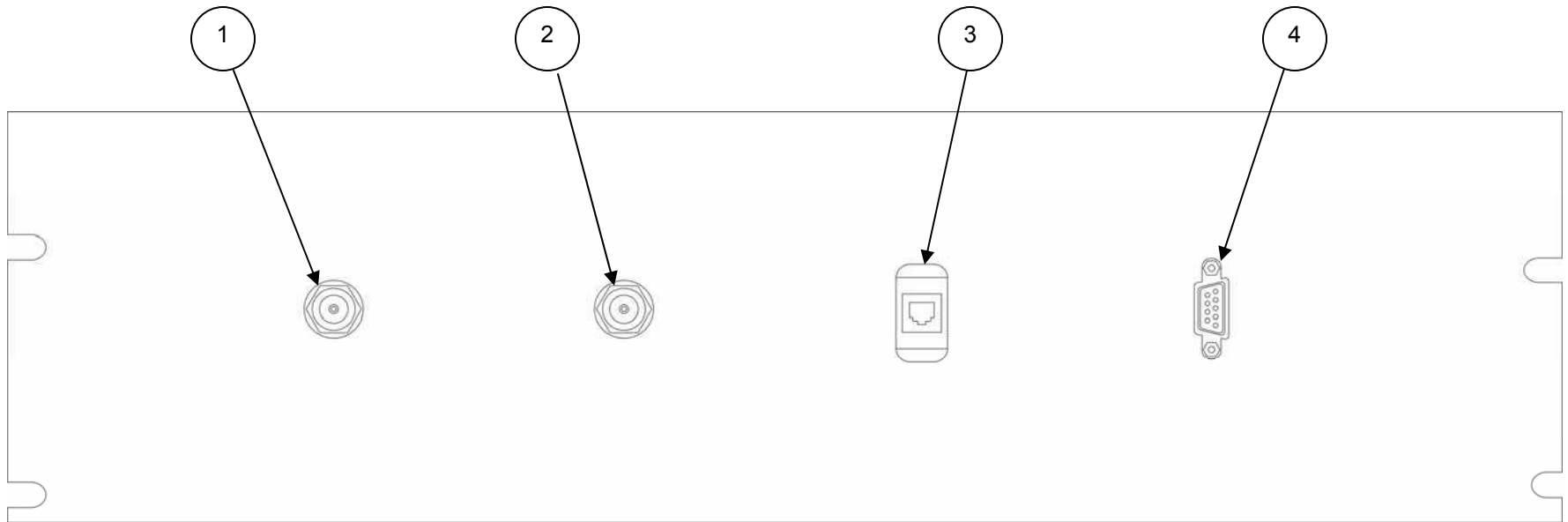

Figure 1-26 RFMOW Patch Panel (Rear)

Table 1-20 RFMOW Patch Panel (Rear)	
ITEM	COMPONENT
1	TX IF connection to Combiner/Divider Panel
2	RX IF connection from Combiner/Divider Panel
3	Ethernet connection to Signal Entrance Panel
4	RS485 connection to curbside J4

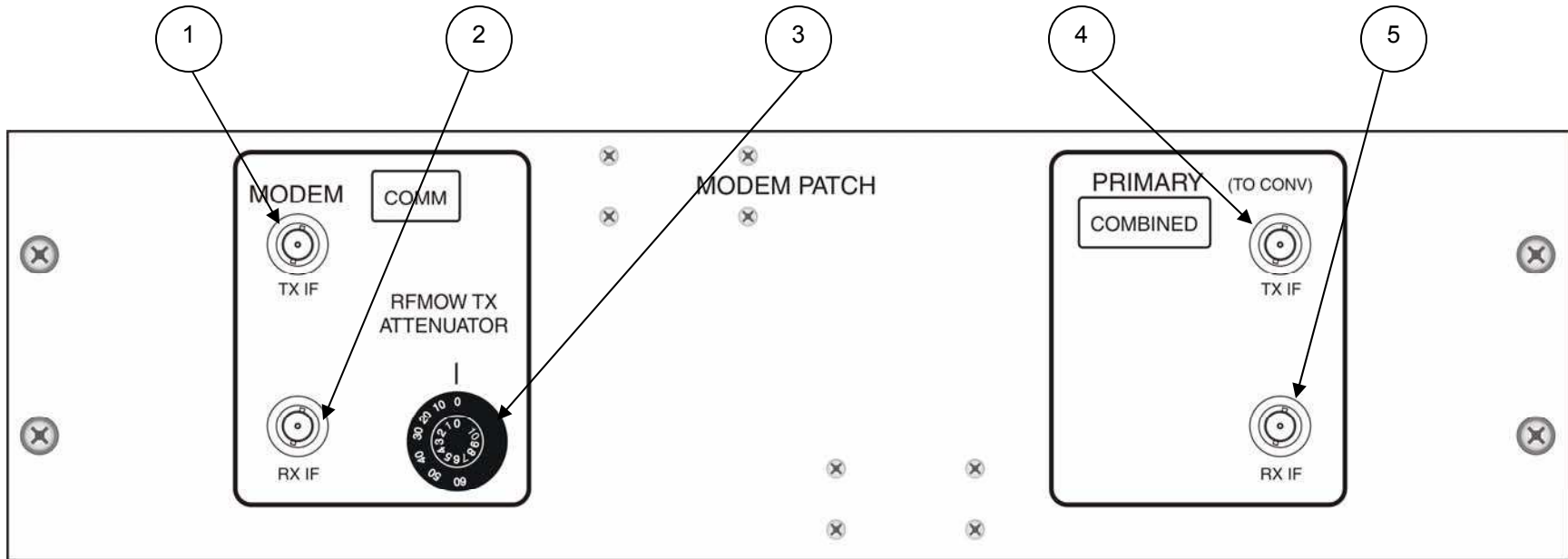

Figure 1-27 Combiner/Divider Panel(85D) (Front)

Table 1-21 Combiner/Divider Panel (Front)	
ITEM	COMPONENT
1	IF Signal from TX MD-1340
2	IF Signal to TX MD-1340
3	RFMOW Attenuator
4	Composite Signal output to Up Converter
5	Composite Signal input from Down Converter

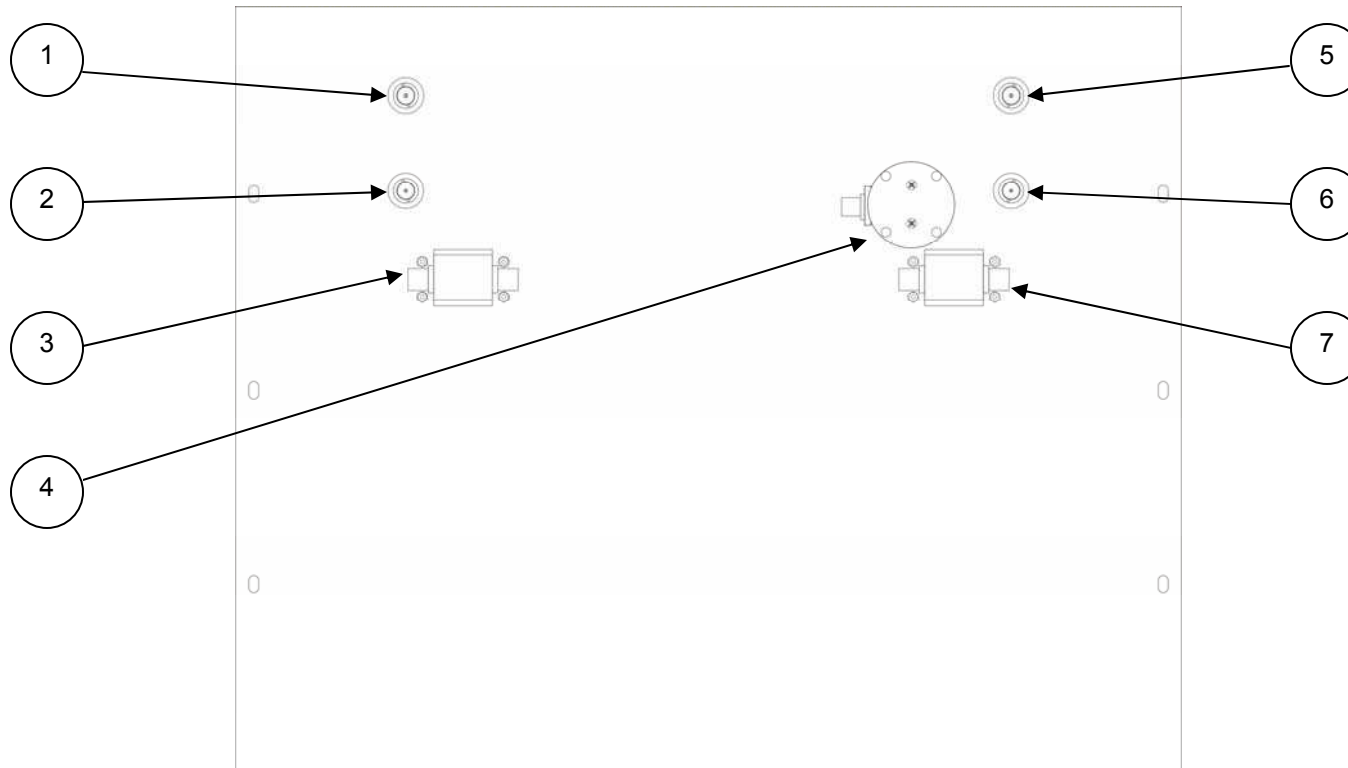

Figure 1-28 Combiner/Divider Panel(93D) (Rear)

Table 1-22 Combiner/Divider (Rear)			
ITEM	COMPONENT	ITEM	COMPONENT
1	Composite Signal output to Up Converter	5	IF Signal from TX MD-1340
2	Composite Signal input from Down Converter	6	IF Signal to TX MD-1340
3	Divider	7	Combiner
4	RFMOW Attenuator		

1.14 DIFFERENCE BETWEEN MODELS

The 41700-8593 (85) RFMOW contains a Combiner/Divider Panel (41700-085) and a Patch Panel (41700-185) as well as two Rack Adapter Kits (41700-8593). The 41700-8593 (93) RFMOW contains a Combiner/Divider Panel (41700-093) and a Patch Panel (41700-193) as well as one Rack Adapter Kit (41700-8593).

1.15 TECHNICAL CHARACTERISTICS

The RFMOW technical data includes the physical, electrical, and environmental data described in the following paragraphs.

1.15.1 Physical Characteristics

The RFMOW physical characteristics are listed in Tables 1-23.

Table 1-23 RFMOW Physical Data		
Raven RFMOW Characteristics	Standard	Metric
Measurements:		
Width	19.00 inches	45.09 cm
Depth	20.00 inches	50.80 cm
Height	29.50 inches	74.93 cm
Weight (fully loaded)	180 lbs.	81.65 kg
Raven 41700-003 Enclosure Panel Characteristics	Standard	Metric
Measurements:		
Width	19.00 inches	48.26 cm
Depth	1.50 inches	3.81 cm
Height	1.75 inches	4.45 cm
Weight	74 lbs.	33.57 kg
Comtech/EF Data SDM-300A Modem Characteristics	Standard	Metric
Measurements:		
Width	19.00 inches	43.18 cm
Depth	15.50 inches	39.37 cm
Height	1.75 inches	4.45 cm
Weight	9.50 lbs.	4.31 kg
Raven 41700-001 Fan Panel Characteristics	Standard	Metric
Measurements:		
Width	19.00 inches	48.26 cm
Depth	1.67 inches	4.24 cm
Height	5.25 inches	13.35 cm
Weight	1.60 lbs.	0.73 kg

Raven 41700-005 Computer Characteristics		Standard	Metric
Measurements:			
	Width	19.00 inches	48.26 cm
	Depth	15.00 inches	38.10 cm
	Height	3.50 inches	8.89 cm
Weight		18.50 lbs.	8.39 kg
Raven 41700-006 Power Distribution Characteristics		Standard	Metric
Measurements:			
	Width	19.00 inches	48.26 cm
	Depth	4.50 inches	11.43 cm
	Height	1.75 inches	4.45 cm
Weight		4.00 lbs.	1.81 kg
Raven 41700-004 Monitor Clamp Characteristics		Standard	Metric
Measurements:			
	Width	19.00 inches	48.26 cm
	Depth	0.75 inches	1.91 cm
	Height	1.75 inches	4.45 cm
Weight		8.00 oz.	0.23 kg
Raven 41700-015 Keyboard/Monitor/Mouse Characteristics		Standard	Metric
Measurements:			
	Width	19.00 inches	48.26 cm
	Depth	18.50 inches	46.99 cm
	Height	3.50 inches	8.89 cm
Weight		31.50 lbs.	14.06 kg
Raven 41700-777 Interface Unit Characteristics		Standard	Metric
Measurements:			
	Width	19.00 inches	48.26 cm
	Depth	13.00 inches	33.02 cm
	Height	3.50 inches	8.89 cm
Weight		14.00 lbs.	6.35 kg

Raven 41700-002 STU/STE Drawer Characteristics		Standard	Metric
Measurements:			
	Width	19.00 inches	48.26 cm
	Depth	15.00 inches	38.10 cm
	Height	3.50 inches	8.89 cm
Weight		9.50 lbs.	4.31 kg
Raven 41700-085 Combiner/Divider Panel Characteristics		Standard	Metric
Measurements:			
	Width	19.00 inches	48.26 cm
	Depth	4.00 inches	10.16 cm
	Height	5.22 inches	13.26 cm
Weight		3.00 lbs.	1.36 kg
Raven 41700-093 Combiner/Divider Panel Characteristics		Standard	Metric
Measurements:			
	Width	19.12 inches	48.56 cm
	Depth	4.00 inches	10.16 cm
	Height	15.53 inches	39.45 cm
Weight		9.00 lbs.	4.08 kg
Raven 41700-185 Patch Panel Characteristics		Standard	Metric
Measurements:			
	Width	19.00 inches	48.26 cm
	Depth	1.25 inches	3.18 cm
	Height	4.34 inches	11.02 cm
Weight		1.00 lbs.	0.45 kg
Raven 41700-193 Patch Panel Characteristics		Standard	Metric
Measurements:			
	Width	19.00 inches	48.26 cm
	Depth	1.25 inches	3.18 cm
	Height	5.22 inches	13.26 cm
Weight		1.50 lbs.	0.68 kg

1.15.2 Electrical Characteristics

The RFMOW electrical characteristics are listed in Table 1-24.

Table 1-24 Electrical Data	
RFMOW Characteristics	Value
Input Power	95 to 125 VAC

1.15.3 Environmental Characteristics

The RFMOW environmental data is listed in Table 1-25.

Table 1-25 Environmental Data		
Characteristics		Value
Temperature (Ambient)	Non-Operating	-40°C to 60°C (-40°F to 140°F)
	Operating	0°C to 40°C (32°F to 104°F)
Relative Humidity	Non-Operating	10 to 90% Non-Condensing
	Operating	10 to 90% Non-Condensing
Altitude	Non-Operating	To 15,000 ft. above mean sea level
	Operating	To 10,000 ft. above mean sea level
Shock and Vibration	Non-Operating	As encountered during normal equipment transport by common carrier as secured cargo by land, sea, or air, and as encountered during tactical off-road movement
	Operating	As encountered during normal operator maintenance

1.16 EQUIPMENT SUPPLIED

Chapter 5 of this manual provides a parts list of the equipment supplied with the RFMOW.

1.17 EQUIPMENT REQUIRED BUT NOT SUPPLIED

The equipment that is required, but not supplied for the RFMOW is shown in Table 1-26.

Table 1-26 Government Furnished Equipment	
Equipment	Remarks
COMSEC Equipment	KIV-7 and Secure Telephone Equipment (STE)

1.18 INITIAL INSTALLATION AND SETUP

The following sections provide information required for installation, setup, and replacement of the Replacement Frequency Modulated Orderwire (RFMOW) for use. The information includes:

- Equipment location and mounting
- Power distribution and grounding
- Unpacking
- Setup and preparation for use
- Cooling System

1.19 EQUIPMENT LOCATION AND MOUNTING

The RFMOW is designed to be rack-mounted in a standard depth, 19-inch wide equipment rack.

1.20 POWER DISTRIBUTION AND GROUNDING

The following subparagraphs describe the power distribution and grounding of the RFMOW.

WARNING

Proper grounding is an important safety feature, and must be a primary consideration in all electrical and electronic equipment installations. Ensure that all grounding connections are secure and that all grounding cables are kept out of vehicle and personnel paths.

WARNING

Use extreme care when working around electrical equipment to avoid the possibility of severe or fatal electrical shock. Remove all jewelry (i.e. rings, necklaces, etc.) before working with the RFMOW.

WARNING

Ensure that all power connections are properly insulated, clean, and mechanically secure to prevent personnel injury when the RFMOW is powered up and operated. When the RFMOW power cables are installed, carefully inspect all connectors and wiring for worn or broken parts. Make any necessary repairs before powering up the RFMOW. If any cable or connector damage is discovered while the RFMOW is operating, the RFMOW should be powered down and the damage repaired immediately.

1.20.1 Power Distribution

The 95-125 VAC, 47-63 Hz AC power is input via the AC Power Connector (located on top of the RFMOW chassis) and is applied to the RFMOW. The Power Distribution provides operating voltages to all major components of the RFMOW.

1.20.2 Grounding

Grounding to the user equipment rack shall consist of a grounding cable attached to the RFMOW grounding stud on top of the Rack Adapter.

1.21 RFMOW UNPACKING

Upon receiving the RFMOW, remove the rack adapter and the various boxes from the shipping container. Remove the units from the shipping boxes. Remove all packing materials from inside the RFMOW Rack and Interface Unit. Inspect for any obvious signs of external damage due to shipping. Retain the original shipping containers in case the unit(s) need to be returned to the depot for repair.

1.22 SETUP AND PREPARATION FOR USE: ALL MODELS

Install the RFMOW by performing the steps in Section 4.4.1.

1.23 COOLING SYSTEM

The RFMOW is air-cooled by a fan assembly that pulls air in through two intakes in the fan panel assembly towards the top of the Rack Adapter. See maintenance procedures in Chapter 4 for filter cleaning and/or replacement information.

CHAPTER 2

OPERATING INSTRUCTIONS

2.1 INTRODUCTION

This chapter provides the information necessary for setup, initialization, and operation of the RFMOW. This chapter includes:

NETWORK TERMINAL (NT)

- Principles of Operation
- Equipment Theory of Operation and Functional Diagrams
- Controls and Indicators
- Equipment Description
- Equipment Power-Up
- Equipment Power-Down
- NT Installation, Configuration, and Checkout

2.2 PRINCIPLES OF OPERATION

2.2.1 Subsystems – Servers and Clients

At each site, there must be one server and at least one client. The server is located on the computer that is physically attached to the RFMOW equipment. A client may also reside on the same computer as the server. Other clients may be connected to the server via an Ethernet network (see Figure 2-1, RFMOW System Network Node Architecture)

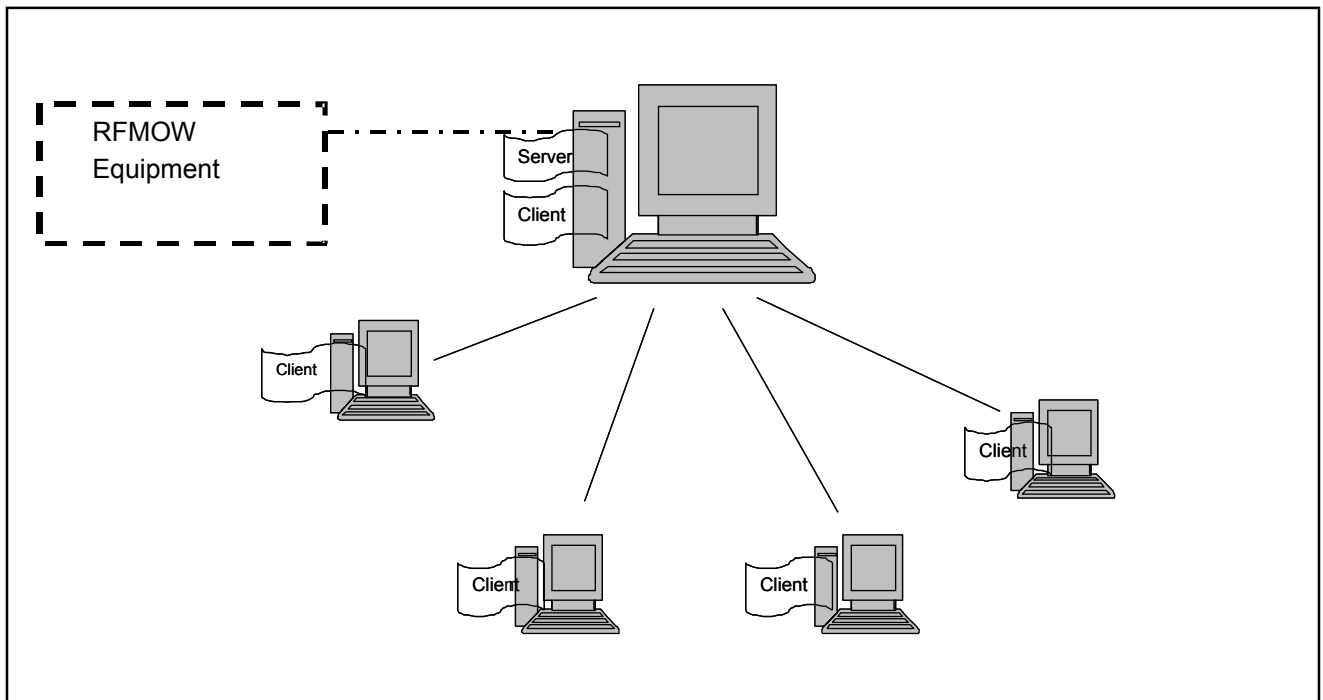

Figure 2-1. RFMOW System Network Node Architecture

There are two types of clients. One is the control client and the other is the monitor client. The client which connects to the server first is designated the control client. However, the control client can hand over its

control privilege to any monitor client that is connected to the server. Only control clients are permitted to make changes to equipment configurations that could affect the operation of the RFMOW network.

When the RFMOW terminal software is started, it first examines the hard disk for a file containing basic configuration data. If this file is not found, the software proceeds through the terminal initialization and configuration screens and the operator has to configure the terminal manually. If the file is found and contains valid configuration data, this data is used as default data. The software will still display the terminal initialization and configuration screens. The operator should check that the data as displayed in the initialization and Power and Frequency Configuration screens is correct and then click OK at each screen to confirm the data. If any parameters need to be changed, follow the procedure in Chapter 4 for the specific screen.

For an NT, the software also reads a file on the hard disk that contains network data, to determine whether there was a problem at the terminal (e.g., a power outage) and if the PC/Controller was disrupted during normal operations. In this case, the software will try to resume the network using the existing database. If the network has not changed since the terminal went down, the terminal will automatically resume normal operations. If it is found that the state of the network has changed while the terminal was down, RFMOW will wait for an updated TDMA schedule, which comes automatically from the NCT via the FOW. It will then proceed with the login process to rejoin the network.

2.2.2 Subnets

The RFMOW network may be divided into multiple subnets. A RFMOW Subnet ID and frequency set are identified by the Satellite Access Authorization (SAA) and entered into the RFMOW software by the operator. Each Subnet operates at a different set of frequencies and Subnet ID, unique from the other subnets within the network. The NCT operator must define at least one subnet during the initial establishment of the network. All NTs entering the network must use an existing subnet defined in the SAA for network access.

2.2.3 Network Messages

All automated operations at the NCT and NT are executed through the exchange of network messages over the FOW and ROW. The general message format for all messages is shown in Figure 2-2 and an explanation for each of the fields in the message template is described in Table 2-1.

Header (SOM)		
CRC		Message Type
Destination ID	Flags	Source ID
ACK Number		Sequence Number
Payload . . .		Payload Length
		. . .

Figure 2-2. Network Message Format

TABLE 2-1 Network Message Fields		
MESSAGE FIELD	SIZE IN BYTES	PURPOSE
SOM	4	Delimiter indicating the beginning of a message
CRC	2	Cyclic Redundancy Check for the rest of the message
Message Type	1	Identifies the type of message (e.g., text orderwire)
Source ID	1	ID of the terminal that created this message
Destination ID	1	ID of the [first] destination (but, see flags)

TABLE 2-1 Network Message Fields			
MESSAGE FIELD	SIZE IN BYTES	PURPOSE	
Flags	1	Bit field containing the following flag bits:	
		0x80	Destination = All Terminals
		0x40	Invalid ID - "I have No ID"
		0x20	Destinations in payload (byte 16 = number of destinations; bytes 17-n = Destination IDs)
		0x10	message is a fragment (byte 16 = fragment number; byte 17 = number of fragments)
		0x08	message is urgent data
		0x04	message is a retransmitted message
		0x02	message is part of a group to
		0x01	message needs to be acknowledged
Sequence Number	2	Identifier used for acknowledging messages	
ACK Number	2	Number of the latest message received by the source terminal	
Payload Length	2	Size of payload in bytes	
Payload	Variable	Message data	

The "Flags" byte contains information related to the addressing and acknowledgment of messages. Network messages can be grouped into five sets based on their function:

- a. Network control messages
- b. Network login/logout messages
- c. Equipment control messages
- d. Network data messages
- e. Secure voice configuration messages

Each group of messages are explained in further detail in the following subsections.

2.2.3.1 Network Control Messages

Network control messages are used by the NCT to inform the NTs of changes in network operation. Some messages are the "Bulletin Board" (BB) message, the "Begin Access Window" message; the "Access Window is Open" message, and the "TDMA Schedule" message. The BB message is periodically transmitted by the NCT to all NTs in the network. It serves three purposes. The primary purpose is to inform terminals (which are not currently members of the network) of the network's current operating parameters. These parameters include the FOW frequency and the ROW frequency for each subnet, the network name, the satellite Inter Range Operation Number (IRON), and the remaining time until the next access period where new NTs are allowed to attempt network entry. This information is required for initial entry into the network. The BB message additionally includes the "network time" at the moment of transmission. When an NT is waiting to login to the network, it uses the network time in the BB message to estimate the difference between the local system clock and the network time. The network name and satellite IRON are used to ensure that an NT acquiring the FOW is communicating within the desired network.

Other messages ("TDMA Schedule", "Begin Access Window", "Access Window is Open") inform the NTs that the network is transitioning to a state of Normal operations, or that the network is transitioning to or is within an Access window during which additional terminals may contend for network entry. These messages disseminate the information required by NTs when the network switches between operating modes. In the

Normal mode of operation, the network is functioning directly in support of its mission; to provide control orderwire services between the NCT and the NTs. In the Access mode of operation, NTs gain access to the network by logging-in. At any one point in time, the network is either allowing terminals to join the network (Access), or the network is supporting control orderwire traffic (Normal). These messages and their use are fully described in Section 2.2.6 (Network Modes of Operation).

Other network control messages include the "Network Shutdown", "Suspend Network", "Resume Network", "Request Network Control", "Handover Network Control", "Accept Network Handover", "Deny Network Handover", "NCT Frequencies", and "NCT Network Configuration" messages which are used in other network control operations.

2.2.3.2 Network Login/Logout Messages

The login/logout message group is composed of messages used in the process of logging in to or out of the network. These messages include the "Row Access Request" "Grant of Row Access" "Accept of Row Access" "ROW Is Good" "ROW Release" "Login Request" "Log in Acknowledge" "Log in Successful" "Login Failure" "NT Clock" "NT Term Conf Data" "Log out Request" "Log out Postpone" "Logout Done" "Logout Deny" "Force Logout" "Disconnection" "Reconnection" and "Reconnect Request" messages. The messages related to the ROW, Log in, NT Clock, and the NT Term Conf Data message are used in the log in process that is fully explained in Section G-1.4.1 Network Login (NT). The Log out messages are used by the NCT and an NT to control the process of logging an NT out of the network, are explained in Section G-1.7 (NT) for (Terminal Logout). The "Disconnection", "Reconnection", and "Reconnect Request" messages are used in management of the disconnect process. Other information regarding disconnect are described in section G-1.6 (NT) (Disconnect).

2.2.3.3 Equipment Control Messages

Terminal control messages are used by the NCT to control the equipment of an NT during execution of certain automated procedures. These messages include the "Change Modem Parameter" message, the "Hardware Command" message, the "Hardware Response" message, the "Begin and End ROW Measurement" messages, and the "Time Correction" message.

The "Begin/End ROW Measurement" messages inform an NT that the NCT wants to start/end the process of measuring the receive characteristics, that is, the frequency and Energy per bit over Noise (E_b/N_0), of the ROW as transmitted by that NT and received at the NCT. This process is fully described in Section 2.2.7 (Maintenance of Control Link Quality). During the login process, the NT's view of the network time is adjusted by the NCT to be as accurate as possible. Additionally, periodic re-synchronization is performed during normal network operation, since PC/Controller clock skew can build up to unacceptable levels unless the time is occasionally updated/reset. To accomplish this, the NCT compares the expected arrival time of the first packet of each ROW slot for a given NT to the actual arrival time of the packet. Some filtering is applied where the difference is compared to other recent differences, and if it is greater than a predefined maximum allowable variation, the NCT will send a "Time Correction" message to instruct the NT to adjust its clock by the filtered difference.

2.2.3.4 Network Data Messages

The network data messages consist of the "Network Database" "Modem Statistics" "ROW/FOW Statistics" "Link Configuration" "Text Orderwire" "File Transfer" "NCT Message Acknowledge" "Undelivered Message" and "Notice" messages. The "Network Database" message is used by the NCT to distribute the information about the nodes in the network. The "Modem Statistics" message is used by the NTs to disseminate the status of their control modem to the NCT. They are transmitted at regular intervals and assist the NCT in the proper maintenance of the control channel. The status parameters include values such as the current E_b/N_0 , the Bit Error Rate, and Received Signal Level as measured by the NT. The status of the FOW channel (as received by one NT) is derived from measurements made by its control modem. "The FOW/ROW Statistics" messages are transmitted by the NCT and are used to inform all NTs of the current status of all FOW and ROW links.

The Text Orderwire messages are text messages composed by operators and transmitted to or from the NCT and destination NTs during Normal network operation. The operation of the text orderwire is described in Section G-1.5.1 (NT) (Composing, Sending and Receiving Text Orderwire Messages). The text orderwire function provides only UNCLASSIFIED communications transmission. It is the responsibility of the operator/sender of the messages to ensure that classified information is not transmitted over this medium. Operations Security (OPSEC) should be used when composing and transmitting text orderwire messages. The secure voice orderwire is provided for those occasions where classified information must be exchanged between the NCT and an NT.

- a. The "File Transfer" message is used by any node in the network to send a file to other network recipients. The "File Transfer" message will normally contain only part of a larger file which is segmented by the originator and reassembled by the recipient nodes.
- b. The "NCT Message Acknowledge" message is used by the NCT to acknowledge receipt of a Text Orderwire, File Transfer, or other assured delivery message. This notification allows the source node to be informed that the delivery of the message was successful.
- c. The "Undelivered Message" message is used by the NCT to inform a source node that a message was not able to be delivered to the specified recipient NT.
- d. The "Notice message" is used by the NT to inform the NCT operator of a problem that has occurred at the NT that is not otherwise handled by the message protocol.

2.2.3.5 Secure Voice Configuration Messages

The secure voice configuration messages are used in the process of setting up a secure voice circuit between the NCT and an NT. They include the "Request VO" "VO Queued" "Cancel VO" "VO Removed" "Setup VO" "VO Done" and "VO Error" messages. These messages and how they are used is described in Section 2.2.9 (Operation of the Secure Voice Orderwire).

2.2.4 Forward Orderwire (FOW) Channel

The FDMA broadcast link connecting the NCT with all NTs is called the FOW. The purpose of the FOW is to transfer information in the form of messages from the NCT to the NTs or from one NT to the other NTs (through the NCT). The NCT is always transmitting the FOW whether there are messages to be sent or not (see Figure 2-3). Therefore, there can be times where the FOW contains no messages, i.e., it is idle and only a scrambled carrier is transmitted. Each message sent on the FOW is formatted as shown in Figure 2-3. Messages received at the NCT from NTs (on the ROW) are interleaved (for retransmission) with NCT originated messages and then get transmitted on the FOW.

NT 1 Msg	NT 1 Msg	NT 1 Msg	Idle	NT 2 Msg	NT 2 Msg	NCT Msg	NT 2 Msg	NCT Msg	NCT Msg	NT 3 Msg
-------------	-------------	-------------	------	-------------	-------------	------------	-------------	------------	------------	-------------

Figure 2-3. Typical FOW Sequence of Messages

2.2.5 Return Orderwire (ROW) Channel

2.2.5.1 ROW Structure

The TDMA return link connecting all NTs with the NCT is called the ROW. The ROW, as shown in Figure 2-4, is a TDMA transmission wherein each NT transmits messages to the NCT in specified time slots. Each NT is assigned a unique time slot when it logs into the network. The sequencing for NT ROW messages is similar to that for FOW messages (Figure 2-3).

NT 1 Msg	NT 1 Msg	NT 1 Msg	Idle	NT 2 Msg	NT 2 Msg	NT 2 Msg	Idle	Idle	NT 3 Msg
-------------	-------------	-------------	------	-------------	-------------	-------------	------	------	-------------

Figure 2-4. Typical ROW Sequence of Messages

From Figure 2-4, it can be seen that if an NT does not have enough messages to be transmitted to fill up its allocated time slot, then periods of idle time on the ROW will result.

2.2.5.2 ROW Utilization

Figure 2-5 (a) in conjunction with Table 2-2 explains how the ROW is used during Normal and Access network modes. Figure 2-5 (b) in conjunction with Table 2-3 explains the breakdown of an individual ROW TDMA transmission time slot.

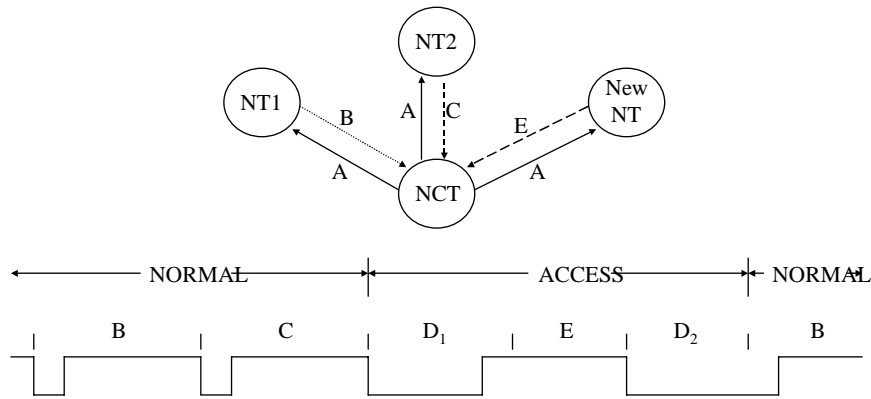

(a) ROW Transmissions during NORMAL and ACCESS Modes

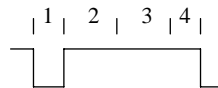

(b) Breakdown of a ROW TDMA Time Slot

Figure 2-5. ROW Details

TABLE 2-2 ROW Usage During Normal And Access Network Modes	
LABEL	DESCRIPTION
A	The FOW signal is always present while the network is operational
B	NT 1 is transmitting on the ROW frequency during this time slot
C	NT 2 is transmitting on the ROW frequency during the next time slot

TABLE 2-2 ROW Usage During Normal And Access Network Modes	
LABEL	DESCRIPTION
D ₁	An access window has opened and the NCT is waiting for a new NT to attempt to log in to the network
E	A new NT began to transmit on the ROW frequency during D ₁ and now the NCT is logging the new NT into the network
D ₂	After the new NT logged into the network, the NCT opens another access window. When no new NT attempts to log in, the network transitions to NORMAL mode

TABLE 2-3 ROW TDMA Slot Elements	
LABEL	DESCRIPTION
1	Front guard time prevents overlap of NT transmissions due to timing uncertainties.
2	Period of time allocated for NCT control modem to synchronize on NT's ROW signal
3	Time during which NT data is transmitted over the ROW
4	Time to ensure that the last "bit" of data has been transmitted by the modem before it is turned off

2.2.6 Network Modes of Operation

As mentioned previously, the RFMOW network operates in two modes: Normal (Operate) and Access. In the NORMAL mode, terminals are transmitting status, text orderwire messages, and other data associated with normal network operations in their assigned ROW TDMA slots. However, only terminals that have logged into the network and hence have been assigned a TDMA slot can transmit messages on the ROW in this mode. In order for a terminal to be assigned a ROW TDMA slot, the terminal must first log into the network. To make this process possible, the NCT periodically directs the NTs to suspend transmissions on the ROW by announcing the start of an access window. Upon receipt of the "Start of Access Window" message, all NTs currently logged into the network stop transmitting.

The NCT operator can change the time period between access opportunities and the duration of the access window. The appropriate interval and duration will depend upon the number of NTs attempting to log in to the network at any particular time. Once the time between access opportunities has expired, the NCT equipment will automatically issue a network control message that will change the network from the NORMAL mode to the ACCESS mode. (In addition to the periodic scheduled access windows, the NCT operator can initiate an access window manually at any time.)

A major factor dictating how long it takes for an NT to log into the network is the frequency uncertainty in the NT relative to the NCT. This uncertainty manifests itself as an error or a difference between the expected transmission frequency and the actual transmission frequency. This error accumulates from a number of sources: uncertainties in the NT terminal transmit chain; uncertainties in the NCT receive chain, satellite frequency translation error, and satellite Doppler. The larger the error, the further the control modem may have to search to find the NT signal. Since the optimal search bandwidth is scenario dependent, this parameter is optionally set by the NCT operator and is called the Modem Search Bandwidth.

The ACCESS mode is entered when the NCT transmits a "Start of Access Window" message that informs all NTs awaiting the opportunity to log into the network that they may attempt to do so. The NTs already logged into the network know, through the BB message, when this will happen and receive the announcement as well, so they suspend their normal operations (an ongoing secure voice call is not suspended) when the network goes into the ACCESS mode. The "Start of Access Window" message also specifies how long the window will be open (the Access Window Duration). Each NT waiting to log into the network divides the Access Window

Duration into slots of five seconds in length. The NT then randomly selects one of the slots to begin transmitting a "ROW Access Request" message. This randomization of NT login times helps to reduce the number of terminals transmitting at the same time. It is still possible that "ROW Access" messages from multiple terminals will collide. Usually the transmit times and power levels of contending NTs are different enough that the NCT is able to select one NT over the others. Once the NCT properly receives the "ROW Access Request" message from a specific NT, the NCT will transmit a "Grant Of ROW Access" message to all NTs but will only allow the specific NT to access.

Upon receipt of the "Grant of ROW Access" message over the FOW, all other NTs currently attempting to log in cease their transmissions and wait for the next "Begin Access Window" message. The NCT then completes the log in process for the terminal that was acknowledged. The completion process consists of the NCT adjusting the NT transmit power and frequency to minimize future acquisition times. The adjustment process is implemented using the "Change Modem Parameter" message that is transmitted by the NCT to the NT. After the NCT adjusts the entering terminal's modem parameters, the NT transmits its configuration data to the NCT. This information is incorporated into the overall network database maintained by the NCT.

Once the NCT has either successfully logged the new terminal into the network, or given up on the attempt, the NCT transmits a "ROW Release" message followed by another "Begin Access Window" message. The process then repeats. The process continues until the NCT receives no "ROW Access Request" during an access window for a given subnet. The NCT then changes its down converter to the frequency for another subnet and repeats above process. Determining that no new terminals wish to enter the network from any of the different subnets, the NCT transmits a "TDMA Schedule" message to distribute the new TDMA slot assignments to all logged-in terminals, and transmits "Network Database" messages to each of the terminals, containing information about all terminals now in the network. After that, a BB message is transmitted so that all the NTs can update their local time to network time. Once an NT receives the current TDMA schedule, it can begin participating in the network.

If an NT desires to log out of the network, it will transmit a "Log out Request" message to the NCT during its next TDMA transmission. The NCT will process this message without operator intervention and transmit "Force log out" over the FOW if Log out is not locked for the NT. Otherwise, the NCT operator must approve the request before the "Force log out" will be transmitted over the FOW. When the NT receives the confirmation, it will cease transmission of the ROW. If the NCT operator denies the NT log out request, a "Log out Deny" message is sent over the FOW. If no "Force log out" or "Log out Deny" message is received from the NCT the NT operator is given the option to locally force a log out. After a message indicating a successful log out, the NT is no longer part of the network. As other NTs receive the log out notification, they will update their local databases. The TDMA time slot reserved for the NT that logged out will be marked empty and will not be used by other NTs until after the next access window when the TDMA schedule is recomputed and redistributed.

2.2.7 Maintenance of Control Link Quality

Efficient operation of the RFMOW network relies on a relatively low bit-error-rate on the FOW and ROW. To assist operators in maintaining link quality, each control link is assigned a high and low receive E_b/N_0 threshold. These thresholds are settable by the NCT operator and serve as a basis for alerting the operator when maintenance actions are warranted. In addition to the link alarm thresholds, there is a link automatic power control flag for each ROW link. When this control flag is set for a ROW link, the NCT will automatically send power adjustment commands to the appropriate NT to maintain ROW link quality. These commands are executed through the "Change Modem Parameter" message.

The power adjustment for the ROW occurs in the following way. Since the NT TDMA slot is too short to allow for an accurate measurement of the received NT ROW E_b/N_0 , the NCT sends a "Begin ROW Measurement" message to a specific NT when there are no secure voice calls in progress. This message causes the NT to retune its control modem's transmit frequency to the NCT auxiliary modems receive frequency. The NT then turns its control modem on, and waits until the NT receives the "END ROW Measurement" message from the NCT. This transmission is sufficient for the NCT auxiliary modem to make a good E_b/N_0 measurement and receive the frequency offset. After a stable measurement is obtained, the NCT sends power and frequency adjustment commands, as needed, to adjust the NT's ROW transmission. The NCT then transmits an "End

ROW Measurement" message to the NT to instruct the NT software to retune the control modem back to the normal ROW frequency. This measurement process happens automatically, without operator intervention.

Control link transmit power is adjusted using the transmit power attenuator internal to the control modem. Operator intervention is normally not required to maintain proper link performance when the automatic power control flag is set. The situation can occur that the control modem reaches the dynamic range limit of the power attenuator. In such a case, the operator is alerted, and operator intervention is required. The operator must perform an uplink chain alignment to re-center the operation of the modem within the available dynamic range (see Appendix F, Power Balance/Alignment Procedure).

ROW links associated with ANCT terminals are not subject to automatic power adjustment. The ANCT operator must check and, if needed, manually adjust the terminal's output power to enable successful communication with other network terminals in the event of a network handover. This will normally require the ANCT to transmit at a higher output power and the NCT to receive the ANCT ROW with an E_b/N_0 which is outside the normal acceptable range. However, the NCT will not adjust the ANCT's power, neither during log in nor during ROW measurement. The automatic power control flag for an ANCT terminal is set to 'N' (no) and is not modifiable.

2.2.8 Operation of the Text Orderwire

The primary mission of RFMOW is to provide text orderwire communications between the NTs and the NCT. This capability is executed through a PC/Controller Text Orderwire screen that is divided into three sections. The top section displays the list of all messages sent to and from the current terminal. The middle section of the messages window is the display screen for received and sent messages. A user only needs to highlight a message from the top section to have it displayed in the display section. Messages can be copied and printed from the display section but not edited. The bottom section of the screen is an edit window used to create, modify and transmit outgoing text orderwire messages. The text orderwire capability is designed to support the transmission of UNCLASSIFIED messages only.

The size of a message that can be sent by an NT is dependent on the length of the timeslot assigned to it. This length is not known until the NT goes to Operate mode and receives the timeslot information, so composing of Text Orderwire messages is restricted until that time. Once the length of the timeslot is known, the software will prevent the operator from composing a message that is too long to be transmitted in the available time. NCT Operators may compose messages up to approximately 1000 characters in length.

Once a message has been composed and the operator has initiated the send function, the message is stored within the PC/Controller in a transmit queue. During the NT's next TDMA slot, the Text Orderwire messages (and any other messages stored in the transmit queue) are transmitted to the NCT. All messages received by the NCT are stored and processed for viewing by the NCT operator. If there are other NTs in the destination list, the message is immediately retransmitted on the FOW. The controller software on each NT then looks at the destination list of the Text Orderwire message as it is received. Messages addressed to that NT are stored for operator viewing and an indicator is posted on the operator display. Messages addressed to other NTs are discarded.

As terminals log into and out of the network, the NCT transmits updates to all NTs. In this way, an address list is maintained at each NT letting the operator know the NTs to whom he can send messages. When the operator selects an NT as a destination which has become disconnected from the network, he will be warned upon sending the message that delivery may not be possible. If the destination is later logged out of the network without accepting delivery of the message, the operator will be notified of the failure to deliver the message. All Text Orderwire messages have assured delivery in the sense that either messages are delivered, or the initiator is notified when it is determined that the delivery cannot be made.

As a message is received at the node, the server immediately enters a copy of that message into an archive file. New archive files are created each time the operator launches the software or when the current archive file reaches a software-defined maximum (currently 5 MB). The server also relays the received messages to all clients connected to the server. The client keeps up to 100 forwarded messages in a first-in-first-out manner. The operator can view and reply to the received messages on a text orderwire screen. The archive

files saved on the server are also viewable on demand. Any text message being viewed can be printed from the screen to a local (dedicated) printer if one is available.

Recalling that each NT is assigned one TDMA slot, and that the number of TDMA slots within the ROW is equal to the number of NTs recently logged into the network, the time between when a message is queued for transmission and the time at which it is received at the NCT will vary depending on the network size. Once received at the NCT, message forwarding through the FOW is essentially immediate. Thus, assuming that a TDMA slot is three seconds, and that on average an NT must wait one-half a TDMA frame cycle before its slot occurs, the message delivery delay will be approximately one-half times the number of logged-in network members times the slot duration (in seconds). For example, if there are 10 NTs logged into the network, the message delivery delay will average $\frac{1}{2} \times 10 \times 3 = 15$ seconds.

2.2.9 Operation of the Secure Voice Orderwire

The Secure Voice service provides an NT operator and the NCT operator with the capability to converse over a secure voice orderwire circuit. Only the keying material included in the Crypto Ignition Key (CIK) of each of the STEs (Tactical) at the ends of the circuit, and local security policies, limit the classification of this transaction. Direct NT-to-NT secure voice orderwire calls are not supported.

The secure voice orderwire capability is normally available at all terminals in the network. When an NT operator requests a secure voice orderwire connection, the NT equipment transmits a "Request VO" message over the ROW in its assigned TDMA slot. The NCT immediately responds with a "VO Queued" message and places the request in a queue. The NCT operator is provided with a list of queued secure voice call requests. The NCT operator may select any NT for the purpose of setting up a call.

When the NCT operator selects a destination from either the queued call request list or the list of active terminals, the activation of the secure voice call begins once the auxiliary modem is available. If a ROW E_b/N_0 measurement process is currently occurring, the setup of the secure voice circuit will be delayed until the measurement has completed. Any further use of the auxiliary modem for ROW E_b/N_0 measurement will then be suspended. A "Setup VO" message is sent automatically over the FOW informing the target NT to retune its control modem to the secure voice frequencies. The modem will retune itself automatically. After a short delay, the secure phone at each end of the circuit will connect and once the NCT operator picks up the phone, the NT's phone will ring.

If at any point the NCT's PC/Controller or the NT's PC/Controller determines that there is a problem in setting up the voice orderwire circuit (i.e., no signal from the other terminal has been received), then the PC/Controller will reset the modems to their original settings. At an appropriate time the NCT will transmit a "VO Error" message and/or the NT will transmit a "Notice" message that indicates exactly what went wrong. The terminal operator will be presented with an alert box on the display indicating the nature of the problem. The operator should use this information to correct the problem before re-attempting the connection.

Hanging up the phone terminates the call. Within the terminal equipment, hang-up is detected by the PC/Controller, and after a short delay to allow the secure telephone unit to perform a hang-up protocol, the NT PC/controller re-tunes its control modem back to the FOW and ROW frequencies for continued participation in the network. At the NCT, the PC/Controller also detects hang-up and use of the auxiliary modem for E_b/N_0 measurement is then restarted. The NCT will transmit a "VO Done" message to inform the other NTs of the status of the voice orderwire circuit.

An NT PC/Controller can choose to cancel a secure voice call request that is currently queued. This will result in a "Cancel VO" message being transmitted in the NT's assigned TDMA time slot. The NCT will remove the NT from the VO queue and send a "VO Remove" message to inform all NTs that the NT no longer has a request queued. (If the NT operator decides to cancel the request even before the "Request VO" message has been sent to the NCT (his TDMA time slot has not yet arrived), the request is simply removed from the transmit message queue at the NT.)

After issuing a setup for the secure voice call, the NCT's PC/Controller can choose to cancel the setup of a secure voice call if needed. Once the cancel setup command is issued, the call setup process will be terminated.

2.2.10 File Transfer

The file transfer function can be used by a network operator to send a file from one network node to another. This feature is designed to allow operators to communicate information throughout the network that cannot be contained within a text orderwire message, which is of very limited size. When an operator sends a file to the network, the file is segmented into file transfer messages which are delivered using the same underlying mechanism as text orderwire messages, but at a lower priority. Text orderwire messages may be composed, sent, and/or received by a node that is in the process of sending a file, and these messages will take transmission precedence over the file transfer in progress.

For a description of the file transfer operator interface, see section G-1.5.3 (NT) (Sending and Receiving Files).

2.2.11 Network Control Handover

During network operation, the control of the network (the NCT role) can be handed over to an ANCT. The NCT or ANCT Operator can initiate a handover as part of a planned network control function, or the ANCT Operator can initiate it as a recovery attempt from an abnormal network condition (the loss of the FOW signal from the NCT). Coordination is required between the NCT and receiving ANCT prior to initiation of network handover.

The ANCT can attempt to Initiate Network Control at any time the network is in NORMAL operating mode and the ANCT is not in ROW measurement. If the NCT is functioning in the network and receives the request for control from the ANCT, the NCT Operator will either accept or refuse the request and send the appropriate response to the ANCT. If the ANCT is not currently receiving communications from the NCT (the FOW has been lost), the ANCT may assume control of the network without NCT approval via the RFMOW software. However, the ANCT operator should always acquire approval by some means before attempting to force takeover of network control, as this could seriously disrupt network activity if done inappropriately.

The NCT operator may also initiate the handover of network control to an ANCT at any time the network is in NORMAL operating mode and there is an ANCT terminal logged into the network. The ANCT operator is required to approve this handover request.

Once approval for handover of network control has been given, the network is suspended temporarily to allow the NCT and ANCT to exchange roles (frequencies, terminal ids, etc.). The NTs in the network are advised of the change, and the network operation is resumed normally with the new roles.

2.2.12 File Management

Because RFMOW creates several types of log files; server event logs, client event logs, and message logs, it is important that RFMOW also manage those files to ensure that memory never becomes an issue. Log files are retained until the operator removes them or if the hard drive is over 80% full. If the machine has less than 20% of hard drive space, RFMOW will attempt to delete as many logs files as possible, oldest first, to reduce the used space on the machine to 70%. RFMOW displays a warning dialog at 75% disk usage, and another warning dialog will be displayed if there are no log files to be deleted and the disk usage is still exceeding 80%. These dialogs will continue to be displayed until the operator frees enough space for the disk usage to fall below 75%. Refer to section G-1.8 (NT) for procedures on how to remove files from the hard drive.

2.2.13 Equipment States

When the equipment is first started it will be in the IDLE State. In this state, the operator must enter basic network and earth terminal configuration data. Once correctly entered, the equipment will transition to the STANDBY state. From this state, the operator can then establish the network (NCT) or log into the network (NT). Once the network is established, or the terminal has logged into the network, the equipment will transition to the OPERATE state. In this state, all orderwire services are available.

Should an NT lose the FOW transmission or the NCT fail to receive ROW transmissions from an NT for one (1) minute and two (2) consecutive TDMA frames, the NT will enter the DISCONNECT State. In this state,

operations are limited until the problem has been corrected. If the problem is corrected within approximately 15 minutes, the NT will automatically re-join the network and return to OPERATE state. If the FOW has been restored, but the NT has not yet been able to re-join the network, and the NT detects that an Access window is being opened, the NT will revert to STANDBY state to attempt to re-log in. This will help to ensure that the NT is able to re-enter the network as quickly as possible. If the NT is unable to re-join within approximately 15 minutes, the NT will be automatically logged out of the network and returned to STANDBY state, and the NT operator must wait for an Access window to perform a normal log in to re-enter the network.

When the network is terminated by the (NCT) or an NT logs out of the network, the equipment will return to the STANDBY State. From this state the operator can either shut down the equipment, or re-establish (NCT) or re-log into (NT) the network.

When the NCT suspends the network for a frequency shift, key management or other reason, the equipment will transfer to the HOLD state

2.3 EQUIPMENT THEORY OF OPERATION

The RFMOW acts as a data-switching and control device between various peripherals to include the Interface Unit (IU), controller computer, satellite modem, secure voice unit, or other devices. Switching is controlled by software that is installed on a controller computer.

2.3.1 Device Control

The J5 connector on the rear of the Interface Unit (see Figure 1-21) is the Controller Interface. The controller computer utilizes the J4 port on the Interface Unit to control the modem within the RFMOW enclosure. The Interface Unit acts as a RS-232 to RS-485 converter for the purpose of controlling external devices.

2.3.2 "A / B" Switch Operation

In the NT mode of operation, it is necessary to control the Interface Unit (IU) to switch between the voice and data paths. In order to control the "A / B" switch on the IU, the computer communications port (COM2) must be connected to J4. To switch from data to voice mode, the computer asserts the DTR line of the communications port. De-asserting DTR returns the IU to data mode. This functionality is handled automatically using the RFMOW software as described in TM 11-5895-1780-13 Replacement Frequency Modulated Orderwire (RFMOW).

2.3.3 Sonalert Operation

When a message is received from the NCT, the sonalert is enabled. The IU can accomplish this with the help of software control. As in the case with "A / B" switch operation, a communications port on the controller computer needs to be connected to J4 of the IU. Asserting the RTS pin on the communications port enables the IU's sonalert. De-asserting the RTS pin turns the sonalert off. This is handled automatically using the RFMOW software.

2.3.4 Data Communications

Data communications occurs through the use of terminal software that utilizes a communications port on the controller computer. This is done by connecting J6 on the IU to one of the controller computer's communications ports (COM1). For data communications to occur in the NT mode of operation, DTR must not be asserted.

2.3.5 Voice Communications

Voice communication occurs by connecting a Secure Telephone device (STE) to J1 on the front or back of the IU. If the system is in NT mode, DTR must be asserted in order for the IU to select the voice path on the "A / B" switch.

Secure Telephone devices include built-in COMSEC so additional crypto devices are not necessary.

2.3.6 Enable Auto TX Off Switch on Interface Unit

The “Auto TX off” switch is a proprietary feature and *must be disabled* during normal operation. When facing the unit, reach underneath the right hand side of the Interface Unit. With your fingers on the back panel of the IU, locate the Auto TX Off switch, which will be on the upper right hand corner of the units chassis. There are two small dipswitches located here. Move the lower dipswitch to the right. (To disable the setting.)

2.4 CONTROLS AND INDICATORS

The RFMOW user interface is through the computer. The controls and indicators are illustrated in Figures 2-6 and 2-7 and described in Tables 2-4 and 2-5.

2.4.1 SDM-300A Controls and Indicators

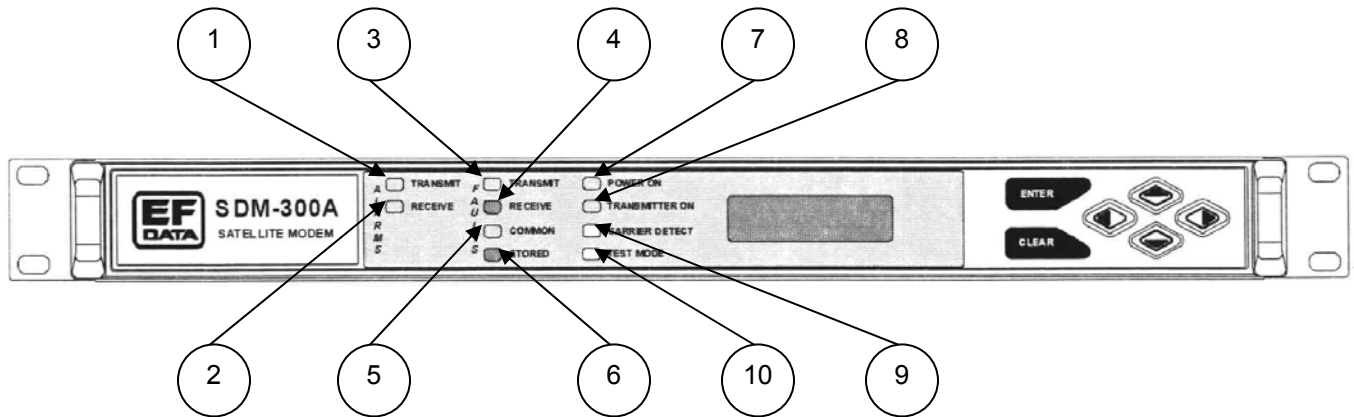

Figure 2-6 Modem Controls and Indicators

Table 2-4 Modem Controls and Indicators		
ITEM	INDICATOR	DESCRIPTION
1	Transmit (Yellow)	A transmit function is in an alarm condition.
2	Receive (Yellow)	A receive function is in an alarm condition.
3	Transmit (Red)	A fault condition exists in the transmit chain.
4	Receive (Red)	A fault condition exists in the receive chain.
5	Common (Red)	A common equipment fault condition exists.
6	Stored (Yellow)	A fault has been logged and stored. The fault may or may not be active.
7	Power On (Green)	Power is applied to the modem.
8	Transmitter On (Green)	Transmitter is currently on. This indicator reflects the actual condition of the transmitter, as opposed to the programmed condition.
9	Carrier Detect (Green)	Decoder is locked.
10	Test Mode (Yellow)	Flashes when the modem is in a test configuration.

2.4.2 Interface Unit Controls and Indicators

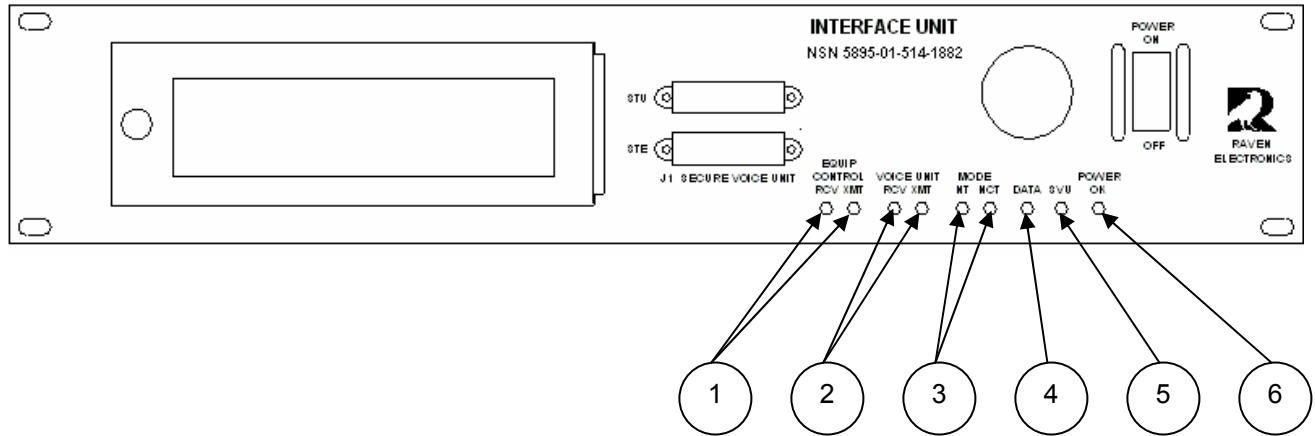

Figure 2-7 Interface Unit Controls and Indicators

Table 2-5 Interface Unit Controls and Indicators		
ITEM	INDICATOR	DESCRIPTION
1	Equipment Control RCV and XMT Status LEDs	Displays Modem Remote Control RCV/XMT Activity
2	Voice Unit RCV and XMT Status LEDs	Displays Voice Unit RCV/XMT Data Activity
3	NT and NCT Mode LEDs	Displays current setting of NT/NCT Dip Switch
4	Data Status LED	On when "Data" mode is Active
5	SVU Status LED	On when "SVU" mode is Active
6	Power On Status LED	On when IU power is on and +12V, -12V, +5V Levels are good

2.5 EQUIPMENT DESCRIPTION

The NT equipment consists of the following major hardware items:

1. Enclosure Panel and Patch Panel – Provides interface for RFMOW PC to RS-485 BUS (Remote Control of Terminal Equipment). It also provides interface for RFMOW PC to RS-232 Port Interface. It also provides interface for SDM-300A Transmit and Receive IF to the Combiner/Divider Panel. Provides interface for Ethernet input from the Signal Entrance Panel.
2. Modem – The satellite modem used in the RFMOW system can be an SDM-100, SDM-300A, or SLM-8650 modem each manufactured by EFDATA Corporation. The modem's RS-422 data port and RS-485 Remote M&C port both connect to the Interface Unit. Use of other modems requires pre-coordination with Defense Information Systems Agency (DISA) to ensure appropriate software drivers are available. Additional documentation describing the operation of these modems is published by EFDATA Corporation and can be found in manuals entitled "SDM-100 Satellite Modem Installation and Operation Manual", "SDM-300A Satellite Modem Installation and Operation Manual", and "SLM-8650 Satellite Modem Installation and Operation Manual".
3. PC/Controller – Is the Primary Operator Interface and overall equipment controller. PC runs the RFMOW software (Server/Client). *Note: Also runs CMA Software, RFMOW Power Balance and Alignment, also stores documentation, etc.*
4. Power Distribution Panel – Main power supply for the RFMOW.
5. Monitor Clamp Panel – The clamp holds the monitor in place while in use.
6. Keyboard/Video/Mouse (KVM) – User Interface for the PC Controller.
7. Interface Unit (IU) – The RFMOW Interface Unit consists of a 19-inch rack mountable enclosure housing two logic level converters, a data switch, power supply, and the KIV-7. The KIV-7 resides within the enclosure; however, it is not procured as a part of the Interface Unit. The purpose of the Interface Unit is to provide housing for the KIV-7, provide protocol conversion, and to provide a convenient point for connecting the various hardware elements.

The Interface Unit supports both MMT-1500 STU III and STE (Tactical) secure phones. The Interface Unit is able to detect which of the two secure phones is currently connected to the system, and will provide appropriate signaling to the secure voice unit. Within the Interface Unit, two logic level converters change the RS-232C signals coming from the PC/Controller into the RS-485 signals required to interface with the satellite modems' Remote Maintenance and Control (M&C) ports. The KIV-7 converts the RS-232C data signals to RS-422 signals required to interface with the satellite modems' data ports. Refer to the Interface Unit Hardware Reference Manual (Appendix D) for additional information on the Interface Unit. The specific interface connections on the RFMOW Interface Unit are:

The Secure Voice Unit port (J1), an RS-232C synchronous interface for the Secure Voice Unit (MMT-1500 or STE (Tactical)).

The Control Modem Data port (J2), an RS-422 port that connects to the control modem's data port.

The Auxiliary Modem Data port (J3), an RS-422 port that connects to the auxiliary modem's data port in an NCT configuration.

The Controller Modem Remote Control port (J4), an RS-232C interface that connects to a Computer serial port.

The Remote Control port (J5), an RS-485 port that connects to both the control and auxiliary satellite modems' Remote M&C port(s), and (on an NCT/ANCT) to the control and auxiliary frequency down converters.

The Controller Modem Data port (J6), an RS-232C interface that connects the Computer's other serial port.

The Secure Voice Unit ports are on both the front and rear panel of the Interface Unit. All other ports are on the rear panel only.

8. TRANSEC Device (KIV-7HSB) – The TRANSEC function is implemented with a low or high-speed version of the Embeddable KG-84 Communication Security (COMSEC) Module (KIV-7). (NOTE: The OCs must use the KIV-7HSB model.) The TRANSEC device is used to control and maintain access to the network. The KIV-7 does not provide text message security in the RFMOW. Accordingly, all operator text messages exchanged over the control channel must be UNCLASSIFIED.

The KIV-7 is physically mounted within the Interface Unit and connected to level converters internal to the Interface Unit. Additional documentation describing the operation of the KIV-7 is published by Mykotronx, Inc. and is entitled “Embeddable KG-84 COMSEC Module (KIV-7) User’s Manual”, and is classified FOR OFFICIAL USE ONLY.

9. Secure Voice Unit (STE (Tactical)) – The Secure Voice Unit, STE, provides the NT operator with the ability to communicate in a secure voice mode. The secure voice unit interfaces to the Interface Unit through a serial RS-232C synchronous connection. The keying material installed in each of the secure voice units, and local policy, limits the classification of allowed traffic. Additional information on the STE, see the “STE USERS MANUAL, L-3 Communications”, control number K00000187.
10. Frequency Converters – As shown in Figures 2-7, the NT configuration requires one Up Converter and one Down Converter. The RFMOW system supports the following models of converters for use at the NTs. The NTs may use any converters currently installed in the terminal. Additional documentation describing the operation of the CV-4352 Up Converter and CV-4353 Down Converter can be found in TM 11-5895-1684-13 (85) and TM 11-5895-1685-13 (93).

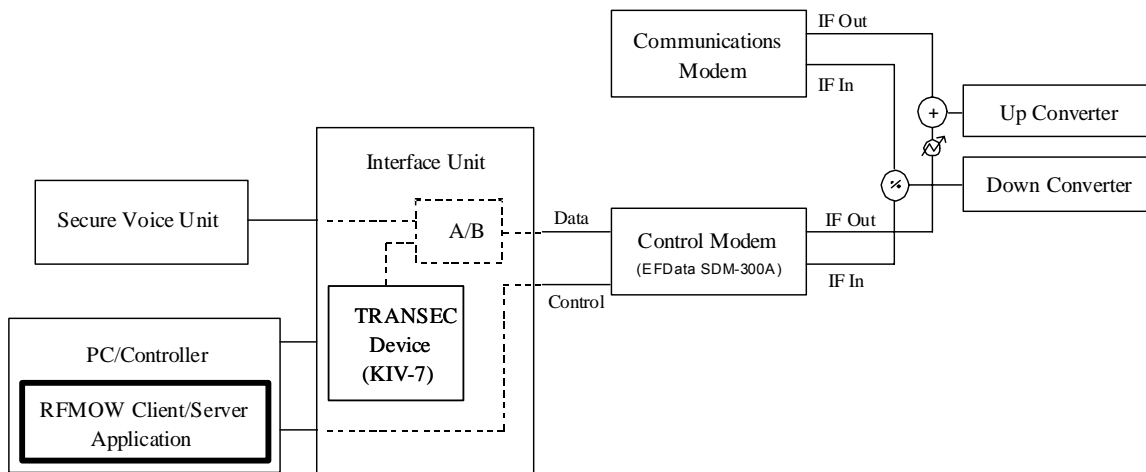

Figure 2-8 RFMOW Functional Block Diagram

2.6 EQUIPMENT POWER-UP

WARNING

Ensure that all power connections are properly insulated, clean, and mechanically secure to prevent personnel injury when the RFMOW is powered up and operated. When the RFMOW power cables are installed, carefully inspect all connectors and wiring for worn or broken parts. Make any necessary repairs before powering up the RFMOW. If any cable or connector damage is discovered while the RFMOW is operating, the RFMOW should be powered down and the damage repaired immediately.

Perform the following procedure to power up the RFMOW:

- a. Ensure that power is connected to the top of the RFMOW enclosure at the Power Input receptacle.
- b. Ensure the Interface Unit power switch is in the OFF position.
- c. Switch the Power Distribution Panel (Figure 1-16 on page 1-18) into the ON position.
- d. Open the computer front panel using the two thumbscrews and push the Power button to turn on the computer (Figure 1-13 on page 1-15).
- e. Close the Computer Front Panel.
- f. Switch the Interface Unit power switch (Figure 1-21 on page 1-23) to the ON position.
- g. Deploy the KVM keyboard and monitor out by unscrewing the thumbscrews and pulling each drawer out. (*Note: the keyboard will latch in position when pulled out*)
- h. Flip the display screen in the up position and attach the Monitor Clamp to the display panel to secure it in the upright position.
- i. Push the power button on the display panel (Figure 1-19 on page 1-21).
- j. Ensure that the fans and modem are operating.
- k. Refer to TM 11-5895-1780-13 for procedures on installing and operating the RFMOW software suite.

2.7 EQUIPMENT POWER-DOWN

Perform the following procedure to power-down the RFMOW:

- a. Press the Power button on the display panel to turn off the KVM.
- b. Remove the Monitor clamp, press in the slide releases, and stow the KVM by closing each drawer and securing the thumbscrews.
- c. Close all computer programs including the operating system.
- d. Open the Computer Front Panel using the thumbscrews and push the Power button to turn off the computer.
- e. Close the Computer Front Panel.
- f. Switch the Interface Unit Power switch to the OFF position.
- g. Switch the Power Distribution Panel into the OFF position.

2.8 NT INSTALLATION, CONFIGURATION, AND CHECKOUT

2.8.1 Equipment List

A RFMOW NT terminal consists of the equipment listed in Table 2-6.

TABLE 2-6 NT RFMOW Terminal Equipment List	
QUANTITY	DESCRIPTION
1	Personal computer (laptop) with at least a Celeron 600 MHz CPU, 256 MB RAM and 1 MB video RAM, 4.5 GB Hard drive, CD-ROM drive, keyboard, color SVGA monitor, two (2) unused serial ports for AN/TSC-85D(V)1 AND AN/TSC-93D(V)1 or AN/TSC-152 AND AN/USC-59 terminals, three (3) for 85/93D terminals and Windows 2000.
1 (optional)	Printer
1	RFMOW installation disk
1	Satellite modem, which can be an EFData SDM-100, an SDM-300A, or an SLM-8650. The SLM-8650 is located in the AN/TSC-152 AND AN/USC-59 (NT) only.
1	Digital telephone or STE (Tactical)
1	Interface Unit
1	KIV-7 crypto device
1	Cable for connecting the MMT-1500's or STE (Tactical) BDI port to the Interface Unit's Secure Voice Unit port.
1	Cable for connecting one PC/Controller serial port to the Interface Unit's Controller Modem Remote Control port.
1	Cable for connecting the other PC/Controller serial port to the Interface Unit's Controller Modem Data port.
1	Cable to connect the modems' data ports to the Control Modem Data port of the Interface Unit
1	Cable to connect the control modem's Remote M&C port to the Interface Unit's Modem Remote Control port.
1	Cable for connecting the modem I/F output to the alignment panel combiner.
1	Cable for connecting the modem I/F input from the alignment panel divider.

2.8.2 Installation Procedures

Specific placement of the equipment will depend upon space availability constraints for each terminal type and layout. In general, the modem and Interface Unit should be installed in an appropriate rack assembly and the Secure Voice Unit and PC/Controller placed in a location convenient to the operator. See individual equipment manuals for specific equipment installation instructions. Once the equipment has been installed, the equipment must be connected as shown in Figure 2-9.

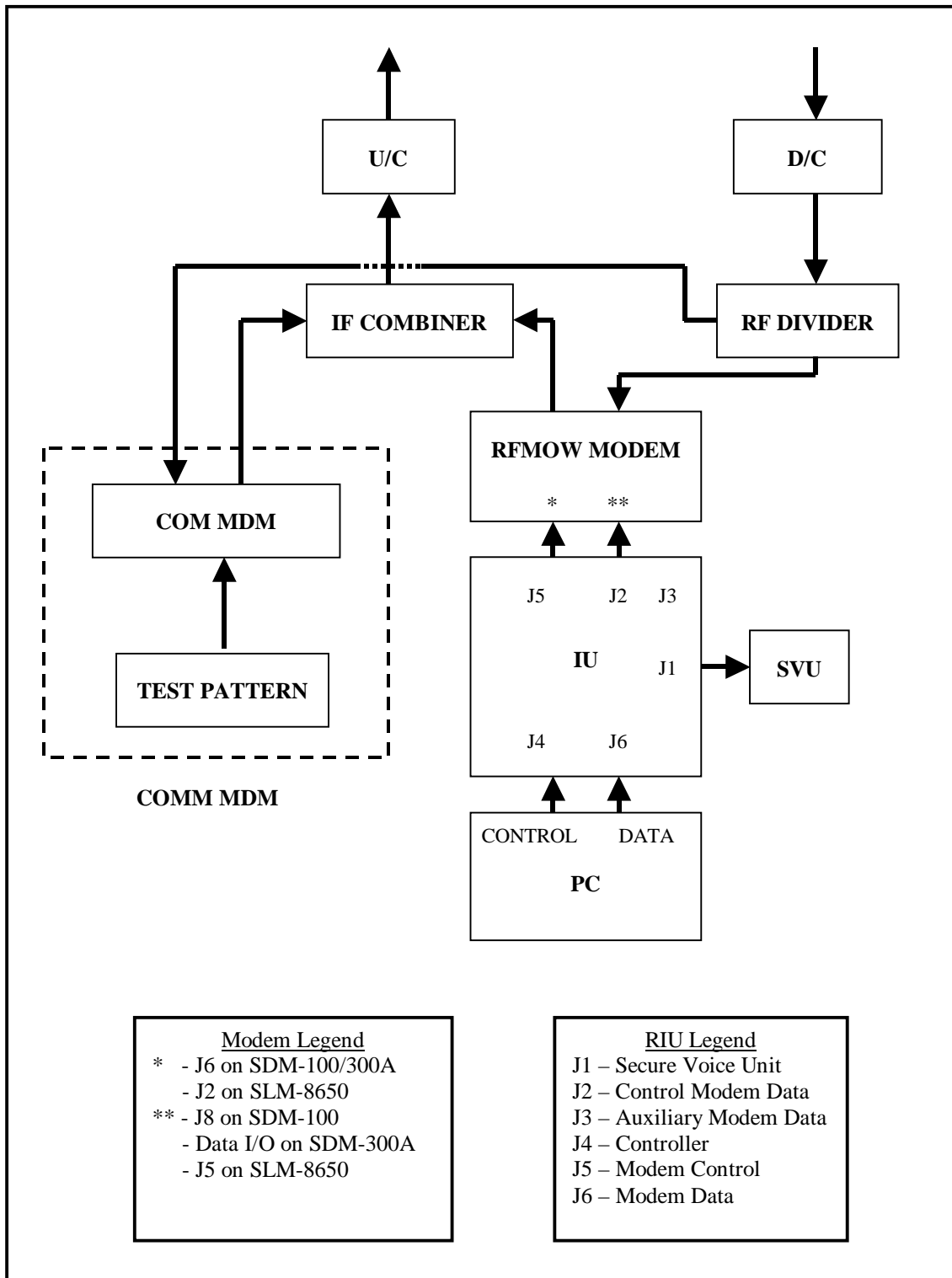

Figure 2-9 NT Equipment Connections

2.8.3 Equipment Configuration

Prior to operating the NT, the terminal equipment must be configured. The equipment configuration procedures are outlined in the following steps:

- a. If PCMCIA cards are to be used, they should be configured with the software drivers provided by the PCMCIA hardware manufacturer.
- b. Configure the Control Modem as specified in Appendix E
- c. Configure the KIV-7 as specified in Appendix E.
- d. Configure the STE (Tactical) as specified in Appendix E.
- e. Perform the RFMOW Software Installation as specified in paragraph 2.8 (RFMOW Software Installation). If an older version of RFMOW software exists, follow the procedures specified in paragraph 2.8 (RFMOW Software Un-Installation to un-install the older version).
- f. Perform the Power Balancing/Alignment as specified in Appendix F.

2.8.4 Equipment Checkout Procedures

Refer to the terminal TM for associated equipment checkout procedures.

2.8.5 RFMOW Software Installation

2.8.5.1 Un-Zip Procedures:

- a. Create a “New Folder” on the Desktop
- b. As shown in Figure 2-10, double-click the “RFMOW ver 1.3.exe” icon.

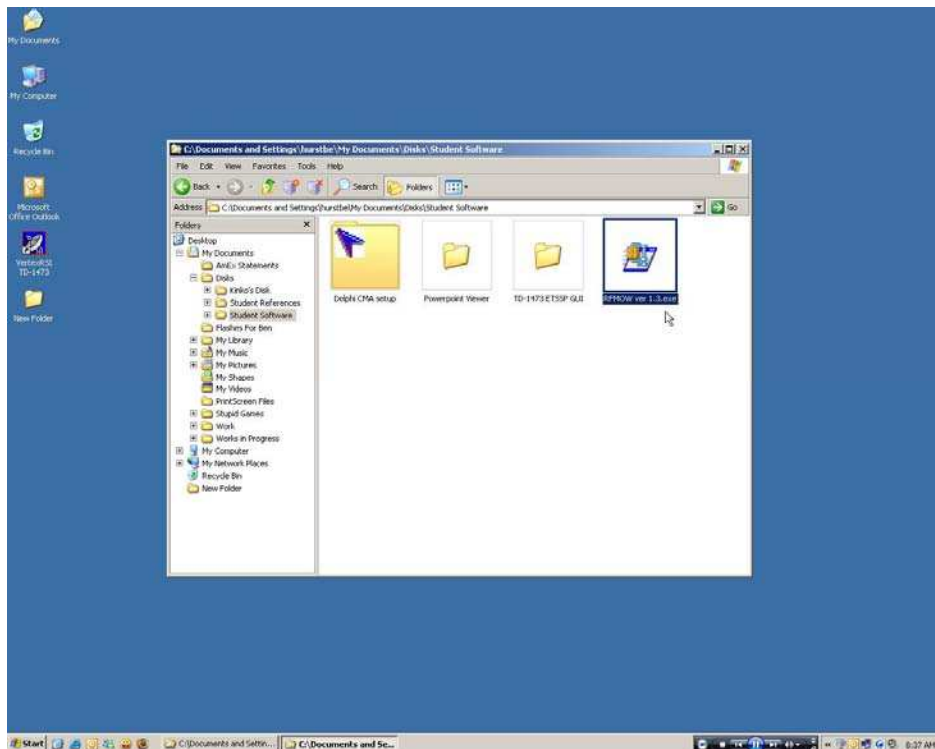

Figure 2-10 RFMOW Executable File

- c. As show in Figure 2-11, Click on the “Browse” button and select the “New folder” from the Desktop to Unzip the contents to that location. Click “OK”.

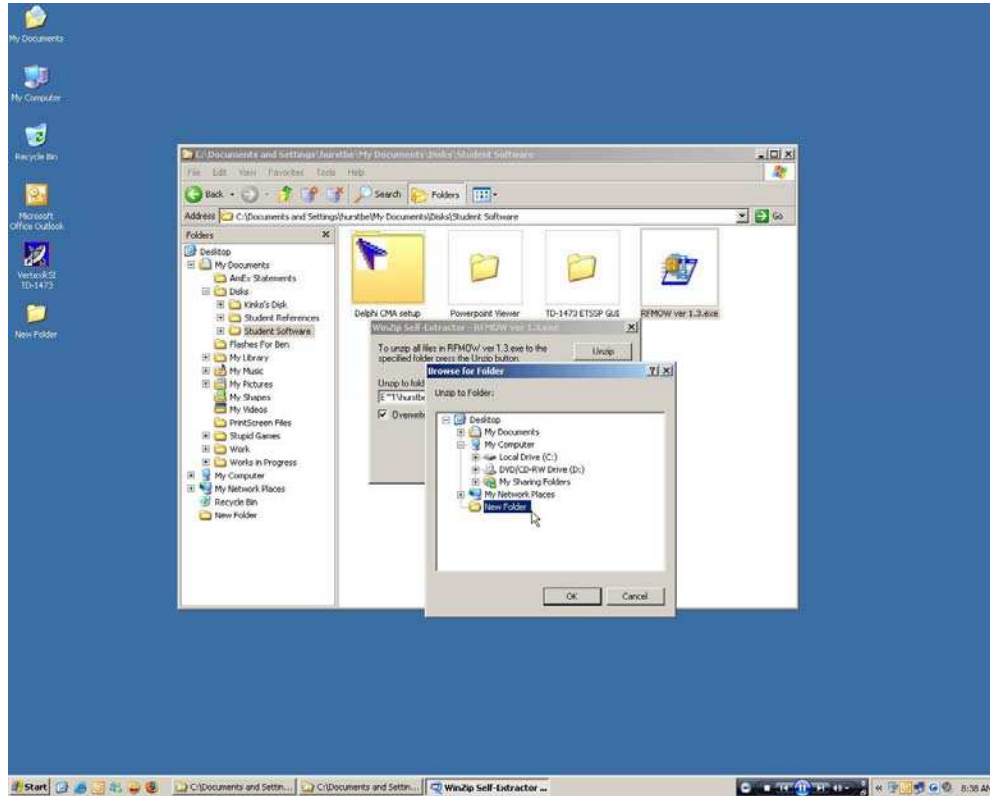

Figure 2-11 RFMOW Software Unzip File Path

- d. Click “Unzip”. Once the files unzip a pop-up that reads “33 File(s) unzipped successfully” will display. Click “OK”
- e. Close the Win-Zip Self Extractor.

2.8.5.2 Install RFMOW Software as follows:

- a. Open “New Folder” located on the Desktop.
- b. Double-click the “setup.exe” file to run the Install Shield Wizard.

- c. As shown in figure 2-12, follow the Installation Wizard allowing the default locations to be created. (By clicking “Next” without changing the settings.

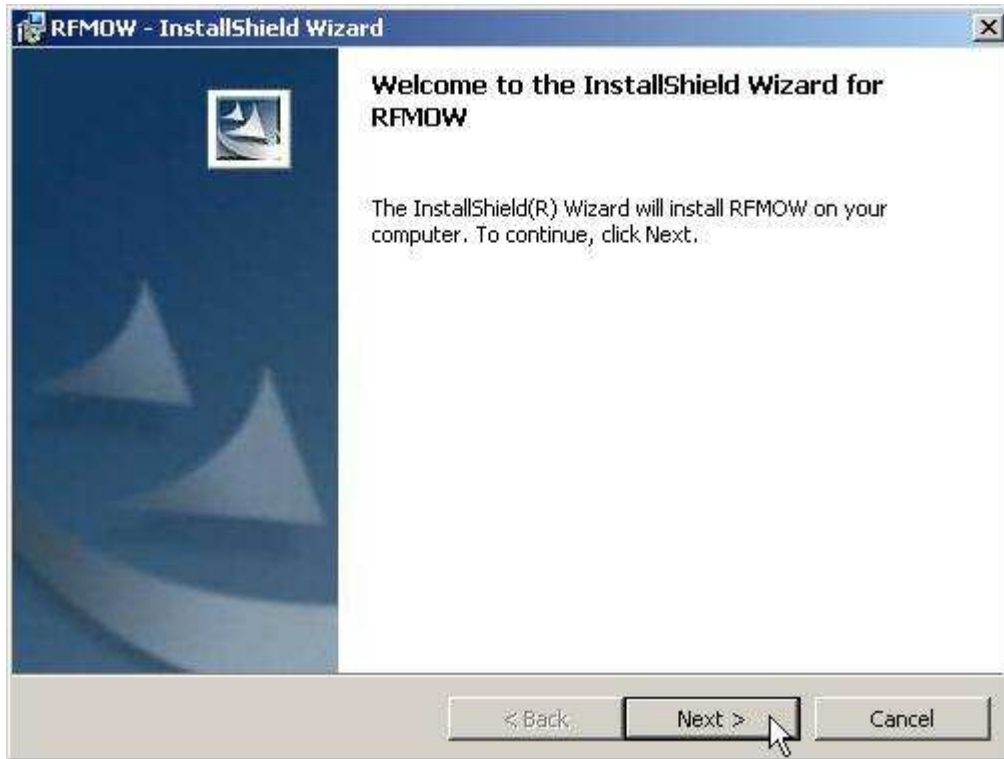

Figure 2-12 InstallShield Wizard for RFMOW

- d. After the Wizard installs the necessary files to the PC/Controller the operator will be prompted to select a terminal type to be installed. “NT with SDM-100/300 modem” **MUST** be selected (As shown in Figure 2-13) in order for the software to execute correctly. If any other selection is made from this screen the software will **NOT** pass the “Hardware Check” during the initial setup of the RFMOW.

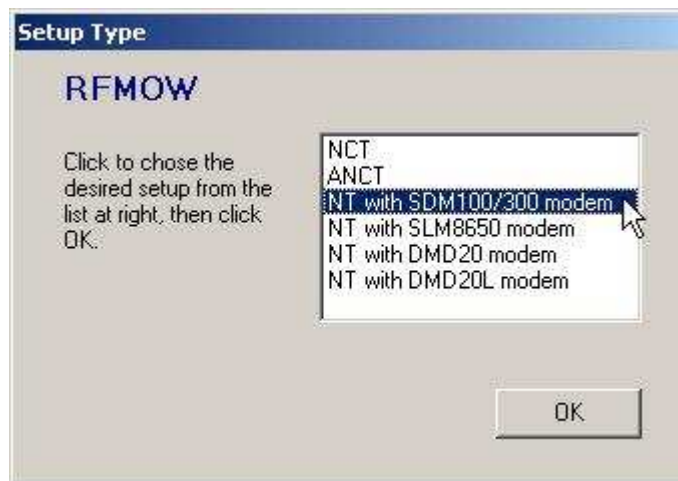

Figure 2-13 Terminal Setup Type

- e. Click “Finish” once the installation is complete. Click “OK” on the pop-up that states a restart is required for the installation to be complete.

- f. Delete the “New Folder” that was created on the Desktop for installation purposes.

2.8.6 RFMOW Software Un-Installation

Perform RFMOW Software un-installation as follows:

- a. As shown in Figure 2-12, click on the *Start* button located in bottom portion of the Microsoft Windows Desktop. Go to *Settings* option and click on the *Control Panel* option.

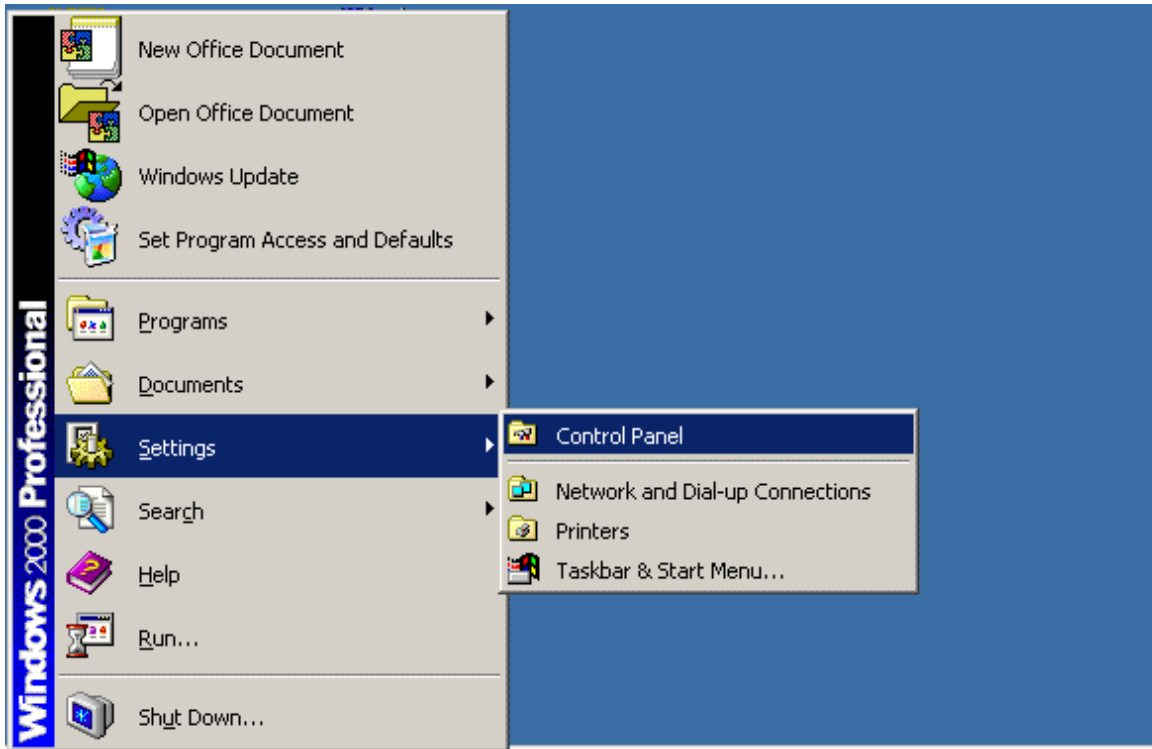

Figure 2-14 Control Panel Location

- b. As shown in Figure 2-13, in the “Control Panel” window pop-up, click on the *Add/Remove Programs* option.

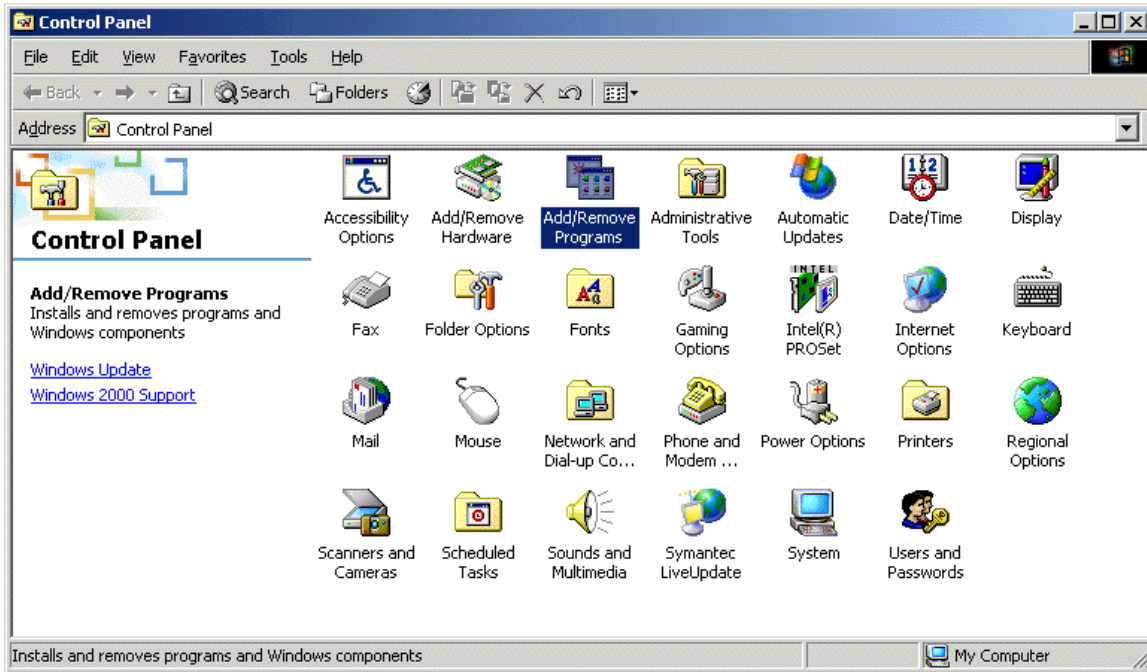

Figure 2-15 Add/Remove Programs Location

- c. As shown in Figure 2-14, in the "Add/Remove Programs" window pop-up, select *RFMOW* option and click on the *Change/Remove* button.

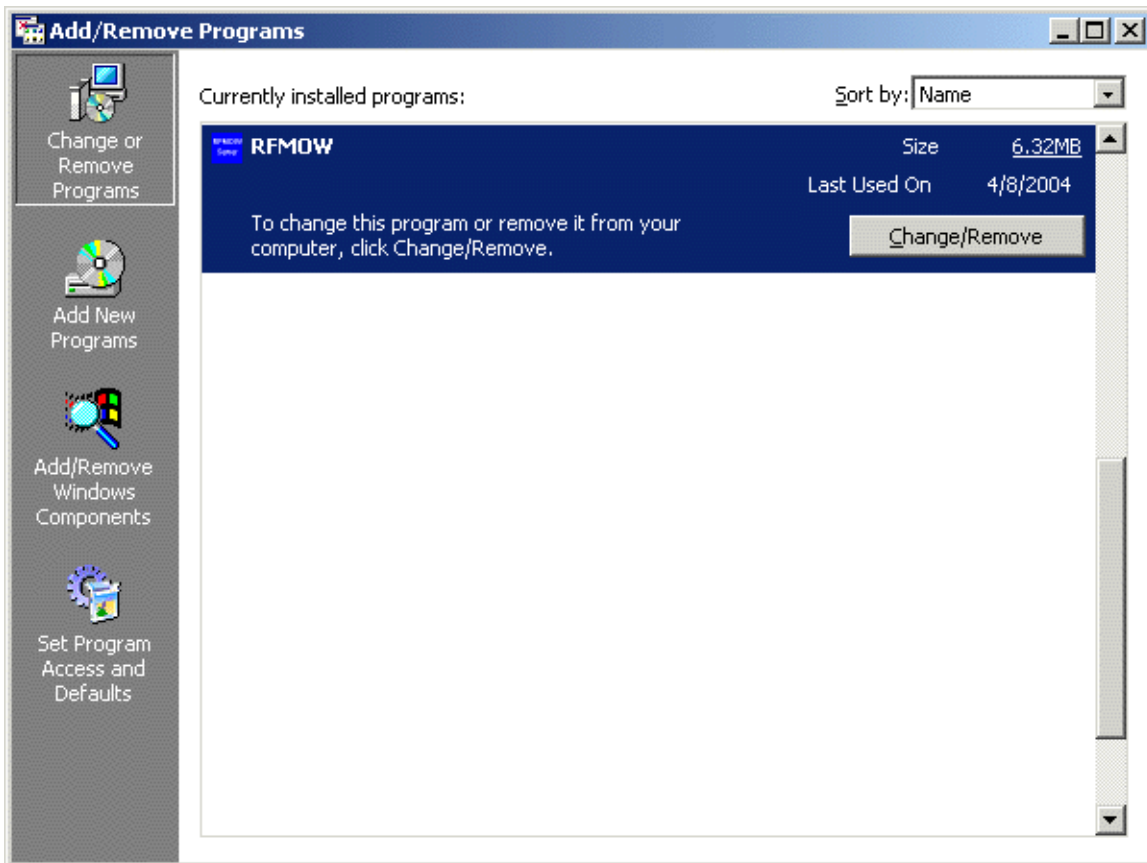

Figure 2-16 RFMOW Un-Installation Selection

- d. From the “Confirm File deletion” window pop-up, click on the Yes button to proceed with RFMOW software un-installation.
- e. From the “Remove Programs from your Computer” window pop-up, click on the OK button to finish RFMOW software un-installation.

This page left blank intentionally.

CHAPTER 3

TROUBLESHOOTING

3.1 INTRODUCTION

This chapter provides the following information for the RFMOW:

- Troubleshooting
- Connector Pin Outs
- Schematics

3.2 TROUBLESHOOTING

WARNING

Proper grounding is an important safety feature, and must be a primary consideration in all electrical and electronic equipment installations. Ensure that all grounding connections are secure and that all grounding cables are kept out of vehicle and personnel paths.

WARNING

Use extreme care when working around electrical equipment to avoid the possibility of severe or fatal electrical shock. Remove all jewelry (i.e. rings, necklaces, etc.) before working with the RFMOW.

WARNING

Ensure that all power connections are properly insulated, clean, and mechanically secure to prevent personnel injury when the RFMOW is powered up and operated. When the RFMOW power cables are installed, carefully inspect all connectors and wiring for worn or broken parts. Make any necessary repairs before powering up the RFMOW. If any cable or connector damage is discovered while the RFMOW is operating, the RFMOW should be powered down and the damage repaired immediately.

WARNING

Even with covers removed, lethal voltages may still be present inside the RFMOW. Failure to exercise caution could result in fatal or serious injury to personnel.

WARNING

High voltage, 120 VAC, is present in this equipment. Use extreme caution and ensure that at least two people are present while performing inspection, test, and maintenance procedures. Failure to comply may result in fatal or serious injury to personnel.

WARNING

Ensure that power is removed during the performance of equipment replacement and cleaning procedures. Do not open equipment enclosures when cleaning. Use of damp cleaning materials can cause shock, resulting in fatal or serious injury to personnel.

WARNING

Hazardous voltages are present. Use care when measuring for voltage. Failure to do so can result in fatal or serious injury to personnel.

CAUTION

This equipment contains static-sensitive devices. Always follow ESD handling procedures when working on this equipment.

Table 3-1 Troubleshooting

COMPONENT	PROBLEM	PROBABLE CAUSE	MAINTENANCE TASK
Fan Panel	Fans do not power on	<ol style="list-style-type: none"> 1. Interface Unit is not turned on. 2. Cable is not plugged in or not plugged in properly. 	<ol style="list-style-type: none"> 1. Make sure Interface Unit power is turned on. 2. Check Fan Panel Cable R209-0004 for proper connector position and seating.
Computer	No Power	<ol style="list-style-type: none"> 1. Problem with KVM. 2. Power cable is not properly seated. 	<ol style="list-style-type: none"> 1. Check if power light is on. If light is on, go to KVM troubleshooting. 2. Check power cable for proper seating.
	Screen goes blank after windows start-up screen	<ol style="list-style-type: none"> 1. Wrong display mode. 2. Old video driver 	<ol style="list-style-type: none"> 1. Press CTRL-ALT-F1 on the keyboard. 2. Update computer video driver.
Power Distribution Panel	No Power	<ol style="list-style-type: none"> 1. Circuit breaker is tripped. 2. Power cable is not properly seating. 	<ol style="list-style-type: none"> 1. Check circuit breaker next to power switch. If breaker is tripped, check power cable for frays or shorts. 2. If Power switch does not light up, check power cable for proper seating.
KVM	Monitor won't turn on	<ol style="list-style-type: none"> 1. Power may not be turned on. 2. Power cable may not be properly seated. 3. Computer may not be turned on. 	<ol style="list-style-type: none"> 1. Check if Power distribution panel is turned on. 2. Check power cable for proper seating. 3. Turn on computer.
	Distorted Image	<ol style="list-style-type: none"> 1. Wrong clock frequencies. 	<ol style="list-style-type: none"> 1. Press the EXIT button to do an Auto Adjust.
	Keyboard and Mouse do not work	<ol style="list-style-type: none"> 1. Connectors may not be plugged in, in correct location, or properly seated. 	<ol style="list-style-type: none"> 1. Check the keyboard and mouse connectors on the back of the KVM and the computer for proper location and seating.
	Screen goes blank after Windows start-up Screen.	<ol style="list-style-type: none"> 1. Wrong display mode. 2. Old video driver 	<ol style="list-style-type: none"> 1. Press CTRL-ALT-F1 on the keyboard. 2. Update computer video driver.

Table 3-1 Troubleshooting			
COMPONENT	PROBLEM	PROBABLE CAUSE	MAINTENANCE TASK
KVM	Mouse Cursor Jittering		Refer to Flow Chart A-7.
Interface Unit	No Power	<ol style="list-style-type: none"> 1. Power switch is off. 2. Power distribution panel is off. 3. Power cable is not properly seated. 	<ol style="list-style-type: none"> 1. Make sure the power switch is turned on. 2. Make sure the power distribution panel is turned on. 3. Make sure the power cable is properly seated.
	Power LED is off, but other LEDs are on.	<ol style="list-style-type: none"> 1. Missing necessary voltage. 	<ol style="list-style-type: none"> 1. The power LED is an indicator light for the voltage comparator circuits. If this light is not on then a necessary voltage for proper operation is missing. The IU will need to be sent in for repairs.
	SVU light is not functioning.	<ol style="list-style-type: none"> 1. SVU Cable is not properly seated. 2. Controller cable is not properly seated. 	<ol style="list-style-type: none"> 1. Check cable connections at J1 for proper seating. 2. Check J4 cable connections.
	Data won't send	<ol style="list-style-type: none"> 1. Cables are not properly seated or are in the wrong location. 2. KIV is not installed or operating properly. 	<ol style="list-style-type: none"> 1. Check cables for proper location and seating. 2. Make sure KIV is installed and operating properly.
	DATA light is not functioning	<ol style="list-style-type: none"> 1. Cable is not properly seated. 	<ol style="list-style-type: none"> 1. Check cable connections at J4 for proper seating.
	NCT light is on	<ol style="list-style-type: none"> 1. Dip Switch set to NCT mode. 	<ol style="list-style-type: none"> 1. Change NCT/NT dipswitch on back of Interface Unit to NT mode.
	IU beeps and cuts off transmit channel after 1 minute.	<ol style="list-style-type: none"> 1. Enable Auto XMT Off Switch is turned on. 	<ol style="list-style-type: none"> 1. Set "Enable Auto XMT" Off Switch to the disable position.
	VOICE UNIT RCV/XMT lights are not functioning	<ol style="list-style-type: none"> 1. SVU light is not functioning. 2. Cables are not properly seated or are in the wrong location. 	<ol style="list-style-type: none"> 1. Check if SVU light is on. If light is off, go to 'SVU light not functioning' 2. Check cable connections at J1 and J2 for proper seating.
	EQUIP CONTROL RCV/XMT lights	<ol style="list-style-type: none"> 1. Loose or disconnected J4 Cable 2. Loose or disconnected J5 Cable 	<ol style="list-style-type: none"> 1. Check J4 Cable 2. Check J5 Cable
	SONIC ALERT does not operate	<ol style="list-style-type: none"> 1. Loose or disconnected J4 Cable 	<ol style="list-style-type: none"> 1. Check J4 Cable
	Control Port Error Message		Refer to Flow Chart A-4.
	Auxiliary Port Error Message		Refer to Flow Chart A-5.
	Data Port Error Message		Refer to Flow Chart A-6.
RFMOW Software	RFMOW Server Application will not run		Refer to Flow Chart A-1.
	RFMOW Client Application will not run		Refer to Flow Chart A-2.

Table 3-1 Troubleshooting

COMPONENT	PROBLEM	PROBABLE CAUSE	MAINTENANCE TASK
RFMOW Software	RFMOW Client Application does not attach to RFMOW Server Application		Refer to Flow Chart A-3.
Network Entry	FOW not on the satellite		NCT Problem.
	No "Carrier Detect"		Refer to Flow Chart B-1.1 and B-1.2.
	Getting "Carrier Detect" but not receiving Bulletin Board Messages		Refer to Flow Chart B-2.
	ROW not on the satellite		Refer to Flow Chart B-3.1 and B-3.2.
	ROW is on the satellite		1. Verify output of Up Converter for carrier at correct offset. 2. Observe Event Log for excessive power corrections during login.
Server Disconnect State	NT put into disconnect state		Refer to Flow Chart C-1.
Server Logged Out	NT is forced out of the network		Refer to Flow Chart C-2.
Text Messaging	Transmitted Messages do not appear in the transmit window		Refer to Flow Chart D-1.
	Transmitted Messages appear in the transmit window, but no response is received		Refer to Flow Chart D-2.
Secure Voice	RFMOW Client Application reflects voice setup, but STE does not ring		Refer to Flow Chart E-1.

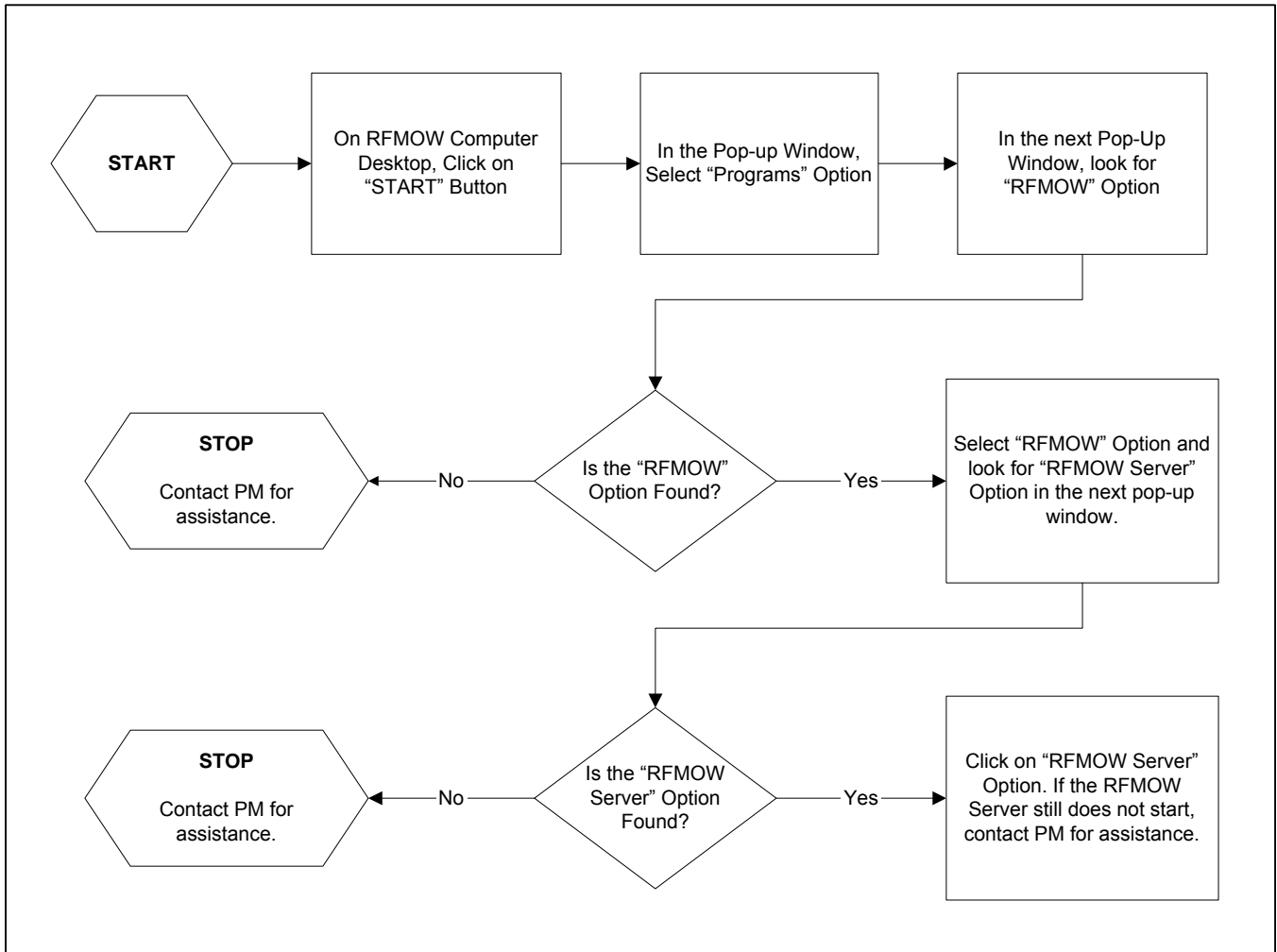

Flowchart A-1 RFMOW Server Application will not run

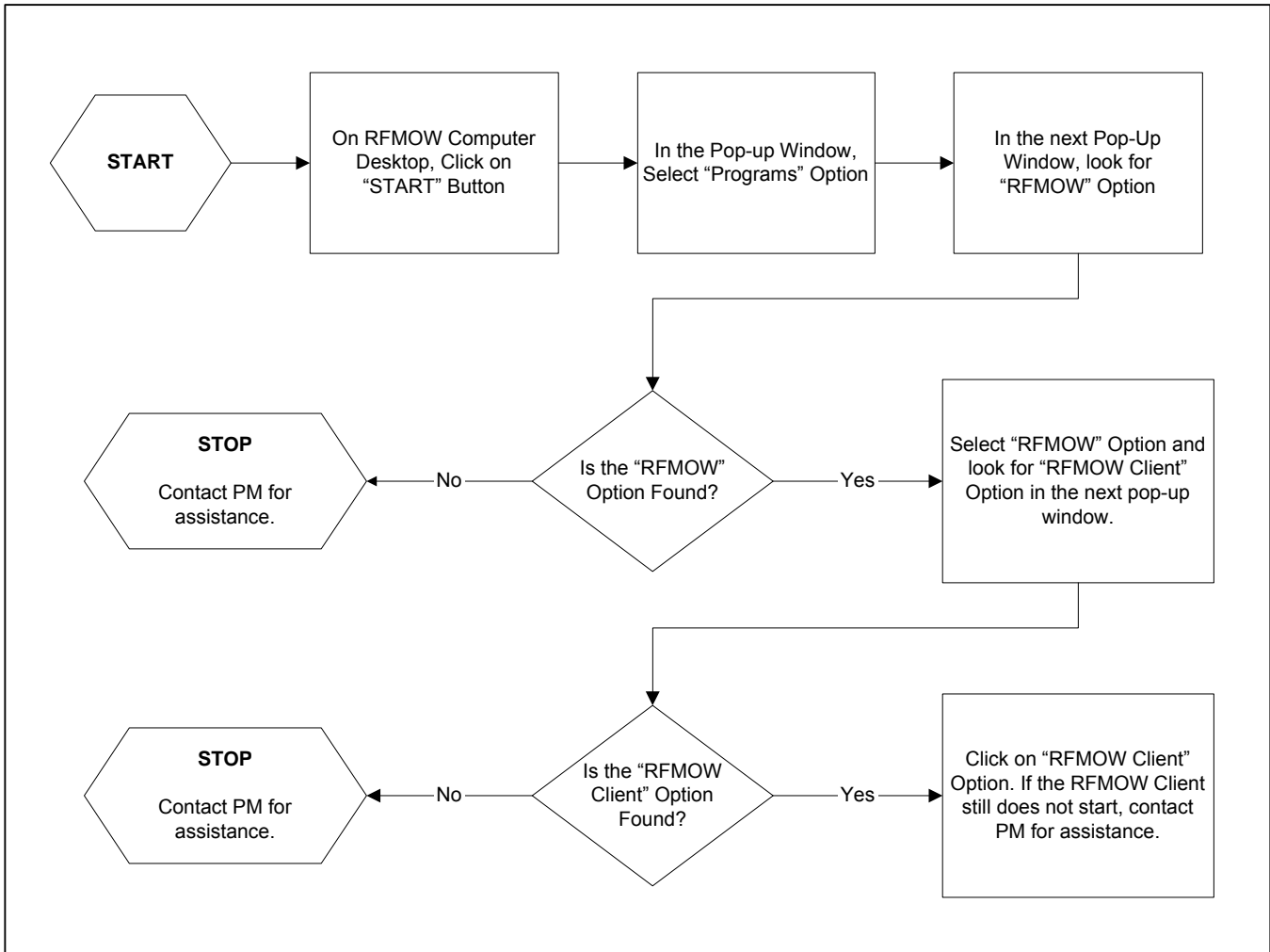

Flowchart A-2 RFMOW Client Application will not run

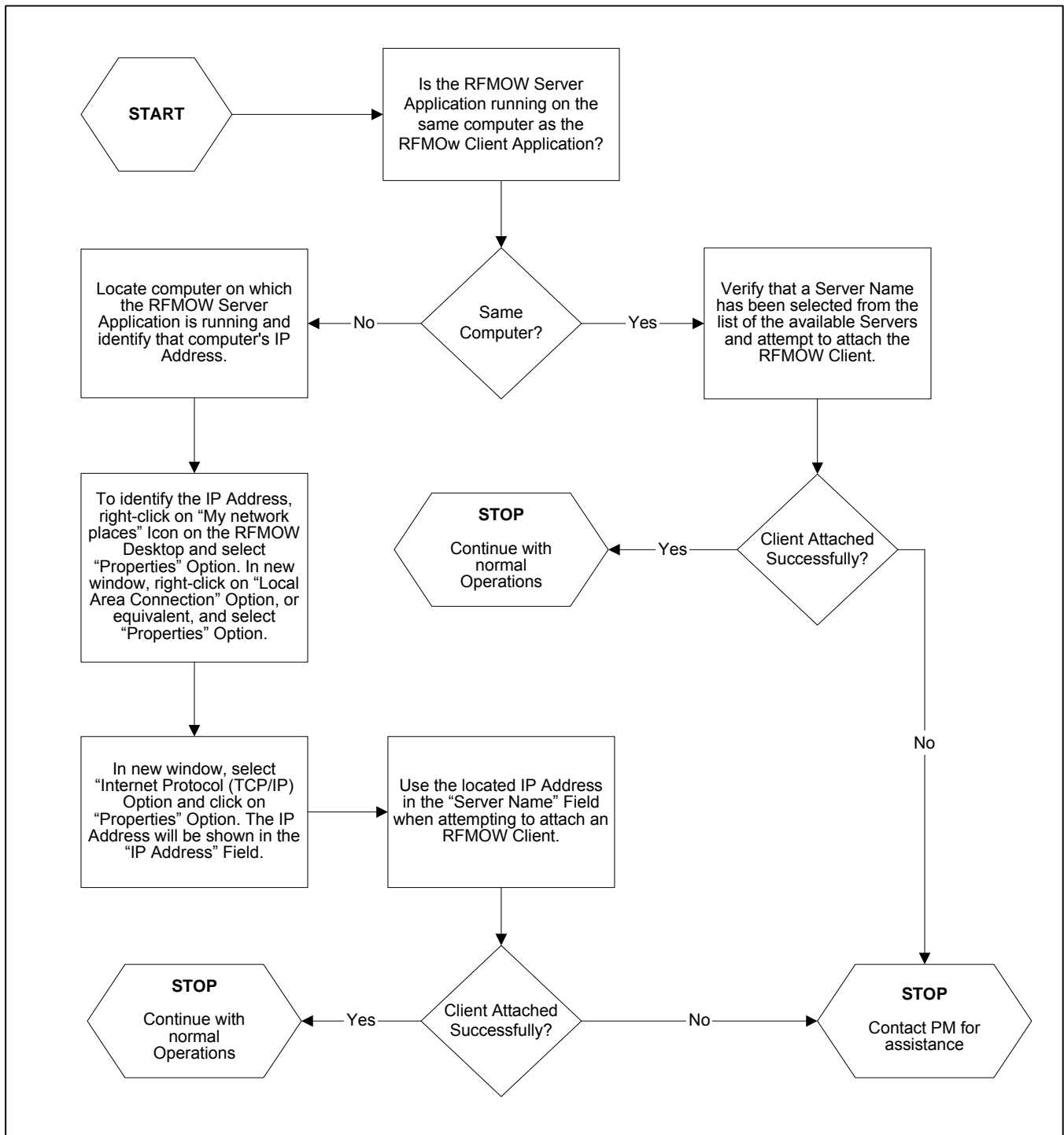

Flowchart A-3 RFMOW Client Application does not attach to RFMOW Server Application

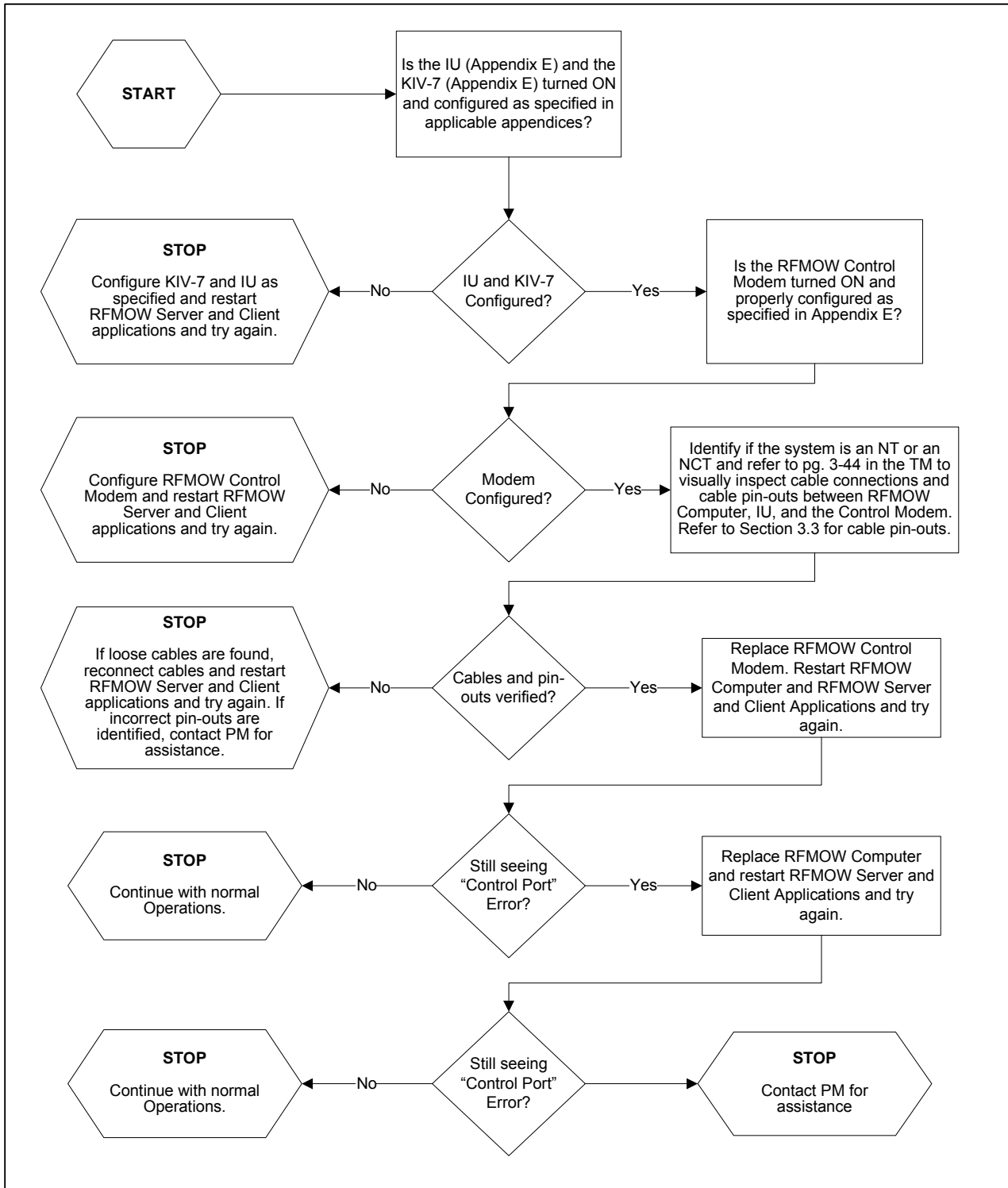

Flowchart A-4 Control Port Error Message

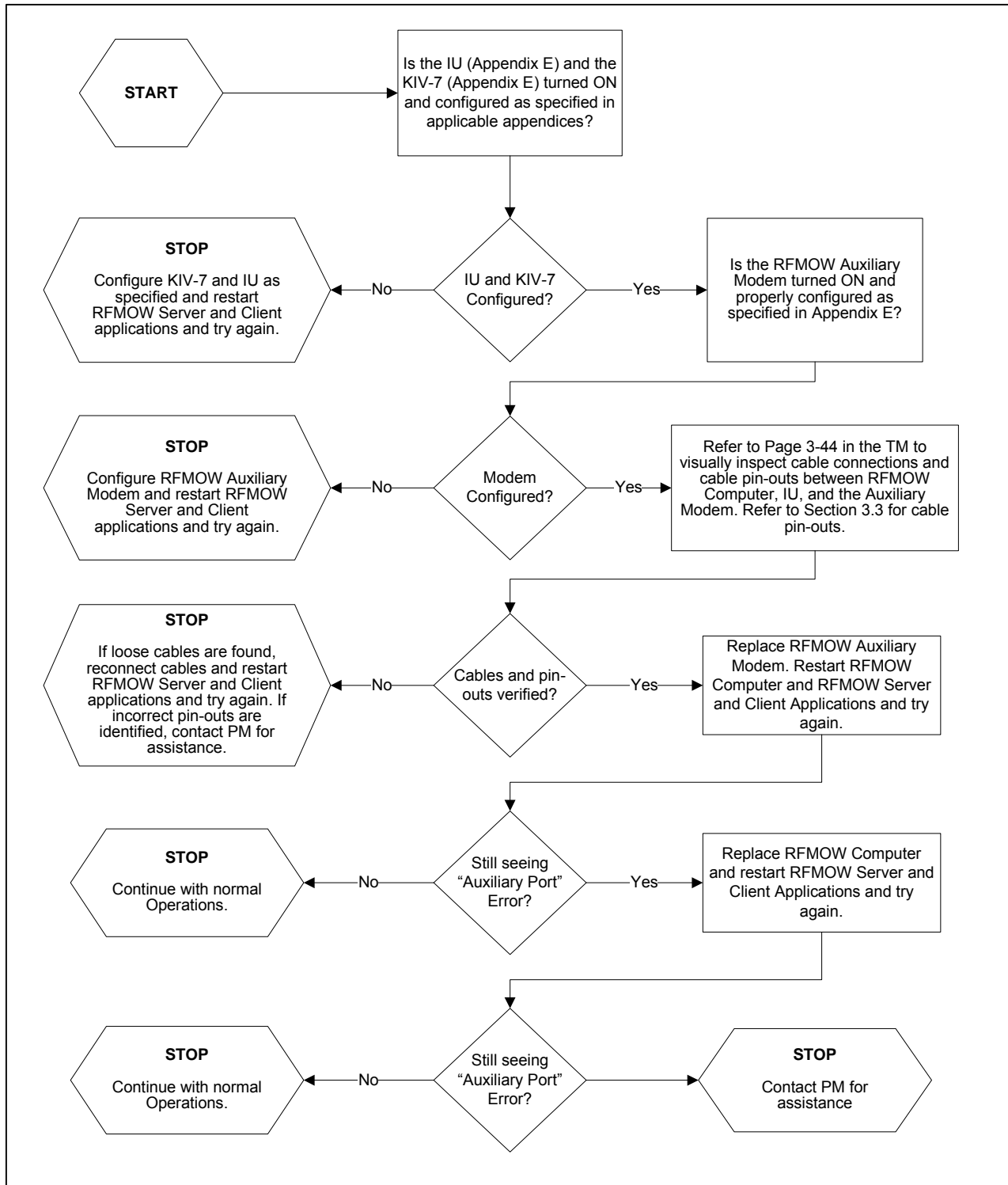

Flowchart A-5 Auxiliary Port Error Message

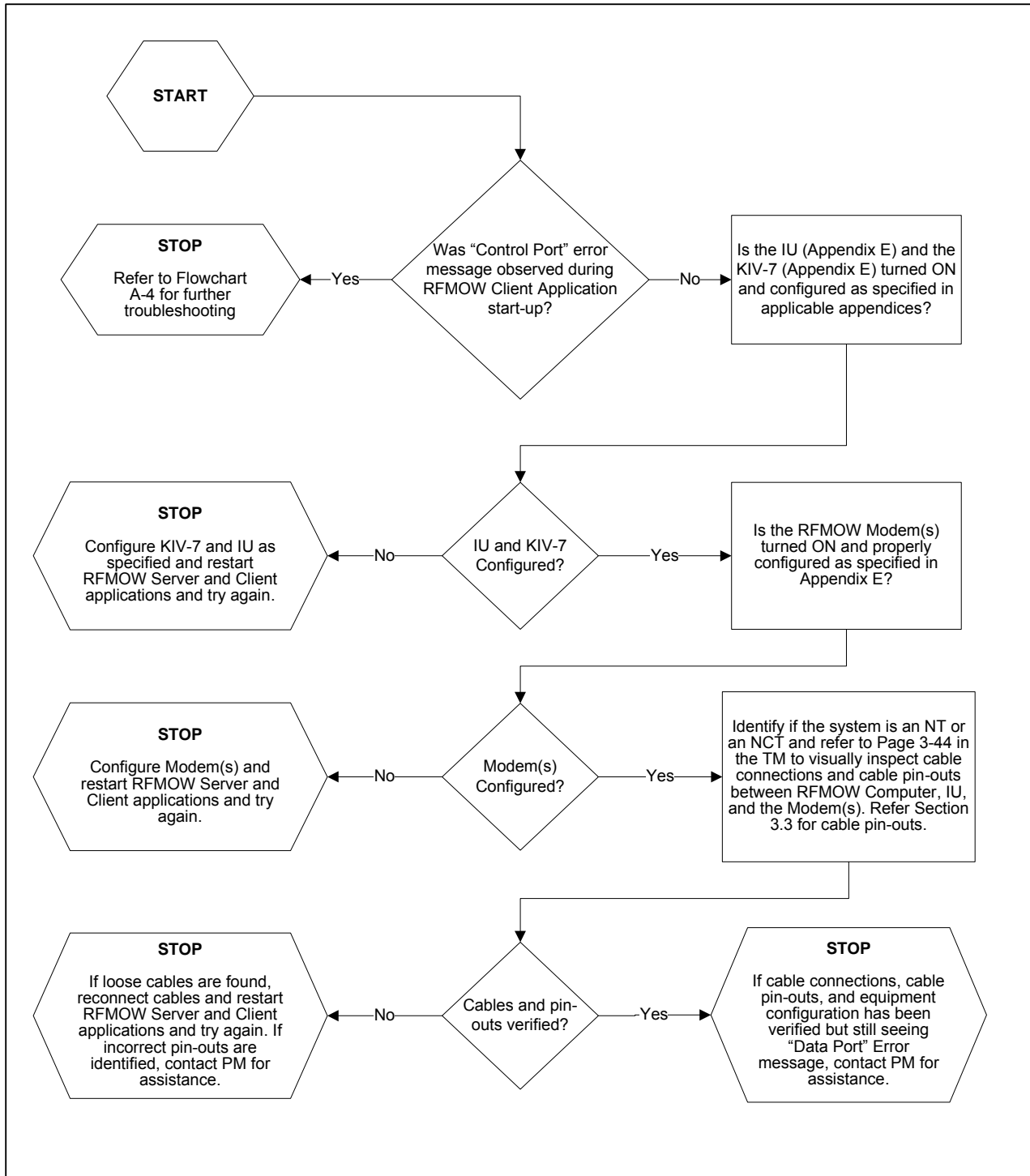

Flowchart A-6 Data Port Error Message

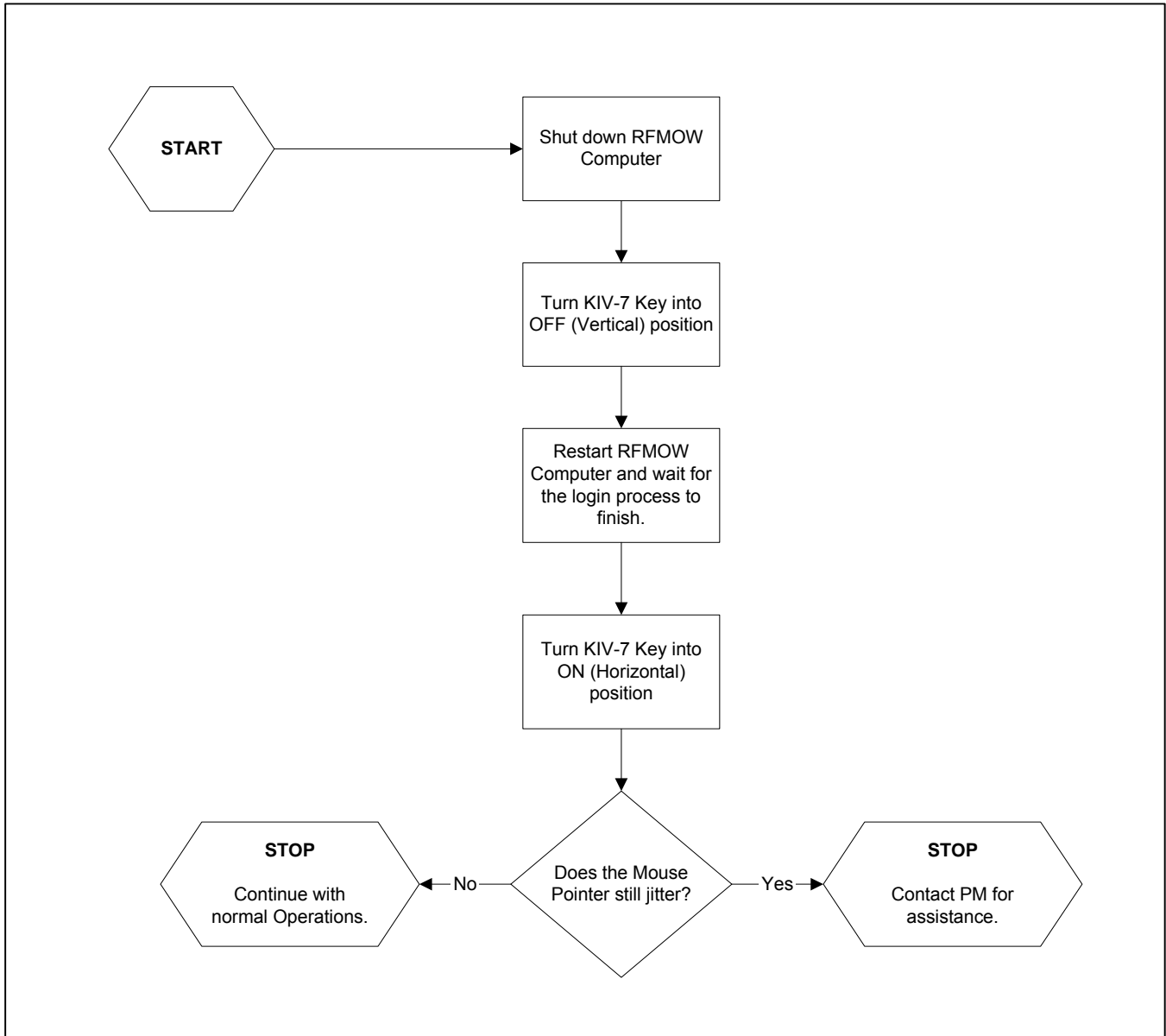

Flowchart A-7 Mouse Pointer Jittering

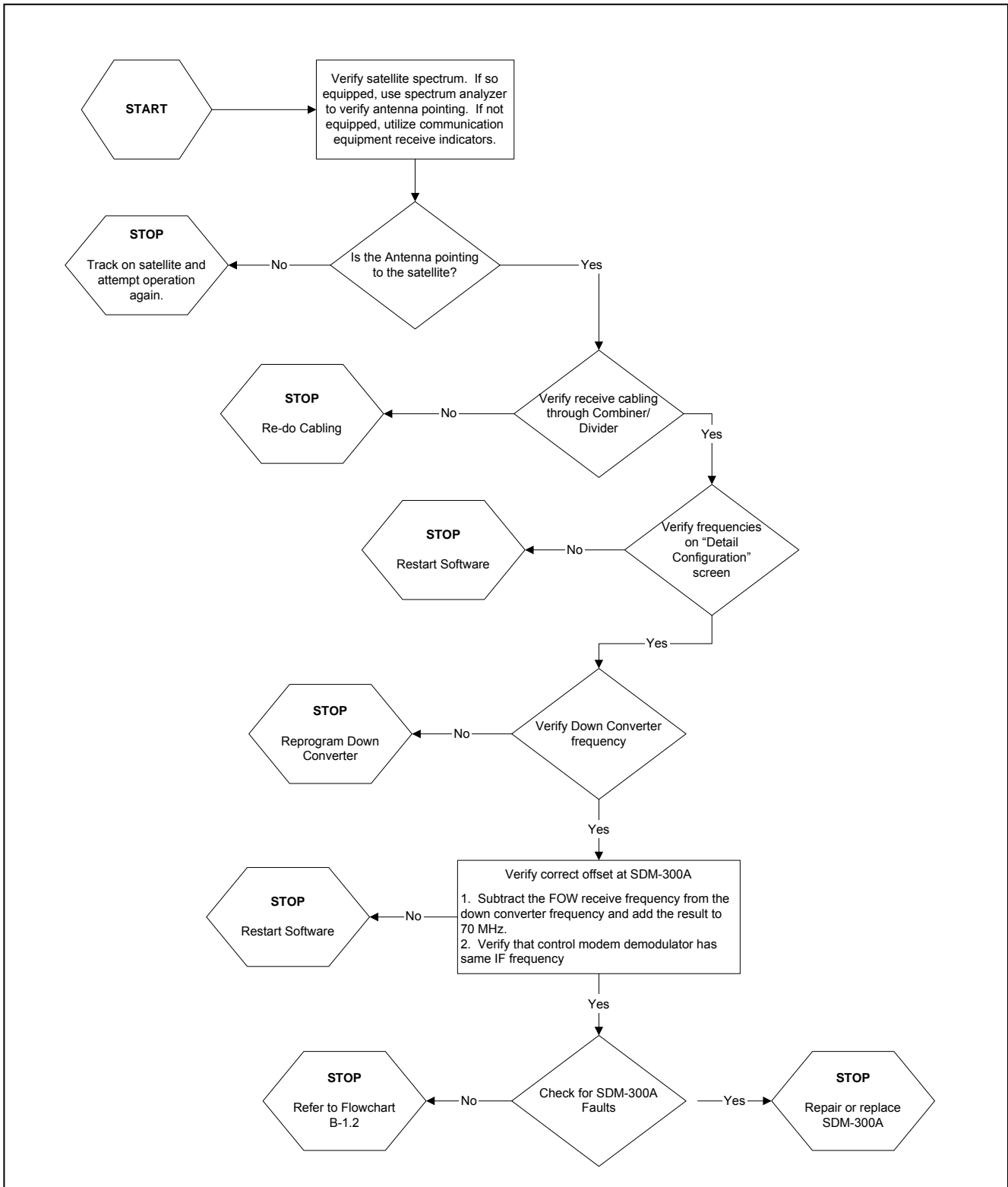

Flowchart B-1.1 FOW on the Satellite: NT no "Carrier Detect"

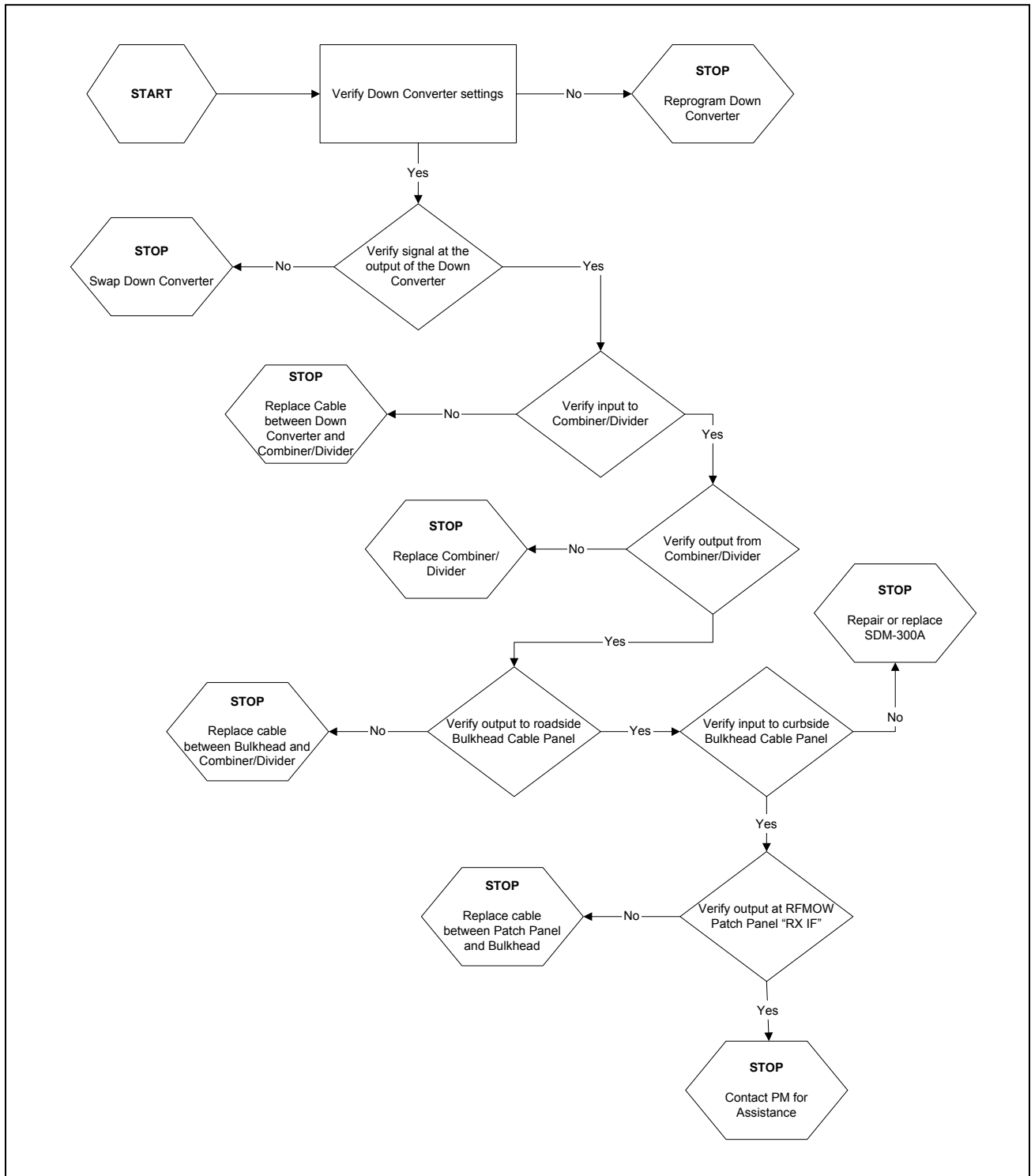

Flowchart B-1.2 FOW on the Satellite: NT no "Carrier Detect"

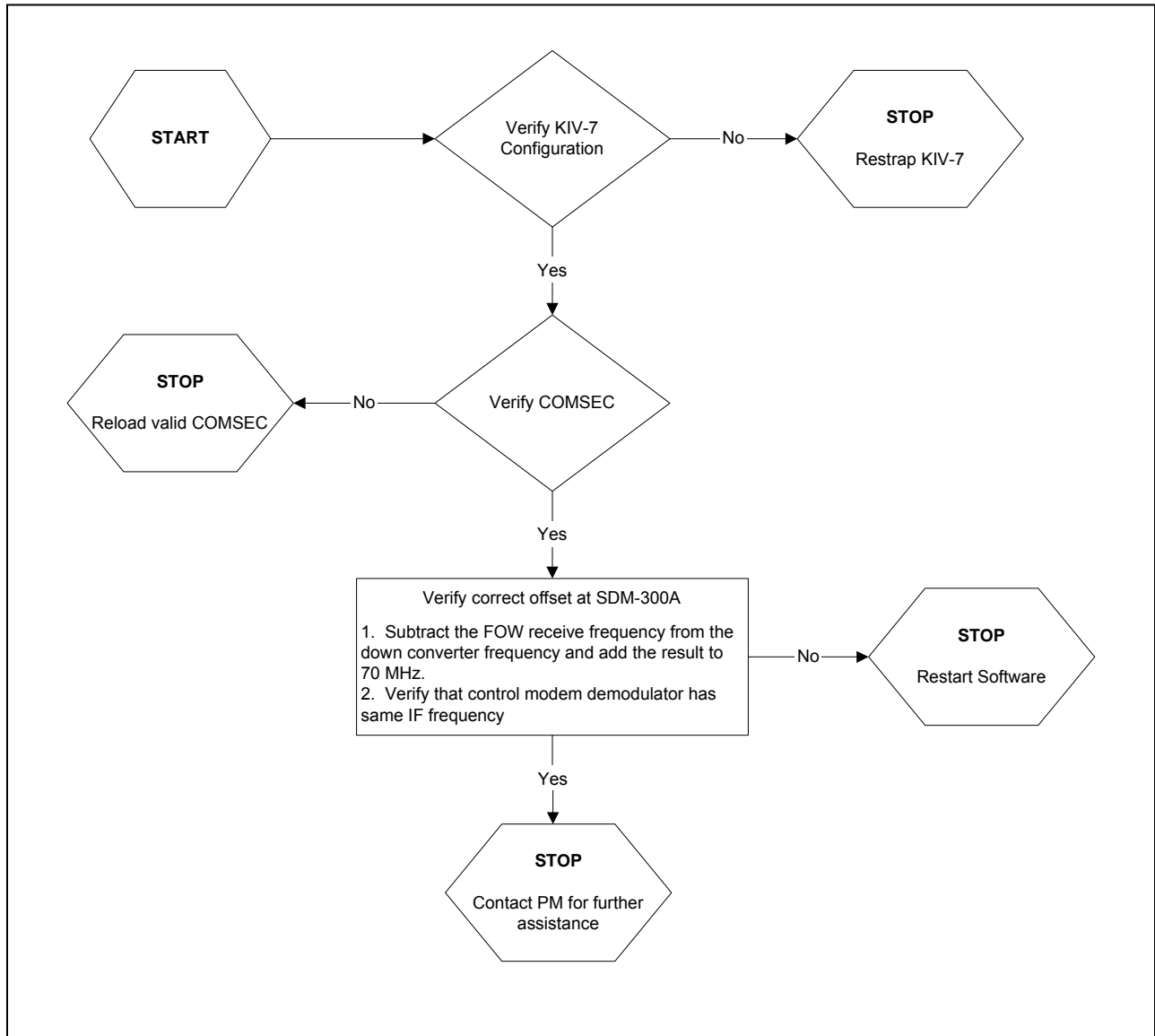

Flowchart B-2 FOW on the Satellite: "Carrier Detect": No Bulletin Board Messages

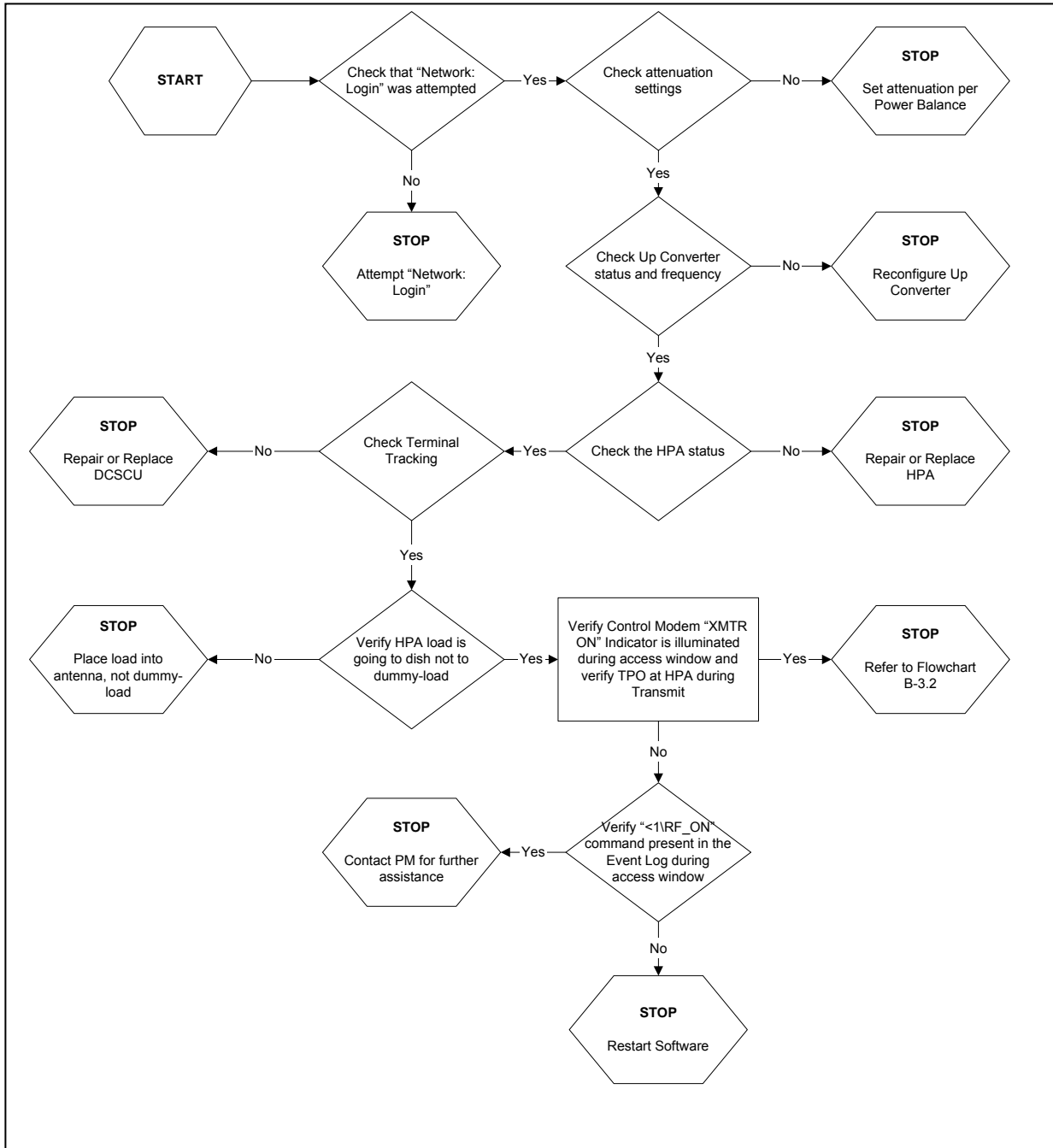

Flowchart B-3.1 ROW not on the Satellite

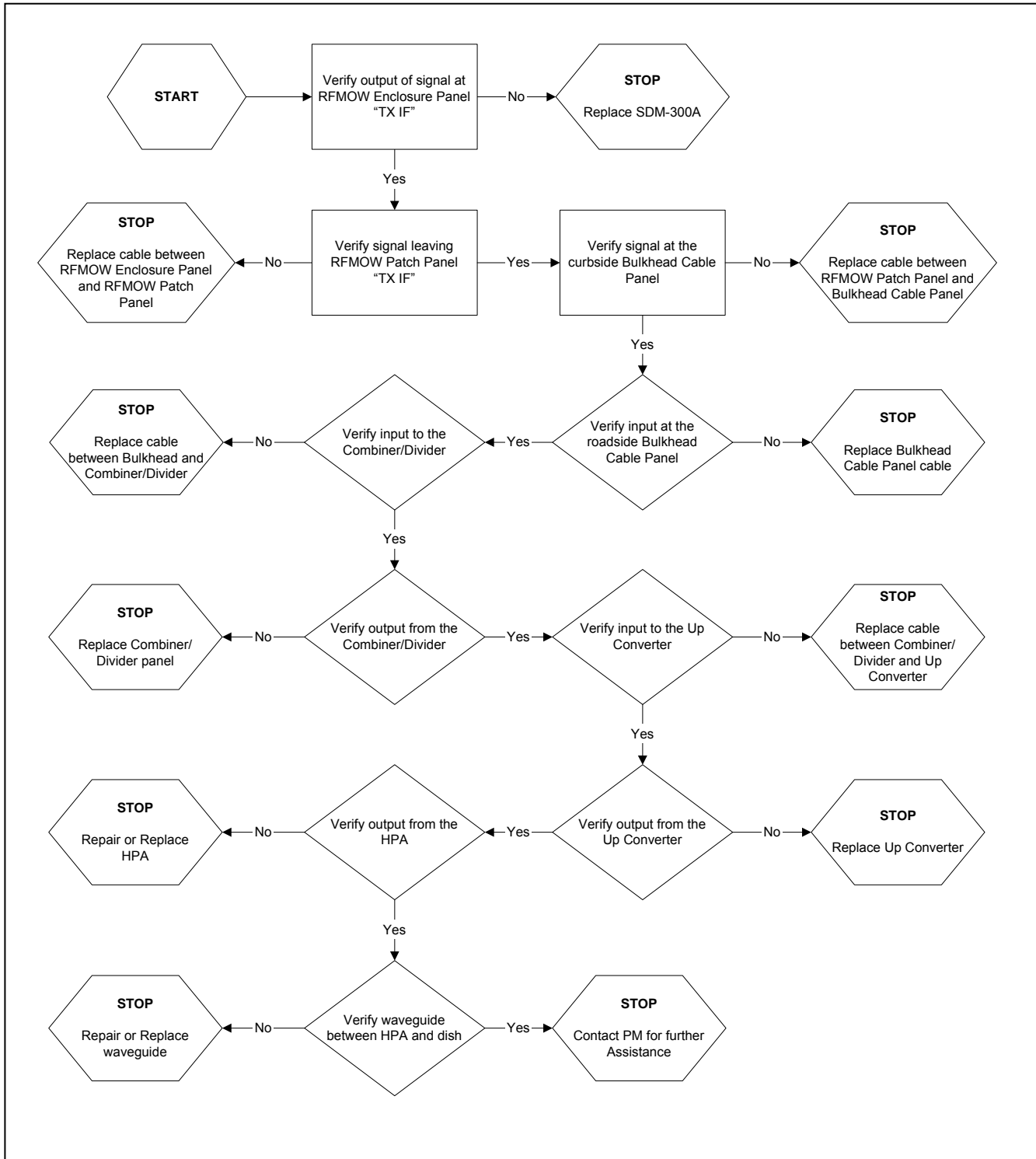

Flowchart B-3.2 ROW not on the Satellite

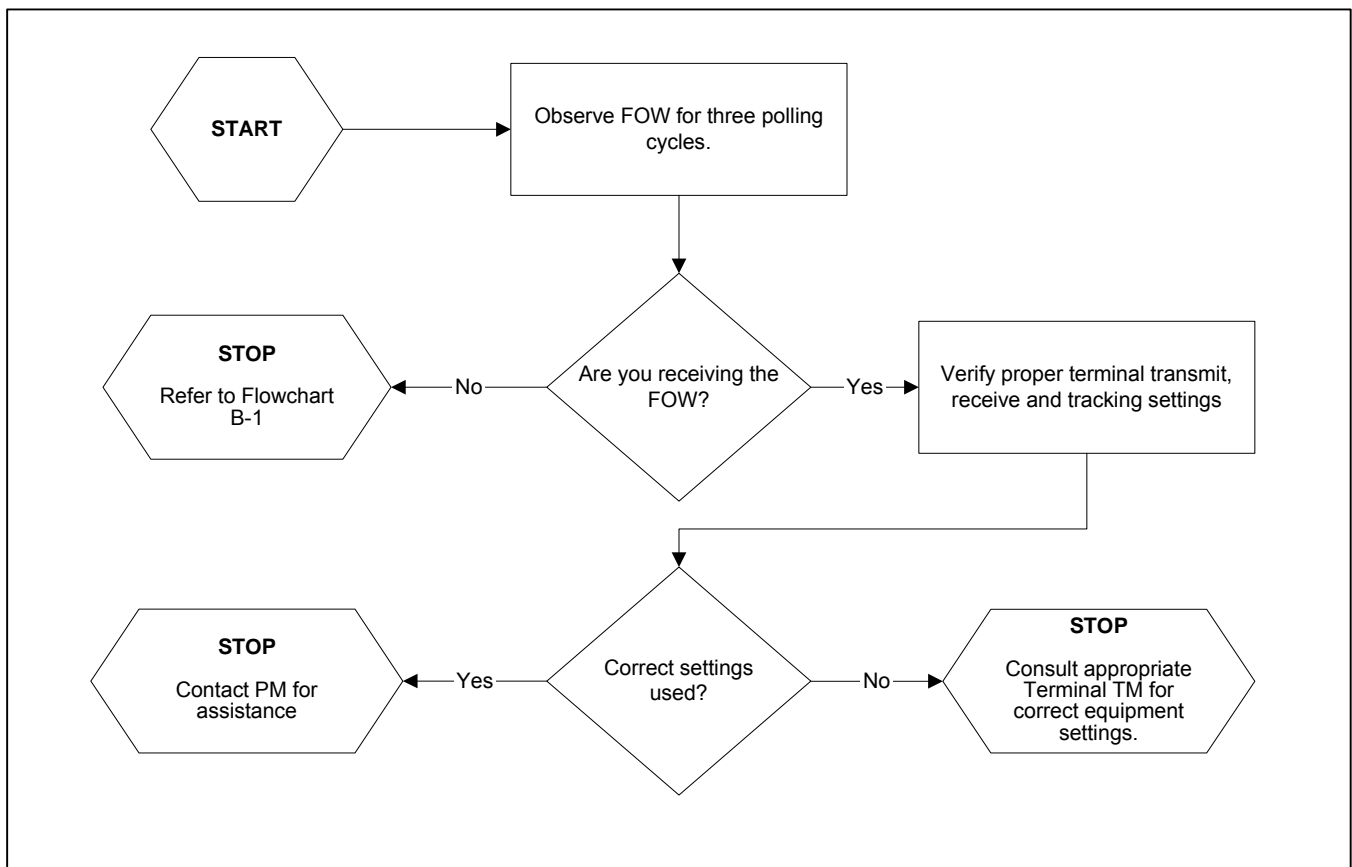

Flowchart C-1 NT has Entered into Disconnect State

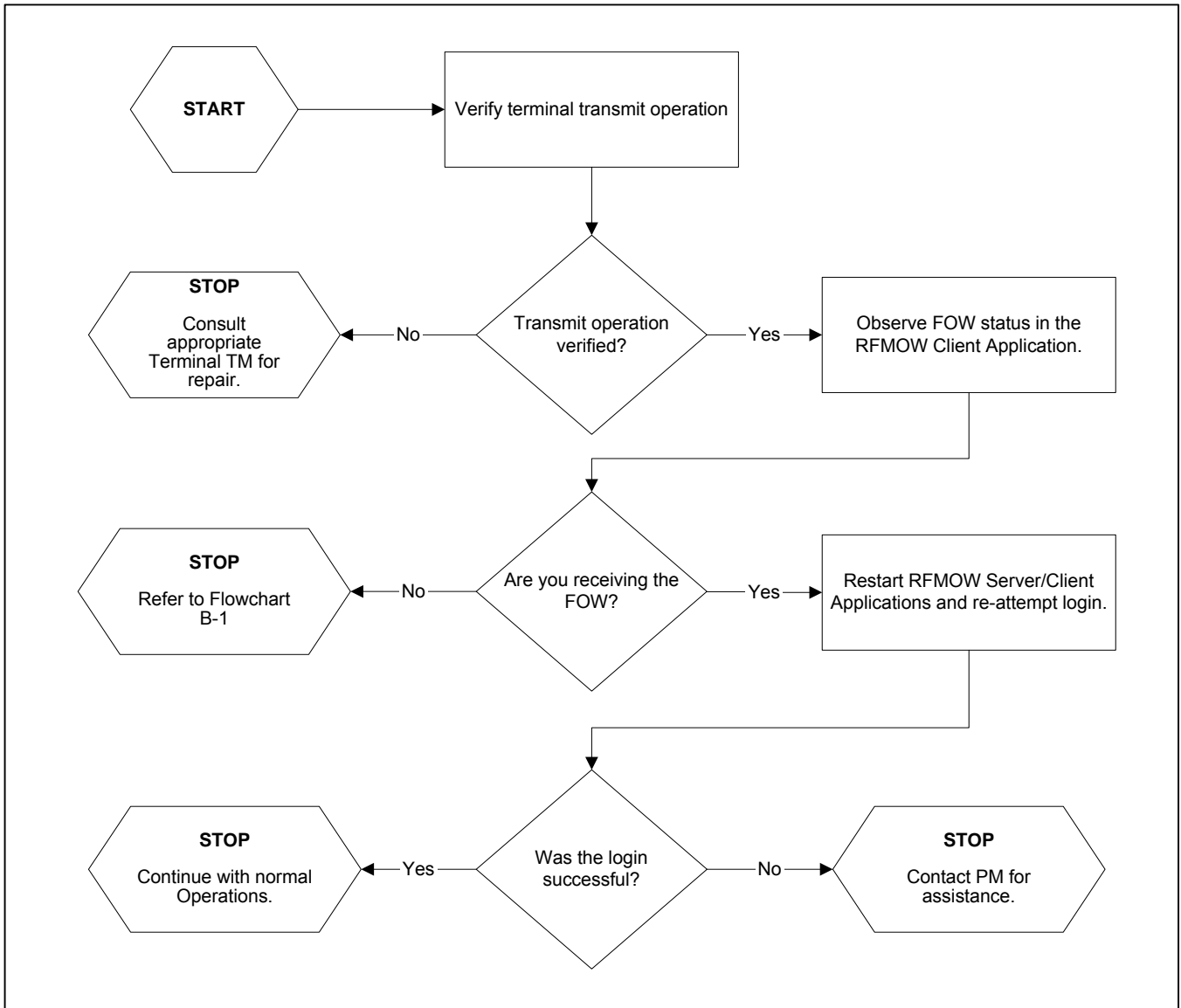

Flowchart C-2 NT is forced out of the Network

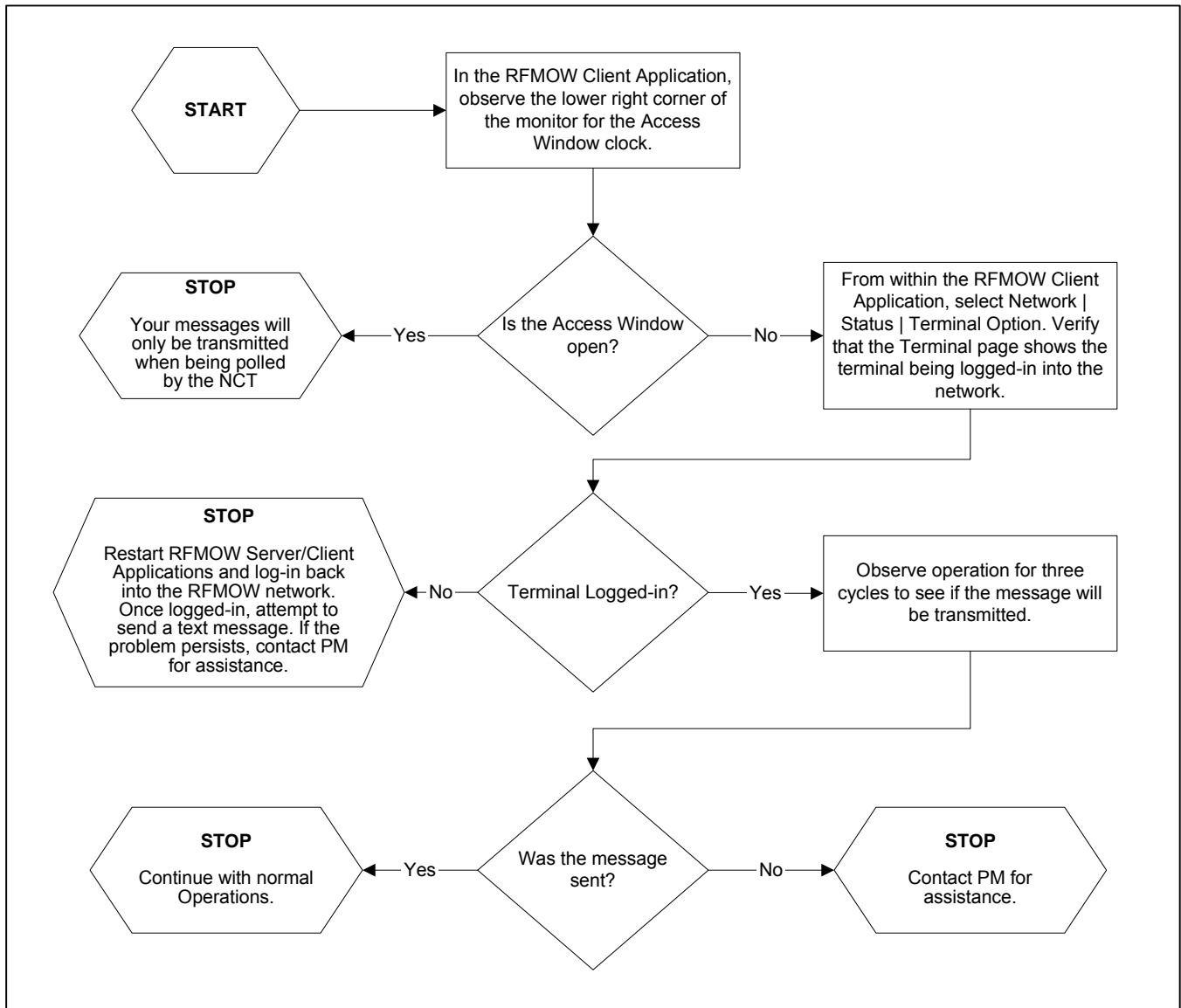

Flowchart D-1 Transmitted Messages to not Appear in the Transmit Window

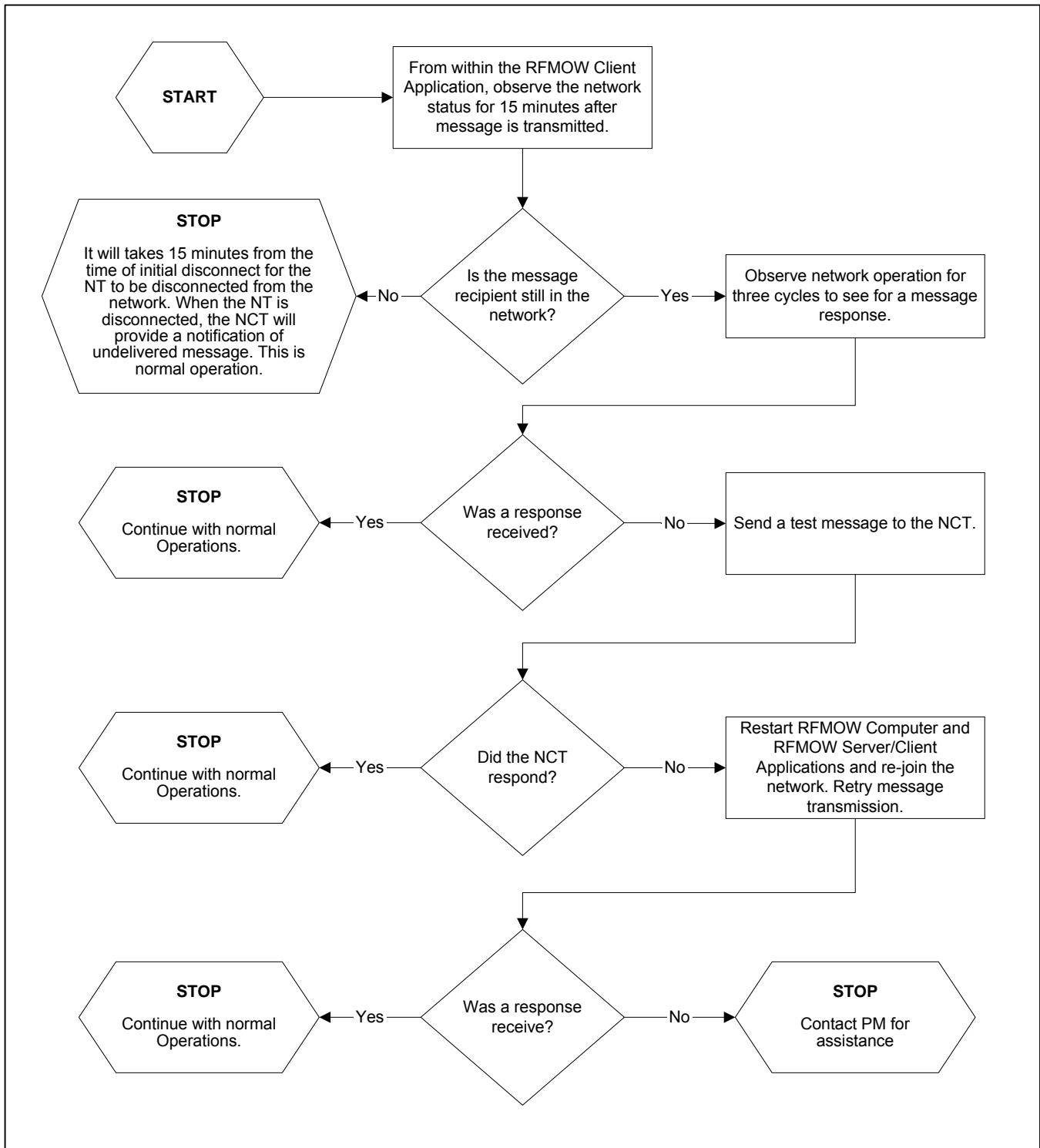

Flowchart D-2 Transmitted Messages Appear in the Transmit Window, but no Response is Received

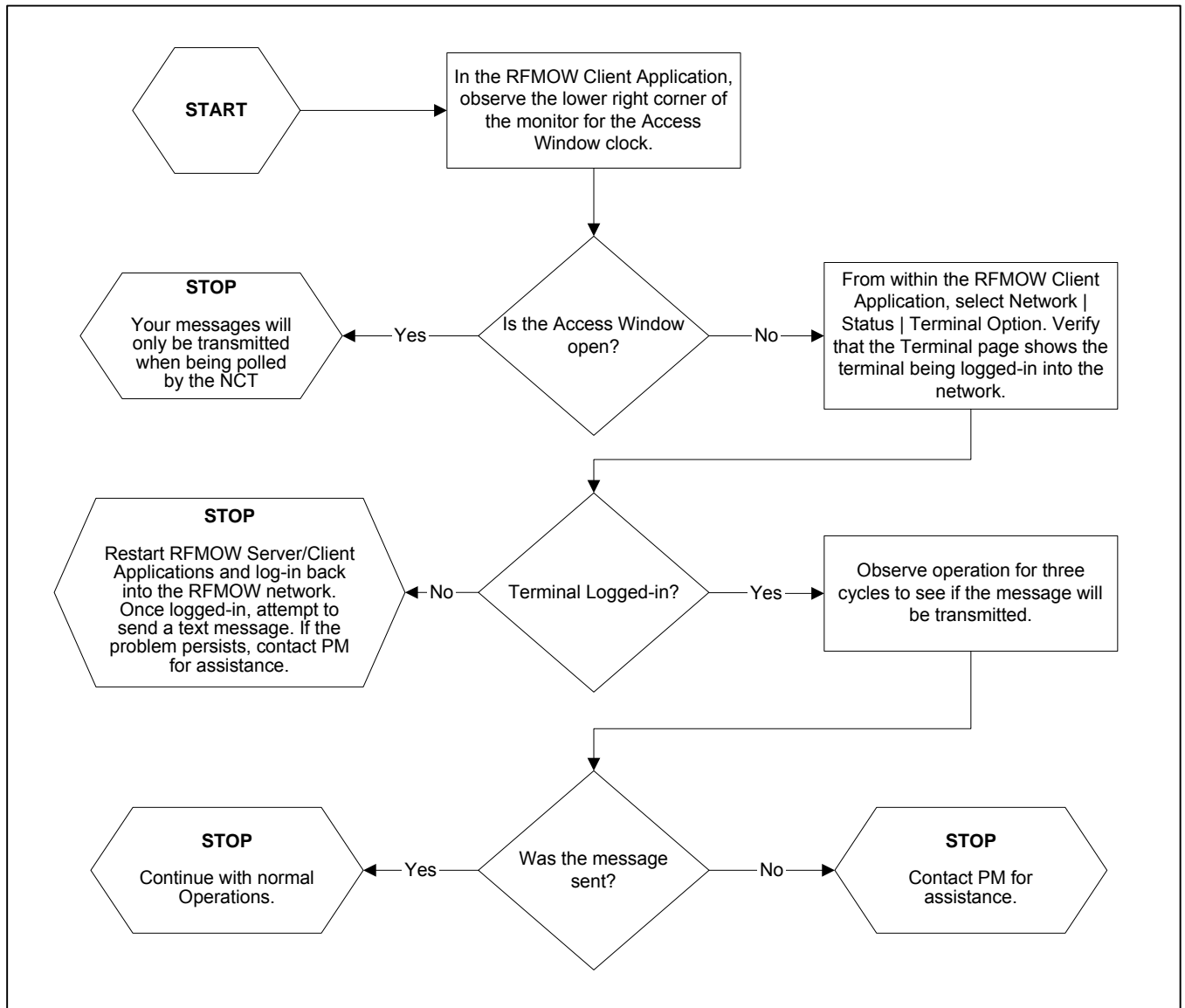

Flowchart E-1 RFMOW Client Application reflects Voice Setup but Secure Voice Phone does not Ring

This page left blank intentionally.

CONNECTOR PIN OUTS

3.3.1 Enclosure Panel

Figure 1-8 illustrates the location of external connectors for the 41700-003 Enclosure Panel. Figure 3-1 and Figure 3-2 illustrate pin outs for these connectors. Connector pin outs are described in Table 3-2 and Table 3-3.

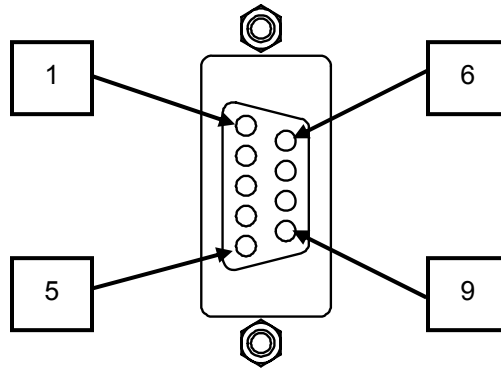

Figure 3-1 RS485 Connector

Pin #	Description
1	Transmit Data B
2	Not Used
3	Not Used
4	Not Used
5	Common
6	Transmit Data A
7	Not Used
8	Receive Data B
9	Receive Data A

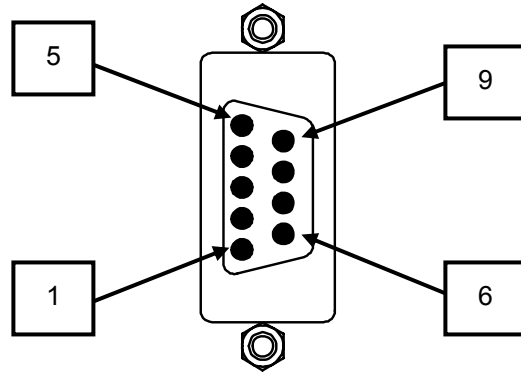

Figure 3-2 RS232 Connector

Pin #	Description
1	Data Carrier Detect (Input)
2	Receive Data (Input)
3	Transmit Data (Input)
4	Data Terminal Ready (Output)
5	Signal Ground
6	Data Set Ready (Input)
7	Request to Send (Output)
8	Clear to Send (Input)
9	Not Used

3.3.2 SDM300A Modem

Figure 1-10 on page 1-12 illustrates the location of external connectors for the SDM300A Modem. Figure 3-3 and Figure 3-4 illustrate pin outs for these connectors. Connector pin outs are described in Table 3-4 and Table 3-5, respectively.

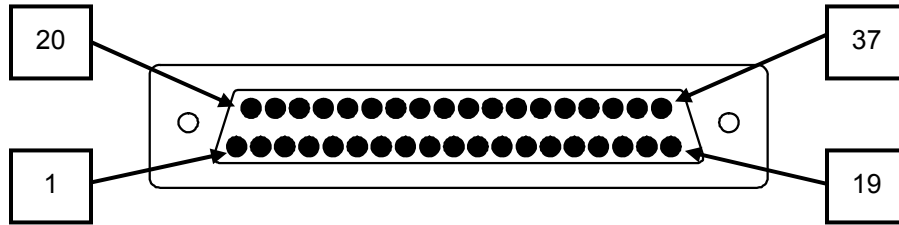

Figure 3-3 37-Pin Connector for SDM-300A Modem

Table 3-4 37-Pin Connector for SDM-300A Modem Pin Out	
Pin #	Description
1, 19	Shield
3	MF
4	SD-A
5	ST-A
6	RD-A
7	RS-A
8	RT-A
9	CS-A
11	DM-A
13	RR-A
16	MC-A
17	TT-A
20, 37	SIGGND
21	DF
22	SD+B
23	ST+B
24	RD+B
25	RS+B
26	RT+B
27	CS+B
29	DM+B
31	RR+B
34	MC+B
35	TT+B

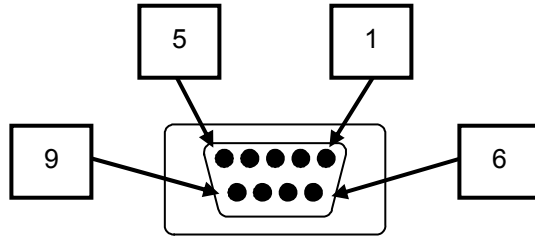

Figure 3-4 Remote Connector (J6) for SDM-300A Modem

Table 3-5 Remote Connector (J6) (EIA-485) Pin Out		
Pin #	2-Wire Description	4-Wire Description
1	GND	Not Used
2	Not Used	Not Used
3	Not Used	Not Used
4*	+RX/TX	+TX
5*	-RX/TX	-TX
6	Not Used	Not Used
7	Not Used	Not Used
8*	+RX/TX	+RX
9*	-RX/TX	-RX

* For 2-Wire Operation:

- Only two wires are required
- Tie pins 4 and 8 together (both +)
- Tie pins 5 and 9 together (both -)

3.3.3 Fan Panel

Figure 1-12 on page 1-14 illustrates the location of external connectors for the 41700-001 Fan Panel. Figure 3-5 illustrates pin outs for this connector. Connector pin outs are described in Table 3-6.

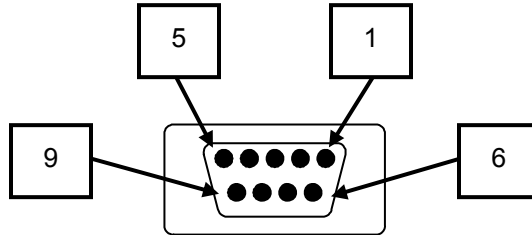

Figure 3-5 Fan Panel Power Connector (J1)

Table 3-6 Fan Panel Power Connector (J1) Pin Out	
Pin #	Description
1	Not Used
2	Not Used
3	Positive Voltage
4	Positive Voltage
5	Not Used
6	Not Used
7	Ground
8	Ground
9	Not Used

3.3.4 Computer

Figure 1-15 on page 1-17 illustrates the location of external connectors for the 41700-005 Computer. Figure 3-6 through Figure 3-11 illustrate pin outs for these connectors. Connector pin outs are described in Table 3-7 through Table 3-11, respectively.

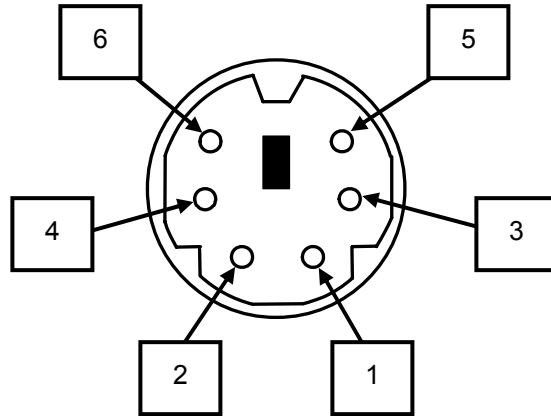

Figure 3-6 PS/2 Mouse and Keyboard Connectors

Table 3-7 PS/2 Mouse and Keyboard Connectors Pin Out		
Pin #	Mouse Description	Keyboard Description
1	Data	Data
2	Not Used	Not Used
3	Ground	Ground
4	+5 V	+5 V
5	Clock	Clock
6	Not Used	Not Used

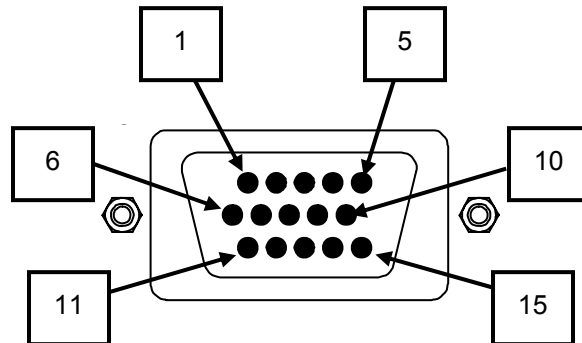

Figure 3-7 VGA Serial Port

Pin #	Description
1	Red
2	Green
3	Blue
4	Not Used
5	Ground
6	Ground
7	Ground
8	Ground
9	Not Used
10	Ground
11	Not Used
12	DDC DAT
13	Horizontal Synchronization
14	Vertical Synchronization
15	DDC Clock

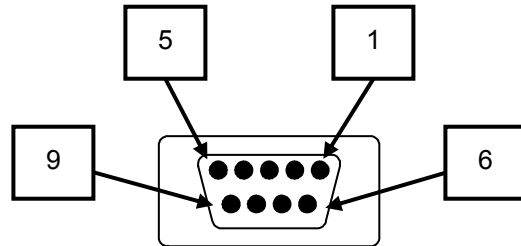

Figure 3-8 COM1 and COM2 Serial Ports

Table 3-9 COM1 and COM2 Serial Ports Pin Out	
Pin #	Description
1	Data Carrier Detect
2	Receive Data
3	Transmit Data
4	Data Terminal Ready
5	Ground
6	Data Set Ready
7	Request to Send
8	Clear to Send
9	Ring Indicator

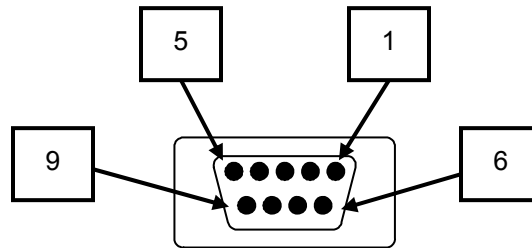

Figure 3-9 COM3 RS485 Port

Pin #	Description
1	Receive Data A (Input)
2	Transmit Data B (Output)
3	Transmit Data A (Output)
4	Not Used
5	Ground
6	Not Used
7	Not Used
8	Not Used
9	Receive Data B (Input)

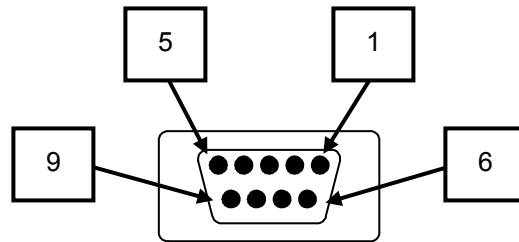

Figure 3-10 COM4 RS232 Port

Pin #	Description
1	Data Carrier Detect (Input)
2	Receive Data (Input)
3	Transmit Data (Input)
4	Data Terminal Ready (Output)
5	Signal Ground
6	Data Set Ready (Input)
7	Request to Send (Output)
8	Clear to Send (Input)
9	Not Used

3.3.5 Keyboard/Monitor/Mouse

Figure 1-20 on page 1-22 illustrates the location of external connectors for the 41700-015 Keyboard/Monitor/Mouse. Figure 3-11 and Figure 3-12 illustrate pin outs for these connectors. Connector pin outs are described in Table 3-12 and Table 3-13, respectively.

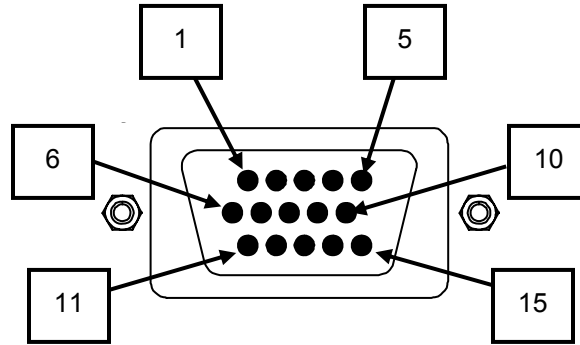

Figure 3-11 VGA Serial Port

Table 3-12 VGA Serial Port Pin Out	
Pin #	Description
1	Red
2	Green
3	Blue
4	Not Used
5	Ground
6	Ground
7	Ground
8	Ground
9	Not Used
10	Ground
11	Not Used
12	DDC DAT
13	Horizontal Synchronization
14	Vertical Synchronization
15	DDC Clock

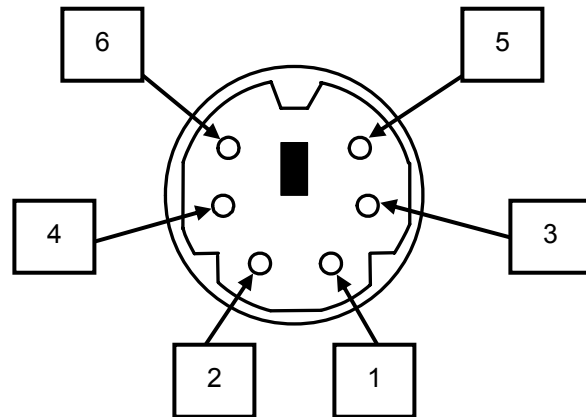

Figure 3-12 PS/2 Mouse and Keyboard Connectors

Table 3-13 PS/2 Mouse and Keyboard Connectors Port Pin Out		
Pin #	Mouse Description	Keyboard Description
1	Data	Data
2	Not Used	Not Used
3	Ground	Ground
4	+ 5V	+ 5V
5	Clock	Clock
6	Not Used	Not Used

3.3.6 Interface Unit

Figures 1-21 and 1-22 on pages 1-23 and 1-24 illustrate the location of external connectors for the 41700-777 Interface Unit. Figure 3-13 through Figure 3-18 illustrate pin outs for these connectors. Connector pin outs are described in Table 3-14 through Table 3-19, respectively.

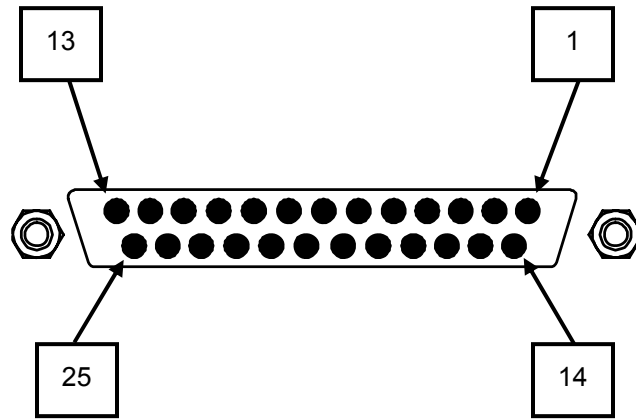

Figure 3-13 STU III/STE Telephone Connector (J1)
(Female 25 pin D-Sub)

Table 3-14 Parallel Port Connector (J1) Pin Out			
Pin #	Description	Pin #	Description
1	Not Used	14	Not Used
2	RS-232 Data From the STE Phone	15	4800 Hz Clock (Transmit Clock)
3	RS-232 Data To the STE Phone	16	Not Used
4	+12 V (Not on STU III)	17	4800 Hz Clock (Receive Clock)
5	+12 V (Not on STU III)	18	Not Used
6	+12 V (Not on STU III)	19	Not Used
7	Ground	20	Not Used
8	+12 V (Not on STU III)	21	Not Used
9	Not Used	22	Not Used
10	Not Used	23	Not Used
11	Not Used	24	Not Used
12	Not Used	25	Not Used
13	Not Used		

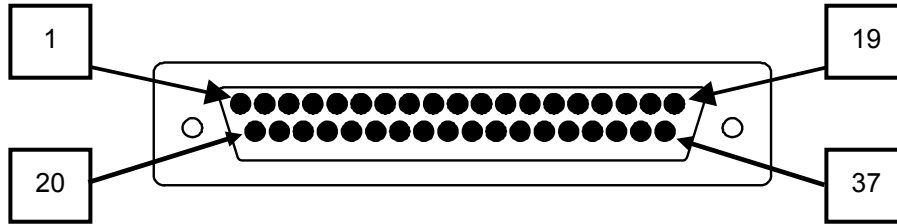

Figure 3-14 Primary and Secondary Modem Data Path Connectors (J2 and J3)
(Male 37 pin D-Sub)

Table 3-15 37-Pin Connector (J2 and J3) Pin Out

Pin #	Description	Pin #	Description
1	Not Used	20	Not Used
2	Not Used	21	Not Used
3	Not Used	22	RS-422 Data + to the Modem
4	RS-422 Data – to the Modem	23	RS-422 Clock + From the Modem (Transmit)
5	RS-422 Clock – From the Modem (Transmit)	24	RS-422 Data + From the Modem
6	RS-422 Data – From the Modem	25	Not Used
7	Not Used	26	RS-422 Clock + From the Modem (Receive)
8	RS-422 Clock – From the Modem (Receive)	27	Not Used
9	Not Used	28	Not Used
10	Not Used	29	Not Used
11	Not Used	30	Not Used
12	Not Used	31	Not Used
13	Not Used	32	Not Used
14	Not Used	33	Not Used
15	Not Used	34	Not Used
16	Not Used	35	Not Used
17	Not Used	36	Not Used
18	Not Used	37	Not Used
19	Not Used		

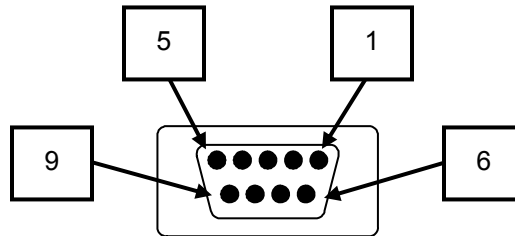

Figure 3-15 PC Control Signals Connector (J4)
(Female 9 pin D-Sub)

Table 3-16 PC Control Signals Connector (J4) Pin Out	
Pin #	Description
1	RS-232 Telephone OFF HOOK Signal Hi = off hook, Low = on hook
2	RS-232 Control Signal to PC Used to confirm controls from the Modem
3	RS-232 Control Signal from the PC Used to control the Modem or other Equip. on Bus
4	RS-232 Control Signal for the "A / B" Switch Hi = voice from the STE, Low = Data from the PC transmitted to and received from the Modem Data Port
5	Not Used
6	Not Used
7	RS-232 Control Signal for the IU Alarm Horn Hi = Horn On, Lo = Horn Off <i>The front panel alarm horn sounds continuously when signal is high.</i>
8	Not Used
9	Not Used

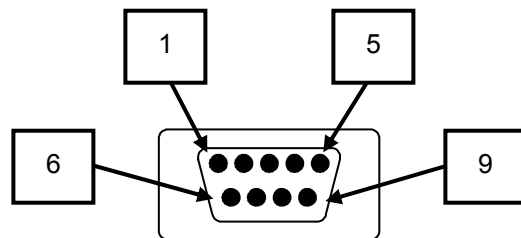

Figure 3-16 Control Signals to the Modem (J5)
 (Male 9 pin D-Sub)

Table 3-17 Control Signals to the Modem (J5) Connector Pin Out	
Pin #	Description
1	Ground
2	Not Used
3	Not Used
4	RS-485 Signal + to the Modem
5	RS-485 Signal - to the Modem
6	Not Used
7	Not Used
8	RS-485 Signal + From the Modem
9	RS-485 Signal - From the Modem

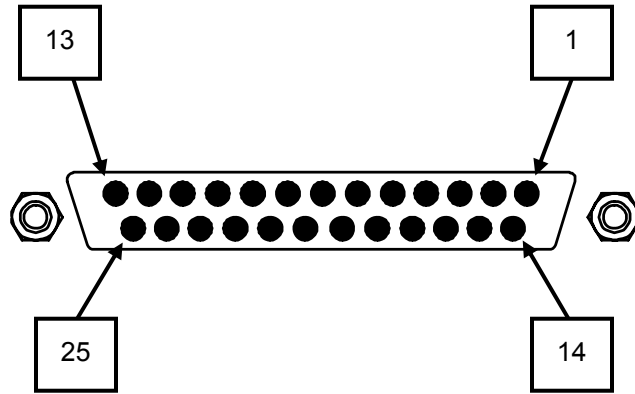

Figure 3-17 Data From/To the PC (J6)
(Female 25 pin D-Sub)

Table 3-18 Data From / To the PC (J6) Connector Pin Out			
Pin #	Description	Pin #	Description
1	Not Used	14	Not Used
2	RS-232 Data From the PC to the COMSEC Device	15	Not Used
3	RS-232 Data To the PC from the COMSEC Device	16	Not Used
4	Not Used	17	Not Used
5	RS-232 Red Alarm Indicator from the COMSEC Device	18	Not Used
6	RS-232 Black Alarm Indicator from the COMSEC Device	19	Not Used
7	Ground	20	RS-232 Sync Command Transmit / Receive to the COMSEC Device
8	Not Used	21	Not Used
9	Not Used	22	Not Used
10	Not Used	23	Not Used
11	Not Used	24	Not Used
12	Not Used	25	Not Used
13	Not Used		

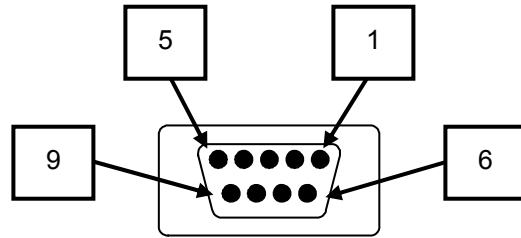
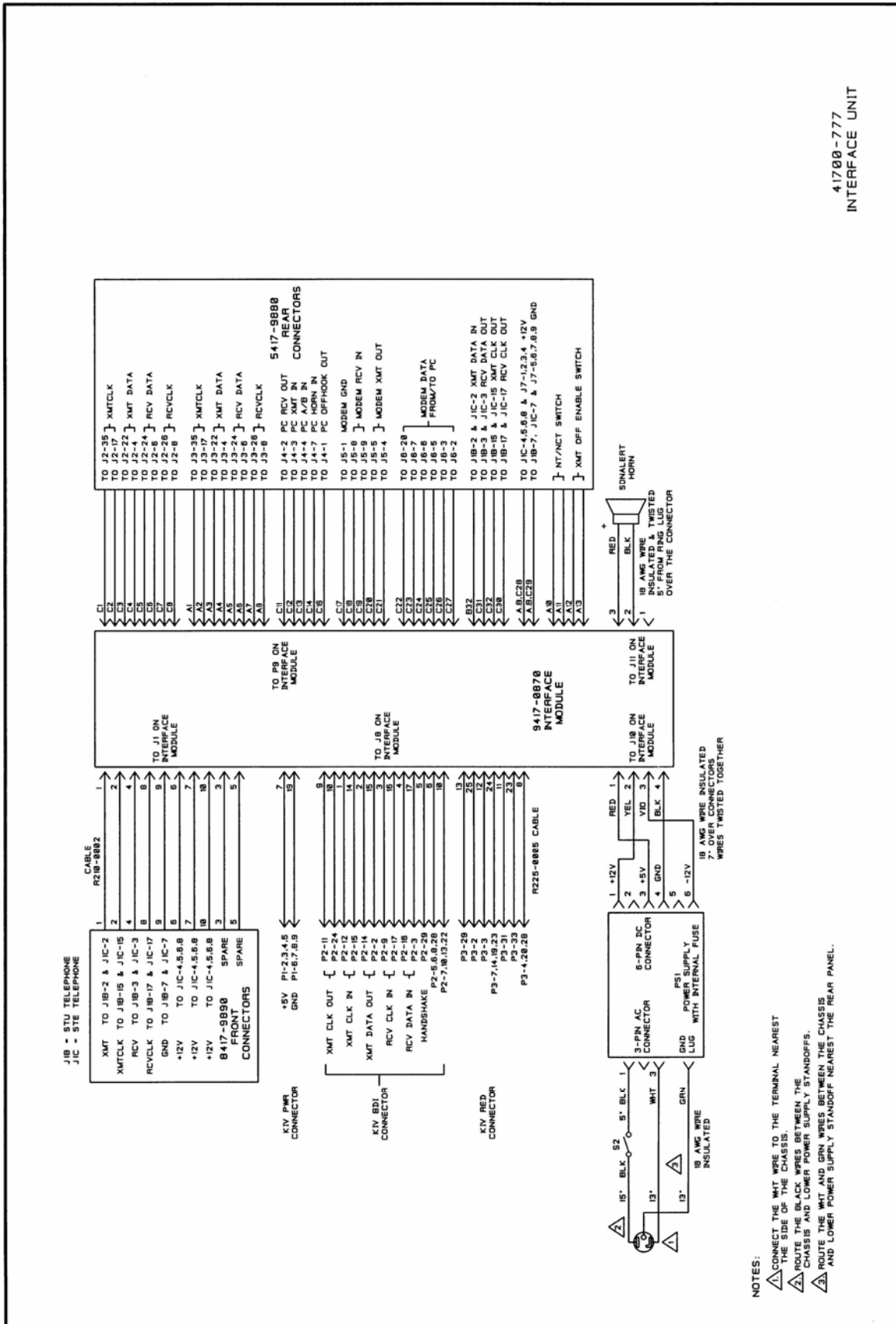

Figure 3-18 Optional Power for External Equipment (If Needed) (J7)
 (Female 9 pin D-Sub)

Table 3-19 Optional Power (J7) Pin Out	
Pin #	Description
1	+12 VDC up to 1 Amp current draw
2	+12 VDC up to 1 Amp current draw
3	+12 VDC up to 1 Amp current draw
4	+12 VDC up to 1 Amp current draw
5	Ground
6	Ground
7	Ground
8	Ground
9	Ground

Schematic Interface Unit 41700-777



41700-777
INTERFACE UNIT

Figure 3-19 Schematic Interface Unit

Wiring Diagram Replace Frequency Modulated Orderwire

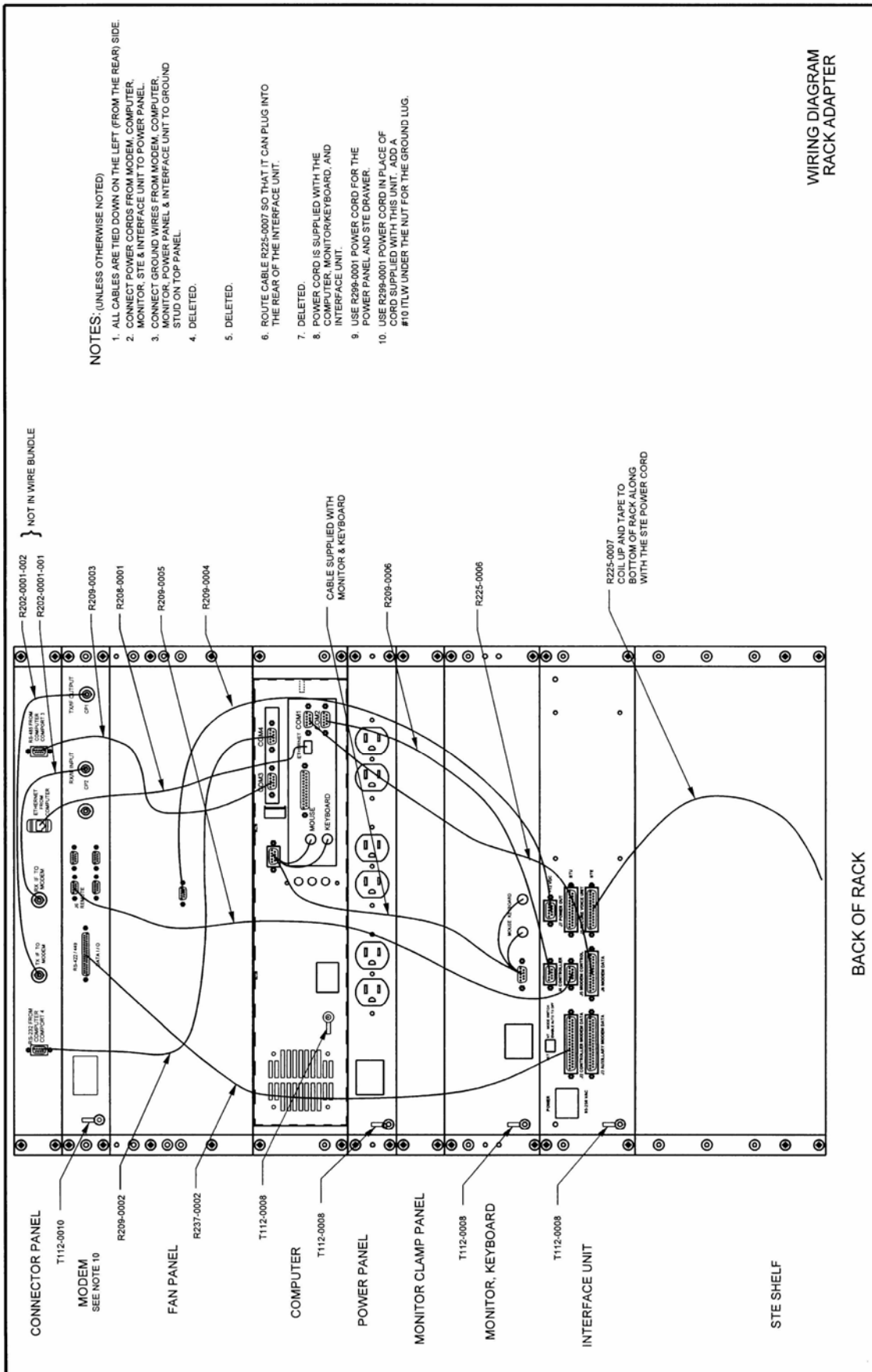

NOTES: (UNLESS OTHERWISE NOTED)

1. ALL CABLES ARE TIED DOWN ON THE LEFT (FROM THE REAR) SIDE.
2. CONNECT POWER CORDS FROM MODEM, COMPUTER, MONITOR, STE & INTERFACE UNIT TO POWER PANEL.
3. CONNECT GROUND WIRES FROM MODEM, COMPUTER, MONITOR, POWER PANEL & INTERFACE UNIT TO GROUND STUD ON TOP PANEL.
4. DELETED.
5. DELETED.
6. ROUTE CABLE R225-0007 SO THAT IT CAN PLUG INTO THE REAR OF THE INTERFACE UNIT.
7. DELETED.
8. POWER CORD IS SUPPLIED WITH THE COMPUTER, MONITOR/KEYBOARD, AND INTERFACE UNIT.
9. USE R299-0001 POWER CORD FOR THE POWER PANEL AND STE DRAWER.
10. USE R299-0001 POWER CORD IN PLACE OF CORD SUPPLIED WITH THIS UNIT. ADD A #10 TLW UNDER THE NUT FOR THE GROUND LUG.

Figure 3-20 RFMOW Wiring Diagram

CHAPTER 4

MAINTENANCE AND INFORMATION

4.1 INTRODUCTION

This chapter provides the following maintenance information for the RFMOW:

- Maintenance Concept
- Preventative Maintenance
- Removal and Replacement

4.2 MAINTENANCE CONCEPT

The goal of the RFMOW maintenance is to prevent equipment failures by performing preventive maintenance. When failures occur, the objective of corrective maintenance is to verify the failure and replace the faulty RFMOW part in the shortest possible time with the least impact on the mission.

4.3 PREVENTIVE MAINTENANCE

Preventive maintenance includes recommended maintenance tasks required to prevent future equipment breakdown such as chassis cleaning and inspection. The following paragraphs describe the preventative maintenance for the RFMOW.

WARNING

Ensure that power is removed during the performance of equipment replacement and cleaning procedures. Do not open equipment enclosures when cleaning. Use of damp cleaning materials can cause shock, resulting in fatal or serious injury to personnel.

4.3.1 Tools Required

The tools required to perform Maintenance Tasks are described in Table 4-1 below.

Table 4-1 Tools Required Index	
INDEX	CONTENT
A	Dry Cloth, Pressured Air Spray (NON-LIQUID)
B	#2 Cross-Tip Screwdriver, Canned Air (NON-LIQUID), Clean, Dry Towel, Small Brush (Optional)
C	Synthesized Sweep Generator, Scalar Network Analyzer, Dell Laptop, Power Meter, Printer, Harris Sweep Software Application (Standard Converter Sweep Cart)
D	Spectrum Analyzer (GHz)
E	Signal Generator, Spectrum Analyzer, Power Meter

4.3.2 Maintenance Tasks

The Maintenance Tasks required to be performed are provided in Table 4-2. For Frequencies, B=Before, D=During, A=After, W=Weekly, and Q=Quarterly

Table 4-2 Maintenance Tasks								
Item No.	Interval					Tools Required	Items to be Inspected	Procedures
	B	D	A	W	Q			
1				•		A	PC-Wipe down screen / keyboard	1. The monitor screen and keyboard for each RFMOW client and RFMOW server resident system shall be wiped down using a cloth and canned air.
2				•		B	Dust	1. Remove intake filters on the fan panel and computer. 2. Rinse filters in warm water and let dry. 3. When the filters are dry, reinstall them. 4. Open the keyboard drawer. 5. Clean the keyboard with canned air. 6. Slide the keyboard into rack. 7. Slide out the monitor and lift the monitor open. 8. Wipe the dust off the monitor with a clean towel. 9. If necessary, please use a small brush to dislodge impacted dust from corners and other hard-to-reach areas. 10. Wipe down entire RFMOW with a clean towel.
3				•		N/A	Cable Inspection	1. All cables exposed to external elements or cables exposed to high personnel trafficked areas such as shelter walkways shall be visually inspected for wear and tear.
4					•	C	Uplink Calibration	1. Terminal gains and losses shall be measured as defined in the respective terminal maintenance procedures to ensure proper operation. 2. Any and all alignments required to place the terminal into proper mission operation shall be performed. 3. Once performed, the RFMOW alignment system gain values shall be entered into the appropriate field of the system gains page screen. (C-3 for 85/93)
5					•	N/A	Access Alignment Verification	1. The terminal operator shall start the RFMOW alignment software and select the alignment based on terminal type. 2. The operator shall click 'Initiate Alignment' and attempt to access RFMOW subnet. 3. Once accessed, the operator shall send a message to the NCT requesting a 'COMM CHECK'. 4. Once a message response is received from the NCT, the operator shall request logout from NCT and upon approval, orderly log out of the RFMOW network. <i>Note: This task should be done Quarterly and additionally anytime Task No. 4 is performed.</i>
6					•	N/A	Software Maintenance	1. Log files older than 10 days and having no significance shall be deleted from the system to avoid exceeding hard drive usage constraints. 2. The Log File Zip Utility Software is available on the RFMOW website. 3. The website for the RFMOW is https://rdit.army.mil/commssc <i>Note: Hard drive total capacity may vary the frequency of this maintenance.</i>

4.3.3 Exterior Hardware Inspection

Perform the following exterior hardware inspection on a regular basis:

- a. Check exterior of RFMOW for loose screws, knobs, toggle switches, etc.
- b. Tighten any hardware that may have become loose.

4.4 GENERAL REMOVAL AND REPLACEMENT PROCEDURES

This section describes removal and replacement procedures for the RFMOW.

WARNING

Proper grounding is an important safety feature, and must be a primary consideration in all electrical and electronic equipment installations. Ensure that all grounding connections are secure and that all grounding cables are kept out of vehicle and personnel paths.

WARNING

Use extreme care when working around electrical equipment to avoid the possibility of severe or fatal electrical shock. Remove all jewelry (i.e. rings, necklaces, etc.) before working with the RFMOW.

WARNING

Ensure that all power connections are properly insulated, clean, and mechanically secure to prevent personnel injury when the RFMOW is powered up and operated. When the RFMOW power cables are installed, carefully inspect all connectors and wiring for worn or broken parts. Make any necessary repairs before powering up the RFMOW. If any cable or connector damage is discovered while the RFMOW is operating, the RFMOW should be powered down and the damage repaired immediately.

WARNING

Even with covers removed, lethal voltages may still be present inside the RFMOW. Failure to exercise caution could result in fatal or serious injury to personnel.

WARNING

High voltage, 120 VAC, is present in this equipment. Use extreme caution and ensure that at least two people are present while performing inspection, test, and maintenance procedures. Failure to comply may result in fatal or serious injury to personnel.

WARNING

Ensure that power is removed during the performance of equipment replacement and cleaning procedures. Do not open equipment enclosures when cleaning. Use of damp cleaning materials can cause shock, resulting in fatal or serious injury to personnel.

WARNING

Hazardous voltages are present. Use care when measuring for voltage. Failure to do so can result in fatal or serious injury to personnel.

WARNING

RFMOW weight in the crate is approximately 180 lbs. (81.65 kg). A forklift or equivalent is required to move the crate. Individual weights of items in the crate are listed in section 1.15.1 (not including shipping materials). Two persons are required to install the RFMOW Rack, which is approximately 74 lbs. (33.57 kg). Failure to comply may result in fatal or serious injury to personnel, and/or damage to the equipment.

CAUTION

This equipment contains static-sensitive devices. Always follow ESD handling procedures when working on this equipment.

4.4.1 Installation of the RFMOW

WARNING

Remove any power from host system prior to installing the RFMOW. Failure to do so may result in severe or fatal electrical shock and/or damage to the equipment.

WARNING

RFMOW weight in the crate is approximately 180 lbs. (81.65 kg). A forklift or equivalent is required to move the crate. Individual weights of items in the crate are listed in section 1.15.1 (not including shipping materials). Two persons are required to install the RFMOW Rack, which is approximately 74 lbs. (33.57 kg). Failure to comply may result in fatal or serious injury to personnel, and/or damage to the equipment.

Tools Needed:

- 3/8" Nut Driver
 - 5/8" Nut Driver
 - 11/32" Nut Driver
 - 1/8" Flat-Tip Screwdriver
 - #2 Phillips Screwdriver
- a. Locate the RFMOW rack assembly position in the front of the host rack.
 - b. Attach the AC Power Cable and the Grounding Cable to the rack assembly (located on top of the RFMOW) (see Figure 1-7 on page 1-9).
 - c. Place the RFMOW rack assembly into position in the host rack.
 - d. Place 10/32 x 1 inch flat-head screws in the mounting holes that will be used and tighten to the host rack.
 - e. Install the SDM-300A Modem into the RFMOW rack assembly (see Figure 1-10 on page 1-12).
 1. Attach the Grounding Cable to the Grounding Stud on rear panel (Item 1) and tighten with a 3/8" nut driver.
 2. Plug the AC Power Cable into the AC Power Input Connector on the rear panel (Item 2).
 3. Attach the Data I/O Cable to the Data I/O Connector on the rear panel (Item 3) and tighten with a 1/8" Flat-Tip screwdriver.
 4. Attach the Remote Cable to J6 on the rear panel (Item 4) and tighten with a 1/8" Flat-Tip screwdriver.
 5. Attach the TX/IF Output Cable to the CP1 BNC Connector on the rear panel (Item 8).
 6. Attach the RX/IF Input Cable to the CP2 BNC Connector on the rear panel (Item 9).
 7. Place the Modem into the rack assembly.
 8. Place 10/32 x 5/16 inch screws in the four mounting holes and tighten to the host rack using a #2 Phillips screwdriver.
 - f. Install the Fan Panel into the RFMOW rack assembly (see Figure 1-12 on page 1-14).
 1. Attach the Power Connector to the back of the fan panel assembly and tighten with a 1/8" Flat-Tip screwdriver.
 2. Place the Fan Panel into the rack assembly.
 3. Place 10/32 x 5/16 inch screws in the four mounting holes and tighten to the host rack using a #2 Phillips screwdriver.
 - g. Install the Computer into the RFMOW rack assembly (see Figure 1-15 on page 1-17).
 1. Attach the Grounding Cable to the Grounding Stud on the rear panel (Item 2) and tighten with a 5/16" nut driver.
 2. Plug the Power Connector into the AC Power Input Connector on the rear panel (Item 4).
 3. Position the Power Connector Retainer over the AC Power Connector on the rear panel (Item 3) and tighten the screw in the Power Connector Bracket with a #2 Phillips screwdriver.
 4. Attach the VGA Monitor Cable to the Connector on the rear panel (Item 8) and tighten with a 1/8" Flat-Tip screwdriver.
 5. Plug the Keyboard Cable into the Connector on the rear panel (Item 12).
 6. Plug the Mouse Cable into the Connector on the rear panel (Item 11).
 7. Attach the Computer Com 3 Cable to the Com 3 Connector on the rear panel (Item 9) and tighten with a 1/8" Flat-Tip screwdriver.
 8. Attach the Computer Com 4 Cable to the Com 4 Connector on the rear panel (Item 10) and tighten with a 1/8" Flat-Tip screwdriver.
 9. Attach the Computer Com 2 Cable to the Com 2 Connector on the rear panel (Item 17) and tighten with a 1/8" Flat-Tip screwdriver.
 10. Attach the Computer Com 1 Cable to the Com 1 Connector on the rear panel (Item 16) and tighten with a 1/8" Flat-Tip screwdriver.
 11. Plug the Ethernet Cable into the Ethernet Port on the rear panel (Item 14).
 12. Place the Computer into the rack assembly.
 13. Place 10/32 x 5/16 inch screws in the four mounting holes and tighten to the host rack using a #2 Phillips screwdriver.
 - h. Install the KVM (Keyboard/Video/Monitor) into the RFMOW rack assembly (see Figure 1-20 on page 1-22).

1. Attach the Grounding Cable to the Grounding Stud on the rear panel (Item 1) and tighten with a 11/32" nut driver.
 2. Plug the Power Connector into the AC Power Input Connector on the rear panel (Item 2).
 3. Attach the VGA Monitor Cable to the Connector on the rear panel (Item 3) and hand tighten the thumbscrews
 4. Plug the Keyboard Cable into the Connector on the rear panel (Item 4).
 5. Plug the Mouse Cable into the Connector on the rear panel (Item 5).
 6. Place the KVM into the rack assembly.
 7. Place 10/32 x 5/16 inch screws in the four mounting holes and tighten to the host rack using a #2 Phillips screwdriver.
- i. Install the IU (Interface Unit) into the RFMOW rack assembly (see Figure 1-22 on page 1-24).
1. Attach the Grounding Cable to the Grounding Stud on the rear panel (Item 2) and tighten with a 5/16" nut driver.
 2. Plug the Power Connector into the AC Power Input Connector on the rear panel (Item 1).
 3. Attach the Controller Modem Data Cable to J2 on the rear panel (Item 4) and tighten with a 1/8" Flat-Tip screwdriver.
 4. Attach the Modem Data Cable to J6 on the rear panel (Item 8) and tighten with a 1/8" Flat-Tip screwdriver.
 5. Attach the Modem Control Cable to J5 on the rear panel (Item 7) and tighten with a 1/8" Flat-Tip screwdriver.
 6. Attach the Controller Cable to J4 on the rear panel (Item 6) and tighten with a 1/8" Flat-Tip screwdriver.
 7. Attach the STU or STE Cable to J1 on the rear panel (Item 10) and tighten with a 1/8" Flat-Tip screwdriver.
 8. Attach the Fan Panel Power Cable to J7 on the rear panel (Item 9) and tighten with a 1/8" Flat-Tip screwdriver.
 9. Place the IU into the rack assembly.
 10. Place 10/32 x 5/16 inch screws in the four mounting holes and tighten to the host rack using a #2 Phillips screwdriver.
- j. Position the Telephone Drawer on the slides and push the assembly inward until fully seated.
- k. Feed the power cable and telephone cable through the hole on the rear of the telephone drawer.

4.4.2 Removal and Replacement of the RFMOW Modem

Equipment Required:

- One (1) #2 Phillips Screwdriver
- One (1) 1/8" Flat-Tip Screwdriver
- One (1) 3/8" Nut Driver

Remove and replace the Modem by performing the steps in the following procedures:

Removal

- a. Fully extend telephone drawer to place units on to be removed.
- b. Place a piece of foam on drawer to prevent damage.
- c. Using #2 Phillips screwdriver, loosen four (4) retaining screws securing the Modem to rack.
- d. Slide Modem forward and place on the telephone drawer.
- e. Using a 1/8" Flat-Tip screwdriver, remove Data I/O cable connected to the Data I/O on Modem rear panel.
- f. Using a 1/8" Flat-Tip screwdriver, remove Remote cable connected to J6 on Modem rear panel.
- g. Remove RX-IF Input cable connected to CP2 on Modem rear panel.
- h. Remove TX/IF Output cable connected to CP1 on Modem rear panel.
- i. Remove Power cable connected on Modem rear panel.
- j. Using a 3/8" nut driver, remove the Grounding cable on the Grounding Stud on Modem rear panel.

Replacement

- a. Fully extend telephone drawer to place units on to be installed.
- b. Place a piece of foam on drawer to prevent damage.
- c. Place the Modem onto the telephone drawer face down.
- d. Using a $\frac{3}{8}$ " nut driver, replace the Grounding cable on the Grounding Stud on Modem rear panel.
- e. Insert Power cable and connect it to the Modem rear panel.
- f. Insert TX/IF Output cable and connect it to CP1 on Modem rear panel.
- g. Inset RX-IF Input cable and connect it to CP2 on Modem rear panel.
- h. Using a $\frac{1}{8}$ " Flat-Tip screwdriver, insert Remote cable and connect it to J6 on Modem rear panel.
- i. Using a $\frac{1}{8}$ " Flat-Tip screwdriver, insert Data I/O cable and connect it to the Data I/O on Modem rear panel.
- j. Position Modem onto guides in rack and carefully push the Modem in place.
- j. Using #2 Phillips screwdriver, tighten four (4) retaining screws securing the Modem to rack.

4.4.3 Removal and Replacement of the RFMOW Fan Panel

Equipment Required:

- One (1) #2 Phillips Screwdriver
- One (1) $\frac{1}{8}$ " Flat-Tip Screwdriver

Remove and replace the Fan Panel by performing the steps in the following procedures:

Removal

- a. Using #2 Phillips screwdriver, loosen four (4) retaining screws securing the Fan Panel to rack.
- b. Using a $\frac{1}{8}$ " Flat-Tip screwdriver, remove the Power cable on Fan Panel rear panel.

Replacement

- a. Using a $\frac{1}{8}$ " Flat-Tip screwdriver, insert Power cable and connect it to the Fan Panel rear panel.
- b. Position Fan Panel onto rack.
- c. Using #2 Phillips screwdriver, tighten four (4) retaining screws securing the Fan Panel to rack.

4.4.4 Removal and Replacement of the RFMOW Computer

Equipment Required:

- One (1) #1 Phillips Screwdriver
- One (1) #2 Phillips Screwdriver
- One (1) $\frac{1}{8}$ " Flat-Tip Screwdriver
- One (1) $\frac{5}{16}$ " Nut Driver

Remove and replace the Computer by performing the steps in the following procedures:

Removal

- a. Fully extend telephone drawer to place units on to be removed.
- b. Place a piece of foam on drawer to prevent damage.
- c. Using #2 Phillips screwdriver, loosen four (4) retaining screws securing the Computer to rack.
- d. Slide Computer forward and place on the telephone drawer, front panel down.
- e. Remove Ethernet cable from Ethernet port on Computer rear panel.
- f. Remove Video cable connected to VGA Serial Port on Computer rear panel.
- g. Remove PS/2 Keyboard cable connected to "Keyboard" on Computer rear panel.
- h. Remove PS/2 Mouse cable connected to "Mouse" on Computer rear panel.
- i. Using a $\frac{1}{8}$ " Flat-Tip screwdriver, remove Modem Data cable connected to COM1 on Computer rear panel.
- j. Using a $\frac{1}{8}$ " Flat-Tip screwdriver, remove Modem Control cable connected to COM2 on Computer rear panel.

- k. Using a 1/8" Flat-Tip screwdriver, remove RFMOW Enclosure Panel cables connected to COM3 and COM4 on Computer rear panel.
- l. Using a #1 Phillips screwdriver, loosen the Power Retaining Bracket and remove the power cable.
- m. Using a 5/16" nut driver, remove the Grounding cable on the Grounding Stud on Computer rear panel.

Replacement

- a. Fully extend telephone drawer to place units on to be installed.
- b. Place a piece of foam on drawer to prevent damage.
- c. Place the Computer onto the telephone drawer, front panel down.
- d. Using a 5/16" nut driver, replace the Grounding cable on the Grounding Stud on Computer rear panel.
- e. Using a #1 Phillips screwdriver, insert Power Cable on Computer rear panel and tighten the Power Retaining Bracket.
- f. Using a 1/8" Flat-Tip screwdriver, insert RFMOW Enclosure Panel cables and connect them to COM3 and COM4 on Computer rear panel.
- g. Using a 1/8" Flat-Tip screwdriver, insert Modem Control cable and connect it to COM2 on Computer rear panel.
- h. Using a 1/8" Flat-Tip screwdriver, inset Modem Data cable and connect it to COM1 on Computer rear panel.
- i. Insert PS/2 Mouse cable and connect it to "Mouse" on Computer rear panel.
- j. Insert PS/2 Keyboard cable and connect it to "Keyboard" on Computer rear panel.
- k. Insert Video cable and connect it to VGA Serial Port on Computer rear panel.
- l. Insert Ethernet cable into Ethernet port on Computer rear panel.
- m. Position Computer onto guides in rack and carefully push the Computer in place.
- n. Using #2 Phillips screwdriver, tighten four (4) retaining screws securing the Computer to rack.

4.4.5 Removal and Replacement of the RFMOW Keyboard/Video/Monitor (KVM)

Equipment Required:

- One (1) #2 Phillips Screwdriver
- One (1) 1/8" Flat-Tip Screwdriver
- One (1) 11/32" Nut Driver

Remove and replace the Keyboard/Video/Monitor (KVM) by performing the steps in the following procedures:

Removal

- a. Fully extend telephone drawer to place units on to be removed.
- b. Place a piece of foam on drawer to prevent damage.
- c. Tighten thumbscrews so that drawers will not open.
- d. Using #2 Phillips screwdriver, loosen four (4) retaining screws securing the KVM to rack.
- e. Slide KVM forward and place on the telephone drawer, front panel down.
- f. Remove Video cable connected to "Analog RGB (VGA)" on KVM rear panel.
- g. Remove PS/2 Keyboard cable connected to "Keyboard (violet)" on KVM rear panel.
- h. Remove PS/2 Mouse cable connected to "Mouse (green)" on KVM rear panel.
- i. Remove Power cable connected on KVM rear panel.
- j. Using a 11/32" nut driver, remove the Grounding cable on the Grounding Stud on KVM rear panel.

Replacement

- a. Fully extend telephone drawer to place units on to be installed.
- b. Place a piece of foam on drawer to prevent damage.
- c. Place the KVM onto the telephone drawer.
- d. Using a 11/32" nut driver, replace the Grounding cable on the Grounding Stud on KVM rear panel.
- e. Insert PS/2 Mouse cable and connect it to "Mouse (green)" on KVM rear panel.
- f. Insert PS/2 Keyboard cable and connect it to "Keyboard (violet)" on KVM rear panel.
- g. Insert Video cable and connect it to "Analog RGB (VGA)" on KVM rear panel.
- h. Insert Power cable and connect it on KVM rear panel.
- i. Position KVM onto guides in rack and carefully push the KVM in place.
- j. Using #2 Phillips screwdriver, tighten four (4) retaining screws securing the KVM to rack.

4.4.6 Removal and Replacement of the RFMOW Interface Unit

Equipment Required:

- One (1) #2 Phillips Screwdriver
- One (1) 1/8" Flat-Tip Screwdriver
- One (1) 5/16" Nut Driver

Remove and replace the Interface Unit by performing the steps in the following procedures:

Removal

- a. Fully extend telephone drawer to place units on to be removed.
- b. Place a piece of foam on drawer to prevent damage.
- c. Using #2 Phillips screwdriver, loosen four (4) retaining screws securing the Interface Unit to rack.
- d. Slide IU forward and place on the telephone drawer, front panel down.
- e. Using a 1/8" Flat-Tip screwdriver, remove Secure Voice Unit (STU or STE) cable connected to J1 on IU rear panel.
- f. Using a 1/8" Flat-Tip screwdriver, remove Controller Modem Data cable connected to J2 on IU rear panel.
- g. Using a 1/8" Flat-Tip screwdriver, remove Controller cable connected to J4 on IU rear panel.
- h. Using a 1/8" Flat-Tip screwdriver, remove Modem Control cable connected to J5 on IU rear panel.
- i. Using a 1/8" Flat-Tip screwdriver, remove Modem Data cable connected to J6 on IU rear panel.
- j. Using a 1/8" Flat-Tip screwdriver, remove Power Out cable connected to J7 on IU rear panel.
- k. Remove Power cable connected on IU rear panel.
- l. Using a 5/16" nut driver, remove the Grounding cable on the Grounding Stud on IU rear panel.

Replacement

- a. Fully extend telephone drawer to place units on to be installed.
- b. Place a piece of foam on drawer to prevent damage.
- c. Place the IU onto the telephone drawer, front panel down.
- d. Using a 5/16" nut driver, replace the Grounding cable on the Grounding Stud on IU rear panel.
- e. Insert Power cable connected on IU rear panel.
- f. Using a 1/8" Flat-Tip screwdriver, insert Secure Voice Unit (STU or STE) cable and connect it to J1 on IU rear panel.
- g. Using a 1/8" Flat-Tip screwdriver, insert Controller Modem Data cable and connect it to J2 on IU rear panel.
- h. Using a 1/8" Flat-Tip screwdriver, insert Controller cable and connect it to J4 on IU rear panel.
- i. Using a 1/8" Flat-Tip screwdriver, insert Modem Control cable and connect it to J5 on IU rear panel.
- j. Using a 1/8" Flat-Tip screwdriver, insert Modem Data cable and connect it to J6 on IU rear panel.
- k. Using a 1/8" Flat-Tip screwdriver, insert Power Out cable and connect it to J7 on IU rear panel.
- l. Position IU onto guides in rack and carefully push the IU in place.
- m. Using #2 Phillips screwdriver, tighten four (4) retaining screws securing the Interface Unit to rack.

This page left blank intentionally.

CHAPTER 5

REPAIR PARTS AND SPECIAL TOOLS LIST

5.1 INTRODUCTION

This chapter contains parts list information for Replacement Frequency Modulated Orderwire, manufactured by Raven Electronics Corporation.

5.2 LIST OF MANUFACTURERS

The Commercial and Government Entity (CAGE) code and manufacturer's address for the RFMOW are listed below:

<u>CAGE Code</u>	<u>Name and Address</u>
1RN38	Comtech EF Data 2114 W. 7 th Street Tempe, AZ 85281
51504	Raven Electronics Corporation 400 Edison Way Reno, NV 89502

5.3 PARTS LIST

RFMOW parts are shown in Figure 5-1 through Figure 5-3 and listed in Table 5-1 through Table 5-3. Format for the various assembly parts lists are described in the following subparagraphs.

- i. Figure and Index. This column lists the figure and index number for each part listed in the associated parts list.
- ii. CAGE Code Column. This column lists the Commercial and Government Entity (CAGE) code for the manufacturer of the item.
- iii. Part Number Column. This column lists the manufacturer or Government part number. When a vendor part number is listed (other than Raven Electronics Corporation), the corresponding Raven Electronics Corporation specification control drawing number will be listed following the description.
- iv. Description Column. This column describes the common nomenclature associated with each part.
- v. Source, Maintenance, and Recoverability Code Column. The Source, Maintenance, and Recoverability (SMR) code is a five-position code containing supply/requisitioning information, maintenance category authorization criteria, and disposition instruction, as shown in the following breakout.

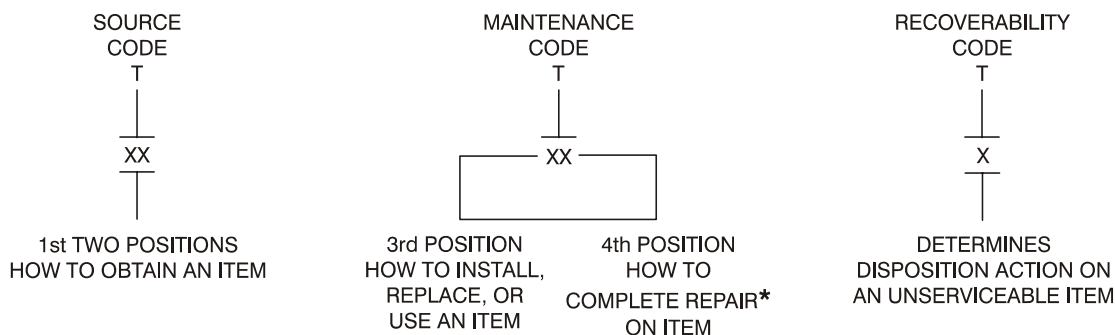

* COMPLETE REPAIR: MAINTENANCE CAPACITY, CAPABILITY, AND AUTHORITY TO PERFORM ALL CORRECTIVE MAINTENANCE TASKS OF THE REPAIR FUNCTION IN A USE/USER ENVIRONMENT IN ORDER TO RESTORE SERVICEABILITY TO A FAILED ITEM.

- a. **Source Code.** The source code indicates how to get an item needed for maintenance, repair, or overhaul of an end item/equipment. Explanation of source codes follows.

PA – Stocked items; use applicable NSN to request/requisition items with these source codes. They are authorized to the category indicated by code entered in third position of SMR code.

- b. **Maintenance Code.** Maintenance codes tell the level(s) of maintenance authorized to USE and REPAIR support items. Maintenance codes are entered in the third and fourth positions of the SMR code as follows.

1. The maintenance code entered in the third position indicates the lowest maintenance level authorized to remove, replace, and use an item. The maintenance code entered in the third position will indicate authorization to one of the following levels of maintenance.

O – Organizational or aviation unit category can remove, replace, and use the item.

2. The maintenance code entered in the fourth position indicates whether or not the item is to be repaired and identifies the lowest maintenance level with the capability to perform complete repair (e.g., perform all authorized repair functions). This position contains one of the following maintenance codes.

NOTE

Some limited repair may be done on item at lower level of maintenance, if authorized by Maintenance Allocation Chart (MAC) and SMR codes.

D – Limited repair by O level. Depot is the lowest level that can do complete repair of the item.

L – Repair by Depot.

Z – Non-repairable. No repair is authorized.

- c. **Recoverability Code.** Recoverability codes are assigned to items to indicate the disposition action on unserviceable items. The recoverability code is entered in the fifth position of the SMR code as follows.

D – Repairable item. When beyond lower level repair capability, return to Depot. Condemnation and disposal of item not authorized below depot level.

Z – Non-repairable item. When unserviceable, condemn and dispose of the item at the level of maintenance shown in third position of SMR code.

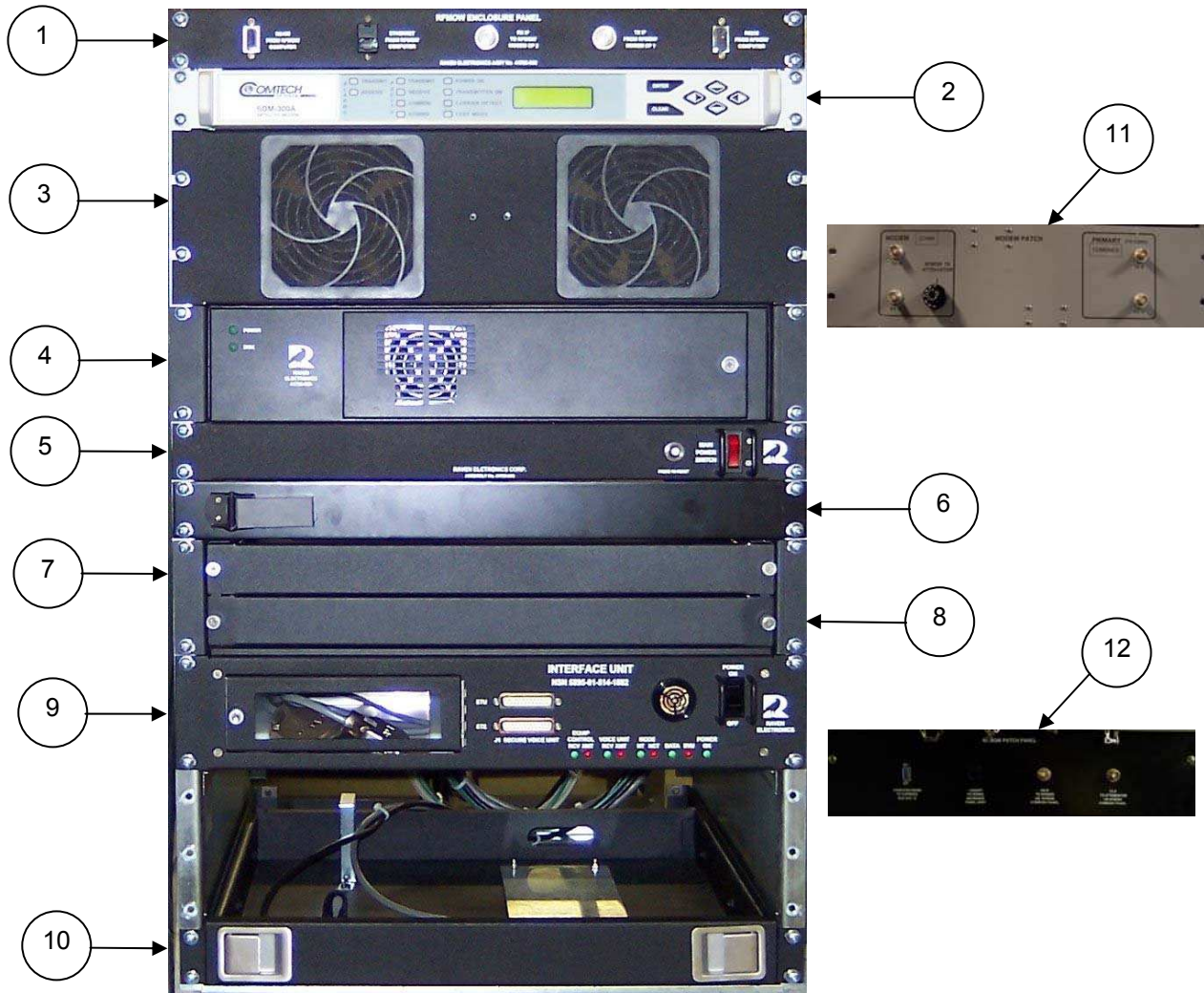

Figure 5-1 Replacement Frequency Modulated Orderwire Parts Location (85 Terminal)

Table 5-1 Replacement Frequency Modulated Orderwire Parts List (85 Terminal)

FIGURE INDEX	CAGE CODE	PART NUMBER	DESCRIPTION	SMR CODE	NSN
Figure 5-1	51504	41700-8593	REPLACEMENT FREQUENCY MODULATED ORDERWIRE (AN/GSC-69(V)1)	PAODD	5895-01-522-2119
Figure 5-1 1	51504	41700-003	. ENCLOSURE PANEL	PAODD	TBD
Figure 5-1 2	1RN38	SDM-300A-726	. MODEM	PAODD	5895-01-463-9474
Figure 5-1 3	51504	41700-001	. FAN PANEL	PAODD	TBD
Figure 5-1 4	51504	41700-005	. COMPUTER	PAODD	7010-01-537-2375
Figure 5-1 5	51504	41700-006	. POWER DISTRIBUTION PANEL	PAODD	TBD
Figure 5-1 6	51504	41700-004	. MONITOR CLAMP PANEL	PAODD	TBD
Figure 5-1 7	51504	41700-015	. MONITOR DRAWER	PAODD	7025-01-537-2367
Figure 5-1 8			. KEYBOARD & MOUSE DRAWER		
Figure 5-1 9	51504	41700-777	. INTERFACE UNIT	PAODD	5895-01-514-1882
Figure 5-1 10	51504	41700-002	. STE TELEPHONE DRAWER	PAODD	TBD
Figure 5-1 11	51504	41700-085	. COMBINER/DIVIDER PANEL	PAODD	TBD
Figure 5-1 12	51504	41700-185	. PATCH PANEL	PAODD	TBD

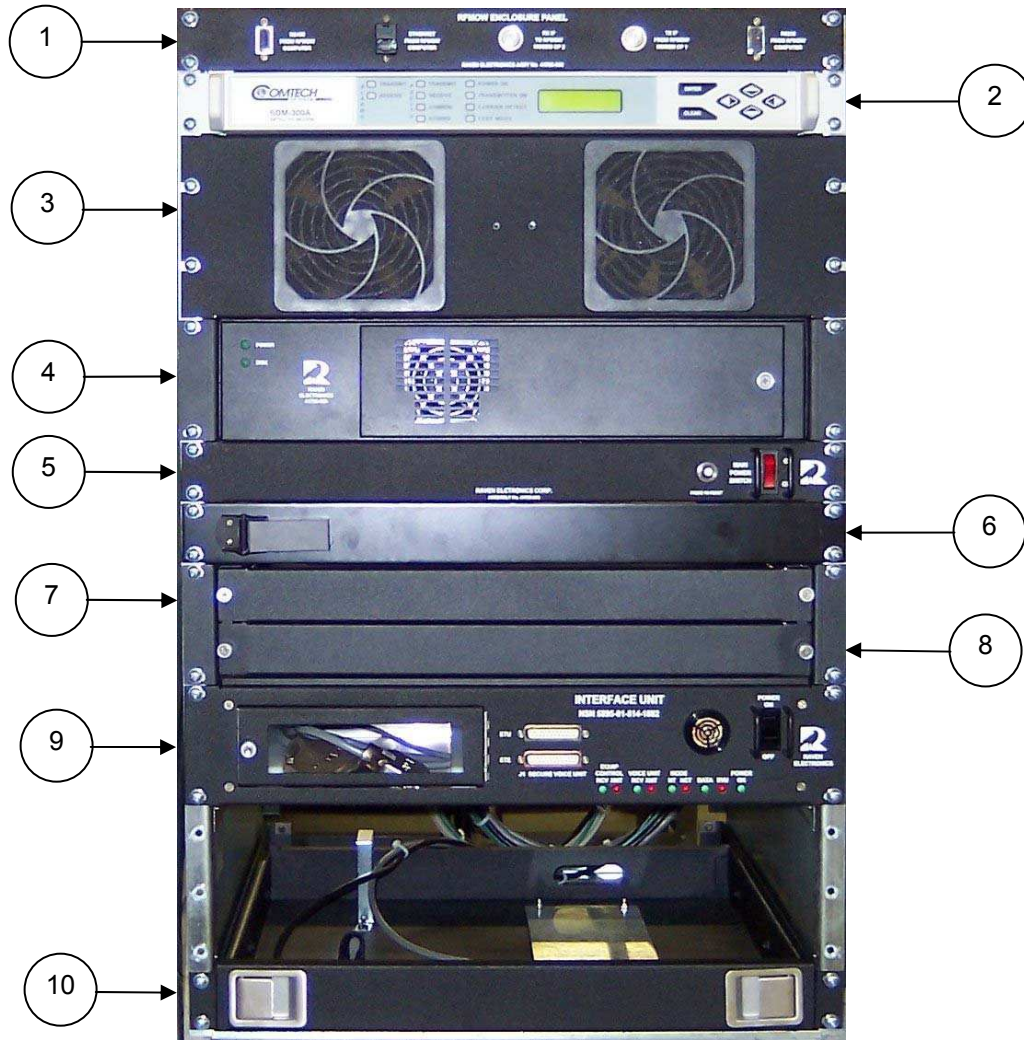

Figure 5-2 Rack Adapter Kit

Table 5-2 Rack Adapter Kit Parts List (85 Terminal)

FIGURE INDEX	CAGE CODE	PART NUMBER	DESCRIPTION	SMR CODE	NSN
Figure 5-2	51504	41700-8593	RACK ADAPTER KIT	PAODD	5975-01-529-3943
Figure 5-2 1	51504	41700-003	. ENCLOSURE PANEL	PAODD	TBD
Figure 5-2 2	1RN38	SDM-300A-726	. MODEM	PAODD	5895-01-463-9474
Figure 5-2 3	51504	41700-001	. FAN PANEL	PAODD	TBD
Figure 5-2 4	51504	41700-005	. COMPUTER	PAODD	7010-01-537-2375
Figure 5-2 5	51504	41700-006	. POWER DISTRIBUTION PANEL	PAODD	TBD
Figure 5-2 6	51504	41700-004	. MONITOR CLAMP PANEL	PAODD	TBD
Figure 5-2 7	51504	41700-015	. MONITOR DRAWER	PAODD	7025-01-537-2367
Figure 5-2 8			. KEYBOARD & MOUSE DRAWER		
Figure 5-2 9	51504	41700-777	. INTERFACE UNIT	PAODD	5895-01-514-1882
Figure 5-2 10	51504	41700-002	. STE TELEPHONE DRAWER	PAODD	TBD

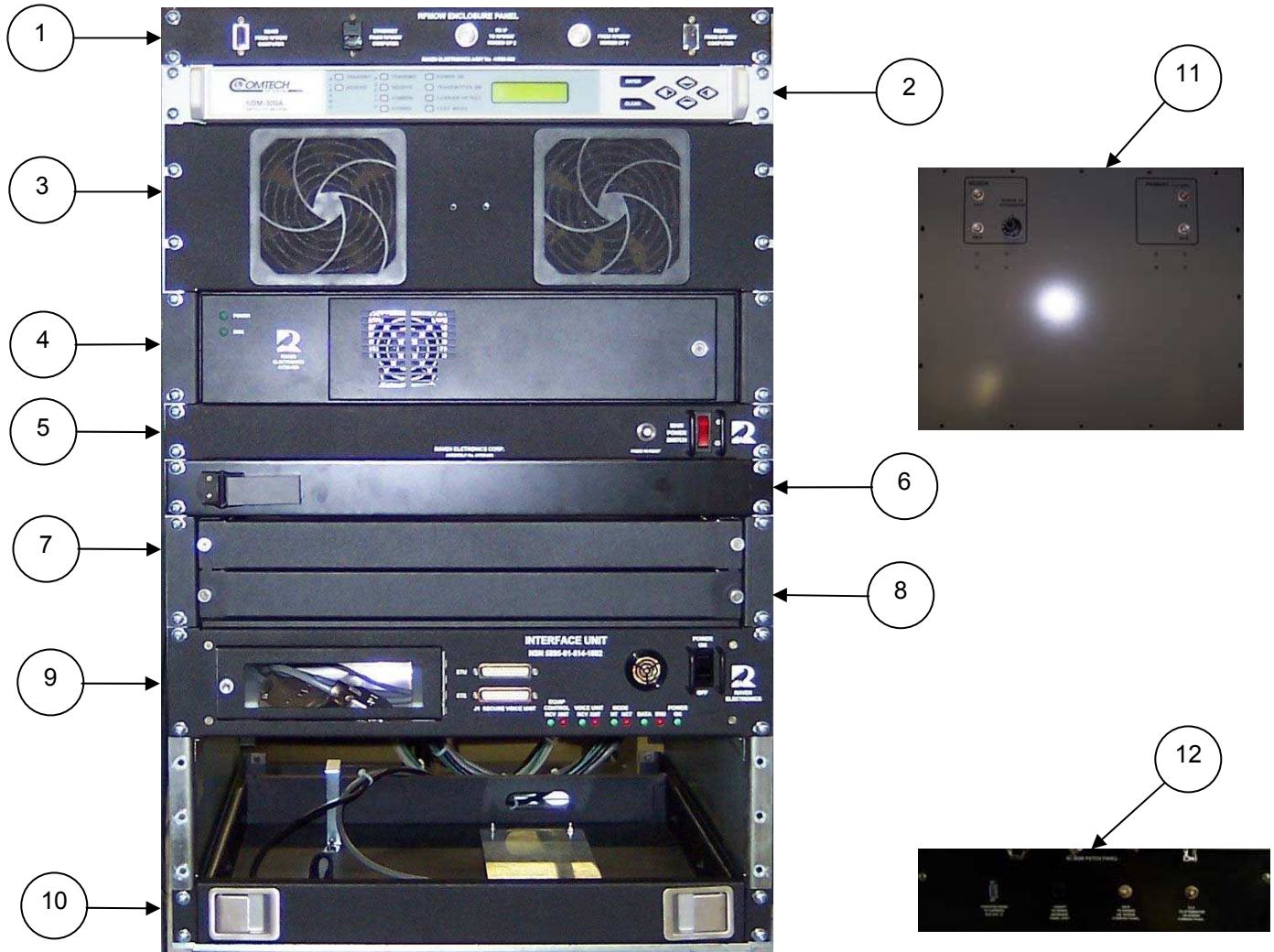

Figure 5-3 Replacement Frequency Modulated Orderwire Parts Location (93 Terminal)

Table 5-3 Replacement Frequency Modulated Orderwire Parts List (93 Terminal)

FIGURE INDEX	CAGE CODE	PART NUMBER	DESCRIPTION	SMR CODE	NSN
Figure 5-3	51504	41700-8593	REPLACEMENT FREQUENCY MODULATED ORDERWIRE (AN/GSC-69(V)2)	PAODD	5895-01-522-2117
Figure 5-3 1	51504	41700-003	. ENCLOSURE PANEL	PAODD	TBD
Figure 5-3 2	1RN38	SDM-300A-726	. MODEM	PAODD	5895-01-463-9474
Figure 5-3 3	51504	41700-001	. FAN PANEL	PAODD	TBD
Figure 5-3 4	51504	41700-005	. COMPUTER	PAODD	7010-01-537-2375
Figure 5-3 5	51504	41700-006	. POWER DISTRIBUTION PANEL	PAODD	TBD
Figure 5-3 6	51504	41700-004	. MONITOR CLAMP PANEL	PAODD	TBD
Figure 5-3 7	51504	41700-015	. MONITOR DRAWER	PAODD	7025-01-537-2367
Figure 5-3 8			. KEYBOARD & MOUSE DRAWER		
Figure 5-3 9	51504	41700-777	. INTERFACE UNIT	PAODD	5895-01-514-1882
Figure 5-3 10	51504	41700-002	. STE TELEPHONE DRAWER	PAODD	TBD
Figure 5-3 11	51504	41700-093	. COMBINER/DIVIDER PANEL	PAODD	TBD
Figure 5-3 12	51504	41700-193	. PATCH PANEL	PAODD	TBD

APPENDIX A

REFERENCE PUBLICATIONS

RELATED TECHNICAL MANUALS

The following manuals or related publications may be required to operate and maintain the Replacement Frequency Modulated Orderwire (RFMOW).

TM 11-5895-1780-13&P 41700-777	RFMOW Technical Manual Interface Unit Manual
DISA, System Specification KIV-7	"ITOS Version 2.0", dated 29 October 1998 Mykotronx, Embeddable KG-84 COMSEC Module (KIV-7) User's Manual
SECTEL MMT-1500	Motorola, Inc., SECTEL MMT-1500, Multimedia Terminal, User's Manual [part number 6844083D03 dated April 1995]
STE USERS MANUAL	L-3 Communications, STE USERS MANUAL, control number K00000187
SDM-100	EFDData Corporation, SDM-100 Satellite Modem Installation and Operation Manual
SDM-300A	EFDData Corporation, SDM-300A Satellite Modem Installation and Operation Manual
SLM 8650	EFDData Corporation, SLM 8650 Satellite Modem Installation and Operation Manual
TM 11-5895-1196-13&P-1 dated 14 Feb 03	Harris Corporation CV-4251/G Frequency Up Converter, Interactive Electronic Technical Manual for the AN/GSC-39, AN/GSC-52 and AN/FSC-78 Satellite Communication Terminals, Version 2.0.0
TM 11-5895-1196-13&P-1 dated 14 Feb 03	Harris Corporation CV-4250/G Frequency Down Converter, Interactive Electronic Technical Manual for the AN/GSC-39, AN/GSC-52 and AN/FSC-78 Satellite Communication Terminals, Version 2.0.0
TM 11-5895-1124-14 dated 15 August 1987	CMI Corporation, CV-3655/G Frequency Up Converter User's Manual
TM 11-5895-1124-14 dated 15 August 1987	CMI Corporation, CV-3654/G Frequency Down Converter User's Manual
TM 11-5895-1356-40 dated 1 July 1990	CMI Corporation, CV-3655A/G Frequency Up Converter User's Manual
TM 11-5895-1356-40 dated 1 July 1990	CMI Corporation, CV-3654A/G Frequency Down Converter User's Manual
TM 11 5895-1196-13 Vol 1-10	Medium Satellite Communications Terminal AN/GSC-52(V), Fixed

This page left blank intentionally.

APPENDIX B

MAINTENANCE ALLOCATION CHART

Section I. INTRODUCTION

B-1 THE ARMY MAINTENANCE SYSTEM MAC

This section provides a general explanation of all maintenance and repair functions authorized at various maintenance levels.

B-1.1 This introduction (section I) provides a general explanation of all maintenance and repair functions authorized at various maintenance levels under the standard Army Maintenance System concept.

B-1.2 The Maintenance Allocation Chart (MAC) in section II designates overall authority and responsibility for the performance of maintenance functions on the identified end item or component. The application of the maintenance functions to the end item or component will be consistent with the capacities and capabilities of the designated maintenance levels, which are shown on the MAC in column (4) as:

Unit – Includes two sub-columns, C (operator, crew) and O (unit) maintenance.

Organizational – Includes an F sub-column.

General Support – Includes an H sub-column.

Depot – Includes a D sub-column.

B-1.3 Section III lists the tools and test equipment (both special tools and common tool sets) required for each maintenance function as referenced from section II.

B-1.4 Section IV contains supplemental instructions and explanatory notes for a particular maintenance function.

B-2 Maintenance Functions

Maintenance functions are to be limited to and defined as below:

B-2.1 **Inspect** To determine the serviceability of an item by comparing its physical, mechanical, and/or electrical characteristics with established standards through examination (e.g., by sight, sound, or feel).

B-2.2 **Test** To verify serviceability by measuring the mechanical, pneumatic, hydraulic, or electrical characteristics of an item/end item and comparing those characteristics with prescribed standards.

B-2.3 **Service** Operations required periodically to keep an item in proper operating condition, e.g., to clean (includes decontaminate, when required), to preserve, to drain, to paint, or to replenish fuel, lubricants, chemical fluids, or gases.

B-2.4 **Adjust** To maintain or regulate, within prescribed limits, by bringing into proper position, or by setting the operating characteristics to specified parameters.

B-2.5 **Align** To adjust specified variable elements of an item to bring about optimum or desired performance.

- B-2.6 **Calibrate** To determine and cause corrections to be made or to be adjusted on instruments or test, measuring, and diagnostic equipment used in precision measurement. Consists of comparisons to two instruments, one of which is a certified standard of known accuracy, to detect and adjust and discrepancy in the accuracy of the instrument being compared.
- B-2.7 **Remove/Install** To remove and install the same item when required to perform service or other maintenance functions. Install may be the act of emplacing, seating, or fixing into position a spare, repair part, or module (component or assembly) in a manner to allow the proper functioning of an equipment or system.
- B-2.8 **Replace** To remove an unserviceable item and install a serviceable counterpart in its place. "Replace" is authorized by the MAC and assigned maintenance level is shown as the 3rd position code of the SMR code.
- B-2.9 **Repair** The application of maintenance services¹ including fault location/troubleshooting² removal/installation, and disassembly/assembly³ procedures, and maintenance actions⁴ to identify troubles and restore serviceability to an item by correcting specific damage, fault, malfunction, or failure in a part, subassembly, module (component or assembly), end item, or system.
- B-2.10 **Overhaul** That maintenance effort (service/action) prescribed to restore an item to a completely serviceable/operational condition as required by maintenance standards in appropriate technical publications (i.e., DMWR). Overhaul is normally the highest degree of maintenance performed by the Army. Overhaul does not normally return an item to like new condition.
- B-2.11 **Rebuild** Consists of those services/actions necessary for the restoration of unserviceable equipment to a like new condition in accordance with original manufacturing standards. Rebuild is the highest degree of materiel maintenance applied to Army equipment. The rebuild operation includes the act of returning to zero those age measurements (e.g., hours/miles) considered in classifying Army equipment/components.

¹ Services – Inspect, test, service, adjust, align, calibrate, and/or replace.

² Fault location/troubleshooting – The process of investigating and detecting the cause of equipment malfunctioning; the act of isolating a fault within a system or Unit Under Test (UUT).

³ Disassembly/Assembly – The step-by-step breakdown (taking apart) of a spare/functional group coded item to the level of its least component, that is assigned an SMR code for the level of maintenance under consideration (i.e., identified as maintenance significant).

⁴ Actions – Welding, grinding, riveting, straightening, facing, machining, and/or resurfacing.

B-3 EXPLANATION OF COLUMNS IN THE MAC, SECTION II

- B-3.1 **Column 1, Group Number** Column 1 lists functional group code numbers, the purpose of which is to identify maintenance significant components, assemblies, subassemblies, and modules with the next higher assembly. End item group number shall be "00".
- B-3.2 **Column 2, Component/Assembly** Column 2 contains the item names of components, assemblies, subassemblies, and modules for which a maintenance function is authorized.
- B-3.3 **Column 3, Maintenance Functions** Column 3 lists the functions to be performed on the item listed in Column 2 (For detailed explanation of these functions, see paragraph B-2).
- B-3.4 **Column 4, Maintenance Level** Column 4 specifies each level of maintenance authorized to perform each function listed in column 3, by indicating work item required (expressed as task-hours in whole hours or decimals) in the appropriate sub-column. This work-time figure represents the active time required to perform that maintenance function at the indicated level of maintenance. If the number or complexity of the tasks within the listed maintenance function vary at different maintenance levels, appropriate work-time figures are shown for each level. The work-time figure represents the average time required to restore an item (assembly, subassembly, component, module, end item, or system) to a serviceable condition under typical field operating conditions. This time includes preparation time (condition/follow-on tasks) (including any necessary disassembly/assembly time), troubleshooting/fault location time, and quality assurance time in addition to the time required to perform the specific tasks identified for the maintenance functions authorized in the MAC. The symbol designations for the various maintenance levels are as follows:

NOTE

When a complete replace or repair task performed at higher level maintenance includes lower level maintenance tasks (equipment condition/follow-on tasks), the lower level work-time figures in the MAC must be added to the higher level work-time shown in the MAC to determine the total to accomplish the maintenance function.

- C Operator or crew maintenance
- O Unit maintenance
- F Direct support maintenance
- L Specialized Repair Activity (SRA)⁵
- H General support maintenance
- D Depot maintenance⁶

⁵ This maintenance level is not included in Section II, column (4) of the Maintenance Allocation Chart. Functions to this level of maintenance are identified by a work-time figure in the "H" column of Section II, column (4), and an associated reference code is used in the Remarks, column (6). This code is keyed to Section IV, Remarks, and the SRA complete repair application is explained there.

⁶ Specific repair time is not referenced for this level, rather an * is used to designate repair activity.

- B-3.5 **Column 5, Tool and Equipment Ref Code.** Column 5 specifies, by code, those common tool sets (not individual tools), common TMDE, and special tools, special TMDE, and special support equipment required to perform the designated function. Codes are keyed to tools and test equipment in section III.
- B-3.6 **Column 6, Remarks Code.** When applicable, this column contains a letter code, in alphabetical order, which is keyed to the remarks contained in section IV.

B-4 EXPLANATION OF THE COLUMNS IN TOOLS AND TEST EQUIPMENT

The following subparagraphs provide an explanation of the columns in Tools and Test Equipment (Section III).

- B-4.1 **Column 1, Tools or Equipment Ref Code.** The tool and test equipment reference code correlates with a code used in the MAC, Section II, Column 5.
- B-4.2 **Column 2, Maintenance Level.** The lowest level of maintenance authorized to use the tool or test equipment.
- B-4.3 **Column 3, Nomenclature.** Name or identification of the tool or test equipment.
- B-4.4 **Column 4, National Stock Number.** The National Stock Number of the tool or test equipment.
- B-4.5 **Column 5, Tool Number.** The manufacturer's part number, model number, or type number.

B-5 EXPLANATION OF COLUMNS IN REMARKS, SECTION IV

- B-5.1 **Column 1, Remarks Code.** The code recorded in Column 6, Section II.
- B-5.2 **Column 2, Remarks.** This column, along with the related codes, should be used to clarify maintenance and inspection functions by different MOS' involved in maintaining some components.

Section II. MAC for RFMOW

Table B-1										
(1) GROUP NUMBER	(2) COMPONENT/ASSEMBLY	(3) MAINTENANCE FUNCTIONS	(4) MAINTENANCE LEVEL					(5) TOOL AND EQUIPMENT REF CODE	(6) REMARKS CODE	
			FIELD		SUSTAINMENT					
			UNIT		DIRECT SUPPORT	GENERAL SUPPORT	DEPOT			
			C	O	F	H	D			
00	REPLACEMENT FREQUENCY MODULATED ORDERWIRE 41700-8593 NSN: 5895-01-522-2119 (85) NSN: 5975-01-529-3743 (85 Rack) NSN: 5895-01-522-2117 (93)	Replace	5.3				*	1-8	A, D, G	
		Service (clean)		.1						B
		Inspect		.1						D
		Test		.5						E, F
01	ENCLOSURE PANEL 41700-003	Inspect		.1				7, 8	D	
		Service (clean)		.1					B	
		Replace		.2			*		G	
		Test		.2					F	
02	SDM-300A MODEM V100-0040	Inspect		.1				3, 7, 8	D	
		Service (clean)		.1					B	
		Replace		.5			*		G	
		Test		.5					F	
03	FAN PANEL 41700-001	Inspect		.1				2, 7, 8	D	
		Service (clean)		.2					C	
		Replace		.5			*		G	
		Test		.1					E	
04	COMPUTER 41700-005	Inspect		.1				4, 7, 8	D	
		Service (clean)		.1					C, G	
		Replace		.5			*		G	
		Test		.5					F	
0401	KEYBOARD/MONITOR/MOUSE 41700-015	Inspect		.1				4, 7, 8	D	
		Service (clean)		.1					B	
		Replace		.2			*		G	
		Test		.5					F	
05	POWER DISTRIBUTION PANEL 41700-006	Inspect		.1				2, 7	D	
		Service (clean)		.1					B	
		Replace		.5			*		G	
		Test		.2					E	

Table B-1

(1) GROUP NUMBER	(2) COMPONENT/ASSEMBLY	(3) MAINTENANCE FUNCTIONS	(4) MAINTENANCE LEVEL					(5) TOOL AND EQUIPMENT REF CODE	(6) REMARKS CODE
			FIELD		SUSTAINMENT				
			UNIT		DIRECT SUPPORT	GENERAL SUPPORT	DEPOT		
			C	O	F	H	D		
06	MONITOR CLAMP 41700-004	Inspect Service (clean) Replace Test		.1 .1 .2 .1			*	7	D B G E
07	INTERFACE UNIT 41700-777	Inspect Service (clean) Replace Test		.1 .1 .5 .2			*	4, 7, 8	D B G F
0701	KIV-7	Inspect Replace Test	.1		.2 .2				D, P G, K, P E, P
08	STE TELEPHONE DRAWER 41700-002	Inspect Service (clean) Replace Test		.1 .1 .2 .1			*	7	D B G E
0801	STE PHONE	Inspect Replace Test	.1		.1				D, P K, P E, P

Section III. Tools and Test Equipment Requirements for RFMOW

Table B-2				
TOOL OR TEST EQUIPMENT REF CODE	MAINTENANCE LEVEL*	NOMENCLATURE	NATIONAL STOCK NUMBER	TOOL NUMBER
1	C, O	5 mm Nut Driver		
2	C, O	11/32 in. Nut Driver		
3	C, O	3/8 in. Nut Driver		
4	C, O	5/16 in. Nut Driver		
5	C, O	1/4 in. Nut Driver		
6	C, O	#1 Philips Screwdriver		
7	C, O	#2 Philips Screwdriver		
8	C, O	1/8 in. Flat-Tip Screwdriver		

*C--Crew
 O--Organization
 F--Direct Support
 H--General Support
 D--Depot

Section IV. Remarks for RFMOW

Table B-3

1 REFERENCE CODE	2 REMARKS
A	Installation at the operational site is accomplished by personnel using tools and test equipment in accordance with approved, site-unique installation plans and procedures. Since installation is a one-time action and unique to each site, no installation procedures are included in the manual.
B	Service by the operator consists of (1) periodic replenishment of expendables that can be accomplished without any equipment disassembly, and (2) cleaning of the exposed surfaces of all equipment to remove accumulated contaminants. Cleaning is accomplished using a soft brush, lint less cotton cloth, and isopropyl alcohol, as required.
C	Service by the operator consists of (1) periodic replenishment of expendables that require equipment disassembly to be accomplished, and (2) the use of a vacuum to clean all air filters and the interiors of cabinets and equipment items.
D	Inspection by the operator is limited to determining the serviceability of the system and equipment items by visually observing that selected indicators, screen displays, and/or hardcopy messages comply with established standards.
E	Testing by the operator at the system or equipment level is limited to operational performance verification accomplished using self-test features or an embedded or downloaded diagnostic where applicable without the aid of any TMDE.
F	Testing by the operator using self-test features or an embedded or down-loaded diagnostic where applicable without the aid of any TMDE to the extent necessary to localize and/or isolate system failures to a repairable or replaceable level of assembly and to verify the effectiveness of corrective action accomplished by repair or replacement.
G	Repair accomplished in place by the operator by removal and replacement of lower-level assemblies, to include but not limited to computer monitor, mouse, keyboard, interface Unit, as well as, cables and parts coded non-repairables
H	Overhaul at the operational site, if required, will be accomplished by O&M contractor personnel using O&M contractor-furnished tools and test equipment in accordance with a government-approved, site-unique overhaul plan.
J	Testing performed by the operator using listed TMDE as necessary to isolate a malfunction to the individual equipment item.
K	Replacement from on-site spares inventory, performed by the operator.
L	Repair accomplished in place by O&M contractor personnel using contractor furnished tools and test equipment IAW site-unique requirements.
M	Repair is accomplished by the Original Equipment Manufacturer (OEM) or army support structure.
N	Repair is accomplished by the authorized activity and IAW procedure for repairing security equipment.
O	Alignment is accomplished by the user/operator IAW alignment procedures in Appendix C and TMDE identified in Section III of this MAC.
P	See COMSEC Officer for this equipment and handling/control procedures.

APPENDIX C
COMPONENTS OF END ITEMS
AND
BASIC ISSUE ITEMS LIST

NONE REQUIRED

This page left blank intentionally.

APPENDIX D
EXPENDABLE/DURABLE ITEMS LIST

D-1 SCOPE

This appendix contains the expendable and durable items list that is needed to operate and maintain the Replacement Frequency Modulated Orderwire (RFMOW). This list is for information only and is not authority to requisition the listed items.

D-2 EXPLANATION OF COLUMNS

The following subparagraphs explain the information in the various columns of Table D-1.

D-2.1 Item

This number is assigned to the entry in the listing and is referenced to identify the item.

D-2.2 Level

This letter identifies the lowest level of maintenance that requires the item.

D-2.3 NSN

This number identifies the National Stock Number of the item to be used for inventory or requisition purposes.

D-2.4 Description

This column provides a minimal description of the item.

D-2.5 Part Number

This column provides the item part number.

D-2.6 Cage Code

The Commercial And Government Entity Code (CAGE CODE) is a five-digit code that identifies the manufacturer, distributor, or Government agency that supplies the item.

D-2.7 U/M

The Unit of Measurement (U/M) code shows the physical measurement or count of an item, such as gallon, dozen, gross, etc.

Table D-1 Expendable/Durable Items List						
ITEM	LEVEL	NSN	DESCRIPTION	PART NO.	CAGE CODE	U/M
1	O	N/A	Fan Panel Intake Filter	E100-0001	51504	EA
2	O	N/A	Computer Intake Filter	E100-0002	51504	EA

This page left blank intentionally.

APPENDIX E

MANUAL EQUIPMENT CONFIGURATION PROCEDURES

E-1 KIV-7HSB CONFIGURATION

NOTE: Verify operational status of the KIV-7HSB battery. Consult KIV-7HSB manual for procedure.

1. Load Key using Fill Device.
 - a. Initiate the load process using the appropriate fill device. Follow the instructions associated with the fill device for further information. **NOTE:** The key must be loaded into the X01 register.
 - b. Observe "Load Good" status message when load is complete. Consult KIV-7HSB manual if a different status message is displayed and repeat loading procedure if necessary.
2. Perform the following procedure to configure the KIV-7HSB via the **SETUP A** menu:
 - a. Verify Power is ON and Key is inserted and turned clockwise 90°. If the KIV-7HSB is On-Line, press ON-LINE to put the KIV-7HSB OFF-LINE, else continue.
 - b. Press SCROLL to display SETUP A and press INITIATE.
 - c. Press SCROLL to display CLKSEL and press INITIATE.
 - d. Press SCROLL to display MASTER and press INITIATE. MASTER should be (selected) highlighted.
 - e. Press SCROLL to display RETURN and press INITIATE to exit sub-menu.
 - f. Press SCROLL to display SYNC SEL and press INITIATE.
 - g. Press SCROLL to display OP2 and press INITIATE. OP2 should be highlighted.
 - h. Press SCROLL to display RETURN and press INITIATE to exit sub-menu.
 - i. Press SCROLL to display COMM SEL and press INITIATE.
 - j. Press SCROLL to display FDX and press INITIATE. FDX should be highlighted.
 - k. Press SCROLL to display RETURN and press INITIATE to exit sub-menu.
 - l. Press SCROLL to display DATA MOD and press INITIATE.
 - m. Press SCROLL to display BB and press INITIATE. BB should be highlighted.
 - n. Press SCROLL to display RETURN and press INITIATE to exit sub-menu.
 - o. Press SCROLL to display DATA LEN and press INITIATE.
 - p. Press SCROLL to display 11 Bits and press INITIATE. 11 Bits should be highlighted.
 - q. Press SCROLL to display RETURN and press INITIATE to exit sub-menu.
 - r. Press SCROLL to display TX RATE and press INITIATE.
 - s. Press SCROLL to display 9.6k and press INITIATE. 9.6k should be highlighted.
 - t. Press SCROLL to display RETURN and press INITIATE to exit sub-menu.
 - u. Press SCROLL to display RX RATE and press INITIATE.
 - v. Press SCROLL to display 9.6k and press INITIATE. 9.6k should be highlighted.
 - w. Press SCROLL to display RETURN and press INITIATE to exit sub-menu.
 - x. Press SCROLL to display TTY MODE and press INITIATE.
 - y. Press SCROLL to display UNFRAMD and press INITIATE. UNFRAMD should be highlighted.
 - z. Press SCROLL to display RETURN and press INITIATE to exit sub-menu.
 - aa. Press SCROLL to display I/F CTRL and press INITIATE.
 - bb. Press SCROLL to scroll through to ensure that no options are selected. If an option is found selected, press INITIATE to de-select it.
 - cc. Press SCROLL to display RETURN and press INITIATE to exit sub-menu.
 - dd. Press SCROLL to display RETURN and press INITIATE to exit SETUP A.
3. Perform the following procedure to configure the KIV-7HSB via the **SETUP B** menu:
 - a. Verify Power is ON and Key is inserted and turned clockwise 90°. If the KIV-7HSB is On-Line, press ON-LINE to put the KIV-7HSB off-line, else continue
 - b. Press SCROLL to display SETUP B and press INITIATE.
 - c. Press SCROLL to display INVERT and press INITIATE.
 - d. Press SCROLL to scroll through to ensure that no options are selected. If an option is found selected, press INITIATE to de-select it.
 - e. Press SCROLL to display RETURN and press INITIATE to exit sub-menu.
 - f. Press SCROLL to display TX CLOCK and press INITIATE.

- g. Press SCROLL to display CONT TXC and press INITIATE. CONT TXC should be highlighted.
 - h. Press SCROLL to display RETURN and press INITIATE to exit sub-menu.
 - i. Press SCROLL to display RX CLOCK and press INITIATE.
 - j. Press SCROLL to display CONT RXC and press INITIATE. CONT RXC should be highlighted.
 - k. Press SCROLL to display RETURN and press INITIATE to exit sub-menu.
 - l. Press SCROLL to display SYNC OOS and press INITIATE.
 - m. Press SCROLL to display DISABLD and press INITIATE.
 - n. Press SCROLL to display RETURN and press INITIATE to exit sub-menu.
 - o. Press SCROLL to display IDLE SEL and press INITIATE.
 - p. Press SCROLL to display DISABLD and press INITIATE. DISABLD should be highlighted.
 - q. Press SCROLL to display RETURN and press INITIATE to exit sub-menu.
 - r. Press SCROLL to display AUTO PHS and press INITIATE.
 - s. Press SCROLL to display OFF and press INITIATE. OFF should be highlighted.
 - t. Press SCROLL to display RETURN and press INITIATE to exit sub-menu.
 - u. Press SCROLL to display UPDATE U and press INITIATE.
 - v. Press SCROLL to display ENABLED, and press INITIATE.
 - w. Press SCROLL to display RETURN and press INITIATE to exit sub-menu.
 - x. Press SCROLL to display CLK LOCK and press INITIATE.
 - y. Press SCROLL to display DISABLD and press INITIATE.
 - z. Press SCROLL to display RETURN and press INITIATE to exit sub-menu.
 - aa. Press SCROLL to display RETURN and press INITIATE to exit SETUP B.
4. Perform the following procedure to configure the KIV-7HSB via the **SETUP C** menu:
- a. Verify Power is ON and Key is inserted and turned clockwise 90°. If KIV-7HSB is On-Line, press ON-LINE to put the KIV-7HSB off-line, else continue.
 - b. Press SCROLL to display SETUP C and press INITIATE.
 - c. Press SCROLL to display RED I/F and press INITIATE.
 - d. Press SCROLL to display RS-232 and press INITIATE. RS-232 should be highlighted.
 - e. Press SCROLL to display RETURN and press INITIATE to exit sub-menu.
 - f. Press SCROLL to display BLK I/F and press INITIATE.
 - g. Press SCROLL to display EIA-530 and press INITIATE. EIA-530 should be highlighted.
 - h. Press SCROLL to display RETURN and press INITIATE to exit sub-menu.
 - i. Press SCROLL to display FIL I/F and press INITIATE.
 - j. Press SCROLL to display 102/STD and press INITIATE. 102/STD should be highlighted.
 - k. Press SCROLL to display RETURN and press INITIATE to exit sub-menu.
 - l. Press SCROLL to display RETURN and press INITIATE to exit SETUP C.
5. Perform the following procedure to configure the KIV-7HSB via the **SETUP D** menu:
- a. Verify Power is ON and Key is inserted and turned clockwise 90°. If KIV-7HSB is On-Line, press ON-LINE to put the KIV-7HSB off-line, else continue.
 - b. Press SCROLL to display SETUP D and press INITIATE.
 - c. Press SCROLL to display MSTRSLV and press INITIATE.
 - d. Press SCROLL to display SLAVE and press INITIATE.
 - e. Press SCROLL to display RETURN and press INITIATE to exit sub-menu.
 - f. Press SCROLL to display ALGRTHM and press INITIATE.
 - g. Press SCROLL to display ALG 1 and press INITIATE.
 - h. Press SCROLL to display RETURN and press INITIATE to exit sub-menu.
 - i. Press SCROLL to display RETURN and press INITIATE to exit SETUP D.
6. Perform the following procedure to select a Traffic Encryption Key (TEK) for secure on-line operation:
- a. Verify Power is ON and Key is inserted and turned clockwise 90°. If the KIV-7HSB is On-Line, press ON-LINE to put the KIV-7HSB off-line, else continue.
 - b. Press SCROLL to display SEL KEY and press INITIATE.
 - c. Press SCROLL to display KEY X01 and press INITIATE. KEY X01 should be highlighted.
 - d. Observe the "Key Good" status message and PARITY indicator. Consult KIV-7HSB manual if a different status message is displayed.
 - e. If the selected TEK is not loaded or not valid, the parity indicator remains lit. Another TEK must be selected or a valid TEK must be loaded into the selected location prior to initiating on-line operation.
 - f. Press SCROLL to display RETURN and press INITIATE to exit SEL KEY.

7. Perform the following procedure to store the SETUP A, SETUP B, SETUP C, SETUP D and SEL KEY configuration:
 - a. If KIV-7HSB is On-Line, press ON-LINE to put the KIV-7HSB off-line.
 - b. Press SCROLL to display SET MGMT and press INITIATE.
 - c. Press SCROLL to display STORE and press INITIATE.
 - d. Press SCROLL to the desired storage location 1 and press INITIATE.
 - e. Observe the "STO Good" status message. Consult KIV-7HSB manual if a different status message is displayed.
 - f. Press SCROLL to display RETURN and press INITIATE to exit sub-menu.Select KIV-7HSB, Press ON-LINE Button, Display is illuminated and reads FDX TR. ("FDX TR" will indicate that KIV-7HSB has been properly configured).

NOTE: Refer to Table E-1 for a summary of KIV-7HSB configuration.

E-2 KIV-7 AND KIV-7HS CONFIGURATION

NOTE: KIV-7 and KIV-7HS use the same configuration. The configuration procedures will use the definition KIV-7 when referring to the device.

NOTE: Verify operational status of the KIV-7 battery. Consult KIV-7 manual for procedure.

1. Load Key using Fill Device.
 - a. Initiate the load process using the appropriate fill device. Follow the instructions associated with the fill device for further information. **NOTE:** The key must be loaded into the X01 register.
 - b. Observe "Load Good" status message when load is complete. Consult KIV-7HSB manual if a different status message is displayed and repeat loading procedure if necessary.
2. Perform the following procedure to configure the KIV-7 via the **SETUP A** menu:
 - a. Verify Power is ON and Key is inserted and turned clockwise 90°. If the KIV-7 is On-Line, press ON-LINE to put the KIV-7 OFF-LINE, else continue.
 - b. Press SCROLL to display SETUP A and press INITIATE.
 - c. Press SCROLL to display CLKSEL and press INITIATE.
 - d. Press SCROLL to display MASTER and press INITIATE. MASTER should be (selected) highlighted.
 - e. Press SCROLL to display RETURN and press INITIATE to exit sub-menu.
 - f. Press SCROLL to display SYNC SEL and press INITIATE.
 - g. Press SCROLL to display OP2 and press INITIATE. OP2 should be highlighted.
 - h. Press SCROLL to display RETURN and press INITIATE to exit sub-menu.
 - i. Press SCROLL to display COMM SEL and press INITIATE.
 - j. Press SCROLL to display FDX and press INITIATE. FDX should be highlighted.
 - k. Press SCROLL to display RETURN and press INITIATE to exit sub-menu.
 - l. Press SCROLL to display DATA MOD and press INITIATE.
 - m. Press SCROLL to display BB and press INITIATE. BB should be highlighted.
 - n. Press SCROLL to display RETURN and press INITIATE to exit sub-menu.
 - o. Press SCROLL to display DATA LEN and press INITIATE.
 - p. Press SCROLL to display 11 Bits and press INITIATE. 11 Bits should be highlighted.
 - q. Press SCROLL to display RETURN and press INITIATE to exit sub-menu.
 - r. Press SCROLL to display TX RATE and press INITIATE.
 - s. Press SCROLL to display 9.6k and press INITIATE. 9.6k should be highlighted.
 - t. Press SCROLL to display RETURN and press INITIATE to exit sub-menu.
 - u. Press SCROLL to display RX RATE and press INITIATE.
 - v. Press SCROLL to display 9.6k and press INITIATE. 9.6k should be highlighted.
 - w. Press SCROLL to display RETURN and press INITIATE to exit sub-menu.
 - x. Press SCROLL to display TTY MODE and press INITIATE.
 - y. Press SCROLL to display UNFRAMD and press INITIATE. UNFRAMD should be highlighted.
 - z. Press SCROLL to display RETURN and press INITIATE to exit sub-menu.
 - aa. Press SCROLL to display I/F CTRL and press INITIATE.

- bb. Press SCROLL to display RS&CS and press INITIATE. RS&CS should be highlighted.
 - cc. Press SCROLL to display RETURN and press INITIATE to exit sub-menu.
 - dd. Press SCROLL to display RETURN and press INITIATE to exit SETUP A.
3. Perform the following procedure to configure the KIV-7 via the **SETUP B** menu:
- a. Verify Power is ON and Key is inserted and turned clockwise 90°. If the KIV-7 is On-Line, press ON-LINE to put the KIV-7 off-line, else continue.
 - b. Press SCROLL to display SETUP B and press INITIATE.
 - c. Press SCROLL to display INVERT and press INITIATE.
 - d. Press SCROLL to scroll through to ensure that no options are selected. If an option is found selected, press INITIATE to de-select it.
 - e. Press SCROLL to display RETURN and press INITIATE to exit sub-menu.
 - f. Press SCROLL to display TX CLOCK and press INITIATE.
 - g. Press SCROLL to display CONT TXC and press INITIATE. CONT TXC should be highlighted.
 - h. Press SCROLL to display RETURN and press INITIATE to exit sub-menu.
 - i. Press SCROLL to display RX CLOCK and press INITIATE.
 - j. Press SCROLL to display CONT RXC and press INITIATE. CONT RXC should be highlighted.
 - k. Press SCROLL to display RETURN and press INITIATE to exit sub-menu.
 - l. Press SCROLL to display SYNC OOS and press INITIATE.
 - m. Press SCROLL to display DISABLD and press INITIATE.
 - n. Press SCROLL to display RETURN and press INITIATE to exit sub-menu.
 - o. Press SCROLL to display IDLE SEL and press INITIATE.
 - p. Press SCROLL to display DISABLD and press INITIATE. DISABLD should be highlighted.
 - q. Press SCROLL to display RETURN and press INITIATE to exit sub-menu.
 - r. Press SCROLL to display AUTO PHS and press INITIATE.
 - s. Press SCROLL to display OFF and press INITIATE. OFF should be highlighted.
 - t. Press SCROLL to display RETURN and press INITIATE to exit sub-menu.
 - u. Press SCROLL to display UPDATE U and press INITIATE.
 - v. Press SCROLL to display ENABLED, and press INITIATE.
 - w. Press SCROLL to display RETURN and press INITIATE to exit sub-menu.
 - x. Press SCROLL to display RETURN and press INITIATE to exit SETUP B.
4. Perform the following procedure to configure the KIV-7 via the **SETUP C** menu:
- a. Verify Power is ON and Key is inserted and turned clockwise 90°. If KIV-7 is On-Line, press ON-LINE to put the KIV-7 off-line, else continue.
 - b. Press SCROLL to display SETUP C and press INITIATE.
 - c. Press SCROLL to display RED I/F and press INITIATE.
 - d. Press SCROLL to display RS-232 and press INITIATE. RS-232 should be highlighted.
 - e. Press SCROLL to display RETURN and press INITIATE to exit sub-menu.
 - f. Press SCROLL to display BLK I/F and press INITIATE.
 - g. Press SCROLL to display EIA-530 and press INITIATE. EIA-530 should be highlighted.
 - h. Press SCROLL to display RETURN and press INITIATE to exit sub-menu.
 - i. Press SCROLL to display FIL I/F and press INITIATE.
 - j. Press SCROLL to display 102/STD and press INITIATE. 102/STD should be highlighted.
 - k. Press SCROLL to display RETURN and press INITIATE to exit sub-menu.
 - l. Press SCROLL to display RETURN and press INITIATE to exit SETUP C.
5. Perform the following procedure to select a Traffic Encryption Key (TEK) for secure on-line operation:
- a. Verify Power is ON and Key is inserted and turned clockwise 90°. Press ON-LINE to put the KIV-7 off-line, if not already off-line, else continue.
 - b. Press SCROLL to display SEL KEY and press INITIATE.
 - c. Press SCROLL to display KEY X01 and press INITIATE. KEY X01 should be highlighted.
 - d. Observe the "Key Good" status message and PARITY indicator. Consult KIV-7 manual if a different status message is displayed.
 - e. If the selected TEK is not loaded or not valid, the parity indicator remains lit. Another TEK must be selected or a valid TEK must be loaded into the selected location prior to initiating on-line operation.

- f. Press SCROLL to display RETURN and press INITIATE to exit SEL KEY.
6. Perform the following procedure to store the SETUP A, SETUP B, SETUP C and SEL KEY configuration:
 - a. If KIV-7 is On-Line, press ON-LINE to put the KIV-7 off-line.
 - b. Press SCROLL to display SET MGMT and press INITIATE.
 - c. Press SCROLL to display STORE and press INITIATE.
 - d. Press SCROLL to the desired storage location 1 and press INITIATE.
 - e. Observe the "STO Good" status message. Consult KIV-7 manual if a different status message is displayed.
 - f. Press SCROLL to display RETURN and press INITIATE to exit sub-menu.
 - g. Select KIV-7, Press ON-LINE Button, Display is illuminated and reads FDX TR. ("FDX TR" will indicate that KIV-7 has been properly configured)

NOTE: Refer to Table E-1 for a summary of KIV-7 configuration.

Table E-1 KIV-7, KIV-7HS, and KIV-7 HSB Configuration			
SETUP MENU	PARAMETER	KIV7 & KIV-7HS PARAMETER VALUE	KIV-7HSB PARAMETER VALUE
SETUP A	ClkSel	Master	Master
	SyncSel	OP2	OP2
	CommSel	FDX	FDX
	DataMod	BB	BB
	DataLen	11 Bits	11 Bits
	TxRate	9.6k	9.6k
	RxRate	9.6k	9.6k
	TTYMode	Unframd	Unframd
	I/F Ctrl	RS&CS	No Selection
	SETUP B	Invert	No Selection
TxClock		contTXC	ContTXC
RxClock		contRXC	ContRXC
SyncOOS		Disabld	Disabld
Idle Sel		Disabld	Disabld
Auto PHS		Off	Off
UpdateU		Enabled	Enabled
ClkLock		N/A	Disabld
SETUP C	Red I/F	RS-232	RS-232
	Blk I/F	EIA-530	EIA-530
	Fil I/F	102/STD	102/STD
	Fil Addr	254	254
	RCU Addr	31	31
	Display	Medium	Medium
SETUP D	Speaker	Enabled	Enabled
	MstrSlv	N/A	Slave
SEL KEY	Algrthm	N/A	Alg 1
	Key Sel	X01:000	X01:000
	RCUStat	No Setting	No Setting

E-3 SECURE VOICE UNIT

E-3.1 STE (Tactical) Configuration

1. Press the MENU button to bring up the TERMINAL MANAGEMENT option on the screen.
 - a. Press SELECT to get the NETWORK SETTINGS option.
 - b. Press SELECT.
 - i. Confirm Active Network Port is set to BDI 232, then press SCROLL.
 - ii. Press CHANGE to set STU3 Ack/Nack to DISABLED, then press SCROLL.
 - iii. Confirm STU3 Extended Timeout is set to 0, then press SCROLL 3 times.
 - iv. Confirm DCE Ready is set to Not Required, then press SCROLL.
 - v. Confirm Network Rate is set to 4.8 Kbps, then press SCROLL twice.
 - c. Press VIEW to get the TERMINAL CONFIGURATION CONTROL options.
 - d. Press SELECT.
 - i. Confirm Initial Secure Mode is set to Auto Secure, then press SCROLL.
 - ii. Confirm Remote Control is set to DISABLED, then press SCROLL.
 - iii. Confirm Card Privileges is set to ENABLED, then press SCROLL twice.
 - e. Press SECAPP to enter the SECURE ACCESS CONTROL SYSTEM.
 - i. Confirm that Secure Data Appl is set to ENABLED, then press SCROLL.
 - ii. Confirm that Secure Data ACL is set to DISABLED, then press SCROLL.
 - iii. Confirm that Secdata Max Sec and Secdata Min Sec are set to None, then press SCROLL.
 - iv. Confirm that Secure Voice Appl is set to Enabled, then press SCROLL.
 - v. Confirm that Secure Voice ACL is set to Disabled, then press SCROLL.
 - vi. Confirm that Secvoice Max Sec and Secvoice Min Sec are set to None, then press SCROLL twice.
 - f. Press SELECT to enter Speakerphone Control settings.
 - i. Confirm that Nonsecure speakerphone is Disabled, then press SCROLL.
 - ii. Confirm that Secure speakerphone is Enabled, then press SCROLL twice.
 - g. Press BACK to return to TERMINAL PRIVILEGES options.
 - h. Press SCROLL three times.
 - i. Confirm Audible Alerts is set to Enabled, then press SCROLL.
 - ii. Confirm Auto-Answer is set to Disabled, then press SCROLL.
 - iii. Confirm Data Port is set to EIA-232, then press SCROLL.
 - iv. Confirm Handset Sidetone is set to Enabled, then press SCROLL.
 - v. Confirm Ring Selection is set to Standard Ring.
 - i. Press MODE button to view terminal modes.
 - i. Press CHANGE once to set Secure Data to Synchronous, then press SCROLL.
 - ii. Press CHANGE once to set Secure Data to 4.8 Kbps, then press BACK.
 - iii. Confirm that Secure Voice is set to STE-ADPCM STU-CELP, then press SCROLL.
 - iv. Confirm that STU Mode is set to Full_Duplex, then press BACK to exit mode options.

NOTE: Refer to Table E-2 for a summary of STE (Tactical) configuration.

Table E-2 STE (Tactical) Configuration		
SETUP MENU	PARAMETER	PARAMETER VALUE
Network Settings	Active Network Port	BDI 232
	STU3 Ack/Nack	Disabled
	STU3 Extended Timeout	0
	DCE Ready	Not Required
	Network Rate	4.8 kbps
Terminal Config Ctrl	Initial Secure Mode	Auto Secure
	Remote Control	Disabled
	Card Privileges	Enabled
Secure Access Ctrl System	Secure Data Appl	Enabled
	Secure Data ACL	Disabled
	Secdata Max Sec	None
	Secdata Min Sec	None
	Secure Voice Appl	Enabled
	Secure Voice ACL	Disabled
	Secvoice Max Sec	None
Speakerphone Control	Nonsecure speakerphone	Disabled
	Secure speakerphone	Enabled
Other settings	Audible Alerts	Enabled
	Auto-Answer	Disabled
	Data Port	EIA-232
	Handset Sidetone	Enabled
	Ring Selection	Standard
Mode settings	Secure Data	Synchronous 4.8 kbps
	Secure Voice	STE-ADPCM STU-CELP
	STU Mode	Full Duplex

E-4 RFMOW MODEM CONFIGURATION AND OPERATION

E-4.1 RFMOW Modem Interface Settings

The remote interface of the RFMOW Modem must be configured prior to system operation. The following steps must be taken to access the remote interface configuration:

1. Ensure the title screen appears on the modem (The title screen will have the name of the modem and the version number of the software on it. Press the Clear button until this screen appears).
2. Press right arrow (→) five (5) times to Function Select Utility. Press Enter button.
3. Press right arrow (→) three (3) times to Utility System. Press Enter button.
4. Configure the remote interface settings as specified in Table E-3.

Figure E-3 shows the summary of the steps taken to access the configuration menu.

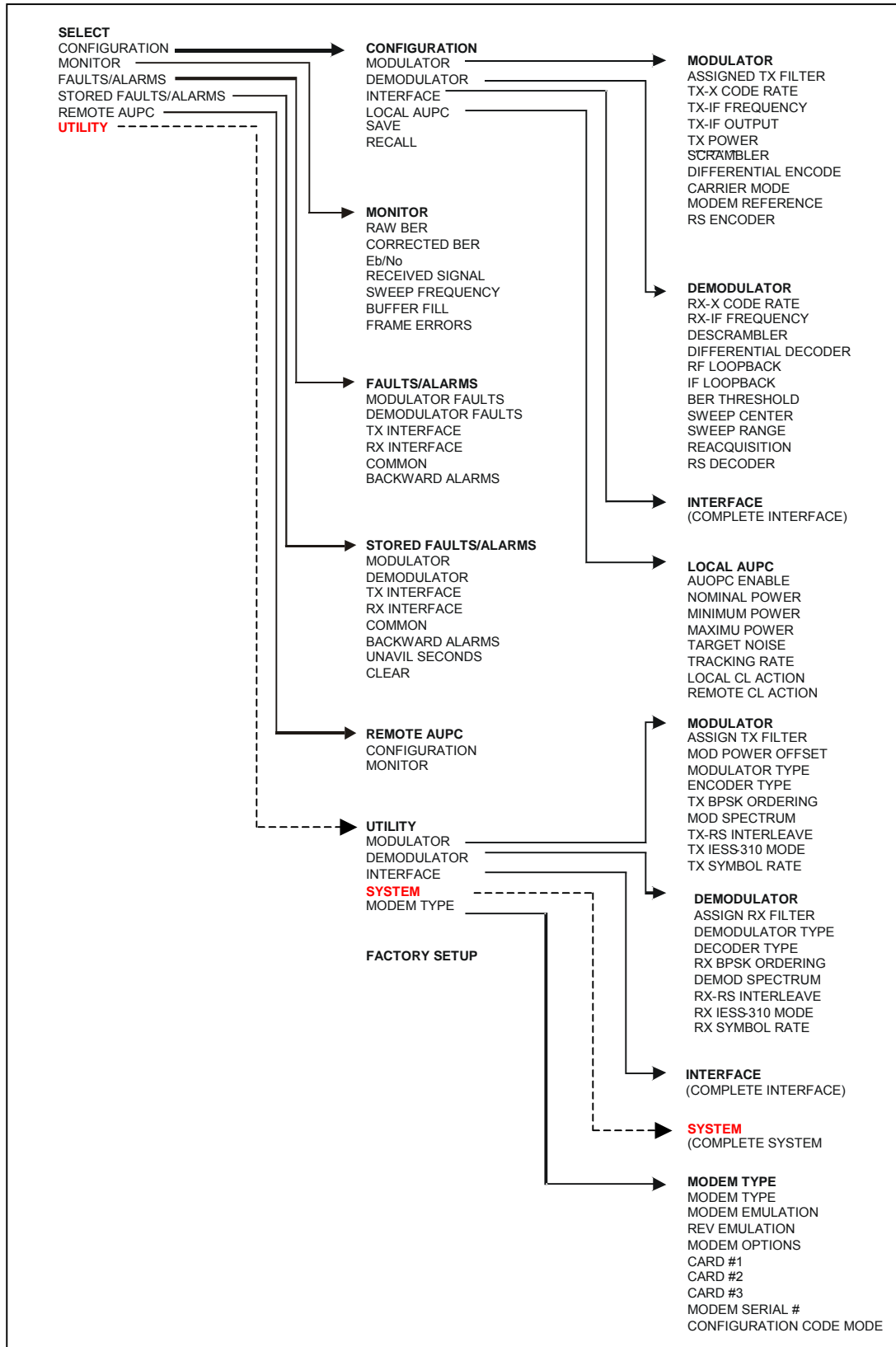

Figure E-3 RFMOW Modem Configuration Menu

Table E-3 SDM-300A Remote Interface Settings		
CONFIGURATION MENU	PARAMETER	PARAMETER VALUE
System Utility	Remote Interface Baud Rate	9600(w/CMI converter) 19200(w/Harris converter)
	Remote Interface Parity	NONE
	Remote Interface Word Length	8
	Year Display	2 Digit
	Mode of Operation	2-Wire OR 4-Wire
	Remote Interface Address	1 (Control Modem)

APPENDIX F

POWER BALANCE / ALIGNMENT PROCEDURE

F-1 OVERVIEW OF POWER BALANCE / ALIGNMENT

The RFMOW system allows tactical terminals to access the positive control network without requiring dedicated use of up and down converters. The converters that already exist in the terminal may continue to be used for both regular communications carriers and the RFMOW system at the same time. This is accomplished by balancing the communications carrier and the RFMOW carrier power levels so that they will meet the power requirements dictated by the SAA when the two carriers are combined. They are able to use the same up converter. Also the received signals must be separated after the down converter and attenuated appropriately for normal operation.

This section provides step-by-step procedures to perform the power balancing/alignment for RFMOW terminals.

F-2 THE ALIGNMENT PROGRAM

The alignment program has been developed to automate and simplify the power balancing/alignment process. This process must still be performed long before the terminal will be required to perform an RFMOW mission because the terminal operator will need to calibrate and characterize the terminal equipment.

F-3 ALIGNMENT PROCEDURE FOR THE AN/TSC-85D(V)1 AND AN/TSC-93D(V)1

Performing the alignment.

NOTE: If the measured output power of the L3 MD1340 modem, the measured gain of the up converter, and the measured gain of the klystron are not available, they should be measured prior to beginning this alignment procedure. Default values for a well calibrated terminal are available in the alignment program and may be used. However, the default power levels should be used with the understanding that the attenuator settings derived from the alignment may result in the incorrect power level of a communications carrier (carrier being much higher or lower than the predicted power level) or the incorrect power level of the RFMOW orderwire carrier, which will prevent the terminal from logging into the RFMOW network.

1. To begin the alignment procedure, select Start=>Programs=>JSEC=>TSC-85 and 93 Server from the bottom left-hand side of the Windows display of the RFMOW terminal. The user will be prompted for a user name and a user password to log-in. After successful login, the Server screen will be displayed. See Figure F-1

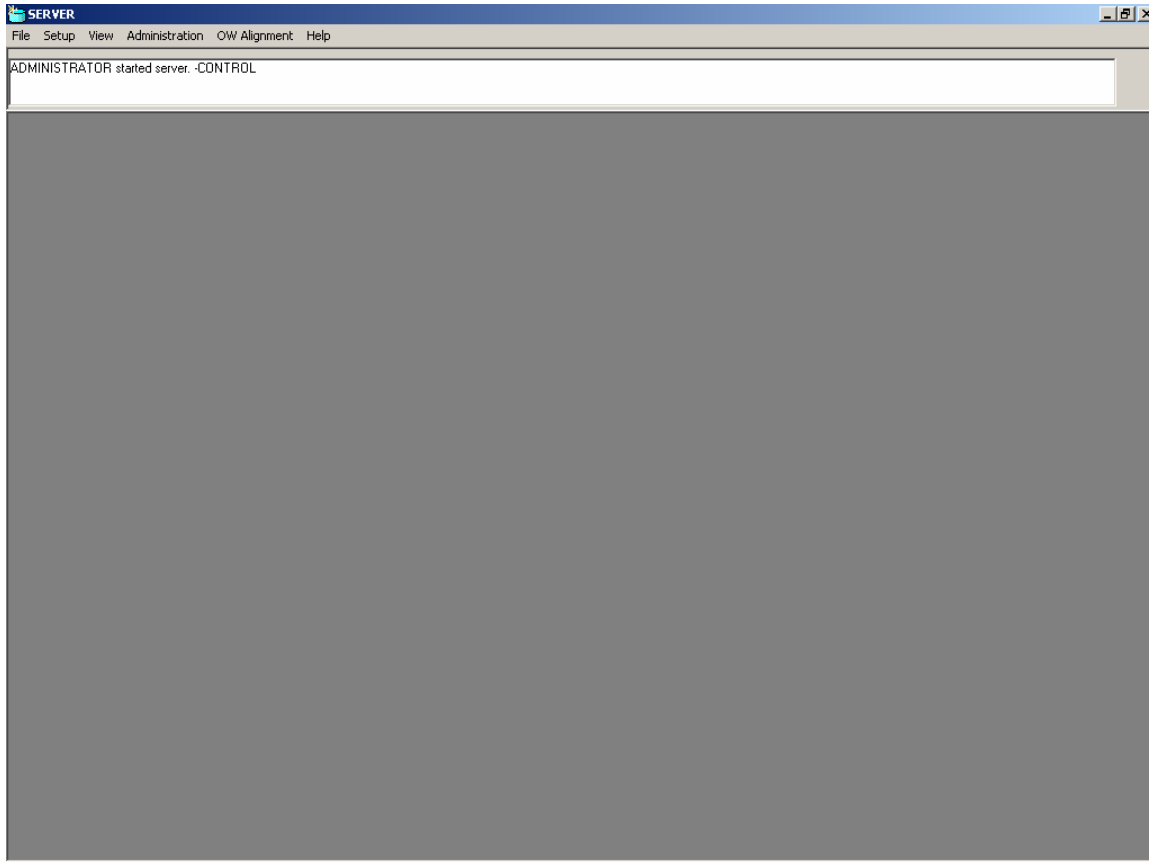

Figure F-1 Server Screen

2. Select Menu=>OW Alignment. This will bring up the TSC 85/93 Terminal D RFMOW Alignment screen. See Figure F-2.

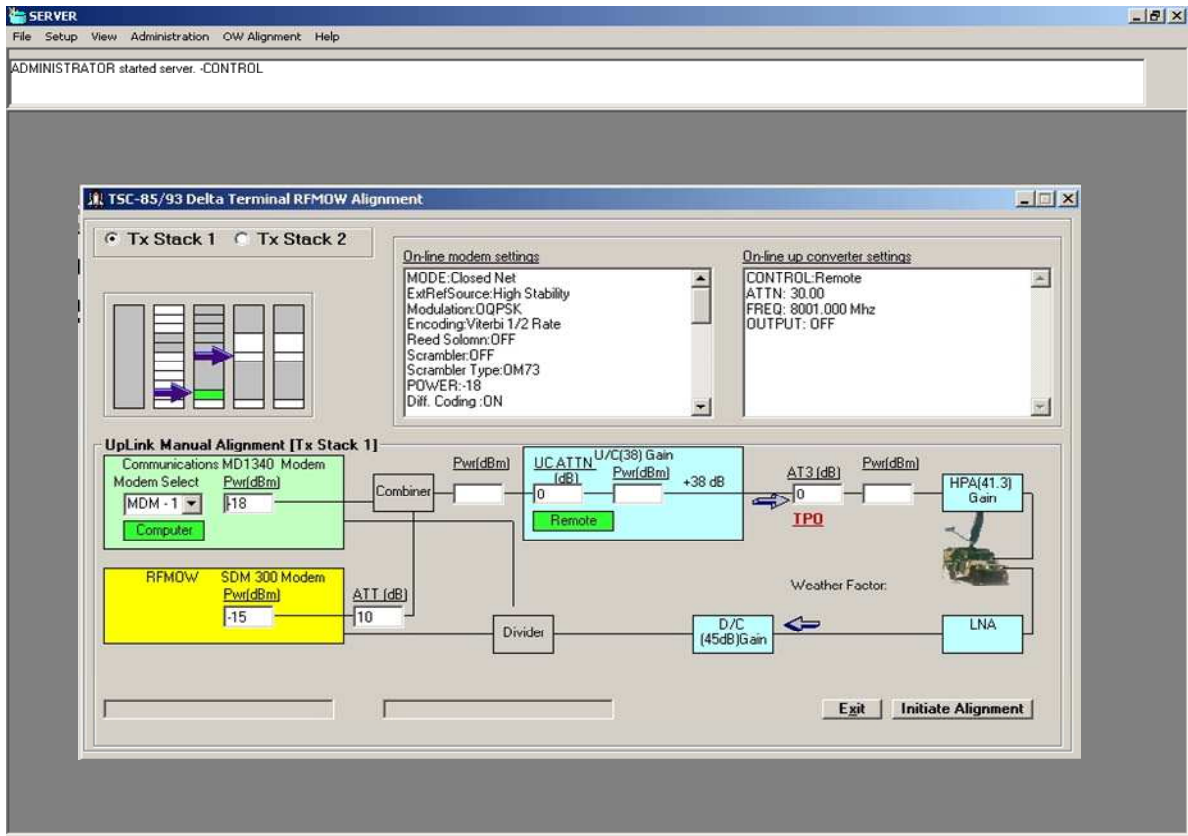

Figure F-2 AN/TSC-85D(V)1 and AN/TSC-93D(V)1 RFMOW Alignment Screen

3. Select Menu=>Setup=>System Values. This will display the System Values screen. See Figure F-3.

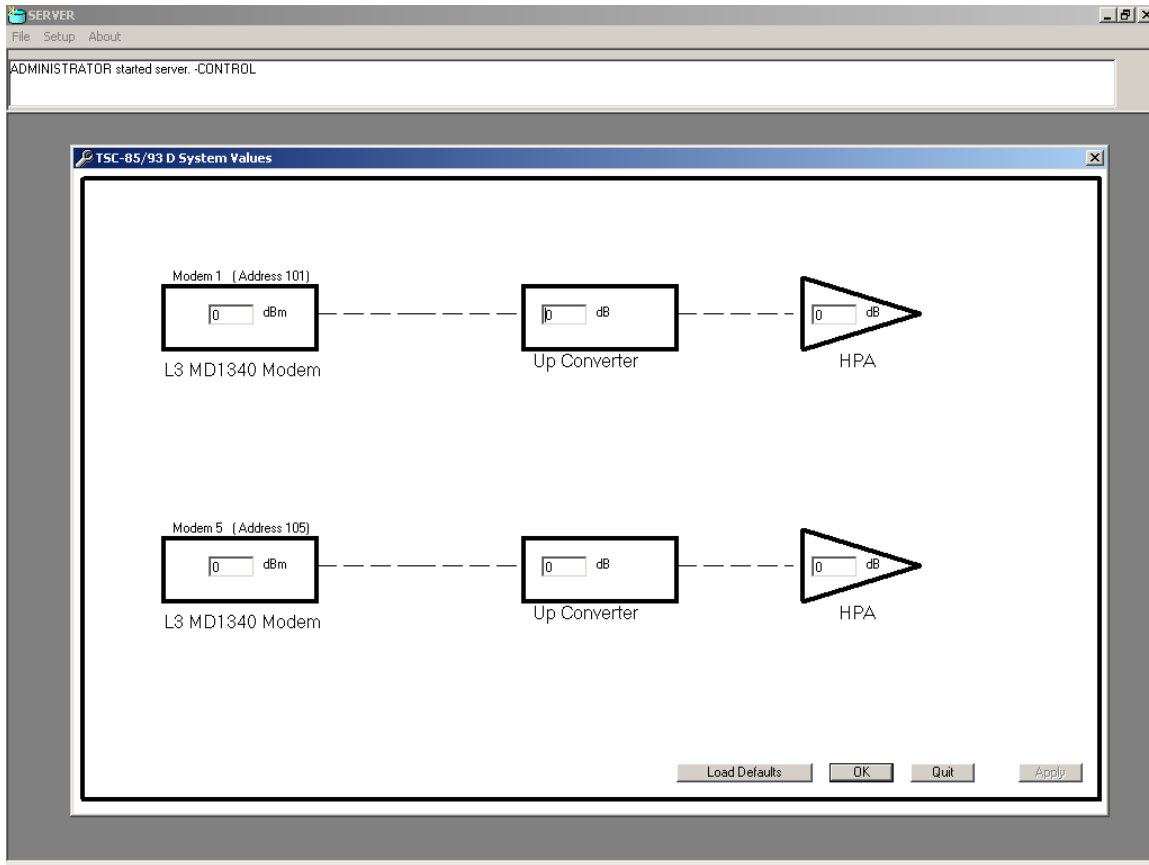

Figure F-3 System Values Screen

4. Enter the measured values for the L3 MD1340 modem, the measured gain of the up converter, and the measured gain of the klystron in the appropriate fields.

NOTE: If the actual measured values are not available, select the Load Defaults button to load default values that will successfully align a terminal whose equipment is close to specification values.

5. Click OK to save the equipment values. A window will appear stating that the application will have to be restarted to continue the alignment.
6. Select OK and the alignment program will close.
7. Once again, start the RFMOW Alignment program by selecting Start=>Programs=>JSEC=>TSC-85 and 93 Server from the bottom left-hand side of the Windows display of the RFMOW terminal. The Server screen will be displayed.

8. Ensure that the appropriate Side 1 or Side 2 is selected and the Up-Converter in that position is set for Remote Control. See Figure F-4.

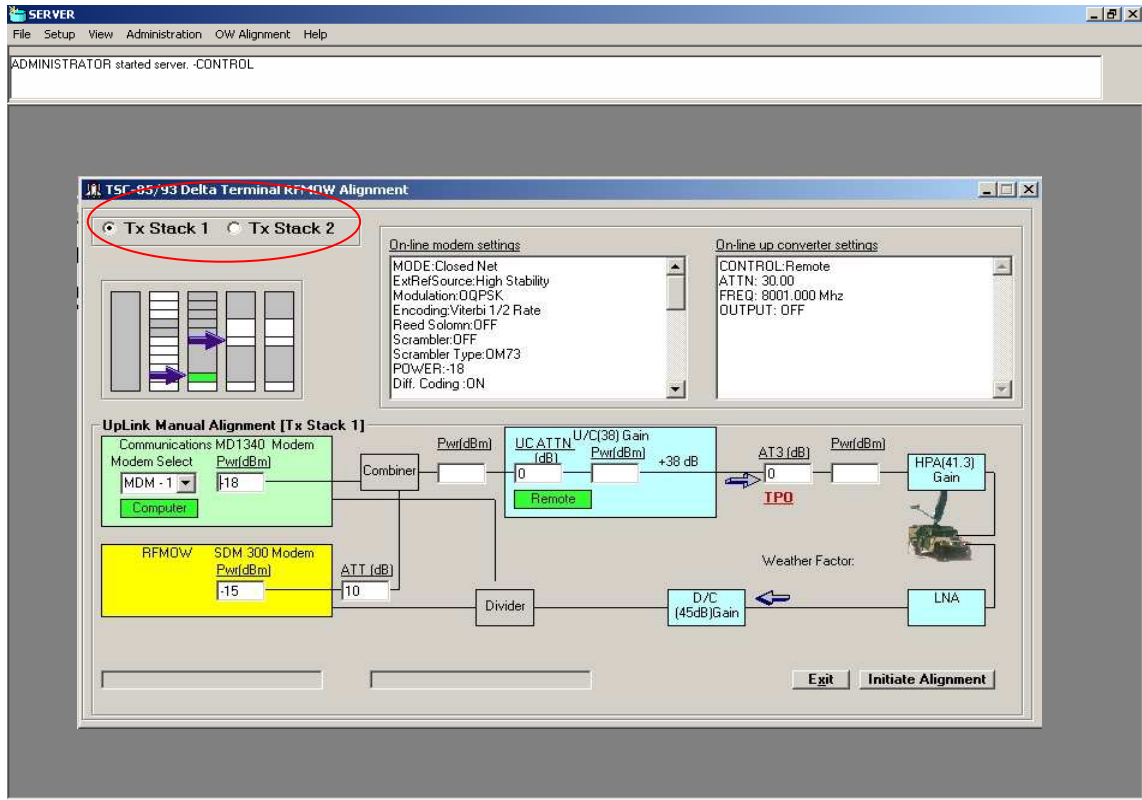

Figure F-4 U/C Converter Selection

9. Select the appropriate MD1340 communications modem by selecting it from the drop-down menu. Ensure that the selected modem is set for Remote Control. See Figure F-5.

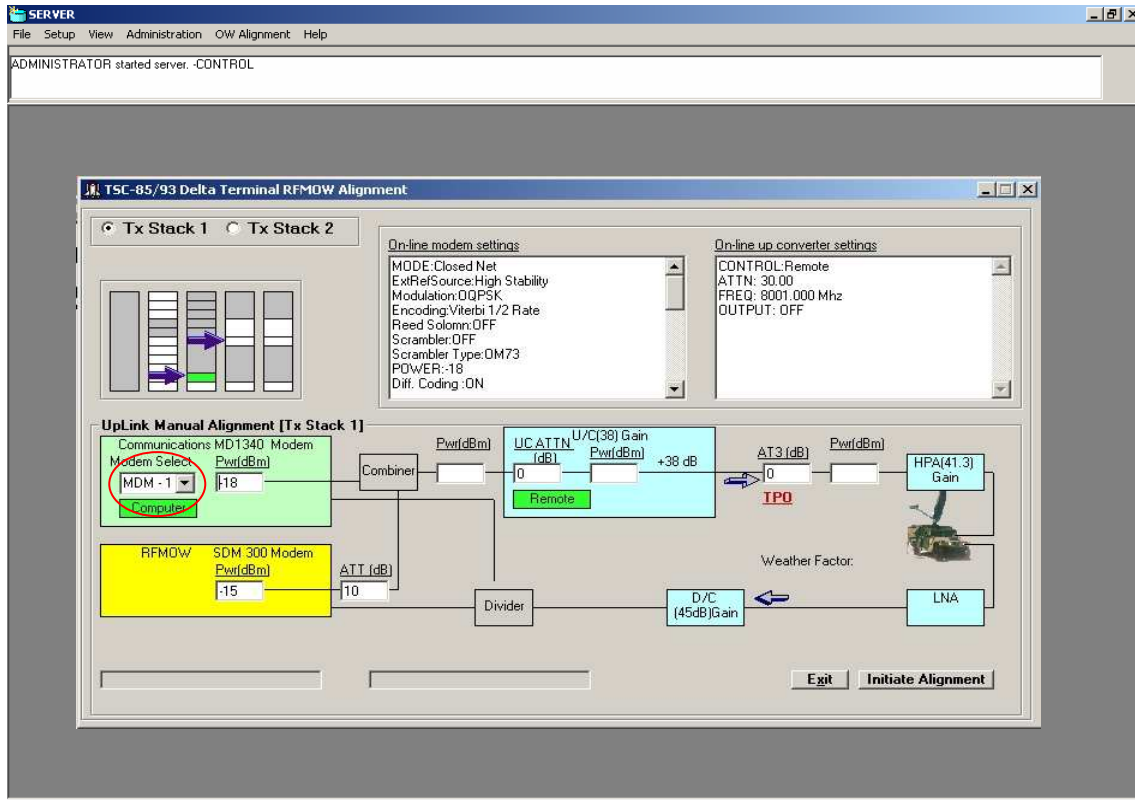

Figure F-5 MD1340 Communications Modem Selection

10. Select Menu=>OW Alignment. This will bring up the TSC 85/93 Terminal D RFMOW Alignment screen.
11. At the bottom right of the TSC-85/93 Delta Terminal RFMOW Alignment window select the Initiate Alignment button. This will begin the wizard to guide you step by step though the rest of the alignment procedure.
12. The first dialog displayed will be the Communications Link Power dialog. See Figure F-6. Enter the predicted communications link power from the SAA and click OK to continue.



Figure F-6 Communications Link Power Dialog

- Next the Weather Handicap dialog will be displayed. See Figure F-7. Enter the current weather conditions at your terminal and click OK to continue.

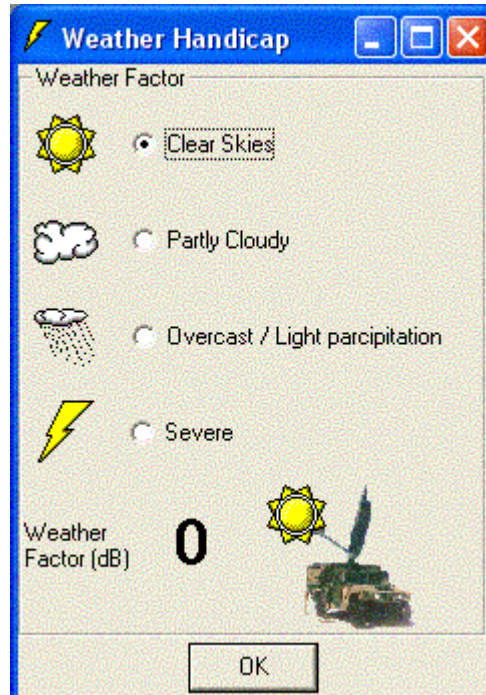

Figure F-7 Weather Handicap Dialog

- Next the Orderwire Link Power dialog will be displayed. See Figure F-8. Enter the predicted orderwire link power from your SAA and click OK to continue.

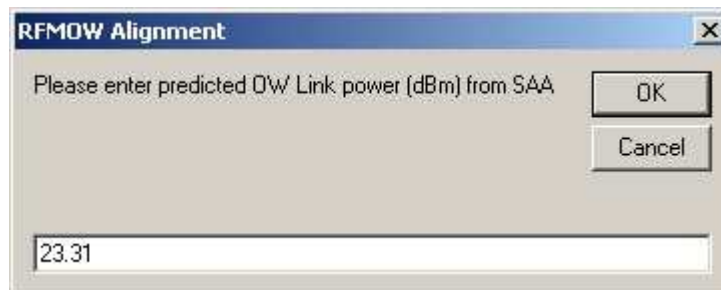

Figure F-8 Orderwire Link Power Dialog

15. Next a Message dialog will be displayed. See Figure F-9. Read the instructions carefully on each message dialog and perform the actions requested. Click the Next button to continue.



Figure F-9 Message Dialog

Step 1: Please ensure TRANSMITTER is in STANDBY.

The toggle switch on the L3 HVPS must be set to STANDBY. This is to ensure that no spurious signals will be transmitted to the satellite.

Step 2: Please ensure the MD1340 TRANSMIT ON indicator is EXTINGUISHED.

This is to ensure that the orderwire signal and not the communications carrier will be the first signal transmitted to the satellite.

Step 3: Now that we are safe, point the antenna to your spacecraft.

If the antenna was not already pointed to the spacecraft, this is the time to do it. Use the look angle from the SAA to assist you in locating the correct satellite.

Step 4: Tune Up Converter and Down Converters as specified by SAA.

Since the communications carrier and the orderwire carrier use the same Up and Down Converter, the frequencies to input are the communications transmit and receive frequencies from the SAA. The RFMOW orderwire modem will automatically be set to an offset value so that both modems can use the same Converters.

Step 5: Start RFMOW software desktop.

Enter network data to include converter frequencies, network and subnet ID as specified by SAA into RFMOW desktop as prompted.

If you are unsure what these values are, consult with your higher Headquarters or Satellite Controlling Authority.

Please refer to Chapter 4, section 4.2 of this document for assistance in navigating the RFMOW screens. Also please refer to Chapter 5 of this document for assistance in troubleshooting problems that may arise.

Step 6: Ensure RFMOW demodulator indicates 'carrier detect'. If not, check your D/C.

This is the Carrier Detect lamp on the front of the orderwire modem. It will probably be an SDM-100/300A. If there is no carrier detect, check the RFMOW software configuration to ensure that the FOW frequency is correct and the Down Converter frequency is correct. Then check the Down Converter to ensure that the setting is correct. If there is still no carrier detect, the most common cause is the antenna is pointed at the wrong satellite.

Step 7: Ensure KIV-7 encryption is on key and update specified by COMSEC callout message.

One of the most common reasons for terminals being unable to join the RFMOW network is incorrect keying material.

Step 8: Observe RFMOW desktop software RSL to indicate between -30 and -50 dBm.

The RSL indicator for the FOW is at the top of the RFMOW PC/Controller screen as shown in Figure F-10.

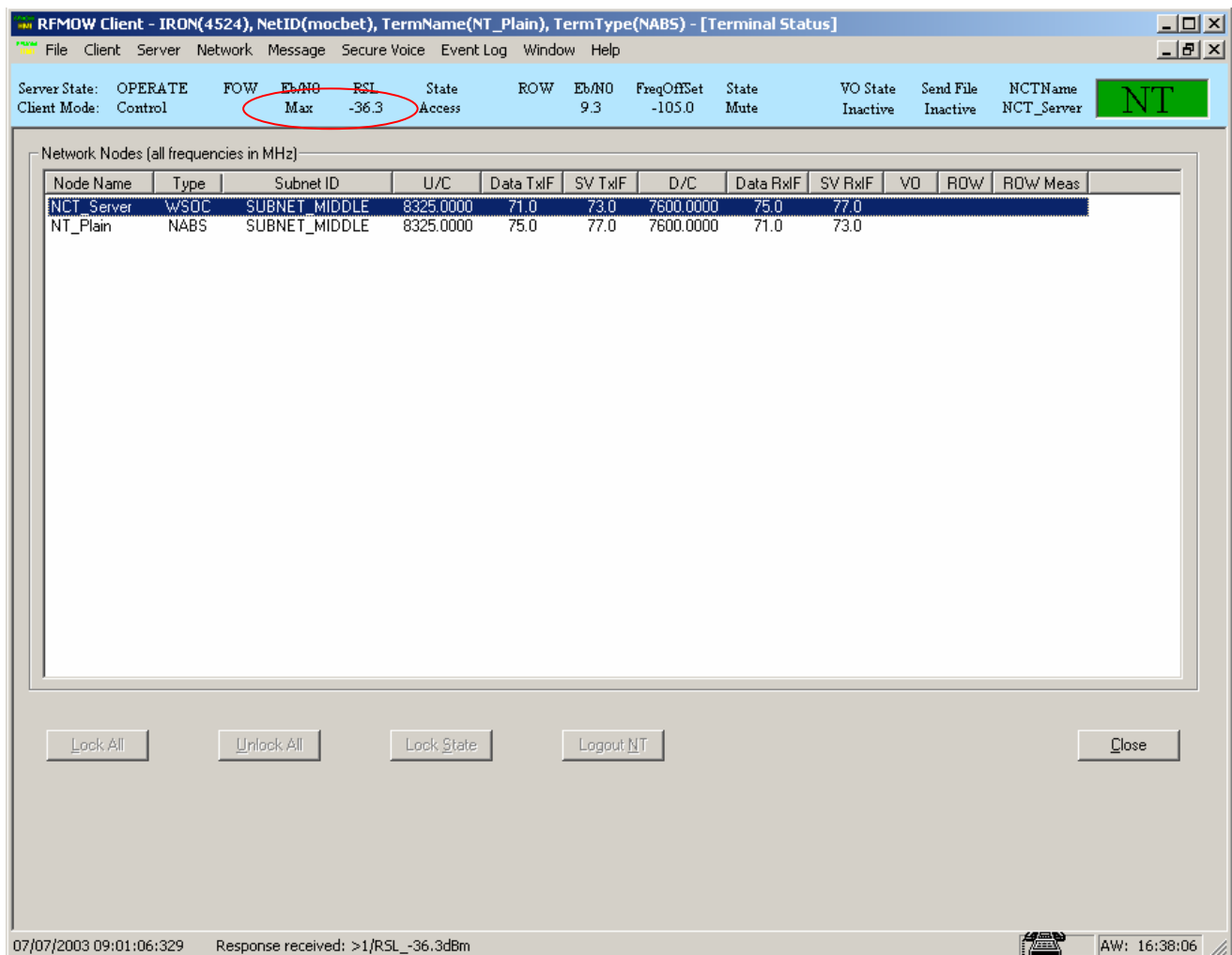

Figure F-10 RSL and Eb/No Level Indications

Step 9: Once the NCT FOW is recognized by the RFMOW desktop, set the RFMOW output attenuator as currently shown in the alignment diagram. See Figure F-11.

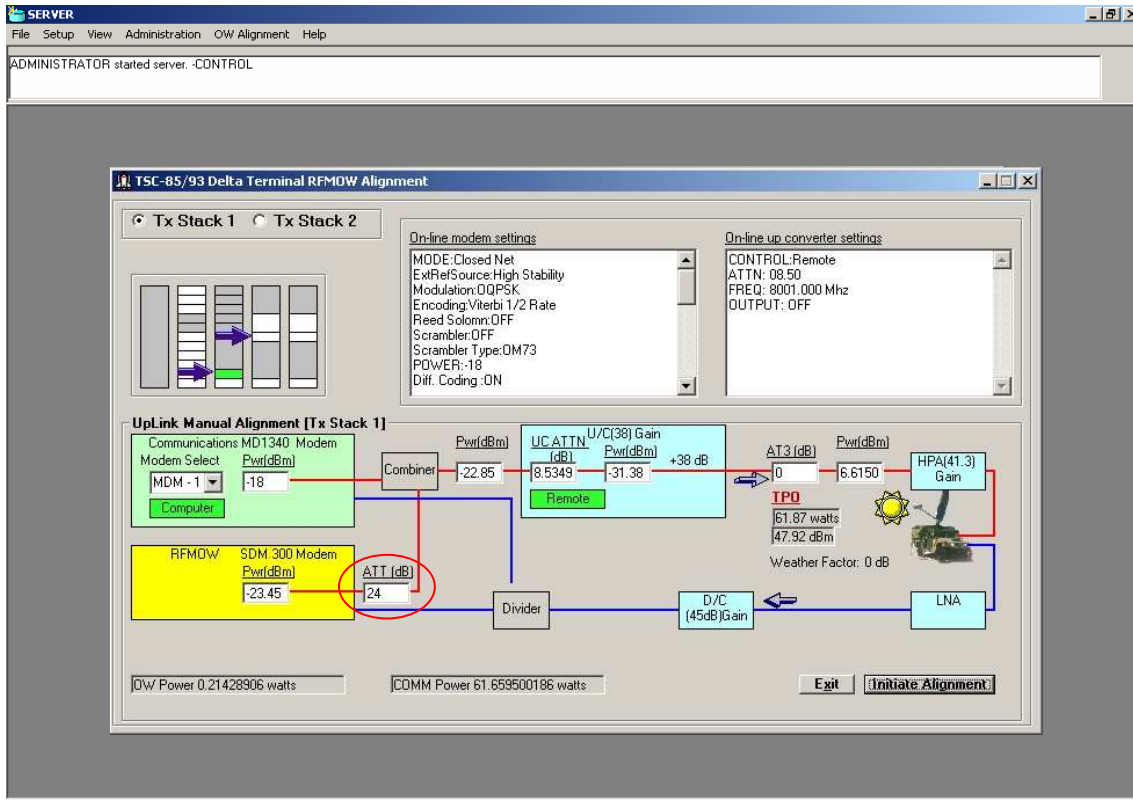

Figure F-11 RFMOW Output Attenuator

Step 10: Place transmitter into operate. Ensure transmitter output is directed to the antenna and not the dummy load.

The RFMOW orderwire modem will not attempt to transmit at this time until login is selected at the RFMOW desktop and the NCT (GMF Controller) opens an access window to allow terminals to content for access to the network.

Step 11: Attempt to log on to RFMOW network.

This is done by selecting Menu=>Network=>Login at the main menu of the RFMOW desktop. The orderwire modem will still not transmit until commanded to do so by the NCT. Watch the RFMOW orderwire modem. If the transmit light goes on, then a message window should appear on the RFMOW desktop informing the terminal operator that a terminal has just been granted the ROW.

Step 12: If successful, request permission to access comm carrier. If not successful, check attenuator settings and uplink path.

See step 11 above. If successful, the operator should request a secure voice call on the RFMOW desktop. Then real time feedback will be available from the NCT regarding the establishment of the communications carrier.

Step 13: If access to your comm carrier is granted, enable your MD1340 Transmit.

Step 14: Now, while observing the Klystron power meter, slowly decrease attenuation on U/C. When the SAA predicted comm power is reflected on Klystron meter, coordinate final adjustments with control facility.

Step 15: Check with the control facility via the RFMOW for adjustment. Click the Finish button to close the Message dialog.

This page left blank intentionally.

APPENDIX G

RFMOW SOFTWARE OPERATION

G-1 OVERVIEW OF TERMINAL INITIALIZATION

This paragraph provides step-by-step procedures to power up the equipment and conduct normal network operations. If the equipment is being started for the first time, then all initial operating parameters will have to be provided. If the equipment has been previously powered up, then most of the basic operating parameters have been saved to the PC/Controller hard disk. In either case, the power up procedure involves three steps: applying equipment power and starting the RFMOW software in the PC/Controller, entering (or confirming) basic network data via the Initialization Screen, and configuring (or confirming) the set-up of the terminal via the Power and Frequency Configuration Screen.

G-2 CONTROL CIRCUIT CONFIGURATION

The link characteristics required to configure the control circuits (both the FOW and ROW) are internally stored in the RFMOW software. These values are not expected to change over the lifetime of the RFMOW. Fundamentally, both the FOW and ROW are operated as simplex links between the NT and the NCT. These two links are characterized as Binary Phase Shift Keying (BPSK) modulated, 1/2 rate Viterbi encoded/decoded, scrambled, at a data rate of 9.6 Kbps.

G-3 POWER UP

The following sub-sections present the detailed steps on how to initialize the terminal through the software screens.

Table G-1 NT Power Up	
1	Turn on the power to the Up Converter, Down Converter, Computer, and Interface Unit. Also ensure that power is connected to the KIV-7 and the orderwire modems. The order in which power is applied to the equipment is not significant. For computer login information consult the site's system administrator.
2	Ensure that the current key is loaded into the KIV-7. See the Embeddable KG-84 COMSEC Module (KIV-7) User's Manual or the COMSEC manager for more information on loading the KIV-7.
3	If the KIV-7 has not been used with RFMOW previously or if the settings have changed, then verify the settings per Appendix E. See the Embeddable KG-84 COMSEC Module (KIV-7) User's Manual or the COMSEC manager for more information on configuring the KIV-7.
4	Enter the Communications Carrier (uplink) frequency from the SAA for this terminal into the Up Converter that will be shared with RFMOW.
5	Enter the Communications Carrier (downlink) frequency from the SAA for this terminal into the Down Converter that will be shared with RFMOW (Default setup for the AN/TSC-85D(V)1 and AN/TSC-93D(V)1 have D/C 1 already cabled in).
6	If the orderwire modem has not been used with the RFMOW, ensure it is configured (Under the System=>Utilities menu from the front panel of the SDM-300A) as follows: a. REMOTE BAUD RATE: 9.600 bps NONE b. REMOTE ADDRESS: 1 c. REMOTE TYPE: RS485 (2 WIRE)
7	If the Secure Voice Unit has not been used with the RFMOW or if the settings have been changed, verify the configuration per Appendix E.
8	Perform the Alignment Procedure (see Appendix F). The Alignment Procedure will instruct the operator to perform some operations that are included in subsequent paragraphs of this chapter.
9	When prompted to do so by the Power Balance/Alignment procedure, attempt to log on to the RFMOW computer in accordance with the Unit's SOP

Table G-2 Executing the RFMOW Server and Client	
1	Double-click the RFMOW Server Icon on the desktop. The Server screen will be displayed (See Figure G-1).
2	Double-click the RFMOW Client Icon on the desktop. The Connect to Server screen will be displayed (See Figure G-2).
If the Icons are not located on the Desktop take the following steps:	
1	Select Start at the bottom left of the Microsoft Windows desktop.
2	Select Programs=>RFMOW=>RFMOW Server. The Server screen will be displayed (See Figure G-1).
NOTE: Item 3 below can be executed on the same computer as the Server or on a computer connected to the Server via a network.	
3	Select Start=>Programs=>RFMOW=>RFMOW Client. The Connect to Server screen will be displayed (See Figure G-2).

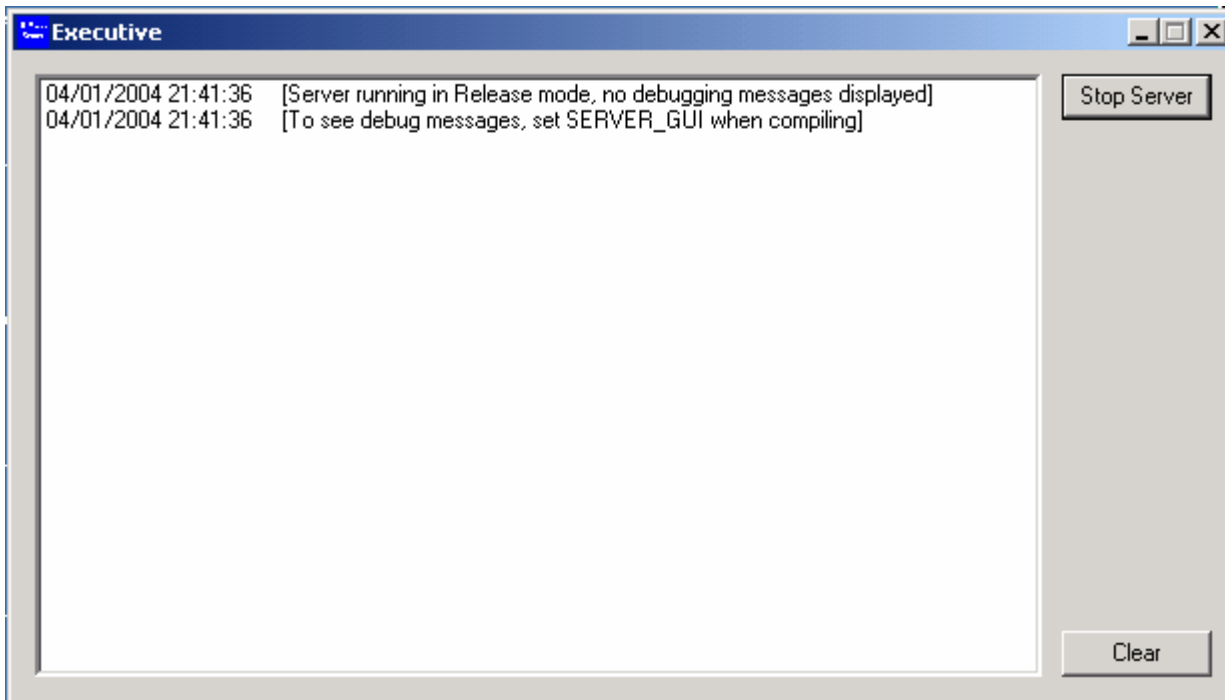

Figure G-1 Server (Executive) Screen

WARNING: DO NOT CLOSE THE EXECUTIVE WINDOW AT ANY TIME DURING NORMAL OPERATIONS. If desired, the window may be minimized using the minimize button at the top right-hand of the screen (i.e. the underscore _ button).

G-3.1 Connect to Server

The first screen the operator will encounter when starting the client software is the Connect to Server Screen (see Figure G-2). This screen allows the operator to specify which server to connect to as well as specifying the Client ID. The following are the list of items that must be entered or verified.

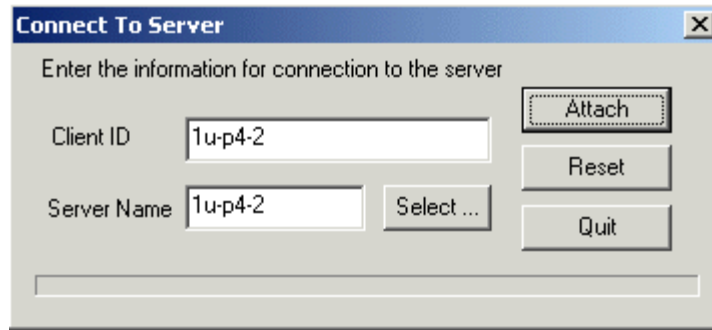

Figure G-2 Connect to Server Screen

- Client ID: A name to identify the client when multiple clients are present. The Full Computer Name will be filled in automatically by the RFMOW software.
- Server Name: This is the name of the server to which the operator will connect. If the server resides on the same machine then 'localhost' is an acceptable entry.

Table G-3 Connect to Server	
1	If the name of the computer hosting the Server is displayed in the Server Name area, proceed to step 2. Otherwise, choose Select and double click on the RFMOW Server displayed. The Server and the Client may reside on the same computer.
2	Select Attach to attach the Client to the Server. The Network and Terminal Identification Information screen will be displayed (see Figure G-3).
NOTE: Click the Quit button to close the Connect To Server screen without attaching to the server.	

G-3.2 Initialization

The next screen the operator will encounter when starting the software is the Network and Terminal Identification Information screen (see Figure G-3). Following the procedures is the list of items that must be entered (or verified if the items are being defaulted to data stored in an existing configuration file).

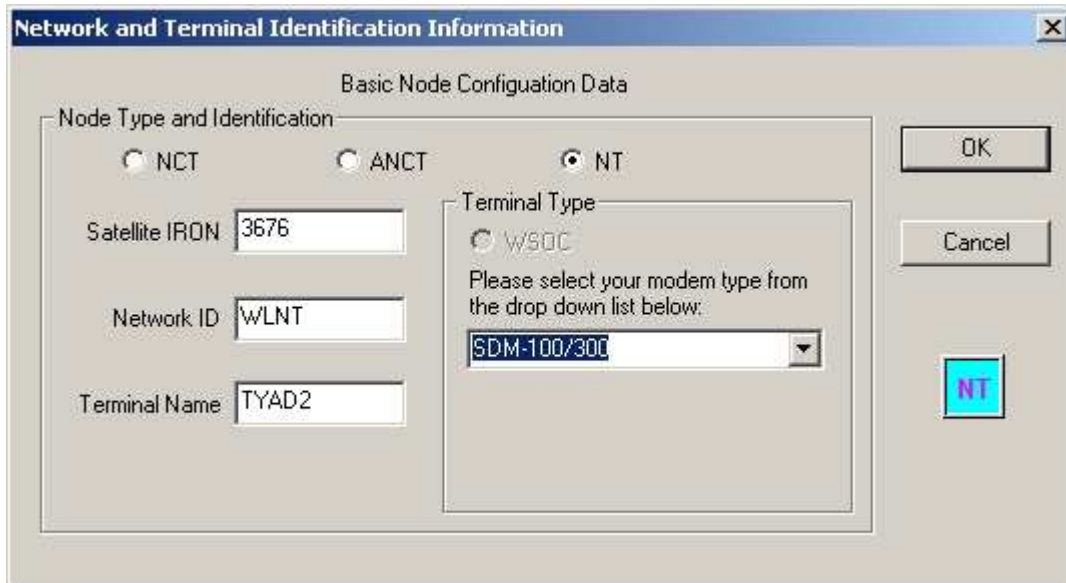

Figure G-3 NT Network and Terminal Identification Information Screen

- Node Type and Identification: The mode selected must be compatible with hardware installed at the node in order to complete the hardware initialization successfully. The term 'Node' is used here and throughout this document to describe an RFMOW terminal/server of any type (e.g. NCT, ANCT, or NT).
- Terminal Type: Enter the modem type using the drop-down menu. For the AN/TSC-85D and 93D the "SDM-100/300" selection will be used.
- Satellite IRON: The satellite IRON is a 4 digit number used by the network.
- Network ID: This is a string up to 10 characters long. This ID is found on the SAA immediately after the IRON (e.g. EPAC, WPAC, etc).
- Terminal Name: This is a name up to 10 characters long. The name should begin with a letter; the remaining nine characters can be numbers, letters, or a dash (-). This usually will be provided in the SAA.
- Blue-ish colored square in the lower right-hand corner indicates how the software was installed on the PC/Controller. This square should indicate "NT" for the AN/TSC-85D(V)1 and AN/TSC-93D(V)1 **AT ALL TIMES.**

Table G-4 Basic Node Configuration.	
1	Select the Node Type (NT) by clicking the corresponding radio button at the top of the screen.
2	Select the Terminal Type modem selection (SDM-100/300 for the AN/TSC-85D and 93D)
NOTE: Since the Node Type selected is NT, then AN/TSC-152 AND AN/USC-59 and AN/TSC-85D(V)1 AND AN/TSC-93D(V)1 are the only Terminal Types allowed. If the orderwire modem is an SLM-8650, select AN/TSC-152 AND AN/USC-59, otherwise select AN/TSC-85D(V)1 AND AN/TSC-93D(V)1 regardless of terminal type.	
3	Enter the Satellite IRON, Network ID, and Terminal Name from the SAA.
4	Click the OK button. The RFMOW software will perform a diagnostic of the RFMOW hardware.
5	If this diagnostic is successful, the "Power and Frequency Configuration" screen will be displayed (see Figure G-5). Otherwise, the RFMOW Error dialog will be displayed (see Figure G-4). Proceed to Hardware Test Diagnostics, paragraph 4.2.3.3.
NOTE: To close the Network and Terminal Configuration Information screen without saving changes, Click the Cancel button.	

G-3.3 Hardware Test Diagnostics

After the Network and Terminal Identification Information Screen is closed, software will then execute a series of built in hardware diagnostic tests to make sure that all hardware required for the selected terminal type is present and functional.

If hardware is missing, not powered on, or fails to respond to a diagnostic command (e.g.- improper configuration on the SDM-300A), a popup dialog similar to Figure G-4 will be presented to the operator indicating which hardware failed its diagnostic tests. Proceed to Chapter 3 for Troubleshooting.

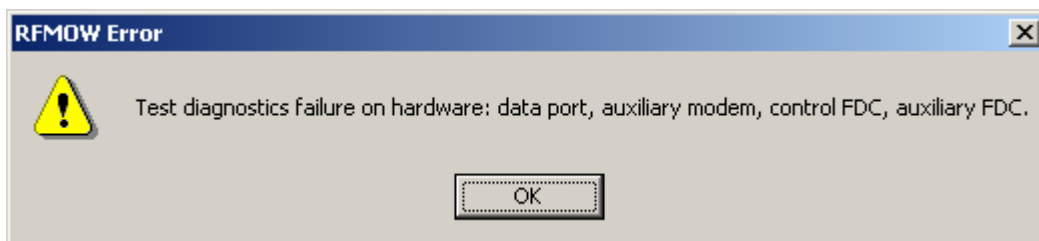

Figure G-4 Hardware Diagnostic Error Dialog

G-3.4 Power and Frequency Configuration Screen

The next screen the operator will encounter when initializing the software is the Power and Frequency Configuration Screen.

For an AN/TSC-85D(V)1 AND AN/TSC-93D(V)1 terminal type, the Power and Frequency Configuration Screen (see Figure G-5) will be displayed. Table G-5 lists the names of the data entry fields on the screen, and the definitions and valid ranges, for the data.

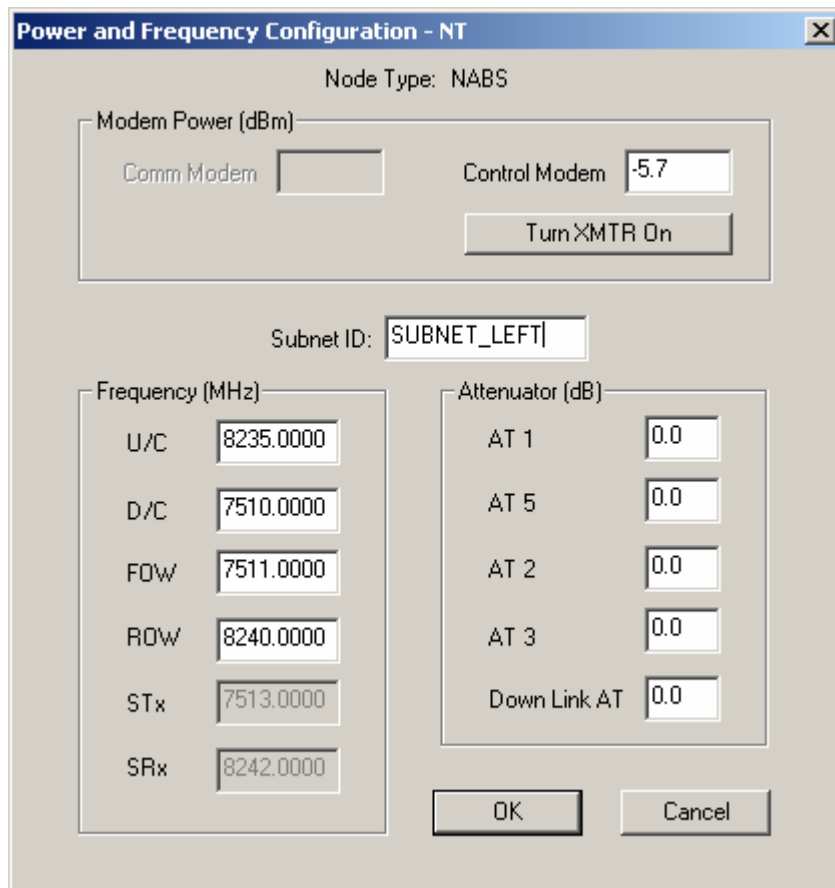

Figure G-5 AN/TSC-85D(V)1 and AN/TSC-93D(V)1 Power and Frequency Configuration Screen

Table G-5 Power and Frequency Configuration Screen Value Ranges		
PARAMETER	DEFINITION	RANGE
Subnet ID	Subnet Identification	1-15 characters
Frequency: U/C	Up converter frequency	7900 to 8400 MHz
Frequency: D/C	Down converter frequency	7250 to 7750 MHz
Frequency: FOW	FOW receive frequency	7250 to 7750 MHz
Frequency: ROW	ROW transmit frequency	7900 to 8400 MHz
Modem Power: Control Modem	Control modem output power	-30 to -5 dBm
Attenuator: AT1	Attenuator	0 to 70 dB
Attenuator: AT2	Attenuator	0 to 70 dB
Attenuator: AT3	Attenuator	0 to 70 dB
Attenuator: AT5	Attenuator	0 to 70 dB
Attenuator: Down Link AT	Attenuator	0 to 60 dB

The Turn Modem XMTR On/Off button is provided to allow the operator to manually verify that the required control power will be achieved before attempting to enter the network. **WARNING:**

Output of the terminal **MUST** be directed toward dummy load, and not toward the satellite, before the operator may click this button. To verify the control link, set Ctrl Modem Pwr in the Ctrl Modem PWR entry field. Then click the Turn Modem XMTR On button. This will turn on the control modem (The button will now read Turn Modem XMTR Off). Proper control link power can then be verified by measuring the link power at an appropriate point in the terminal transmit chain, or by measuring the link power using a spectrum analyzer if the link is being transmitted to the satellite. The link power can be changed by entering a new Ctrl Modem PWR value and again pressing Set Ctrl Modem Pwr. The Turn Modem XMTR On button is a toggle, and will now show Turn Modem XMTR Off. Press the button again to turn the control link off. See Appendix F for detailed procedures for setting AN/TSC-85D(V)1 AND AN/TSC-93D(V)1 communications and control links.

Table G-6 Power and Frequency Configuration	
WARNING: Pressing Turn Modem XMTR On will cause the control modem to transmit a 9.6 kbps scrambled carrier at the ROW frequency. Ensure that the terminal antenna is not pointing at a satellite or that the terminals transmit path is connected to a dummy load.	
1	Whenever the server application is restarted, Control Modem power value is always reset to the default of -15dBm. This ensures that the modem power is set to the value expected when the power balancing/alignment procedure is performed and not some other value that may prevent the terminal from entering the network. Change this value only if instructed to do so.
2	Enter the Subnet ID, the U/C frequency, the D/C frequency, the FOW frequency, and the ROW frequency from the SAA.
NOTE: The secondary receive and secondary transmit frequencies (SRx and STx) will automatically be filled in when the FOW is received and cannot be entered by the NT operator. SRx and STx are named from the point of view of the NCT, so SRx is actually the secondary frequency that the NT will transmit at and STx is the secondary frequency that the NT will receive at.	
3	If the Attenuator values are known from the power balancing procedure, (see Appendix F), enter the values into each field, otherwise proceed to step 4.
NOTE: The five (5) fields in the Attenuator (dB) window are only placeholders and are not used in any calculations. They are also not used to automatically configure any equipment. They are a place for the terminal operator to store the settings of the attenuator panel and the attenuator on the front of the klystron. Then they may be retrieved from this screen if needed to reset the panel to known working values. They can be left blank until after a successful power balancing/alignment is performed, but must be filled in at a later time.	
4	If all power, frequency, and subnet information is correct, select OK to continue. A hardware configuration diagnostic will be performed.
5	If the diagnostic is successful, the "NT PC/Controller" screen will be displayed (see Figure G-9). Otherwise, proceed to Chapter 5, Maintenance & Troubleshooting

G-3.4.1 Hardware Initialization Error Dialog

When the OK button is clicked on the Power and Frequency Configuration screen, the configuration information will be used to initialize the RFMOW hardware. If the initialization is successful, the configuration information is saved. The main screen will be displayed. If any error should occur, an error screen similar to Figure G-6 will be displayed. The message in the error screen will explain the general nature of the problem.

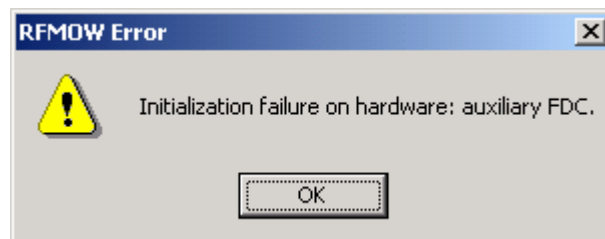

Figure G-6. Hardware Initialization Error Dialog

G-3.5 Main Menu

The Main Menu (Figure G-7) is the starting point from which the operator can access the functions of RFMOW. The operator can select the functions of RFMOW through the menu bar by using the mouse or using the <Alt> key + the accelerated letter key can accomplish the same thing. Some menu items will automatically be enabled and disabled depending on the configuration and current state of the terminal. Table G-7 provides an explanation of the available functions that the operator will find on the menu bar.

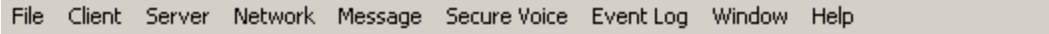

Figure G-7 Main Menu

Table G-7 Main Menu Functions	
MENU ITEM	ACTION
File: New	Allows the operator to create a new text document in a notepad window
File: Open...	Allows the operator to open a text file in notepad
File: Print Setup...	Opens the windows interface for printer settings
File: Send File...	Allows the operator to send a file via the RFMOW network
File: Cancel Send File	Allows the operator to cancel the ongoing sending of a file
File: Retrieve File...	Allows the operator to retrieve a file from the server and save it on the local computer. This function is necessary when the RFMOW Client does not reside on the same computer as the RFMOW Server.
File: Exit	Allows the operator to exit from the client
Client: Attach to Server	Allows the operator to attach to a server
Client: Detach from Server	Allows the operator to detach from a server
Client: Handover Server Control	Allows a control client to handover server control to a monitoring client
Client: Request Control	Allows monitoring operator to request server control from the control client
Server: Basic Configuration	Allows the operator to view the basic configuration when Server State is in Standby (Network and Terminal Identification Information screen)
Server: Detailed Configuration	Allows the operator to view and make changes to the Power and Frequency Configuration screen when Server State is in Standby.
Server: Disable Audio Alarm	Allows the operator to disable the audio alarm, this command will toggle between disable and enable depending on the current state
Server: Enable Debug Logging	Allows the operator to enable logging of debugging log messages, this command will toggle between disable and enable depending on the current state. Enable will cause a large amount of information to be continually stored to the hard drive. This can be very useful for troubleshooting, but should be set to disable for operation under normal conditions.

Table G-7 Main Menu Functions	
MENU ITEM	ACTION
Server: Send HW Command	Allows the operator to send raw commands to the modems. The NCT may issue commands to the modems of any terminal in the network, but NTs may only issue commands that affect their own modem. NTs may also query information from any modem in the network.
Server: Built-in Tests	Allows the operator to test the hardware individually or all at once
Server: Stop Server	Allows the operator to bring the server down
Network: Login	Allows the operator of an NT to login to the network
Network: Login Cancel	Allows the operator of an NT, that is waiting to login, the ability to cancel the login request
Network: Logout	Allows the operator of an NT to send a logout request to the NCT
Network: Status: Terminal	Allows the operator to view a summary of network nodes logged into the network
Network: Status: Link	Allows the operator to view the status of the FOW and ROW links and initiate actions on changing the parameters of the links
Network: Packet Statistics	Allows the operator to view the statistics of the packet transmissions
Message: Send and Display...	Allows the operator to open the screen where text orderwire messages are read, created, received, and sent (This screen is the default screen once the Client is connected to the Server).
Message: Open Archive...	Allows the operator to view archived text orderwire messages
Secure Voice: Request Call	Allows the operator to request a secure voice call
Secure Voice: Cancel Request	Allows the operator to cancel a request for a secure voice call
Event Log: Live Event Log	Allows the operator to view the current event log as it is built. To view previous events, see Client Archives and Server Archives below.
Event Log: Client Archives	Allows the operator to open archived logs containing information specific to the execution of the client program. Different clients connected to the same server will store these local logs on the local machine.
Event Log: Server Archives	Allows the operator to open archived logs containing information specific to the execution of the server program. All information regarding equipment status and network status is stored in the server logs on the computer executing the server.
Window: Cascade	Allows the operator to see all of the function windows in a cascade arrangement
Window: Tile	Allows the operator to view all function windows at once
Window: Arrange Icons	Allows the operator to organize the minimized function windows
Help: Help Topics	TBD
Help: About RFMOW	Displays a dialog with version information about RFMOW

G-4 OPERATION UNDER USUAL CONDITIONS

G-4.1 Standby

When the terminal has been successfully configured, the RFMOW will enter the Standby state and the PC/Controller Screen (see Figure G-8) will open. The "Server State:" at the top left of the Status Line will now show STANDBY.

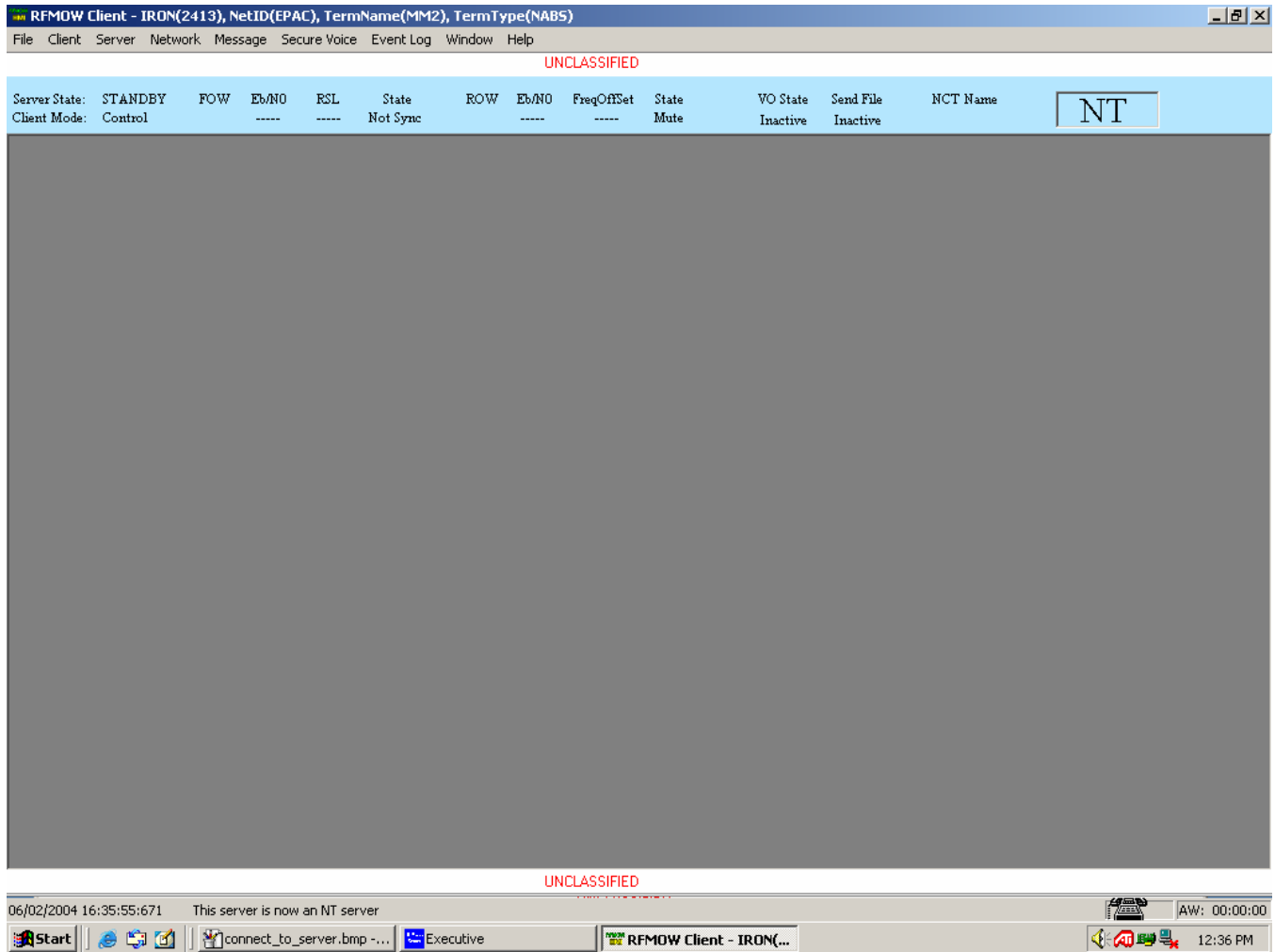

Figure G-8 NT PC/Controller Screen

As shown at the top of the screen, the window title contains the satellite IRON number, the network identification (NetID), the terminal name (TermName), and terminal type (TermType). Beneath the title bar is located the menu bar, the contents of which are described in paragraph G-1.3.5 (Main Menu). Beneath the menu bar is the status line, which contains various information about the current status of the terminal, the communications links, and the operation of the network. The content of the display is shown below in Figure G-9 (NT Status Line), and a description of each of these items and their possible values are described in Table G-8.

Server State:	OPERATE	FOW	Eb/N0	RSL	State	ROW	Eb/N0	FreqOffset	State	VO State	Send File	NCTName	NT
Client Mode:	Control		Max	-36.3	Access		9.3	-105.0	Mute	Inactive	Inactive	NCT_Server	

Figure G-9 NT Status Line

Table G-8 NT Status Line Fields		
LEGEND	VALUE	DESCRIPTION
Server State	IDLE	The server starts, binds to the Transmission Control Protocol (TCP) port, and listens at the port waiting for client to connect and complete initialization
	STANDBY	The server is waiting for the operator to issue the login command or is in the process of logging into the network
	OPERATE	The server is participating in network activities and all the RFMOW services are available
	HOLD	The network is suspended by NCT (usually during the network handover from NCT to ANCT, or NCT operator changes the TDMA slot parameters)
	DISCONNECTED	Terminal has been disconnected from the network
Client Mode	Control	Client has control privileges and access to all operator functions
	Monitor	Client has monitoring privileges and access to limited operator functions
FOW Eb/N0	----	No data or state is available
	NN.N	The current reading of the FOW Eb/N0
	Max	The current FOW Eb/N0 reading is greater than 16.0dB
FOW RSL	----	No data or state is available
	NNN.N	The current reading of the FOW RSL
FOW State	Not Sync	No activity, not currently trying to log in, not logged in
	Search	Searching for the FOW
	Found	The FOW has been found
	Normal	The network is in normal mode, measurements and transmitting can take place
	Access	The network is in access mode, NT's transmitters are turned off so other NTs can attempt a login
ROW Eb/N0	----	No data or state is available
	NN.N	Last reported reading of the ROW Eb/N0
ROW FreqOffset	----	No data or state is available

Table G-8 NT Status Line Fields		
LEGEND	VALUE	DESCRIPTION
	NNN.N	Current reading of the ROW Frequency Offset
ROW State	Mute	No activity
	Logging in	Currently trying to log into the network
	Logged in	Logged into the network and waiting for transition to Normal mode
	Transmit	Transmitting in the network
	Measure	Currently being measured
	Rejoining	Currently rejoining the network
VO State	Inactive	There is currently no secure call activity
	Requesting	A request for a secure call has been made
	Queued	The secure call request has been queued, waiting for NCT to setup call
	Canceling	In the act of canceling a secure call request
	Setting Up	NCT operator is setting up the secure call
	Set Up	Secure call has been setup
	Ending	Secure call is ending
Send File	Inactive	No outgoing file transfer is in progress
	Sending	Outgoing file transfer is in progress
NCTName	----	No data is available at this time
	<string>	The name of the NCT in the network

The next section of the screen is the Main Window. This area displays a variety of windows depending on what function the operator is performing (e.g. sending orderwire messages, displaying the status of links, displaying archives, etc.). The operator chooses a function by selecting it from the menu bar located at the top of the window.

The bottom of the main window contains a few fields that are always present. One is for event log messages that are displayed one at a time and the other is the Access Window timer. The event log can be viewed in full by selecting that function from the toolbar. The dialog at the bottom of the screen is designed to give the operator some feedback on what is currently happening. Example content would include error messages or informational messages. The image of the phone at the bottom right hand corner of the screen will change to indicate if the phone is on hook or off hook.

In the Standby state, terminal data can be changed as needed. At this point the operator will normally log into the network.

See paragraph G-4.2 (Network Login) for an explanation of the login process.

G-4.2 Network Login

NOTE: The procedures and programs for performing the power balancing/alignment for the AN/TSC-85D(V)1 AND AN/TSC-93D(V)1 terminals must be performed prior to accessing the network (see Appendix F, Power Balance/Alignment Procedure). The power balancing procedure may include some of the steps listed below.

When an NT operator initiates network login, the equipment will attempt to acquire the FOW. The following is an explanation of the steps to log into the network:

Table G-9 NT Network Login	
NOTE: Any NTs configured properly will receive the FOW. The operator can determine this by checking the Carrier Detect light on the front of the SDM-300A. If the light is on, a signal is being received at the FOW frequency.	
NOTE: Before a Login is attempted the operator should open the "Live Events Log" to verify communications between the SDM-300A and the PC/Controller.	
1	To login to the network, the NTs select Menu=>Network=>Login. At this time, the RFMOW software will begin searching for the FOW. Once the FOW has been acquired, FOW E_b/N_0 and RSL values will be displayed in the Status Line. The countdown clock on the bottom right of the display labeled "AW:" will indicate the time remaining before the next "Access Window is Open" message is expected. If the counter is at 0, the network may be in access mode. To determine this, the operator may check the FOW Status at the top of the screen. If the FOW State shows Access, an access window has opened for this subnet. During the Access mode, the NCT software will automatically rotate through all the defined Subnets in turn.
2	When the NT PC/Controller receives an "Access Window is Open" message, it will start the login process. At some point (depending upon the number of other NTs attempting to log into the network), the PC/Controller will indicate that it has acquired the ROW and will update the ROW state on the Status Line to indicate that it is logging into the network. The "ROW Granted" dialog will be displayed at all NTs (see Figure G-10). Select OK to close this dialog. The NT and NCT will then automatically adjust power, frequency and network time.
3	If the ROW Granted dialog is received, proceed to step 4, otherwise refer to Chapter 5, Maintenance & Troubleshooting.
4	If the NT terminal successfully logs into the network, the message "Login is completed successfully" will be displayed in a popup message box at that NT (see Figure G-11). Select OK to close the dialog. The ROW state in the Status Line will change to Logged in, and the Logout option on the menu will be enabled. If the terminal was unable to log in to the network, execute the fault isolation procedure in Chapter 5 (Maintenance & Troubleshooting) to correct the problem.
5	The NT terminal then waits until the NCT has closed the access window and has sent the updated "TDMA Schedule" message. The NT then automatically updates the ROW State to Mute, the Server State to Operate, calculates the time to wait for the beginning of its timeslot, and begins normal network operations, at which time the NT box in the upper right corner turns green.



Figure G-10 ROW Granted Dialog

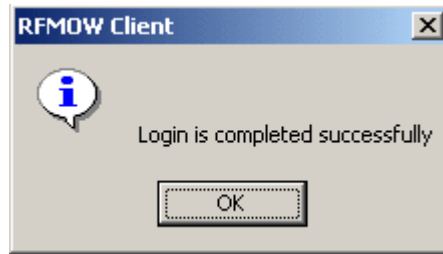

Figure G-11 Login Successful Dialog

G-4.2.1 Login Multiple Clients

RFMOW allows for multiple clients to be attached to a single server within an RFMOW node (a node being a single NCT, ANCT, or NT). Operators may start a client on any PC with RFMOW software installed, and specify the name of the server on the local area network (LAN) to which they desire to connect. NOTE: All clients MUST be configured in the same subnet. The first client connected to a server is designated the Control client and is given all operator privileges. Any subsequent connecting clients are designated Monitor clients and are given limited operator privileges. Control client privileges can be handed over from one client to another. See Server Control Handover (paragraph G-1.5.8) for further information.

G-4.3 Operate State

When the terminal is in the Operate State, text and voice orderwire services are available. In addition, Power and Frequency Configuration, Terminal Summary, Network Configuration, Event Log and Modem Control screens are available through the menu. These menu options allow the operator to select the feature they wish to view in the main window. The following paragraphs provide the procedures for composing and sending text messages, requesting a secure voice call, viewing network parameters and maintaining network operations.

G-4.3.1 Composing, Sending and Receiving Text Orderwire Messages

Anytime a text orderwire message is received the RFMOW icon in the task bar will flash until at least one of the unread messages has been read. In the received list, unread messages are in blue text and read messages are in gray. Messages are placed in the list chronologically sorted by the time stamp of when they were sent. If an NT's TDMA slot is missed due to a ROW measurement or some other reason, messages may appear in the list above previously received/read messages or out of the viewable display area. For this reason, it is important to check the top of the window for the current number of unread messages. The procedures for reading the messages, and for composing and sending a response are provided in the following paragraphs.

G-4.3.1.1 Reading a Message

Table G-10 Reading a Text Orderwire Message	
1	To read a text orderwire message, open the Text Messages screen by selecting Menu=>Message=>Send and Display from the Message menu bar. The Text Messages Screen will open (see Figure G-12). The screen is divided into three sub-windows. The bottom sub-window is where an operator composes a message. Newly arrived messages will be listed in the top sub-window and when they are selected they will be displayed in the middle sub-window. If portions of the message are not visible, the contents of each sub-window can be scrolled. To scroll within a sub-window, click inside to activate the sub-window to be scrolled. Then use either the <up/down/PgUp/PgDn> keys or the scrollbar on the right to scroll the text up and down within the sub-window. If an optional printer is attached, selecting the print button will cause the message displayed in the Display window to be printed.

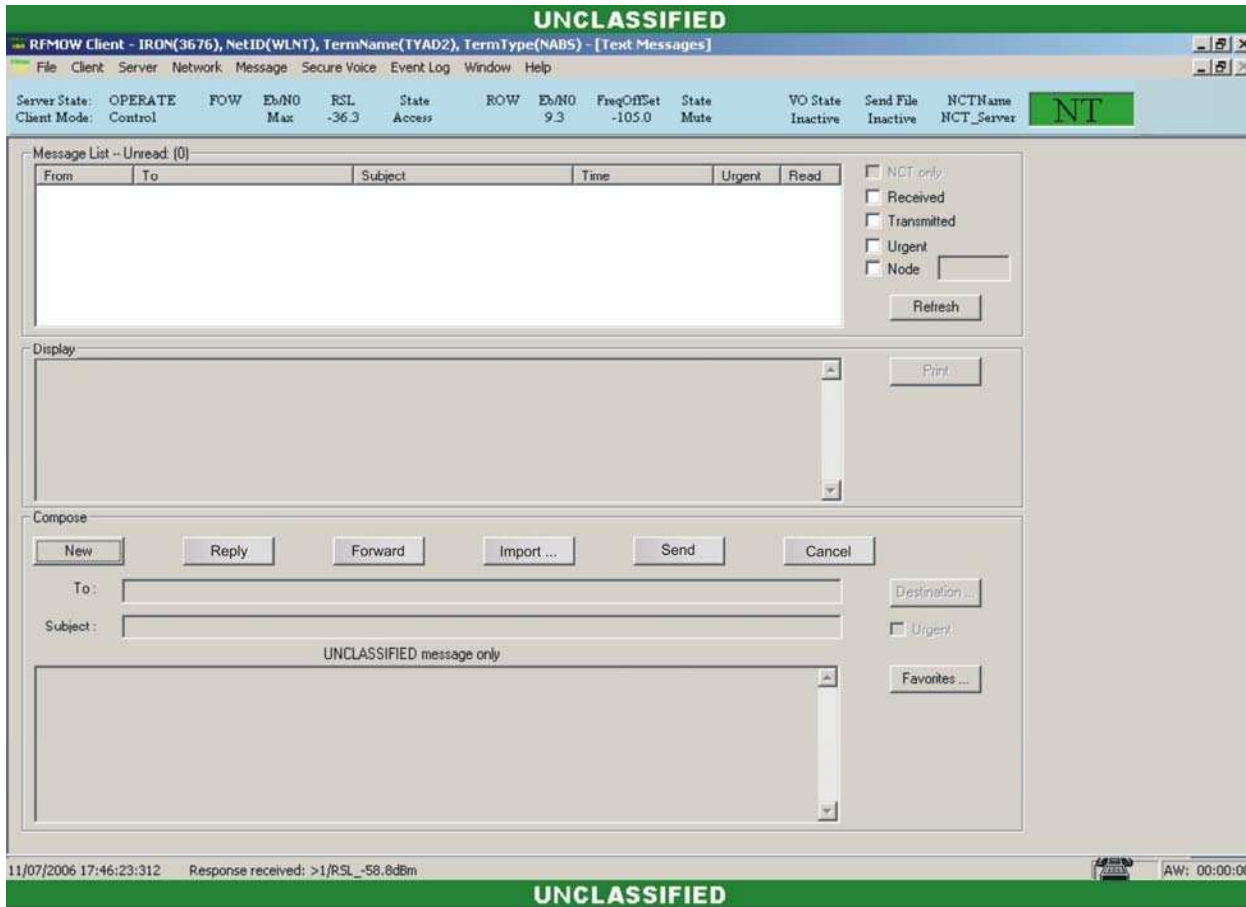

Figure G-12 NT Text Messages Screen

The top sub-window displays all messages that have been received and sent from the local server. Messages will remain in blue letters until read by the local client. All received and sent messages can be sorted in order by the following; source, destination, subject, time sent, and urgency. RFMOW also has filtering capabilities for messages. The operator can choose to filter messages by the checkbox next to the receive window. Once a checkbox or a combo of buttons have been activated, clicking the refresh button will update the messages in the receive window.

The middle sub-window is a display window for reading received messages. Text from messages can be copied to the clipboard from this window, or the operator can print all messages or a selected message by highlighting them and clicking the print button (if a dedicated printer is connected).

The bottom sub-window is a text editor used to compose an outgoing orderwire message. It supports standard text editor functions, e.g., the insertion, selection and manipulation of text, word wrapping, and cursor keys that allow the operator to move around the sub-window. The operator is provided with buttons for creating a new message, replying to received messages, importing text files to the current message, sending the current message, printing the message in the display window, canceling the creation of the current message, and a destination button for obtaining a list of available nodes to send messages to (Figure G-13). The operator may hand type the recipient in the address text box as well as selecting from the destination list. The maximum capacity of a text message varies according to the length of the transmit time of the NT's timeslot. (An NT with a default time slot with 1045 milliseconds of transmit time will have a maximum text message length of 730 characters.) If the character limit is reached during message editing, a dialog will be displayed to notify the operator. Similarly, when importing a file that will exceed the character limit, RFMOW will notify the operator that the message length is over the limit and will import as much of the file as possible without exceeding the limit. If the operator must send a message exceeding the size limit, he should use the file transfer function described in paragraph G-4.3.3 (Sending and Receiving Files).

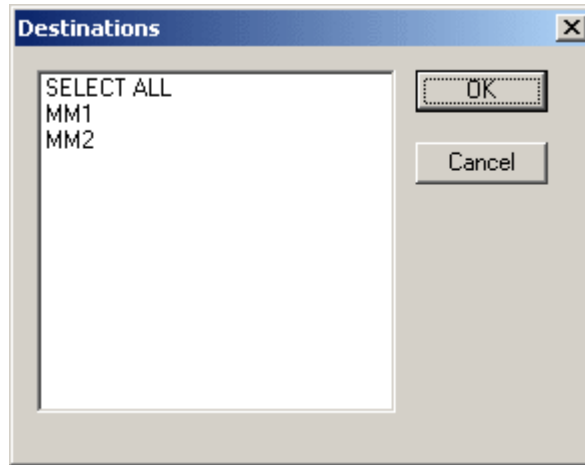

Figure G-13 NT Destinations Screen

The SELECT ALL option can be used as a shortcut to choose all available destinations. The names preceded by an asterisk (*) represent favorite groups that can be managed using the Favorites Groups screen, which can be accessed by clicking the 'Favorites...' button on the Text Messages Screen. For more information on the Favorite Groups screen see paragraph G-4.3.1.5.

When the local server receives an orderwire message, the PC/Controller first determines whether or not that local server is an addressee. If so, the local server saves the message to the message archive file and forwards the message to all the clients connecting to it. The client then alerts the operator by giving an audio bell, highlighting the text of the message in blue until opened, and flashing the RFMOW window for as long as the message stays unread. The audio bell will sound until a message is read for an urgent message. SELECT ALL messages require each receiving terminal's software to automatically send an ACK to the NCT. For each relevant incoming orderwire message, the receive sub-window displays the header of the message. Messages not directed to the local server are ignored. When an urgent message is received a dialog box (Figure G-14) will appear in the middle of the screen and the will not stop sounding until the dialog has been closed.

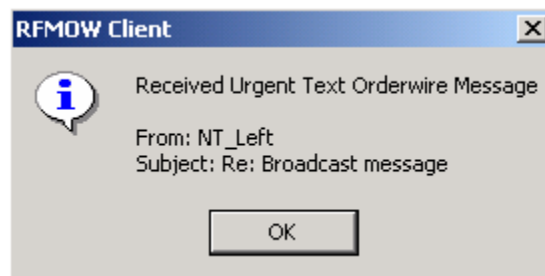

Figure G-14 Urgent Message Dialog

G-4.3.1.2 Composing and Sending a Message

Table G-11 Composing and sending a message.	
1	To compose a message, within the Text Messages screen, click either the 'New' button or select a message in the Message List text box and click the 'Reply' button in the bottom sub-window. Once a new message has been started the message fields become editable and the message can then be entered. Normal editing functions can be used.
2	Either click the 'Destination' button to the right of the sub-window to choose recipients (Figure 4-64) or enter each recipient's terminal id in the 'To' text box separated by a comma. If the Destinations dialog box is used, highlight each intended destination and then click OK when done.
3	Tab to or click the Subject text box and type the message subject.

4	Tab to or click the Urgent check box if the message is to be flagged as urgent. This will cause the computer speakers (if present) at the recipient terminal to continue to beep until the message is acknowledged.
5	Tab to or click the message body text box and enter the message. Unclassified messages only are allowed. The operator will be prevented from entering a message longer than can be transmitted in one TDMA slot.
6	When all desired destinations have been selected, the body of the message has been finished, and the subject of the message has been entered, click the Send button to send the message. The sent message will not appear in the Message List text box of an NT until the terminal transmits in its TDMA slot.
NOTE: To cancel the current message without sending, click the Cancel button. Once the Send button has been clicked, the Cancel button will have no effect.	

Each node has SELECT ALL as an option on the destination list. Choosing SELECT ALL will enter the name of every logged in node into the To: field. This requires the NT software to automatically send an ACK to the NCT when the message is received. During the terminal's next ROW TDMA slot (or as soon thereafter as possible), the message will be sent to the NCT. If other NTs are designated recipients of the message, the NCT will rebroadcast the message over the FOW to all terminals. The operators of the terminals addressed in the message will be alerted that a new message has been received. The message will also appear in the sender's receive message sub-window, confirming that the message was successfully transmitted to the NCT. Note that receipt of the returned message does not guarantee that all addresses received the message. If the NCT cannot deliver the message to any addressed terminal within a fifteen (15) minute period, the source terminal will be informed of the delivery failure.

G-4.3.1.3 Viewing Text Message Logs

All text messages received by a terminal are stored in message log files. The contents of a message log file may be viewed in the message archive window found under messages in the toolbar. The Archived Text Message Screen (Figure G-15) will appear with a list on the left side, a scrollable text box on the right, and a series of buttons along the bottom. The operator can print, both the entire message and a selection, and can save the log to a different location or a different name. All message log files are stored in the 'MessageLogs' directory, which is located at the RFMOW installation point. All message log files are stored under the name 'msg_MMDDYYYY-TTTTTT.log', where "MM" is the month, "DD" is the day, "YYYY" is the year, and "TTTTTT" is the system time of when the log was created. Thus a message log with the filename of 'msg_12302002-113925.log' corresponds to messages received on December 30th, 2002 and was created at 11:39.

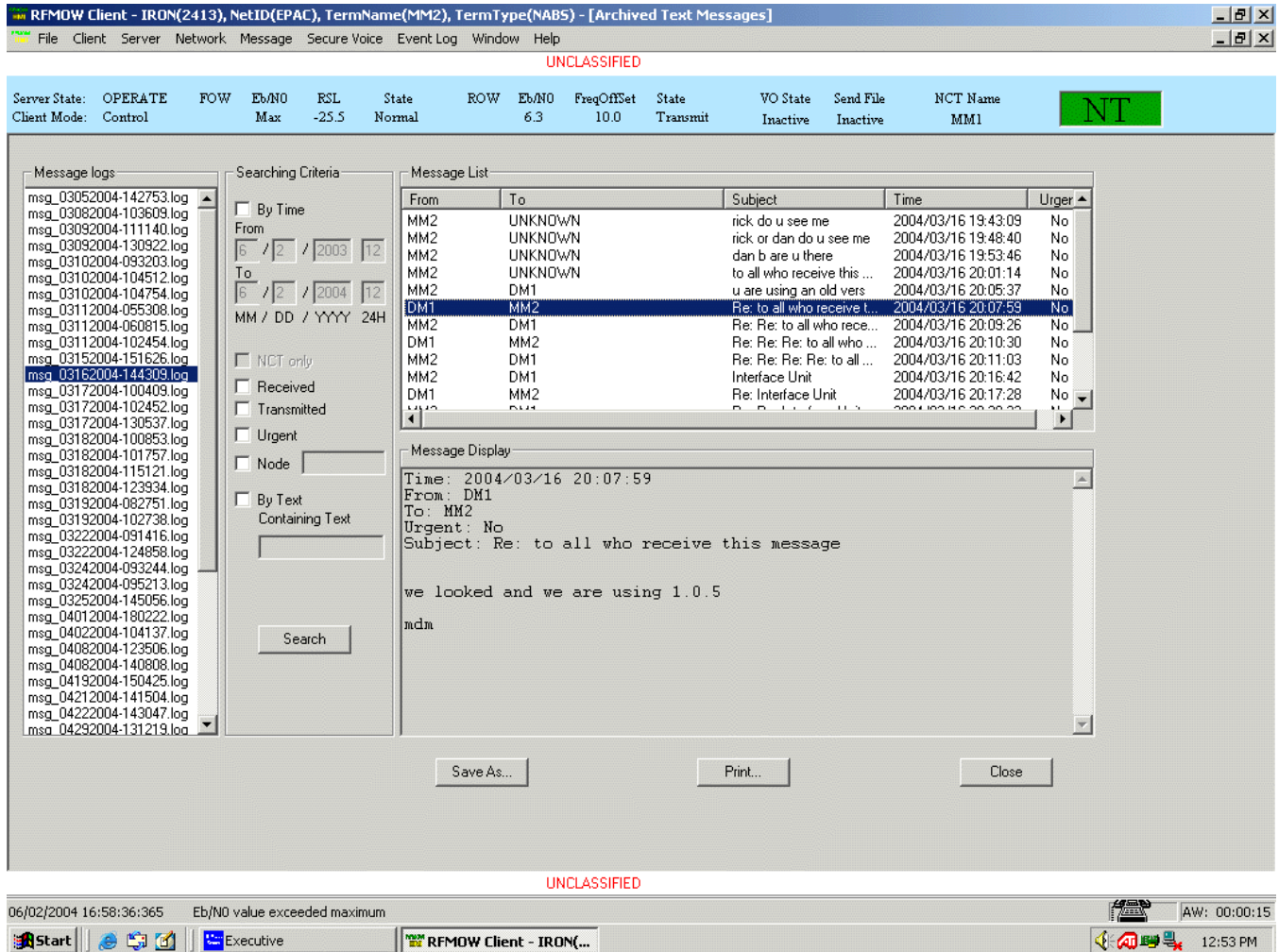

Figure G-15 NT Archived Text Messages Screen

Table G-12 Viewing Archived Messages	
1	To display the Archived Text Messages screen (Figure G-16), select Menu=>Message=>Open Archives.
2	To view a specific message log, select that message log from the Message Logs list and click the Search button. The contents of the log will be displayed in the Message List text box.
3	To view a specific message in the Message List, click on that message. The message contents will be displayed in the Message Display text box.

Table G-13 Filtering Messages From a Message Log	
1	An extensive filtering capability exists to allow only certain messages from a message log to appear in the Message List. Search criteria can include any combination of Time/Date, Received, Transmitted, Urgent, Node, and specific Text string.
2	To filter by any combination of the items listed above, select the check box located next to that item, enter the Time/Date, Node, and Text string as desired and click the Search button. Only those messages desired will be displayed in the Message List text box.

A copy capability is also available for copying selected text segments from the open file into the compose sub-window of the Text Orderwire Screen. The operator also has the ability to print an entire log or just a selected portion. The save button will allow the operator to save a message log to the local machine where the client application is running with an option of choosing a different name and location.

G-4.3.1.4 Cut and Paste into the Compose Window

Text within a message log file can be copied into the compose window.

Table G-14 Cutting and pasting text.	
1	To select text within the message file, move the cursor to the start of the desired text and highlight as much as needed.
2	Right click and select copy to save the selected text to the clipboard.
3	After closing the file edit window, the text can be inserted into the text orderwire compose window by placing the cursor at the desired insertion point and clicking paste from the right click drop down.

G-4.3.1.5 Favorite Groups

The Favorite Groups screen (see Figure G-16) allows the terminal operators to create mission addresses using the SAA Mission Number or other logical mnemonic rather than always selecting terminal IDs.

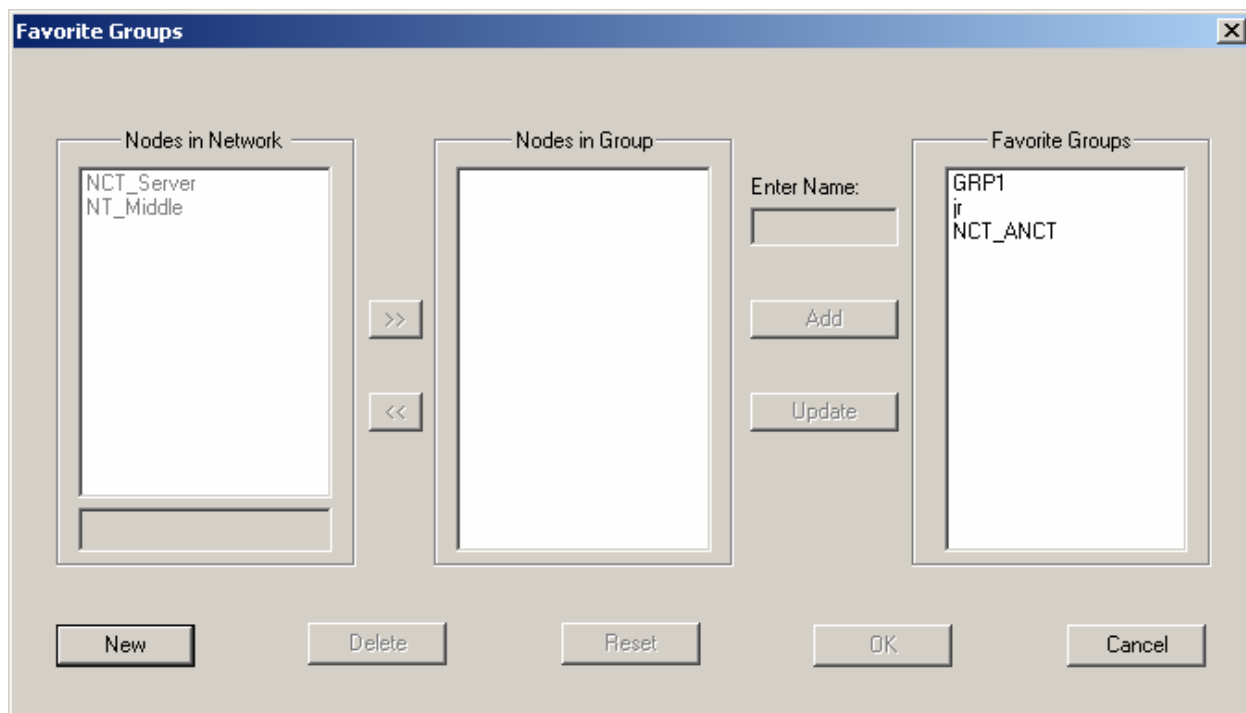

Figure G-16 Favorite Groups Screen

Table G-15 Creating Favorite Groups	
1	On the Text Messages screen, click the Favorites button to open the Favorite Groups screen (Figure G-17).
2	Click the New button to create a new group.
3	Enter the new group name in the Enter Name field.
4	Enter the node name(s) into the text field and/or select node name(s) from the Nodes in Network list, and click the '>>' button for each node.
5	Click the Add button to store the new group.

6	A group that is no longer needed can be removed by selecting the group from the Favorite Groups list and clicking the Delete button.
7	An existing favorite group can be modified by selecting the group from the Favorite Groups list, adding or removing nodes using the '>>' or '<<' button, respectively, and clicking the Update button.
NOTE: To close the Favorite Groups screen without making any changes, Select Cancel.	

G-4.3.2 Requesting and Conducting a Secure Call

The NCT and the NT have the ability to make secure voice orderwire calls with each other. The procedures for requesting a call, answering a call, and viewing secure voice call queue status are provided in the following paragraphs.

G-4.3.2.1 Requesting a Call

Table G-16 Requesting a Secure Call	
1	To request a call, select Menu=>Secure Voice=> Request Call from the main menu. The request will be sent to the NCT and the NT will be put on a call queue waiting for a response from the NCT. A message box containing the message "NT xxxx is queued for voice call", where xxxx is the NT name from which the request was sent, will be displayed to the NCT operator.

Table G-17 Canceling a Secure Call Request	
1	If the NCT does not answer the voice orderwire request in a timely fashion, or for any other reason, the NT can cancel the pending request from the queue by selecting Menu=>Secure Voice=>Cancel Request from the main menu. The "Node <NT Name> has been removed from the voice call queue" message dialog will be displayed at the NCT. The "VO request has been canceled" message dialog (see Figure G-17) will be displayed at the NT. Select OK to close the dialog.

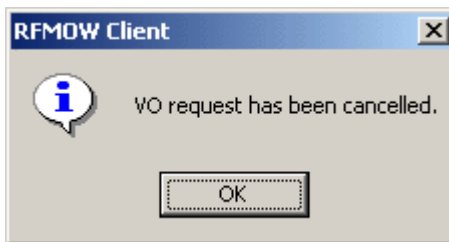

Figure G-17 Secure Voice Request Canceled Dialog

G-4.3.2.2 Call Setup and Answering

Table G-18 Receiving a Call	
1	When the NCT attempts to call the NT, the NT will display the message "VO has been setup, please wait for phone to ring" in a message box.
2	The NT operator must pick up the receiver on the secure voice unit when instructed, "Secure phone is ringing, please pick up the phone" by a message box or when the secure voice unit begins to ring. Picking it up before the message box appears may cause the call to fail.
3	When the secure call is complete, the call is terminated at either end by hanging up the receiver on the secure voice unit.

WARNING: Picking up the STE handset during call setup will generally cause the call setup to fail. In some cases the STE will also go into a failure mode. In the failure mode, no buttons on the face of the phone, including the Reset button, will be functional. Should this happen, the phone must be turned off and then back on. To turn the STE off and then on, remove and then replace the power cable connected to the back of the secure voice unit.

When the NCT operator has selected the destination NT for a call, the NCT PC/Controller will retune its auxiliary modem to the network secure voice frequencies and command the NT PC/Controller to retune its control modem to the network secure voice frequencies and the NT software to switch the Interface Unit A/B switch from data to voice mode. When a link is successfully established for a AN/TSC-85D(V)1 AND AN/TSC-93D(V)1 terminal it will normally take 10-20 seconds. Once established a message popup box with the message "VO has been setup, please wait for phone to ring" will be displayed to the NT operator, and an info alert box with the message "VO has been setup, please pick up phone" will be displayed to the NCT operator. When the NCT operator picks up his phone, the STEs will then begin their synchronization process. When the phones have successfully synchronized, a "Secure phone is ringing, please pick up the phone" alert will be displayed to the NT operator, the phone will ring, and the audio alarm located on the Interface Unit will ring if enabled. The NT operator should pick up the hand set at this time to complete the call.

If the secure voice call link setup should fail for any reason, or should the NT operator pick up the phone before it rings, both the NT and NCT operators will receive an alert with the message "Unable to establish voice call".

G-4.3.2.3 Viewing the Secure Voice Call Queue

Table G-19 Displaying the Terminal Status Screen	
1	To display the Terminal Status screen, select Menu=>Network=>Status=>Terminal.
2	To close the Terminal Status Screen, click Close.

Terminals with a secure voice call queued, and the terminal currently involved with an active call (if any), can be seen from the "VO" column on the right side of the Terminal Status Screen (see Figure G-18). If a call has been requested by a terminal and queued, an "RQ" will appear in the list entry for the terminal. If a call is in process, then an "AC" will appear in the list entry for the terminal conducting the call.

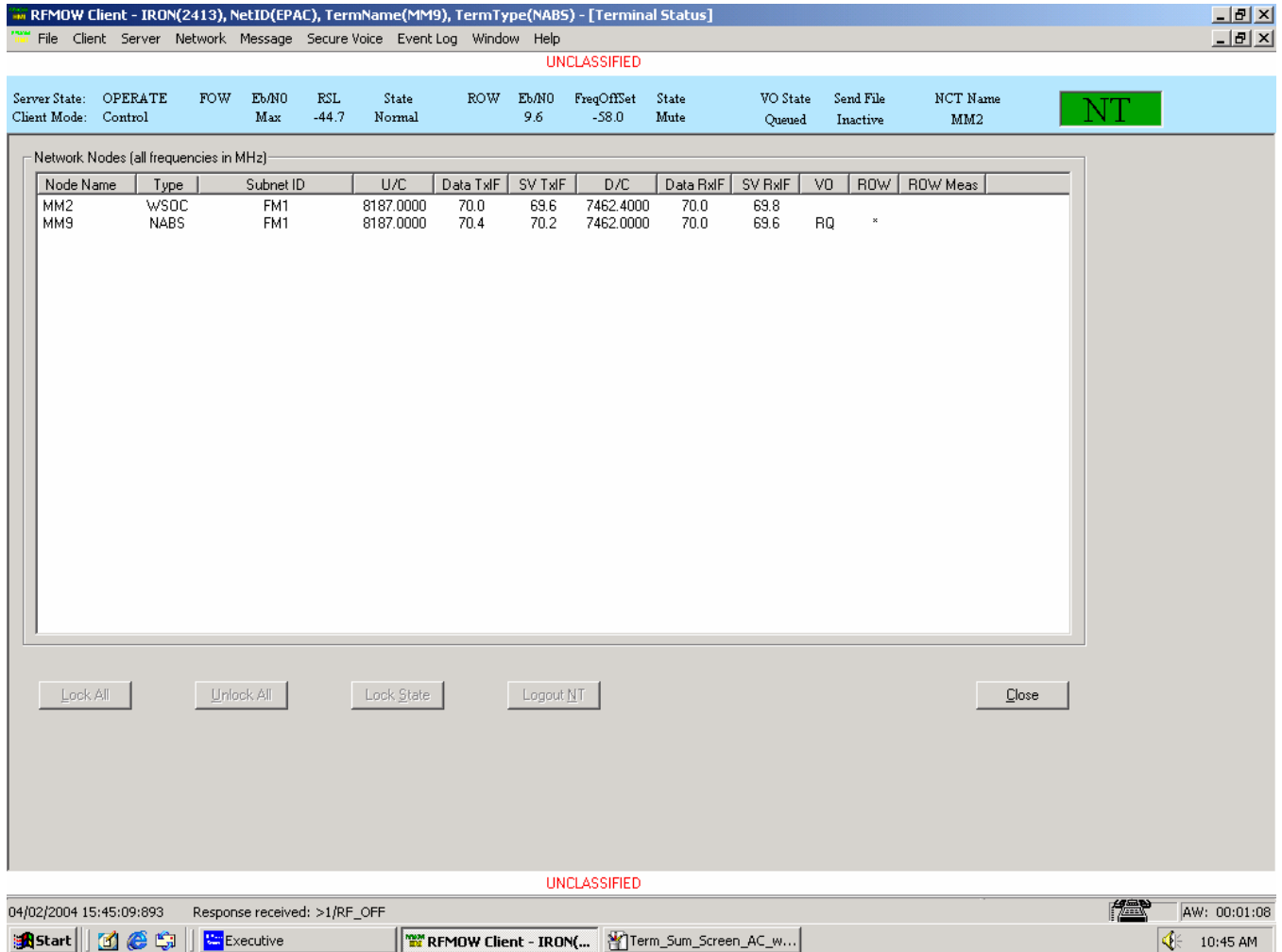

Figure G-18 NT Terminal Status Screen

G-4.3.3 Sending and Receiving Files

The RFMOW provides the ability to send and receive files of any type. The time required for an NT to send a file depends on the size of file, the number of NTs in the network, and the length of the ROW TDMA time slot.

G-4.3.3.1 Send File Screen

The Send File Screen (Figure G-19) is used by the operator to initiate a file transfer.

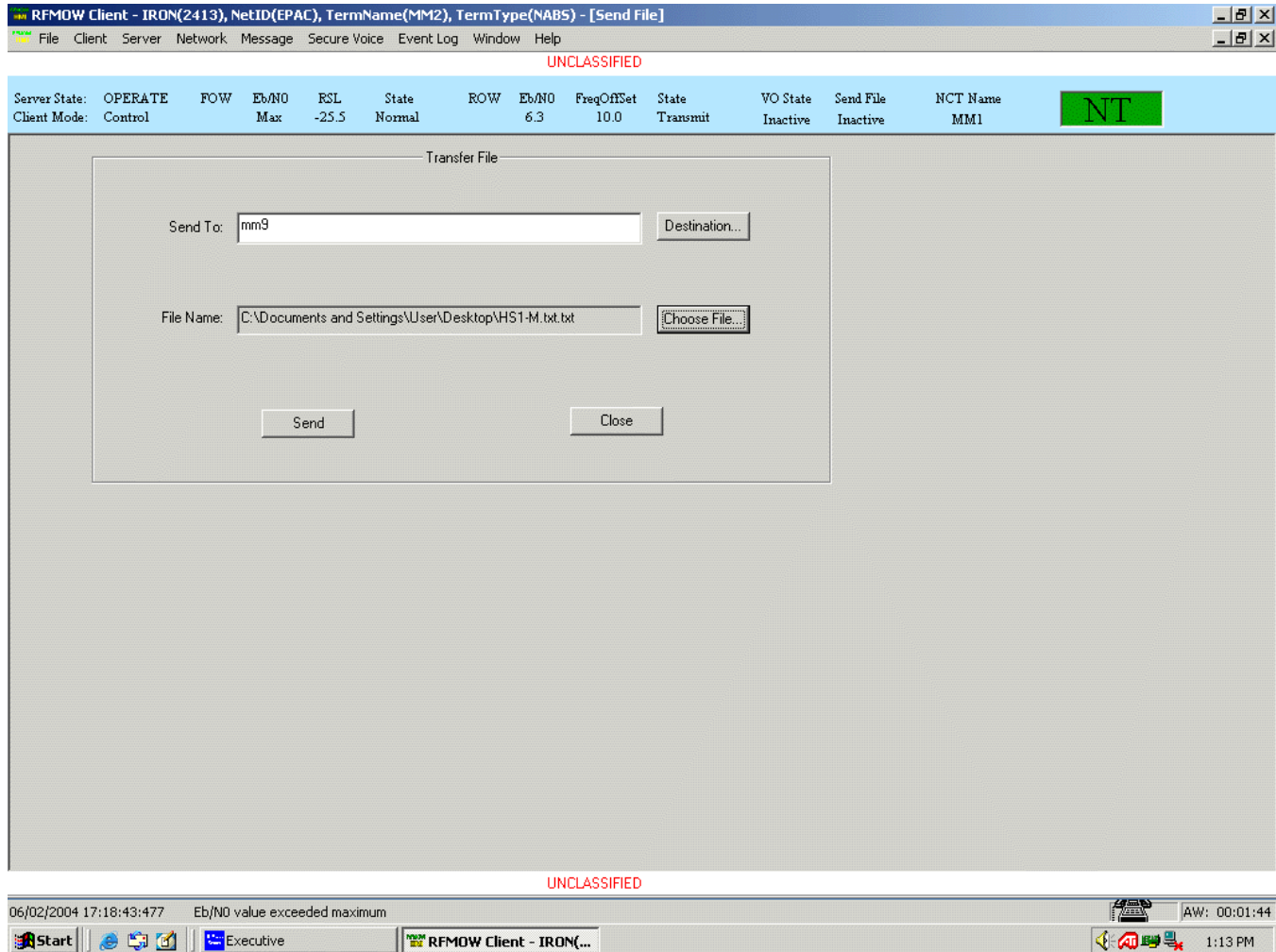

Figure G-19 NT Send File Screen

Table G-20 Transferring a File	
1	Display the Send File screen by selecting Menu=>File=>Send File from the main menu.
2	Either type the Terminal ID of the recipients into the Send To field or select terminals from the Destination window by selecting Destination, clicking on the recipients, and selecting OK.
3	Click the Choose File button to select the file to be sent using the standard Microsoft Windows "Open" file dialog.
NOTE: Files larger than 10KB should not be sent from an NT/ANCT via file transfer due to the limited bandwidth inherent in the ROW TDMA structure. Larger files may be sent from the NCT since the FOW is not subject to the same TDMA restrictions.	
4	Click the Send button to initiate the file transfer. Once the file name and destinations have been entered, the Send button will be sensitive and the operator can click it to initiate the file transfer.
5	Click the Close button to close the Send File Screen.

Once the file transfer has been initiated using the "Send" button, the 'Send File' status in the terminal status bar will be changed from 'Inactive' to 'Sending'. This status will be displayed until all file segments have been transmitted into the network. While a file transfer is in the 'Sending' state, the "Send File..." menu option will be disabled, and the "Cancel Send File" option will be enabled. This option allows the operator to cancel the file transfer that is in progress. The file transfer occurs in the background. This does not prevent any other actions from occurring at the NCT or NTs. Secure Voice calls and ROW measurements will take precedence over file transfers and may cause file transfer delays.

Once all file segments have been transmitted into the network, the operator will be informed of the completion of the file segmentation and transmission, and will be allowed to initiate another file transfer if desired. All destination nodes may not successfully receive the file immediately, since some nodes may be experiencing communication degradations preventing immediate delivery. When a destination successfully receives the complete file (all segments received error-free), a text orderwire message will be sent to the node originating the file transfer, informing the sender of the successful delivery. This message can be viewed on the Text Orderwire Screen along with other text orderwire messages received. Conversely, if a destination node suffers an unrecoverable transmission failure before completion of the file transfer, the originator will be sent an 'Undelivered file' text orderwire message with notification of the delivery failure. When a destination node successfully receives the file, all operators attached to the node are notified that the file has been received from the originator. Any or all operators on the destination node may retrieve the file by using the "Retrieve File..." option on the "File" menu (see following paragraph).

G-4.3.3.2 Get File Screen

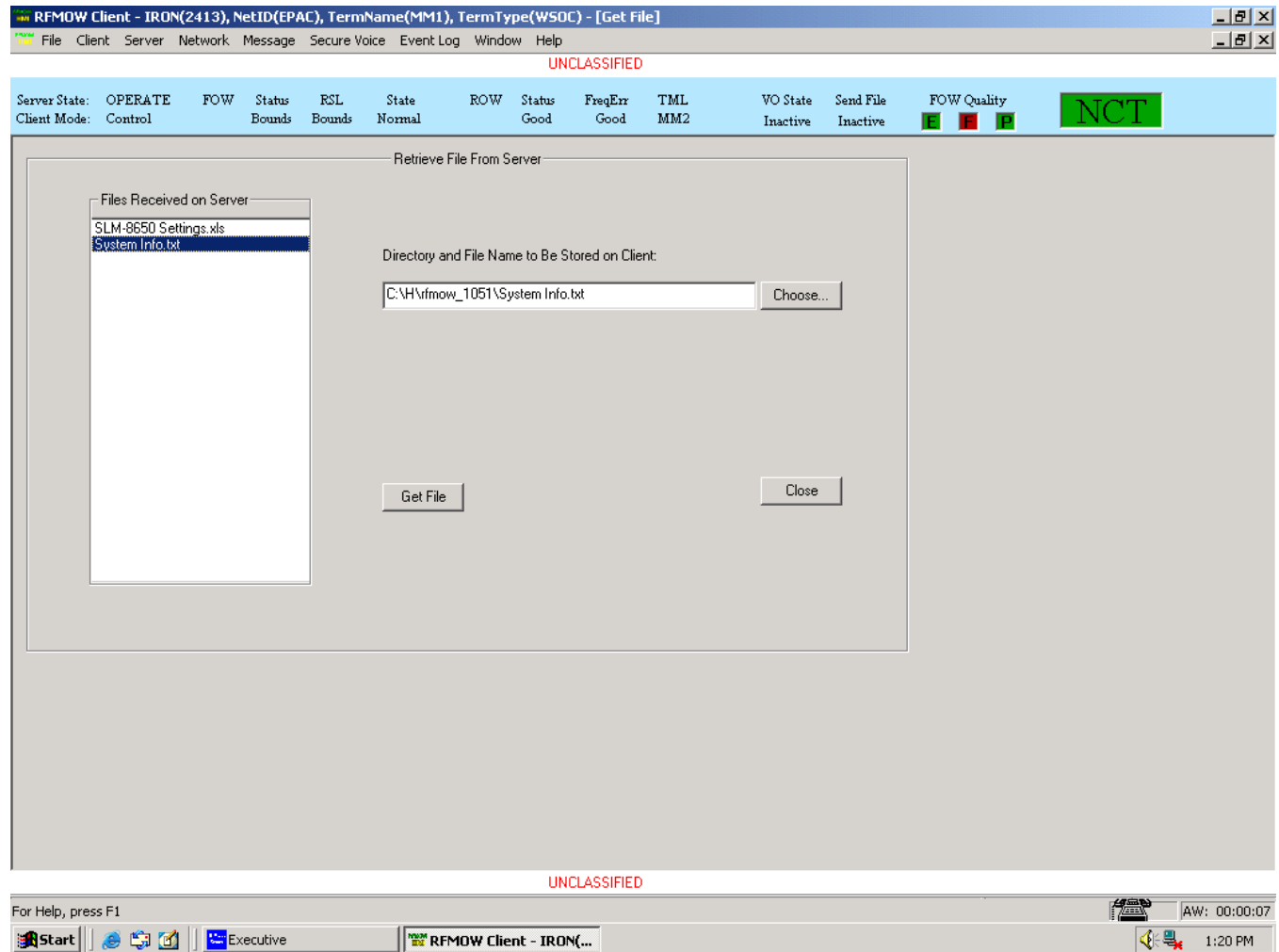

Figure G-20 NT Get File Screen

The Get File Screen (Figure G-20) is used by the client computer to retrieve a received file from the server computer. This is necessary since files transferred to a node are stored on the server computer, not each individual client.

When a file is received from the network, the file is stored in the 'ReceivedFiles' folder on the server computer. If the client application is running on the same computer as the server, the Retrieve File function is not necessary. If the server and client are running on separate machines, the Retrieve File function is used to

transfer the received file from the server to the client computer. The “Files Received on Server” sub-window above displays the contents of the ‘ReceivedFiles’ folder. When a file is retrieved from the server using the above screen, it will not be removed from the ‘ReceivedFiles’ folder and will continue to be shown in the “Files Received on Server” sub-window until it is manually deleted. This will allow all operators the opportunity to retrieve and/or view the received file.

Table G-21 Retrieving a File from the Server Computer	
1	Display the Get File screen by selecting the Menu=>File=>Retrieve File from the main menu.
2	Select the file to be transferred by clicking on the file in the "Files Received on Server" window.
3	Either type the destination manually or click on the Choose button to use the Microsoft Windows 'Save As' file dialog.
4	Once the desired file location has been entered, click the Get File button to copy the file from the server's 'ReceivedFiles' folder to the chosen location.
5	Click Close to close this screen.

G-4.3.4 Viewing Network Data

Each operator can view the network data contained in the Terminal Status (see Figure G-24) and Link Status (see Figure G-25) Screens. Each operator can also view his local Event Log (see Figure G-21). The following paragraphs contain procedures for viewing and understanding this data.

G-4.3.4.1 The Event Log

The event log contains a time-stamped sequence of informational, error, critical, and (optionally, at the operator's request) debug messages including all messages that are displayed in the Event window at the bottom of the PC/Controller screen. The event log is useful in reconstructing prior operator actions, for station logging purposes, and for detecting unusual or anomalous conditions. For example, if the log shows an unusually high number of ROW TDMA receive failures for a particular terminal, then the terminal may have a transmit problem.

G-4.3.4.1.1 Opening the Live Event Log

To open the current event log, select Live Event Log from the menu bar. The Live Events Screen will open (see Figure G-22). The <up/down/PgUp/PgDn> keys or the scroll bar can be used to scroll through the log. The operator can also filter which messages are to be displayed. The filters do not affect the archived event logs; all events are still logged. To view events that occurred prior to opening the Live Event Log, view the Archived Events. See paragraphs G-1.5.4.1.2 (Archived Events Screens) and G-1.5.4.1.3 (Opening an Archived Event Log).

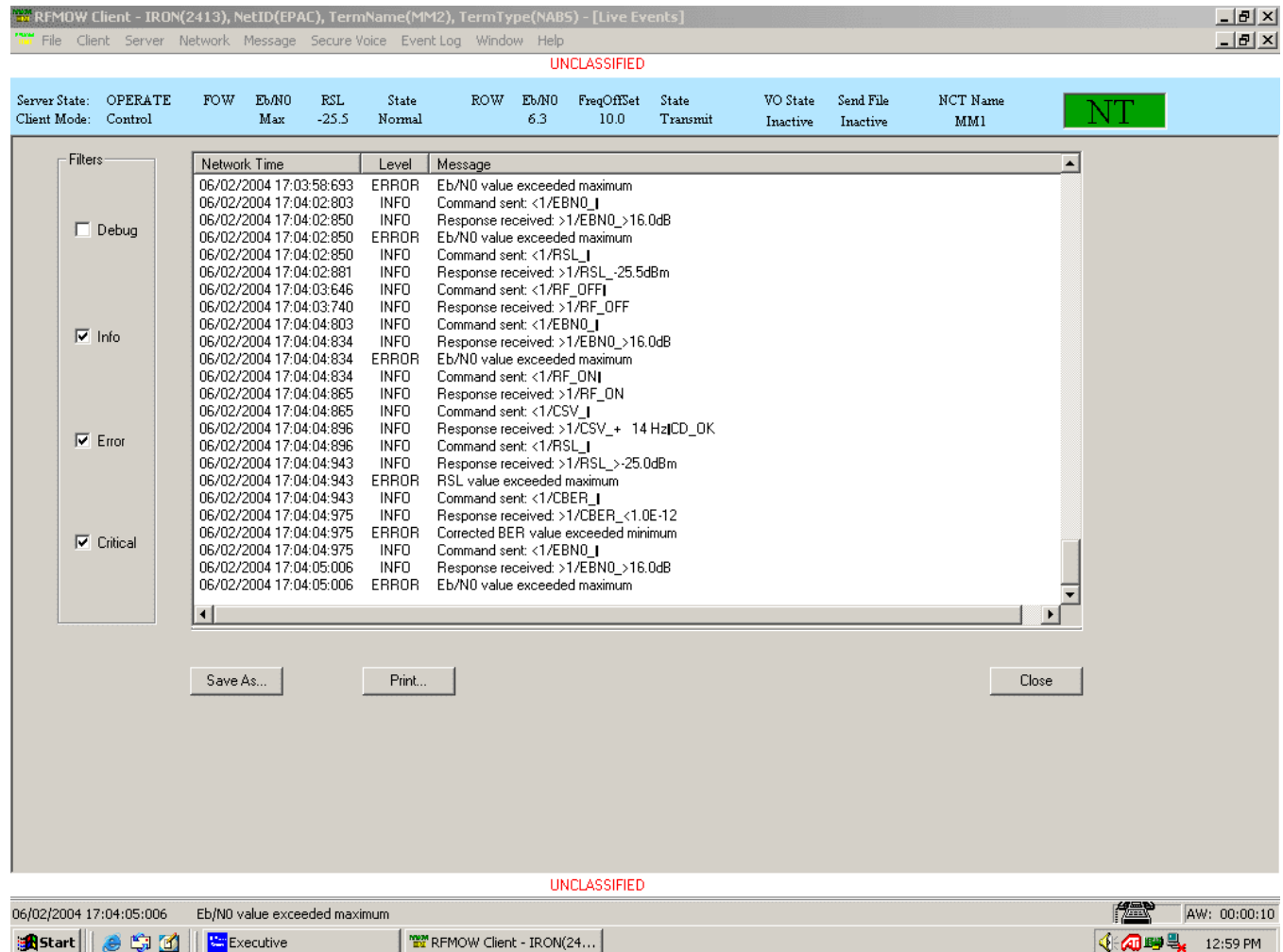

Figure G-21 NT Live Events Screen

The Live Events Screen (Figure G-21) contains a scrollable window that displays the most recent event messages. The operator can selectively choose to display one or more types of messages: the debug events, the error events, the information events, or the critical events. The operator can choose to save or print part or all of the displayed events.

Table G-22 Displaying, Filtering, Saving, and Printing the Live Event Log	
1	Display the Live Events screen by selecting Menu=>Event Log=>Live Event Log on the main menu.
2	Select Debug, Info, Error, or Critical to choose the types of live event messages to be displayed. A check mark next to an event type will cause that type of event to be displayed.
3	Click the Save As button to use the Microsoft Windows 'Save As' file dialog to save the filtered event log.
4	Click the Print button to print the currently displayed Event Log window contents to the optional printer.
NOTE: To close the Live Events window, click the Close button.	

G-4.3.4.1.2 Archived Events Screens

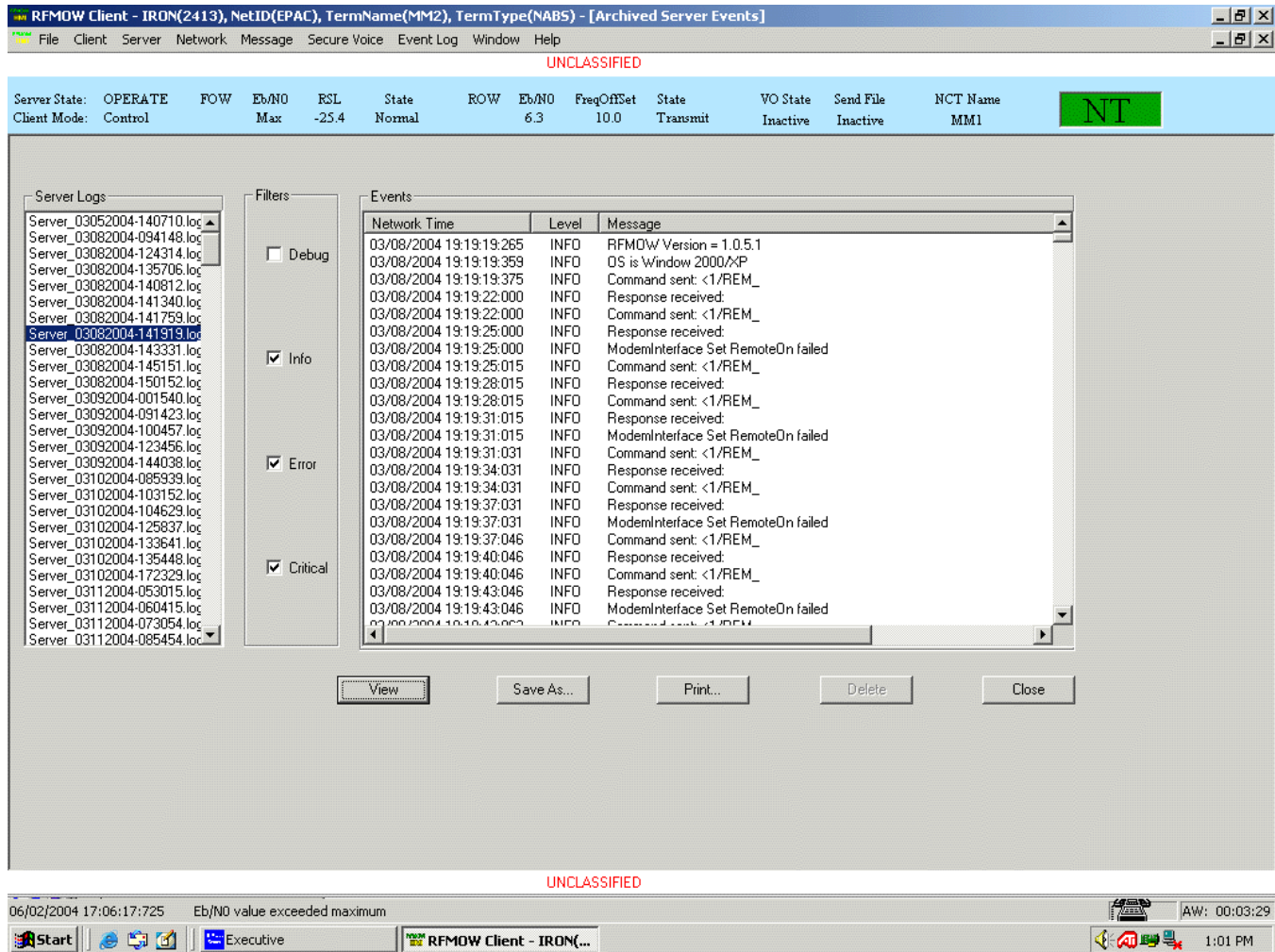

Figure G-22 NT Archived Server Events Screen

Events screen is used to view event logs for the client application as well as any event log file that the operator has saved earlier. Either screen allows the desired log file, selected from the list on the left side of the window, to be displayed inside the events window. When the View button is pressed, the text window will be updated to show the contents of that log. The operator can filter on the different kinds of event messages to be viewed. The checkboxes allow the operator to exclude any types of messages that are not desired by deselecting the checkbox. The operator also has the ability to print an entire log or just a selected portion. The save button will allow the operator to save the viewed event log to the local machine where the client application is running with the option of choosing a different file name and location. The operator is not allowed to delete any log files through the RFMOW application that are generated by RFMOW. Only those log files created by the operator may be deleted. The RFMOW software will automatically delete log files when the hard disk utilization exceeds 80%.

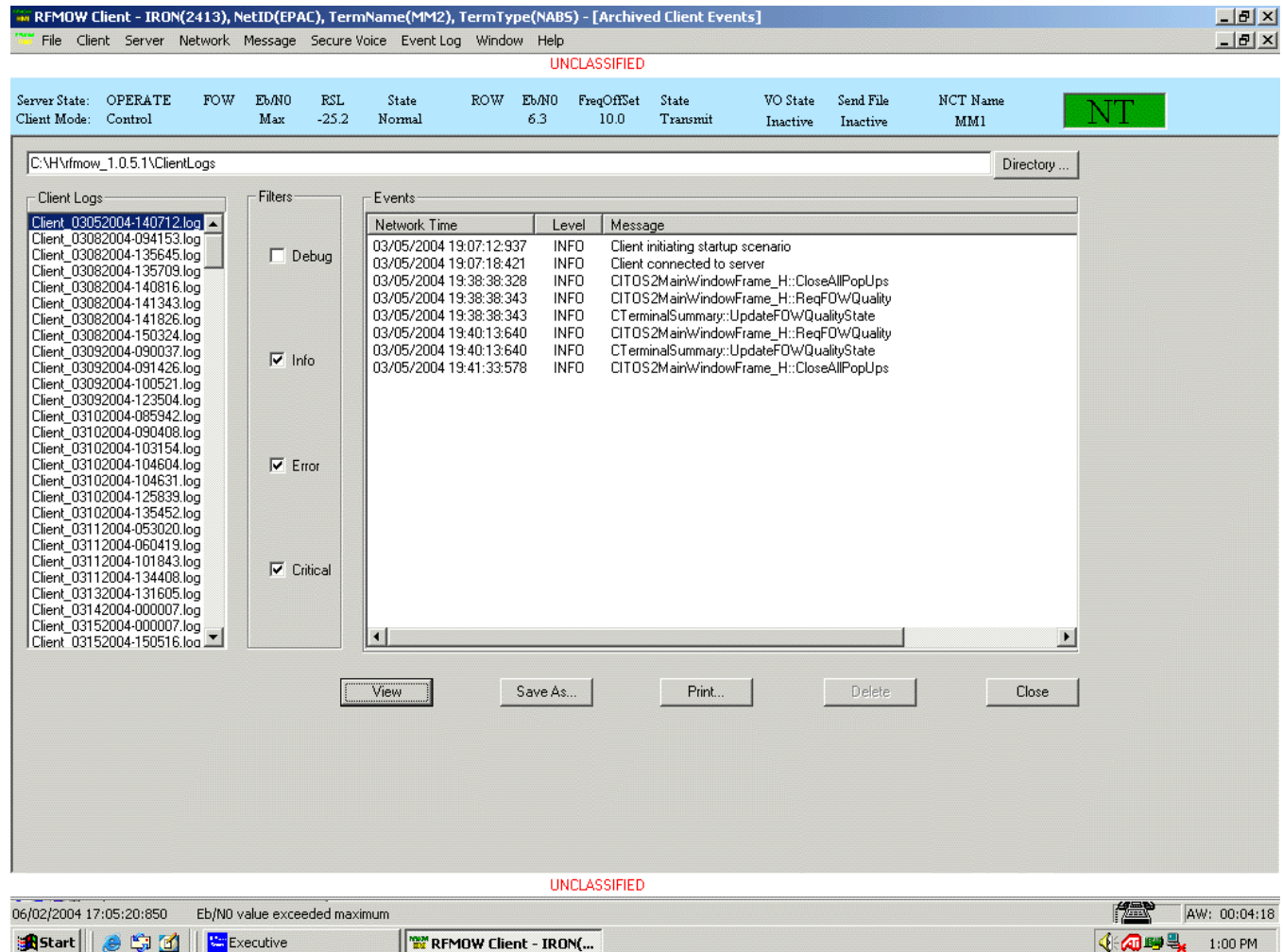

Figure G-23 NT Archived Client Events Screen

The Archived Client Events screen is very similar to the Archived Server Events screen except that it has a field for entering the directory path. This additional field gives the operator the ability to open up a previously saved log file located in the directory he had chosen before. The operator is allowed to delete only the log files that are previously saved by him.

G-4.3.4.1.3 Opening an Archived Event Log

Event logs are stored to disk and rollover when the size of the event log exceeds 5 MB and at midnight of each day. At this time, the existing log file is saved and a new log file is opened. Both server event and client event logs are archived. All event files are stored in the directory ServerLogs or ClientLogs, which are located at the RFMOW installation point. All event logs are stored under the name xxxxxx_MMDDYYYY-TTTTTT.log, where "xxxxxx" is either 'server' or 'client', "MM" is the month, "DD" is the day, "YYYY" is the year, and "TTTTTT" is the system time of when the log was created. Thus a message log with the filename of 'server_12302002-113925.log' corresponds to a server event log written on December 30th, 2002 at 11:39:25 a.m.

The window will appear with a list on the left side, a scrollable text box on the right, and a series of check boxes in the middle. The checkboxes allow the operator to view specific types of events in the log (e.g. if the user wishes to view only critical and error events to isolate a problem). As with message logs, text within the event log can be copied to the message compose window for inclusion in a text message if desired.

NOTE: Event log files are not editable, and the operator does not have the ability to delete event logs using the RFMOW software. Log files will be automatically deleted by RFMOW whenever the hard disk utilization exceeds 80%. Log files may be deleted manually using Microsoft Windows.

Table G-23 Displaying, Filtering, Saving, and Printing the Archived Event Log	
1	Display the Archived Server Events screen or the Archived Client Events screen by selecting Menu=>Event Log=>Client Archive or Menu=>Event Log=>Server Archive on the main menu, depending whether the server or client archive is to be displayed.
2	Select the server log to be displayed or the client log to be displayed from the Server Logs window or the Client Logs window respectively.
3	Select Debug, Info, Error, or Critical to choose the types of live event messages to be displayed. A check mark next to an event type will cause that type of event to be displayed. If debug logging has not been previously enabled, no debug events will be saved to the log files and, therefore, will not be displayed even if the Debug checkbox is selected. To enable debug logging, select Menu=>Server=>Enable Debug Logging from the main menu. To disable debug logging, select Menu=>Server=>Disable Debug Logging from the main menu.
4	Click the View button to cause only the selected event types to be displayed in the event window.
5	Click the Save As button to use the Microsoft Windows 'Save As' file dialog to save the filtered event log.
6	Click the Print button to print the currently displayed Event Log window contents to the optional printer.
7	Select a log file and click the Delete button to permanently delete the log file from the computer.
NOTE: To close the Live Events window, click the Close button.	

G-4.4 Terminal Configuration

G-4.4.1 Local Terminal Configuration

Table G-24 Displaying the Power and Frequency Configuration Screen	
1	Select Menu=>Server=>Detailed Configuration under the main menu to display the Power and Frequency Configuration screen.

WARNING: Turning an RFMOW modem on and off at inappropriate times will disrupt network operations.

The current configuration of the local terminal can be viewed by selecting Detailed Configuration under Server on the menu bar. The Power and Frequency Configuration Screen for the AN/TSC-85D(V)1 AND AN/TSC-93D(V)1 will open. If the terminal is in the Operate mode, the Turn Modem XMTR On/Off options will be disabled (grayed out) to prevent the modem modulator from being turned on and off. In Standby mode, the operator has the ability to make changes to power and frequency. Once changes have been entered, clicking the OK button will make those changes in the network. In Operate mode, changes to the transmit power and frequency must be made from the link entry on the Link Status window. See paragraph G-3.4 (Power and Frequency Configuration) for more information.

G-4.4.2 Viewing the Network Terminal Status

Table G-25 Displaying the Terminal Status Screen	
1	Select Menu=>Network=>Status=>Terminal from the main menu to display the Terminal Status screen.
NOTE: To close the Terminal Status screen without making any changes, Select Close.	

Summary information on the other terminals currently logged into the network can be viewed by opening the Terminal Status Screen (see Figure G-24). This screen shows the name and type of all terminals in the network as well as the current transmit and receive frequencies.

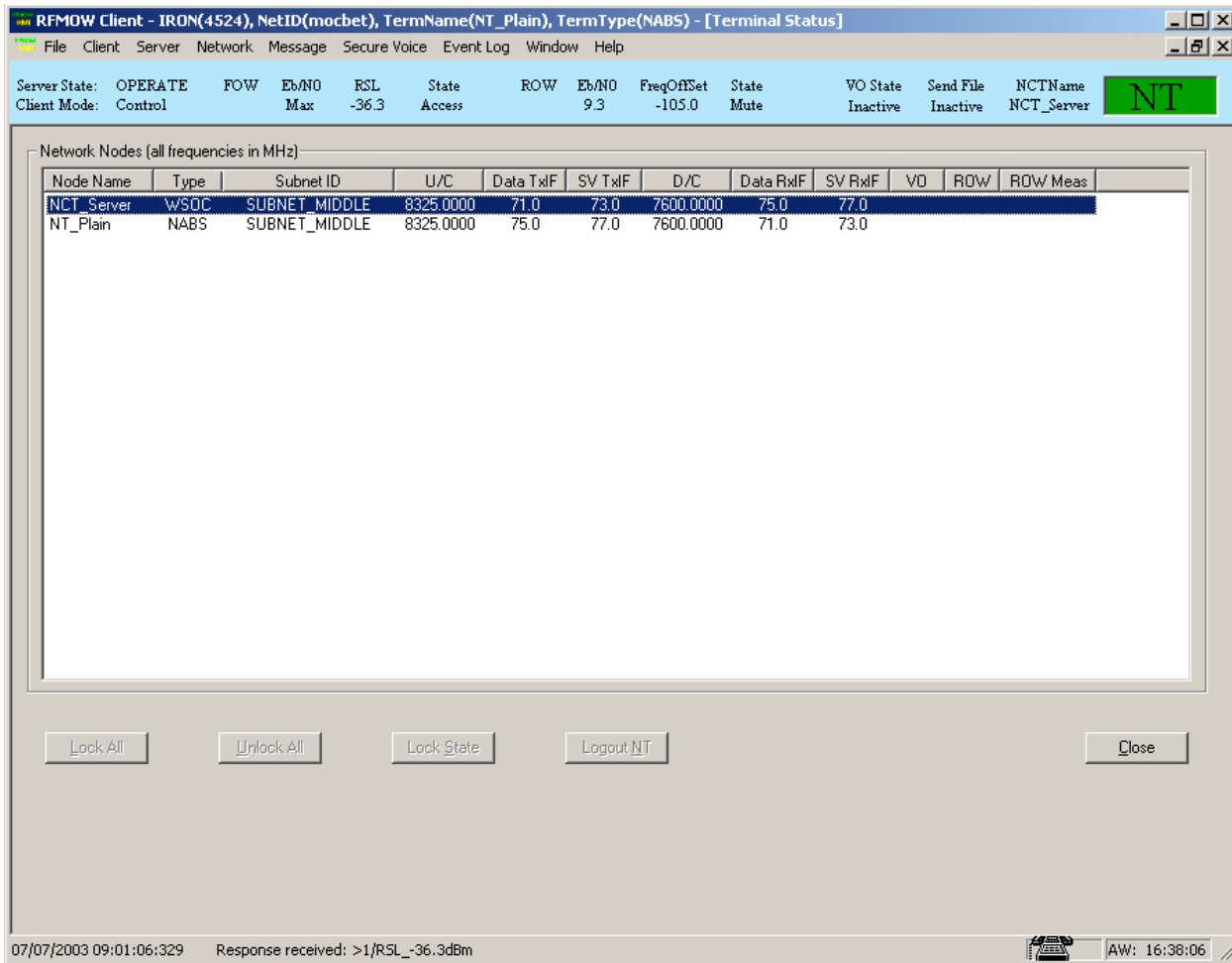

Figure G-24 NT Terminal Status Screen

The terminal parameters are displayed in Table G-26 as follows:

Table G-26 Terminal Status Screen Fields	
Parameter	Description
Node Name	Name of the terminal
Type	Type of the terminal (WSOC, AN/TSC-85D(V)1 AND AN/TSC-93D(V)1, or AN/TSC-152 AND AN/USC-59)
Subnet ID	Name of the subnet the node belongs to
U/C	Up converter frequency of the terminal in MHz
Data TxIF	Modem transmit IF frequency for data in MHz
SV TxIF	Modem transmit IF frequency for secure voice orderwire in MHz
D/C	Down converter frequency of the terminal in MHz
Data RxIF	Modem receive IF frequency for data in MHz
SV RxIF	Modem receive IF frequency for secure voice orderwire in MHz
VO	Voice orderwire status of terminal - "AC" indicates active, "RQ" indicates a request to use the VO has been queued

Table G-26 Terminal Status Screen Fields	
Parameter	Description
ROW	An "*" indicates which terminal is currently transmitting the ROW. A "D" indicates that that status of the terminal currently owning the ROW time slot is DISCONNECTED but not logged out of the network
ROW Meas	An "*" indicates the terminal whose ROW is currently being measured by the NCT

The IF frequencies are computed based upon the difference in the terminal converter frequency and the network frequency. For example, if the WSOC up converter is set to 7900.0000 MHz and the required FOW transmit frequency is 7905.0000 MHz, then the Data TxIF frequency for the WSOC will be 75.0 MHz, that is, 5 MHz above the normal 70 MHz output frequency. This is the IF frequency that the WSOC control modem modulator will be set to. The control modem IF 5 MHz offset corrects for the up converter frequency setting, which is 5 MHz below the required FOW transmit frequency.

The control modem transmit modulator IF frequency can be set in +/- 2.5 kHz steps. Under automatic frequency control, the modem modulator will be adjusted in these steps to compensate for frequency errors in the terminal transmit and receive chains. The screen does not provide adequate space to list the IF frequency to this resolution, so the listed frequencies are rounded.

G-4.4.3 ROW TDMA and ROW Measurement Sequencing

The sequencing of terminal ROW TDMA transmissions, and the sequencing of ROW measurement by the NCT, can be viewed on the Terminal Status Screen.

Under the ROW column to the right of the screen, an "*" will appear in the list entry for the terminal currently transmitting a ROW TDMA burst. If a terminal is currently in the Disconnect mode (see paragraph 4.2.6, (Disconnect)), the ROW column for that terminal will display a "D" instead of an "*". Under the ROW Meas column, an "*" will appear in the list entry for the terminal whose ROW transmission E_b/N_0 and frequency is currently being measured by the NCT. If the network is in the Access mode, then no TDMA slot transmission will be shown, although the ROW measurement will continue.

Should a scheduled ROW TDMA transmission slot occur while a terminal's ROW E_b/N_0 and frequency is being measured by the NCT's auxiliary modem, the terminal will not transmit during its slot. This is normal operation and will not cause a disconnect condition. To ensure that a terminal has adequate opportunities to transmit any status, control or text orderwire messages while ROW measurements are occurring, when the network consists of a small number of terminals, the software will insert additional time to separate sequential ROW measurements.

G-4.4.4 Control Link Status

To view current FOW and ROW link status, open the Link Status Screen (see Figure G-25).

Table G-27 Displaying the Link Status Screen	
1	Select Menu=>Network=>Status=>Link to display the Link Status screen.
2	Select a ROW Link and then select the Modify Tx Parameters button to display the Control Modem Tx Parameters screen.
3	Select a FOW Link and then select the Modify Link Parameters button to display the Link Parameters screen.
NOTE: Select the Close button to close the Link Status screen.	

Although there is only one FOW broadcast link from the NCT to the network, an individual FOW link entry is shown for each terminal. This allows FreqErr, RSL, and Act E_b/N_0 values to be shown as measured by each NT and reported sequentially to the NCT during each NT's TDMA slot transmission. The ROW FreqErr, RSL,

and Act E_b/N_0 values are those measured by the NCT using the auxiliary modem when a secure voice call is not being conducted.
Some ROW link information will be shown in red if the NCT has been unable to measure the ROW link parameters (frequency error, RSL and E_b/N_0) after five sequential attempts. This means that the data shown is old or out of tolerance.

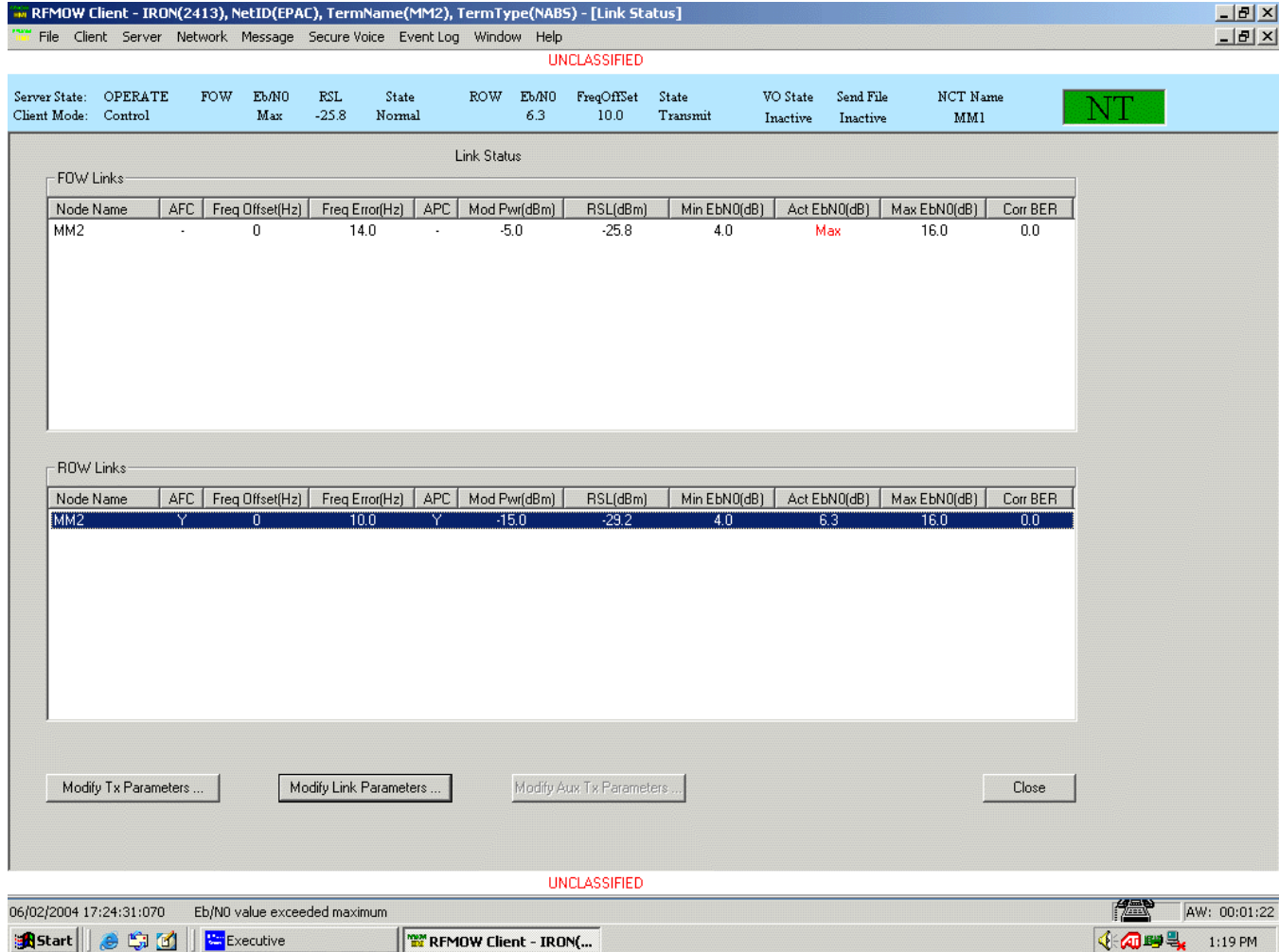

Figure G-25 NT Link Status Screen

The Link Status Screen (Figure G-25) displays the status of all active control links in the network. The display is divided into FOW links and ROW links. A FOW link entry is included for each NT in the network. The purpose of this is to display the FOW related data unique to that NT. The Link Status screen fields are described in Table G-27.

Table G-28 Link Status Screen Fields	
PARAMETER	DESCRIPTION
Name	The name of the link is the terminal name
AFC	A "Y" appears in this column if Automatic Frequency Control (AFC) for the ROW link is enabled, a "N" appears if AFC for the ROW link is disabled, and a "-" appears for all FOW links
Freq Offset	The transmission frequency correction in Hz that has been set within the control modem to compensate for frequency inaccuracies in the earth terminal equipment
Freq Error	The residual error in Hz between the corrected frequency and the actual frequency

Table G-28 Link Status Screen Fields	
PARAMETER	DESCRIPTION
APC	A “Y” appears in this column if Automatic Power Control (APC) for the ROW link is enabled, a “N” appears if APC for the ROW link is disabled, and a “-“ appears for all FOW links
Mod Pwr	The transmit power of the source modem of the link in dBm (measured, not operator entered)
RSL	The Receive Signal Level in dBm obtained from the destination modem
Min Eb/N0	A minimum E_b/N_0 threshold, in dB, set for alarming purposes
Act Eb/N0	The measured E_b/N_0 value of the link at the destination modem in dB. This will be displayed as MAX if the value is greater than 16.0 dBm due to modem limitations.
Max Eb/N0	A maximum E_b/N_0 threshold, in dB, set for alarming purposes
BER	The Corrected Bit Error Rate of the link obtained from the destination modem

For a FOW link, the Frequency Error, RSL, Act E_b/N_0 , and Corr BER entries on this screen are the values that are measured by each NT in the network and reported to the NCT. For a ROW link, these values are measured by the NCT’s auxiliary modem as a part of the normal background ROW measurement process.

Automatic Frequency Control (AFC) only applies to ROW links. If a “Y” is set for a ROW link, then the offset of the NT’s control modem transmit frequency will be automatically adjusted to minimize the error between the actual received frequency and the expected frequency each time the NCT performs a ROW measurement of the NT’s ROW. The Frequency Offset field will be updated anytime the offset is adjusted to correct for any frequency error; the Frequency Error field shows any residual error. For the SDM-300A modem used in RFMOW, the modulator frequency can only be set in +/- 2.5 kHz increments. Therefore, the Frequency Offset will always be in increments of 2.5 kHz, and any remaining Frequency Error will be within +/- 1.25 kHz. To ensure efficient ROW operation, the NCT should receive ROW signals with a minimum frequency error. During login, ROW transmit frequency is automatically adjusted to minimize any frequency error. If enabled, AFC will maintain this error within +/- 1.25 kHz during normal operations. Since an NT, once logged into the network, continuously tracks the FOW, a slowly changing FOW frequency error will not affect normal network operations.

Automatic Power Control (APC) only applies to ROW links. A “Y” set for an NT ROW link will cause the NCT to automatically adjust the NT’s control modem modulator power such that the ROW E_b/N_0 is maintained at the required value. If the terminal is found to be peaked up on the satellite and the automatic adjustment of the modem’s modulator power level reaches either limit of the possible settings, the terminal operator will be informed and will have to follow the power balancing/alignment procedure in Appendix F (Power Balancing/Alignment Procedure) to reconfigure the terminal attenuators external to RFMOW.

Mod Power is the current output power of the terminal’s control modem modulator. The same value will be shown for all FOW links representing the control modem modulator setting at the NCT. If APC is enabled for a ROW link, the value for that link will change as link adjustments are made to compensate for rain fades, antenna-tracking errors, or other problems that affect link quality.

RSL, Act E_b/N_0 and Corrected Bit Error Rate (CBER) values are gathered from the modem on the receive side of the link. They provide the operator with information about the “quality” of the link and are used when the operator is responsible for manually adjusting the transmitting modem’s power level. The E_b/N_0 provides some feedback on what is happening on the link (e.g., if the E_b/N_0 starts to drop, then perhaps the satellite antenna is no longer tracking the satellite properly or the link is experiencing rain fade). The CBER also provides the same sort of feedback. The Receive Signal Level gives feedback on the strength of the received signal. It is possible for the E_b/N_0 of the signal to be acceptable and for the RSL to be too low. If the RSL is close to the lower limit of the modem (typically -55 dBm), then even though the signal is error free (a high E_b/N_0), the dynamic range of the modem may be exceeded and the lock on the carrier may be lost.

Min and Max E_b/N_0 are operator settable values (see Figure G-26). Should the Act E_b/N_0 for a link fall outside these thresholds, the link entry on the Link Status Screen will turn red. Both an NT and NCT operator can

independently set these thresholds. These independent thresholds apply only to the Link Status screen of the local terminal.

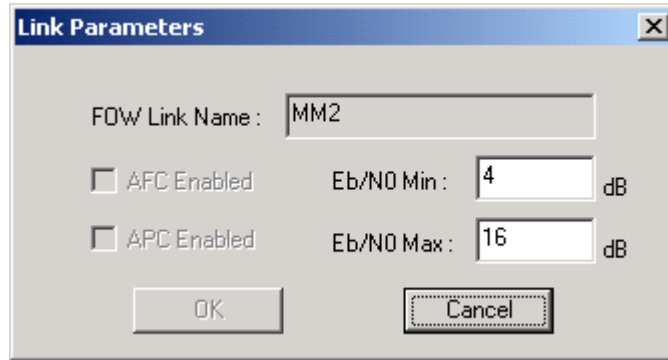

Figure G-26 FOW Link Parameters Screen

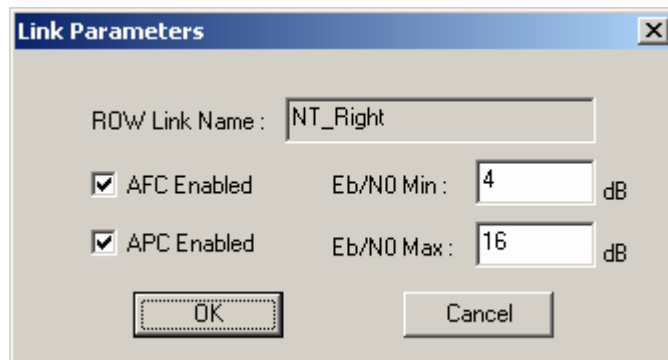

Figure G-27 ROW Link Parameters Screen

AFC, APC and Min and Max E_b/N_0 values may be changed by scrolling the link selection highlight to the desired link and pressing the Modify Link Parameters button at the bottom of the Link Status Screen. The Figure G-28 – ROW Link Parameters Screen contains check boxes that are disabled to the NT operator. The screen also contains entry fields to allow changing of Min and Max E_b/N_0 values.

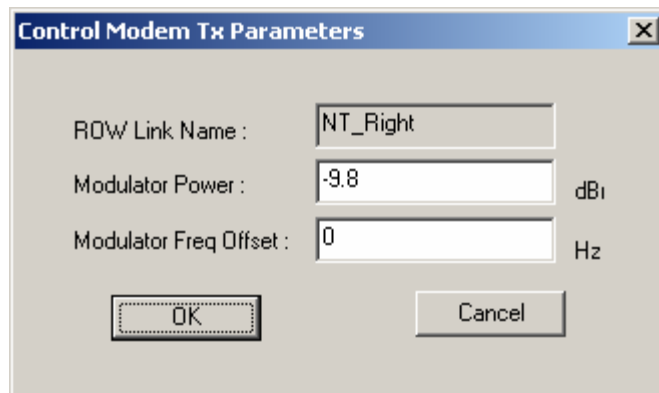

Figure G-28 ROW Control Modem Tx Parameters Screen

Frequency Offset and Mod Power values, when not being automatically maintained, can be manually set by pressing the Modify Tx Parameters button at the bottom left of the Link Status Screen. The Control Modem Tx Parameters dialog that appears (Figure G-28) contains entry fields to allow changing the control modem

modulator power and the link frequency offset. Since the terminal is an NT, then only the ROW link transmitted from the terminal will be modifiable.

G-4.4.5 Manually Commanding and Viewing Modem Status

Command messages sent by the PC/Controller to the control and auxiliary modems, and response messages sent from the modems to the PC/Controller can be viewed on the Send Native Hardware Command Screen (see Figure G-29). The current commands being issued by the terminal operator and their results are displayed as they occur. Any terminal can change the operating parameters of its own modem(s); only the NCT operator can modify parameters of other terminals' modems. Any terminal can also view modem status from other terminals.

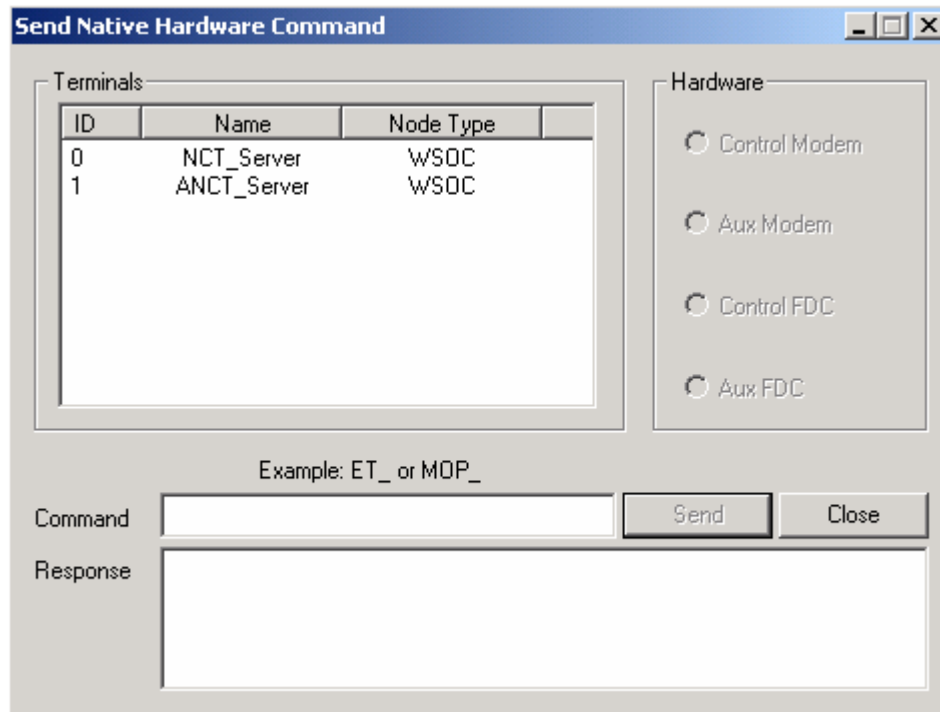

Figure G-29 Send Native HW Command Screen

Table G-29 Sending Native Hardware Commands	
1	Select Menu=>Server=>Send HW Command on the main menu to display the Send Native Hardware Command screen.
2	Select the terminal whose modem will be issued a command by clicking on the terminal name in the Terminals window.
3	Select the modem to be commanded from the Hardware window. NTs cannot issue commands to the local down converter since it is not controlled by the RFMOW system. No auxiliary modem is present in the NT terminal configuration.
4	Enter the modem command in the Command field. The commands for the specific modem used in the terminal can be found in the user's manual for that equipment (see Appendix A - References).
5	Click the Send button to issue the command to the equipment. The response from the modem will be displayed in the Response window. If the NT issues a command to a remote terminal, a response will not be displayed until the response is transmitted to the NCT from the remote terminal during its TDMA slot.
NOTE: To close the Send Native Hardware Command screen, click the Close button.	

NOTE: The RFMOW always precedes a command sequence with a command placing the modem in the remote control mode. If the operator attempts to place the modem in the local mode from the modem front

panel controls, the next RFMOW command will place the modem back into the remote mode. If it is necessary to manually command a modem, the RFMOW should be in the Idle or Standby states.

G-4.5 Maintaining Network Operations

The following paragraphs provide the procedures for adjusting the various network-operating parameters to maintain proper network operation.

G-4.5.1 Turning Interface Unit Audio Alarm On and Off

Table G-30 Turning On and Off the Interface Unit Audio Alarm	
1	If the audio alarm is currently set to on (default), select Menu=>Server=>Disable Audio Alarm to turn it off. This will prevent critical alarms from sounding the interface unit audio module.
2	If the audio alarm is currently set to off, select Menu=>Server=>Enable Audio Alarm to turn it on. This will enable critical alarms to sound the interface unit audio module.

The menu label will change to reflect the new state of the audio alarm.

G-4.5.2 Monitoring and Maintaining the Control Links

See paragraph G-1.5.5.4 (Control Link Status) for information on opening the Link Status screen.

The maintenance of the control links (FOW and ROW) for the RFMOW network is the responsibility of the NCT. NT operators at the request of the NCT can assist these activities.

Link frequency offset, transmit power and Min and Max E_b/N_0 alarm values can be changed from this screen. Follow the adjustment procedure for the desired parameter in the following paragraphs.

Note that the NCT can change link parameters for all links, that is, the FOW and all ROWs. An NT can only change link parameters for his ROW link although he can see the parameters for all links.

G-4.5.3 Manually Adjusting Control Modem Power During Operation

Table G-31 Manually Adjusting Control Modem Power During Operation	
1	From the Link Status screen select the link to be modified from the ROW Links window.
NOTE: NTs may view any link transmit power, but will only be allowed to change the local control modem transmit power. The NCT may change the transmit power on any control or auxiliary modem. ANCTs will only be allowed to change the local control and auxiliary modem transmit power.	
2	Click the Modify Tx Parameters button. This will open the Control Modem Tx Parameters screen (Figure G-31).
3	Enter the new Modulator Power and/or Modulator Freq. Offset in the appropriate field.
4	Click OK to command the modem to the new values.
NOTE: To close the Control Modem Tx Parameters dialog without making any changes, click Cancel.	

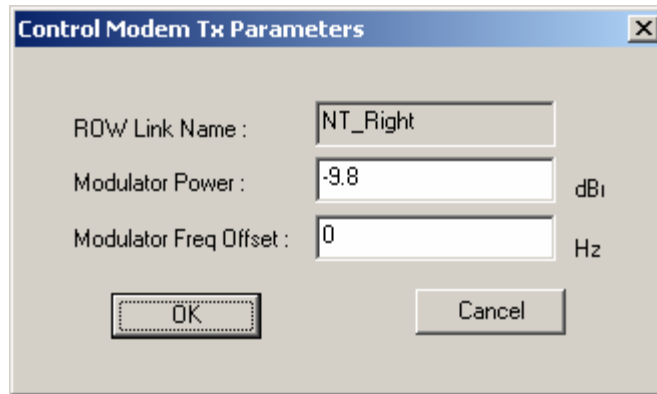

Figure G-30 Control Modem Tx Parameters Screen

The ROW control links require relatively low terminal transmit power. As a result, if the terminal has been configured properly, the control modem output power should be around - 15 dBm. The maximum output power is - 5 dBm, so adequate adjustment margin should be available to compensate for weather changes of 3-6 dB.

WARNING: Care must be taken to ensure that the total power into the control link up converter is below the converter's maximum linear operating point. In the AN/TSC-85D(V)1 AND AN/TSC-93D(V)1 terminals, the converter is shared with a communications link. Overdriving the converter input will result in intermodulation signals being generated in the converter and transmitted to the satellite. These signals can interfere with other communications signals on the satellite. Correct operation can be ensured at the NT by performing the alignment procedure (see Appendix F).

G-4.5.4 Manually Adjusting ROW Link Frequency Offset

The ROW Link Frequency Offset may be changed by the operator. This will allow the operator to compensate for equipment inaccuracies.

Table G-32 Manually Adjusting ROW Link Frequency Offset During Operation	
1	From the Link Status screen select the link to be modified from the ROW Links window.
NOTE: NTs may view any link frequency offset, but will only be allowed to change the local control modem frequency offset.	
2	Click the Modify Tx Parameters button. This will open the Control Modem Tx Parameters screen (Figure G-31).
3	Enter the new Modulator Power and/or Modulator Freq. Offset in the appropriate field.
4	Click OK to command the modem to the new values.
NOTE: To close the Control Modem Tx Parameters dialog without making any changes, click Cancel.	

G-4.5.5 Setting Min and Max Eb/N0

Min and Max E_b/N_0 values only apply to the local terminal. Therefore, both an NT operator and an NCT operator can set independent values for the same ROW or FOW link.

Table G-33 Setting Min or Max Eb/N0 Alarm Thresholds for a Link	
1	Highlight the desired link on the Link Status Screen.
2	Click the Modify Link Parameters button. The Link Parameters screen will open (see Figure G-27 and G-28).
3	Enter the new values in the desired fields.
4	To close the dialog and save the new value(s), click the OK button at the bottom of the dialog. The values will be saved and the dialog will close.
NOTE: To close the dialog without saving the values, select the Cancel button.	

G-4.5.6 Detach from Server/Stop Server

A control client has the ability to stop the server from the client. A new server can then be started and the already running client can then be attached to it. The server should not be stopped during normal network operation. Rather, the operator should logout from the network before stopping the server.

Table G-34 Detach from Server/Stop Server	
a. Stopping the server	
1	The control client must select Menu=>Stop Server from the main menu. Before stopping the server, the operator will be notified of other clients connected to that server.
b. Detaching from the server	
NOTE: Both monitor and control clients can detach from the server.	
1	Select Menu=>Client=>Detach from Server on the main menu. If the control client is detaching, a server control handover is performed provided other clients are attached to the server (see next paragraph).

NOTE: If the server is accidentally stopped, the RFMOW client software will continue to run, but since the client is connected to the network via the server, the client will be effectively detached from the network. Restarting the server and reattaching the client quickly may allow an NT to continue network operations without logging back in.

G-4.5.7 Server Control Handover

As noted in Login Multiple Clients (paragraph G-4.2.1), multiple clients (one control client and any number of monitoring clients) may be attached to a server at one time. The capability to control the server is given only to the Control client, but can be exchanged between clients by two mechanisms. There can be many Monitor clients at one time, but there is only one Control client for each server.

Table G-35 Server Control Handover	
a. Transferring server control to a monitor client	
1	At the control client, select Menu=>Client=> Handover Server Control on the main menu. A list of available clients will be displayed that are ready to assume control.
2	Select a client from the list.
3	Click the Select button to transfer control.
NOTE: To close the screen without transferring server control, Select Cancel.	
b. Requesting server control from the control client	
1	At the monitor client, Select Menu=>Client=>Request Control on the main menu. The operator of the control client will be prompted for permission to transfer control to the requesting monitoring client. Only the menu option corresponding to the requesting client will be sensitive for operator selection.
2	At the control client, select Yes or No depending on whether you should relinquish the control client.

G-5 OPERATION UNDER UNUSUAL CONDITIONS

G-5.1 Disconnect

If an NT loses the FOW or an NCT fails to receive ROW transmissions from an NT, the NT will be put into the DISCONNECT state. The DISCONNECT state is in effect a hold condition pending correction of the FOW or ROW problem. If the condition is corrected in less than 15 minutes, the NT in general will be able to resume normal operations without requiring a login and all interrupted text messages will be delivered. Conversely, if the problem persists for longer than 15 minutes, the NT operator will have to manually log back into the network. Any pending messages addressed to the DISCONNECTED NT will be undelivered and the senders of the messages will be notified that the message was undeliverable.

G-5.1.1 Entering and Recovering from the DISCONNECT State

The state of an NT will change to DISCONNECT if any of the following conditions occur:

- a. The FOW signal is lost, that is, the NT control modem demodulator loses synchronization for a period of 1 minute.
- b. The network is in the Operate mode but no valid messages from the NCT are received over the FOW for a period of 1 minute.
- c. The NCT does not receive a ROW TDMA transmission from the NT for a period of 1 minute plus two consecutive TDMA frames.

NOTE: See Chapter 3 for troubleshooting procedures.

The loss of the FOW (cases a. and b., above) can be caused by either a local FOW receive problem at the NT or a FOW transmit problem at the NCT. In either case, when the NT detects a loss of FOW condition, it will cease any ROW TDMA transmissions, place itself in the DISCONNECT state and, popup an alert message to the operator.

Failure of the NCT to receive any ROW transmissions (case 3) from an NT can be caused by a local transmit problem at the NT, a receive problem at the NCT, or will result if the NT ceases ROW transmission due to a FOW transmit problem at the NCT. In any of these cases, the NCT will send a message to the NT placing it in the DISCONNECT state. An alert message will be displayed to the operator on both the NCT and the NT.

If the NT operator is alerted that the local terminal has been placed in the DISCONNECT state by the NCT due to loss of ROW, then the FOW is still being received and the problem is either a local NT transmit failure or NCT receive failure. The NT operator should take immediate action to determine and correct any local transmit problem.

If the NT operator is alerted that the local terminal has placed itself in the DISCONNECT state due to loss of FOW, then the problem is either an NCT transmit failure or local receive failure. The NT operator should take immediate action to determine and correct any local receive problem.

If this condition persists for 15 minutes, the NCT and the NT will automatically log the NT out of the network. To rejoin the network, the NT operator must follow the normal login procedure (see paragraph G-4.1, Network Login). In order to recognize a network membership change during a disconnect outage, the NT waits for the next "Bulletin Board" message, which contains the schedule start time. If the problem is corrected in less than 15 minutes, then the NT will automatically rejoin the network without requiring operator action and any stored text orderwire messages destined to the NT will be delivered. If the network membership has not changed during the Disconnect outage, then the current network TDMA frame will be unchanged; the NT can simply start transmitting its ROW transmission in its assigned TDMA slot. If the network membership has changed, the NT will have to wait for a TDMA Schedule message to determine the location of its new TDMA slot. It can then begin transmitting its ROW in its new assigned slot. If the network switches to access mode before the NT has successfully recovered, the NT will attempt to re-login during the access window. This will prevent the NT from being automatically logged out of the network by the NCT, in the case that its disconnect time exceeds 15 minutes during the access window.

G-5.1.1.1 NT Recovery from Loss of ROW or FOW

If a FOW transmit failure occurs at the NCT, then all NTs in the network will detect the loss of FOW and revert to the DISCONNECT state. In this state, they will cease transmitting the ROW in their assigned TDMA slots. Should this happen, or should an NCT ROW receive failure occur, the NCT, after receiving no NT ROW transmissions for a period of 1 minute and two consecutive TDMA frames, will put all NTs in DISCONNECT state and alert the NCT operator. The NCT will continue to attempt to receive ROW messages. If no ROW transmissions are again received from any NTs for 15 minutes, the NTs are logged out, and the operator will again be alerted. The NCT will then enter Access Mode and wait for the NTs to log back into the network. The NT operator should take immediate action to determine and correct any local transmit or receive problem(s).

G-5.2 Terminal Logout

G-5.2.1 Logging Out of the RFMOW Network

Logout is applicable to an NT only.

Table G-36 Logging out of the Network	
1	Select Menu=>Network=>Logout from the main menu. When the logout is selected, a Logout Request message is sent to the NCT.
2	At the NCT, if the logout lock has been selected for the NT, then select Yes or No to approve or disapprove the NT's logout request. If logout lock has been deselected, no NCT approval is necessary.
3	At the NT, if the logout was approved, then the terminal will logout and the terminal state will be set to Standby.
4	At the NT, if the logout was not approved, a message box will appear giving the operator the choice to log out anyway. If the NCT has not given permission to logout, then only under extreme circumstances should the NT operator choose to logout. If Yes is selected, logout will occur. If No is selected, normal network operations will resume.
5	If no response is received from the NCT, the operator on the NT is given the option to force a local logout.

G-5.2.2 NT Emergency Logout

All NT logouts follow the method described in the above paragraphs. If the NT does not receive a response from the NCT within a reasonable time period, or if the NCT operator denies the logout request, the NT operator is given the option of force logout from the network. This allows the NT to shutdown his equipment in an emergency situation when communication with the NCT has been lost.

<p>WARNING: The NT operator should perform a forced logout only if the terminal must be immediately shutdown, or if the RFMOW software has failed in an apparently non-recoverable, but still executing, state. To rejoin the network, the operator must perform a normal login. The re-login attempt will be made during the next access window.</p>
--

G-5.3 Additional Functions

G-5.3.1 Packet Statistics

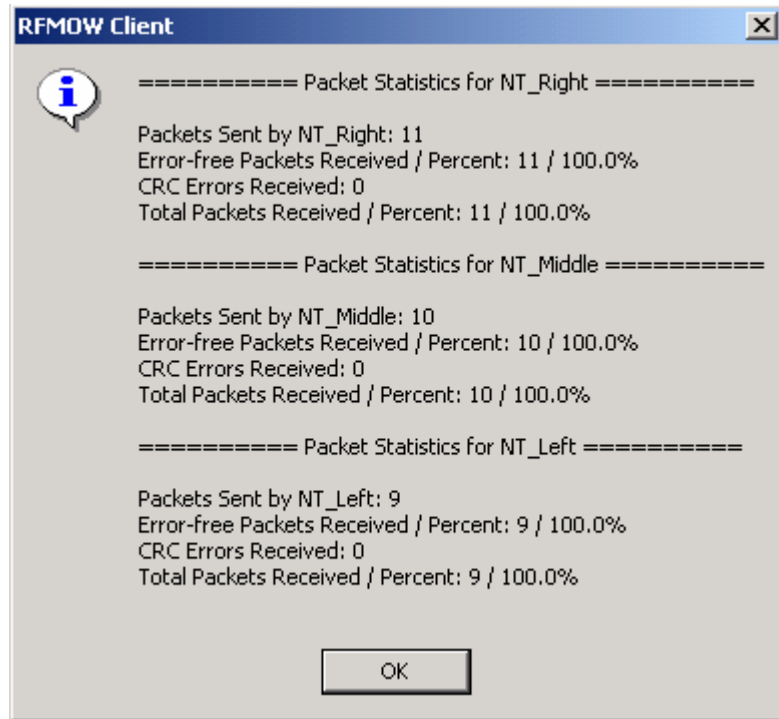

Figure G-31 Packet Statistics Screen

The Packet Statistics screen (Figure G-31) gives the operator some feedback on the efficiency of the packet transmissions on each receive link. For the NCT it shows the packets statistics for each of the NTs logged into the network. When packet statistics are viewed on an NT node, only one set of statistics will be seen since all packets are received from the NCT.

Table G-37 Viewing Packet Statistics	
1	To view packet statistics, select Menu=>Network=>Packet Statistics. The Packet Statistics screen will be displayed.
2	Click OK to close the Packet Statistics screen.

G-5.3.2 Information Message Boxes

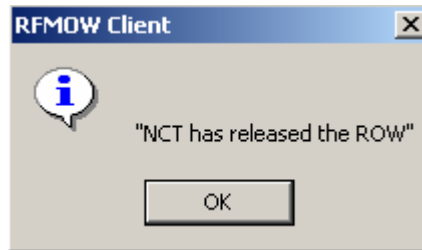

Figure G-32 Information Message Box

An information message box such as shown in Figure G-32 will pop up anytime the operator makes an error in entering data into a data entry field, confirmation of an action is required, or there is a need to provide information to the operator. For a confirmation message, Yes and No buttons will allow the operator to confirm the specified action.

G-5.3.3 Error Message Boxes

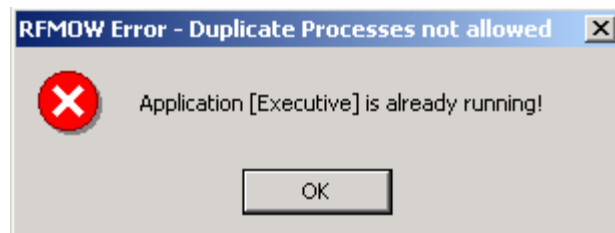

Figure G-33 Error Message Box

An error message box such as shown in Figure G-33 will pop up anytime RFMOW encounters an error. For error boxes, an OK button allows the box to be closed.

G-5.3.4 Alert Message Boxes

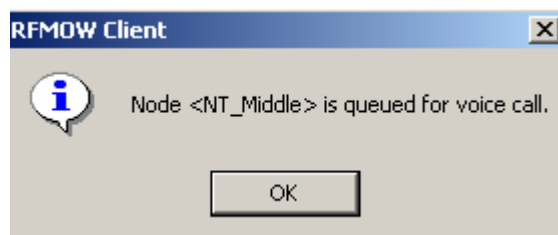

Figure G-34 Alert Boxes

An alert box such as shown in Figure G-34 will pop up anytime an event occurs that the operator should be aware of, or if the operator needs to take action. If the alert is urgent, the entire box will blink. Alert boxes are used to notify the operator of key network events such as a terminal login, receipt of an urgent text message or a secure call setup. They are also used to notify the operator of failure events such as the loss of the FOW signal. The alert box will include an OK button with which the operator may dismiss the dialog from the screen.

G-5.3.5 Manually Saving and Deleting Log Files

Log files can grow rapidly in size and number particularly if debug logging is enabled. This may require periodic manual log file and hard disk maintenance by the terminal operator.

Table G-38 Saving Log Files to an External Medium and Deleting them from the Hard Disk	
1	Determine the external medium on which to save the log files. This could be any of a number of choices including floppy disk, CD-R, DVD-R, USB jump drive, etc.
2	Insert/attach the external medium to the computer.
3	Select "My Computer" from the Windows desktop by double clicking on it with the mouse.
4	Use the mouse to navigate to C:\H\RFMOW\BIN on the hard disk. There will be three directories containing RFMOW log files within the C:\H\RFMOW\BIN directory. They are named "ServerLogs", "ClientLogs" and "MessageLogs". Refer to the Windows Reference Manual or Microsoft.com for more information on Windows navigation.
NOTE: The default installation directory for RFMOW is C:\H\RFMOW\BIN. If the RFMOW was installed in a different directory, the log file directories will be found in that directory.	
5	Use the mouse to navigate to the "MessageLogs" directory.
6	Select the files to be saved. Refer to the Windows Reference Manual or Microsoft.com for more information on selecting files.
7	Copy the files to the desired medium. Refer to the Windows Reference Manual or Microsoft.com for more information on copying files.
8	Now that the log files have been saved, delete them from the "MessageLogs" directory. Also be sure to empty the Recycle Bin on the Windows Desktop. Refer to the Windows Reference Manual or Microsoft.com for more information on deleting files and emptying the Recycle Bin.
NOTE: The message log, server log, and/or client log files currently being used by RFMOW may not be able to be deleted. Ignore this file and delete the others.	
9	Return to the C:\H\RFMOW\BIN directory or other directory where RFMOW has been installed.
10	Repeat steps 5 through 9 above to save and delete files from the "ServerLogs" directories.
11	Repeat steps 5 through 9 above to save and delete files from the "ClientLogs" directories.
NOTE: Depending on the size of the hard disk, this procedure will have to be executed periodically to ensure that all log files are saved before the RFMOW deletes them automatically at 80% hard disk utilization.	

This page left blank intentionally.

APPENDIX H

GLOSSARY

ACRONYMS AND ABBREVIATIONS

The acronyms and abbreviations used in this manual are defined below:

Abbreviation or Acronym

AC	Alternating Current
ACK	Acknowledgment
AFC	Automatic Frequency Control
ANCT	Alternate Network Control Terminal
APC	Automatic Power Control
ASAP	As Soon As Possible
AW	Access Window
BB	Bulletin Board
BDI	Black Digital Interface
BER	Bit Error Rate
BLK	Black
BPSK	Binary Phase Shift Keying
C	Celsius
CAGE	Commercial and Government Entity
CD-R	Compact Disc-Recordable
CIK	Cryptographic Ignition Key
cm	Centimeter
CMA	Control Monitor and Alarm
COM	Serial Communications Port
COMM	Communications
COMSEC	Communication Security
contRXC	Continuous Terminal Receive Clock
contTXC	Continuous Terminal Transmit Clock
CPU	Central Processing Unit
CRC	Cyclic Redundancy Check
CTRL	Control
D/C	Down Converter
dB	Decibel
dBm	Decibel-milliwatts
DCD	Data Carrier Detect
DEL	Delete
DEMUX	Demultiplexer
DISA	Defense Information Systems Agency
DTR	Data Terminal Ready
E_b/N_0	Energy per Bit / Noise Density
EIA-530	High Speed 25-Position Interface for Data Terminal Equipment and Data Circuit- Terminating Equipment
EIR	Equipment Improvement Recommendations
EQUIP	Equipment
ESD	Electrostatic Discharge
F	Fahrenheit
FDMA	Frequency Division Multiple Access
FDX	Full Duplex with end-around synchronization
FDX TR	Full Duplex
FIL I/F	Fill Port Electrical Interface
FOW	Forward Orderwire

Abbreviation or Acronym

Ft	Feet
GND	Ground
GHz	Gigahertz
GMF	Ground Mobile Forces
GUI	Graphical User Interface
Hi	High
HPA	High Power Amplifier
Hz	Hertz
I/F	Interface
I/O	Input/Output
ID	Identification
IF	Intermediate Frequency
in.	Inch(es)
IRON	Inter-Range Operation Number
IU	Interface Unit
JP	Jumper
kg	kilograms
KG-84	Crypto Device
KHz	Kilo hertz
KIV-7	Crypto Device
KVM	Keyboard/Video (Monitor)/Mouse
lbs.	Pounds
LCD	Liquid Crystal Display
AN/TSC-152 AND AN/USC-59	Light Mobile Satellite Terminal
LNA	Low Noise Amplifier
Lo	Low
M&C	Monitor & Control
MAC	Maintenance Allocation Chart
MB	Megabyte
MHz	Megahertz
MMT	Multimedia Terminal
MS-DOS	Microsoft Disk Operating System
MUX	Multiplexer
AN/TSC-85D(V)1 AND AN/TSC-93D(V)1	NATO Airbase Satellite Terminal
NCT	Network Control Terminal
NSN	National Stock Number
NT	Network Terminal
OEM	Original Equipment Manufacturer
OP2	Sync selection of KIV-7
OW	Orderwire
oz.	Ounce
PC	Personal Computer
PC/Controller	Personal Computer / Controller
PCB	Printed Circuit Board
PCMCIA	Personal Computer Memory Card International Association
PMCS	Preventive Maintenance Checks and Services
PS/2	Personal System/2
PWR	Power
RCV	Receive
RF	Radio Frequency
RFMOW	Replacement Frequency Modulated Orderwire
RGB	Red-Green-Blue
RMA	Return Merchandise Authorization
ROW	Return Orderwire
RQ	Requested
RS&CS	Override Request-to-Send (PTRS) and Clear-to-Send (CTCS)

Abbreviation or Acronym

RS-232	Serial Binary Data Interchange standard
RSL	Receive Signal Level
RTS	Ready to Send
RX	Receive
SAA	Satellite Access Authorization
SATCOM	Satellite Communications
SECTEL	Secure Telephone
SEL	Select
SMR	Source, Maintenance, and Recoverability
SOM	Start of Message
Spkr	Speaker
SRA	Specialized Repair Activity
SRx	Secure Voice Receive
STE	Secure Terminal Equipment
STU	Secure Telephone Unit
STx	Secure Voice Transmit
SVGA	Super Video Graphics Array
SVU	Secure Voice Unit
Sync	Synchronize
SyncOOS	Synchronize Out-Of-Sync
T2U	Technical Terminal Units
TDMA	Time Division Multiple Access
TM	Technical Manual
TMDE	Test, Measurement, and Diagnostic Equipment
TRANSEC	Transmission Security
TTY	Teletype
TX	Transmit
U/C	Up Converter
U/M	Unit of Measurement
UUT	Unit Under Test
VO	Voice Orderwire
XMT	Transmit
VAC	Volts AC
VGA	Video Graphics Array
WSOC	Wideband SATCOM (Satellite Communications) Operations Center

This page left blank intentionally.