



**TWIN BOMBINGS AT ZAMBOANGA CITY  
11 AUGUST 2005  
PHILIPPINES**

**SOURCES:**

**PHILIPPINE NATIONAL POLICE  
PHILIPPINE BOMB DATA CENTRE  
AUSTRALIAN FEDERAL POLICE FORENSICS  
AUSTRALIAN BOMB DATA CENTRE**



**AIM**

The aim of this bulletin is to advise bomb technicians, forensics and investigators of the Twin Bombings in Zamboanga City dated 11 August 2005. The result of the Post Blast Reconstruction of evidence recovered and the possible explosive use in the bombing based on the damage assessment at the scene of the crime.

**Background**

On about 101920H August 2005, two (2) bombs exploded in the key City of Zamboanga. First bomb exploded along Campaner St., fronting the Luzon Copra Warehouse which destroyed a Multi-Cab vehicle, damaging nearby houses and injuring six (6) bystanders. Another explosion occurred at about 2000H of same date at the 2<sup>nd</sup> floor of Ann's Pension House located at Gov. Lim Avenue cor. Climaco Avenue destroying the entire 2<sup>nd</sup> floor of the building and damaging the ground floor of Chowking Food Chain which includes portions of the 3<sup>rd</sup> floor emanated by the secondary blast. Total injured on the second explosion were twenty-five (25) passer-bys.

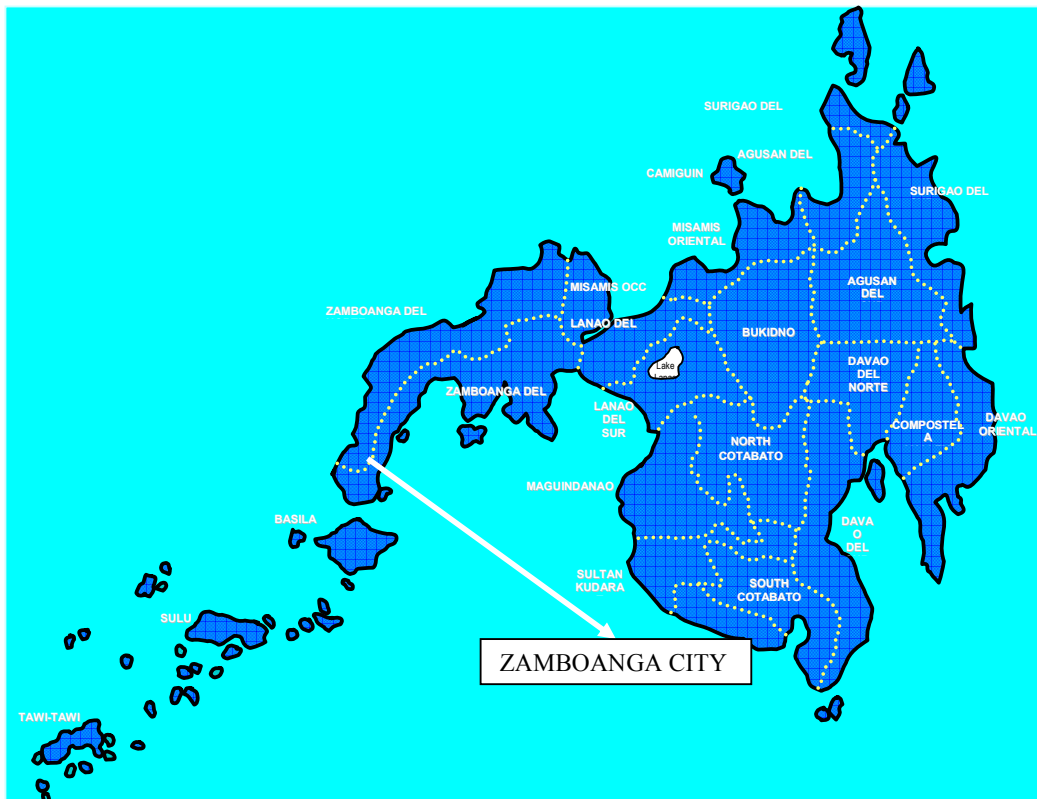
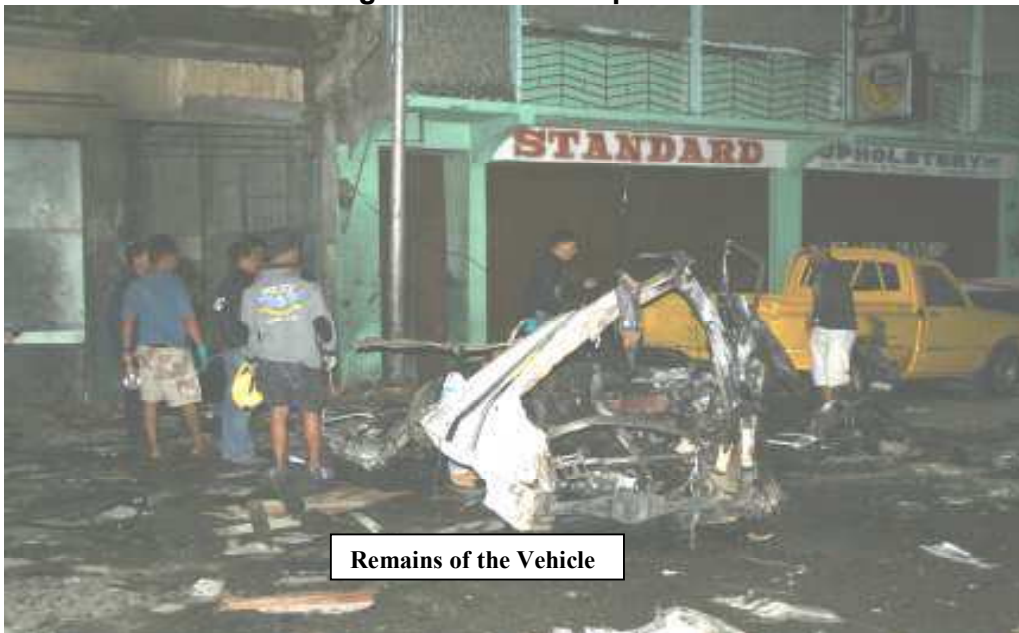

**Figure 1: Map Location of Incidents**

**PHOTOGRAPHS OF THE CRIME SCENE :1<sup>ST</sup> Explosion**



**Figure 2: Site of Explosion**



**Examination of Bomb Scene**

On 11 August 2005 members from the Philippine Bomb Data Centre (PBDC), PNP-SOCO of PRO 9 and EODT-PNP conducted the joint Post Blast Investigation and examination at the Crime Scene at Campaner St and at Ann's Dormitory Pension house with a total number of thirty one (31) injured bystanders. The explosion destroyed the vehicle parked at the vicinity including a nearby establishment which was affected by the secondary blast pressure effect of explosion.

Moving the Crime Scene to a Safer Working Area



Figure 3: Collection of evidence and debris at the scene of the crime along Campaner St.



Figure 4: Other business establishment affected by the blast



**Figure 5: Seat of Explosion found underneath the vehicle measuring about 21"x 4" diameter deep crater**



**Figure 6: Other vehicle affected by the blast**



Figure 7: 2<sup>nd</sup> Explosion at Ann's Dormitory Pension House



Figure 8: Overview of the external damage of the building



Figure 9: Injured victims being treated at the Zamboanga City Public Hospital



Figure 10: Second Floor Plan of the Building (Blue Print)

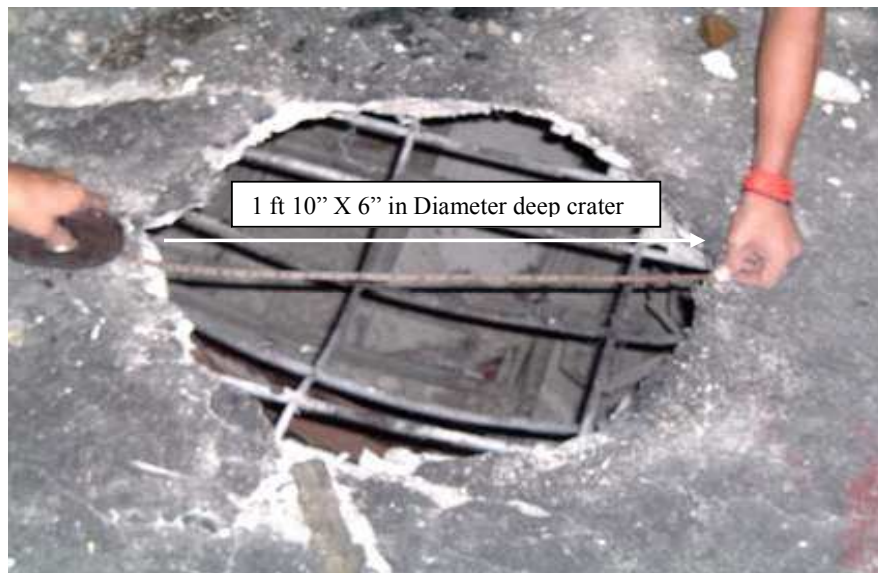

Figure 11: Seat of explosion found at Room 1013



Photographs of the interior damage of the building



Examination at the scene of the crime through Damaged Assesment

No primary fragment was found at the scene. However, based on the debris, venting of steel bars, pushing of metal from structure and the crater effect on the floor suggest a HIGH EXPLOSIVE was used in the device. A large amount of metal fragments were found scattered throughout the scene. The pushing of the sidewalls and concaving of the floors indicate of a multiplying blast pressure effect due to confinement of the rooms and of the building. The explosive effects are very common to the effects of a chlorate based explosive mixture of Potassium Chlorate mixed with sulfur and alluminum powder also known as the "dirty white powder". No other traces of explosive residue were found by the team from scene of the crime office (SOCO) except positive to the traces of nitrates in both explosion incidents.



Debris at the second floor



Concave ceiling at the ground floor



Crack concrete ceiling cause by strong pressure



Exit Crater of the seat of explosion

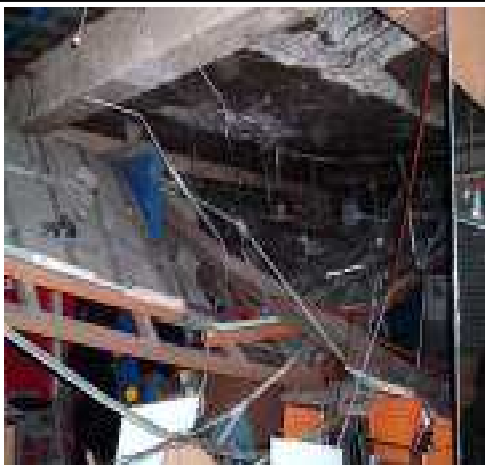

Damaged portion at the ground floor



Detached steel beam cause by downward pressure



Parts of the Alarm Clock

**Evidence recovered at the 1<sup>st</sup> Explosion (Multi- Cab Vehicle)**

- a) Several small parts of an alarm clock
- b) Disintegrated parts of possible 9 volts battery
- c) Swab samples taken by PRO 9, SOCO tm from the crime scene for chemical / laboratory analysis



Evidence recovered at the 2<sup>nd</sup> Explosion



Possible parts of the clock



Empty six (6) boxes of alarm clock recovered at the hotel

Recovered at 2<sup>nd</sup> Explosion (Ann's Dormitory Pension House)

- a) Several pieces of possible parts of a 9 volts battery
- b) Six (6) empty carton boxes of alarm clock made from Korea, Japan and China respectively.
- c) Twisted and vent metal parts of the steel bed of room 1013
- d) Swab samples taken by PRO 9 SOCO for chemical/laboratory examination.

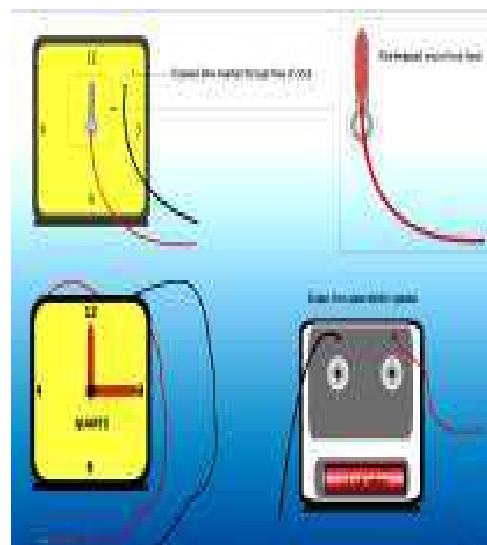
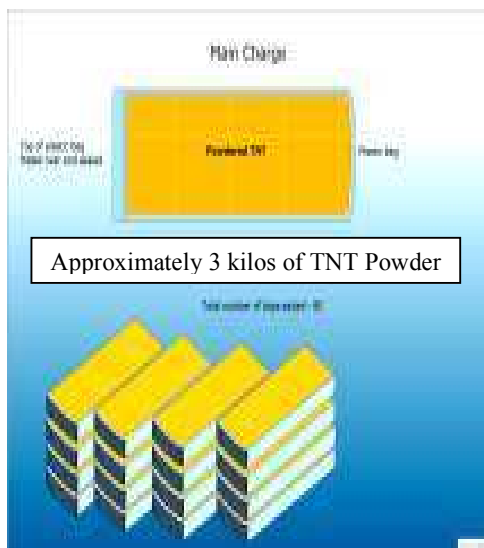



Possible connection from the alarm clock

Close-up of interior of timer...

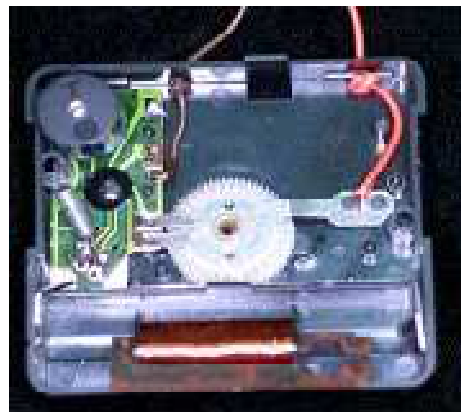

**EVIDENCE RECOVERED AT THE SCENE OF EXPLOSION**

All specimens taken by PRO 9 SOCO tm for chemical/laboratory examination turned out to be negative of any explosive traces, however, positive to the traces of nitrate. Contrary on the damage on the vehicle and structures of the building indicates a chlorate base explosive mixtures commonly used by JI-ASG. This type of explosive mixtures were introduced by the so called JEMAAH ISLAMIAH, the ASIAN Terror Group responsible in most cases of bombings in the south and in Manila. The JI is also responsible for Bomb Making and explosive demolition trainings to the local terrorist groups which is being held every quarter of the year like by the JI- ASG, RSM, KHALID Trinidad Group, MILF/MNLF lost Command and MILF- SOG.

**Possible Motives of the Bombings**

- a) Diversionary tactics of the JI-ASG due to the on – going military operations against KHADAFY JANJALANI in central part of Mindanao
- b) Test mission of their new graduates on bomb making for 3rd quarter of the year
- c) Field test of their explosive mixtures
- d) Possible part of their main event planned bombing during the 4<sup>th</sup> quarter of the year 2005

Comparative analysis of the post blast reconstruction of evidence recovered at the said twin bombings showed strong similarities to the signatures of the IED’s use in the past bombing incidents. The attempted bombing of Koronadal Public City Market last July 10, 2005 and the Zamboanga bombing are related to each other and may be prelude to their main event, to conduct bombing between October-December 2005.

The possible lay-out of the circuitry and schematic diagram of the device use based on the evidence recovered at the scene of the crime both on the multi- cab at Campaner St. and at Ann’s Dormitory Pension House located at corner Gov Lim Avenue St. in Zamboanga City.

**Circuit Diagram**

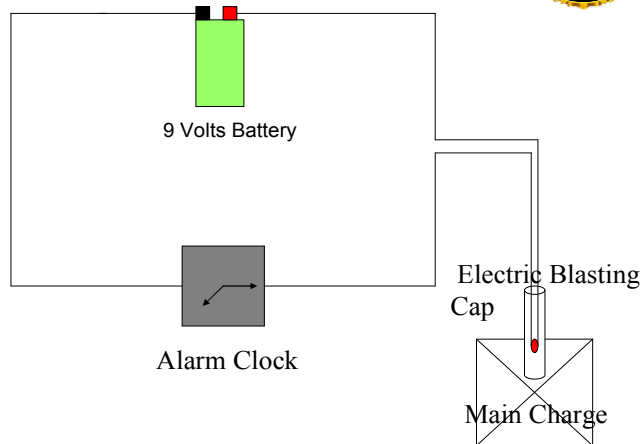

**CONCLUSION**

Detailed study regarding the chain of events with respect to the past and recent bombing incidents tells that for every quarter of the year, incidents of either bombings or attempted bombing will most likely to occur. This also coincides with the actual test run of the new graduates on bomb-making. The said training was taught by the JI in three (3) separate locations near the main camp of the MILF in Maguindanao. A very alarming situation was also noted because the devices now being used by the different terrorist groups belong to the signature of DR AZAHARI and DULMATIN, who are known JI leaders responsible for the Bali and Marriot Bombings. Now, they are using a cell phone activated device, an ITC board or 555 Timer with SCR or a combination of either of the two (2) which are further integrated with PC board that serves as the switch enhancer to make the device function. These devices are also known to AL- Qaeda who is also responsible for the actual training of our Muslim brothers during the Afghan War. Such training is usually re echoed to the ASG and the Rajah Solaiman Movement (RSM), headed by Ahmed Santos.

In addition, a similar incident is perceived to occur in the near future considering the discovery of six (6) empty boxes of alarm clock believed to be the same clock used on the twin bombings.