

---

# Machine Guns and Machine Gun Gunnery

---



---

**U.S. Marine Corps**

DEPARTMENT OF THE NAVY  
Headquarters United States Marine Corps  
Washington, D.C. 20380-0001

1 September 1996

Foreword

1. PURPOSE

Marine Corps Warfighting Publication (MCWP) 3-15.1, *Machine Guns and Machine Gun Gunnery*, describes how various machine guns are maintained and employed by the U.S. Marine Corps' machine gun crews. It also provides the principles and techniques for their use in engaging and destroying enemy targets.

2. SCOPE

This reference publication is designed for machine gunners, platoon commanders, platoon sergeants, S-3 officers and chiefs, armorers, and ammunition technicians. It outlines a standardized way to train Marine machine gunners through the use of gunnery tables.

3. SUPERSESSSION

FMFRP 6-15, *Machineguns and Machinegun Gunnery*, dated 17 August 1988.

4. CHANGES

Recommendations for improving this manual are invited from commands as well as directly from individuals. Forward suggestions, using the User Suggestion Form format, to—

Commanding General  
Doctrine Division (C 42)  
Marine Corps Combat Development Command  
3300 Russell Road Suite 318A  
Quantico, Virginia 22134-5021

5. CERTIFICATION

Reviewed and approved this date.

BY DIRECTION OF THE COMMANDANT OF THE MARINE CORPS

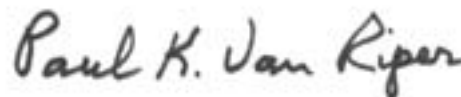

PAUL K. VAN RIPER  
Lieutenant General, U.S. Marine Corps  
Commanding General  
Marine Corps Combat Development Command  
Quantico, Virginia

DISTRIBUTION: 143 000014 00

## User Suggestion Form

From:

To: Commanding General, Doctrine Division (C 42), Marine Corps Combat Development Command,  
3300 Russell Road Suite 318A, Quantico, Virginia 22134-5021

Subj: RECOMMENDATIONS CONCERNING MCWP 3-15.1, *MACHINE GUNS AND MACHINE GUN  
GUNNERY*

1. In accordance with the foreword to MCWP 3-15.1, which invites individuals to submit suggestions concerning this FMFM directly to the above addressee, the following unclassified recommendation is forwarded:

<u>Page</u>	<u>Article/Paragraph No.</u>	<u>Line No.</u>	<u>Figure/Table No.</u>
Nature of Change:	<input type="checkbox"/> Add		
	<input type="checkbox"/> Delete		
	<input type="checkbox"/> Change		
	<input type="checkbox"/> Correct		

2. Proposed new verbatim text: (Verbatim, double-spaced; continue on additional pages as necessary.)

3. Justification/source: (Need not be double-spaced.)

Note: Only one recommendation per page.

(reverse blank)



# Machine Guns and Machine Gun Gunnery

## Table of Contents

	<b>Page</b>
<b>Chapter 1. Introduction to Machine Guns</b>	
<b>Chapter 2. Machine Gun, Light, Squad Automatic Weapon, M249</b>	
Section 1. Introduction . . . . .	2-1
Section 2. Disassembly and Assembly . . . . .	2-7
Section 3. Functioning . . . . .	2-20
Section 4. Malfunctions and Stoppages . . . . .	2-24
Section 5. Mounts and Accessories . . . . .	2-27
Section 6. Maintenance . . . . .	2-29
Section 7. Ammunition . . . . .	2-37
Section 8. Operation and Firing . . . . .	2-40
Section 9. Qualification Firing . . . . .	2-45
<b>Chapter 3. Machine Gun, 7.62mm, M240G</b>	
Section 1. Introduction . . . . .	3-1
Section 2. Disassembly, Assembly, and Nomenclature . . . . .	3-7
Section 3. Functioning . . . . .	3-19
Section 4. Malfunctions and Stoppages . . . . .	3-23
Section 5. Mounts and Accessories . . . . .	3-27
Section 6. Maintenance . . . . .	3-38
Section 7. Ammunition . . . . .	3-41
Section 8. Operation and Firing . . . . .	3-45
Section 9. Gun Drill . . . . .	3-50
Section 10. Qualification Firing . . . . .	3-56
Section 11. Firing with Blank Ammunition . . . . .	3-62
<b>Chapter 4. Machine Gun, Caliber .50, Browning, M2HB</b>	
Section 1. Introduction . . . . .	4-1
Section 2. Disassembly, Assembly, and Nomenclature . . . . .	4-7
Section 3. Headspace and Timing . . . . .	4-26
Section 4. Functioning . . . . .	4-29
Section 5. Malfunctions and Stoppages . . . . .	4-35
Section 6. Mounts and Accessories . . . . .	4-39
Section 7. Maintenance . . . . .	4-43
Section 8. Ammunition . . . . .	4-47
Section 9. Operation and Firing . . . . .	4-53
Section 10. Gun Drill . . . . .	4-56
Section 11. Qualification Firing . . . . .	4-64

## Chapter 5. Machine Gun, 40mm, MK-19 MOD 3

Section 1. Introduction . . . . .	5-1
Section 2. Disassembly, Assembly, and Nomenclature . . . . .	5-7
Section 3. Functioning . . . . .	5-15
Section 4. Malfunctions and Stoppages . . . . .	5-20
Section 5. Mounts and Accessories . . . . .	5-22
Section 6. Maintenance . . . . .	5-30
Section 7. Ammunition . . . . .	5-32
Section 8. Operation and Firing . . . . .	5-36
Section 9. Gun Drill . . . . .	5-40

## Chapter 6. Employment and Gunnery

Section 1. Introduction . . . . .	6-1
Section 2. Characteristics of Fire . . . . .	6-9
Section 3. Classes of Fire . . . . .	6-12
Section 4. Range Determination . . . . .	6-16
Section 5. Traversing and Elevating Mechanism . . . . .	6-18
Section 6. Fire Control . . . . .	6-21
Section 7. Methods of Target Engagement . . . . .	6-25
Section 8. Overhead Fires . . . . .	6-36
Section 9. Techniques of Predetermined Fire . . . . .	6-42
Section 10. Final Protective Lines . . . . .	6-46
Section 11. Range Cards . . . . .	6-49
Section 12. Firing From Defilade Position . . . . .	6-53
Section 13. Machine Gunner's Mathematics . . . . .	6-60
Section 14. Antiaircraft Gunnery . . . . .	6-64
Section 15. Firing Positions . . . . .	6-72
Section 16. Wire Communications . . . . .	6-75

## Appendices

Appendix A. M60E3/M240G Firing Tables . . . . .	A-1
Appendix B. M2 .50 Cal Firing Tables . . . . .	B-1
Appendix C. MK-19 MOD 3 Firing Tables . . . . .	C-1
Appendix D. Destruction of Machine Guns . . . . .	D-1
Appendix E. Infantry Plotting Board M17 . . . . .	E-1
Appendix F. Adjustment of Indirect Machine Gun Fire . . . . .	F-1
Appendix G. Final Protective Lines . . . . .	G-1
Appendix H. Acronyms and Abbreviations . . . . .	H-1
Appendix I. References and Related Publications . . . . .	I-1

## Notes

## Chapter 1

# INTRODUCTION TO MACHINE GUNS

*“For their part the machine-gun units must be on the alert to seize and exploit every opportunity to assist the forward movement of the rifle units, without waiting for specific orders to engage a particular target or locality.”*

—FMFRP 12-2, *Infantry In Battle*<sup>1</sup>

*“Leaders must know what the guns can do before the attack starts, what they can do while the attack is in progress, and what they can do during reorganization and consolidation. They must learn to seek and to recognize opportunities for employing machine guns in every phase of the action. Finally, they must have the aggressiveness to keep everlastingly at the task of getting the guns forward, so that when opportunity does present, they will be able to seize it.”*

—FMFRP 12-2, *Infantry In Battle*<sup>2</sup>



**Desert Storm, Kuwait  
A Marine Machine Gunner Scans the Desert For Targets**

## Table of Contents

1001	History	1004	Principles of Machine Gun Employment
1002	Types of Machine Guns		
1003	Machine Gun Employment		

## List of Figures

1-1	Marine Automatic Rifleman, Operation Desert Shield	1-3	Heavy Machine Gun Squad in Training During Operation Desert Shield
1-2	Marines From the Enlisted Instructor Company Train New Lieutenants in the Field, The Basic School, Quantico, Virginia		



## Chapter 1

# Introduction to Machine Guns

### 1001. History

Despite their post-Civil War development, modern machine guns didn't begin to exhibit their full potential in battle until World War I. The effects on employment of these new weapons systems altered the doctrinal way of waging war for both Allied and Axis powers. Properly employed machine guns proved to be devastating to massed infantry formations and paved the way for the creation of a whole new methodology of warfighting. The machine gun became the keystone of the infantry defense and a major supplier of organic firepower in the offense. New tactics were being developed by both sides to not only exploit the effects of the machine gun, but to counter the enemy's machine gun employment capabilities.

The machine gun changed the face of modern warfare just as surely as the development of aircraft and precision indirect fire artillery. The impact of this weapon can be seen not only in military writings of that period, but in the principles of employment still in use today. FMFRP 12-2, *Infantry in Battle*, a compilation of lessons learned from World War I, provides a wealth of knowledge concerning the employment of machine guns. These lessons remain applicable and are still studied today, almost 70 years later. The proper employment of machine guns has won many a battle at the company and platoon level, and a well rehearsed, proficient machine gun team can sometimes make the difference between success and failure on the battlefield. Military history is filled with examples of the impact that machine guns and their gunners have had in turning the tide of battle:

*“Machine guns affect the outcome of battle by fire power alone. Guns that have not fired have not attacked, no matter how many times they have been placed in position.”*<sup>3</sup>

*“The machine gun acts by fire alone; movement of this weapon has no other purpose than to secure positions from which more effective fire can be delivered. Maximum usefulness is obtained only when every gun within range of the enemy is firing effectively against him.”*<sup>4</sup>

*“Although machine guns lend themselves more readily to the defense than to the attack, this is no excuse for a failure to exact the utmost from them in support of advancing troops. The handicaps to their effective employment in the attack can be and must be overcome.”*<sup>5</sup>

Though the weapons themselves have changed over the years and will continue to do so, the basic considerations for their employment remain constant. The excerpts from FMFRP 12-2, listed above, serve as reminders of this fact, and the lessons contained in them are just as applicable today as when they were first written.

### 1002. Types of Machine Guns

Machine guns are classified as light, medium, or heavy. Classifications are determined by a combination of weapon caliber, weapon system weight, crew size, and the primary type of intended target.

**a. Light Machine Guns/Automatic Rifles.** The light machine gun (LMG) classification generally includes .22 to .250 caliber (5.45mm to 6mm) automatic weapons. An LMG typically weighs between 15 and 30 pounds, complete. An LMG is normally manned by a crew of one or two individuals depending on the accessories being used. Neither a tripod nor a spare barrel is normally used with an LMG when it is manned by a single individual. Bullet weights for LMGs normally range from 45 to 72 grains. They are optimally employed against exposed and lightly protected personnel at ranges less than 1,000 meters. In

this category, the Marine Corps employs the squad automatic weapon, M249, 5.56mm. Figure 1-1 provides an example of a Marine using an LMG.

**b. Medium Machine Guns.** This medium machine gun (MMG) classification generally includes .264 to .33 caliber (6.5mm to 8mm) automatic weapons. Typical MMG weights are 25 pounds or more when loaded with 50 rounds of ammunition. Remaining ammunition, ground tripod, spare barrel, and other accessories can add another 25 pounds or more to the overall weight of MMG systems. The MMG is generally employed by a crew of three. A MMG generally uses bullets that weigh between 140 and 220 grains. Optimally, they are employed against personnel and light materials ( e.g., motor vehicles) at ranges of 1500 meters or less. In this category, the Marine Corps employs several variants of the 7.62mm, M240G machine gun. Figure 1-2 show Marines training with a MMG.

**c. Heavy Machine Guns.** The heavy machine gun (HMG) classification generally includes .50 caliber or larger (12.7mm to 15mm) automatic weapons. The system weight of a heavy machine gun is substantial. In a ready to fire configuration using a ground tripod, an HMG without ammunition can weigh more than 125 pounds. An HMG is normally manned by a crew of four or more personnel (although a crew of three may be sufficient if motor vehicles or draft animals are employed for transportation over distance). The common bullet weight of an HMG is 700 grains or larger. HMGs are primarily employed against field fortifications, vehicles, and aircraft. They are generally effective against these types of targets at ranges of 1,000 meters or greater. The machine guns from this category currently employed by the Marine Corps are the caliber .50, Browning, M2HB, machine gun and the 40mm, MK-19 MOD 3 machine gun. Figure 1-3 portrays a HMG squadron during Operation Desert Shield.



**Figure 1-1. Marine Automatic Rifleman, Operation Desert Shield.**

### 1003. Machine Gun Employment

Properly employed, the machine gun provides a high volume of accurate fire in support of the infantry in both the offense and defense. In the offense, the machine gun can add firepower to the assault, but it is often best employed to suppress or neutralize the objective from a base of fire. The long-range, close defensive, and final protective fires of the machine gun provide an integral part of the defense against infantry attack. HMGs may also be used to destroy lightly armored vehicles or as defense against slow-moving, low-flying aircraft. In addition, the machine gun is used effectively in convoy security, point defense of rear area facilities, and other rear-area security missions.

### 1004. Principles of Machine Gun Employment

Maximum efficiency in the tactical employment of all types of machine guns can be reached by applying the following principles during planning. Most tactical situations would benefit from the employment of all eight principles simultaneously. However, in actuality, these principles are prioritized according to the tactical situation and some may be abandoned in favor of others that are more crucial. These principles are not meant to serve as absolutes. They are, however, sound ideas, proven in combat, that should be understood and considered by all personnel involved in the operation and employment of machine guns. Chapter 6 addresses detailed employment of today's weapons.



**Figure 1-2. Marines From the Enlisted Instructor Company Train New Lieutenants in the Field, The Basic School, Quantico, Virginia.**

**a. Mutual Support.** No machine gun should be placed in isolation. Machine guns should be placed where they can cover each other by fire, fires of one machine gun can help defeat attacks on another machine gun. Another reason to place guns so that they cover each other is so one gun can fire directly at the other position if it is overrun. In some instances, it may be necessary to have other weapons (AT-4 or M203) provide covering fire.

An important facet of the principle of mutual support is security. Protection of machine guns should be of primary concern. Since machine gun positions inflict devastating fire upon the enemy, they will come under concentrated attacks by the enemy in his attempt to stop the attack. To provide protection and security, well-placed riflemen, and/or automatic riflemen are placed so they can cover approaches that the enemy may use to attack the guns. For example, although machine guns should be placed on the flanks to provide defense, they should not be placed in the last

position out since this leaves them vulnerable to a flanking attack. A fire team, or perhaps even larger element, should be positioned outboard of the gun position. This securely “tucks” the machine guns into the defense.

**b. Employed in Pairs.** Employing machine guns in pairs ensures a continuous, high volume of fire. It also gives the guns the capability of efficiently engaging targets of larger width or depth than one machine gun could effectively engage alone. Employment in pairs also provides the opportunity for continued fire from one machine gun while the other machine gun is reloading or clearing a malfunction or stoppage.

**c. Coordination of Fire.** Ensure machine gun fire is coordinated with the fires of other machine guns and other weapons. In the defensive, the machine gun forms the backbone around which other infantry weapons are organized. The machine gun fire plan must be studied by the leader, other fires are then



**Figure 1-3. Heavy Machine Gun Squad in Training During Operation Desert Shield.**

planned to complement the machine gun fire plan. For example:

- Dead space in a machine gun's final protective line (FPL) is covered by other indirect and/or direct fire weapons.
- Indirect fire planned to concentrate along the line where the machine gun's FPL is expected to stop the enemy, hitting him when he seeks cover.

In the offensive, machine gun fire must be coordinated with other weapons systems to ensure complementary or additive effects against the enemy during all phases, i.e.; preparation firing, final assault, consolidation, and pursuit by fire.

**d. Positioned in Defilade.** If at all possible, gun positions should be in defilade. As previously discussed, the enemy will quickly target gun positions, trying to neutralize or destroy them. Placing the machine guns in defilade provides them with some substantial cover between them and the enemy's direct fire weapons. This could be essential to their survival.

**e. Positioned to Produce Enfilade Fire.** To achieve the greatest effect from the machine gun, position it so that the long axis of the beaten zone coincides with the long axis of the target. This type of fire, called enfilade fire, causes the maximum amount of rounds to be concentrated on the maximum amount of targets, significantly increasing the chances of hitting targets. Enfilade fire is normally associated with flanking fire.

**f. Interlocking Fire.** Ensuring that fire from one machine gun position interlocks with the fires of other machine gun positions prevents gaps through which the enemy can easily close with and attack friendly positions. Machine gun fire, properly augmented with obstacles and other weapons effects, should

form a "wall of steel" between friendly positions and the enemy.

**g. Cover and Concealment.** Well-planned and well-prepared alternate and supplementary positions that provide cover and concealment for machine guns are essential. Employ machine guns from a covered and concealed position and do not open fire until necessary. Once machine guns open fire they may be located by the enemy. Once machine gun positions are located, they become a high priority target for the enemy. When tactically feasible, employ machine guns from a defilade or partial defilade position. This provides cover and some concealment. The use of cover and concealment protects the guns and their crews.

**h. Economy.** Machine guns fire at high rates making excessive ammunition consumption a concern. Wasteful use of ammunition can severely jeopardize the success of an operation if resupply is slowed or halted by enemy action, weather, terrain, and/or other factors beyond friendly control. Therefore, a detailed, accurate mission analysis plans to use only those types and amounts of ammunition that will effectively cripple or destroy the enemy. Rates of fire are used when determining a mission analysis.

To conserve ammunition, gunners can be taught to count the length of the burst and to time the pause in between bursts. Another way to conserve/regulate ammunition expenditure is to employ machine guns in pairs or to use alternating fires. In alternating fires, as one machine gun finishes its burst and is about to pause, the other machine gun opens fire. This technique is known as "talking guns". In addition to controlling ammunition consumption, these techniques also reduce the wear and tear on a machine gun's operating parts and prevent overheating and damage to barrels.

## Chapter 2

### MACHINE GUN, LIGHT, SQUAD AUTOMATIC WEAPON, M249

*“Our main defense was two light machine guns, fairly close together, backup up by two heavy machine guns. We had our riflemen all around them.*

*“That’s where Joe comes in. His BAR [Browning Automatic Rifle] was to see that no Koreans would sneak up and heave a hand grenade at the machine guns....Those machine guns could lay down a field of fire that could keep the mass of the enemy away, but you had to keep a sharp eye out for those that broke through It would only take one or two of them to put those guns out of action....*

*“[Joe] was killed just before the last attack was repulsed....*

*“....about ten yards forward of Joe there was a dead North Korean sergeant. The fellow had a pistol in one hand and a hand grenade in the other. He’d obviously been hit by a BAR. Joe must have gotten him just as he was going to throw a grenade at our machine gunners.”*

—Account of Cpl Joseph Vittori, USMC, Company F, 2d Battalion, 1st Marines, in Korea, September 1951. Cpl Vittori was post-humously awarded the Congressional Medal of Honor.<sup>6</sup>



**Korea, South Bank of the Soyang Gang River  
A Light Machine Gun Section Moves into Firing Position.**

## Table of Contents

### Section 1. Introduction

- 2101. General Data
- 2102. Sights
- 2103. Safety
- 2104. Roles of the SAW

### Section 2. Disassembly and Assembly

- 2201. General Disassembly
- 2202. General Assembly
- 2203. Detailed Disassembly and Assembly

### Section 3. Functioning

- 2301. Feeding
- 2302. Chambering
- 2303. Locking
- 2304. Firing
- 2305. Unlocking
- 2306. Extracting
- 2307. Ejecting
- 2308. Cocking

### Section 4. Malfunctions and Stoppages

- 2401. Malfunctions
- 2402. Stoppages
- 2403. Immediate Action
- 2404. Remedial Action

### Section 5. Mounts and Accessories

- 2501. Bipod
- 2502. Spare Barrel Bag
- 2503. Night Vision Sights

### Section 6. Maintenance

- 2601. Care and Cleaning Before, During, and After Firing
- 2602. Normal Maintenance Procedures
- 2603. Special Maintenance Procedures
- 2604. Inspection

### Section 7. Ammunition

- 2701. Classification
- 2702. Identification
- 2703. Ballistic Data
- 2704. Ammunition Packaging
- 2705. Storage
- 2706. Care, Handling, and Preservation of Ammunition

### Section 8. Operation and Firing

- 2801. Loading
- 2802. Unloading
- 2803. Operation of the Safety
- 2804. Firing the SAW
- 2805. Change Barrel Procedures

### Section 9. Qualification Firing

- 2901. Fundamentals of Marksmanship
- 2902. Position and Grip
- 2903. Sight Settings and BZO Procedures
- 2904. 10-Meter Firing
- 2905. Transition Firing

## List of Figures

- |       |  |      |  |
|-------|--|------|--|
| 2-1   | The SAW (Left and Right Sides)           | 2-15 | Operating Group, Detailed Disassembled |
| 2-4   | Five Main Groups (General Assembly)      | 2-16 | Removing the Heat Shield               |
| 2-3   | Safety                                   | 2-17 | Removing the Collar                    |
| 2-5.  | Clearing Procedures                      | 2-18 | Removing the Gas Regulator             |
| 2-2.  | Front and Rear Sights                    | 2-19 | Barrel Group, Detail Disassembled      |
| 2-6.  | Removing the Operating Group             | 2-21 | Removing the Handguard                 |
| 2-7.  | Removing the Barrel Group                | 2-22 | Removing the Gas Cylinder              |
| 2-8.  | Removing the Buttstock and Buffer Group  | 2-20 | Replacing the Collar                   |
| 2-9.  | Removing the Trigger Group               | 2-23 | Removing the Bipod                     |
| 2-10. | Replacing the Trigger Group              | 2-24 | Receiver Group, Detail Disassembled    |
| 2-11. | Replacing the Buttstock and Buffer Group | 2-25 | Replacing the Gas Cylinder             |
| 2-12. | Replacing the Barrel Group               | 2-26 | Malfunctions                           |
| 2-13. | Replacing the Operating Group            | 2-27 | Stoppages                              |
| 2-14. | Separating the Operating Group           | 2-28 | Lowering the Bipod                     |

2-29	Folding of Bipod Under the Handguard	2-47	Loading a Magazine
2-30	Spare Barrel Bag	2-48	Prone Position, Bipod-Supported
2-31	Mounting the Bracket and the Device	2-49	Firing From the Hip (Preferred Assault Fire Technique)
2-32	Centered Reticle Pattern		
2-33	Reticle Aiming Point and the Target Aiming Point	2-50	Firing From Under the Arm
2-34	SAW Tool Storage	2-51	Sight Picture
2-35	Cleaning the Gas Vent Hole	2-52	Sliding Scale on Sight
2-36	Cleaning the Central Hole	2-53	Windage and Elevation (Peep Sight) Correction Chart
2-37	Cleaning the Grooves of the Body	2-54	Zero Group Size
2-38	Cleaning the Front Interior and Internal Grooves of the Gas Cylinder	2-56	Grid Square Overlay
2-39	Cleaning the Grooves of the Piston	2-55	Basic Machine Gun Target
2-40	Cleaning the Hole in the Front of the Piston	2-57	Shot Group on Basic Machine Gun Target
2-41	Cartridges for the SAW	2-58	Overlay Placed Over Pastors
2-42	Cartridges in Metallic Belt	2-59	Common Errors of Marksmanship
2-43	Ballistic Data for 5.56mm Ammunition	2-60	Firing Table I
2-44	Condition Codes for the SAW	2-61	Firing Table II
2-45	Loading	2-62	Single E-Type and Double E-Type Silhouette Targets
2-46	Loading an Ammunition Belt		



## Chapter 2

# MACHINE GUN, LIGHT, SQUAD AUTOMATIC WEAPON, M249

---

### Section 1 Introduction

---

The machine gun, light, squad automatic weapon, M249 (SAW) is a gas-operated, air-cooled, belt or magazine-fed, automatic weapon that fires from the open-bolt position (see figure 2-1). It has a maximum rate of fire of 850 rounds per minute. Primarily, ammunition is fed into the weapon from a 200-round ammunition box containing a disintegrating metallic split-link belt. As an emergency means of feeding, the

SAW can use a 20 or 30 round M16 rifle magazine, but this will increase the chance of stoppages.

The SAW can be fired from the hip, or underarm using assault fire techniques; however, the preferred method of employment is to fire from the bipod-steadied position. The bipod gives the weapon the stability needed to engage targets at its maximum effective range. The SAW has a spare barrel to allow quick barrel changes during employment; however, barrels must not be interchanged with those from other SAWs unless the headspace has been set for that weapon by



**Figure 2-1. The SAW (Left and Right Sides).**

ordnance personnel. Each automatic rifleman and assistant automatic rifleman should have ready access to TM 08671A-10/1A, a detailed, pocket-sized reference manual for operators of the SAW.

## 2101. General Data

### Weight of SAW:

With bipod and tools . . . . .	17 pounds
With 200 round drum . . . . .	23.92 pounds

### Measurements:

Length . . . . .	40.87 inches
Muzzle velocity	
Ball ammunition . . . . .	3,025 feet per second
Tracer ammunition . . . . .	2,870 feet per second
Rifling . . . . .	Standard right hand twist one turn in 7 inches

### Ranges:

Maximum . . . . .	3,600 meters
Maximum effective	
Point targets . . . . .	800 meters
Area targets . . . . .	1,000 meters
Grazing fire . . . . .	600 meters

### Ammunition:

Caliber . . . . .	5.56 millimeter
Types in use . . . . .	Ball, tracer, blank, and dummy
Basic allowance . . . . .	600 rounds per SAW, carried by the automatic rifleman and assistant automatic rifleman
Weight of full 200 round drum . . . . .	6.92 pounds

### Rates of fire:

Sustained . . . . .	85 rounds per minute, fired in 3 to 5 round bursts, 4 to 5 seconds between bursts no barrel changes
Rapid . . . . .	200 rounds per minute, fired in 6 to 8 round bursts, 2 to 3 seconds between bursts, barrel change every 2 minutes
Cyclic . . . . .	850 rounds per minute, continuous burst, barrel change every minute

## 2102. Sights

The SAW has a hooded and semi-fixed front sight (see figure 2-2A). The rear sight assembly (see figure 2-2B) mounts on the top of the cover and feed mechanism assembly. The elevation knob drum has range settings from 300 meters to 1,000 meters. Range changes are made on the SAW sight by rotating the elevation knob to the desired range setting. Rotation of the rear sight aperture (peep sight) is used for fine changes in elevation or range adjustments, such as during zeroing. Each click of the peep sight (180-degree turn) equals a one-half-mil change in elevation, which is .5 cm at 10 meters. The sight adjusts for windage by rotating the windage knob. Each click of windage adjustment also equals a one-half-mil change, which is .5 cm at 10 meters. There is also a windage sliding scale marked with index lines for centering the rear sight aperture.

## 2103. Safety

The safety (figure 2-3) is in the trigger housing. The safety is pushed from left to right (red ring NOT visible) to render the weapon *SAFE*, and the bolt cannot be released to go forward. The safety is pushed from right to left (red ring visible) to render the weapon ready to fire. The cocking handle on the right side of the weapon is used to pull the bolt to the rear.

## 2104. Roles of the SAW

From the mid-1960s to the mid-1980s the Marine Corps operated with an automatic weapon at the squad/fire team level that was extremely limited. The automatic rifleman's weapon (the M16A1) was the same weapon carried by the other members of the fire team. The automatic rifleman had no unique capabilities or equipment except that he was given a removable, "clip on" bipod for his weapon. This shortfall was remedied with the introduction of the SAW in the late 1980s. The Marine Corps has never had a more capable and versatile weapon at the squad level. Prior to the fielding of the SAW, the Browning automatic

rifle had been the last automatic weapon used by the Corps that provided significant fire power to the rifle squad beyond the capabilities of the other small arms carried within it. Various models of the Browning automatic rifle were used by Marine units from World War I to the early 1960s. Even the much respected Browning automatic rifle, that served the Corps so well for over 40 years, had limitations that the design of the SAW has overcome. The Browning was an automatic rifle and it had some design limitations common to other rifles of its day. These included a limited ammunition supply (only a 20 round box magazine), problems with overheating during continuous firing (because of a fixed barrel that could not be changed by the operator), and a limited maximum effective range.

Although employed as an automatic rifle by the Marine Corps, the SAW is designed like a medium machine gun. As such it has design features that make it a more versatile weapon, such as; it can be belt or magazine fed thus providing more continuous fire before reloading and it has a quick change barrel feature which allows barrel changes during periods of continuous firing without taking the weapon out of action for more than a few seconds. The SAW also has greater effective range and a higher rate of fire than any other weapon in the present rifle squad.

The SAW can provide a heavy volume of continuous, accurate fire in support of offensive or defensive operations. Its presence in large numbers (e.g., nine per rifle platoon) at the small unit level has significantly increased the combat power of those units. In the past, medium machine guns were often attached to platoons or squads, more out of concern over the lack of fire power in those small units than for sound tactical reasons. The introduction of the SAW into those units has changed that. The SAW provides the platoons with significant fire power against enemy personnel and light equipment. Because of this, more times than not, the company's machine gun section can now be employed as a section, in a general or direct support role, rather than attached out. The SAW's presence, in any type of unit, increases the available fire power

and provides additional flexibility to the unit leader in terms of weapons employment options.

---

## Section 2

### Disassembly and Assembly

---

The SAW is designed for easy disassembly and assembly; the use of force is not necessary and no special tools are required. As the weapon is disassembled, place the parts (in the order in which they are removed) on a clean, flat surface. This reduces the possibility of losing a part and aids in assembly, as all parts are replaced in reverse order. To prevent unnecessary wear, disassembly should be kept to the minimum, consistent with maintenance and training requirements.

Disassembly and assembly may be divided into two categories; general and detailed. General disassembly involves separation of the weapon into main groups. This is also known as field stripping and is a practice that stems from past experience in combat situations. The intent behind designating main groups for a weapon and the practice of field stripping is to allow the operator to quickly break the weapon down into a set of major components that can be hastily cleaned to keep the weapon ready for action. The idea is to disassemble the weapon just far enough to conduct basic cleaning without having to contend with numerous assemblies and parts.

Detailed disassembly, for the operator, involves the removal of some of the component parts and assemblies from the main groups. The idea here is that, when the situation and conditions permit, the operator can then take the time to more fully disassemble and thoroughly clean the weapon. Complete general and detailed disassembly is normally the expected routine in garrison after the completion of firing and/or field training, but this may also be conducted in a field environment when necessary, to ensure the proper functioning and maintenance of the weapon. Disassembly of the weapon beyond that described in this publication is not authorized, except by qualified ordnance personnel.

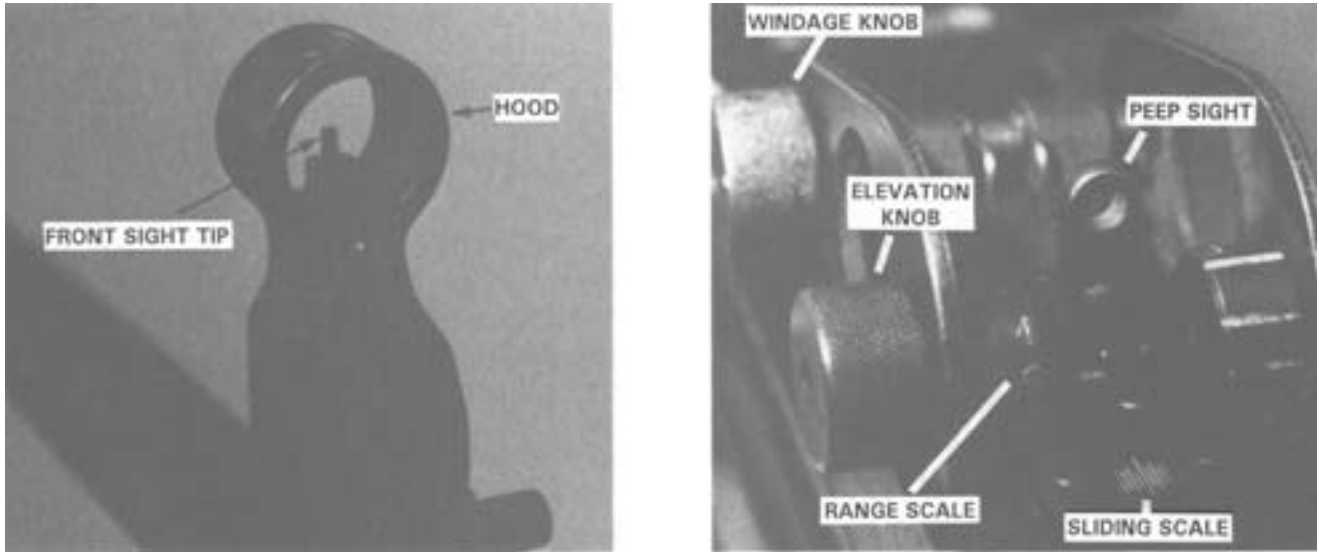

Figure 2-2. Front and Rear Sights.

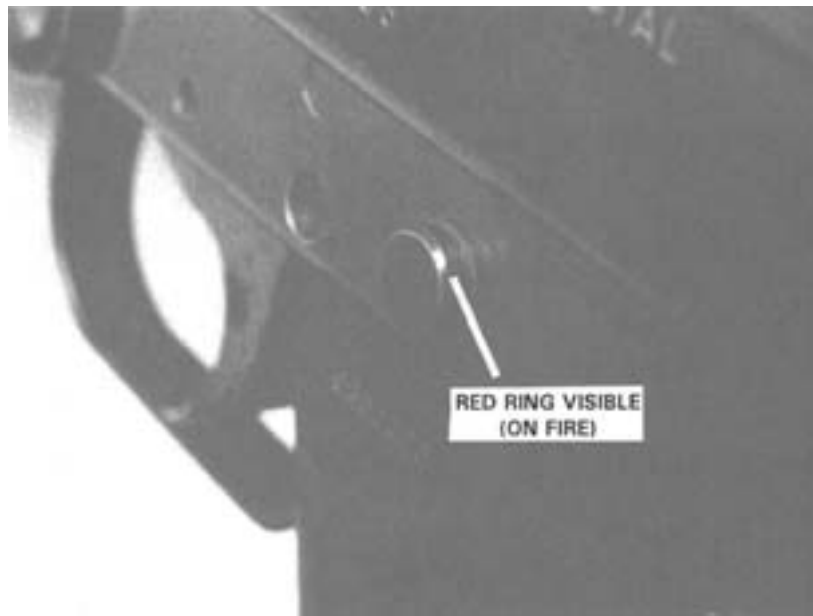

Figure 2-3. Safety.

## 2201. General Disassembly

General disassembly is the separation of the SAW into five main groups (see figure 2-4). They are the operating group, the barrel group, the trigger group, the buttstock and buffer group, and the receiver group.

**a. Clearing the Weapon.** The first step in disassembly is to clear the weapon (see figure 2-5). This applies in all situations, not just after firing. The automatic rifleman must always assume the SAW is loaded. To clear the SAW, perform the following procedures:

- Move the safety to the *FIRE* position by pushing it to the left until the red ring is visible.
- With the right hand, palm up, pull the cocking handle to the rear, locking the bolt in place.
- While holding the resistance on the cocking handle, move the safety to the *SAFE* position by pushing it to the right until the red ring is not visible. (The weapon cannot be placed on safe unless the bolt is locked to the rear.)
- Return and lock the cocking handle in the forward position.

### CAUTION

When opening the feed cover, make sure the weapon is on the ground away from your face. With the weapon on your shoulder, possible injury could occur if a round goes off when the cover is raised.

- Raise the cover and feed mechanism assembly and conduct the *five-point safety check* for brass, links, or ammunition.
  1. Check the feed pawl assembly under the feed cover.
  2. Check the feed tray assembly.
  3. Lift the feed tray assembly and inspect the chamber.
  4. Check the space between the bolt assembly and the chamber.
  5. Insert two fingers of the left hand in the magazine well to extract any ammunition or brass.
- Close the cover and feed mechanism assembly and move the safety to the *FIRE* position. With the right hand, palm up, return the cocking handle to the rear position. Press the trigger and at the same time ease the bolt forward by manually riding the cocking handle forward.

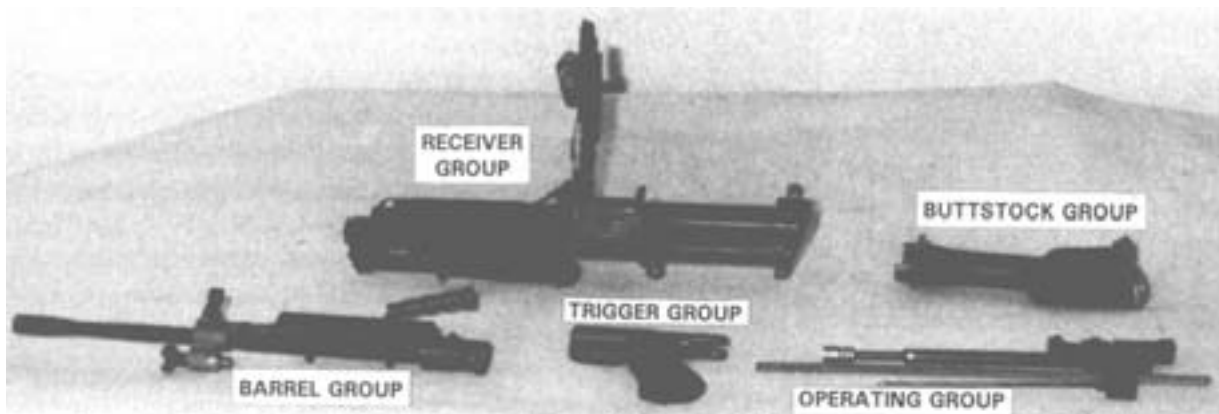

Figure 2-4. Five Main Groups (General Assembly).



Figure 2-5. Clearing Procedures.

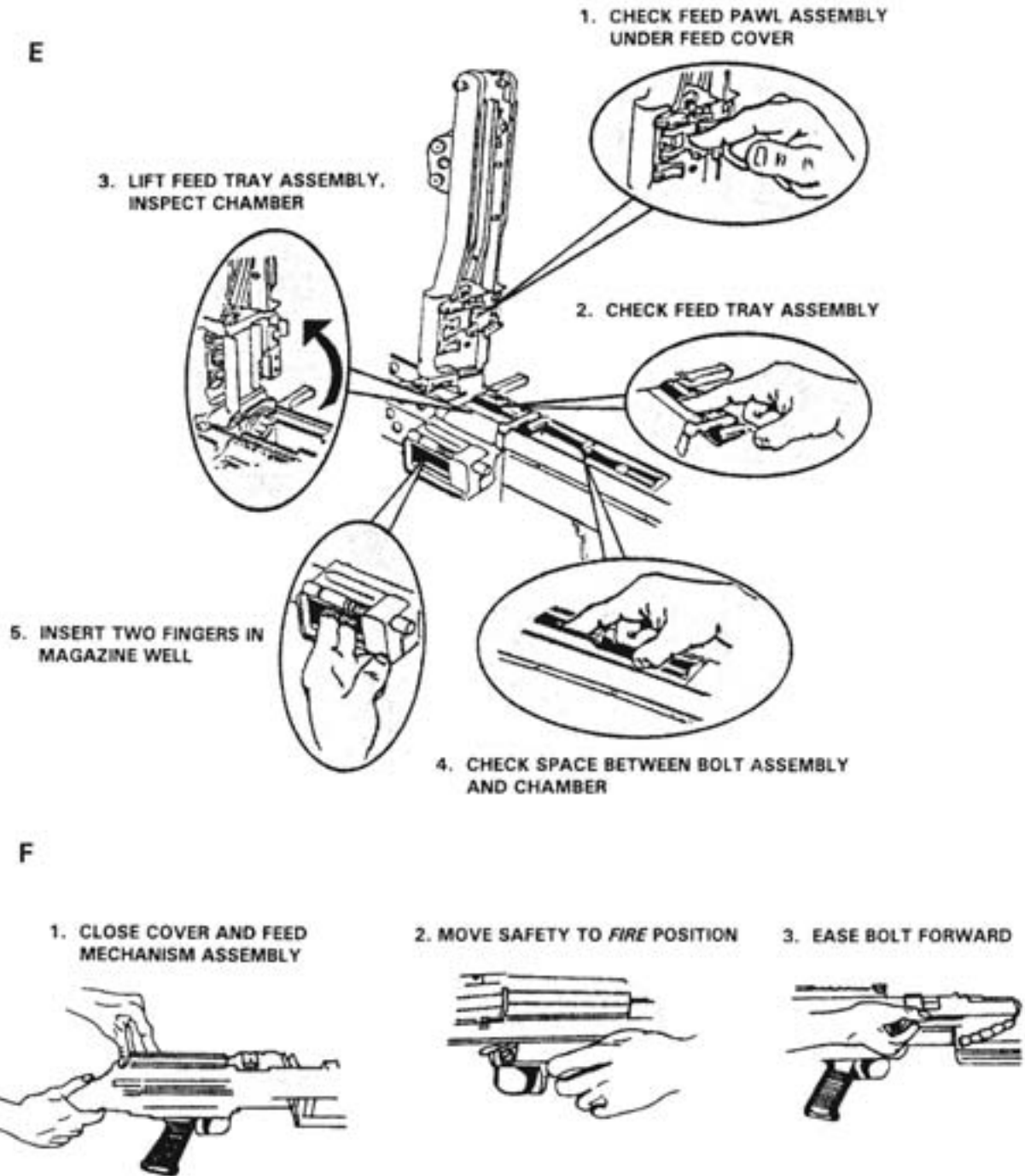

Figure 2-5. Clearing Procedures—Continued.

**b. Removing the Operating Group.** Once the weapon is clear, general disassembly begins by removing the operating group. The operating group consists of the spring guide rod, operating rod spring, slide assembly, piston assembly, and bolt assembly.

- To remove the operating group, first pull the upper retaining pin at the rear of the receiver that holds the buttstock to the left. Allow the buttstock to pivot downward and place it on a surface to support the weapon for disassembly. See figure 2-6, step 1.
- To release the operating rod assembly from the positioning grooves inside the receiver, hold the weapon with one hand on the buttstock assembly and use the thumb of the other hand to push in and upward on the rear of the operating rod assembly.
- Pull the operating rod and spring from the receiver group and separate the parts. See figure 2-6, step 2.
- Hold the buttstock assembly with the left hand to stabilize the weapon. With the right hand, pull the cocking handle to the rear to lock the bolt. Return the cocking handle to the forward position. Place a



Step 1. Rotating the Buttstock Down.



Step 2. Removing the Operating Rod.



Step 3. Removing the Piston, Slide, and Bolt Assemblies.

Figure 2-6. Removing the Operating Group.



finger on the face of the bolt and push until the finger makes contact with the bridge at the end of the receiver. This leaves the piston, slide, and bolt assemblies exposed.

- Hold the slide assembly while pulling the moving parts out the rear of the receiver. See figure 2-6, step 3.

**c. Removing the Barrel Group.** The barrel group consists of barrel, heat shield, flash suppressor, front sight, gas regulator, and gas regulator collar. See figure 2-7.

---

### CAUTION

---

Barrels must not be interchanged with those from other SAWs unless the headspace has been certified for that weapon by ordnance personnel.

---



**Figure 2-7. Removing the Barrel Group.**

- To remove the barrel from the receiver, close the cover and feed mechanism assembly, depress the barrel locking lever with the left hand, lift the carrying handle using the right hand, and push the barrel forward.

**d. Removing the Buttstock and Buffer Group.** To remove the buttstock and buffer assembly (see figure 2-8), use a cartridge or the spring guide rod to push the lowermost retaining pin on the rear of the

receiver to the left. It is a captured pin; it is not removed. Remove the buttstock and shoulder assembly by pulling it rearward, while supporting the trigger mechanism.



**Figure 2-8. Removing the Buttstock and Buffer Group.**

**e. Removing the Trigger Group.** To separate the trigger group, push the lowermost retaining pin that was used to release the buttstock all the way to the left and remove the trigger assembly from the bottom of the receiver. See figure 2-9.

---

### CAUTION

---

The upper and lower retaining pins in the rear of the receiver are captured pins. Do not attempt to remove them completely.

---

Once the trigger group has been removed general disassembly is complete.

## 2202. General Assembly

The SAW is assembled in reverse order of the disassembly.

**a. Replacing the Trigger Group.** Align the trigger mechanism with the slot on the bottom of the



**Figure 2-9. Removing the Trigger Group**

receiver. Hold the trigger mechanism in position to accomplish the next step. See figure 2-10.

**b. Replacing the Buttstock and Buffer Group.**

Align the lower hole in the buttstock and buffer group with the rear hole in the trigger mechanism, then push the lower retaining pin to the right. See figure 2-11.

**c. Replacing the Barrel Group.** Depress the barrel locking lever to the rear with the left hand, while holding the carrying handle with the right hand. Pull the barrel rearward and push downward; align the gas regulator with the gas cylinder and lock it by releasing the barrel locking lever. Check the barrel to ensure it

is locked into the receiver by pulling or lifting on the carrying handle. See figure 2-12.

**d. Replacing the Operating Group**

- Open the cover assembly on the receiver. Insert the face of the piston into the receiver, aligning the bolt lugs onto the receiver rails. Pull the trigger and push the moving parts forward until the bolt is seated into the chamber.



**Figure 2-10. Replacing the Trigger Group.**



**Figure 2-11. Replacing the Buttstock and Buffer Group.**



**Figure 2-12. Replacing the Barrel Group.**

- Place the operating rod tip into the operating rod spring. Then, insert the free end of the operating rod and spring into the rear of the piston. Depress the rear of the operating rod assembly until the two lugs on the buffer are positioned in the receiver grooves. See figure 2-13.
- Pivot the buttstock upward into position and push the upper retaining pin to the right, locking the buttstock to the receiver.
- Grasp the cocking handle with the right hand, palm up, and pull and hold it to the rear.
- Move the safety to the *FIRE* position.
- While continuing to hold resistance on the cocking handle, use the left hand to pull the trigger and ease the bolt forward to prevent it from slamming into the chamber area and damaging the face of the bolt.

**e. Conducting a Function Check.** A function check must be performed to ensure that the SAW has been assembled correctly. The procedures, in order, are—

- Grasp the cocking handle with the right hand, palm up, and pull the bolt to the rear locking it in place.
- While continuing to hold the resistance on the cocking handle, use the left hand to move the safety to the *SAFE* position.
- Push the cocking handle forward into the forward lock position.
- Pull the trigger. (The weapon should not fire.)



**Figure 2-13. Replacing the Operating Group.**

- If the weapon fails the function check, check for missing parts or the reassembly procedures. (Before disassembling the weapon, make sure it is positioned where the guide rod and spring cannot cause bodily harm if the bolt is locked to the rear.)

---

### CAUTION

---

The bolt must be eased forward to prevent damage to the cover and feed mechanism assembly and operating rod group. This is known as “riding” the bolt forward.

---

### NOTE

The cover and feed mechanism assembly can be closed with the bolt in either the forward or the rearward position.

## 2203. Detailed Disassembly and Assembly

The term detailed disassembly, as it is used in this manual, refers only to those disassembly procedures

authorized for the *operator* level. This is not to be confused with procedures authorized for 2d echelon maintenance (unit armorers) or above. Detailed disassembly of *any* of the groups beyond that described in this document is NOT AUTHORIZED except by qualified ordnance personnel.

The operator is not authorized to detail disassemble the trigger group or the buttstock and buffer group. The other three groups can be further disassembled by the operator as described below:

### a. Operating Group

#### (1) Detailed disassembly

- To separate the operating group (see figure 2-14), hold the piston assembly in one hand, place the other hand on the bolt assembly, and rotate the bolt to disengage the bolt from the slide assembly.
- To separate the slide assembly from the piston, press the retaining pin at the rear of the slide assembly to the left and lift the slide assembly.



Step 1. Separating the Slide Assembly From the Piston.



Step 2. Removing the Bolt From the Slide.

Figure 2-14. Separating the Operating Group.

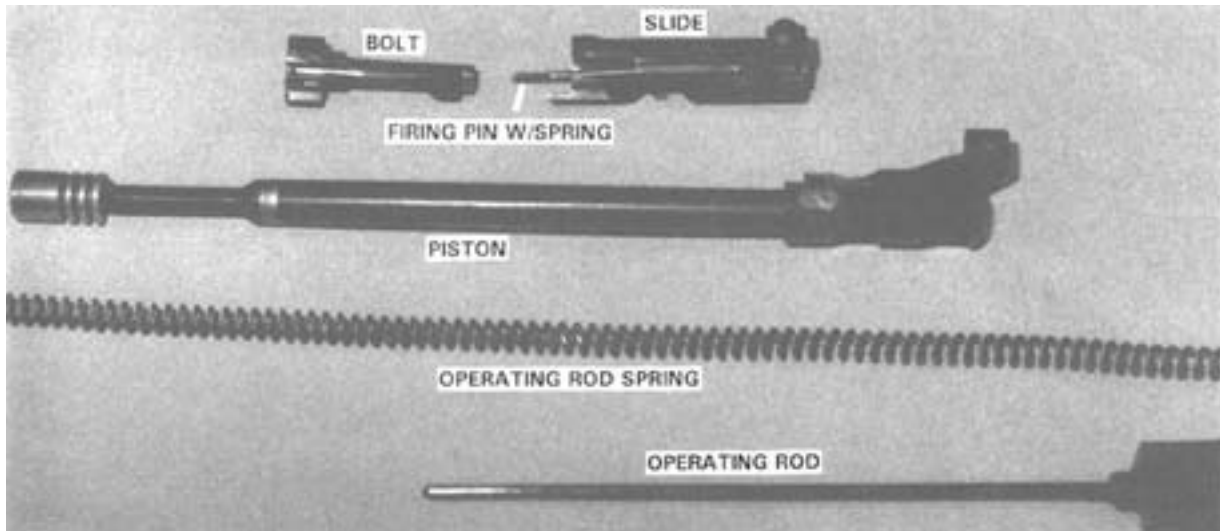

**Figure 2-15. Operating Group, Detailed Disassembled.**

This completes detailed disassembly of the operating group. See figure 2-15.

**(2) Detailed assembly**

- Hold the piston in one hand with the face of the piston facing outward and the sear notches downward. With the other hand, place the slide assembly onto the rear of the piston with the firing pin toward the front of the piston. (Check the slide assembly retaining pin to make sure it is out.)
- Push the slide assembly retaining pin to the right. This locks the piston assembly and the slide assembly together.

- Place the bolt on the slide assembly, aligning the driving lug of the bolt with the slot of the slide assembly. Apply pressure to the face of the bolt to compress the firing pin spring. Then, rotate the bolt to hook the driving lug into the slide assembly.

**b. Barrel Group**

**(1) Detailed disassembly**

- To remove the heat shield, place the barrel with the muzzle end on a hard, flat surface with the heat shield facing away from the body. Place the index fingers of each hand inside the chamber. Use the thumbs to push up on the top clip. See figure 2-16.



**Figure 2-16. Removing the Heat Shield.**

- To remove the gas regulator and collar, rotate the gas collar pin out of the notch. Place the tip of the scraper with the concave side facing the pin of the collar inside the notch. (Be careful not to use too much pressure, so as not to break the tip of the scraper.) Rotate the collar counterclockwise over the concave portion of the tip on the scraper and past the notch until the collar slides off. See figure 2-17.
- To remove the gas regulator (see figure 2-18), separate it from the gas block. This completes detailed disassembly of the barrel group. See figure 2-19.

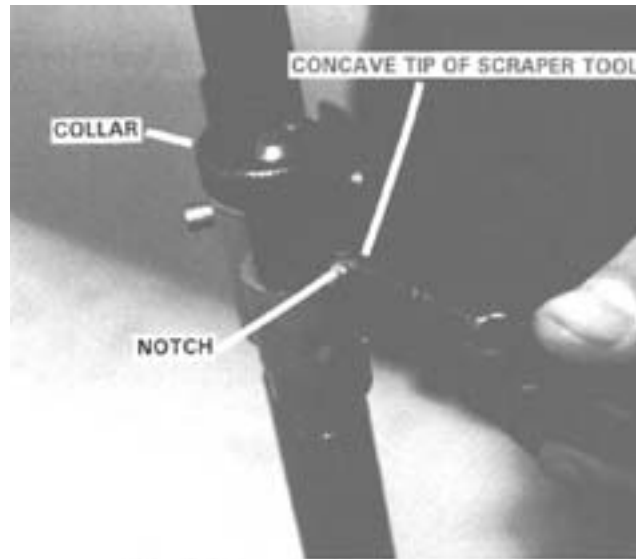

Step 1. Placement of the Scraper Tool.



Step 2. Rotating the Collar.

Figure 2-17. Removing the Collar.



**Figure 2-18. Removing the Gas Regulator.**

**(2) Detailed assembly**

- Insert the gas regulator into the gas block and align the notch on the gas regulator with the notch of the gas block.
- With the gas regulator installed and supported on a firm surface, place the gas regulator collar onto the protruding end of the body and align the spring with the stud. Push the gas regulator collar firmly downward and rotate it until it slips into place. Then, press it in and rotate it to lock it in place. See figure 2-20, page 2-20.

- Replace the heat shield by placing the hook end of the heat shield under the front sight post and press down until the clamps lock on the barrel.

**c. Receiver Group**

**(1) Detailed disassembly**

- Removing the handguard. The handguard assembly consists of the handguard, handguard retaining pin, and cleaning equipment retaining clip. Push the handguard retaining pin to the left using a length of cleaning rod (see figure 2-21, step 1, page 2-21); then pull the handguard down (see figure 2-21, step 2, page 2-21).

**CAUTION**

The handguard retaining pin is a captured pin. Do not attempt to remove it completely.

- Removing the gas cylinder. To remove the gas cylinder from the receiver (see figure 2-22, page 2-22), grasp the gas cylinder at the top of the bipod legs, turn it to the left or right to release the locking spring, and then pull it away from receiver.
- Removing the bipod. Once the gas cylinder is removed, remove the bipod (see figure 2-23, page 2-22) by pulling it away from the receiver. This completes detailed disassembly of the receiver. See figure 2-24, page 2-23.

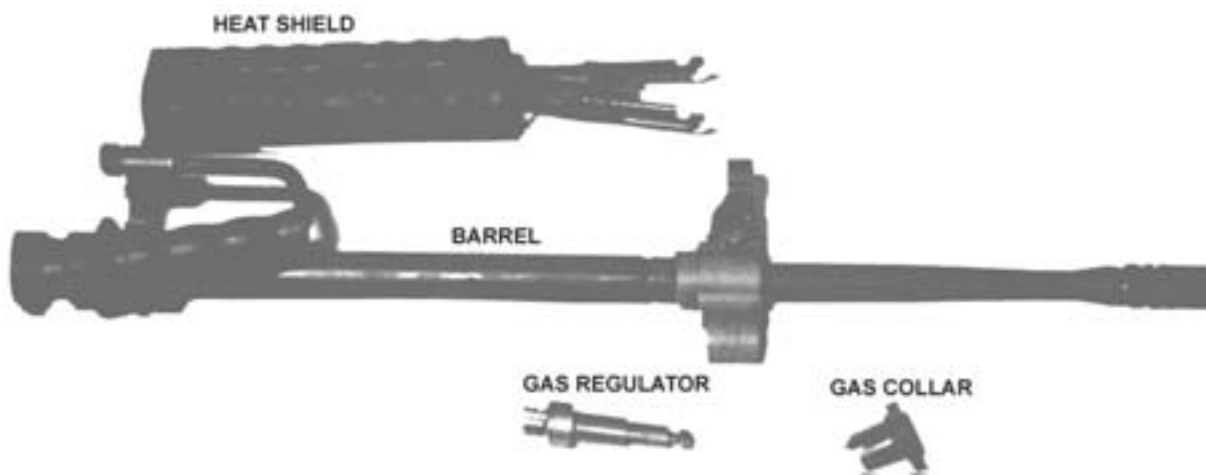

**Figure 2-19. Barrel Group, Detail Disassembled.**



**Figure 2-20. Replacing the Collar.**

**(2) Detailed assembly**

Replacing the bipod. Place the bipod on the receiver group with the bipod legs open and pointed downward. See figure 2-23, page 2-22.

Replacing the gas cylinder. Push the gas cylinder through the bipod yoke into the receiver. Push the cylinder to the rear while countering the pressure of the locking spring and guiding the end of the cylinder into the receiver with the other hand applying downward pressure. Position the recess in the cylinder near the spring. Turn the cylinder until the spring clicks into the recess at the rear of the gas cylinder. See figure 2-25.

Replacing the handguard. To replace the handguard, place it on the receiver from the bottom and push it to the rear until it stops. Using the guide rod, push the handguard retaining pin to the right, which locks the handguard into position. Push the handguard down to make sure it is locked. See figure 2-21.

---

### Section 3 Functioning

---

The cycle of functioning is broken down into eight basic steps. These steps are feeding, chambering, locking, firing, unlocking, extracting, ejection, and cocking. More than one step may occur simultaneously during the cycle of functioning. By understanding how the SAW functions, it will be easier to recognize and correct malfunctions and stoppages which occur during firing.

The cycle is started by putting the first round of the belt in the tray groove or by inserting the magazine into the magazine well. Then the trigger is pulled, releasing the sear from the sear notch. When the trigger is pulled to the rear, the rear of the sear is lowered and disengaged from the sear notch. This allows the piston and bolt to be driven forward by the expansion of the operating rod spring. The cycle stops when the trigger is released and the sear again engages the sear notch on the piston. The sequence of functioning is as follows:

#### **2301. Feeding**

As the bolt starts its forward movement, the feed lever is forced to the right, causing the feed-pawl assembly to turn in the opposite direction. This forces the feed-pawl assembly over the next round in the belt, and it is ready to place the next round into the tray groove when the rearward action occurs again. As the bolt moves to the rear after firing, the feed roller forces the feed lever to the left. The feed lever is forced to turn, moving the feed pawl to the right. This places a round in the tray groove.

#### **2302. Chambering**

As the bolt travels forward, the upper locking lug engages the rim of the round. The pressure of the front and rear cartridge guides holds the round so that



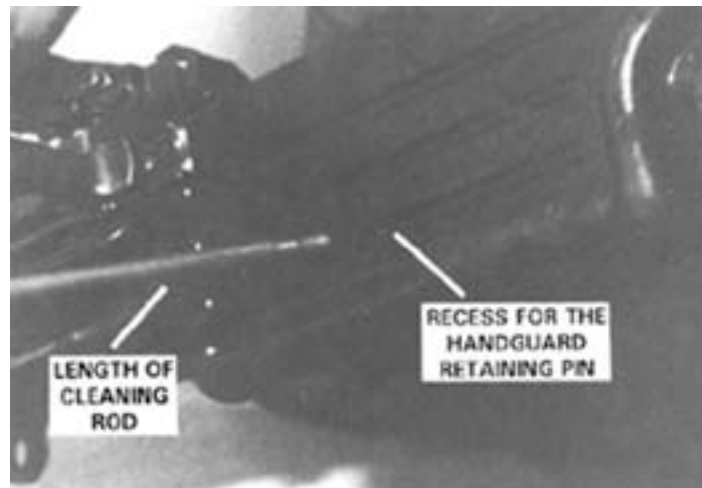

Step 1. Handguard Retaining Pin.



Step 2. Removing the Handguard.

**Figure 2-21. Removing the Handguard.**

positive contact is made with the upper locking lug of the bolt. The front cartridge guide prevents forward movement of the link as the round is stripped from the belt. The upper locking lug carries the round forward. The chambering ramp causes the nose of the round to be crammed downward into the chamber. When the round is fully seated in the chamber, the extractor snaps over the rim of the round, and the ejector on the rail inside the receiver is depressed.

### **2303. Locking**

As the round is chambered, the bolt enters the barrel socket. The upper and lower locking lugs contact the bolt camming surfaces inside the barrel and start turning the bolt clockwise. The action of the bolt into the slide assembly, as the piston continues forward, turns the bolt to complete its 90 degree (one-quarter turn) clockwise rotation. Locking is now complete.



**Figure 2-22. Removing the Gas Cylinder.**



**Figure 2-23. Removing the Bipod.**

### **2304. Firing**

After the bolt is fully forward and locked, the piston continues to go forward, independent of the bolt, for a short distance. The slide assembly carries the firing pin through the face of the bolt. The firing pin strikes the primer of the round and the primer fires the round.

### **2305. Unlocking**

After the round is fired and the bullet passes the gas port, part of the expanding gases go through the gas plug into the gas regulator. The rapidly expanding gases enter into the gas cylinder from the gas regulator, forcing the piston to the rear. As the piston contin-

ues to the rear, the slide assembly, also moving to the rear, causes the bolt to begin its counterclockwise rotation. The upper and lower locking lugs of the bolt contact the bolt camming surfaces inside the barrel socket and, as the bolt continues toward the rear, it completes a one-quarter turn counterclockwise. The rotation and movement to the rear unlocks the bolt from the barrel socket.

### **2306. Extracting**

Extracting begins during the unlocking cycle. The rotation of the bolt loosens the cartridge case in the chamber. As the piston and bolt move to the rear, the extractor pulls the cartridge case from the chamber.

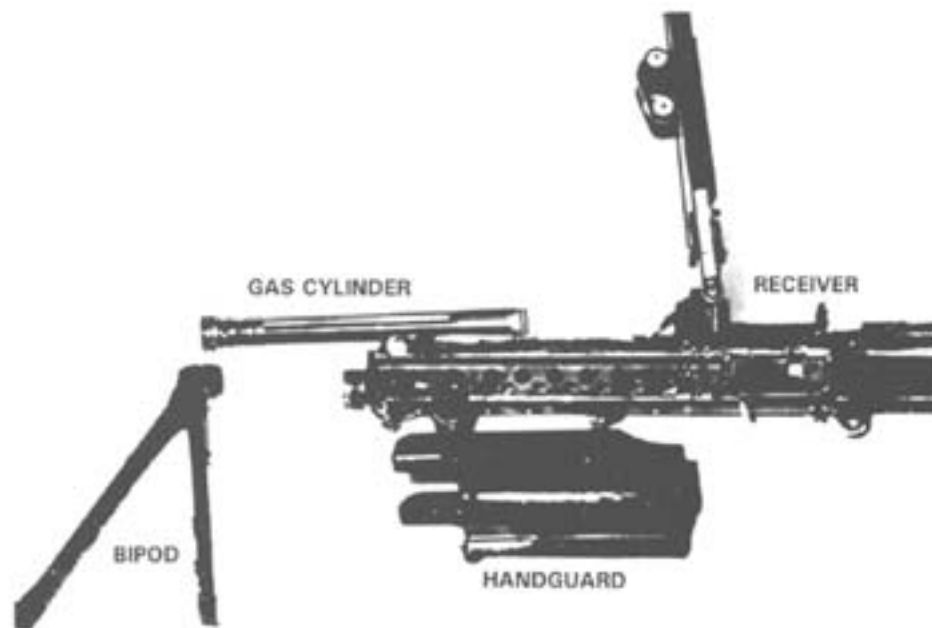

**Figure 2-24. Receiver Group, Detail Disassembled.**



**Figure 2-25. Replacing the Gas Cylinder.**

### **2307. Ejecting**

As the cartridge case is pulled from the chamber, the bolt passes by the ejector. This causes the ejector clip to expand, forcing the ejector to push the expended cartridge. The extractor grips the right side of the cartridge and causes it to spin from the weapon as it reaches the ejection port. The empty belt links are forced out the link ejection port as the rearward movement of the bolt causes the next round to be positioned in the tray groove.

### **2308. Cocking**

The piston assembly acts against the firing pin, pulling the firing pin from the primer of the spent cartridge case. The action of the piston assembly, continuing to the rear with the firing pin, releases the compression of the firing pin spring. As long as the trigger is held to the rear, the SAW will continue to complete the eight steps of functioning automatically. When the trigger is released and the sear again engages the sear notch, the

cycle of functioning is stopped and the weapon is cocked. To prevent undue wear to the sear and sear notch, the automatic rifleman must hold the trigger firmly to the rear during firing.

## Section 4 Malfunctions and Stoppages

Automatic rifleman must have a detailed understanding of the many component parts of their weapon, what those parts do during functioning, and what mechanical problems may be encountered during firing. This knowledge ensures that those problems can be assessed quickly and corrective action taken.

### 2401. Malfunctions

A malfunction is a failure of the gun to function satisfactorily; the gun will fire, but fires improperly. Defective ammunition or improper operation of the gun by a crew member is not considered a malfunction. Two of the more common malfunctions are sluggish operation and runaway gun.

**a. Sluggish Operation.** Instead of firing at its normal rate, a sluggish gun fires very slowly. It can be due to excessive friction or loss of gas. Excessive friction is usually due to lack of lubrication or excessive dirt/carbon in the gas system or on the bolt and

receiver rails. Excessive loss of gas is usually due to loose connections in the gas system. The action taken to reduce sluggish operation is to move the regulator setting to the high position. The remedy for continued sluggish operation is to clean, lubricate, tighten, or replace parts as required.

**b. Runaway Gun.** This is the case when a gun continues to fire after you have released the trigger; firing is uncontrolled. A runaway gun is usually caused by a worn, broken, or burred sear; the sear shoulder is unable to grab the operating rod and hold it to the rear. An excessively worn sear notch on the operating rod could also be responsible. To stop a runaway gun, the automatic rifleman or the assistant automatic rifleman twist and break the belt of ammunition. The remedy for runaway gun is to replace worn parts.

Further information on these two malfunctions is listed in figure 2-26.

### 2402. Stoppages

A stoppage is any interruption in the cycle of functioning caused by faulty action of the weapon or defective ammunition. Stoppages are classified by their relationship to the cycle of functioning. Figure 2-27 shows types of interruptions or stoppages, their probable causes, and the corrective actions. Stoppages must be

MALFUNCTION	PROBABLE CAUSE	CORRECTIVE ACTION
Sluggish operation.	Lack of lubricant.	Lubricate.
	Carbon buildup in gas system.	Clean gas regulator, piston, and cylinder.
	Burred parts.	Notify organizational maintenance.
Failure to cock or a runaway weapon.	Broken, worn, or burred sear.	Notify organizational maintenance.
	Piston assembly sear notch worn.	Notify organizational maintenance.
	Sear stuck in trigger housing.	Notify organizational maintenance.
	Short recoil.	Clean and lubricate bolt and slide assembly.
	Carbon buildup in gas system.	Clean gas regulator, piston, and cylinder.

**Figure 2-26. Malfunctions.**

reduced quickly and the weapon returned to action. Apply immediate action. (See paragraph 2403 below.)

### 2403. Immediate Action

Immediate action is that action taken by the automatic rifleman to reduce a stoppage, without investigating its cause, and quickly return the weapon to action. Two terms used to describe ammunition condition should be understood in conjunction with immediate action procedures.

A **hang fire** occurs when the cartridge primer has detonated after being struck by the firing pin but some problem with the propellant powder causes it to burn too slowly and this delays the firing of the projectile. Time (5 seconds) is allotted for this malfunction before investigating a stoppage further because injury to personnel and damage to equipment could occur if the round went off with the cover of the weapon open.

A **cook off** occurs when the heat of the barrel is high enough to cause the propellant powder inside the round to ignite even though the primer has not been struck. Immediate action is completed in a total of 10 seconds to ensure that the round is extracted prior to the heat of the barrel effecting it. When the round fails to extract/eject, further action is delayed (15 minutes) if the barrel is hot because the gunner must assume that a round is still in the chamber and could cook off at any time prior to the barrel cooling off.

The immediate action procedures for the SAW are—

- Wait 5 seconds after the misfire to guard against a hang fire.
- Within the next 5 seconds (to guard against a cook off) pull and lock the cocking handle to the rear while observing the ejection port to see if a cartridge case, belt link, or round is ejected. Ensure that the bolt remains to the rear to prevent double feeding if a round or cartridge case is not ejected.
- If a cartridge case, belt link, or a round is ejected, push the cocking handle to its forward position, take aim on the target, and press the trigger. If the weapon does not fire, take remedial action. If a car-

tridge case, belt link, or round is not ejected, take remedial action.

#### WARNING

**If nothing is ejected and the barrel is hot (200 or more rounds fired in 2 minutes or less), do not open the cover. Push the safety to the right (red ring not visible), which places the weapon on SAFE. Keep the weapon pointed downrange and remain clear for 15 minutes, then clear the weapon.**

### 2404. Remedial Action

Remedial action is any action taken to determine the cause of a stoppage and to restore the weapon to an operational condition. This action is taken only after immediate action did not remedy the problem. See figure 2-27.

**a. Cold Weapon Procedures.** When a stoppage occurs with a cold weapon and immediate action has failed, use the following procedures:

- While the weapon is on the shoulder, grasp the cocking handle with the right hand, palm up, pull the cocking handle to the rear locking the bolt. While holding the resistance on the cocking handle, move the safety to *SAFE* and return the cocking handle forward.
- Place the weapon on the ground or away from the face, open the feed cover, and perform the five-point safety check (page 2-9). Reload and continue to fire.
- If it does not fire, clear the weapon and inspect it and the ammunition.

**b. Hot Weapon Procedures.** If the stoppage occurs with a hot weapon (200 or more rounds in 2 minutes or less), move the safety to *SAFE*, let the weapon cool for 15 minutes, and use the same procedures as outlined for cold weapon procedures.

STOPPAGE	PROBABLE CAUSE	CORRECTIVE ACTION
Failure to feed.	Insufficient lubrication.	Lubricate as required.
	Defective ammunition link.	Remove and replace ammunition.
	Obstruction in receiver.	Remove obstruction.
	Insufficient gas pressure.	Clean gas regulator, piston, and cylinder.
	Unlatched cover.	Latch cover.
	Long or short rounds.	Align rounds in link belt.
	Inverted link belt.	Reinstall link belt with open end of link facing down.
	Damaged, weak, or worn operating parts.	Notify organizational maintenance.
Failure to fire.	Safety on.	Push safety to left, exposing red ring.
	Link belt improperly loaded.	Remove and reinstall link belt properly.
	Defective ammunition.	Eject round.
	Faulty ammunition.	Replace ammunition.
	Broken or damaged firing pin.	Notify organizational maintenance.
	Broken or weak driving spring.	Notify organizational maintenance.
Failure to extract.	Dirty chamber or bolt and slide assembly.	Clean chamber or bolt and slide assembly. If problem continues, notify organizational maintenance.
	Carbon buildup in gas system.	Clean gas regulator, cylinder, and piston.
	Damaged extractor or spring.	Notify organizational maintenance.
Failure to chamber.	Dirty ammunition	Clean ammunition.
	Carbon buildup in gas cylinder.	Clean gas cylinder.
	Carbon buildup in receiver.	Clean receiver.
	Damaged round.	Remove round and recock weapon.
	Damaged or weak driving spring.	Notify organizational maintenance.
	Dirty chamber.	Clean chamber.
	Damaged gas regulator.	Notify organizational maintenance.
Failure to eject.	Short recoil.	Clean and lubricate slide and bolt assembly. If problem still exists, notify organizational maintenance.
	Damaged ejector or spring.	Notify organizational maintenance.
	Carbon buildup in gas system.	Clean gas regulator, piston and cylinder.

Figure 2-27. Stoppages.

---

## Section 5

### Mounts and Accessories

---

The SAW is best employed using the bipod for support. The bipod provides a stable platform that best enables the automatic rifleman to accurately engage targets at the maximum effective range of the weapon. In some situations, however, it may be necessary to employ the weapon using assault fire techniques. See section 8, Operation and Firing, of this chapter for more detail.

#### 2501. Bipod

The bipod is used to fire from the prone position or from a fighting hole. The shoulder rest on the buttstock provides support for the SAW when fired in the bipod mode. The gas cylinder holds the bipod in place. Once the gas cylinder is removed, the bipod can also be removed from the receiver.

- To lower the bipod legs, hold the legs together and pull down and away from the handguard. Release the legs so that they lock in the vertical position. To

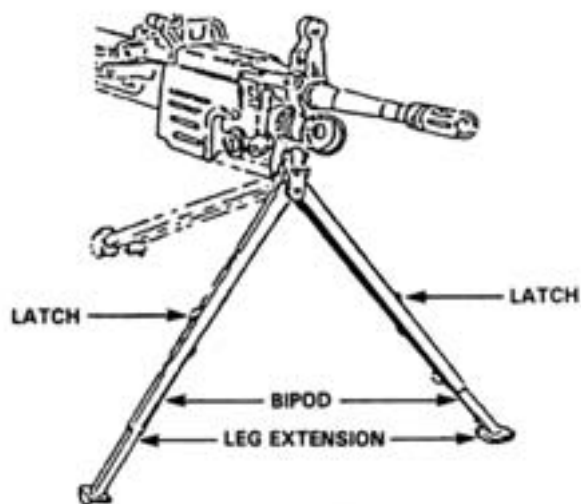

**Figure 2-28. Lowering the Bipod.**

extend the bipod legs, grasp the foot of each leg and pull down. See figure 2-28.

- To retract the bipod legs, push in the latches and push in the legs.
- Fold the bipod legs when transporting the weapon. Hold the two legs together, pull back under the handguard, and release so that the hooks on the legs grip the handguard. The bipod can be folded only when the legs are in the closed position. See figure 2-29.

#### 2502. Spare Barrel Bag

The spare barrel bag is used to carry a spare barrel for each SAW. It has an attached carrying strap and zippered exterior pocket for carrying additional cleaning gear or accessories. See figure 2-30.

#### 2503. Night Vision Sights

The principal night vision sight used with the SAW is the AN/PVS-4.

**a. Zeroing the AN/PVS-4.** Zeroing aligns the AN/PVS-4 to the SAW. The sight may be zeroed during daylight or darkness. (TM 11- 5855-238-10.) To obtain a precise zero, it is best done at 300 meters and at night. If done during daylight, the daylight cover must be used. Once an AN/PVS-4 has been zeroed on an SAW, anyone who knows how to use the reticle should fire the weapon effectively. However, there may be some changes in zero when the objective focus is adjusted to engage targets at various ranges and when the diopter focus is adjusted for the vision of different firers. A metal target is excellent for zeroing purposes, because the strike of the round can be easily observed with an AN/PVS-4.

---

#### CAUTION

---

When mounting an AN/PVS-4 to the mounting bracket, make sure that the hole for the screw in the AN/PVS-4 is aligned and flush against the bracket screw. If not, the screw will strip the threads in the screw hole of the AN/PVS-4 and prevent use with the SAW.

---



**Figure 2-29. Folding of Bipod Under the Handguard.**

**b. Mounting the Bracket and the Device**

- Place the mounting bracket on top of the feed cover mechanism assembly so that the two forked ends are secured around the headless pins.
- Remove the screw cover behind the rear sight assembly, and screw the bracket knob in until it is tight.
- Position the AN/PVS-4 on top of the bracket so that the mount of the AN/PVS-4 is aligned with the mounting knob of the bracket.
- Turn the mounting knob clockwise until the AN/PVS-4 is tight. See figure 2-31.

**c. Seating the Device.** Once the device is mounted, the automatic rifleman fires a three-round

burst to seat the device, checks and tightens the mounting knob, and then fires another three-round burst. He checks the device to ensure it is settled and securely fastened and tightens the mounting knob, if necessary. He does not fire at the boresight target during this procedure.

**d. Centering the Reticle in the Field of View.** The automatic rifleman turns the device on and centers the reticle pattern in the field of view by using the azimuth and elevation actuators. To be accurate, he does this by rotating the elevation and azimuth actuators from one side to the other and from top to bottom while counting the number of clicks. (The elevation actuator has the down direction marked *DN* with an arrow. This moves the strike of the round. The azimuth actuator has the





**Figure 2-30. Spare Barrel Bag.**

right direction marked with *RT* with an arrow. This also moves the strike of the round. He divides the number of clicks for each by two and moves the elevation and azimuth actuators that number of clicks. This manually centers the reticle in the field of view horizontally and vertically. This enables the automatic rifleman to reach an accurate boresight between the point of aim (reticle) and the center of the bore. See figure 2-32.

**e. Confirming the Boresight.** To do this, the automatic rifleman centers and affixes a 25-meter (M16A2) zero target to the back of a basic machine gun paster target. This provides a large, clear surface for identifying the strike of the round. Then, he emplaces the target 10 meters from the firing position. The automatic rifleman places the reticle aiming point on the 25-meter zero target aiming point (see figure 2-33, page 2-32), and fires a single round. If the round impacts anywhere near the aiming point, he fires two more rounds to establish his group.

---

## Section 6 Maintenance

---

Proper maintenance, care, cleaning, and inspection of a weapon and its accessories determine whether or not it will function correctly when needed. The bore and chamber must be properly maintained to preserve accuracy. Because of the close fit of working surfaces and the high speed at which the gun operates, the receiver and all moving parts must be kept clean, correctly lubricated, and free from burrs, rust, and dirt to ensure proper, efficient functioning.

There are certain actions that must be taken before, during, and after firing to properly maintain the SAW.

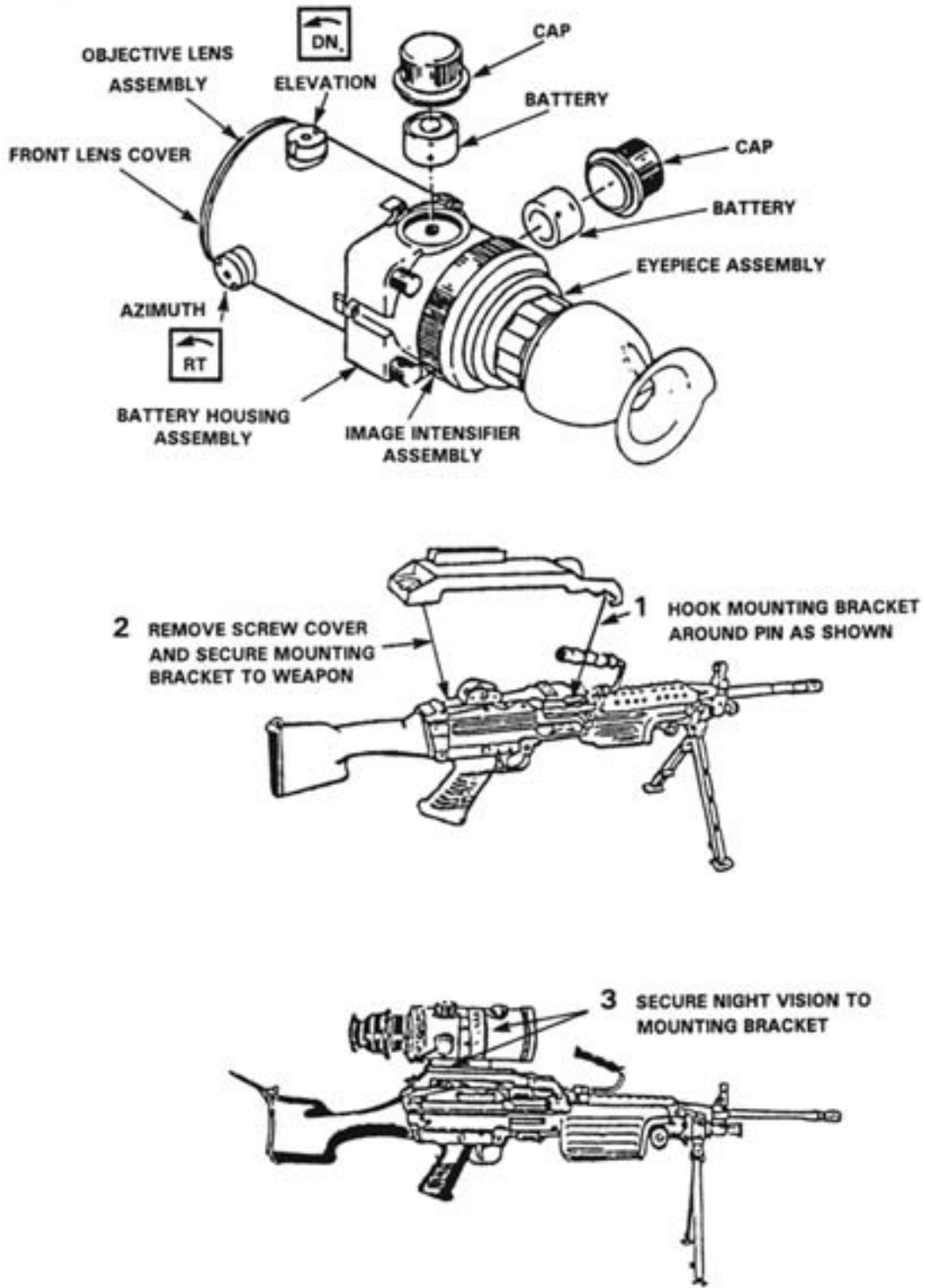

Figure 2-31. Mounting the Bracket and the Device.

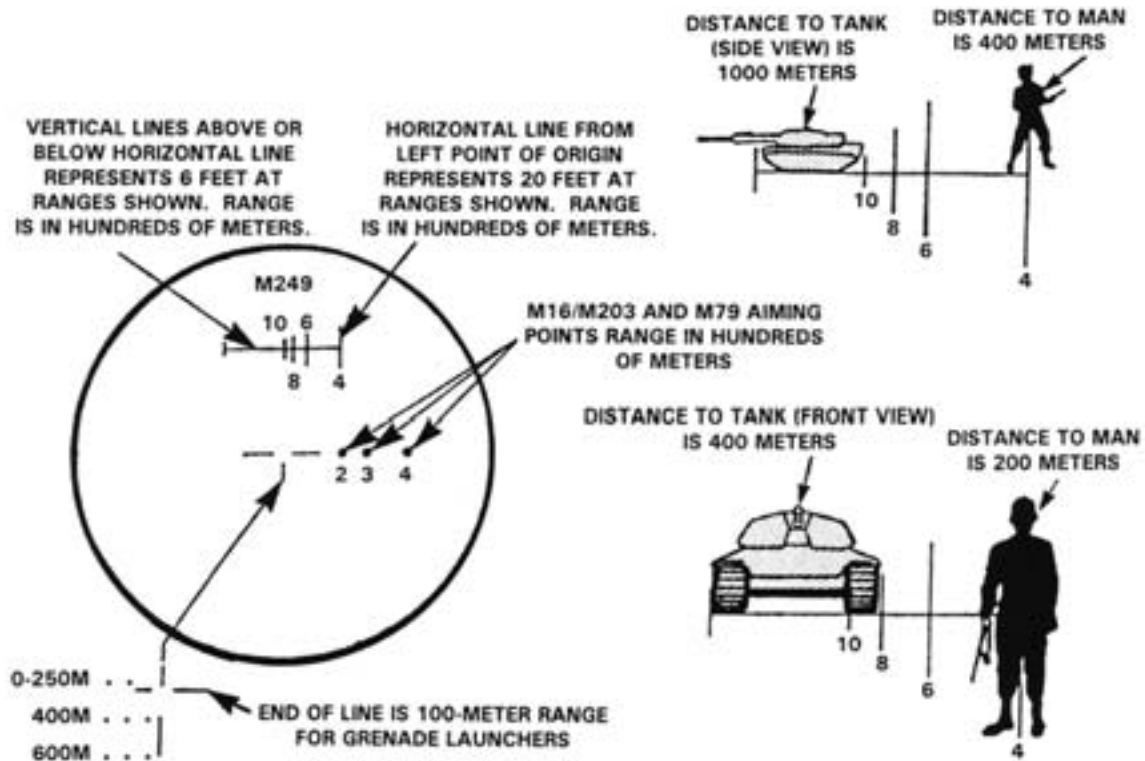

Figure 2-32. Centered Reticle Pattern.

## 2601. Care and Cleaning Before, During, and After Firing

### a. Before Firing

- Wipe the bore dry.
- Inspect the weapon as outlined in the operator's technical manual.
- Lubricate the weapon.

### b. During Firing

- Inspect the weapon periodically to ensure that it remains lubricated.
- When malfunctions or stoppages occur, follow the procedures in section 4.

### c. After Firing

- Immediately clear and clean the weapon.
- Every 90 days during inactivity, clean and lubricate the weapon unless inspection reveals more frequent servicing is necessary.

## 2602. Normal Maintenance Procedures

The SAW should be cleaned immediately after firing. It should be detail disassembled before cleaning. After it has been cleaned and wiped dry, a thin coat of CLP is applied by rubbing with a cloth. This lubricates and preserves the exposed metal parts during all normal temperature ranges. When not in use, the SAW should be inspected daily and cleaned and lubricated when necessary.

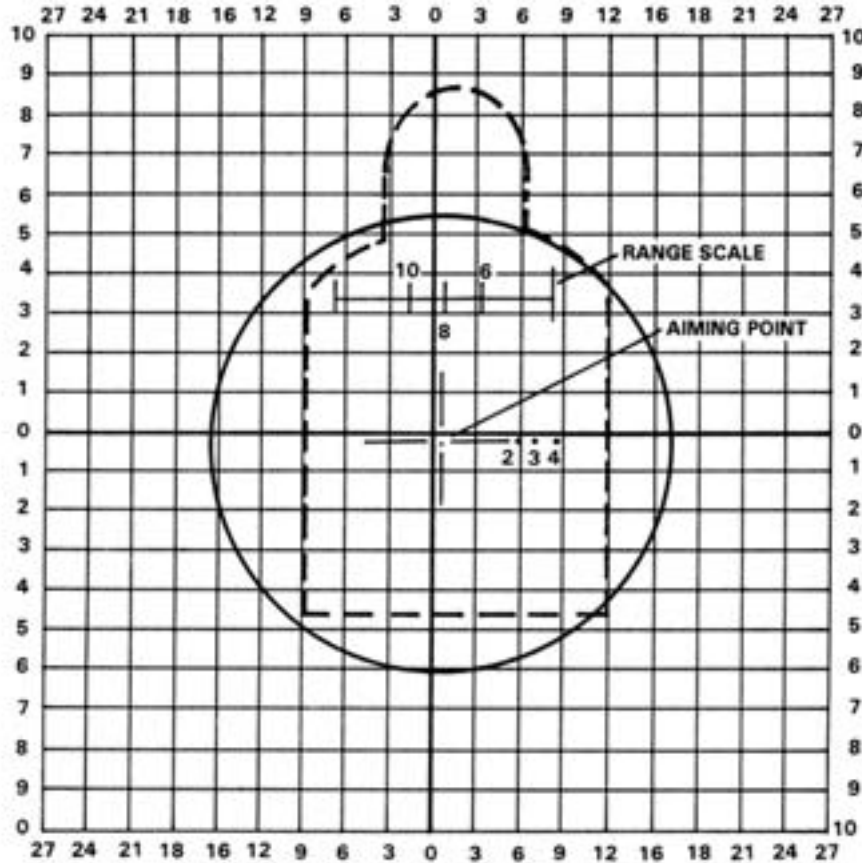

**Figure 2-33. Reticle Aiming Point and the Target Aiming Point.**

**a. Cleaning.** Cleaning material authorized for use on the SAW by the operator is CLP, RBC, and dry cleaning solvent. Use CLP or RBC for daily maintenance and to remove minor carbon buildup after firing. Dry cleaning solvent will dry out the metal and is recommended for cleaning when changing from one type of lubricant to another.

The special tool, scraper, is used to clean the gas system. Just as its name implies it is used to scrape carbon buildup out of the various ports, grooves and recesses of the gas cylinder, piston, block, and collar. See the text below for details. This tool is carried in the handguard along with the other SL-3 cleaning components for the weapon. See figure 2-34.

All metal components and surfaces that have been exposed to powder fouling should be cleaned using CLP on a bore-cleaning patch. The same procedure is used to clean the receiver.

#### CAUTION

When using CLP, no other type cleaner can be used. Never mix CLP with RBC or LSA.

- (1) **Bore and chamber.** Use CLP and fresh swabs.
- (2) **Gas regulator.** Use the special tool (scraper). Remove all carbon dust. Do not use CLP on the collar, gas block, or body.
  - Clean the gas vent hole. See figure 2-35.

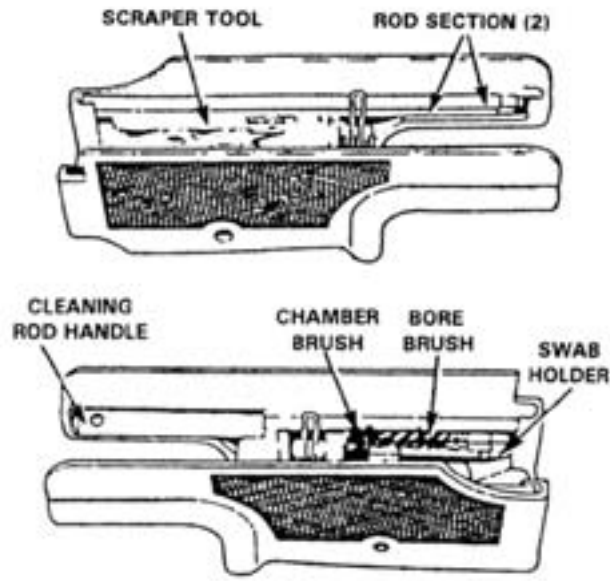

Figure 2-34. SAW Tool Storage.

- Clean the central hole with the appropriate part of the scraper by turning it clockwise and pushing it inward toward the bottom of the housing. See figure 2-36.
- Use the protruding tips of the scraper to clean the two grooves of the body. See figure 2-37.



Figure 2-35. Cleaning the Gas Vent Hole.

(3) **Gas cylinder and piston.** Use the special tool (scraper). Do not use CLP on the gas cylinder or piston.

- Clean the front interior of the gas cylinder (repositioned in receiver with bipod in place) by inserting and turning the flat side of the scraper in a 360 degree circular motion. See figure 2-38.
- Clean the internal grooves of the front side of the gas cylinder the same as described in the preceding bullet, except insert the scraper farther into the gas cylinder. See figure 2-38.
- Clean the three grooves of the piston using a 360 degree circular motion (see figure 2-39). Remove all carbon dust from the piston inside and out.
- Clean the hole in the front of the piston by inserting and turning the flat side of the scraper in a 360 degree circular motion. See figure 2-40.

(4) **All other parts.** Clean carbon and dirt from all other parts of the weapon.

#### NOTE

A cloth saturated in CLP is used on exterior surfaces to prevent corrosion.

**b. Lubricating.** The lubricants authorized for field use on the SAW are CLP and LAW. They are used to lubricate certain parts of the weapon before, during, and after firing (see paragraph 2601). Each type is



Figure 2-36. Cleaning the Central Hole.

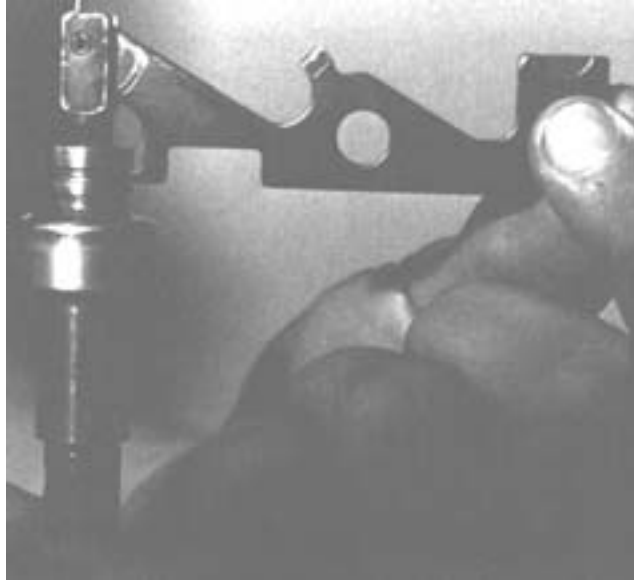

**Figure 2-37. Cleaning the Grooves of the Body.**

best used in specific climatic and environmental conditions (see paragraph 2602).

After the SAW is cleaned and wiped dry, a thin coat of CLP is applied by rubbing it with a cloth. This lubricates and preserves the exposed metal parts during all normal temperature ranges. The moving parts are lubricated with CLP. After lubricating, rub the components by hand to spread the CLP.

**(1) Operating rod group.** Use CLP on the operating rod and spring, the slide assembly, the feed roller, and the bolt-locking lug.

**(2) Barrel group.** Use CLP on the cam surfaces of the bolt-locking lugs, the heat shield, and along the outer surfaces of the barrel clamp.

**(3) Receiver group.** Use CLP on all moving parts on the cover assembly and the receiver rails.



**Figure 2-38. Cleaning the Front Interior and Internal Grooves of the Gas Cylinder.**



**Figure 2-39. Cleaning the Grooves of the Piston.**

### 2603. Special Maintenance Procedures

#### a. Climatic Conditions

(1) **Cold climates.** In cold climates, the SAW must be kept free of excess lubricants, cleaners, and moisture, all of which can freeze and cause the weapon to operate sluggishly. If brought indoors, allow the SAW to come to room temperature, wipe completely dry, and lubricate with a light coat of CLP. In temperatures between 10 degrees Fahrenheit (-12 degrees centigrade) and -10 degrees Fahrenheit (-23 degrees centigrade), the SAW should be lubricated with CLP, or LAW. In sustained temperatures below -10 degrees Fahrenheit (-23 degrees centigrade) use LAW only.

(2) **Hot, humid climates.** In hot, humid climates, inspect more frequently for rust and keep free of moisture. Ensure that the SAW is lubricated properly with CLP. Generally a heavier application of lubricant is required.

(3) **Hot, dry climates.** In hot, dry climates, sand and dust must be kept from collecting in working parts. Clean the weapon daily with CLP. Wipe dry. The Teflon coating left by the CLP will be sufficient to keep the parts working smoothly.

**b. Nuclear, Biological, and Chemical (NBC) Conditions.** If contamination is anticipated, apply lubricant to all outer surfaces of the weapon (do not lubricate ammunition). Keep the weapon covered as much as possible. If the weapon is contaminated, decontaminate by following the procedures outlined in FM 3-5, *NBC Decontamination*, then clean and lubricate.

### 2604. Inspection

Inspection begins with the weapon disassembled in its major groups. Shiny surfaces do not mean the parts are unserviceable. The following parts of the weapon and related equipment are inspected for the conditions indicated. Any broken or missing parts should be repaired or replaced according to TM 9-1005-201-10.

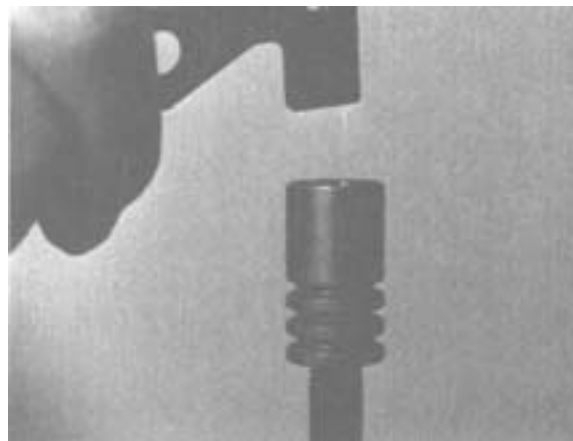

**Figure 2-40. Cleaning the Hole in the Front of the Piston.**

**a. Operating Rod Group**

- The operating rod should not be bent, broken, or cracked.
- The buffer spring should not have breaks.
- Lug pins should protrude equally on both sides of the buffer spacer.
- The operating rod spring should not have kinks or separated strands or broken strands. It can have a maximum of one break on any one strand.
- The bolt assembly is checked for visible damage. The cartridge extractor should not be cracked or chipped.
- The slide assembly is checked for visible damage. The feed roller is checked for spring tension when compressed and that the pivot slide is locked onto the slide assembly.
- The firing pin is checked for straightness and cracks and that the tip is completely rounded.
- The firing pin spring should not be crushed or bent. The beveled end should not be stretched.
- The sear notch on the piston assembly is checked for signs of excessive wear or burring. Slight rotation of the piston on its housing is normal and is not cause for rejection.

**b. Barrel Group**

- The flash suppressor should not be cracked, and it should be fastened securely.
- The front sight post and front sight base must not be bent, cracked, or broken.
- Weapons already zeroed should not be adjusted.
- The heat shield assembly is inspected for damage, cracks, or broken retaining clamps.
- The gas regulator and collar are checked for cracks or burrs.
- The barrel is checked for bulges, cracks, bends, obstructions, or pits in the chamber or bore.
- The gas plug is checked for obstructions, cracks, and bulges.

- The carrying handle is checked to ensure it is not cracked, broken, or missing; that it can be folded under spring pressure to the right and left; and that it remains locked in an upright position.

**c. Handguard Group**

- The handguard should not be cracked or broken.
- The retaining clip must be attached to the handguard retaining pin.

**d. Buttstock and Buffer Assembly Group**

- The buttstock is checked for cracks, bends, or breaks; and for missing components. It is checked for linkage and tension on the buffer rod.
- The shoulder rest is checked to ensure it is not bent or broken and that it locks in both positions.

**e. Trigger Mechanism Group**

- The shoulder of the sear should not show excessive wear.
- The safety should function properly. (The sear should move only slightly when the safety is on *SAFE*, and freely when the safety is on *FIRE*).
- The sear pin should not protrude from the trigger mechanism, because the trigger mechanism will not go back in place.

- f. Gas Cylinder Group.** The gas cylinder should not be cracked, bent, or broken.

**g. Bipod Group**

- The bipod group should not be cracked, bent, or broken.
- The bipod legs should extend and collapse easily.

**h. Receiver Group**

- The cover latch should work properly.



- All parts inside the cover assembly should move under spring tension.
- All spot welds are checked for cracks.
- The cover assembly should remain open without support.
- The belt-holding pawl must be under spring tension.
- The receiver should not be bent or cracked.
- The cocking handle should slide freely within its guide and lock in its forward position.
- The windage and elevation knobs on the rear sight should be movable and legible.
- The windage scale screws should not be worn or burred.

---

## Section 7 Ammunition

---

This section covers the several different types of 5.56mm standard military ammunition used in the SAW (see figure 2-41). Marines should become familiar with and recognize the appropriate ammunition types.

### 2701. Classification

Ammunition for the SAW is classified as listed:

- a. Ball.** Used against targets of light material, personnel, and during marksmanship training.
- b. Tracer.** Used for observation of fire, signalling, and marking targets.
- c. Blank.** Used during training when simulated fire is desired.
- d. Dummy.** Used during training such as gun drill, and loading and unloading practice.

### 2702. Identification

The type, caliber, model, and ammunition lot number, including the symbol of the manufacturer, are necessary for the complete identification of small arms ammunition. The standard 5.56mm NATO cartridge is completely identifiable by its appearance, the painting of the bullet tip, the manufacturer's initial and year of manufacture on the base of the cartridge case, and the markings on the packing containers. When removed from the original packing container, the cartridge may be identified by its physical characteristics. The cartridge description and characteristics are as follows.

**a. Cartridge, 5.56mm Ball M855 (DODAC 1305-A059).** The M855 cartridge has a gilding, metal-jacketed, lead alloy core bullet with a steel penetrator. The primer and case are waterproof. The ammunition is linked by a disintegrating metallic split-linked belt for firing from the ammunition box (see figure 2-42). In an *emergency*, the M855 round can also be loaded and fired from the SAW using a 20 or 30 round magazine from an M16. The M855 round is identified by a green tip, has a projectile weight of 62 grains, and is 2.3 cm long. This is the NATO standard round. It is effective against personnel and light materials.

**b. Cartridge, 5.56mm Tracer, M856 (DODAC 1305-A064).** This cartridge has a 63.7 grain bullet without a steel penetrator. It is identified by an orange tip. The tracer is used for adjustments after observation, incendiary effects, and signalling. When tracer rounds are fired, they are mixed with ball ammunition in a ratio of four ball rounds to one tracer round. The DODAC for ball and tracer mix is A064.

**c. Cartridge, 5.56mm Dummy M199 (DODAC 1305-A060).** This cartridge can be identified by the six grooves along the side of the case beginning about one-half inch from its head. It contains no propellant or primer. The primer well is open to prevent damage to the firing pin. The dummy round is used during mechanical training, dry-fire exercises, and function checks.

CARTRIDGE, 5.56MM, BALL, M855

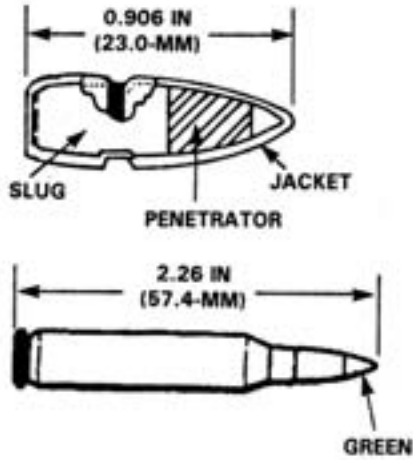

CARTRIDGE, 5.56MM, TRACER, M856

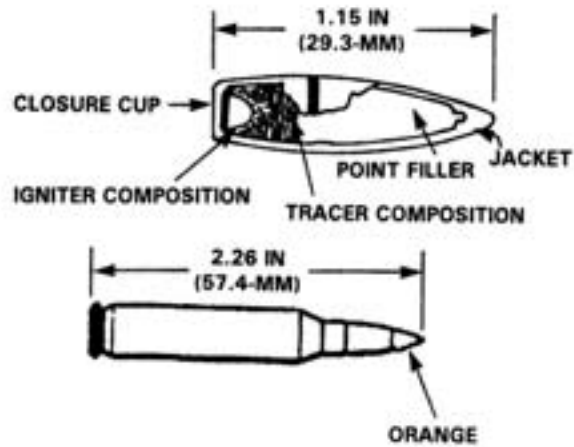

CARTRIDGE, DUMMY, 5.56-MM, M199

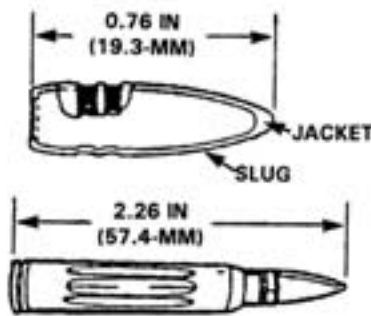

CARTRIDGE, 5.56-MM, BLANK, M200

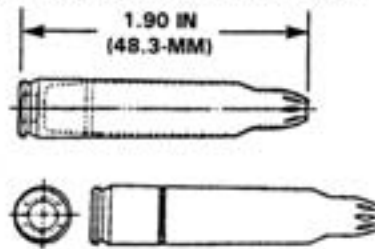

Figure 2-41. Cartridges for the SAW.

**NOTE**

The older issue M193 (ball) and M196 (tracer) 5.56mm cartridges can be fired with the SAW, but accuracy is degraded; therefore, it should only be used in emergency situations when the new M855 or M856 ammunition described on page 2-33 is not available.

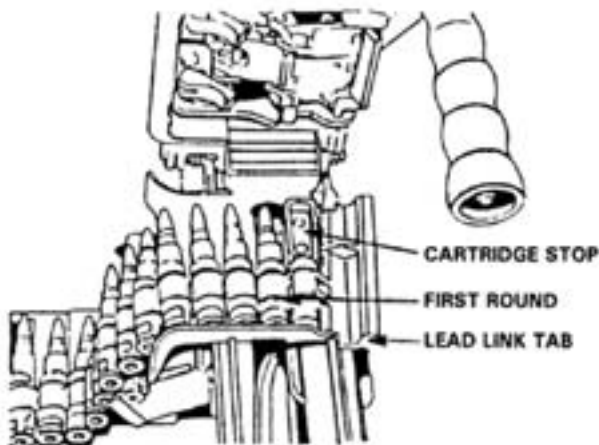

Figure 2-42. Cartridges in Metallic Belt.

d. **Cartridge, 5.56mm blank M200 (M2 link, DODAC 1305-A075).** The blank cartridge has no projectile. The case mouth is closed with a seven-petal rosette crimp and has a violet tip. The original M200 blank cartridge had a white tip. Field use of this cartridge resulted in residue buildup, which caused malfunctions. Only the violet-tipped M200 cartridge should be used. The blank round is used during training when simulated live fire is desired.

An M15A2 blank-firing attachment must be used to fire this ammunition.

### WARNING

**Do not fire blank ammunition at any person within 20 feet, because fragments of a closure wad or particles of unburned propellant can cause injury.**

### 2703. Ballistic Data

Figure 2-43 shows some examples of the penetration capability and other ballistic data for the M855 5.56mm ball round when fired from the SAW.

### 2704. Ammunition Packaging

The ammunition can contains two plastic ammunition boxes. Each box contains 200 rounds and weighs 6.92

pounds. Dummy ammunition (M199) is packed in boxes of 20 rounds each.

### 2705. Storage

Store ammunition of all classes away from heat sources such as; open flame, radiators, heaters, and hot water pipes. Ammunition is stored under cover. If ammunition is in the open, it must be kept at least 6 inches above the ground and covered with a double thickness of tarpaulin. The cover must be placed so that it protects the ammunition yet allows ventilation. Trenches are dug to divert water from flowing under the ammunition.

### 2706. Care, Handling, and Preservation of Ammunition

Ammunition should not be removed from the airtight containers until ready for use. Ammunition removed

AMMO	WEAPON	R50 RANGES FOR SPECIFIED ARMOR PENETRATION				ARMOR PENETRATION AT SOME R50 RANGES		
		7.0 mm	7.4 mm	9.9 mm	18.7 mm	50 meters	300 meters	500 meters
B	M16A2/ M249	-0-	-0-	-0-	-0-	5.5 mm	4.0 mm	3.0 mm
A	M16A2/ M249	325 meters	300 meters	150 meters	-0-	12.0 mm	7.5 mm	4.75 mm

WEAPON	UNITS	HORIZONTAL RANGE								
		0 Meters	100 Meters	200 Meters	300 Meters	400 Meters	500 Meters	600 Meters	700 Meters	800 Meters
M249 SAW	Energy (ft)	1245.7	1004.8	798.2	621.7	474.6	354.2	256.8	183.5	140.4
	Energy (joules)	1689.1	1362.5	1082.3	843.0	643.6	480.3	348.3	248.8	190.3
	Velocity (ft/sec)	3013.0	2706.0	2411.8	2128.5	1859.8	1606.7	1368.1	1156.4	1011.4
	Bullet Drop (ft)	0	-0.205	-0.886	-2.165	-4.215	-7.275	-11.690	-17.976	-28.859

Figure 2-43. Ballistic Data for 5.56mm Ammunition.

from the airtight containers, particularly in damp climates, may corrode.

Ammunition must be protected from mud, dirt, and moisture. If it gets wet or dirty, the ammunition must be wiped off before using. Lightly corroded cartridges are wiped off as soon as the corrosion is discovered. Heavily corroded, dented, or loose projectiles should not be fired.

Ammunition must also be protected from the direct rays of the sun. Excessive pressure from the heat may cause premature detonation.

Oil should never be used on ammunition. Oil collects dust and other abrasives that may possibly damage the operating parts of the weapon.

---

## Section 8 Operation and Firing

---

The SAW squad automatic weapon fires from the open bolt position to facilitate cooling. When the trigger is pulled, the bolt and operating rod start forward initiating the firing sequence. The weapon will continue to fire as long as the trigger is held to the rear and it is supplied with ammunition. The firing operation works on gas pressure created as a fired round passes through the barrel. Whenever the bolt is to the rear the weapon is ready to fire so the weapon must be placed on *SAFE* to prevent firing. The safety is not designed to be engaged when the bolt is forward. The SAW is loaded, fired, unloaded, and cleared from the open-bolt position. As with other small arms, Condition Codes are applied when carrying the SAW. In Condition 1 the weapon is ready to fire when taken off *SAFE*, while Conditions 3 and 4 place the weapon in a less ready status. They are described in figure 2-44.

### NOTE

The ammunition box, if used, should be attached to the underside of the weapon in all three applicable conditions to allow faster transition from one condition to another.

**CONDITION 1:** The bolt is locked to the rear. The safety is engaged. Ammunition is on the feed tray or a magazine is inserted. The cover is closed.

**CONDITION 2:** Not applicable to the M249.

**CONDITION 3:** The bolt is forward. The chamber is empty. The safety is off. The source of ammunition is on the feed tray or in the magazine well. The cover is closed.

**CONDITION 4:** The bolt is forward. The safety is not engaged. The feed tray is clear of ammunition and/or no magazine is inserted. The cover is closed.

**Figure 2-44. Condition Codes for the SAW.**

### 2801. Loading

To load the SAW, make sure the weapon is cleared, as described in Section 2. (With the feed cover raised, make sure your face is not exposed to the open chamber area when loading.) See figure 2-45.

**a. Belt-Fed.** When loading belted ammunition, always cant the weapon to the right. The ammunition box, if used, is attached to the weapon by sliding the flanges on the top of the box into the grooved tracks on the bottom of the receiver until the holding lever on the box snaps into place. A loose belt of ammunition, without the ammunition box, can also be used but care must be taken to keep the ammunition as clean as possible during firing to ensure smooth feeding of the rounds. Make sure the open side of the links are facing down, and place the lead link tab or first round of the belt in the tray groove against the cartridge stop (see figure 2-46). The rounds should be placed flat across the feed tray. With the left hand, count five to six rounds down to hold ammunition in place on the feed tray, and at the same time close the feed cover with the right hand. When closing the feed cover, always place your hand in front of the rear sight to prevent accidentally changing the sight adjustment.



Figure 2-45. Loading.

**b. Magazine-Fed.** Load the 20 or 30 round magazine by inserting it into the magazine well on the left side of the receiver. Push the magazine firmly into the well until it seats and the release tab clicks into the recess on the magazine. See figure 2-47.

#### NOTE

The 20 or 30 round magazine is for emergency use only when linked ammunition is not available.

### 2802. Unloading

To unload the weapon, pull the bolt and lock it in the rear position if it is not already there. Place the safety on *SAFE*. Depending on whether belt-fed or magazine-fed ammunition is used, use the following procedures.

---

#### CAUTION

---

Before raising the feed cover, move the weapon away from your face so that you are not exposed to the open chamber.

---

**a. Belt-Fed.** Raise the feed cover and remove any ammunition or links from the feed tray. Perform the five-point safety check.

**b. Magazine-Fed.** Push the magazine release tab down and pull the magazine from the magazine well. Raise the feed cover and perform the five-point safety check.

### 2803. Operation of the Safety

When the safety is on, the cutaway portion of the safety bar is not aligned with the safety lug of the



**Figure 2-46. Loading an Ammunition Belt.**

sear. When the trigger is pulled, the sear cannot rotate downward and the operating group cannot move forward. When the safety is placed in the *FIRE* position, the cutaway portion of the safety bar is aligned with the safety lug on the sear, allowing the sear to move downward when the trigger is pulled, releasing the operating group and initiating the cycle of function. The weapon is not designed to be placed on *SAFE* with the bolt forward.

#### **2804. Firing the SAW**

**a. Trigger Manipulation.** The trigger is pulled to the rear and then released. This gives the rifleman control of the number of rounds fired in each burst. The sustained rate of fire (100 rounds per minute) is delivered in bursts of 3 to 5 rounds which are fired 4 to 5 seconds apart. The rapid rate of fire (200 rounds per minute) is delivered in bursts of 6 to 8 rounds which are fired 2 to 3 seconds apart.

#### **b. Traverse and Search**

To make minor changes in direction, or traverse, the rifleman shifts his shoulders to the right or left to select successive aiming points in the target area. Major changes require him to redistribute his weight to his elbows and toes and raise his body off the ground. Using his toes, he shifts his body to the right or left to be in the opposite direction of the target, and pivots on his elbows until he is once again aligned with the target. He rapidly assumes a steady position, obtains the proper sight picture, and engages the target.

A search is movement of the weapon's muzzle up or down to distribute fire in depth. To make changes in elevation, the rifleman moves his elbows closer together to lower the muzzle or farther apart to raise the muzzle. Gross errors in range are corrected by adjusting the range setting with the elevation knob.



**Figure 2-47. Loading a Magazine.**

**c. Prone Position, Bipod-Supported.** This is the preferred position for employment of the SAW. This position provides the most stable platform for firing the weapon and affords the automatic rifleman the best opportunity to provide the most accurate fire possible out to the maximum effective range of the weapon. See figure 2-48.

- Assume a prone position to the rear of the weapon and place the shoulder rest on the firing shoulder. An imaginary line drawn through the weapon should bisect the firing shoulder and buttock and continue through the heel of the foot.
- Spread the legs a comfortable distance apart with heels as close to the ground as possible and yet still be comfortable.
- Grasp the pistol grip with the firing hand with the fleshy end of the index finger resting lightly on the trigger. Place the non-firing hand on the small of the stock with the thumb curled underneath. Slide the non-firing hand forward until the little finger

touches the receiver, so the aiming point will always be the same.

- Place the cheek against the forefinger of the non-firing hand to form a stock weld. Try to position the non-firing hand and cheek at the same spot on the stock each time the weapon is fired. The stock weld should provide for a natural line of sight through the center of the rear sight aperture to the front sight post and to the target. Relax the neck so that the cheek rests on the forefinger naturally.
- Apply a firm, steady pressure rearward and down, holding the weapon tightly into the hollow of the shoulder while aiming and firing.
- Keep the shoulders level and elbows about an equal distance from the receiver of the weapon.

**d. Assault Fire Techniques.** The bipod supported prone position is the preferred firing position for the SAW; however, it may sometimes be necessary to employ the weapon from more hasty positions. This



**Figure 2-48. Prone Position, Bipod-Supported.**

should only be done when absolutely necessary because the accuracy of the fire is greatly diminished. For example, assault fire techniques may be used for initial bursts of suppression fire prior to assuming the prone position, in a chance encounter with the enemy, or for suppression fire as the automatic rifleman moves quickly through an objective toward consolidation.

**(1) Firing from the hip.** In the preferred assault fire technique, the automatic rifleman grasps the bipod legs close to the receiver, squeezes them together, and maintains pressure on them downward and to the left as he fires. Another technique is to grasp the handguard assembly, maintaining pressure down and to the left. With either technique he places the buttstock firmly against his hip and holds it there by steady inward pressure from his right forearm while firmly gripping the trigger assembly with his right hand. He leans forward at the waist and bends his knees slightly as he fires. His feet should be kept shoulder width apart when firing. See figure 2-49.

**(2) Firing from under the arm.** The automatic rifleman grasps the handguard maintaining pressure downward and to the left during firing. He places the buttstock firmly under his arm and holds it in place with steady inward pressure from his upper arm while firmly gripping the trigger assembly with his right

hand. He leans forward at the waist and bends his knees slightly as he fires. His feet should be kept shoulder width apart when firing. See figure 2-50.



**Figure 2-49. Firing From the Hip.  
(Preferred Assault Fire Technique.)**





**Figure 2-50. Firing From Under the Arm.**

### **2805. Change Barrel Procedures**

The ability to change the barrels of the SAW quickly provides a great advantage. It allows one barrel to be used while the other is cooling. Barrels should be changed when they are beginning to overheat. Changing a barrel only takes a few seconds and significantly improves rate of fire and accuracy, increases the life of each barrel, and ensures a continuous rapid rate of accurate fire. As a guide, change barrels after firing the rapid rate for 2 minutes.

The barrel can be changed with the bolt forward or to the rear. The weapon does not necessarily need to be unloaded; however, it must be placed on *SAFE* when the bolt is to the rear. The automatic rifleman depresses the barrel release latch and holds it down. The assistant automatic rifleman grasps the barrel changing handle, pulls forward and up and removes

the barrel from the receiver. While the automatic rifleman continues to hold down on the barrel release latch the assistant inserts the new barrel into the receiver, ensures that the gas system is aligned, and pulls to the rear on the barrel changing handle to fully seat the new barrel. The automatic rifleman releases the barrel release latch and the assistant gives a quick tug on the barrel to verify that it is locked in place. The automatic rifleman can now relay on target and continue to fire. The automatic rifleman can easily change barrels by himself if the situation precludes the assistant from helping him.

---

## **Section 9 Qualification Firing**

---

### **2901. Fundamentals of Marksmanship**

**a. Accurate Initial Burst.** Obtaining an accurate initial burst of fire on the target is essential to good marksmanship. This requires the automatic rifleman to estimate range to the target, set the sights, and apply the fundamentals of marksmanship while engaging targets.

**b. Adjustment of Fire.** The automatic rifleman must observe the strike of the rounds when the initial burst is fired. If not on target, he manipulates the SAW until the rounds do strike the target. He must be proficient in observing the strike of rounds, in observing and using tracers, and in rapidly laying the SAW on the target during firing.

**c. Speed.** Speed is also essential to good marksmanship; it is attained by practice in both dry-fire and live-fire exercises. It is an acquired skill gained through extensive training that combines other skills when delivering fire. Speed should not be stressed to the detriment of accuracy.

**d. Steady Position.** In automatic fire, position is the most important aspect of marksmanship. If the automatic rifleman has a good zero, aims his weapon correctly, and properly applies a steady hold in firing a burst of three rounds, the first round of that burst will hit the target at the point of aim. However, this is

not necessarily true of the second and third rounds. The first round hits the aiming point the same as when a round is fired singularly. The recoil from the first and subsequent rounds will progressively disturb the lay of the weapon with each round of the burst.

The relationship between the point of impact of the first and subsequent rounds of the burst depends on the stability of the automatic rifleman's position. His body, directly behind the weapon, serves as the foundation, and his grip serves as a lock to hold the weapon against the foundation. The better the body alignment and the steadier the grip, the less dispersed the rounds of a burst of automatic fire will be.

**e. Aim.** To aim the SAW, the automatic rifleman must align the sights, focus his eye, obtain a correct sight picture, control his breathing, and maintain trigger control.

**(1) Sight alignment.** Align the rear sight aperture (peep sight) with the sight post of the hooded front sight. Then, align the front sight post in the center of the rear peep sight. An imaginary horizontal line drawn through the center of the peep sight should touch the top of the front sight post, while an imaginary vertical line through the center of the rear peep sight should bisect the front sight post.

**(2) Focus of the eye.** A good firing position places the eye directly on line with the center of the rear sight. Focus on the tip of the front sight post. The natural ability of the eye to center objects in a circle and to seek the point of greatest light (center of peep sight) aids in providing correct sight alignment.

**(3) Sight picture.** A correct sight picture has the target, front sight post, and rear sight aligned. The sight picture consists of sight alignment and placement of the aiming point on the target. Align the tip of the front sight post in the center (see figure 2-51) of the rear peep sight and then align the sights with the target. Align the top of the front sight post on the center base of the target.

**f. Breath Control.** Two types of breath control are used. When firing single shots, as in zeroing, the automatic rifleman stops breathing after most of the air has been exhaled during the normal breathing cycle. He fires before he feels any discomfort. During automatic fire, ideally, the automatic rifleman exhales and stops his breath when pressing the trigger. He does not have time to take deep breaths between bursts. He must hold his breath before each burst or adapt his breathing by taking quick shallow breaths or taking deeper breaths between several bursts.

**g. Trigger Control.** Pressing the trigger straight to the rear and releasing it helps control the number of rounds in each burst and prevents disturbing the lay of the weapon. For a three-round burst, the automatic rifleman presses the trigger to the rear, says **PRESS**, **RELEASE**, and releases the trigger.

## 2902. Position and Grip

The rifleman is in a prone position to the rear of the gun with his right shoulder against the buttstock group. A straight line extending through the barrel

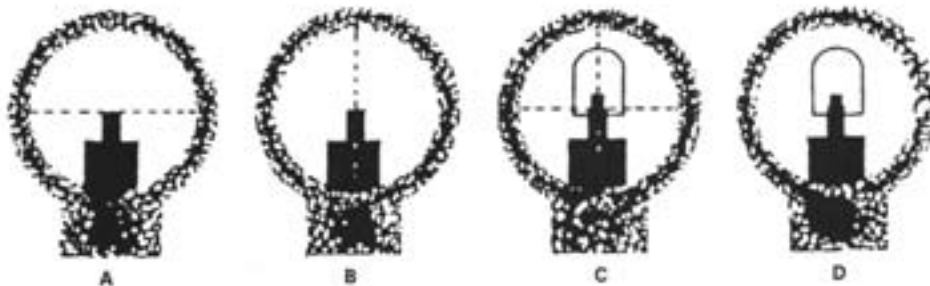

Figure 2-51. Sight Picture.

and receiver passes through his right shoulder and hip. His legs are comfortably spread and his heels are down (if possible).

The rifleman's left hand grasps the top of the buttstock or the hand guard assembly. His right hand is on the trigger assembly with his index finger on the trigger. He exerts a firm pressure to the rear with both hands while aiming and firing. His cheek rests against the buttstock directly or on his hand as it grips the buttstock. Breath control is practiced during aiming and firing.

### 2903. Sight Settings and BZO Procedures

This paragraph provides information on how to set the sights for elevation and windage for the SAW. It also includes information on how to make corrections if the initial setting on the windage knob or peep sight is not accurate. At a 10-meter target, each click is 1 cm. Therefore, two clicks on the windage knob in either direction moves the strike of the round left or right 1 cm and two turns on the peep sight moves the strike of the round up or down 1 cm. For example: If the shot group was 2 cm above and 1 cm to the right of the target, sight corrections are made by correcting windage first. In this case, rotate the windage knob two clicks toward the buttstock (clockwise). Rotate elevation knob four turns toward the buttstock (clockwise) to lower the strike of the round. See figure 2-52.

**a. Elevation.** Adjustments for elevation (range) require the automatic rifleman to turn the elevation knob (closest to the buttstock) on the rear sight to the desired range setting. Range settings are graduated in increments from 300 to 1,000 meters. Even numbered settings are on the left side of the scale wheel and are numbered 4, 6, 8, 10 which represent 400, 600, 800, and 1,000 meters, respectively. Odd numbered settings are on the right side of the scale wheel and marked with the number 3 and three index lines, which represent 300, 500, 700, 900 meters, respectively. Rotation of the elevation knob toward the muzzle (counterclockwise) increases the range, while rotation toward the buttstock (clockwise) decreases the range.

Fine adjustments, like zeroing, are made by adjusting the peep sight. Each 180-degree turn equals a 1/2-mil change in elevation which equals a 1/2-cm change in impact at a range of 10 meters. Clockwise (to the right) rotations decrease elevation, while counterclockwise (to the left) rotations increase elevation. The peep sight can be turned nine 180-degree turns from top to bottom. To make the peep sight easier to grasp, the elevation knob is turned to its highest point (1,000 meters). The appropriate adjustment is made for the peep sight, and then the sight is returned to the desired range. Whenever readjusting the range, the point of aim is never changed. The point of aim is the center base of the target.

**b. Windage.** Adjustments for windage are made by traversing the rear sight right and left along the sliding scale. The sliding scale is marked or graduated with index lines. Each index line is equal to 1/2-mil change in direction or 1/2-cm change of impact at 10 meters. Rotation of the windage knob (closest to the muzzle end) toward the muzzle (counterclockwise) moves the

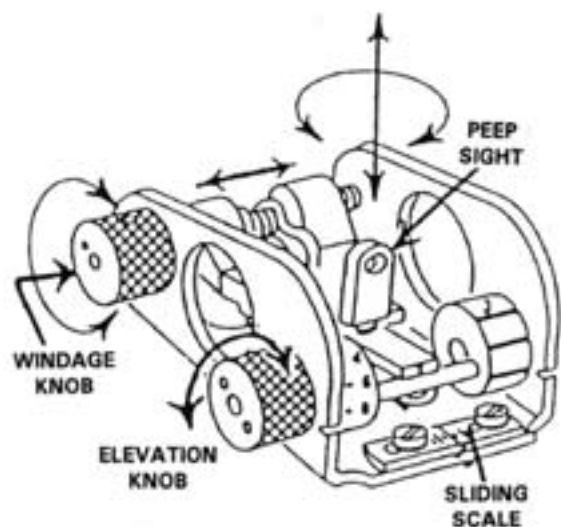

Figure 2-52. Sliding Scale on Sight.

rear sight aperture right, which moves the strike of the rounds right; while rotation toward the buttstock (clockwise) moves the aperture left, which moves the strike of the rounds left.

**c. Corrections.** One click of the windage knob or peep sight moves the strike of the round 1/2 cm at a range of 10 meters or 1/2 meter at 1,000 meters. To make corrections, figure 2-53 is used as a reference.

Range (Meters)	Sight Adjustment
100	One click moves strike 5 cm (2 inches)
200	One click moves strike 10 cm (4 inches)
300	One click moves strike 15 cm (6 inches)
400	One click moves strike 20 cm (8 inches)
500	One click moves strike 25 cm (10 inches)
600	One click moves strike 30 cm (12 inches)
700	One click moves strike 35 cm (14 inches)
800	One click moves strike 40 cm (16 inches)
900	One click moves strike 45 cm (18 inches)

**Figure 2-53. Windage and Elevation (Peep Sight) Correction Chart.**

**d. Zeroing.** Zeroing aligns the sights with the barrel so that the point of aim equals the point of impact. Ten-meter zeroing is for conducting 10-meter fire only and has no further application. (Zeroing at range or field zeroing is the automatic rifleman's battlesight zero and must be recorded.)

**(1) 10-meter zeroing, set the sights (mechanical zero).** The automatic rifleman indexes or places the elevation knob on a range of 700 meters. He centers the rear peep sight by rotating it clockwise (right) as far as it will go, then rotating counterclockwise (left) 5 clicks or half-turns. He rotates the windage knob toward the muzzle until the peep sight is completely to the right, then rotates the windage knob toward the buttstock 12 clicks to the left. This places the peep sight in the approximate center of the sight. Each sight may vary as to how many clicks are needed. To check

the sight, the automatic rifleman starts with the sight all the way to the right and, while counting the clicks, rotates the windage knob until it stops on the left side. He divides the clicks by two. If it is an uneven number, he rounds it up. To center the sight, he rotates the windage knob toward the center (right) while counting the appropriate number of clicks. He adjusts the sliding scale at the rear of the sight to center the large index line under the zeroed windage mark on the sight. Two threads should be showing on the front sight post. If more or less are showing, the automatic rifleman turns in the weapon for maintenance.

**(2) Three-round group.** The automatic rifleman fires three single rounds loaded individually at the center base of the aiming points on the basic machine gun marksmanship target. He fires the three rounds without making any adjustments to the sights. The shot group must be about a 4-cm circle or smaller to establish the center of the group in relation to the center base of the aiming paster. Establishing a smaller shot group is difficult, because the SAW is an open-bolt weapon. Sight alignment is disturbed somewhat as the bolt moves forward during firing.

**(3) Grid square overlay.** For a more accurate adjustment, the automatic rifleman moves downrange and places the grid square overlay over pasters 1 and 2. He ensures that he aligns the overlay with the pasters and squares.

- Count the number of squares it will take to move the shot group to the aiming paster.
- Upon completion, return to the firing line to make corrections to the weapon. Figure 2-54 illustrates a zero group size on which adjustments can be made and a group that is too loose for adjustments. If a group is too loose, check your position and grip.

**(4) Windage correction.** If the center of the group is to the left or right of the black aiming paster, the automatic rifleman must correct for windage. To do this, he must rotate the windage knob to move the peep sight in the direction of the desired change (rotate windage knob toward the muzzle [counterclockwise] to move the strike of the round to the right; rotate the windage knob toward the buttstock [clockwise] to move the strike of the round to the left). One click in

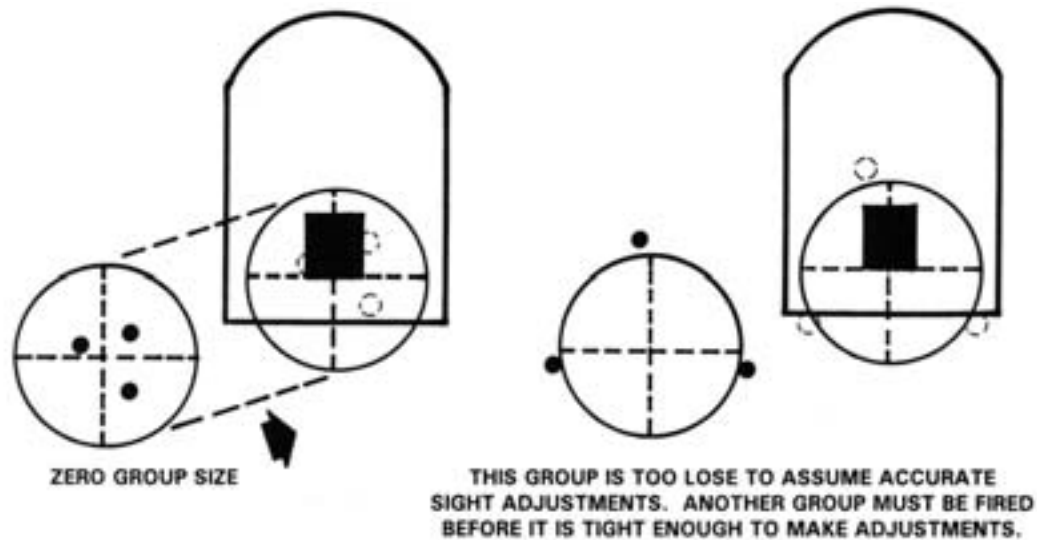

Figure 2-54. Zero Group Size.

either direction moves the strike of the round 1/2 cm at 10 meters.

For example, if the automatic rifleman sees that the center of the shot group is 2 cm (two black aiming pasters) to the left of the aiming point, he adjusts the point of impact four clicks in the direction of the aiming point (to the right) by rotating the windage knob toward the muzzle.

**(5) Elevation correction.** Before making elevation adjustments, the range knob must be at its highest setting. If the center of the shot group is above or below the aiming point, the automatic rifleman rotates the peep sight clockwise to lower the strike of the round or rotates the peep sight counterclockwise to raise the strike of the round. One 180-degree turn in either direction moves the strike of the round 1/2 cm at 10 meters.

**(6) Confirmation.** The automatic rifleman fires another three-shot group (loaded singly) after making his corrections for windage and elevation. If the center of the group is still off the aiming point, he adjusts further until the group is centered on the point of aim.

**(7) Recording.** There is no reason to record the 10-meter zero, because it applies only to firing at the 10-meter basic machine gun target.

**e. Field Zeroing.** Automatic rifleman must know how to zero the SAW at distance. He should select a known distance target between 300 and 700 meters. It is difficult to determine fully where the center of the beaten zone is in relation to the target as range increases. Therefore, the 300-meter target on the transition range is recommended because of the ease of determining adjustments.

**(1) Set the sights.** The automatic rifleman uses the same procedures as for 10-meter zeroing are used except he places the elevation knob on the range to the target. The recommended range is 300 meters.

**(2) Fire a three-round burst.** The automatic rifleman assumes a good stable position and fires a three-round burst at the center base of the target and notes where the burst strikes.

**(3) Correct for windage.** If the center of the beaten zone is to the left or right of the target, he corrects for windage. Each click moves the strike of the rounds 1/2 mil or 6 inches at 300 meters. He adjusts the windage knob accordingly.

**(4) Correct for elevation.** If the center of the beaten zone is high or low in relation to the target, he corrects for elevation. Because determining that

relationship is difficult, automatic riflemen rely on trial and error to gain sufficient experience in making reliable estimates. He makes corrections in the same manner as 10-meter zeroing.

(5) **Confirm.** After making corrections for windage and elevation, he fires a confirming burst of three rounds. If the target is not hit, he repeats the procedures.

(6) **Record zero.** Upon confirming the zero, he records it by counting the number of clicks (half-turns) he moved the peep sight for elevation in relation to the initial setting of 5. For example, if he made two half-turns up, he records UP 2. If he made two half-turns down, he records DOWN 2. Adjustments for the windage scale are not recorded; instead, he loosens the windage sliding scale screws and aligns the scale so that the large index line is under the windage mark on the sight. Then, he tightens the screws.

## 2904. 10-Meter Firing

**a. Targets and Scoring.** The basic machine gun target (FSN 6920-078-5128) is used for the 10-meter firing exercise (see figure 2-55). The following explanation of the target, including the size of the aiming pasters and scoring spaces, aids in zeroing the M249s and facilitates control during the 10-meter firing exercises. The target consists of four sections lettered A, B, C, and D. Each section has four point targets numbered 1, 2, 3, and 4; and two sets of area targets numbered 5 through 6 and 7 through 8. Each space is 4 cm wide and 5 cm high. The black aiming paster within the numbered scoring spaces is 1 cm square. The target is used to score two automatic riflemen—one uses sections A and B, and the other automatic rifleman uses sections C and D.

(1) **Point targets.** Point targets on the basic machine gun target are pasters 1 through 4 of sections A, B, C, and D. Firing at point targets exposes the automatic rifleman to zeroing techniques and controlled-burst fire techniques. Targets 1 through 4 can also be used for qualification.

(2) **Area targets.** Area targets on the basic machine gun target consist of pasters 5 through 6, and 7 through 8 of sections A, B, C, and D. Target group 5 through 6 provides the automatic rifleman with targets in depth and allows him to use a series of aiming

points to disburse fire across the target by using body position changes. Target group 7 through 8 provides the automatic rifleman with linear targets with depth. This series of targets uses a series of aiming points to disburse fire across the target and in depth by using body position changes.

(3) **Grid square overlay.** This device assists the automatic rifleman in zeroing his weapon at 10 meters, while using the basic machine gun target (see figure 2-56). The grid square overlay is used the same as an M16A2 25-meter zero target, except the material can be made of plastic or view graph transparency. Each square is equal to 1 cm.

- Set the sights for 10-meter zeroing, then fire a three-round shot group.
- After firing the second three-round shot group (see figure 2-57), place the grid square overlay over the pasters 1 and 2 (see figure 2-58), and count the number of clicks it will take for rounds to impact on the black aiming paster. (Corrections for figure 2-57 would be turn the windage knob toward the muzzle (clockwise) two clicks.)

(4) **Target analysis.** Targets are analyzed and scored to determine the automatic rifleman's proficiency and to reinforce the fundamentals of marksmanship. During firing with a zeroed weapon, a target is best analyzed by considering the common errors of SAW marksmanship. See figure 2-59.

(5) **Scoring procedures.** When scoring the 10-meter target, the trainer scores all scoring spaces (1 through 4, 5 through 6, and 7 through 8). One point is given for each round impacting within each scoring space. The maximum point value is 3 points for each scoring space. Rounds touching the line on the paster are considered a HIT. When firing at 1 through 4 with a belt of 12 rounds, the maximum score the automatic rifleman can receive is 12 points. When firing at pasters 5 through 6, he engages the five scoring spaces with a 15-round belt. The maximum score possible is 15 points. When firing at pasters 7 through 8, the automatic rifleman engages the eight scoring spaces with 24 rounds with a maximum score of 24 points.

The total possible score is 51 points. A minimum of 35 points is required to qualify on the 10-meter course of fire.

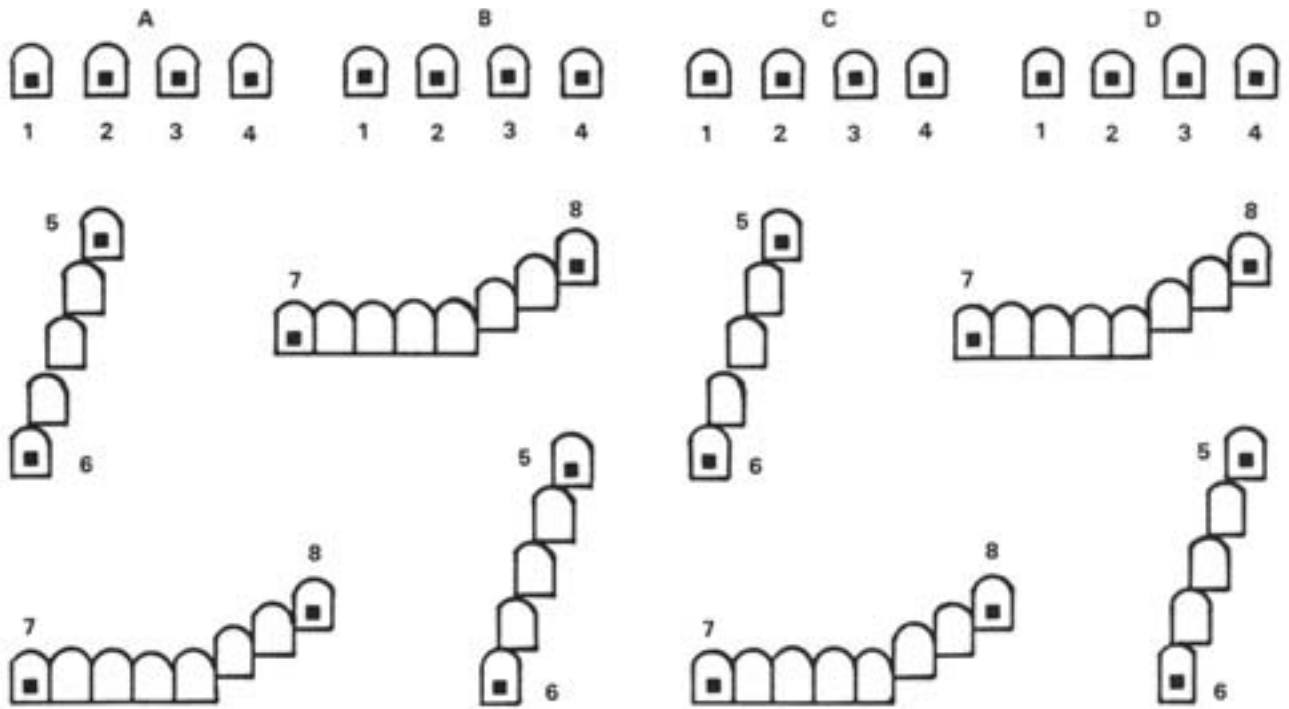
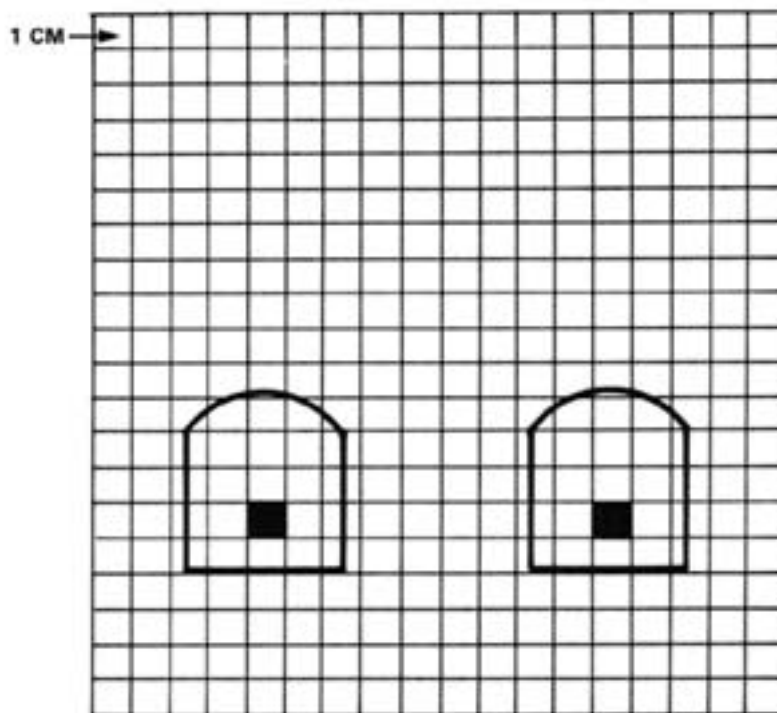

Figure 2-55. Basic Machine Gun Target.



2 CLICKS WINDAGE = 1 CM      TURN WINDAGE KNOB TOWARD THE MUZZLE TO  
 MOVE THE STRIKE OF THE ROUND TO THE RIGHT.

2 CLICKS ELEVATION = 1 CM      TURN PEEP SIGHT COUNTERCLOCKWISE TO MOVE  
 THE STRIKE UP: CLOCKWISE TO MOVE IT DOWN.

Figure 2-56. Grid Square Overlay.

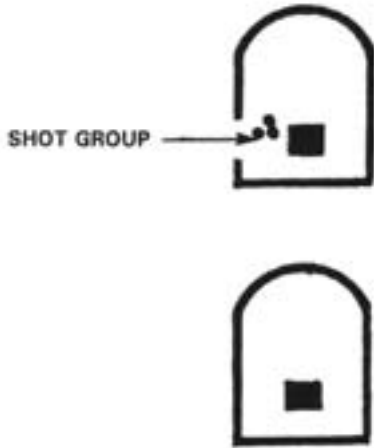

Figure 2-57. Shot Group on Basic Machine Gun Target.

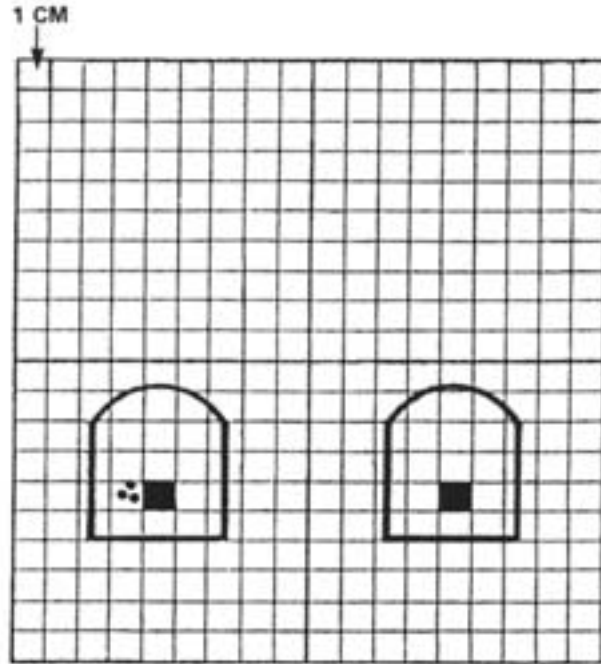
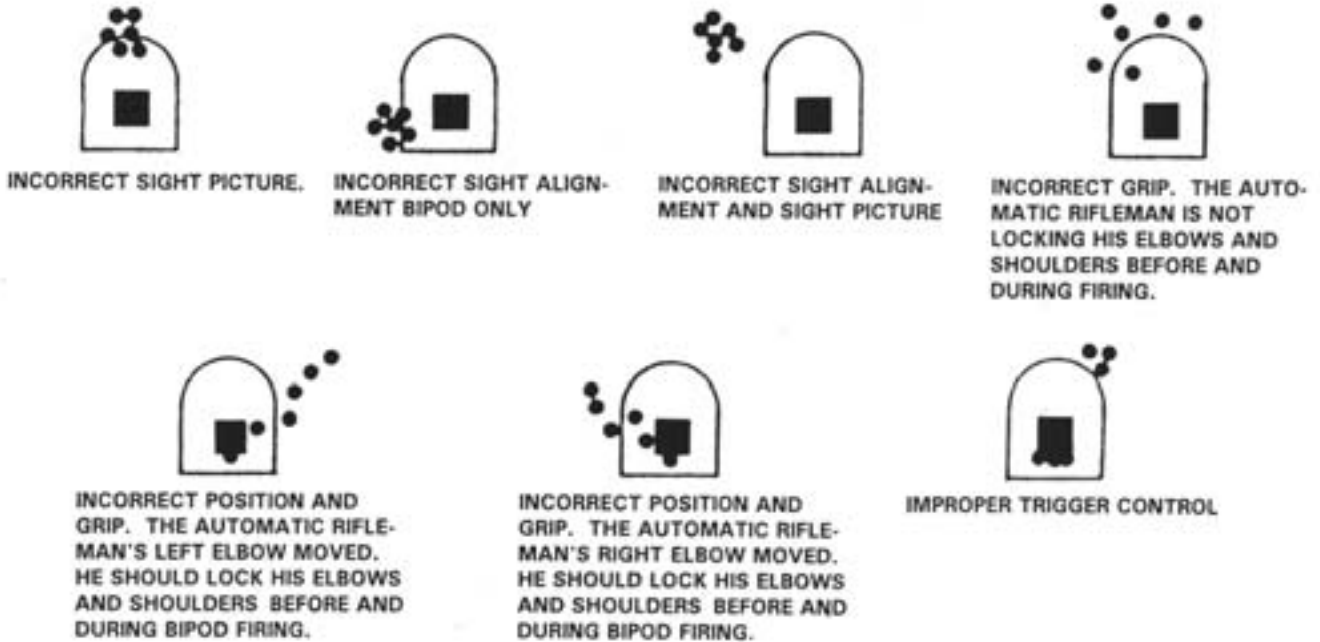

Figure 2-58. Overlay Placed Over Pasters.



COMMON ERRORS ENCOUNTERED ON THE BASIC 10-METER M249 RANGE

Figure 2-59. Common Errors of Marksmanship.



**b. Conduct of Fire.** The 10-meter firing trains automatic riflemen to apply the fundamentals of automatic rifle marksmanship in live-fire exercises. It familiarizes the Marine with the weapon's characteristics, noise, and recoil. It instills in the automatic rifleman confidence in his weapon. Each automatic rifleman learns to zero his SAW, conducts controlled-burst fire at point targets, and uses traverse and search techniques of fire at area targets. The 10-meter firing is conducted on a 10-meter range or a multipurpose range using the basic machine gun target. These exercises are fired with the bipod from the prone position. The 10-meter firing exercises are for practice as well as part of record qualification. All 10-meter firing exercises are recorded and scored to provide the automatic rifleman an assessment on his performance. The 10-meter firing is conducted in accordance with Firing Table I (figure 2-60). The automatic riflemen are instructed on the objectives and fundamentals of firing from the bipod-supported prone position, on fire

commands used on the basic range, on the basic machine gun marksmanship target, and on analyzing and scoring the target. The unit is organized in firing orders based on range constraints. The seven tasks are fired in the following manner.

### NOTE

Throughout all firing exercises, the automatic rifleman performs the appropriate tasks during each element of the fire command. The number of rounds fired is used instead of the rate for METHOD OF FIRE. This is for control. (Omitting the rate specifies RAPID fire which is not desirable for the tasks.)

#### (1) Task 1, zeroing

- Prepare the rear sight for zeroing and check the front sight.
- Assume a good position.

Basic (10-Meter) Firing Prone Position and Fighting Position, Bipod-Supported Practice and Qualification					
TASK	TIME	RDS	TYPE	TARGET	TYPE FIRE
1	No limit	12	Ball	Pasters 1 and 2	3 single-round shot group
2	No limit	6	Ball	Pasters 3 and 4	3-round burst each paster
3X	No limit	15	Ball	Pasters 5 through 6	3-round burst each paster traverse and search
4	No limit	24	Ball	Pasters 7 through 8	3-round burst each paster traverse and search
*5	20 sec	12	Ball	Pasters 1 through 4	3-round burst each paster traverse and search
*6X	40 sec	24	Ball	Pasters 7 through 8	3-round burst each paster traverse and search
*7	40 sec	15	Ball	Pasters 5 through 6	3-round burst each paster traverse and search

**NOTE:**  
 X Indicates tasks fired with protective mask and gloves as a minimum.  
 \* Indicates qualification tasks.

Figure 2-60. Firing Table I.

- Prepare a single round.
- When the following fire command is given, repeat each element of the fire command as it is given.

**AUTOMATIC RIFLEMAN** (Load and move safety to **FIRE**)

**FRONT** (Focus on target or target area)

**PASTER ONE** (Locate target)

**SEVEN HUNDRED** (Adjust sights and acquire sight picture)

**FIXED, ONE ROUND** (Method of fire)

**COMMENCE FIRING** (Fire on command but when ready)

- Load one round, obtain the proper sight picture, and give an UP to safety personnel.

The command **COMMENCE FIRING** is given.

- When ready, engage paster 1 with 3 single shots.
- Move downrange to observe, mark, and triangulate the shot group. Sight adjustments using the rear peep sight and windage knob are made at this time if the shot group is tight enough. If not, fire another 3 rounds to ensure the fundamentals are mastered before adjusting the sights.
- Repeat the steps above, but fire at paster 2.

### NOTE

If the automatic rifleman zeros his weapon using 9 rounds, he uses the remaining 3 to confirm his zero. If he is unable to zero with 12 rounds, he is removed from the firing line for remedial training.

#### (2) Task 2, controlled-burst firing

- Prepare a 6-round belt.
- When the following fire command is given, repeat each element as it is given.

**AUTOMATIC RIFLEMAN**

**FRONT**

**PASTER THREE**

**SEVEN HUNDRED**

**FIXED, THREE-ROUND BURSTS  
AT MY COMMAND**

- Acquire the proper sight picture and give an UP to safety personnel.

The command to **FIRE** is given.

- Fire the first burst of 3 rounds at paster 3.
- Repeat the steps above, but fire at paster 4.

#### (3) Task 3, NBC traverse and search fire

- Prepare a 15-round belt.

The order to mask is given by stating **GAS**. Once the shooters are masked, the fire command is given.

- When the following fire command is given, repeat each element as it is given:

**AUTOMATIC RIFLEMAN**

**FRONT**

**PASTERS FIVE THROUGH SIX**

**SEVEN HUNDRED**

**TRAVERSE AND SEARCH, THREE-ROUND  
BURSTS**

**AT MY COMMAND**

- Acquire the proper sight picture and give an UP to safety personnel.

The command to **FIRE** is given.

- Using the traverse and search technique, engage pasters 5 through 6, firing a 3-round burst for each paster.

Once complete, the shooters are given the order **ALL CLEAR**.

- Restore mask to the carrier and move down range to observe and analyze the targets.

#### (4) Task 4, traverse and search fire

- Prepare a 24-round belt.
- When the following fire command is given, repeat each element as it is given.

**AUTOMATIC RIFLEMAN  
FRONT  
PASTERS SEVEN THROUGH EIGHT  
SEVEN HUNDRED  
TRAVERSE AND SEARCH, THREE-ROUND  
BURSTS  
AT MY COMMAND**

- Acquire the proper sight picture and give an UP to safety personnel.
- Engages pasters 7 through 8, firing a 3-round burst at each paster, using the traverse and search technique.
- Move downrange to observe and analyze the targets.

**(5) Task 5, traverse and search fire**

- Prepare a 12-round belt.
- When the following fire command is given, repeat each element as it is given.

**AUTOMATIC RIFLEMAN  
FRONT  
PASTERS ONE THROUGH FOUR  
SEVEN HUNDRED  
FIXED, THREE-ROUND BURSTS  
AT MY COMMAND**

- Acquires the proper sight picture and give an UP to safety personnel.

The command to **FIRE** is given.

- Engage pasters 1 through 4 in 20 seconds, firing a three-round burst at each paster.
- Move downrange to observe and analyze the targets.

**(6) Task 6, NBC traverse and search fire**

- Prepare a 24-round belt.

The order to mask is given by stating **GAS**. Once the shooters are masked the fire command is given.

- When the following fire command is given, repeat each element of as it is given.

**AUTOMATIC RIFLEMAN  
FRONT  
PASTERS SEVEN THROUGH EIGHT  
SEVEN HUNDRED  
TRAVERSE AND SEARCH, THREE-ROUND  
BURSTS  
AT MY COMMAND**

- Acquire the proper sight picture and give an UP to safety personnel.

The command to **FIRE** is given.

- Using the traverse and search technique, engage pasters 7 through 8 in 40 seconds, firing a 3-round burst at each paster.

Once complete, the shooters are given the order **ALL CLEAR**.

- Restore the mask to the carrier and move downrange to observe and analyze the targets.

**(7) Task 7, traverse and search fire**

- Prepare a 15-round belt.
- When the following fire command is given, repeat each element as it is given.

**AUTOMATIC RIFLEMAN  
FRONT  
PASTERS FIVE THROUGH SIX  
SEVEN HUNDRED  
TRAVERSE AND SEARCH, THREE-ROUND  
BURSTS  
AT MY COMMAND**

- Acquire the proper sight picture and give an UP to safety personnel.
- Using the traverse and search technique, the engage pasters 5 through 6 in 40 seconds, firing a 3-round burst at each paster.
- Move downrange to observe, analyze and score the target.

**c. 10-Meter Qualification Firing.** Qualification consists of firing tasks 2 through 4 of Firing Table I for practice, and tasks 5 through 7 of Firing Table I for record (Firing Table I, page 2-53). Before firing, all automatic riflemen must be familiar with the tasks, the time allowed, the ammunition allowances, the procedures to follow in the event of a stoppage, and the penalties imposed.

**(1) Time and ammunition.** Each automatic rifleman completes zeroing before record firing. Individual fire commands are given for each task. Task 5 is fired in 20 seconds; task 6 in 40 seconds; and task 7 in 40 seconds.

**(2) Stoppages.** If a stoppage occurs, the automatic rifleman must apply immediate action. If the stoppage is reduced, he continues to fire the course.

- If a stoppage occurs that cannot be reduced by immediate action, raise hand and await assistance.
- Once the stoppage is reduced, complete firing beginning with the next task.
- If a stoppage is caused by an error, additional time is not permitted. The score will be the one earned before the stoppage occurred.
- If it is necessary to replace the SAW, zero the new weapon and refire the exercise.

Automatic riflemen who cannot fire a task or cannot complete firing in the time allowed (because of malfunctions) can finish the exercise in an “alibi run” after all other automatic riflemen complete firing. They fire only those tasks they failed to engage because of the malfunction.

**(3) Scoring.** Automatic riflemen do not score their own targets when firing for qualification. During qualification firing, at least 35 points must be achieved on Firing Table I, page 2-53.

## 2905. Transition Firing

**a. Targets and Scoring.** Transition firing provides the automatic rifleman the experience necessary to

progress from the 10-meter firing to field firing at various types of targets at longer distances. The automatic rifleman experiences and learns the characteristics of fire, field zeroing, and range determination. He uses the adjusted aiming point method of fire adjustment. Transition firing should take place on available field firing ranges. These firing exercises are conducted from the bipod in the prone position, or from the bipod in a fighting position. Transition firing is conducted and scored for practice and qualification. Firing Table II is used (see figure 2-61). It consists of eight tasks. Targets should be placed at various ranges that an automatic rifleman might engage. Two “E” type target configurations should be used; either the single or double (see figure 2-62). All targets should be clearly visible from the firing positions. Electrical targets that provide feed back to the shooter and range personnel are desirable.

**(1) Stoppages.** The same procedures used in Firing Table I (page 2-53) qualification firing apply to transition firing.

**(2) Scoring.** Five points are given for each target hit, whether hit with the first or second burst. The total possible points is 55. The automatic rifleman must hit at least 7 (35 points) targets out of 11 exposures to qualify. DA Form 7304-R is used to record scores.

**b. Conduct of Fire.** The unit is organized in firing orders based on range constraints. One coach per automatic rifleman is desirable. The coach assists the automatic rifleman, as needed, in all aspects of the transition course except during qualification. The eight tasks are fired in the following manner:

**(1) Task 1, field zeroing the 300-meter, single E-type silhouette**

- Prepares the rear sight for field zeroing and check the front sight post. Sets the range to the zero target on the elevation knob. The preferred range is 300 meters.
- Assume a good position.
- On command, prepare a 12-round belt.

Transition Firing Prone Position and Fighting Position, Bipod-Supported Practice and Qualification						
TASK	TIME	RDS	TYPE	TARGET	RANGE	TYPE FIRE
1	No limit	12	X 4:1	Single E	300	Fixed, 3-round burst (field zero)
*2	5 sec	6	X 4:1	Single E	200	Fixed, 3-round burst
*3	10 sec	6	X 4:1	Double E	400	Fixed, 3-round burst
*4	10 sec	6	X 4:1	Single E	100	Fixed, 3-round burst
*5	15 sec	6	X 4:1	Single E	300	Fixed, 3-round burst
*6	20 sec	12	X 4:1	Single E	100, 300	Fixed, 3-round burst
*7	20 sec	12	X 4:1	Single E	200	Fixed, 3-round burst
				Double E	400	
*8	25 sec	18	X 4:1	Single E	100	Fixed, 3-round burst
				Single E	200	Fixed, 3-round burst
				Double E	400	Fixed, 3-round burst

**NOTE:** Unit commander determines the firing position. Tasks 4, 5, and 6 are fired with protective masks and gloves at a minimum.

X Indicates ball and tracer 4:1 mix.  
\* Indicates qualification tasks.

Figure 2-61. Firing Table II.



Figure 2-62. Single E-Type and Double E-Type Silhouette Targets.

When the following firing command is given, repeat each element as it is given:

**AUTOMATIC RIFLEMAN  
TROOPS IN THE OPENFRONT  
THREE HUNDRED  
FIXED, THREE ROUND BURSTS  
COMMENCE FIRING**

- Load one 12-round belt of ammunition, obtain the proper sight picture, and announce “up” to the coach.

The coach relays the **READY** signal to safety personnel controlling the range.

The **COMMENCE FIRING** command is given.

- Fire a 3-round burst at the target when ready.
- Observe the beaten zone. If the rounds miss the target, make adjustments for windage and elevation.
- After adjustments have been made, repeat steps 8 through 9 with the remaining rounds until the rounds are impacting on the target. Record the zero.

**(2) Task 2, 200-meter, single E-type silhouette.**

- On command, load one 66-round belt.
- When the following fire command is given, repeat each element as it is given. It is only given once for tasks 2 through 8.

**AUTOMATIC RIFLEMAN  
FRONT  
TROOPS IN THE OPEN  
ONE HUNDRED TO FOUR HUNDRED  
METERS  
FIXED, THREE ROUND BURSTS  
AT MY COMMAND**

- Announce “up” to the coach.

The coach gives the READY signal to the person controlling the line.

The command to **FIRE** is given.

- Scan the sector.

A 200 meter single E-type target is exposed for 5 seconds.

- Determine the range, place the proper setting on the rear sight, assume the proper position, obtain the correct sight alignment and sight picture, and fire a 3-round burst
- If the target is not hit, fire another 3-round burst using the adjusted aiming point method of fire adjustment.

**(3) Task 3, 400-meter, double E-type silhouette**

- Continue to scan the sector.

A 400 meter, double E-type target is exposed for 10 seconds.

- Determine the range, place the proper setting on the rear sight, assume the proper position, obtain the correct sight alignment and sight picture, and fire a 3-round burst.

- If the target is not hit, fire another 3-round burst using the adjusted aiming point method of fire adjustment.

**(4) Task 4, 100-meter, single E-type silhouette**

Range personnel give the order to mask by sounding off, **GAS**.

- Don field protective mask and gloves.
- Continue to scan the sector.

A 100 meter, single E-type target is exposed for 10 seconds.

- Determine the range, place the proper setting on the rear sight, assume the proper position, obtain the correct sight alignment and sight picture, and fire a 3-round burst.
- If the target is not hit, fire another 3-round burst using the adjusted aiming point method of fire adjustment.

**(5) Task 5, 300-meter, single E-type silhouette**

- Continue to scan the sector, while in field protective mask and gloves.

A 300 meter, single E-type target is exposed for 15 seconds.

- Determine the range, place the proper setting on the rear sight, assume the proper position, obtain the correct sight alignment and sight picture, and fire a 3-round burst.
- If the target is not hit, fire another 3-round burst using the adjusted aiming point method of fire adjustment.

**(6) Task 6, 100-meter and 300-meter, single E-type silhouettes**

- Continue to scan the sector, while in field protective mask and gloves.

A 100 meter and 300 meter, single E-type target are exposed for 20 seconds.

- Determine the range, place the proper setting on the rear sight, assume the proper position, obtain the correct sight alignment and sight picture, and fire a 3-round burst at each
- If the target is not hit, fire another 3-round burst using the adjusted aiming point method of fire adjustment at each target.

Range personnel give the **ALL CLEAR** order.

- Return field protective mask to its carrier and remove gloves.

**(7) Task 7, 200-meter single E-type and 400-meter double E-type silhouettes**

- Continue to scan the sector.

The 200 meter single E-type and the 400 meter double E-type targets are exposed for 20 seconds.

- Determine the range, place the proper setting on the rear sight, assume the proper position, obtain correct sight alignment and sight picture, and fire a 3 round burst at each target.
- If the target is not hit, fire another 3-round burst using the adjusted aiming point method of fire adjustment.

**(8) Task 8, 100- and 200-meter, single, E-type and 400-meter double E-type silhouettes**

- Continue to scan the sector.

The 100 meter and 200 meter single E-type and 400 meter double E-type targets are exposed for 25 seconds.

- Determine the range, place the proper setting on the rear sight, assume the proper position, obtain correct sight alignment and sight picture, and fire a 3-round burst at each target,
- If the target is not hit, fire another 3-round burst using the adjusted aiming point method of fire adjustment at each target.

## Chapter 3

### MACHINE GUN, 7.62MM, M240G

*“Warned by the outpost, Puller’s men waited, straining to see through a dark night and a driving rain. Suddenly, the Japanese charged out of the jungle, attacking in Puller’s area near the ridge and the flat ground to the east. The Marines replied with everything they had, calling in artillery, firing mortars, relying heavily on crossing fields of machine gun fire to cut down the enemy infantrymen...lines held and the Japanese were cut down in droves...”*

—Actions of the 1st Battalion, 7th Marines, commanded by LtCol Lewis B. “Chesty” Puller, in defense of Henderson Airfield, 24 and 25 October 1942.<sup>7</sup>



**World War II, Tarawa  
A Marine Machine Gun Team in Action in Support of the Advance Inland**



## Table of Contents

### Section 1. Introduction

- 3101. General Data
- 3102. Sights
- 3103. Safety
- 3104. Roles of the M240G

### Section 2. Disassembly, Assembly, and Nomenclature

- 3201. General Disassembly
- 3202. General Assembly
- 3203. Detailed Disassembly and Assembly

### Section 3. Functioning

- 3301. Feeding
- 3302. Chambering
- 3303. Locking
- 3304. Firing
- 3305. Unlocking
- 3306. Extracting
- 3307. Ejecting
- 3308. Cocking

### Section 4. Malfunctions and Stoppages

- 3401. Malfunctions
- 3402. Stoppages
- 3403. Immediate Action
- 3404. Remedial Action

### Section 5. Mounts and Accessories

- 3501. Bipod
- 3502. Tripod Mount, M122
- 3503. Flex-mount
- 3504. Gun Bag
- 3505. Night Vision Equipment

### Section 6. Maintenance

- 3601. Cleaning Materials and Lubricants
- 3602. Care and Cleaning Before, During, and After Firing

- 3603. Normal Maintenance Procedures
- 3604. Special Maintenance Procedures
- 3605. Inspection

### Section 7. Ammunition

- 3701. Classification
- 3702. Identification
- 3703. Ballistic Data
- 3704. Ammunition Packaging
- 3705. Storage
- 3706. Care, Handling, and Preservation of Ammunition

### Section 8. Operation and Firing

- 3801. Loading
- 3802. Unloading and Clearing the Gun
- 3803. Operation of the Safety
- 3804. Firing the M240G
- 3805. Change Barrel Procedures

### Section 9. Gun Drill

- 3901. Crew Equipment
- 3902. Form for Gun Drill
- 3903. Examination of Equipment Before Firing
- 3904. Placing the Gun into Action
- 3905. Barrel Change
- 3906. Taking the Gun Out of Action
- 3907. Rotation

### Section 10. Qualification Firing

- 31001. Fundamentals of Marksmanship
- 31002. Position and Grip
- 31003. Sight Setting and Battlesight Zero Procedures
- 31004. 12.7 Meter (500 Inch) Firing

### Section 11. Firing With Blank Ammunition

- 31101. Safety
- 31102. Inspection
- 31103. Assembly
- 31104. Operation

## List of Figures

3-1	Left Side, Bipod Mounted	3-40	Flex-mount
3-2	Right Side, Bipod Mounted	3-41	T&E Mechanism
3-3	Rear Sight Assembly	3-42	Attaching the Flex-mount to the Tripod
3-4	Cutaway View	3-43	Attaching the Gun to the Flex-mount
3-5	Five Main Groups	3-44	The Tripod-Mounted Gun
3-6	Removing the Buttstock Group	3-45	Gun Bag
3-7	Removing the Drive Spring Rod Assembly.	3-46	Spare Barrel Bag
3-8	Removing the Bolt and Operating Assembly	3-47	AN/PVS-7B, NVG
3-9	Removing the Trigger Housing Group	3-48	AN/PVS-4, ISWS
3-10	Removing the Barrel Group	3-49	AN/PVS-5, NVG
3-11	Replacing the Trigger Housing Group	3-50	AN/PAQ-4B, IAL
3-12	Replacing the Bolt and Operating Rod Assembly	3-51	Belt of Disintegrating Link Ammunition
3-13	Separating the Bolt and Operating Rod	3-52	Ammunition for the M240G
3-14	Bolt Face	3-53	Ballistic Data for 7.62mm Ammunition
3-15	Operating Group, Detailed Disassembly	3-54	Issue 100-Round Bandolier
3-16	Assembling the Bolt and Operating Rod	3-55	Firing From the Open Bolt Position
3-17	Disassembly of the Gas System	3-56	Opening the Cover
3-18	Barrel Group, Detailed Disassembly	3-57	Feed Tray
3-19	Removing the Cover and Feed Tray	3-58	Loading, Cover Open
3-20	Receiver Group, Detailed Disassembly	3-59	Loading, Cover Closed
3-21	Aligning the Feed Tray Guides	3-60	Inspecting the Chamber
3-22	Trigger Pull Releasing the Operating Group	3-61	Operation of the Safety
3-23	Feeding	3-62	Bipod Position
3-24	Cover Parts	3-63	Changing Barrels
3-25	Chambering	3-64	Team Formed on Line With Equipment
3-26	Locking	3-65	Team in Prone Position
3-27	Firing	3-66	Team Leader Moving to Position
3-28	Action of the Gas	3-67	Extending the Tripod
3-29	Unlocking	3-68	Team Leader Mounting the Flex-mount
3-30	Extraction and Ejection	3-69	Gunner Mounting Gun
3-31	Cocking	3-70	Gun Team Ready to Fire
3-32	Gas Regulator Settings	3-71	Basic Machine Gun Qualification Target
3-33	Immediate Action	3-72	Combination Front Sight Adjusting Tool
3-34	Chamber Condition During Immediate Action	3-73	Correct Sight Alignment
3-35	Bipod Assembly	3-74	Correct Sight Picture
3-36	Lowering the Bipod	3-75	Unlocking the Front Sight Retaining Strap
3-37	M122 Tripod and Flex-mount	3-76	Blank Firing Adapter Assembly
3-38	Tripod	3-77	Installing the Blank Firing Adapter
3-39	Traversing Bar		

## Chapter 3

# Machine Gun, 7.62mm, M240G

---

### Section 1 Introduction

---

The M240G machine gun (see figures 3-1 and 3-2) is an air-cooled, belt-fed, gas-operated automatic weapon. It is able to provide a heavy, controlled volume of accurate, long-range fire that is beyond the capabilities of individual small arms. The weapon fires from the open-bolt position and is fed by a disintegrating belt of metal links. The gas from firing one round provides the energy for firing the next. Thus,

the gun functions automatically as long as it is supplied with ammunition and the trigger is held to the rear. It can be fired utilizing either the attached bipod mount or by mounting the M240G on the tripod. The tripod provides the most stable base for the weapon, enabling the gunner to maximize its range capabilities and deliver a high degree of accurate fire on target. The traversing and elevating (T&E) mechanism permits controlled manipulation in both direction and elevation and makes it possible to engage predetermined targets during darkness or periods of reduced visibility. Each member of the gun crew should have access



**Figure 3-1. Left Side, Bipod Mounted.**



**Figure 3-2. Right Side, Bipod Mounted.**

to TM 08670A-10/1A and TM 08670B-23&P/2 SUPPLEMENT 01 which are detailed, pocket-sized reference manuals for operators of the M240G, M240, M240E1, and M240C.

### 3101. General Data

#### Weights/Measurements

Total system weight (gun and tripod complete) . . . . .	45.6 pounds
Weight of machine gun . . . . .	25.6 pounds
Weight of barrel . . . . .	6.6 pounds
Weight of spare barrel case, complete with spare barrel and all SL-3 components . . . . .	12.90 pounds
Weight of tripod, complete with flex-mount including T&E mechanism . . . . .	20 pounds
Length of machine gun . . . . .	49 inches
Height of machine gun on tripod . . . . .	17 inches
Muzzle velocity . . . . .	2,800 feet per second
Rifling . . . . .	Four grooves with a uniform right hand twist, one turn in 12 inches

#### Ranges

Maximum . . . . .	3,725 meters
Maximum effective . . . . .	1,800 meters
Grazing fire . . . . .	600 meters

#### Ammunition

Caliber . . . . .	7.62 millimeter
Types in use . . . . .	Ball, tracer, blank, dummy, and armor-piercing
Basic allowance per gun . . . . .	400 rounds
Weight of a 100 round assault pack (2 per can) . . . . .	7 pounds

#### Rates of fire

Sustained . . . . .	100 rounds per minute fired in 6 to 8 round bursts 4 to 5 seconds between bursts barrel change every 10 minutes
Rapid . . . . .	200 rounds per minute fired in 10 to 12 round bursts 2 to 3 seconds between bursts barrel change every 2 minutes

#### Cyclic

650 to 950 rounds per minute  
continuous burst barrel  
change every minute  
(depending on gas setting)

#### Manipulation (tripod mount):

Limits of elevation with T&E mechanism . . . . .	247 mils
Free gun . . . . .	996 mils
Limits of depression with T&E mechanism . . . . .	200 mils
Free gun . . . . .	996 mils
Limits of traverse (tripod mount):	
Using traversing bar . . . . .	875 mils (425 left, 450 right)
On the traversing handwheel . . . . .	100 mils
Free gun . . . . .	6400 mils

### 3102. Sights

The M240G has a front sight post which can be adjusted using the tool, combination, front sight adjusting. This is normally only done to zero the weapon (see paragraph 31003). The rear sight consists of a peep sight aperture on an adjustable sight leaf slide. This sight leaf slide rides on a range plate with a graduated scale which is attached to the weapon by a hinged mount. See figure 3-3. The gun is normally carried with the sight in its horizontal position. The gun can be used with the sight in this position to engage close in targets (800 meters or below) from the bipod or tripod. It can also be raised to a vertical position for sighting on targets at greater ranges (more than 800 meters). These settings are normally used only when the gun is employed on the tripod, which provides the stable platform necessary to accurately engage targets at these greater ranges. The range plate scale, located on both sides of the range plate, is marked at 100 meter intervals from 200 meters to the maximum effective range of 1,800 meters. Range changes can be made by moving the rear sight slide horizontally along its graduated steps for range settings from 200 meters to 800 meters, or range changes can be made by raising the sight to its upright position and moving the rear sight slide vertically for range settings from 800 meters to 1,800 meters.

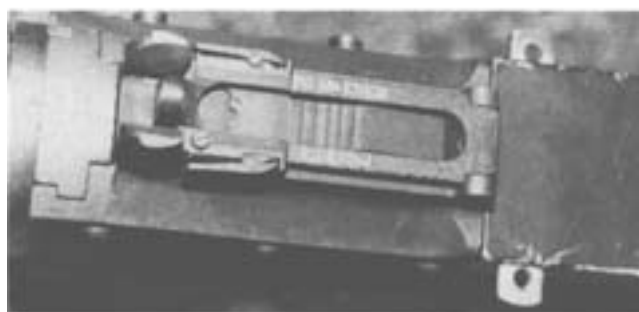
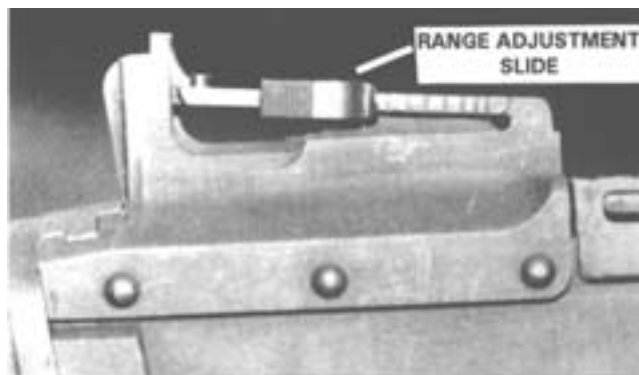

Figure 3-3. Rear Sight Assembly.

### 3103. Safety

The M240G safety is located on the trigger housing assembly. It is set on SAFE (S) by pushing it to the right and to FIRE (F) by pushing it to the left. In the F position a red ring is visible around the safety. The weapon cannot be set on S unless it is cocked (bolt to the rear). To test the safety, first make sure the weapon is clear, then pull the bolt to the rear using the cocking handle. Place the weapon on S, and while holding the cocking handle to the rear, pull the trigger. The bolt should not move forward. If it moves, the safety is defective and should be inspected by ordnance personnel. Finally, place the weapon on F, and while holding the cocking handle to the rear, pull the trigger. The bolt should move forward. Slowly release rearward tension on the cocking handle and allow the bolt to move all the way forward. (This is known as riding the bolt home. This is done to minimize the wear and tear on parts that would result from repeatedly allowing the bolt to spring forward completely during non-firing function testing.)

### 3104. Roles of the M240G

The M240G is a versatile weapon that can support both offensive and defensive operations. It can provide a heavy volume of close, accurate, and continuous fire support to suppress and destroy enemy personnel in support of an attack. That same heavy volume of fire, when employed as final protective fires, forms an integral part of a unit's defensive fire plan and can effectively break up and stop an enemy assault. The M240G can be found in combat, combat support, and combat service support units.

---

## Section 2

### Disassembly, Assembly, and Nomenclature

---

The M240G is designed for easy disassembly and assembly; the use of force is not necessary. No special tools are required. As the weapon is disassembled, place the parts (in the order in which they are

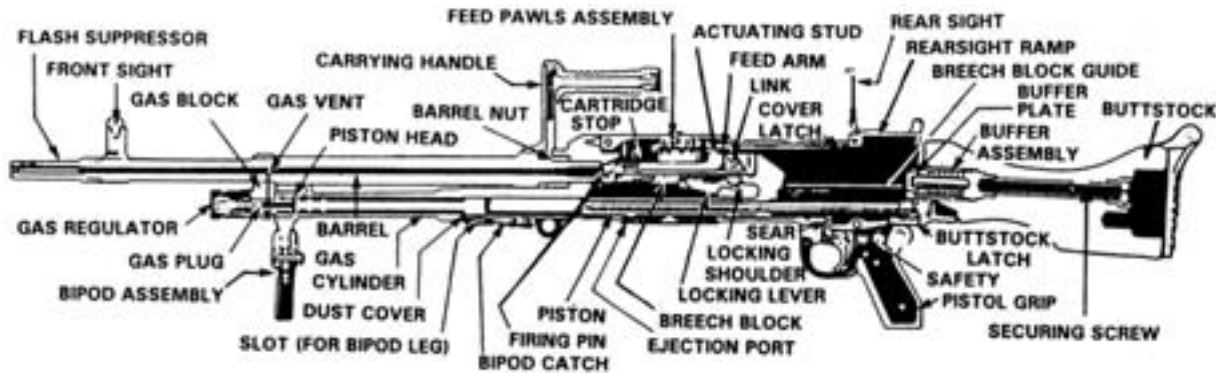

Figure 3-4. Cutaway View.

removed) on a clean, flat surface. This reduces the possibility of losing a part and aids in assembly, as all parts are replaced in reverse order. To prevent unnecessary wear, disassembly should be kept to a minimum, consistent with maintenance and training requirements. See figure 3-4.

Disassembly and assembly are divided into two categories—general and detailed. General disassembly involves separating the weapon into main groups, which is also known as field stripping. This is a practice that stems from past experience in combat situations. It allows the operator to quickly break the weapon down into a set of major components that can be hastily cleaned to keep the weapon ready for action. Detailed disassembly, for the operator, involves the removal of some of the component parts and assemblies from the main groups. When the situation and conditions permit, the operator can then take the time to more fully disassemble and thoroughly clean the weapon. Complete general and detailed disassembly is normally the expected routine in garrison after the completion of firing and/or field training, but it can also be conducted in a field environment when necessary, to ensure the proper functioning and maintenance of the weapon. Disassembly of the weapon beyond that described in this publication is not authorized, except by qualified ordnance personnel.

### 3201. General Disassembly

General disassembly (field stripping) is the separation of the M240G into five main groups. They are

the buttstock group, operating group, trigger housing group, barrel group, and receiver group. See figure 3-5.

**a. Clearing Procedures.** Before the weapon is disassembled, it must be cleared:

- Grasp the cocking handle and pull the bolt to the rear.
- Place the gun on S.
- Open the cover, raise the feed tray, and inspect the chamber both visually and physically.
- Place the gun on F.
- Grasp the cocking handle, squeeze the trigger, and slowly allow the bolt to return to its forward position.

**b. Removing the Buttstock Group**

- Bring the bolt forward and raise the cover.
- Depress the buttstock latch located on the underside of the buttstock where it joins the receiver. See figure 3-6, step 1.
- Slide the buttstock upward and remove it from the receiver. See figure 3-6, step 2.

**c. Removing the Operating Group.** The operating group consists of the operating rod, bolt, and drive spring rod assembly.

- To remove the drive spring rod assembly, first push in against its base, then lift up and outward so that it clears its retaining studs inside the receiver. Then remove it from the rear of the receiver. See figure 3-7, steps 1 and 2 on page 3-10.

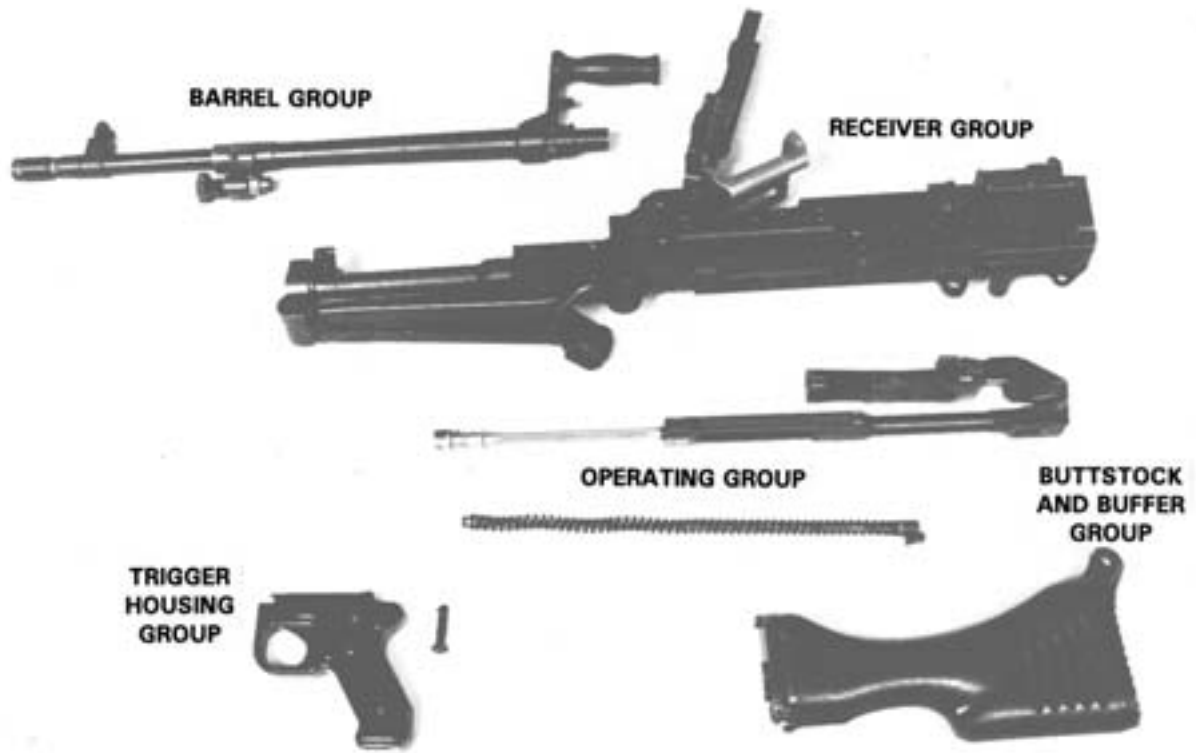

Figure 3-5. Five Main Groups.



Step 1. Depressing the Buttstock Latch.



Step 2. Sliding the Buttstock Off the Receiver.

Figure 3-6. Removing the Buttstock Group.

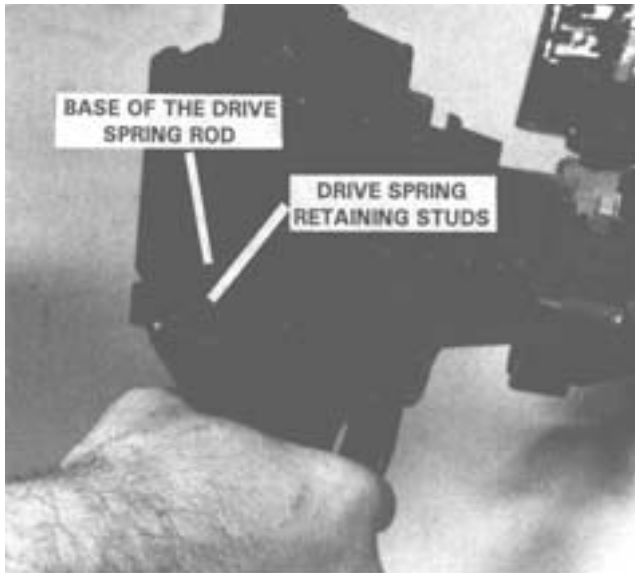

Step 1. Pushing In and Up on the Base of the Driving Spring Guide.



Step 2. Pulling the Driving Spring Guide From the Receiver.

**Figure 3-7. Removing the Drive Spring Rod Assembly.**

- Pull the cocking handle to the rear to start the rearward movement of the bolt and operating assembly

inside the receiver. With the index finger, reach inside the top of the receiver and push rearward on the face of the bolt until the bolt and operating rod assembly are exposed at the rear of the receiver. See figure 3-8, steps 1 and 2.

- Grasp the bolt and operating rod assembly and remove them from the rear of the receiver. See figure 3-8, step 3.

**d. Removing the Trigger Housing Group.** The trigger housing group consists of the trigger housing assembly and the trigger housing assembly spring pin.

- Remove the trigger housing assembly spring pin. See figure 3-9, step 1.
- Rotate the rear of the trigger housing assembly down, disengage the holding notch at the front of the assembly from its recess on the bottom of the receiver, and remove the assembly from the receiver. See figure 3-9, step 2.

**e. Removing the Barrel Group.** The barrel group consists of the barrel with attached gas system, adjustable front sight assembly, flash suppressor, and barrel changing handle.

- Depress the barrel-locking latch located on the left side of the receiver where the barrel joins the receiver. See figure 3-10, step 1.
- Grasp the barrel-changing handle and rotate it to an upright position. Then push forward and pull up, separating the barrel from the receiver. See figure 3-10, step 2.

**f. Receiver Group.** The receiver group consists of the receiver with rear sight, cover, feedtray, and bipod assembly. General disassembly is completed after the removal of the other main groups from the receiver group.

## 3202. General Assembly

General assembly involves replacing the buttstock, operating, trigger housing, and barrel groups on the receiver group. It is done in reverse order of disassembly.





Step 1. Pulling the Cocking Handle to the Rear.



Step 2. Pushing Against the Face of the Bolt.



Step 3. Grasping the Operating Group and Removing It From the Receiver.

Figure 3-8. Removing the Bolt and Operating Assembly.



Step 1. Remove the Trigger Housing Assembly Spring Pin.



Step 2. Disengage the Holding Notch from the Receiver.

Figure 3-9. Removing the Trigger Housing Group.



Step 1. Depressing the Barrel Locking Latch.



Step 2. Rotating Barrel Changing Handle Upright and Pulling Forward to Remove Barrel from Receiver.

**Figure 3-10. Removing the Barrel Group.**

**a. Replacing the Barrel Group**

- Insert the barrel socket into the receiver forward of the cover and align the rear of the gas plug with the gas cylinder tube in front of the bipod.
- Depress the barrel-locking latch and fully seat the barrel in the receiver. Release the barrel-locking

latch and rotate the barrel changing handle down to its lowered position to lock the barrel in place.

**b. Replacing the Trigger Housing Group**

- Insert the holding notch on the front of the trigger housing into its recess on the bottom of the receiver.

Rotate the rear of the trigger housing upward and align the hole of the trigger housing with the mounting bracket on the receiver. See figure 3-11.

- Insert the trigger housing assembly spring pin into the hole, securing the assembly to the receiver. It can be inserted from the left or right.

### c. Replacing the Operating Group

- Insert the bolt and operating rod into the receiver, aligning the slots along their sides with the rails inside the receiver. Extend the bolt to the unlocked (forward) position and then push the entire bolt and operating rod assembly inside the receiver. See figure 3-12.
- Pull the trigger so that the assembly can slide all the way into the receiver.
- Insert the drive spring rod assembly into the receiver, sliding it all the way forward against the recess in the rear of the operating rod. Then lower it so that its base seats against the retaining studs inside the receiver that holds it into place.



Figure 3-11. Replacing the Trigger Housing Group.



Figure 3-12. Replacing the Bolt and Operating Rod Assembly.

**d. Replacing the Buttstock Group**

- Align the recessed grooves at the front of the buttstock with the vertical rails at the rear of the receiver.
- Slide the buttstock downward until it locks in place on the receiver.

**e. Conducting a Function Check.** To check for correct assembly—

- Pull the cocking handle to the rear and return it to its forward position and close the cover.
- Pull the cocking handle to the rear.

- Pull the trigger, with the safety on F and ride the bolt home by maintaining rearward pressure on the cocking handle as the bolt goes forward.

**3203. Detailed Disassembly and Assembly**

The term detailed disassembly, as it is used in this manual, refers only to those disassembly procedures authorized for the *OPERATOR* level. This is not to be confused with procedures authorized for 2D echelon maintenance (unit armorers) or above. Detailed disassembly of *ANY* of the groups beyond that described in this document is **NOT AUTHORIZED** except by qualified ordnance personnel.



Step 1. Removing the Spring Loaded Pin.

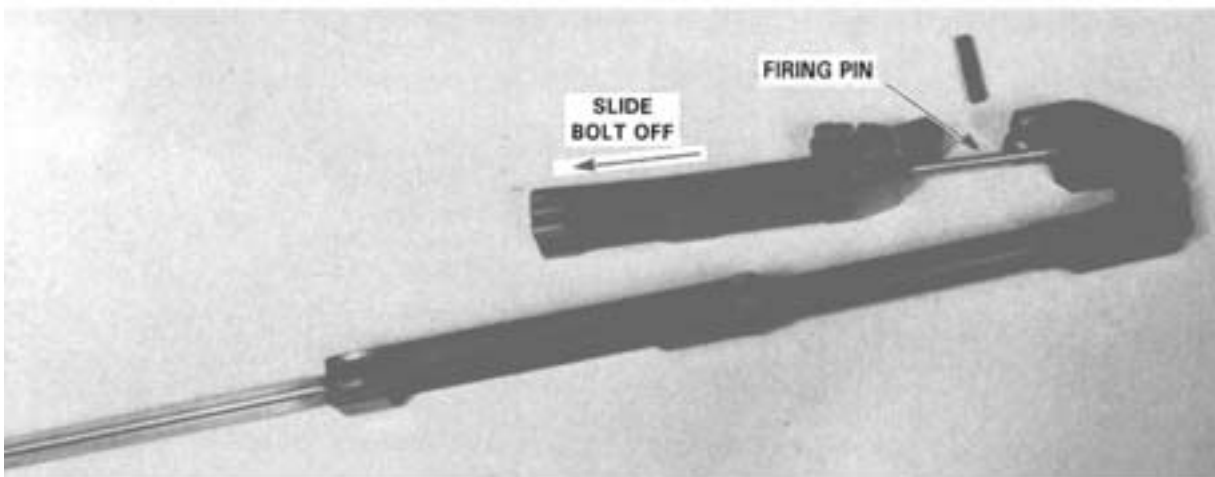

Step 2. Sliding the Bolt Forward Off Firing Pin.

Figure 3-13. Separating the Bolt and Operating Rod.

Detailed disassembly and assembly involves removing and replacing component parts of some of the main groups. Although further disassembly of the operating, barrel, and receiver groups is authorized at the unit level, it should be kept to a minimum to reduce the possibility of damaging or losing parts. The buttstock and trigger housing groups will not have a detailed disassembly performed by the operator.

### a. Operating Group

(1) **Detailed disassembly.** To separate the operating rod and bolt, remove the spring-loaded pin that holds

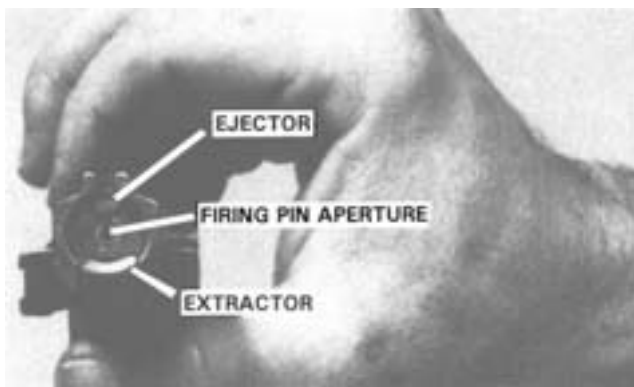

Figure 3-14. Bolt Face.

them together. Then, pull the bolt forward until it is clear of the firing pin, thus disengaging the bolt from the operating rod (see figure 3-13, steps 1 and 2). This completes detailed disassembly of the operating group. The firing pin remains affixed to the operating rod and the ejector and extractor remain affixed to the bolt. These parts are removed by ordnance personnel only (see figures 3-14 and 3-15).

### (2) Detailed assembly

- To join the bolt and operating rod, hold the rod in one hand, then position the rear of the bolt and slide it over the firing pin. See figure 3-16, step 1.
- Align the holes on the bolt with those on the operating rod and push the spring-loaded pin through them to secure the two assemblies together. The pin can be inserted from the left or right. See figure 3-16, step 2.

### b. Barrel Group

#### (1) Detailed disassembly

- Hold the barrel at the point where the gas system attaches to it. Grasp and rotate the collar clockwise until it releases from the gas plug. Remove

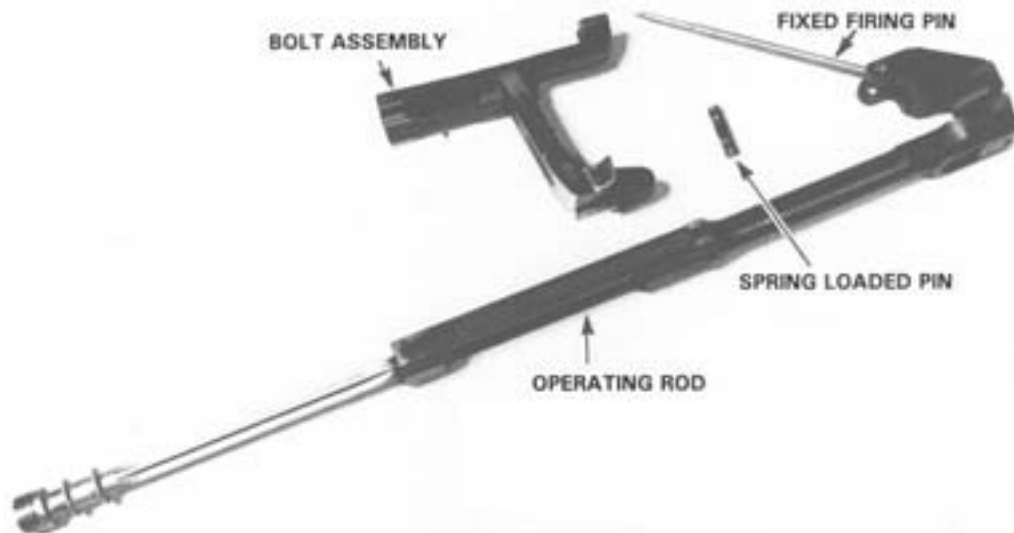
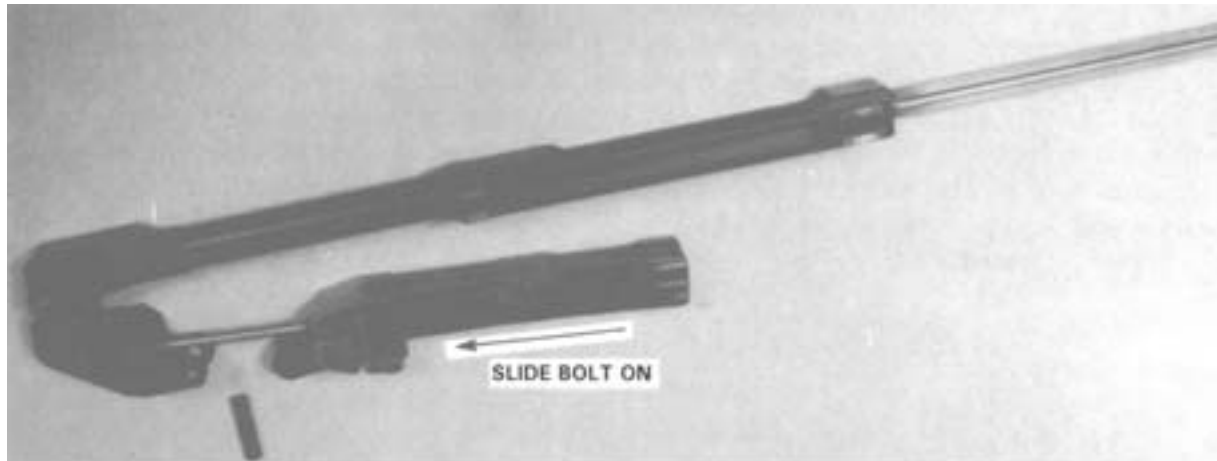

Figure 3-15. Operating Group, Detailed Disassembly.



Step 1. Sliding the Bolt Over Firing Pin.



Step 2. Inserting the Spring Loaded Pin.

**Figure 3-16. Assembling the Bolt and Operating Rod.**

the collar from the gas plug. See figure 3-17, steps 1 and 2.

- Slide the gas plug to the rear out of the gas regulator (see figure 3-17, step 3).

This completes detailed disassembly of the barrel group (see figure 3-18).

## (2) Detailed assembly

- Insert the gas plug into the gas regulator.
- Place the collar over the forward end of the plug. Push against face of the collar while rotating counterclockwise until it locks into place. Pull on the collar to ensure it is in the locked position.

## c. Receiver Group

(1) **Detailed disassembly.** To remove the cover and feedtray, first raise the cover straight up. Then pull the hinge spring pin out and lift the cover and feedtray from the receiver. See figures 3-19, steps 1 and 2. This completes detailed disassembly of the receiver group. See figure 3-20.

(2) **Detailed assembly.** To replace the feedtray, lay the feedtray on the receiver so that the feedtray guides are aligned with the receiver brackets. See figure 3-21. To replace the cover, place the cover onto the receiver aligning its mounting holes with the mounting brackets on the receiver, and push it down into its closed position. Then, insert the cover hinge spring pin into the holes to affix the cover and feed tray to the receiver.

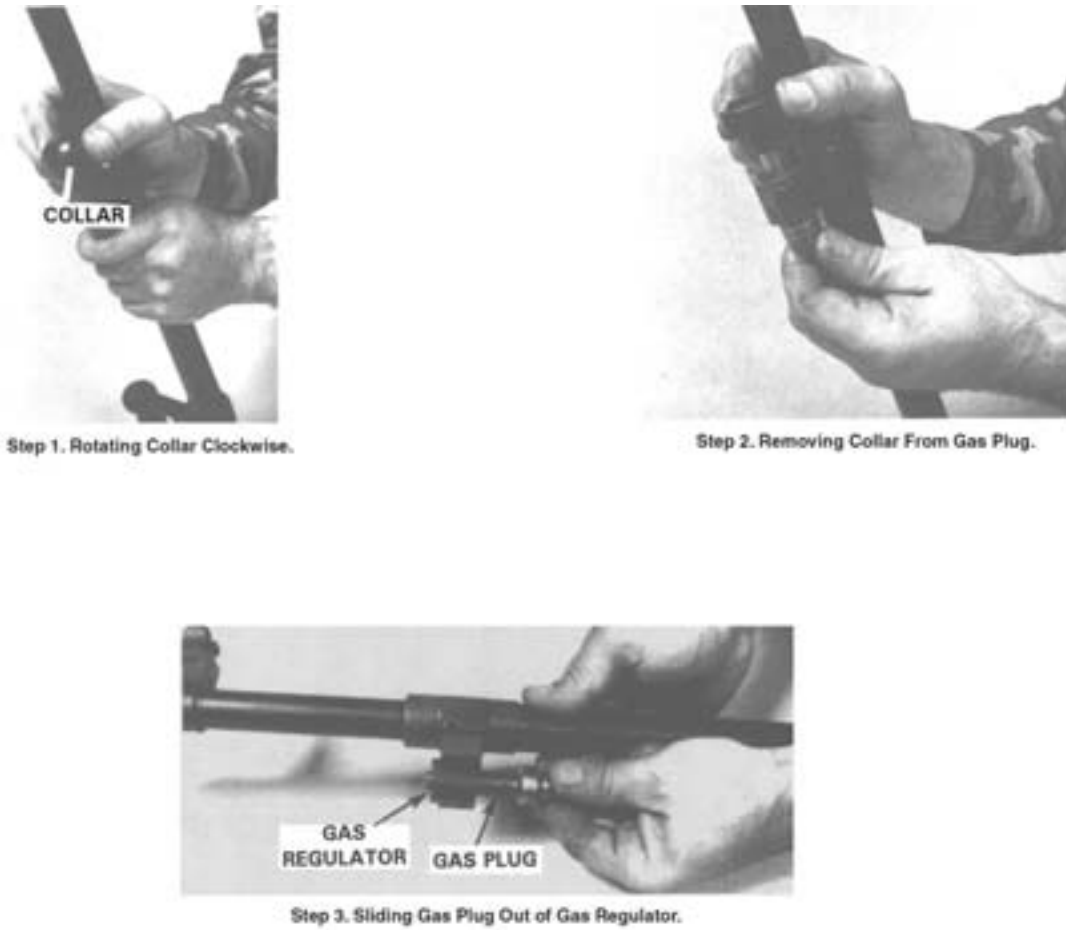

Figure 3-17. Disassembly of the Gas System.

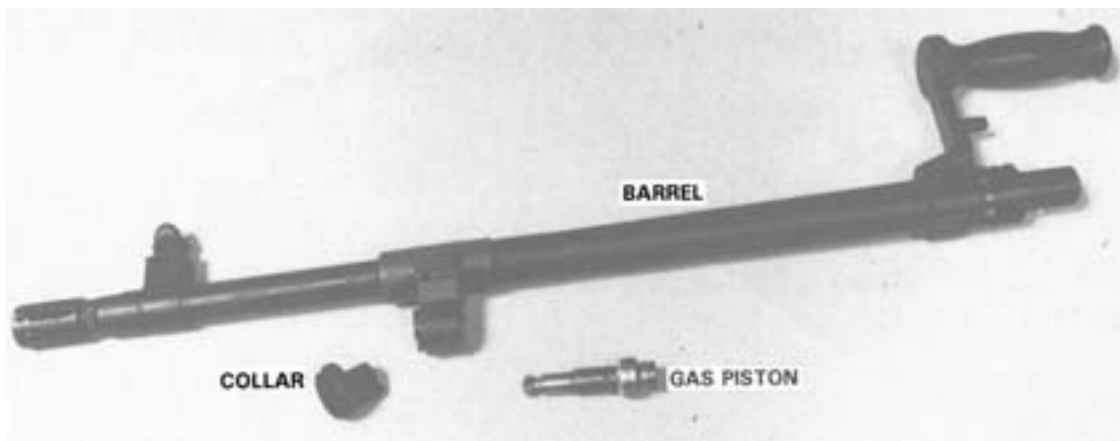
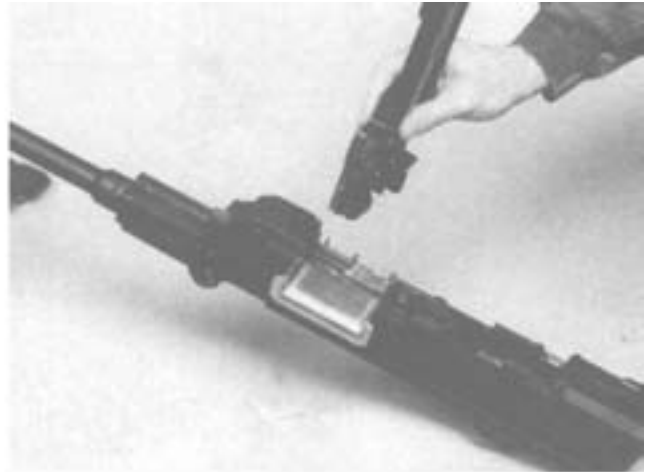

Figure 3-18. Barrel Group, Detailed Disassembly.



Step 1. Removing the Hinge Spring Pin.



Step 2. Removing the Cover and Feed Tray.

Figure 3-19. Removing the Cover and Feed Tray.

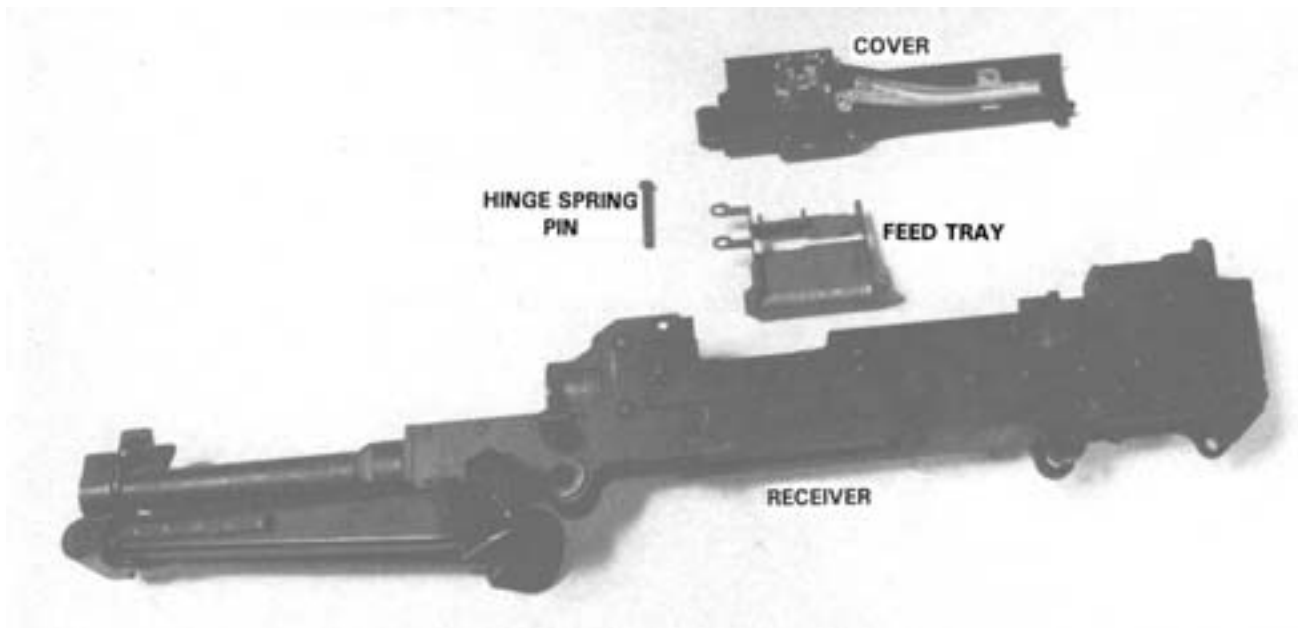

Figure 3-20. Receiver Group, Detailed Disassembly.





Figure 3-21. Aligning the Feed Tray Guides.

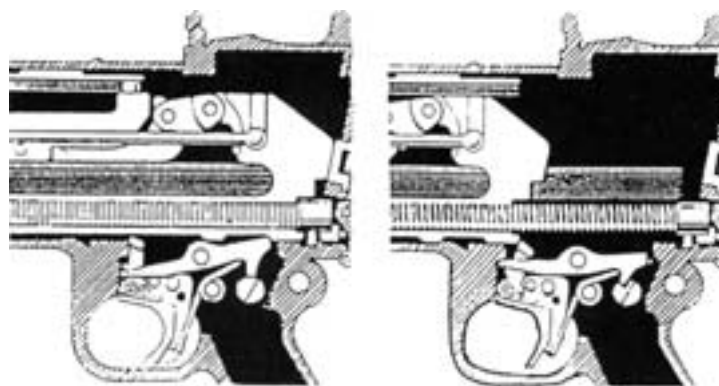

Figure 3-22. Trigger Pull Releasing the Operating Group.

---

### Section 3 Functioning

---

The cycle of functioning is broken down into eight basic steps. More than one step can occur simultaneously during the cycle of functioning. These steps are feeding, chambering, locking, firing, unlocking, extracting, ejection, and cocking. By understanding how the M240G functions, it will be easier to recognize and correct malfunctions and stoppages which occur during firing.

The cycle begins by loading a round in the feedtray groove and then pulling the trigger. The sear is

pulled down by the trigger, disengaging it from the sear notch on the bottom of the operating rod, and initiating forward movement of the operating group under the force of the expanding drive spring. It ends when the trigger is released and the rear of the sear raises up reengaging the sear notch, which then holds the bolt to the rear in its open or ready to fire position. See figure 3-22.

#### 3301. Feeding

When the bolt is to the rear, the outer feed pawls are outside the first round of ammunition. (See

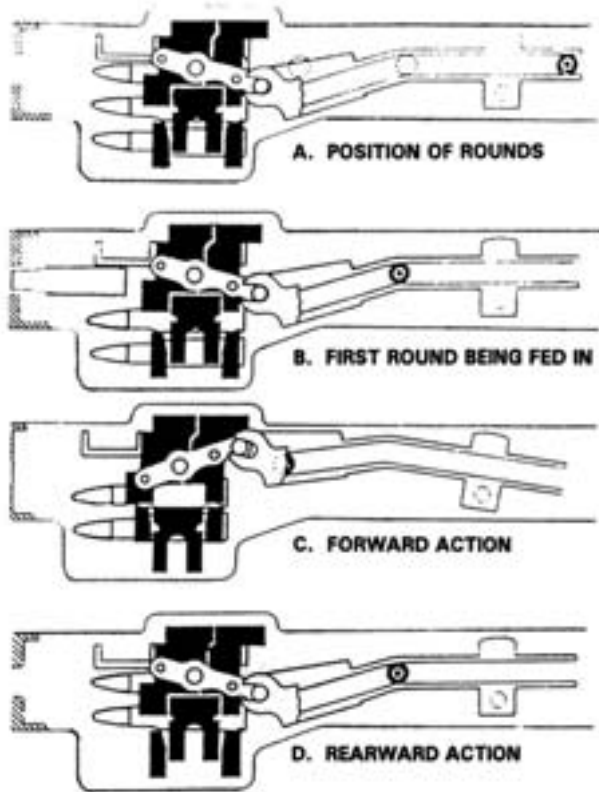

Figure 3-23. Feeding.

figure 3-23.) The inner feed pawls are between the first and second rounds (see figure 3-21).

As the bolt moves forward to fire the round in the feedtray groove, the belt feed pawl moves to the left. It moves up and over the second round in the belt of ammunition and is now in position to drag the second round into the feedtray groove (see figure 3-22).

As the bolt moves to the rear after firing, the belt feed pawl moves to the right, dragging the second round into the feedtray groove. Inside the cover the cam roller, feed arm with control spring, feed arm fork, and pivot arm exist only so the feed pawls can move back and forth, dragging rounds into position to be chambered (see figure 3-24).

### 3302. Chambering

This is the process of stripping a round from the belt and seating it in the chamber. As the bolt travels forward, the upper locking lug of the bolt contacts the base of the cartridge. The bolt strips the round from the belt link. The chambering ramp angles downward and forces the round toward the chamber along with the spring tension of the cartridge guide pawl (see figure 3-25). The cartridge

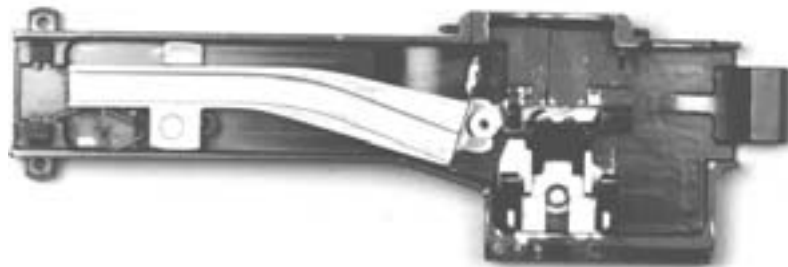

Figure 3-24. Cover Parts.

guide pawl also holds back the belt link. When the round is fully seated in the chamber, the extractor snaps over the extractor rim of the cartridge, and the ejector is depressed.

### 3303. Locking

During chambering, the bolt enters the barrel socket as the operating rod is driven forward by the drive

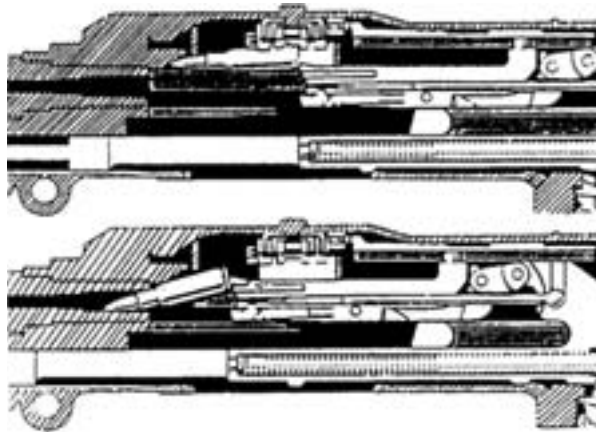

Figure 3-25. Chambering.

spring and the locking lever, which the bolt is riding on, swings forward pushing the bolt forward and locking it to the barrel socket. Although the term locking is used here, it should be noted that in the M240G the bolt and barrel do not physically interlock. This is why the barrel can be removed even when the bolt is forward (see figure 3-26).

### 3304. Firing

After the bolt reaches its locked position, the operating rod moves forward, independent of the bolt (see figure 3-25). It carries the striker of the fixed firing pin through the aperture in the face of the bolt, striking and detonating the primer of the cartridge. See figure 3-27.

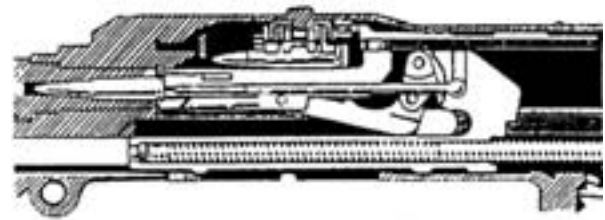

Figure 3-26. Locking.

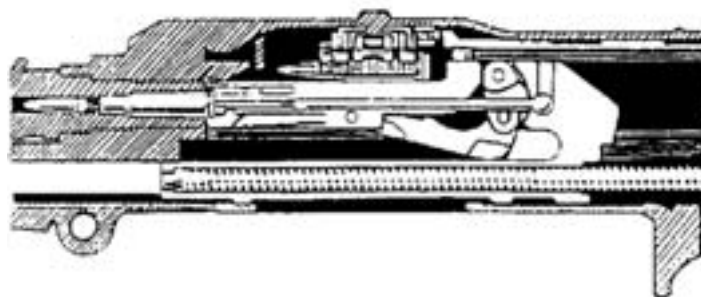

Figure 3-27. Firing.

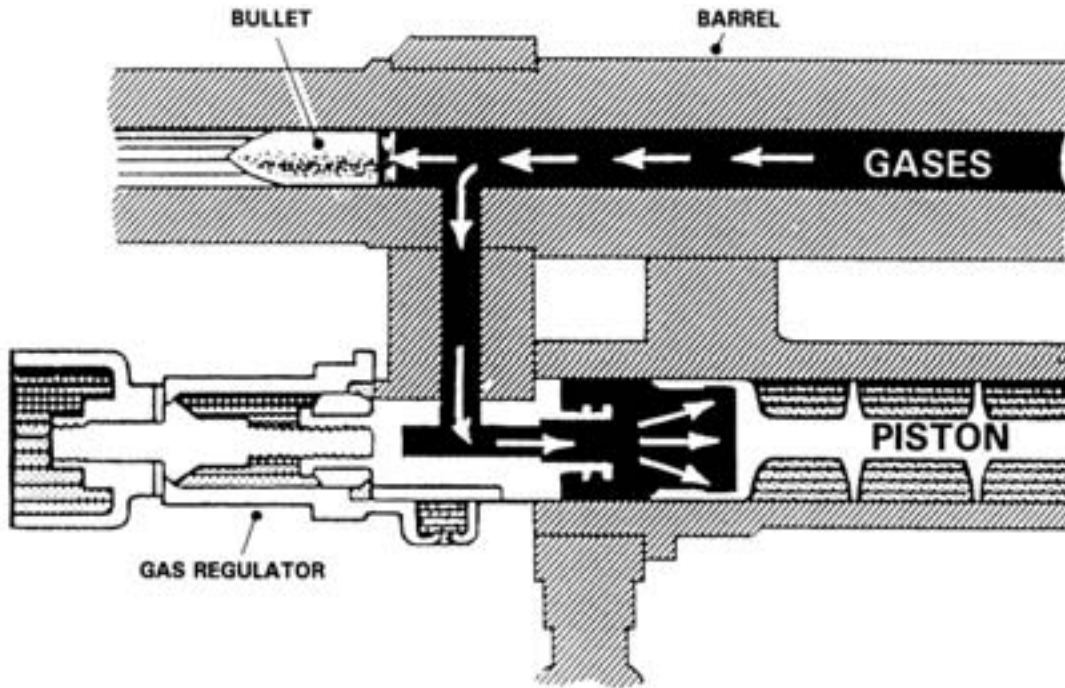

Figure 3-28. Action of the Gas.

### 3305. Unlocking

After the cartridge ignites and the projectile passes the gas port, part of the gases enter the gas cylinder. The rapidly expanding gases enter the hollow end cap of the gas piston and force the operating assembly to the rear, providing the power for the last four steps in the cycle of functioning (see figure 3-28). The operating rod now moves rearward, independent of the bolt, for a short distance. At this point, the locking lever begins to swing toward the rear, carrying the bolt with it into its unlocked position, and clears the barrel socket (see figure 3-29).

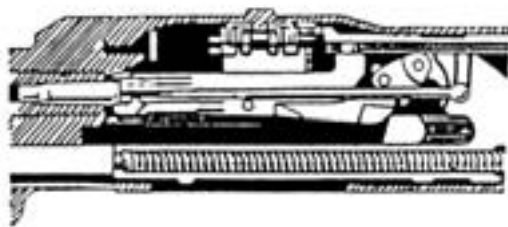

Figure 3-29. Unlocking.

### 3306. Extracting

The extractor grips the rim of the cartridge as the bolt and operating rod pull the case from the chamber. See figure 3-30.

### 3307. Ejecting

As the case is withdrawn from the chamber, the ejector exerts a push from the top, and the extractor exerts a pull from the bottom. The casing falls from the gun as soon as it reaches the cartridge ejection port (see figure 3-30). At approximately the same time, the empty link is forced out of the link ejection port between the cartridge stops on the feedtray by the next round moving into the feedtray groove.

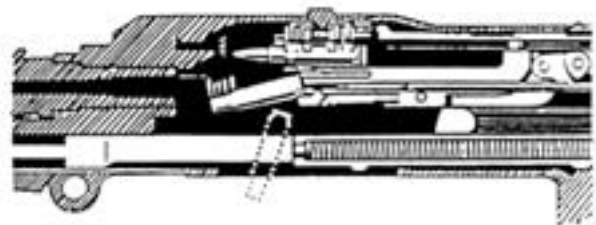

Figure 3-30. Extraction and Ejection.

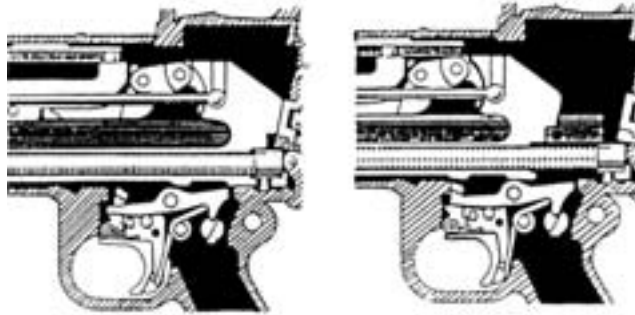

Figure 3-31. Cocking.

### 3308. Cocking

This is the process of placing the parts of the gun in position to fire the next round. During the rearward independent movement of the operating rod, the firing pin striker is withdrawn from the face of the bolt. When the bolt has moved far enough to the rear to pick up the next round for chambering, cocking is completed. (See figure 3-31.)

---

## Section 4 Malfunctions and Stoppages

---

Machine gunners must have a detailed understanding of the many component parts of their weapon, what those parts do during functioning, and what mechanical problems may be encountered during firing. This knowledge ensures that those problems can be quickly assessed and corrective action taken.

### 3401. Malfunctions

A malfunction is a failure of the gun to function satisfactorily; the gun will fire, but fires improperly. Defective ammunition or improper operation of the gun by a crewmember is not considered a malfunction. Two of the more common malfunctions are sluggish operation and runaway gun.

**a. Sluggish Operation.** Instead of firing at its normal rate (approximately 9 to 10 rounds per second), a sluggish gun fires very slowly. It can be due to exces-

sive friction or loss of gas. Excessive friction is usually due to lack of lubrication or excessive dirt/carbon in the gas system or on the bolt and receiver rails. Excessive loss of gas is usually due to loose connections in the gas system. To reduce sluggish operation, move the regulator setting to the number 2 or 3 position (see figure 3-32). To remedy continued sluggish operation, clean, lubricate, tighten, or replace parts as required.

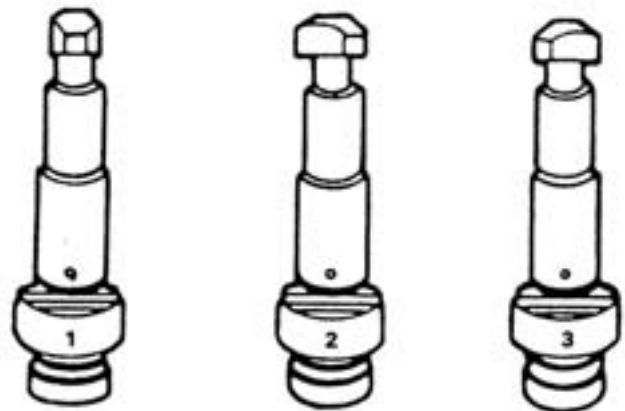

Figure 3-32. Gas Regulator Settings.

**b. Runaway Gun.** This is when a gun continues to fire after the trigger is released; firing is uncontrolled. A runaway gun is usually caused by a worn, broken, or burred sear; the sear shoulder is unable to grab the operating rod and hold it to the rear. An excessively worn sear notch on the operating rod could also be responsible. The action taken to stop a runaway gun, for both tripod and bipod-mounted

guns, is for the team leader to twist and break the belt of ammunition. The remedy for runaway gun is to replace worn parts.

### 3402. Stoppages

A stoppage is any interruption in the cycle of functioning caused by faulty action of the gun or defective ammunition; in short, the gun stops firing. Stoppages must be cleared quickly and firing resumed. Apply immediate action (see paragraph 3403).

### 3403. Immediate Action

Immediate action is that action taken by the gunner/crew to reduce a stoppage, without investigating its cause, and quickly return the gun to action. Hang fire and cook off are two terms that describe ammunition condition and should be understood in conjunction with immediate action procedures.

A hang fire occurs when the cartridge primer detonates after being struck by the firing pin but some problem with the propellant powder causes it to burn too slowly and delays the firing of the projectile. Time (5 seconds) is allotted for this malfunction before investigating a stoppage further because injury to personnel and damage to equipment could occur if the round goes off with the cover of the weapon open.

A cook off occurs when the heat of the barrel is high enough to cause the propellant powder inside the round to ignite even though the primer is not struck. Immediate action is completed in a total of 10 seconds to ensure that the round is extracted before the heat of the barrel affects it. When the round fails to extract/eject, further action is delayed (15 minutes) if the barrel is hot because the gunner must assume that a round is still in the chamber and could cook off before the barrel cools down.

Immediate action procedures for the M240G are as follows:

- Wait 5 seconds after the misfire to guard against a hang fire.
- Within the next 5 seconds (to guard against a cook off), pull the charging handle to the rear, observe the ejection port, and, if brass was seen ejecting, attempt to fire again. If brass did not eject, place the weapon on S, determine if the barrel is hot (200 rounds or more fired in the last 2 minutes) or cold, and take the appropriate steps as outlined in figure 3-33.

### 3404. Remedial Action

When immediate action fails to reduce the stoppage, remedial action must be taken. This involves investigating the cause of the stoppage and may involve some disassembly of the weapon and replacement of parts to correct the problem. Two common causes of a stoppage that may require remedial action are failure to extract due to a stuck or ruptured cartridge. See figure 3-34.

**a. Stuck Cartridge.** Some swelling of the cartridge occurs when it fires. If the swelling is excessive, the cartridge will be fixed tightly in the chamber. If the extractor spring has weakened and does not tightly grip the base of the cartridge, it may fail to extract the round when the bolt moves to the rear. Once the bolt is locked to the rear, the weapon is placed on S, and the barrel has been allowed to cool, a length of cleaning rod should be inserted into the muzzle to push the round out through the chamber.

**b. Ruptured Cartridge.** Sometimes a cartridge is in a weakened condition after firing. In addition, it may swell as described above. In this case, a properly functioning extractor may sometimes tear the base of the cartridge off as the bolt moves to the rear, leaving the rest of the cartridge wedged inside the chamber. The ruptured cartridge extractor must be used in this instance to remove it. The barrel must be removed and the extractor inserted into the chamber where it can grip and remove the remains of the cartridge.

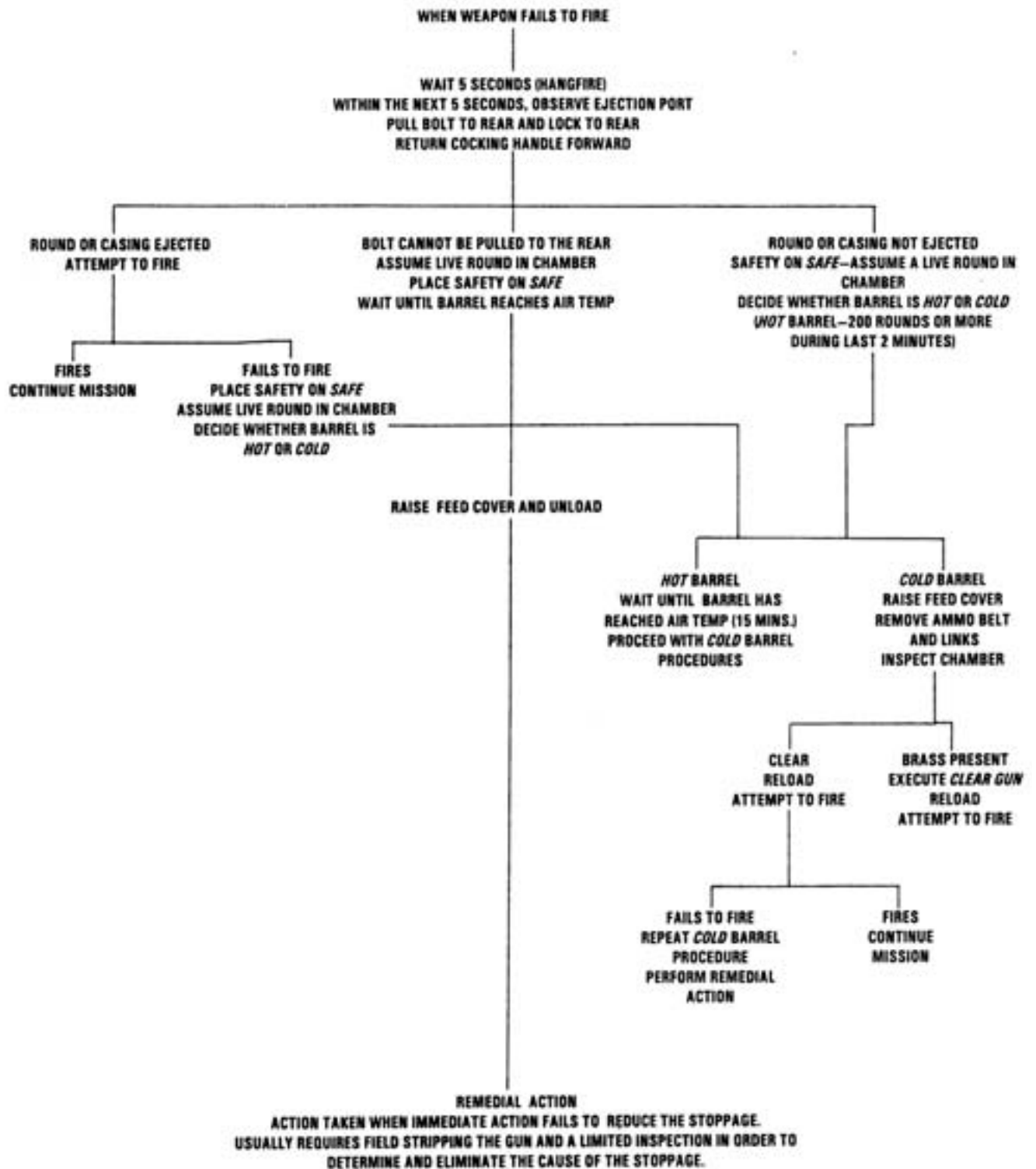

Figure 3-33. Immediate Action.

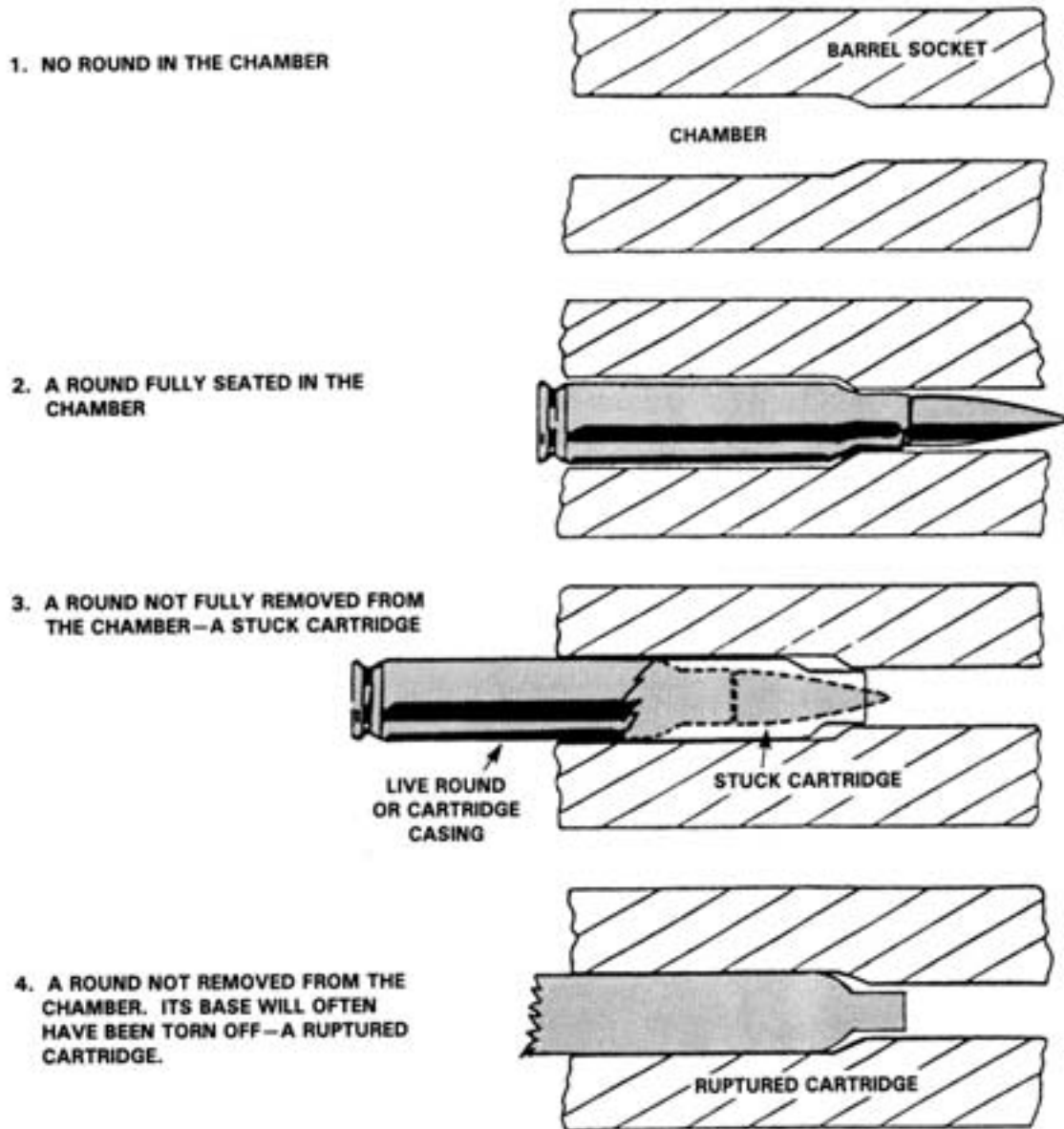

Figure 3-34. Chamber Condition During Immediate Action.



---

## Section 5

### Mounts and Accessories

---

In most cases, the M240G can be best utilized when fired from a tripod mount. In this configuration, the M240G's potential for continuous, accurate fire and controlled manipulation can be maximized. In some situations, however, the gunner can use the bipod mount. Proper utilization of the bipod and the tripod are discussed in this section.

#### 3501. Bipod

The bipod mount is part of the receiver group. It cannot be removed by the operator. The bipod is held in position by the ball joint that joins it to the bottom of the receiver. See figure 3-35.

**a. Lowering.** To lower the bipod legs, push in on the bipod latch and rotate the legs down and forward (see figure 3-36). Release the legs and they will automatically spring outward into their open and locked position.



Figure 3-35. Bipod Assembly.

**b. Raising.** To raise the bipod legs, squeeze them together and rotate the legs rearward and upward into the slot on the bottom of the receiver until the bipod latch engages, locking them in position.

**c. Lateral Movement.** The M240G's bipod pivots on the ball joint, allowing quick and easy right or left lateral movement of the weapon by the gunner.

#### 3502. Tripod Mount, M122

The M122 tripod mount consists of the tripod assembly and flex-mount with the T&E mechanism. See figure 3-37. The tripod assembly provides a stable and relatively lightweight base that is far superior to the bipod. The tripod may be extended and collapsed easily. It consists of a tripod head, one front and two rear legs, and a traversing bar (see figure 3-38). The traversing bar connects the two rear legs. It is hinged on one side with a sleeve and on the other side with a sleeve latch. This allows the tripod to collapse to a closed position for carrying or storage or to lock in an open extended position for use. The traversing bar also supports the T&E mechanism. Engraved on the bar is a scale that measures direction in mils. It is graduated in 5-mil increments. It is numbered every 100 mils from 0 in the center to 450 mils on the left side and 425 mils on the right side (see figure 3-39).

#### 3503. Flex-mount

The flex-mount consists of the mount itself and the (T&E) mechanism. It joins the gun and T&E to the tripod. The flex-mount enhances the stability of the tripod platform and dampens the recoil of the weapon (see figure 3-40). The purpose of the T&E mechanism is to provide controlled manipulation and the ability to engage predetermined targets (see figure 3-41). Detailed instructions for its employment are contained in chapter 6.

The traversing portion of the mechanism consists of the traversing hand wheel, traversing screw, offset head, and traversing slide with lock lever. As the hand wheel is turned, the offset head will appear to move along the traversing screw, and the muzzle of the weapon will

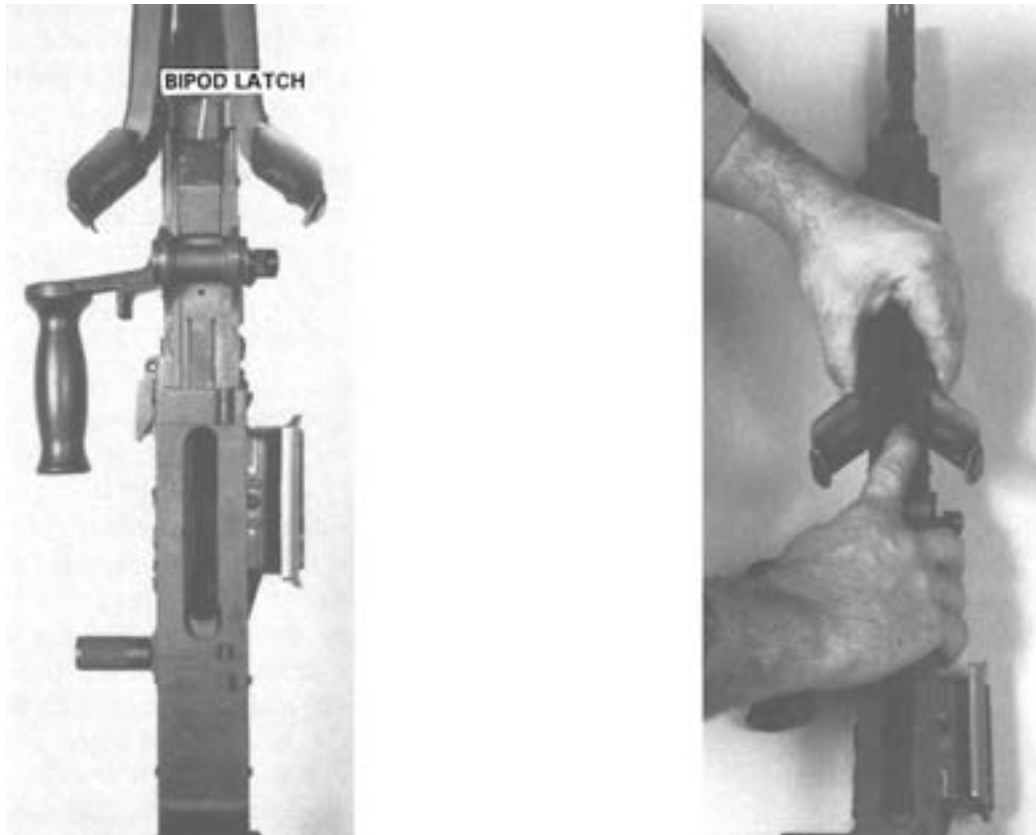

Figure 3-36. Lowering the Bipod.

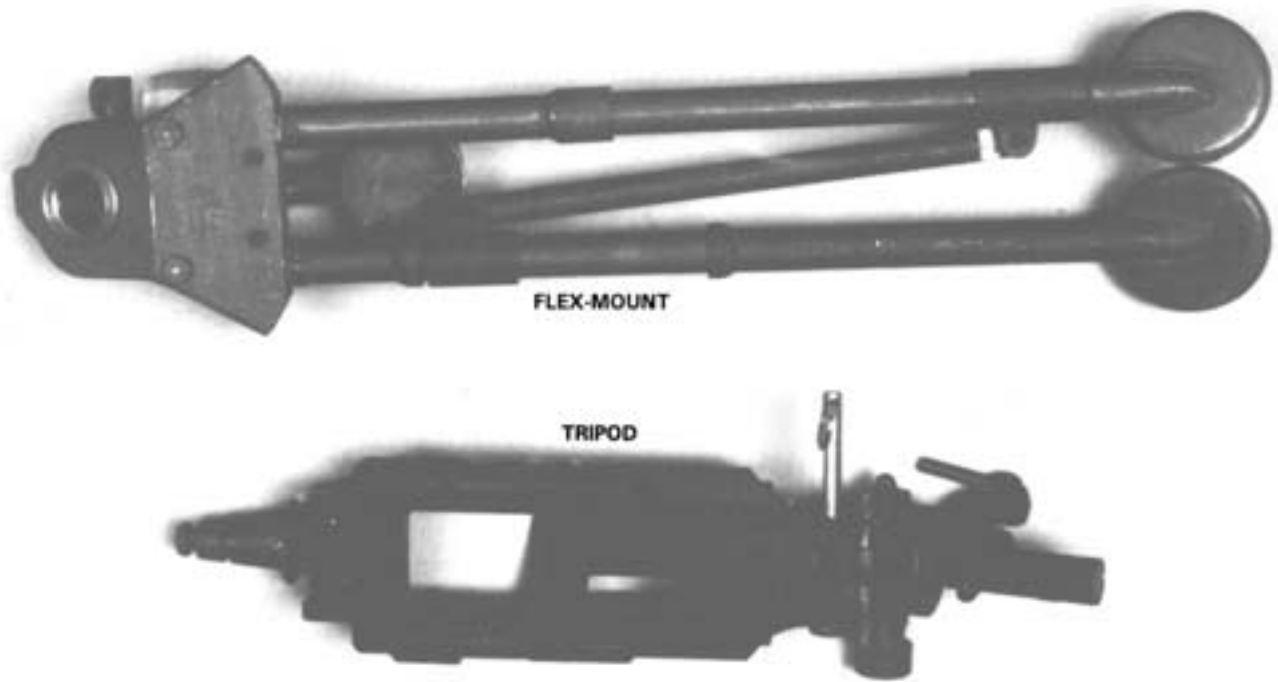

Figure 3-37. M122 Tripod and Flex-mount.

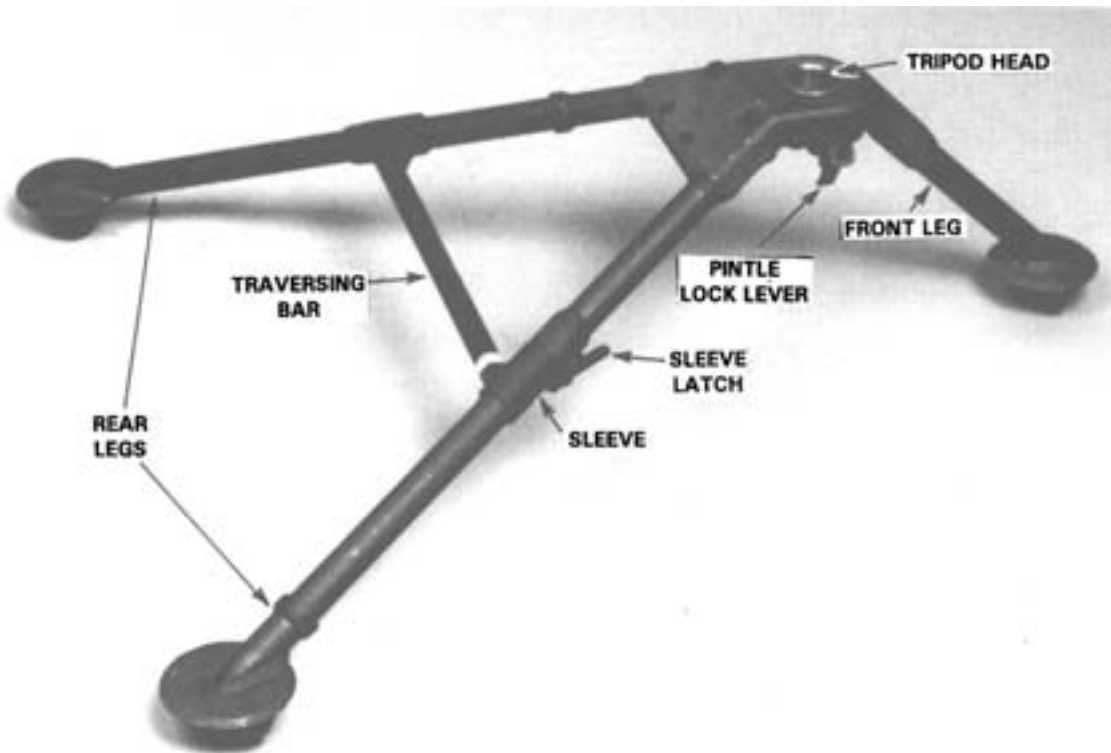

Figure 3-38. Tripod.

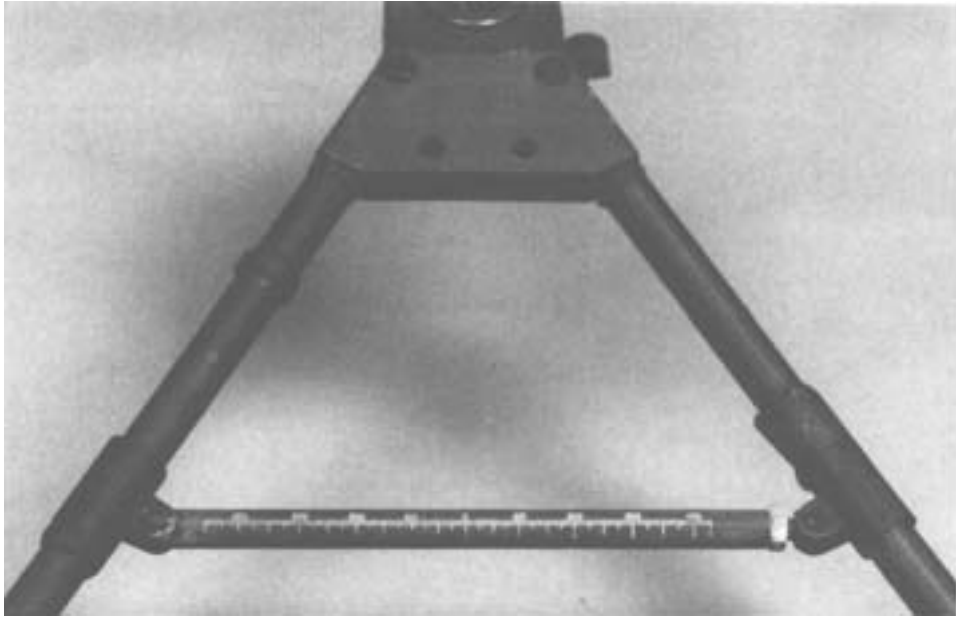

Figure 3-39. Traversing Bar.

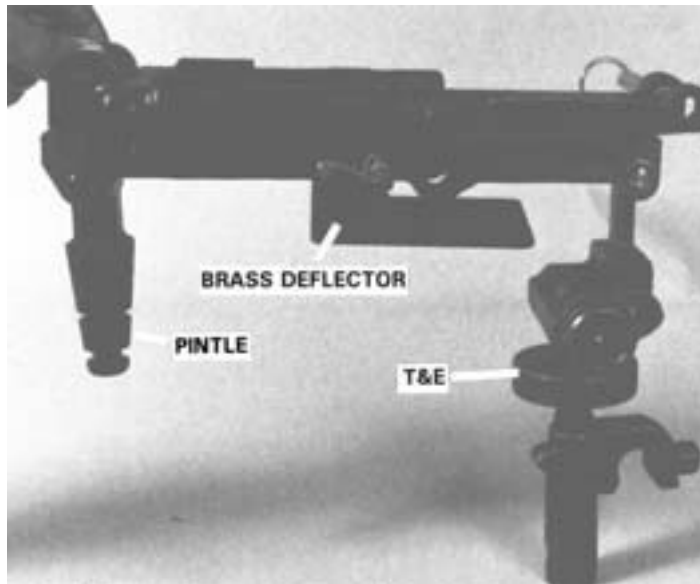

Figure 3-40. Flex-mount.

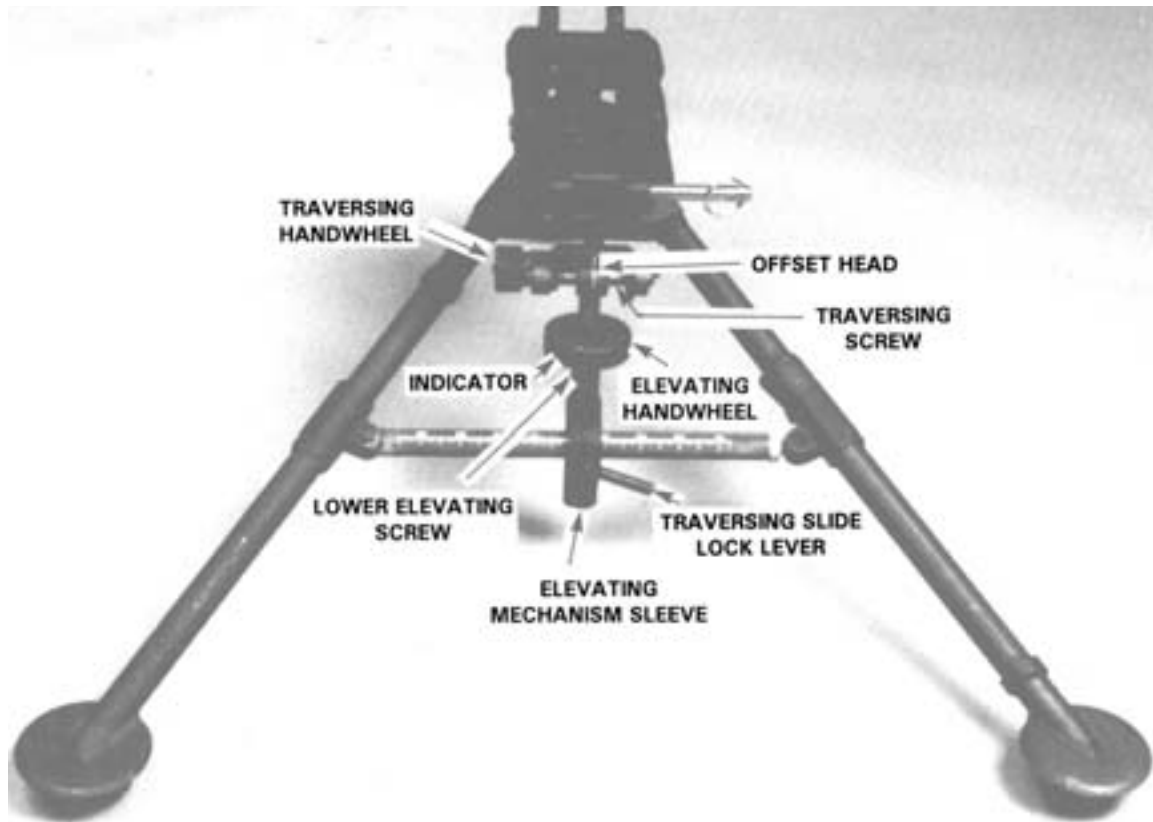

Figure 3-41. T&E Mechanism.

move to the right or left. Each click of the hand wheel indicates a 1 mil change in direction of the muzzle: 1 click = 1 mil. There is a total of 100 mils traverse on the traversing screw. Notice that the traversing slide is a U-shaped projection near the bottom of the T&E mechanism. This slide is locked to the traversing bar by the slide locking lever while firing.

The elevating portion of the mechanism consists of the upper elevating screw with scale, elevating hand wheel, and lower elevating screw. The scale on the upper elevating screw is graduated in 50-mil increments from 0 to +200 and 0 to -200, for a total of 400 mils of elevation change. The elevating hand wheel also has a scale. It is marked in 1 mil increments from 0 to 50. One click on the elevating hand wheel indicates a 1 mil change in elevation of the barrel: 1 click = 1 mil. Beneath the elevating hand wheel is the lower elevating screw.

**a. Mounting the Gun.** The preferred method of mounting the gun is to first attach the flex-mount to the tripod and then mount the gun on the flex-mount.

- Prepare the tripod, extend its legs until the sleeve latch engages, locking them open. See figure 3-38.
- Prepare the T&E mechanism for mounting: rotate the elevating hand wheel until approximately 1 1/2 inches (two fingers) are visible on the upper elevating screw, rotate the traversing slide until approximately two fingers are visible on the lower elevating screw, and rotate the traversing hand wheel until the offset head is centered on the traversing screw. The T&E is now roughly centered.
- Insert the flex-mount's pintle into the tripod's pintle bushing and then engage the pintle locking lever to hold it in place. See figure 3-42, steps 1 and 2.

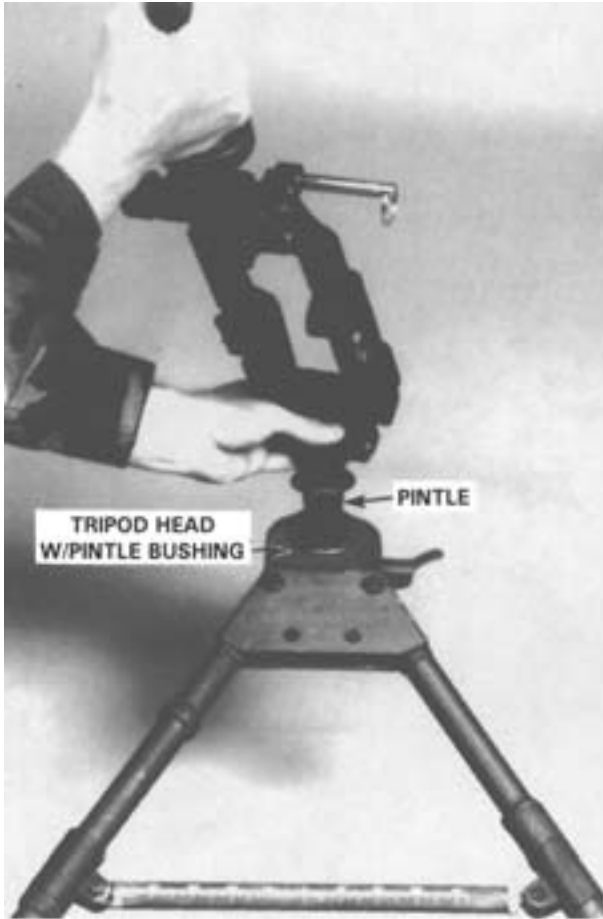

**Step 1.**  
Inserting the Pintle into Pintle Bushing.



**Step 3.**  
Lowering the Traversing Slide  
Over Traversing Bar.

**Figure 3-42. Attaching the Flex-mount to the Tripod.**

Step 2.  
Engaging the Pintle Lock.

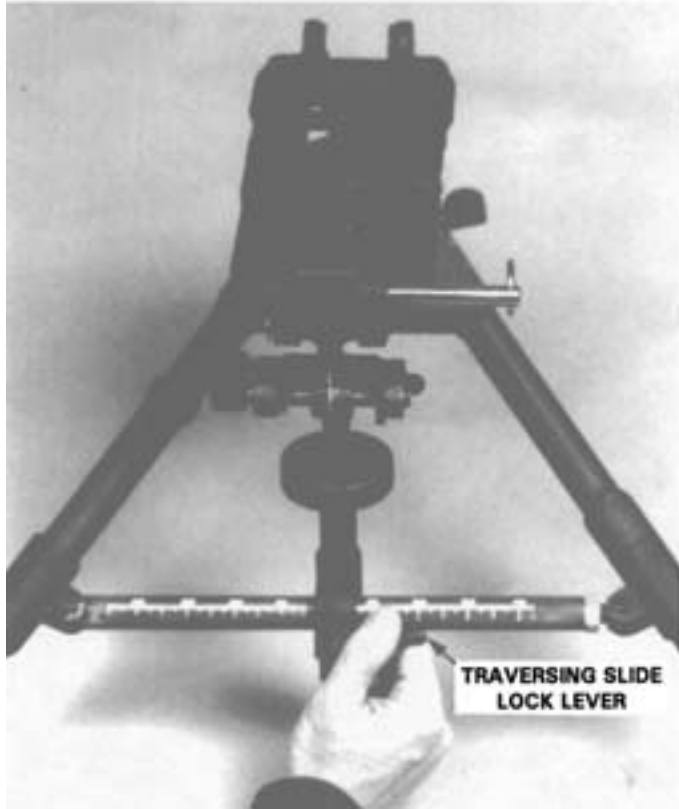

Step 4.  
Locking Down the T&E.

Figure 3-42. Attaching the Flex-mount to the Tripod—Continued.

- Lower the traversing slide over the traversing bar with the traversing slide to the rear and the traversing wheel to the left. Secure it by turning the locking lever clockwise. See figure 3-42, steps 3 and 4.
- Attach the gun to the flex-mount by pushing the recesses on the forward portion of the receiver on the bottom of the receiver against the forward bushings on the flex-mount (see figure 3-43, step 1). Rotate the rear of the gun down to the mount and insert the retaining pin forward of the trigger housing assembly to lock the weapon in place (see figure 3-43, step 2). This completes mounting (see figure 3-44).

**b. Dismounting the Gun.** The preferred method of dismounting the gun is to first remove the flex-mount's rear retaining pin, raise up on the rear of the gun, and then pull the gun back, disengaging it from the mount's forward bushing.

To remove the flex-mount from the tripod, first unlock the traversing slide lock (turn the lever coun-

terclockwise). Then disengage the pintle lock and raise the pintle and entire mount up and off the tripod.

### 3504. Gun Bag

The gun bag is used to carry and protect the M240G machine gun system, complete. It consists of a large outer bag and a smaller, removable spare barrel bag inside. The complete gun bag is used to carry the machine gun, tripod, flex-mount, spare barrel, and all user maintenance equipment and other accessories (SL-3 components) (see figure 3-45). This will keep the gun and all its components together and protected during events such as unit movements for embarkation on ships or aircraft. The removable spare barrel bag is designed for field use and will carry the spare barrel, and a complete set of user maintenance equipment and accessories (SL-3 components) (see figure 3-46). The spare barrel bag has adjustable shoulder straps and can be worn like a pack. It can also be carried by a fixed carrying strap.

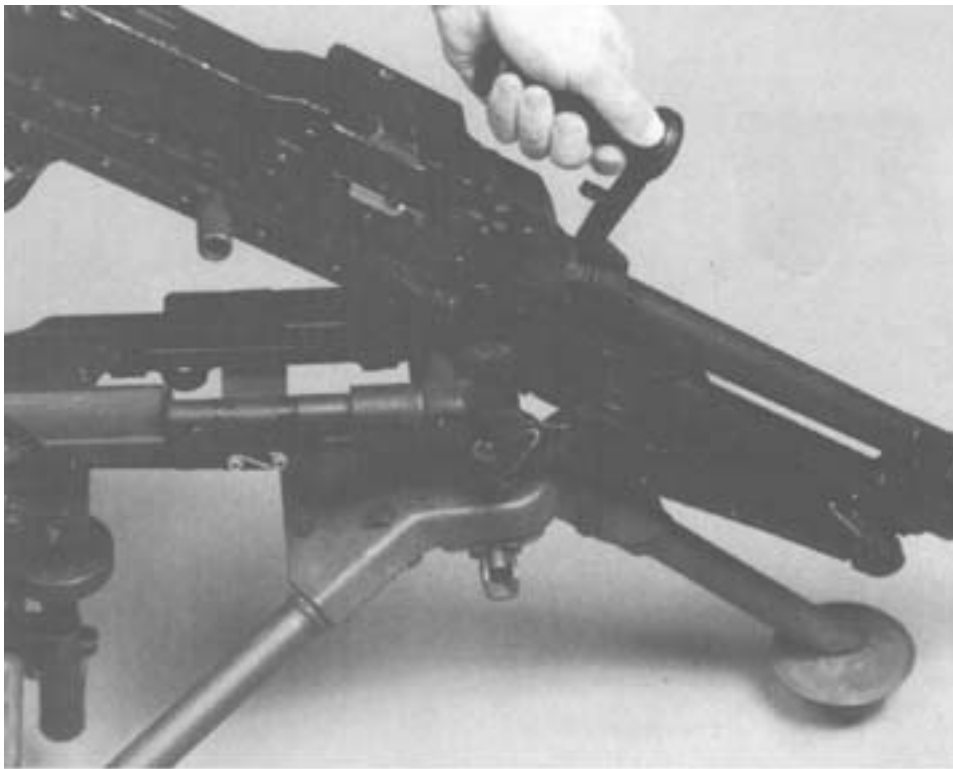

Step 1. Affixing the Gun to the Flex-mount's Forward Bushing.

Figure 3-43. Attaching the Gun to the Flex-mount.



### 3505. Night Vision Equipment

Mounting hardware required to mount night vision equipment (NVE) on the M240G is under development. In the interim, existing NVE can be redistributed or its use modified to meet mission needs in regard to M240G employment at night. AN/PVS-5 night vision goggle (NVG), AN/PVS-4 individual served weapon sight (ISWS), AN/PVS-7B NVG, and AN/PAQ-4B infrared aim light (IAL) provides the M240G with the required night vision capability. The first three are passive image intensifiers, and the last one is a device that will place an aim point on a target out to 600M. The IAL is visible only with an image intensification device, so it is invisible to the naked eye. Until a sight mounting system is fielded for the M240G, use of these devices in any combination deemed appropriate by the unit commander will ensure adequate night vision capabilities within M240G squads and teams. Procurement of thermal

sights for the medium machine gun is a high priority. The overall NVE concept of employment is for thermal sights, image intensified night vision devices, and infrared aim lights to be employed in a complimentary manner, allowing Marines to operate effectively at night. This will improve their mobility and ability to detect and engage the enemy.

**a. Night Vision Goggles, AN/PVS-7B.** The machine gun squad leader can use the AN/PVS-7B NVG to detect, identify, and adjust his guns onto targets. The machine gun team leader can also use the AN/PVS-7B NVG in the same manner to aide in the employment of his machine gun team. The team leader spots and adjusts for the gunner at night just as he does during daylight engagements. The gunner could also be equipped with the AN/PVS-7B, either instead of or in addition to the squad leader or team leader. This would enable the gunner to detect, identify, and adjust his own fire onto targets. The AN/PVS-7Bs are lightweight (1.5 lbs.), small,



Step 2. Locking the Gun in Place with the Flex-mount's Rear Retaining Pin.

Figure 3-43. Attaching the Gun to the Flex-mount—Continued.



**Figure 3-44. The Tripod-Mounted Gun.**



**Figure 3-45. Gun Bag.**

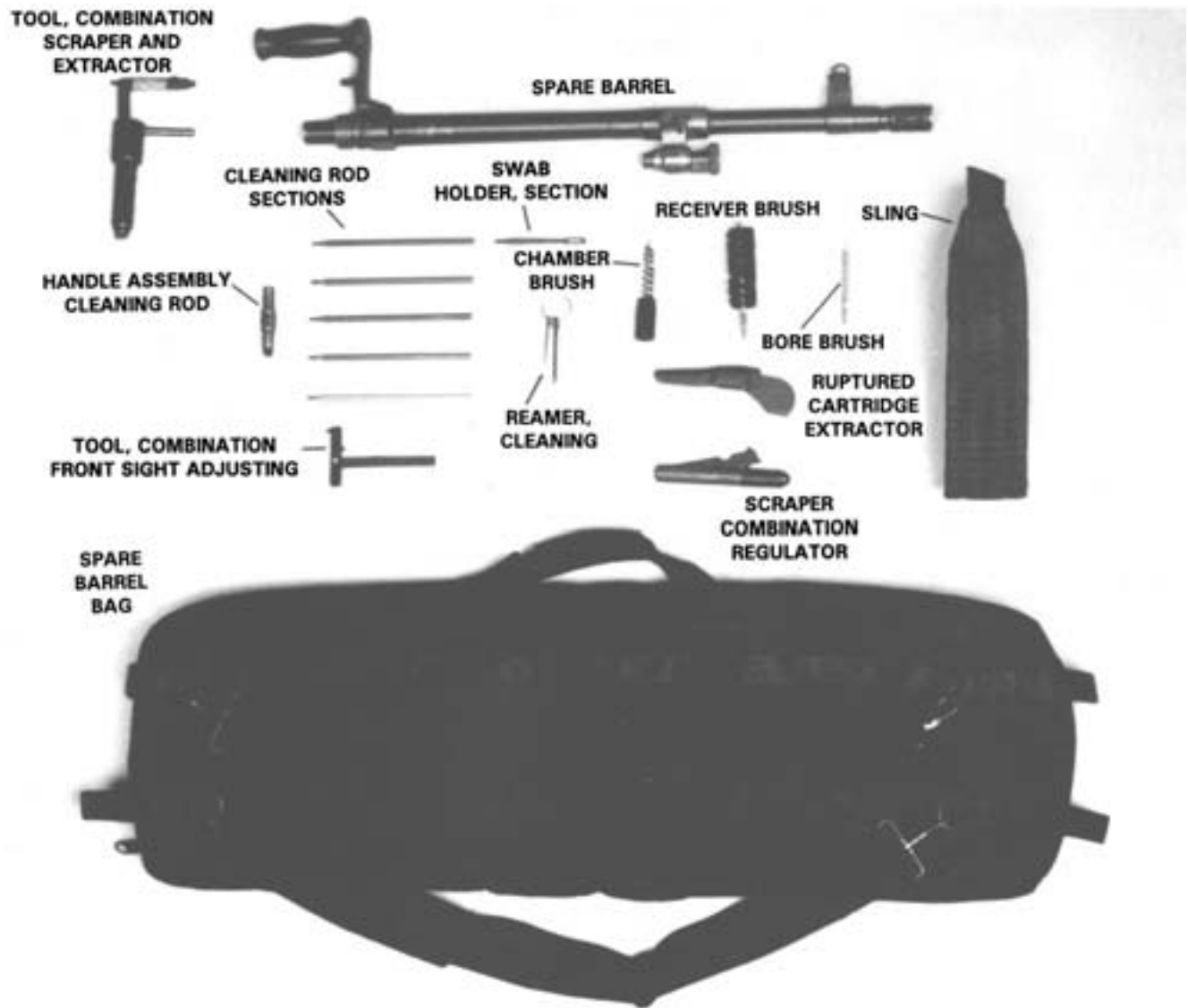

Figure 3-46. Spare Barrel Bag.

and easy to carry and use. This is important when considering the load already carried by machine gun teams. The AN/PVS-7B NVG can be hand-held or worn with a head mount. This is important if issued to the gunners because gunners need both hands free to operate the weapon and manipulate the T&E. The AN/PVS-7Bs have a range of 250 meters in moonlight and 200 meters in starlight. See figure 3-47.

**b. Individual Served Weapon Sight, AN/PVS-4.** The AN/PVS-4 is the currently fielded night sight used with various weapons, including the medium machine gun.

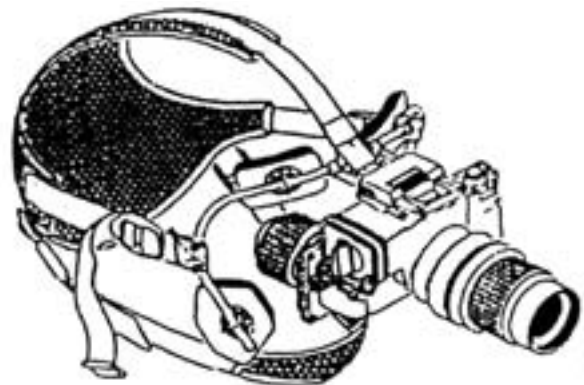

Figure 3-47. AN/PVS-7B, NVG.

There is no mount to attach the AN/PVS-4 to the gun; however, the AN/PVS-4 can be hand-held and would serve more as a monocular night vision device than as a sight in this configuration. The AN/PVS-4 can be used in this manner by the machine gun squad leader and/or the team leader. The AN/PVS-4 could also be mounted on the squad leader's or team leader's M16 rifle; however, the team leader must ensure employment in this manner does not interfere with his duties as the assistant gunner. The AN/PVS-4 ISWS weighs 3.5 lbs and has a range of 600 meters in moonlight and 400 meters in starlight. See figure 3-48.



Figure 3-48. AN/PVS-4, ISWS.

c. **Night Vision Goggles, AN/PVS-5.** The AN/PVS-5 NVG is the currently fielded NVG; however, the AN/PVS-7B NVG will begin to augment/replace it in the future. The NVG functions and is used in basically the same way as the AN/PVS-7B NVG although the range is less, 150 M moonlight and 50 M starlight. See figure 3-49.

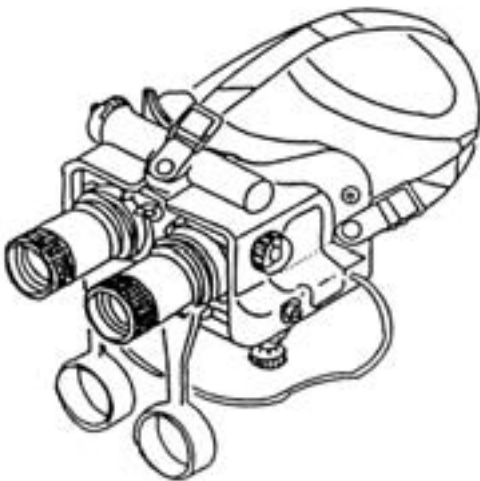

Figure 3-49. AN/PVS-5, NVG.

d. **Infrared Aim Light, AN/PAQ-4B.** The AN/PAQ-4B IAL is a small, lightweight device that bore-sights to the M240G and emits a beam of infrared light that is used in conjunction with a night vision device to acquire and engage targets at night. The IAL is visible only when viewed with image intensified NVE such as the AN/PVS-4 ISWS, AN/PVS-5 NVG, and AN/PVS-7B NVG. The IAL allows the gunner to aim and maintain fire on the target without the sighting process being disturbed by the recoil of the weapon system. The gunner puts the aim point on the target, fires, and adjusts the point of impact. He can readily see the impact of the rounds because his view is not being disrupted by the flash and recoil of the weapon. See figure 3-50.

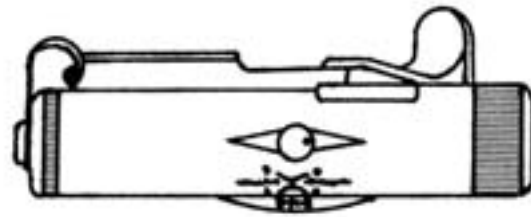

Figure 3-50. AN/PAQ-4B, IAL.

---

## Section 6 Maintenance

---

Proper maintenance, care, cleaning, and inspection of a weapon and its accessories determine whether or not it will function correctly when needed. The bore and chamber must be properly maintained to preserve accuracy. Because of the close fit of working surfaces and the high speed at which the gun operates, the receiver and all moving parts must be kept clean; correctly lubricated; and free from burrs, rust, and dirt to ensure proper, efficient functioning. Maintenance of the mount used with the weapon is no less important. The functioning of the gun and mount together as a weapons system determines its overall effectiveness. Finally, all accessories and equipment used with the gun and mount, including ammunition, must be properly maintained.

### 3601. Cleaning Materials and Lubricants

**a. Cleaning Materials.** The only authorized cleaning materials for use at the unit level are CLP, RBC, and dry cleaning solvent. Use CLP or bore cleaner for daily maintenance and to remove minor carbon buildup after firing. Dry cleaning solvent will dry out the metal and it is recommended for cleaning during change from one lubricant to another.

**b. Lubricants.** The lubricants authorized for field use on the M240G are CLP, LAW, LSA, and LSA-T. They are used to lubricate certain operating parts before, during, and after firing. Each type is best used in specific climatic and environmental conditions. See paragraph 3604.

### 3602. Care and Cleaning Before, During, and After Firing

**a. Before Firing.** Inspect for cleanliness, proper mechanical condition, and missing or broken parts. Remove excess oil from the bore, chamber, barrel socket, and face of the bolt. Lubricate the gun by placing a light coat of CLP on the following parts:

(1) **Operating rod.** Apply CLP on those recesses along the side that make contact with the receiver rails.

(2) **Bolt.** A very small amount of CLP should be placed on the spring pin, the roller, and other moving parts.

(3) **Receiver.** With the bolt to the rear, apply a line of CLP on either side of the bolt. Manually pull the bolt back and forth, so that CLP is spread over the bolt and receiver rails. Headspace should also be checked before firing. To do this, rotate the barrel changing handle and count the number of clicks heard. There must be a minimum of two clicks, but not more than seven. If this is not the case, the weapon should not be fired. It should be turned in for higher echelon maintenance/inspection.

**b. During Firing.** During firing, maintain a light coat of CLP on the parts listed in paragraph 3602a, and ensure that the gas system's connections remain tight. Change barrels when necessary.

**c. After Firing.** After firing, clean the gun with CLP, RBC, or dry cleaning solvent. Even the most careful initial cleaning will not remove all carbon deposits; therefore, it is necessary to clean the gun for 3 consecutive days after firing. After cleaning each day, wipe off all cleaning materials and place a light coat of CLP on all metal parts.

If the gun is fired daily, remember that repeated detailed disassembly will cause unnecessary wear. Adequate cleaning can be performed on a gun that has been disassembled into its five main groups. It is essential to perform detailed disassembly only after prolonged firing. Ensure that cleaning materials such as CLP and RBC are not used on the nonmetallic portions of the gun, such as the buttstock. Hot water, rags, and nonabrasive brushes can be used to remove dirt from the nonmetallic portions of the gun.

The M122 tripod should be cleaned to remove all dirt, then a light coat of CLP should be applied, especially to the sleeve and sleeve latch.

### 3603. Normal Maintenance Procedures

Each gun should be cleaned as soon after firing as possible and each time it is exposed to field conditions. In combat conditions the gun should be cleaned and lubricated daily, whether or not it has been fired. If possible, keep the gun covered with a canvas, tarpaulin, or poncho when not in use. During normal training conditions, inspect the gun daily for rust and maintain a light coat of CLP on all metal parts. In ideal conditions, when the gun is not used and is kept in a clean place, it may only be necessary to disassemble and clean it every 3 to 5 days. The gun should be disassembled, cleaned, and lubricated in a clean, dry location where it is least exposed to dirt and moisture.

## 3604. Special Maintenance Procedures

### a. Climatic Conditions

(1) **Cold climates.** In cold climates, the M240G must be kept free of excess lubricants, cleaners, and moisture; all of which can freeze and cause the gun to operate sluggishly. If brought indoors, allow the gun to come to room temperature, wipe completely dry, and lubricate with a light coat of CLP. In temperatures between 10 degrees Fahrenheit (-12 degrees Centigrade) and -10 degrees Fahrenheit (-23 degrees Centigrade), the M240G should be lubricated with CLP, LSA, or LAW. In sustained temperatures below -10 degrees Fahrenheit (-23 degrees Centigrade) use LAW only.

(2) **Hot, humid climates.** In hot, humid climates, inspect more frequently for rust and keep free of moisture. Ensure that the gun is lubricated properly with LSA, LSA-T, or CLP. Generally a heavier application of lubricant is required.

(3) **Hot, dry climates.** In hot, dry climates, sand and dust must be kept from collecting in working parts. Clean the gun daily with CLP. Wipe dry. The teflon coating left by the CLP or LSA-T will be sufficient to keep the parts working smoothly.

**b. Nuclear, Biological, and Chemical Conditions.** If contamination is anticipated, apply lubricant to all outer surfaces of the machine gun (do not lubricate ammunition). Keep the gun covered as much as possible. If the gun is contaminated, decontaminate by following the procedures outlined in FM 3-5, *NBC Decontamination*, then clean and lubricate.

## 3605. Inspection

The gun should be mounted on the M122 tripod and placed on a poncho with the spare barrel case. The exact position of the gun and contents of the spare barrel case may be specified by the inspecting officer or, in his absence, by the unit leader. The T&E mechanism should be centered. The bolt should be forward and the cover raised. Always check for cleanliness,

but also look for broken, missing, or burred parts. Test the spring tension of appropriate parts, and perform appropriate checks to determine if the gun functions properly. The gun should be inspected in an orderly, set sequence so no part is overlooked and no time is wasted. Each inspector will develop the exact sequence, but it may be convenient to first inspect the gun, then the mount. The following is a suggested sequence (only the main points are outlined):

### a. Inspection of the M240G

- Start with the cover. Always look for cleanliness, but also carefully check parts and components for serviceability and proper functioning. Pull the feed arm back and forth to make sure that the fork and pivot arm freely move along with the outer and inner feed pawls. Check for tight spring tension on the feed arm control spring. Push the feed pawls up against the plate to test their spring tension.
- Run your finger over the receiver rails to check for carbon. See if the drive spring is rusted.
- Ensure the weapon is on *F*, pull the bolt all the way to the rear, and release the cocking handle. If the bolt did not remain to the rear, the sear shoulder or sear notch is excessively worn. Next inspect the forward portion of the receiver rails, the face of the bolt, and the chambering ramp in the receiver. Verify that the extractor and ejector are present. Ensure that the bolt moves freely between its locked and unlocked positions.
- Inspect one side of the receiver, then remove the barrel. Examine the barrel socket, chamber, and bore for cleanliness, burrs, and cracks. Make sure the gas plug and collar fit together tightly. To see if the gas system is relatively free of carbon, take it apart and inspect the gas portals on the plug to ensure that they are clear. Inspect the bipod assembly by lowering and raising the legs. Replace the barrel, examine the rear sight, and inspect the other side of the receiver.
- Test the mechanical condition of the trigger-housing group, specifically the safety. With the weapon on *S* and bolt to the rear, pull the trigger; the bolt

should remain to the rear. If the bolt went forward, the safety is defective.

- With the weapon on F and the cover closed, pull the trigger and ride the bolt home slowly by holding the cocking handle. Riding the bolt home slowly will prevent damage to the cam roller and feedtray. Return the gun to its original position (bolt forward, cover raised).

#### b. Inspection of the Mount

- Check the pintle to see that it is attached properly, that the tripod is extended fully, and that the T&E mechanism is not positioned backwards.
- Examine the T&E mechanism. Determine if the scales can be read without difficulty. Manipulate the T&E hand wheel to examine the cleanliness of the far ends of the T&E screws. At the same time, perform a function check by testing for dead clicks. Dead clicks are present when, while turning either hand wheel, the barrel does not move. It means the gears inside the T&E are excessively worn, and the T&E should be replaced. Also, grasp the stock, and gently pull the gun back and forth to test for inordinate play in the M122 mount. Determine if the slide lock lever firmly holds the T&E to the traversing bar.
- Examine the tripod and flex-mount for rust. One particular spot to check is inside the shoes of the tripod legs.
- Inspect the gun bag and spare barrel bag for signs of deterioration and wear. Ensure that the spare barrel bag contains all required SL-3 components, and examine the spare barrel as described above.
- Before moving to another display, make sure the gun is displayed as you found it.

---

### Section 7 Ammunition

---

This section describes the ammunition used with the M240G. Ammunition is issued as complete rounds consisting of the projectiles (bullets), cartridge cases, propellant powder, and primers. Ammunition is issued in a disintegrating metallic split linked belt (see figure 3-51). The members of machine gun teams must

be able to recognize the types of ammunition and know how to care for them.

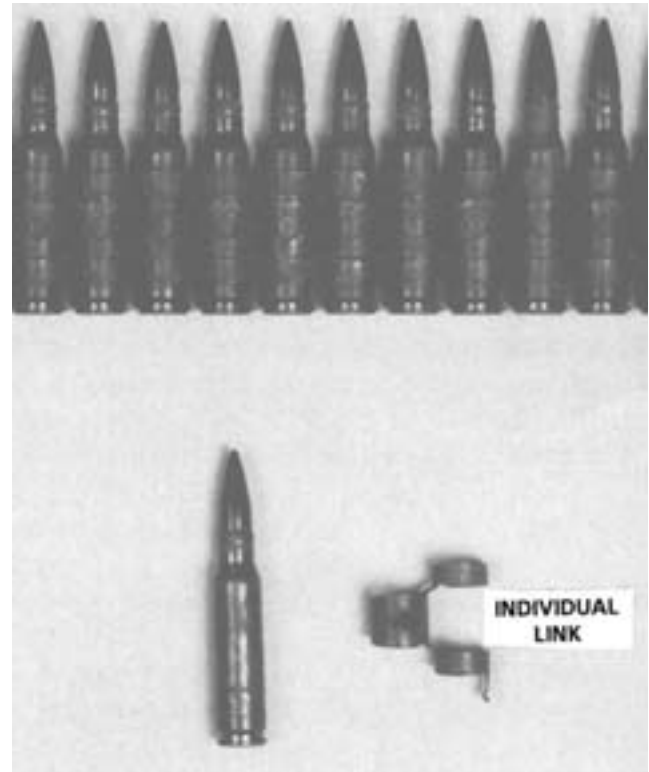

Figure 3-51. Belt of Disintegrating Link Ammunition.

#### 3701. Classification

Ammunition for the M240G is classified as listed:

- Tracer Cartridge.** Used for observation of fire, incendiary effect, signaling, and marking targets.
- Ball Cartridge.** Used against targets of light material, personnel, and during marksmanship training.
- Blank Cartridge.** Used during training when simulated fire is desired.
- Dummy Cartridge.** Used during training, such as gun a drill. It is completely inert, but simulates service ammunition for practice in loading the gun.

e. **Armor-Piercing Cartridge.** Used against lightly armored targets where armor-piercing effects are desired. This ammunition is not authorized for training purposes.

### 3702. Identification

The type, caliber, model, and ammunition lot number, including the symbol of the manufacturer, are necessary for complete identification of small arms ammunition. The 7.62mm NATO cartridge is completely identifiable by its appearance; the painting of the bullet tip, the manufacturer's initial and year of manufacture on the base of the cartridge case, and the markings on the packing containers. When removed from their original packing containers, the cartridges may be identified by the following physical characteristics (also see figure 3-52):

Tracer (M62) . . . . .	Tip of bullet is painted orange.
Tracer (M62 Overhead Fire) . . . . .	Tip of bullet is painted red.
Ball (M80) . . . . .	Plain bullet tip. Full metal jacket on bullet.
Blank (M82) . . . . .	Double tapered neck and no bullet. One-piece metal cartridge from its base to its nose.
Dummy (M63) . . . . .	Six longitudinal corrugations (flutings) on the cartridge. Also, there is no primer or vent hole in the primer pocket.
Armor-Piercing (M61) . . . . .	Tip of bullet is painted black.

### 3703. Ballistic Data

Figure 3-53 shows the armor penetration capability and other ballistic data for the M80 ball round and the M61 armor piercing round. Also see appendix A for further ballistic data.

### 3704. Ammunition Packaging

Ammunition is packaged in a metal box containing two bandoleers. Each box weighs approximately 16 pounds. Each bandoleer contains 100 linked rounds and weighs approximately 7 pounds (see figure 3-54). The bandoleer is made up of a cardboard carton held inside a cloth bag with a carrying strap. Ammunition in the bandoleers may be hooked together and fired from the metal containers, or the bandoleers may be removed for firing.

### 3705. Storage

Store ammunition of all classes away from heat sources; such as open flame, radiators, heaters, and hot water pipes. Ammunition should be stored under cover. If it is necessary to leave ammunition in the open, keep it at least 6 inches from the ground and covered with a double thickness of tarpaulin. Place the tarpaulin so it gives maximum protection and allows free circulation of air. Dig suitable trenches to prevent water from flowing under the ammunition pile.

### 3706. Care, Handling, and Preservation of Ammunition

Ammunition containers should not be opened until the ammunition is to be used. Ammunition removed from the airtight containers, particularly in damp climates, is likely to corrode. Protect ammunition from mud, dirt, and water. If the ammunition gets wet or dirty, wipe it off prior to use. Wipe off light corrosion as soon as it is discovered. Heavily corroded cartridges should be replaced. Use caution during firing to ensure that ammunition is kept out of the dirt. Dirt picked up during firing will act as an abrasive in the chamber and could cause a malfunction that can result in injury to personnel and/or damage to equipment.



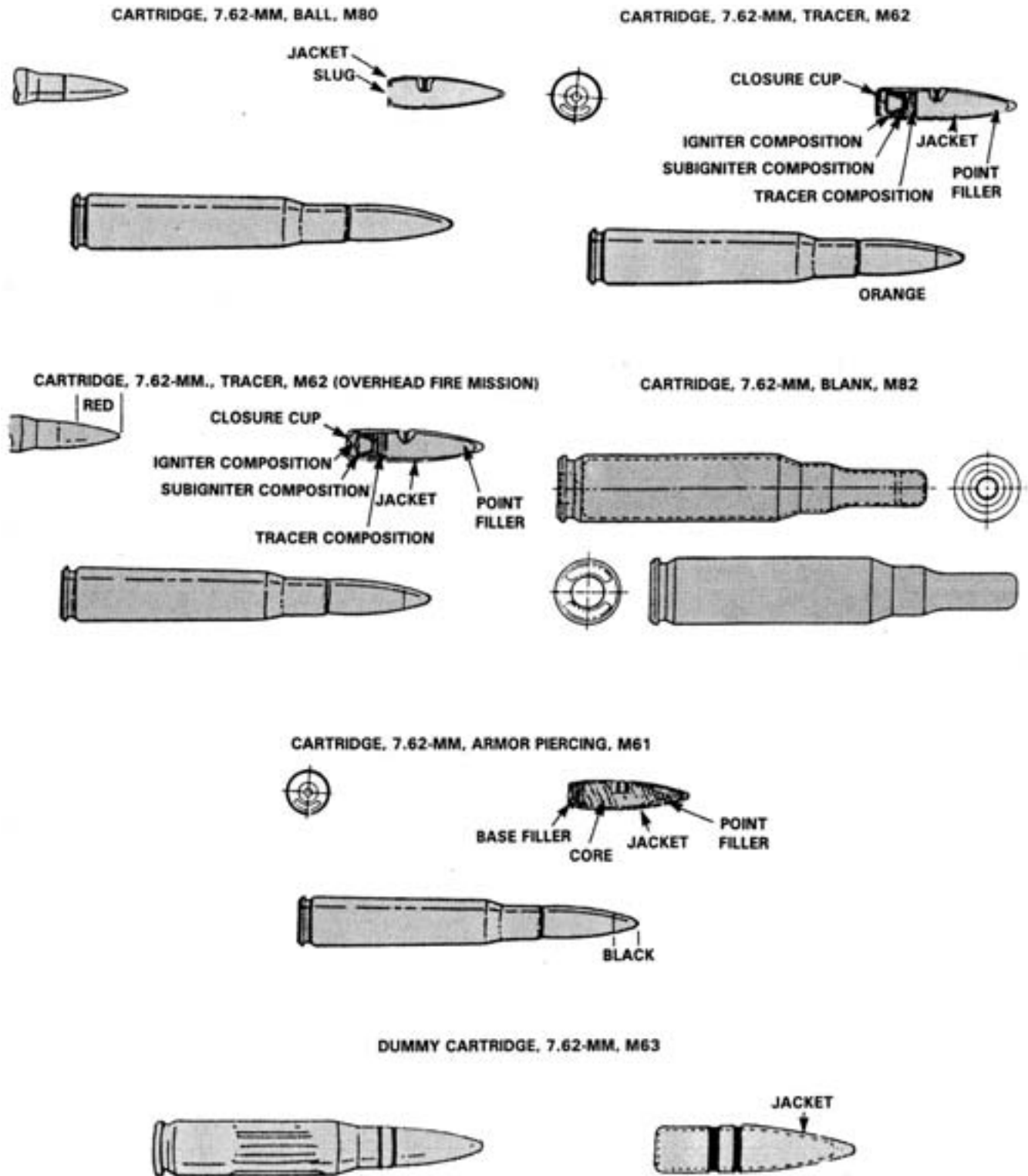

Figure 3-52. Ammunition for the M240G.

	PROJ TYPE	PROJ DIA(MM)	PROJ WT(GM)	M.V. (FPS)	TOF(S) 300M	TOF(S) 500M	TGT MEAN RAD(MIL)	ARMOR PENETRATION (MM)		CARTRIDGE DIMENSIONS		
								300M	500M	L (MM)	D (MM)	WT (GM)
M80	Ball	7.6	9.7	2810	0.42	0.7	0.3	4	3	70	12	25
M61	AP	7.6	9.7	2750	0.42	0.7	0.3	7	5	70	12	25

Maximum range : 4400 meters.

Figure 3-53. Ballistic Data for 7.62mm Ammunition.



Figure 3-54. Issue 100-Round Bandolier.

DO NOT expose ammunition to direct rays of the sun. If the powder is hot, excessive pressure may be developed when the gun is fired.

DO NOT oil or grease ammunition. Dust and other abrasives will collect on it and could damage the operating parts of the gun.

DO NOT fire dented cartridges, cartridges with loose projectiles, or other defective rounds.

DO NOT fire over friendly troops any ammunition graded and marked FOR TRAINING USE ONLY. Only specially approved lots of ammunition can be used for overhead fire. The packaging of this ammunition is clearly stamped FOR OVERHEAD FIRE.

DO NOT fire ammunition (other than blank ammunition) until it has been positively identified by ammunition and grade.

---

## Section 8

### Operation and Firing

---

The M240G fires from the open bolt position to facilitate cooling (see figure 3-55). When the trigger is pulled, the bolt and operating rod start forward. A round is chambered, locked, and fired, all without another action by the gunner. Whenever the bolt is to the rear, the weapon is ready to fire, so ensure the safety is on *S*.

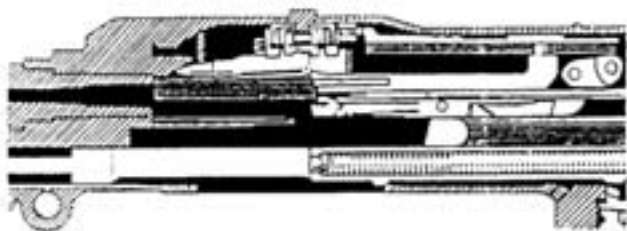

Figure 3-55. Firing From the Open Bolt Position.



Figure 3-56. Opening the Cover.

### 3801. Loading

**a. Raised Cover.** To load with the cover raised, the bolt must be to the rear and the safety lever on *S*. See figure 3-56.

The team leader, who is the assistant gunner, takes a belt of ammunition with the open side of the links down and places the first round against the cartridge stops, aligning it with the feed aperture. See figures 3-57 and 3-58, step 1.

The gunner closes the cover (while the team leader holds the belt to ensure that the first round does not slip away from the cartridge stops) (see figure 3-58, step 2) and places the safety on *F*. The gun is loaded and ready to fire.

**b. Closed Cover.** To load with the cover closed and the bolt forward, the safety must be on *F*.



Figure 3-57. Feed Tray.



Step 1. Aligning the First Round Against the Cartridge Stop.



Step 2. Closing the Cover.

Figure 3-58. Loading, Cover Open.

The team leader takes a belt of ammunition with the open side of the links down and forces the first round into the feedway until the holding pawl engages it and holds it in place. See figure 3-59.

The gunner pulls the cocking handle to the rear and returns the handle forward. The gun is loaded and ready to fire.



Figure 3-59. Loading, Cover Closed.

### 3802. Unloading and Clearing the Gun

**a. Unloading.** Whether or not the belt is expended, unloading procedures are essentially the same: all ammunition must be removed, and the chamber must be checked. The gunner pulls the bolt to the rear (in case all rounds in the belt have been expended), places the weapon on *S*, raises the cover, and the team leader clears the feedtray of ammunition and links. The gunner inspects the chamber by lifting the feedtray (see figure 3-60). If the chamber is clear, unloading is completed.

**b. Clear Gun Procedure.** To ensure the gun is safe, perform the clear gun procedure. This is done after the gun has been unloaded properly and is similar to the unloading procedure.

After the gun is properly cleared, the gunner puts the safety on *F*, pulls the cocking handle to the rear, pulls the trigger, and rides the bolt home. Then the

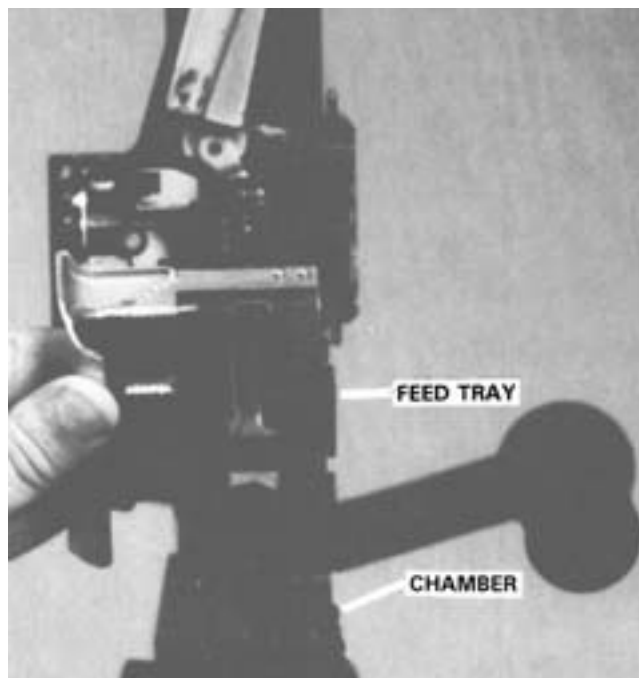

Figure 3-60. Inspecting the Chamber.

gunner pulls the bolt to the rear and returns the safety to *S*.

The team leader runs a cleaning rod down the bore. When the gunner sees the tip of the cleaning rod in the chamber, he sounds off “gun clear,” and the team leader removes the cleaning rod. The gunner then places the gun in a safe position; bolt forward, safety on *S*, and cover raised. The result of properly executing the clear gun procedure is a safe gun.

### 3803. Operation of the Safety

When the safety is on, the cutaway portion of the safety bar is not aligned with the safety lug of the sear. When the trigger is pulled, the sear cannot rotate downward and the operating group cannot move forward. See figure 3-61.

When the safety is placed in the *F* position, the cutaway portion of the safety bar is aligned with the safety lug on the sear. This allows the sear to move downward when the trigger is pulled.

---

#### CAUTION

---

The weapon should NOT be half-cocked. Half-cocking is pulling the bolt to the rear just far enough to engage the safety, then returning the bolt forward. If the bolt is pulled to the rear while the gun is on *S*, the safety will prevent the bolt from being pulled back far enough to lock it to the rear. If the operator inadvertently lets it slip forward again, the drive spring has the strength to send the operating group forward to feed, and then to chamber and fire the next round, even though the weapon must be on *F*, the bolt pulled and LOCKED to the rear, and then the safety engaged in order to prevent inadvertent discharge of the weapon.

---

### 3804. Firing the M240G

**a. Trigger Manipulation.** The trigger is not squeezed as with other small arms; it is pulled to the rear and then released. This enables the gunner to control the number of rounds in each burst and prevents excessive wear to the sear and sear notch. Bursts of less than six rounds should not be fired. The rapid rate of fire of 200 rounds per minute is delivered in bursts of 10 to 12 rounds, which are fired 2 to 3 seconds apart. The sustained rate of fire of 100 rounds per minute is delivered in bursts of six to eight rounds, which are fired 4 to 5 seconds apart.

**b. Firing From the Bipod.** When firing from the bipod, the rear sight is raised. Assume a prone position behind the gun with the right shoulder into the weapon. The right hand grasps the pistol grip and manipulates the trigger. Place the left hand on the comb of the stock, palm down, with the cheek resting lightly against the cover and/or the left hand (see

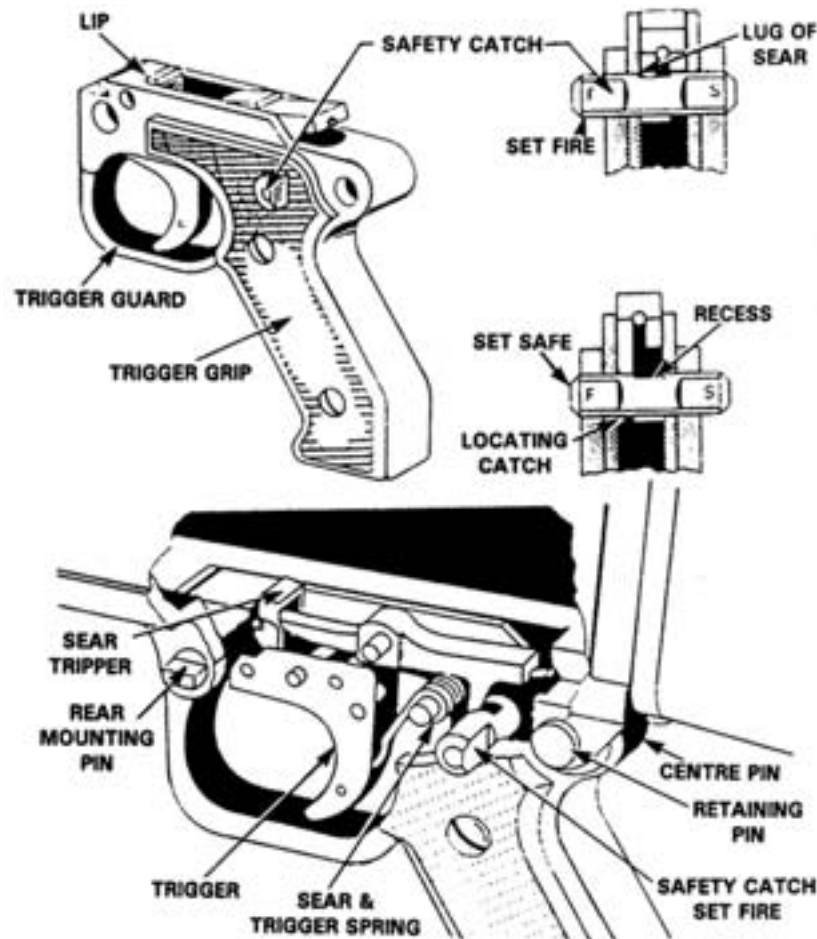

Figure 3-61. Operation of the Safety.

figure 3-62). Both hands exert a firm, steady pressure to the rear during aiming and firing. Unlike the tripod, the bipod mount is relatively unstable (elbows and upper torso may move). A good sight picture must be regained before firing each burst.

(1) **Changing direction.** To manipulate the gun for minor changes in direction (moving the muzzle to the right or left), shift the shoulders and upper torso slightly. The weapon's bipod is mounted on a ball joint, allowing relatively easy minor changes in direction through approximately 45 degrees. To make a major change in direction, the entire body must be moved until it is realigned directly behind the weapon. Thus, rapid, major changes in direction are difficult with the bipod.

(2) **Changing elevation.** To manipulate the gun in elevation (moving the muzzle up or down), move the elbows closer together or farther apart.

c. **Firing From the Tripod.** When firing from the tripod, the rear sight is lowered. Assume a prone position behind the gun with the right shoulder into the weapon. Manipulate the trigger with the right hand and the T&E with the left. Exert a steady rearward pressure during firing with both hands (left hand on the elevating hand wheel, palm down).

(1) **Firing.** Point the muzzle of the gun in the general direction of the target by releasing the slide lock lever and pulling the T&E along the traversing bar. Secure the slide lock lever and raise the rear sight.



**Figure 3-62. Bipod Position.**

Place the estimated range on the rear sight, and manipulate the gun until there is a good sight picture. The assistant gunner then lowers the rear sight and begins firing. Unlike the bipod, the M122 tripod provides a stable base and controlled manipulation, making the use of the sight not only redundant, but it also blocks the gunner's view of the target and impacting rounds.

**(2) Manipulation.** All manipulation is accomplished by turning the two hand wheels with the left hand. If both direction and elevation changes are required to engage a target, manipulate direction first, then elevation.

- To traverse, place the left hand on the traversing hand wheel, thumb up. To move the muzzle to the right, the gunner pushes away with the thumb: PUSH RIGHT. To move the muzzle to the left, the gunner pulls to the rear with the thumb: PULL LEFT.
- To search, rest the left hand on the elevating hand wheel. To move the muzzle up, the gunner pushes away with the thumb: PUSH UP. To move the muzzle down, the gunner pulls to the rear with the thumb: PULL DOWN.

### **NOTE**

The key words, or thumb rule, are similar to those used in reading map coordinates. They are PUSH RIGHT UP. Push on the traversing hand wheel to go right, and push on the elevating hand wheel to go up.

### **3805. Change Barrel Procedures**

The ability to change the barrels of the M240G quickly provides a great advantage. It allows one barrel to be used while the other is cooling. This increases the life of each barrel and ensures a continuous rapid rate of accurate fire. Barrels should be changed when they are beginning to overheat. Changing a barrel only takes a few seconds and significantly improves the rate of fire and accuracy. As a guide, a barrel change is required after firing the sustained rate for 10 minutes and after firing the rapid rate for 2 minutes. The procedures outlined below are for a tripod-mounted gun; however, they are very similar to those for a bipod-mounted gun.

The barrel can be changed with the bolt forward or to the rear. The weapon does not necessarily need to be unloaded; however, it must be placed on *S* when the

bolt is to the rear. The gunner depresses the barrel-locking latch with his left hand and keeps his hand at that position (see figure 3-63). The team leader grasps the barrel by the changing handle, rotates it to its upright position, pushes forward and pulls up, separating the barrel from the receiver. He then grasps the spare barrel by the changing handle, and with the gunner again depressing the barrel locking latch, inserts the barrel socket into the receiver, aligns the gas plug with the gas cylinder, and pulls to the rear until the barrel is fully seated. The gunner then releases the barrel release latch. Once the barrel is fully seated, the team leader lowers the barrel-changing handle, counting the clicks (minimum two, maximum seven) to ensure proper headspace.

---

## Section 9 Gun Drill

---

A gun drill gives team members training in machine gun operation and can help develop confidence in their ability to put the machine gun into action with precision and speed. Rotation of duties during training ensures that every member becomes well trained in each position. Precision is obtained by strict adher-

ence to prescribed procedures. Speed is acquired after precision has been developed. Leaders must remember that a gun drill is simply a means of improving crew functioning. It is not an end in itself.

The machine gun squad consists of a squad leader and two 3-man machine gun teams. Each team operates one M240G and is composed of a team leader, a gunner, and an ammunition bearer.

A gun drill, as discussed here, is limited to the squad leader and one machine gun team (team leader, gunner, and ammunition bearer). Of course, the squad leader may conduct a gun drill for both of his teams simultaneously and the section leader may do likewise for two or all three squads.

### 3901. Crew Equipment

In addition to their individual arms and equipment, machine gun team members carry the following:

- The squad leader carries the binoculars and compass.
- The team leader carries the tripod and one box of ammunition.



**Figure 3-63. Changing Barrels.**



- The gunner carries the machine gun with one bandoleer of ammunition.
- The ammunition bearer carries the spare barrel case, flex-mount with T&E mechanism, and one box of ammunition.

### 3902. Form for Gun Drill

The squad leader commands **FALL IN**, and the team forms on line with five paces between team members (see figure 3-64). The team leader repeats all commands. The squad leader then gives the command **TAKE EQUIPMENT**. Team members take one step forward and pick up their equipment. The squad leader commands **FORM FOR GUN DRILL**. The team forms in a column with five paces between men. The team leader is five paces from, and facing, the squad leader. Team members assume the prone position. See figure 3-65.

### 3903. Examination of Equipment Before Firing

A thorough examination of equipment is made before each exercise. After the team is formed, the squad leader commands **EXAMINE EQUIPMENT**. At this

command, each team member examines his equipment as explained in the following paragraphs:

**a. Team Leader Examination.** The team leader examines his ammunition first. (Linked dummy ammunition should be used for this training.) To do so, he opens the can, releases the cloth flaps, and pulls out the cardboard flaps of the bandoleer. He ensures that the ammunition is properly linked, free of dirt and corrosion, and that the double link is up and ready for loading. Ammunition belts should not be removed from the bandoleer for examination. After he examines the ammunition, he reinserts the cardboard flaps in the bandoleer, closes the cloth cover, puts it back in the ammunition can and closes its cover. He places the ammunition to his left. He then examines the tripod. He assures that the legs are folded closely together and, with his right hand, checks the sleeve latch to ensure that it has tension and will function. This completes his examination of equipment.

**b. Gunner Examination.** Remaining in the prone position, the gunner first examines his ammunition as did the team leader. The gunner then examines his gun. He pulls the bolt to the rear, places the safety on S, raises the cover, and checks the chamber to ensure that the gun is clear. He crawls forward to the front of



Figure 3-64. Team Formed on Line With Equipment.

the gun and looks through the barrel to ensure that the bore is clean. The gunner then checks the flash suppressor for cracks and the front sight for tightness and damage to the blade. Next, he checks the gas system, ensuring the collar is properly affixed to the plug. He checks to ensure that the barrel-changing handle moves freely. He ensures that the feed arm, pivot arm, and feed arm fork move freely and are properly lubricated. He pushes on the feed pawls to ensure they have spring tension. He lowers and latches the cover, places the safety on F, and pulls the trigger, riding the bolt forward. He sets the rear sight on 500 meters. This completes the gunner's examination of equipment. He resumes his position parallel to the gun with his head in line with the feedway.

**c. Ammunition Bearer Examination.** Remaining in the prone position, the ammunition bearer begins by examining the ammunition as did the team leader. He then removes the flex-mount from the spare barrel case and inspects the T&E mechanism. He centers the

elevating hand wheel so that about 1 1/2 inches of thread are exposed above and below the hand wheel. He then centers the offset head. He checks the locking lever on the traversing slide to ensure that it moves freely. He also inspects the rest of the flex-mount ensuring that the locking pin is present and that the pintle is clean and free of burrs. The ammunition bearer removes the spare barrel from its case and performs the same checks listed for the gunner. He also checks the barrel socket to ensure its cleanliness. The ammunition bearer has completed his examination of equipment when he returns the spare barrel and flex-mount to the spare barrel case. He checks the accessory pocket to ensure the required SL-3 components are present.

**d. Report of Examination.** Upon completion of the examination of equipment, discrepancies that cannot be corrected by the individual team member will be reported to the squad leader. If there are no discrepancies, each team member reports as follows:



**Figure 3-65. Team in Prone Position.**

- The ammunition bearer reports **AMMUNITION BEARER CORRECT**.
- The gunner reports **AMMUNITION BEARER AND GUNNER CORRECT**.
- The team leader reports **ALL CORRECT**.

### 3904. Placing the Gun into Action

To place the gun in action, the squad leader gives the command **GUN TO BE MOUNTED HERE, FRONT, ACTION**.

The team leader rises to his feet, grasps the right leg of the tripod near the tripod head with his right hand, and grasps the ammunition box with his left hand. He rotates the tripod onto his right hip, left leg up, and moves forward to the gun position. See figure 3-66.

On arrival at the gun position, the team leader places his ammunition to his front so that it will be approximately on line with the tripod head when the tripod is opened. He kneels on his right knee and rests the shoes of both tripod legs on the ground with the

mount in a vertical position. Steadying the mount with his right hand near the tripod head, he raises the front leg with his left hand. He grasps the right leg shoe with his right hand, the left leg shoe with his left hand, and raises the tripod to a vertical position, chest high. He separates the tripod legs with a quick jerk, ensuring the sleeve latch engages, locking the tripod in its open position (see figure 3-67). He then places the tripod on the ground with the front leg pointing in the direction of fire. He rises to his feet and stamps the rear legs into the ground. He then assumes a prone position on his left hip at the left of the tripod.

The ammunition bearer times himself to arrive at the gun position at the time the team leader assumes his position. He rises, takes the spare barrel case by the handle with his right hand and the ammunition box with his left hand, and moves up to the gun position. On arrival at the gun position, he removes the flex-mount from the spare barrel case and hands it to the team leader, who immediately inserts the pintle into the pintle bushing and locks it down (see figure 3-68). The



Figure 3-66. Team Leader Moving to Position.



**Figure 3-67. Extending the Tripod.**

team leader then lowers the traversing slide over the traversing bar of the tripod, centers it on the 0 graduation line of the traversing bar, and locks it down. While the team leader is affixing the flex-mount to the tripod, the ammunition bearer places the spare barrel case

approximately on line with where the muzzle of the gun will be when it is mounted, and places the ammunition box one pace to the left and on line with the spare barrel case. He then opens the spare barrel case, takes the spare barrel out, and places it on top of the case with the muzzle pointing down range and the sight toward the gun. Then the ammunition bearer turns and moves to the flank to provide security.

The gunner times himself to arrive at the gun position as the team leader receives the flex-mount from the ammunition bearer. He rises to his feet, grasps the barrel changing handle in his right hand and his bandoleer of ammunition in his left hand. He moves forward to the gun position and places his ammunition to the left of the tripod. He slides the recesses in the receiver into the mount's forward bushings, rotates the gun down into position on the rear of the mount and inserts the locking pin to secure the gun to the mount (see figure 3-69). The gunner assumes the prone position and, when ready to fire, reports UP to the team leader who reports UP to the squad leader (see figure 3-70).

#### **NOTE**

Live ammunition is *never* used while conducting the gun drill.



**Figure 3-68. Team Leader Mounting the Flex-mount.**



**Figure 3-69. Gunner Mounting Gun.**



**Figure 3-70. Gun Team Ready to Fire.**

### 3905. Barrel Change

When the team leader has reported UP, the squad leader commands **CHANGE BARREL**.

If the bolt is to the rear, the gunner places the weapon on *S*. The gunner depresses the barrel-locking latch, keeping his hand on the barrel release latch throughout the barrel change.

The team leader grasps the barrel-changing handle and removes the barrel from the machine gun. He places it on the deck to the left of the spare barrel case. The team leader grasps the spare barrel by the changing handle and inserts it into the gun. The gunner depresses the barrel-locking latch to assist the team leader in securely seating the barrel. He then places the safety on *F*, and resumes his firing position. The team leader reports **UP** to the squad leader.

### 3906 Taking the Gun Out of Action

At the squad leader's command **OUT OF ACTION**—

- The gunner raises the cover and inspects the receiver and chamber to ensure they are clear, closes the cover, pulls the trigger, and places the safety on *S*. The team leader secures his ammunition.
- The gunner removes the locking pin from the flex-mount, elevates the rear of the gun, and removes it from the mount. He lowers the rear sight, grasps the carrying handle with his right hand, raises the gun, and rises to his feet. Grasping the ammunition with his left hand, he pivots to his right, and he returns to his original position. The team leader unlocks the traversing slide, unlocks the pintle latch, and removes the flex-mount from the tripod. The ammunition bearer times himself to arrive at the gun position before the team leader removes the flex-mount. The ammunition bearer places the spare barrel in its case, receives the flex-mount from the team leader, and places it in the spare barrel case. He closes the spare barrel case, grasps it

with his right hand, grasps the ammunition box with his left, and returns to his original position.

- The team leader rises, grasps the tripod near its head, and rotates it up onto his right hip so that the left tripod leg is uppermost. He grasps his ammunition with his left hand, turns to his left, and returns to his original position. He places his ammunition on the deck and drops to his right knee. He places the tripod in a vertical position with the rear shoes on the deck, supporting the tripod with his right hand near its head. He reaches up with his left hand and lowers the front leg. Sliding his right hand down the right leg of the tripod, he releases the sleeve latch. He grasps the left leg near the shoe with his left hand and closes it to the right. He lowers the tripod to the deck with its head to the front, and he assumes the prone position and reports **UP**.

### 3907. Rotation

Duties are rotated during a gun drill to ensure that all members of the team can perform all duties within the team. To rotate duties, the squad leader commands **FALL OUT SQUAD LEADER**. At this command the team members rise and move up one position. When the team members move, the members assume their new positions and call out their new duties in order: **AMMUNITION BEARER, GUNNER, TEAM LEADER, SQUAD LEADER**.

---

## Section 10 Qualification Firing

---

After machine gunners become proficient in mechanical training and gun drill, they fire the 12.7-meter qualification course. Machine gunners learn the fundamentals of marksmanship, their position and grip, and 12.7-meter zeroing. They become familiar with the operation and noise of the M240G during firing. Qualifying on the 12.7-meter course instills confidence in the gunner's ability to effectively operate their machine guns.

### 31001. Fundamentals of Marksmanship

**a. Accurate Initial Burst.** Obtaining an accurate initial burst of fire on the target is fundamental to good marksmanship. This is accomplished by correctly estimating the range to the target, by correctly setting the sights on the machine gun, and by properly laying the gun with the T&E mechanism. After the estimated range has been set on the rear sight, the machine gun is manipulated until the line of aim intersects the target at its center base.

**b. Adjustment of Fire.** Adjustment of fire is another fundamental of good marksmanship. The team leader and the gunner observe the strike of the bullets when the initial burst is being fired. If it is not on target, the gun is manipulated until the bullets hit the target.

**c. Mechanical Skill in Manipulation.** Mechanical skill in manipulation is required to engage targets that have depth or width. Skill in the use of the T&E mechanism will be gained from practice. When both traverse and search are necessary, the traverse is accomplished first. One click of either the traversing or elevating hand wheel moves the muzzle of the gun 1 mil. To traverse the weapon, the gunner places his left hand on the traversing hand wheel with his thumb uppermost. To move the barrel of the machine gun to the right, the gunner pushes his thumb up and away from himself. To move the gun to the left, he pulls his hand down. Having traversed the gun, the gunner moves his left hand to the elevating hand wheel, placing it on top of the hand wheel with his thumb to the rear. In order to elevate the weapon, the gunner turns the hand wheel counterclockwise, moving his thumb to the right. To depress the gun, the gunner turns the hand wheel clockwise, pulling his thumb back toward himself. Proper mechanical manipulation of the machine gun can be remembered by the phrases **PUSH RIGHT UP, PULL LEFT DOWN.**

**d. Speed.** Speed is a basic fundamental of good marksmanship. It is attained by practice and a thorough understanding of the other fundamentals of

machine gun marksmanship. Speed should not be stressed to the detriment of accuracy, adjustment, or skill in manipulation.

### 31002. Position and Grip

**a. Gunner.** The gunner is in a prone position to the rear of the gun with his right shoulder against the butt stock group. A straight line extending through the barrel and receiver passes through his right shoulder and hip. His legs are comfortably spread, and his heels are down (if possible). The gunner's left hand grasps the elevating hand wheel, palm down. His right hand is on the grip with his index finger on the trigger. The gunner exerts a firm pressure to the rear with both hands while aiming and firing. His cheek rests against the cover. Breath control is practiced during aiming and firing.

**b. Team Leader.** The team leader assumes a prone position on his left side to the left of the gun. His head and eyes are even with the feedway. He loads, unloads, and changes barrels from this position.

### 31003. Sight Setting and Battlesight Zero Procedures.

The sights of the M240G are rugged and reliable. When setting battlesight zero (BZO), all adjustments (windage and elevation) are made to the front sight assembly. The advantage of this system is that it allows each spare barrel to be individually zeroed to the machine gun and then locked down with the adjustment tools. This avoids accidental loss of zero through inadvertent manipulation during cleaning or inspections. BZO is normally established at 12.7 meters in preparation for qualification firing as described in this reference (see paragraph 31104). The upper row of aiming points (A-D) on the qualification target is designed for this purpose (see figure 3-71). However, any point of aim–point of impact type of target can be used as a field expedient, (e.g., the M16A2 BZO target).

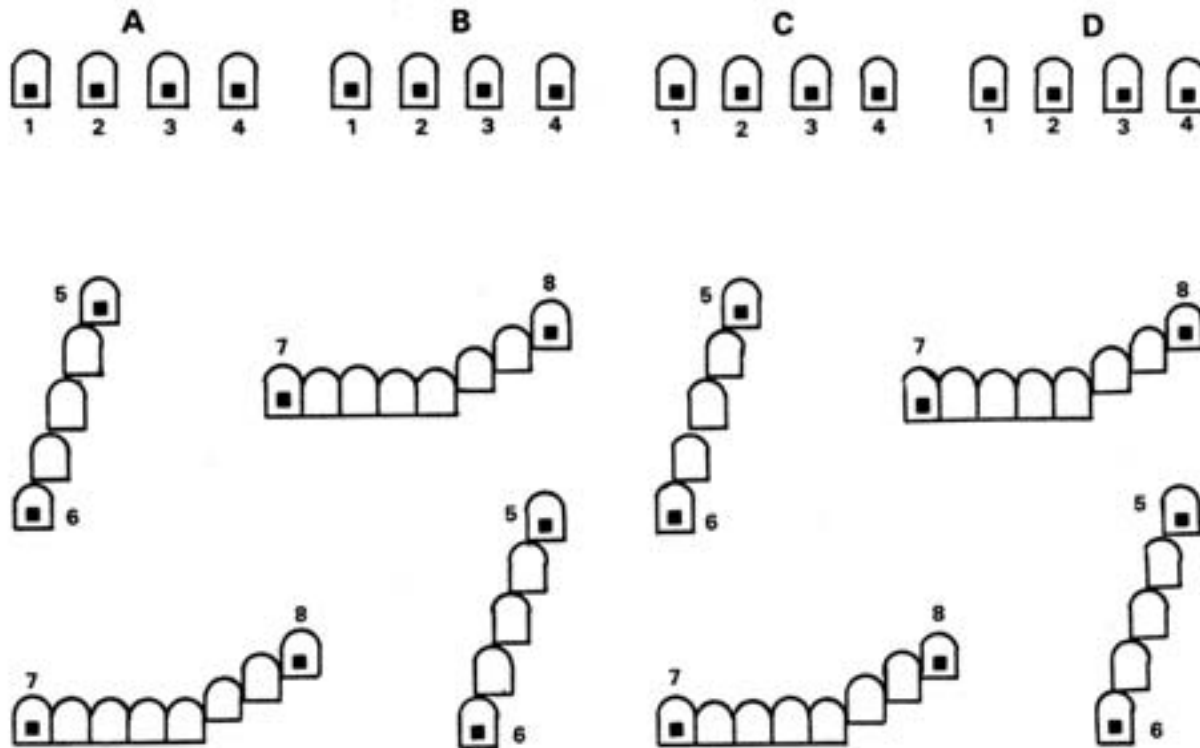

Figure 3-71. Basic Machine Gun Qualification Target.

The combination front sight-adjusting tool is used for elevation and windage adjustments (see figure 3-72). This tool unlocks the front sight blade-retaining strap and has a special slotted end piece to turn the front sight blade for elevation changes. In addition, a hex wrench is included on another section of the tool. This hex wrench is designed to turn the socket head windage adjustment screws; however, it should not be used for this unless it fits the socket heads of the windage screws tightly.

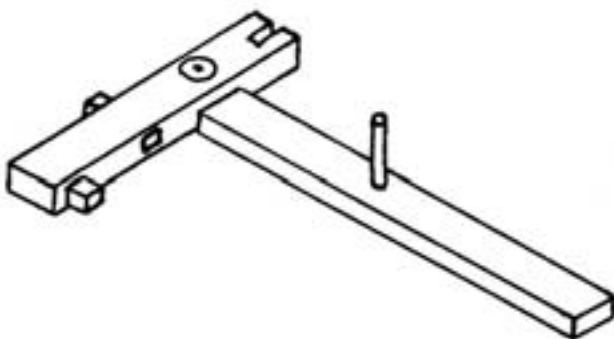

Figure 3-72. Combination Front Sight Adjusting Tool.

**a. Adjusting for Elevation BZO.** For the initial firing groups, do not unlock or change the elevation setting of the front sight post. Begin with the front sight post set at the position in which it is delivered. Set the rear sight elevation at 500 meters. With a target at 12.7 meters, first correctly align the sights (see figure 3-73), then hold a tight/well-supported point of aim, point of impact sight picture (see figure 3-74) and fire three rounds, one round at a time, taking time to realign the sight picture between shots.

If the shot group is above or below the aim point, the front sight needs adjustment. The combination tool is used to unlock the front sight retaining strap (see figure 3-75). Unlock the retaining strap and rotate it upward. The front sight post is now free to rotate. Apply two to three drops of lubricant (CLP, LSA, or LSA-T) around the base of the front sight to lubricate the threaded shaft of the front sight post. This will make it easier to rotate.

#### NOTE

The following sight adjustments are given from the gunner's perspective at the rear of the machine gun with the individual in a normal firing position or positioned above the gun.





Figure 3-73. Correct Sight Alignment.

If the shot group is above the aim point, rotate the sight post counter-clockwise as if it were being unscrewed. If the group is below the aim point, rotate the sight post clockwise as if it were being screwed in or down.

#### NOTE

Rotating the front sight post counterclockwise brings the point of impact down on the target, while rotating the front sight post clockwise brings the point of impact up on the target.

At a range of 12.7 meters, one half turn of the post blade, will move the strike of the bullet by approximately 1/5 of an inch (5mm). One full turn of the post blade will move the strike of the bullet by approximately 3/8 of an inch (10mm). After rotating the post



Figure 3-74. Correct Sight Picture.

blade the required amount, lower the retaining strap, but do not lock it down until the BZO elevation is confirmed. Continue the above procedure until the elevation BZO is confirmed. If the post blade is required to be rotated counterclockwise to a point where its base is more than half way out of the assembly, it should be replaced with a Number 2 front sight blade which is taller than the Number 1 or normal sight. Once BZO elevation is confirmed, lock the retaining strap down to its detent.

#### b. Adjusting for Windage BZO

As above, fire a group(s) to determine if a windage adjustment is required. If the group is to the left of the point of aim, the front sight protector assembly must be moved to the left to shift the point of impact to the right (towards the point of aim). If the group is to the right of the point of aim, the front sight protector must

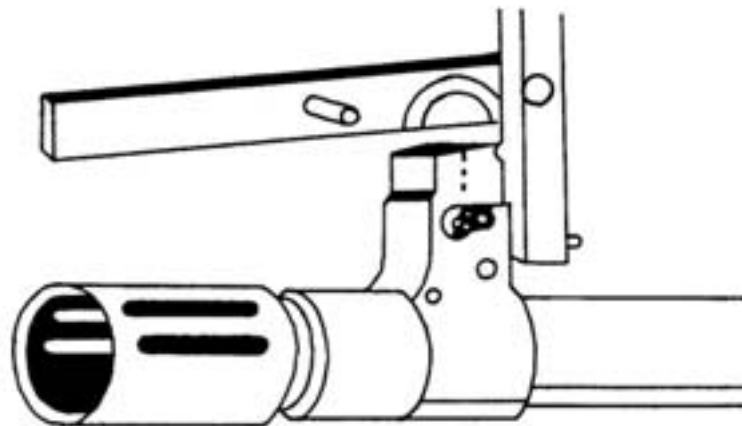

Figure 3-75. Unlocking the Front Sight Retaining Strap.

be moved to the right to shift the point of impact to the left (towards the point of aim).

### NOTE

Moving the front sight post to the right moves the strike of the projectile to the left on the target. Moving the front sight post to the left moves the strike of the projectile to the right on the target.

To move the group to the left, use a tight fitting hex wrench to loosen (turn counterclockwise) the adjusting screw on the right side of the front sight assembly the desired amount. Then tighten (turn clockwise) the opposite side screw (the one on the left side) *exactly* the same amount. At a range of 12.7 meters, one complete rotation (360 degrees) of the adjusting screws will move the point of impact approximately 1/3 inch (8mm). As the adjusting screws are turned, noticeable clicks (eight per revolution) should be detected. If this is not the case, an armorer should replace the protector assembly or the detente spring.

---

### CAUTION

---

The windage adjustment screws will break with the slightest over torquing. Be careful not to over tighten the adjustment screws.

---

To move the group to the right, loosen (turn counterclockwise) the adjusting screw on the left side of the front sight assembly the desired amount. Then tighten (turn clockwise) the opposite side screw (the one on the right side) exactly the same amount. At a range of 12.7 meters, complete rotation (360 degrees) of the adjusting screws will move the point of impact approximately 1/3 inch (8mm).

### NOTE

The front sight windage adjustment procedure is the combination of creating slack on one side, and then taking up that slack from the opposite side. Therefore, the front sight protector assembly should always be clamped tight between the heads of the two opposing screws.

Each time one screw is loosened, the opposite one must be tightened *exactly* the same amount.

Once the shot group is confirmed to be centered, check for play in the front sight assembly by lightly clamping between finger and thumb and attempting to move the sight assembly laterally. If there is no play evident, the windage adjustment is completed. If play is evident, carefully check both screws for looseness.

The 12.7-meter qualification course is fired with the BZO established as above with the rear sight set for 500 meters. Since the BZO procedure above calibrates the rear sight for all targets within the effective range of the machine gun, the estimated range to any other target should be placed on the rear sight and a good sight picture obtained before firing.

If confirmation of the BZO is desired, this is easily done from the 200- or 300-meter line at a rifle range to disk the target shot group once it is fired. When firing, set the range on the rear sight and mount the weapon on the tripod or use a good field firing position with the bipod. If the dispersion of the shot group is too large to calculate the mean center of impact, load and fire one ball round at a time. Note that wearing a flak jacket or gas mask by the gunner may change the mean point of impact.

If firing confirmation zero on a range laid out in yards, do not be overly concerned if the point of impact is slightly above the point of aim, as the beaten zone of a normal burst will cover most targets. If a large number of very distant targets is to be attacked, using ranges estimated in meters taken from a map or range finder, add yards to meters elevation change to the front sight in, or clockwise, one-half turn. This is especially true if shot groups are just slightly low on a target at 200 or 300 yards. If this is the case always add the one-half turn yards to meters elevation change.

At 200 meters, one-half turn of the front sight blade, in either direction, moves the point of impact up or down approximately 4 1/4 inches (108mm). At 200 meters, one-half turn (four clicks) of the windage screws will move the point of impact left or right approximately 3 1/8 inches (80mm).

### 31004. 12.7 Meter (500 Inch) Firing

In 12.7 meter firing, the gunner familiarizes himself with the weapon. These firing exercises teach the gunner the fundamentals required to achieve the primary goal of every machine gun team, which is an accurate initial burst on target each time they open fire. These fundamentals include position and grip, sight alignment and sight picture, and proper trigger manipulation. The exercises also teach the importance of proper zeroing techniques, and the techniques required to properly manipulate the T&E mechanism for accurate searching and traversing fire. Finally, after completion of practice firing exercises, gunners are given the opportunity to qualify with the M240G. These exercises/qualification firings will only be conducted upon completion of all non-live fire training/exercises.

**a. Practice Firing.** This exercise familiarizes the gunner with the firing characteristics of the machine gun, manipulation of the T&E, and introduces him to the strings of fire that will be utilized for qualification. There are no time limits on any of the strings of fire during practice.

**(1) Conduct of fire.** The unit is organized based on the constraints of the range to be used. The following actions are accomplished prior to commencing the practice firing exercise:

- After the conduct of a safety brief applicable to the range to be used, a gunner and assistant gunner are assigned to each firing position to be used. They then set up their guns and perform pre-firing checks.
- Next, each gunner is issued 3 single rounds, 1 belt of 3 rounds, 4 belts of 6 rounds each, 2 belts of 48 rounds, and 1 belt of 30 rounds, for a total of 156 rounds.
- The gunner then zeroes his machine gun, using the three single rounds, firing three rounds on paster 1 to establish his zero and a three round burst on paster 2 to confirm his zero. Section A of the target is normally used for zeroing. The gunner will not continue until zeroing has been mastered.

- Once zeroing is complete, the gunner is ready to commence practice firing.

**(2) First string.** The first string of fire will utilize pasters 1 through 4 in sections B, C, or D. These are fixed-fire pasters, with no manipulation of the T&E conducted other than to obtain proper sight alignment and picture before firing the 6-round burst. A 6-round belt is loaded and fired at each fixed-fire paster. To engage these pasters, the following commands are given:

**WITH A 6-ROUND BELT, LOAD, PASTER NUMBER 1 (2, 3, OR 4), 500, FIXED, 6-ROUND BURST, AT MY COMMAND, FIRE.**

**(3) Second string.** The second string of fire utilizes pasters 7 to 8 and requires proper mechanical manipulation of the machine gun. A 48-round belt is loaded and fired at these pasters. The gunner aims at paster 7 and fires his initial 6-round burst; he then traverses two clicks right, and fires another 6-round burst, repeating this traversing action four times. The next three squares require traverse and search manipulation, two clicks right and one click up, after each 6-round burst, ending the string of fire on paster number 8. To engage pasters 7 to 8, the following fire command is given:

**WITH A 48-ROUND BELT, LOAD, PASTER NUMBER 7, 500, TRAVERSE AND SEARCH, 6-ROUND BURSTS, AT MY COMMAND, FIRE.**

**(4) Third string.** A 30-round belt is loaded and fired at pasters 6 through 5. The gunner aims at paster 6 and fires his initial 6-round burst; traversing and searching manipulation is then required for subsequent bursts, one click left and two clicks down after each 6-round burst. He repeats this action four times, ending the string of fire on paster 5. The fire command is—

**WITH A 30-ROUND BELT, LOAD, PASTER NUMBER 6, 500, TRAVERSE AND SEARCH, 6-ROUND BURSTS, AT MY COMMAND, FIRE.**

**b. Timed Firing Practice.** This is a timed exercise to practice operating the weapon with greater speed and

to prepare for the timed strings of fire that will be encountered in qualification. It should be fired immediately following the practice firing exercise. A time limit of 30 seconds per square is allotted for each string of fire to engage pasters 1 through 4. A total time of 60 seconds is allotted to engage pasters 6 through 5, and a total time of 60 seconds is allotted to engage pasters 7 through 8. The gunner fires a total of 150 rounds for this exercise (24 rounds for 1-4, 96 rounds for 7-8, and 30 rounds for 6-5).

**c. Qualification Firing.** Qualification utilizes the same strings of fire outlined above in practice firing, with the additional requirement to zero the weapon. There are a total of 156 rounds fired in the 12.7 meter qualification course, including zeroing. The 1 through 4, 7 through 8, and 6 through 5 strings of fire are scored for qualification. One point is scored for each bullet hole in a scoring square up to a total of six holes per square. A bonus of two points is awarded for hitting any scoring square. Thus, a gunner may receive a maximum of eight points per square, (six points for six hits plus two bonus points). A bullet hole on the line between two squares may be counted in either square, but not in both squares. It should be scored in the square which will give the higher score. Pastors 1 through 4 may receive a total of 24 points (4 scoring squares with a total possible point value of 8 points per square). Pastors 7 to 8 may receive a total of 64 points (8 scoring squares with a possible total point value of 8 points per square each). Pastors 6 to 5 may receive a total of 40 points (5 scoring squares with a possible total point value of 8 points per square). The total possible score for the 12.7 meter qualification course is 200 points (counting 6 zeroing rounds).

The following classifications may be achieved by machine gunners:

Points	Classification
150 and over	Expert gunner
130 through 149	First class gunner
105 through 129	Second class gunner
104 and below	Unqualified

---

## Section 11

### Firing With Blank Ammunition

---

The ability to fire blank ammunition adds realism to nonlive fire training. The M240G can be configured to fire standard M82, 7.62 mm, NATO, blank-linked cartridges. An MK 164 MOD 1 blank firing adapter (BFA) must also be installed before using M82 blank ammunition. When the M240G is fired without a BFA, propellant gases exit out of the muzzle. Unlike live rounds, which can allow high pressures to build behind the exiting round, blank rounds use a reduced powder charge and will exit quickly through an open barrel. When the M240G loses propellant gas, it will fail to properly cycle and chamber the next round, and it will not fire more than one blank without the operator manually cycling the weapon. The BFA captures the propellant gases released by the blank cartridge's firing and use them to cycle and fire the follow-on rounds until pressure is released from the trigger.

#### 31101. Safety

Prior to installing a BFA on an M240G, the operator must ensure that he has cleared the weapon and that there are no live rounds present. See paragraph 3201a for clearing procedures. Once it is established that the weapon is safe, the BFA can be installed.

---

#### CAUTION

---

Live ammunition or any other type of ammunition different from the M82 blank should NEVER be used when the weapon is equipped with the BFA.

---

#### 31102. Inspection

Before installing the BFA, it must be inspected for cleanliness and service-ability (see figure 3-76). The BFA should be free from cracks or damage and that the locking bolt is present and turns freely within the threads. The locking bolt head is serviceable and capable of being hand tightened with a 3/4" wrench. The discriminator assembly is free of cracks or

warpage. The wire lead is not frayed or detached from either the discriminator assembly or the BFA.

### 31103. Assembly

Install the BFA over the flash hider on the M240G barrel. Hand tighten the locking bolt until a snug fit is achieved, then tighten securely with a 3/4" wrench. Next, insert the discriminator assembly into the feed tray. Ensure that the wire lead from the discriminator assembly is securely attached to the BFA. See figure 3-77.

### 31104. Operation

Once the BFA is properly installed, the M240G can be loaded and operated with M82 blank ammunition. Do not use the M240G's regulator setting #3 once the BFA is installed. If regulator setting #3 is used, the M240G jams. Also, since propellant gases can injure other personnel, do not operate the M240G if personnel are within 12.7 meters of the

M240G. Periodically check to ensure that the locking bolt is tight, as it may loosen during firing and cause the M240G to jam.

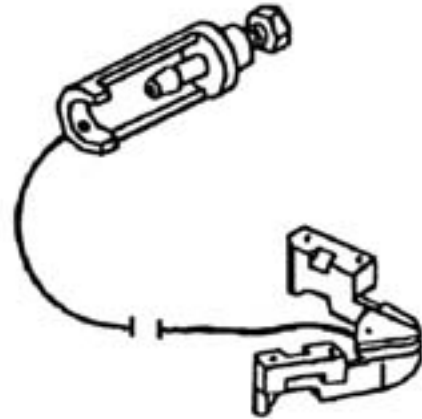

Figure 3-76. Blank Firing Adapter Assembly.

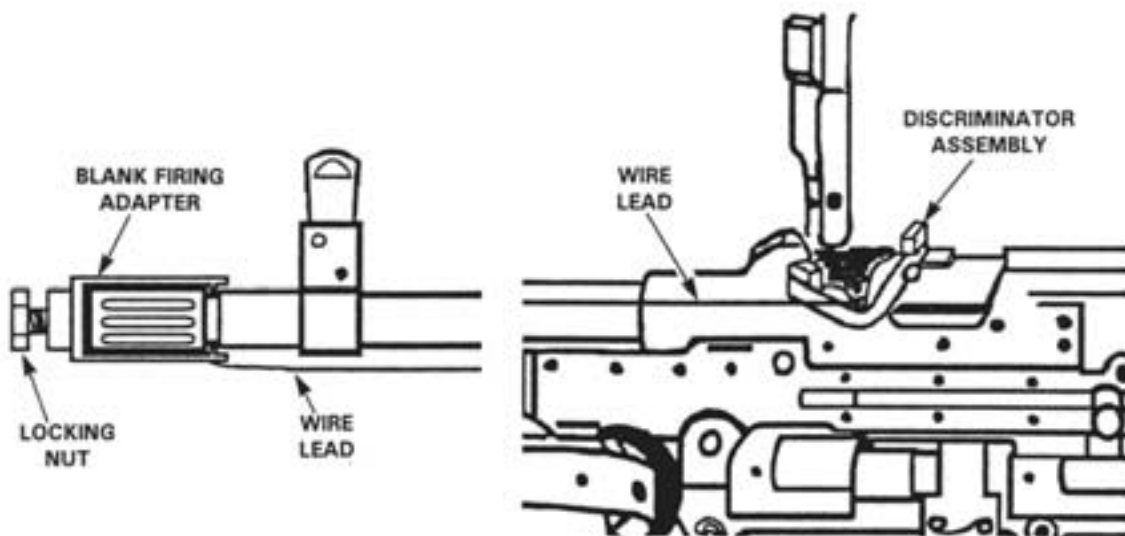

Figure 3-77. Installing the Blank Firing Adapter.

## Chapter 4

# MACHINE GUN, CALIBER .50, BROWNING, M2HB

*“One group headed straight for the artillery positions of 2/14 near the beach. Here Battery D, receiving the impact of the charge, employed not only howitzers but also machine guns to stem it. As the surviving Japanese stole doggedly closer, despite the fire, gunners of Batteries E and F turned infantrymen, leveling enfilading fire from their .50-caliber machine guns into the area forward of Battery D. That fire was conclusive—it ‘literally tore the Japanese to pieces,’ said the battalion executive officer.”*

—Engagement of Batteries D, E, and F, 2d Battalion,  
14th Marines on 24 July 1944<sup>8</sup>



**World War II, Namur Island, Marshall Chain  
Marine Machine Gun Team Covers Advancing Infantry**

## Table of Contents

<b>Section 1. Introduction</b>	4704	Special Maintenance Procedures
4101    General Data	4705	Inspection
4102    Sights		
4103    Safety		
4104    Role of the M2 .50 Cal		
<b>Section 2. Disassembly, Assembly, and Nomenclature</b>		
4201    General Disassembly		
4202    General Assembly		
4203    Detailed Disassembly and Assembly		
<b>Section 3. Headspace and Timing</b>		
4301    Headspace		
4302    Timing		
<b>Section 4. Functioning</b>		
4401    Feeding		
4402    Chambering		
4403    Locking		
4404    Firing		
4405    Unlocking		
4406    Extracting		
4407    Ejecting		
4408    Cocking		
<b>Section 5. Malfunctions and Stoppages</b>		
4501    Malfunctions		
4502    Stoppages		
4503    Immediate Action		
4504    Remedial Action		
<b>Section 6. Mounts and Accessories</b>		
4601    Tripod Mount, M3		
4602    Vehicle Mounts		
4603    Night Vision Sight, AN/TVS-5		
<b>Section 7. Maintenance</b>		
4701    Cleaning Materials and Lubricants		
4702    Care and Cleaning Before, During, and After Firing		
4703    Normal Maintenance Procedures		
		<b>Section 8. Ammunition</b>
	4801	Classification
	4802	Identification
	4803	Ballistic Data
	4804	Ammunition Packaging
	4805	Storage
	4806	Care, Handling, and Preservation of Ammunition
		<b>Section 9. Operation and Firing</b>
	4901	Half Loading and Loading
	4902	Single Shot Operation
	4903	Precautions During Operation
	4904	Unloading and Clearing the Gun
	4905	Positions for Firing
		<b>Section 10. Gun Drill</b>
	41001	Crew Equipment
	41002	Form for Gun Drill
	41003	Examination of Equipment Before Firing
	41004	Placing the Gun into Action
	41005	Taking the Gun Out of Action
	41006	Duties of Crew
	41007	Carrying the Tripod-Mounted Gun
		<b>Section 11. Qualification Firing</b>
	41101	Phases of Training
	41102	Fundamentals of Marksmanship
	41103	Preparatory Exercises
	41104	Equipment for Training
	41105	Positions for Firing
	41106	Introductory Manipulation
	41107	Sighting and Aiming Exercises
	41108	Sight Setting and Laying Exercises
	41109	Manipulation Exercises
	41110	Observation and Adjustment of Fire
	41111	Range Determination and Windage Corrections
	41112	Tracking and Leading Exercises
	41113	Preliminary Gunner's Test
	41114	Range Firing

## List of Figures

4-1	M2 .50 Cal on Tripod Mount, M3	4-35	Barrel Extension Group with New Type Breech Lock
4-2	Leaf Sight	4-36	The Cover Group, Exploded View
4-3	Front Sight, Cover, and Blade	4-37	Removing the Cover Group
4-4	Raising the Cover	4-38	Removing the Belt Feed Lever
4-5	Aligning Barrel Locking Spring Lug With the 3/8-inch Hole	4-39	Removing the Shoulder Headless Pin and Spring
4-6	M2 .50 Cal Link	4-40	Belt Feed Slide
4-7	Removing the Barrel	4-41	Drifting Out the Belt Feed Pawl Pin
4-8	Bolt Latch Release Free of the Bolt Latch Release Lock	4-42	Removing the Belt Feed Pawl and Arm
4-9	Removing the Back Plate	4-43	Disengaging the Belt Feed Pawl Arm From the Belt Feed Pawl
4-10	Driving Spring Rod Assembly	4-44	Removing the Cover Extractor Spring
4-11	Removing the Bolt Stud	4-45	Replacing the Cover Latch Spring
4-12	Freeing the Bolt	4-46	Seating the Belt Feed Pawl Spring (Left-Hand Feed)
4-13	Removing the Bolt from the Receiver	4-47	Replacing the Belt Feed Slide in its Guideways (Left-Hand Feed)
4-14	Removing the Barrel Buffer Group and Barrel Extension Group	4-48	Snapping the Belt Feed Lever Lug to Seat the Shoulder Headless Pin
4-15	Separating the Groups	4-49	Removing the Trigger Lever Pin Assembly
4-16	Separating the Barrel Buffer Assembly From the Barrel Buffer Body Group	4-50	Trigger Lever and Trigger Lever Pin Assemblies
4-17	The Eight Major Groups and Assemblies	4-51	Trigger Lever Replaced (Rear View)
4-18	Joining the Barrel Extension Group and Barrel Buffer Group	4-52	Inserting the Headspace Gage
4-19	Bolt Group, Exploded View	4-53	Inserting the Timing Gage
4-20	Removing the Extractor	4-54	Rotating the Timing Adjustment Nut to the Left
4-21	Removing the Bolt Switch and Bolt Switch Stud	4-55	Depressing the Trigger
4-22	Removing the Cocking Lever and Cocking Lever Pin	4-56	Feeding (Rear View)
4-23	Prying the Sear Stop into the Center Recess	4-57	Feeding (Top View)
4-24	Prying the Accelerator Stop Lock into the Center Recess	4-58	Belt Feed Slide Moving Out of the Side of the Cover
4-25	Drifting the Sear Stop Pin Free From Engagement with the Firing Pin Spring	4-59	Belt Feed Pawl Riding Over the First Round
4-26	Removing the Accelerator Stop Lock	4-60	Belt Feed Pawl Behind the First Round
4-27	Removing the Accelerator Stop	4-61	Belt Feed Slide Moving Inside the Cover
4-28	Removing and Replacing the Sear Side	4-62	Chambering
4-29	Removing and Replacing the Sear and Sear Spring	4-63	Locking
4-30	Removing the Firing Pin Extension Assembly and Firing Pin	4-64	Firing
4-31	Replacing the Firing Pin and Extension Assembly	4-65	Unlocking
4-32	Replacing the Sear Stop and Pin	4-66	Causes of Stoppages
4-33	Replacing the Bolt Switch and Stud	4-67	Immediate Action
4-34	Barrel Buffer Body Group, Exploded View	4-68	Ruptured Cartridge Case Extractor
		4-69	Tripod Mount, M3
		4-70	T&E Mechanism and Pintle
		4-71	HMMWV Mount With MK64 MOD 5 Cradle



4-72	M4 Pedestal Mount With MK64 MOD 5 Cradle	4-92	Screwing the Barrel Into the Barrel Extension
4-73	M66 Truck Ring Mount	4-93	Crew Ready to Place the Gun Into Action
4-74	Pintle Adapter	4-94	Squad Leader Moving the Tripod Into Position
4-75	T&E Mechanism Mount Assembly	4-95	Emplacing the Mount
4-76	M2 .50 Cal and M85 Reticle Pattern	4-96	Mounting the Gun
4-77	Use of Ranging Symbols M2 and M85	4-97	Half Loading the Gun
4-78	Dual-Purpose Sight (Under Development)	4-98	Crew Ready for Action
4-79	Care and Cleaning Procedures Before, During, and After Firing	4-99	Taking the Gun Out of Action
4-80	Inspection Checklist	4-100	Folding the Trail Legs
4-81	Characteristics and Tip Colors of M2 .50 Cal Ammunition	4-101	Dragging the Gun Into Position
4-82	M2 .50 Cal Ammunition	4-102	Two-Man Carry
4-83	Ballistic Data	4-103	Three-Man Carry—Hot Barrel
4-84	Maximum Penetration for Armor-Piercing Cartridge, M2 .50 Cal	4-104	Three-Man Carry—Cold Barrel
4-85	Maximum Penetration for Ball Cartridge, M2 .50 Cal	4-105	Manipulation
4-86	Ammunition Box	4-106	Correct Sight Picture
4-87	Clearing the Gun	4-107	Sighting Bar
4-88	Prone Position	4-108	M2 .50 Cal Targets
4-89	Sitting Position, Legs Crossed	4-109	Sight Picture With One Target Length Lead
4-90	Sitting Position, Legs Extended	4-110	Aiming Target Used in Tracking and Leading Exercises
4-91	Crew Formed in Column	4-111	Target Speeds, 10-Meter Moving Targets
		4-112	Lead Table
		4-113	Preliminary Gunner's Test

## Chapter 4

# Machine Gun, Caliber .50, Browning, M2HB

---

### Section 1 Introduction

---

The machine gun, caliber .50, Browning, M2HB (M2 .50 cal), is a belt-fed, recoil-operated, air-cooled, crew-served machine gun. The gun is capable of single shot as well as automatic fire (see figure 4-1).

Each member of the gun crew should have ready access to TM-9-1005-213-10, a detailed, pocket-sized reference manual for operators of the M2 .50 cal.

**a. Belt Feed.** By repositioning some of the component parts, the gun is capable of alternate feed

(ammunition can be fed into the weapon from the right or the left side of the receiver); however, the infantry generally uses only left side feed. A disintegrating metallic link belt is used in feeding.

**b. Recoil Operation.** The force for recoil operation is furnished by expanding powder gases which are controlled by various springs, cams, and levers.

**c. Air Cooling.** Maximum surface of the barrel and receiver is exposed to permit air cooling. Perforations in the barrel support allow air to circulate around the breach end of the barrel and help in cooling the parts. The heavy barrel is used to retard early overheating.



Figure 4-1. M2 .50 Cal on Tripod Mount, M3.

## 4101. General Data

### Weights/measurements:

Total system weight (gun, and tripod complete)	128 pounds
Weight of receiver	60 pounds
Weight of barrel	24 pounds
Weight of tripod mount M3 (w/traversing and elevating mechanism and pintle w/bolt)	44 pounds
Length of gun	65 inches
Length of barrel	45 inches
Muzzle velocity (M2 ball)	3,050 feet per second
Rifling	Eight lands and grooves with a right hand twist, one turn in 15 inches

### Ranges:

Maximum (M2 ball)	7,400 meters (approximate)
Maximum effective	1,830 meters
Grazing fire	700 meters

### Ammunition:

Caliber	50 caliber
Types in use	Ball, tracer, armor-piercing, incendiary, armor-piercing-incendiary, armor-piercing-incendiary-tracer, sabot light armor penetrator, sabot light armor penetrator-tracer, blank, dummy, and plastic practice (ball and tracer)

### Basic load of ammunition

per gun (vehicle mount)	400 rounds
Weight of 100 rounds in ammunition can	approximately 35 pounds

### Rates of fire:

Sustained	40 rounds or less per minute
Rapid	More than 40 rounds per minute
Cyclic	450-550 rounds per minute

### Manipulation (tripod mount, tripod controlled):

Elevation	100 mils
Depression	250 mils
Traverse	800 mils (400 left/400 right)

## 4102. Sights

The gun has a leaf-type rear sight, graduated in both yards and mils for ranges from 100 to 2600 yards, and from 0 to 62 mils. A windage knob permits deflection changes of 5 mils right or left of center (see figure 4-2). The front sight is a semi-fixed blade type with cover (see figure 4-3).

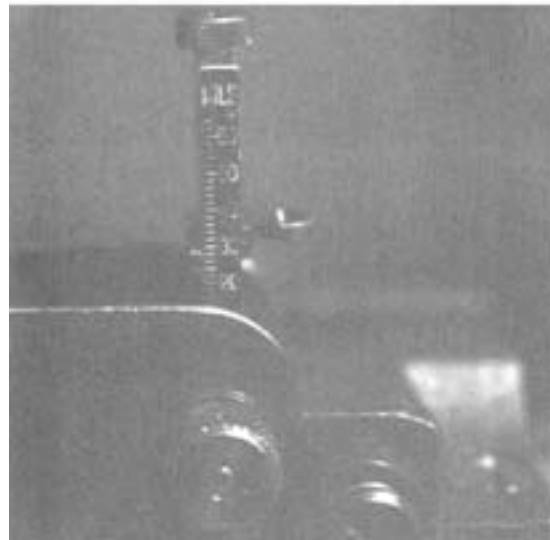
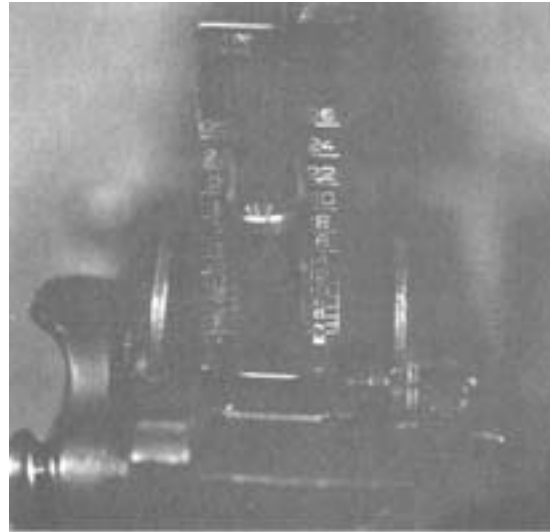

**Figure 4-2. Leaf Sight.**

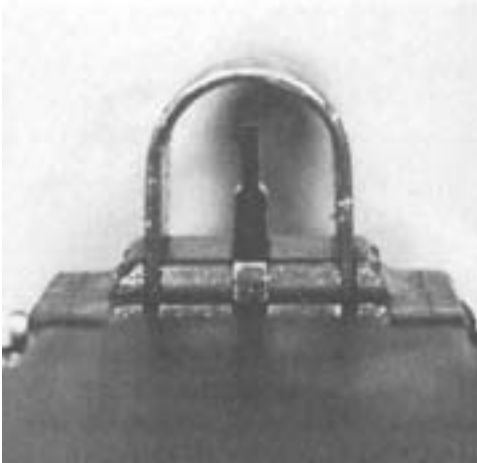

**Figure 4-3. Front Sight, Cover, and Blade.**

### 4103. Safety

The M2 .50 cal does not have a mechanical safety. Once the weapon has been loaded and charged (bolt to the rear with a round on its face) caution must be observed by the gunner as the weapon is ready to fire once the trigger is depressed.

### 4104. Role of the M2 .50 Cal

This machine gun supports both the offense and defense. It provides the heavy volume of close, accurate, and continuous fire support necessary to suppress and destroy enemy fortifications, vehicles and personnel in support of an attack. The long range, close defensive, and final protective fires delivered by this gun form an integral part of the unit's defensive fires.

The M2 .50 cal is also used to—

- Provide protection for motor movements, vehicle parks, and train bivouacs.
- Defend against low-flying hostile aircraft.
- Destroy lightly armored vehicles.
- Provide reconnaissance by fire on suspected enemy positions.
- Provide final protective fires.

---

## Section 2

### Disassembly, Assembly, and Nomenclature

---

Disassembly and assembly may be divided into two categories; general and detailed. General disassembly involves separation of the weapon into main groups. This is also known as field stripping and is a practice that stems from past experience in combat situations. The intent behind designating main groups for a weapon and the practice of field stripping is to allow the operator to quickly break the weapon down into a set of major components that can be hastily cleaned to keep the weapon ready for action. The idea is to disassemble the weapon just far enough to conduct basic cleaning without having to contend with numerous assemblies and parts. Detailed disassembly, for the operator, involves the removal of some of the component parts and assemblies from the main groups. The idea here is that, when the situation and conditions permit, the operator can then take the time to more fully disassemble and thoroughly clean the weapon. Complete general and detailed disassembly is normally the expected routine in garrison after the completion of firing and/or field training, but this may also be conducted in a field environment when necessary, to ensure the proper functioning and maintenance of the weapon. Disassembly of the weapon beyond that described in this publication is not authorized, except by qualified ordnance personnel.

### 4201. General Disassembly

General disassembly for the M2 .50 cal consists of removing groups and assemblies for inspection or cleaning.

- a. Clearing the Gun.** Before disassembly can be conducted, the gun must be cleared as prescribed in paragraph 4903.
- b. Barrel Group.** Turn the cover latch and raise the cover (see figure 4-4). Grasp the retracting slide handle with the right hand, palm up, and pull the recoiling

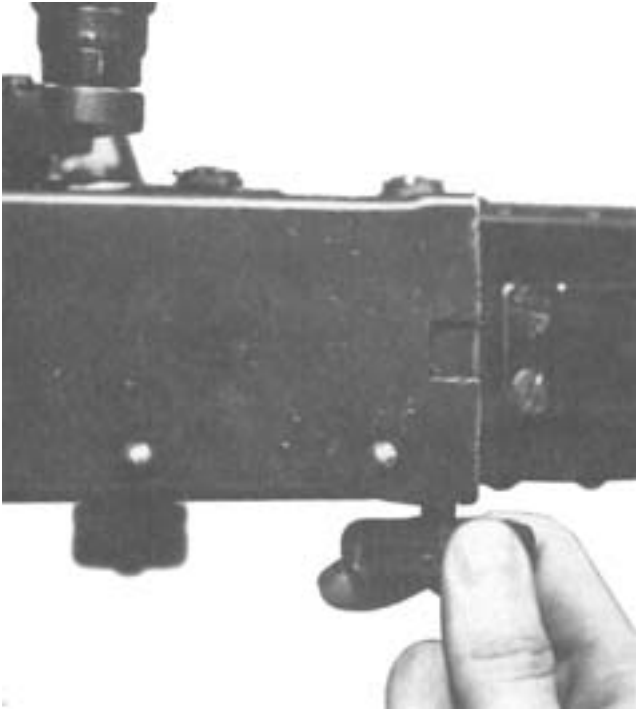

**Figure 4-4. Raising the Cover.**

parts to the rear until the lug on the barrel locking spring aligns with the 3/8-inch hole in the right side plate of the receiver (just below the feed way exit). The barrel can be turned only when the lug is aligned with the 3/8-inch hole. Place the smallest link of the M2 .50 caliber link, or suitable spacer, between the trunnion block and the barrel extension (see figures 4-5 and 4-6). This holds the barrel locking spring lug aligned with the 3/8-inch hole in the right side plate. Unscrew the barrel from the receiver (see figure 4-7). Be careful not to damage the threads or barrel locking notches when setting the barrel down. Pull back slightly on the retracting slide handle and remove the link or spacer from the receiver.

**c. Back Plate Group.** Ensure that the bolt latch release is in the upright position, free of the bolt latch release lock. If it is not in an upright position, push down on the bolt latch release and turn the buffer tube sleeve to the right to free it (see figure 4-8). *The bolt must be forward before the back plate is removed.* If

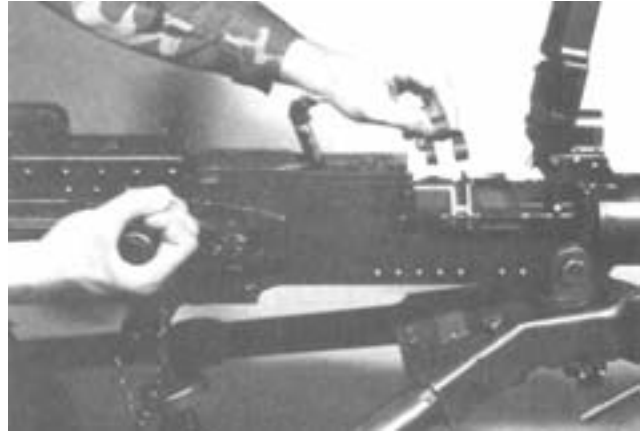

**Figure 4-5. Aligning Barrel Locking Spring Lug With the 3/8-inch Hole.**

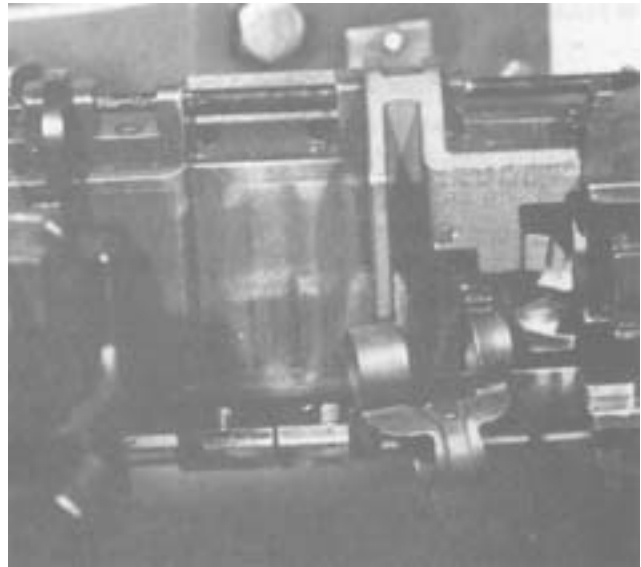

**Figure 4-6. M2 .50 Cal Link.**

the bolt is to the rear, push down on the bolt latch release allowing the bolt to go forward.

---

**CAUTION**

---

Care must be taken to prevent the bolt from slamming forward with the barrel removed.

---



**Figure 4-7. Removing the Barrel.**



**Figure 4-8. Bolt Latch Release Free of the Bolt Latch Release Lock.**

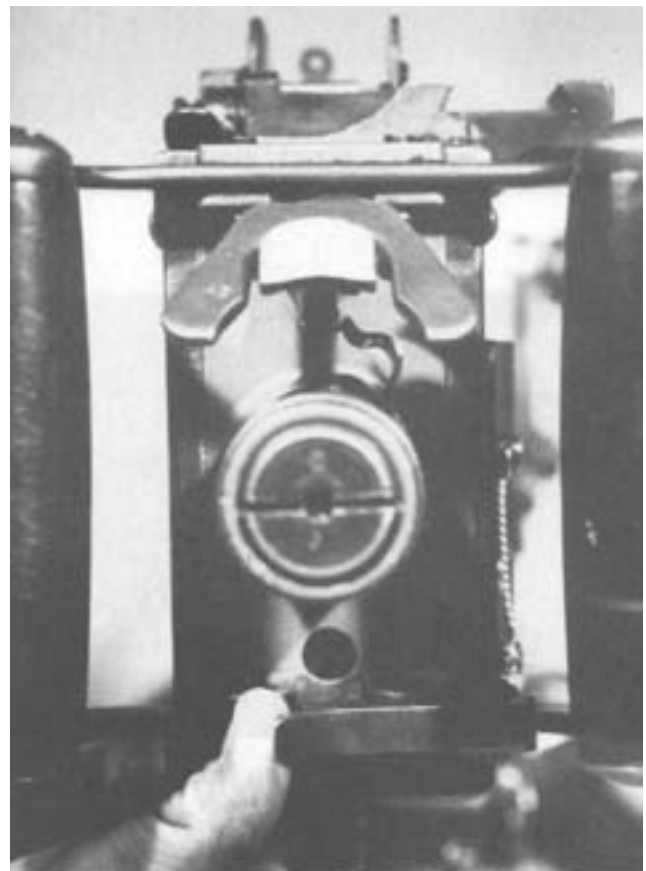

**Figure 4-9. Removing the Back Plate.**

Use the retracting slide handle to ease the bolt forward after the bolt latch is released. The back plate latch lock and latch are below the buffer tube. Pull out on the lock and up on the latch; remove the back plate by lifting straight up (see figure 4-9).

**d. Driving Spring Rod Assembly.** The inner and outer driving springs and driving spring rod are located inside the receiver next to the right side plate (see figure 4-10). Push in and to the left on the head of the driving spring rod to remove it. Push to the left to remove the driving spring rod-retaining pin from its seat in the right side plate. Pull the driving spring assembly to the rear and out of the receiver.

### CAUTION

Never attempt to cock the gun while the back plate is off and the driving spring assembly is in place.

### WARNING

If the back plate is off and the driving spring assembly is compressed, the retaining pin on the driving spring rod can slip from its seat in the side plate and cause serious injury to anyone behind the gun.

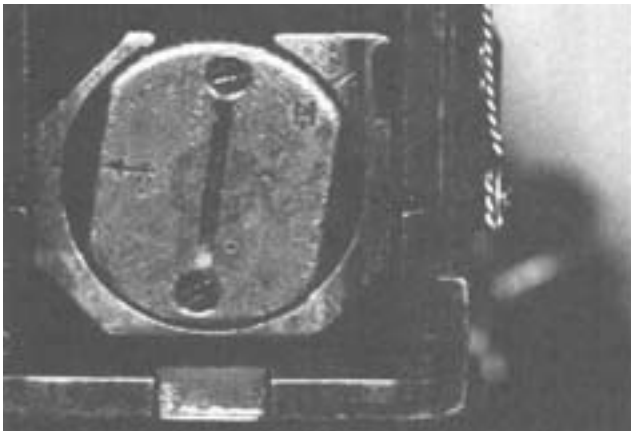

Figure 4-10. Driving Spring Rod Assembly.

**e. Bolt Stud.** Grasp the retracting slide handle and give it a quick jerk, freeing the bolt from the barrel extension. Align the shoulder on the bolt stud with the clearance hole in the bolt slot on the right side plate, and remove the bolt stud (see figure 4-11).

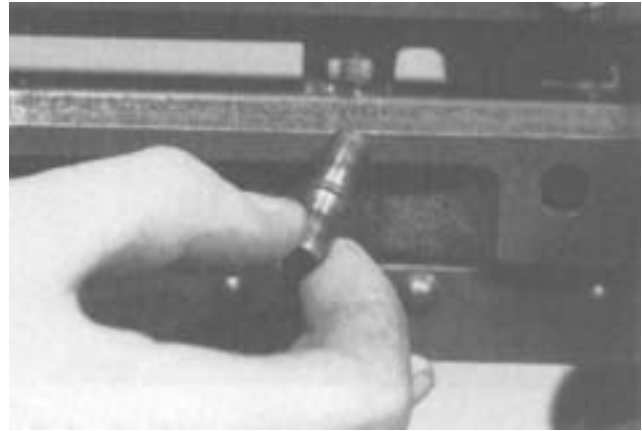

Figure 4-11. Removing the Bolt Stud.

### NOTE

If the bolt is accidentally moved all the way to the rear, the bolt latch will engage in the bolt latch notches in the top of the bolt. If this occurs, raise the bolt latch (left of the trigger lever) and push the bolt forward to align the bolt stud with the clearance hole (see figure 4-12).

**f. Bolt Group.** After freeing the bolt, slide it to the rear and out of the receiver (see figure 4-13). Place the bolt down on its right side (with the extractor arm up), so that the extractor will not fall from the bolt.

**g. Barrel Buffer Group and Barrel Extension Group.** Insert the drift of a combination tool, or other pointed instrument, through the hole in the lower rear corner of the right side plate. Push in on the buffer body lock. At the same time, place one hand in the receiver and push the barrel extension group and barrel buffer group to the rear (see figure 4-14). Remove

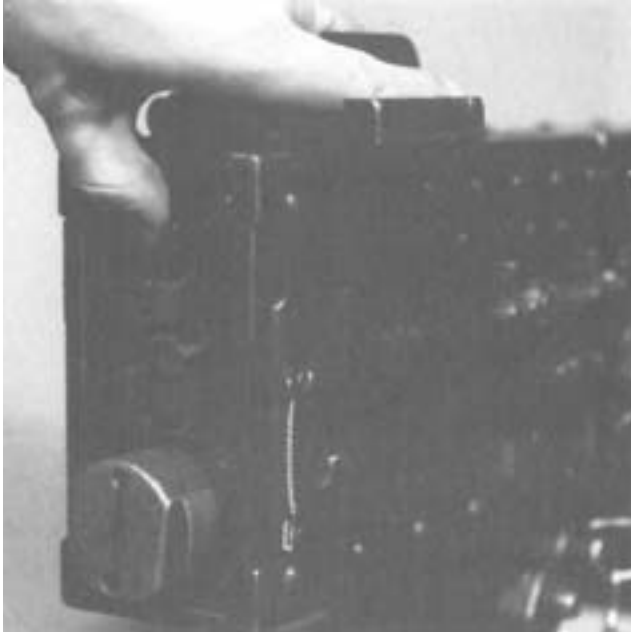

**Figure 4-12. Freeing the Bolt.**



**Figure 4-13. Removing the Bolt from the Receiver.**

the barrel buffer group and the barrel extension group through the rear of the receiver. Separate the two groups by pushing forward on the tips of the accelerator (see figure 4-15).

**h. Barrel Buffer Assembly.** Pull the barrel buffer assembly from the rear of the barrel buffer body group. The barrel buffer assembly will not be disassembled (see figure 4-16). This completes general disassembly (see figure 4-17).

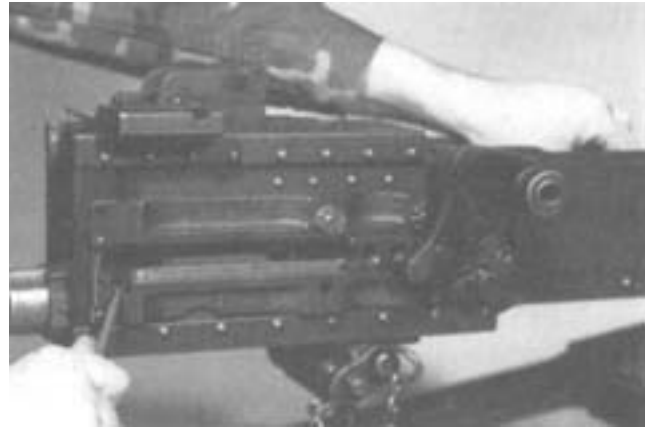

**Figure 4-14. Removing the Barrel Buffer Group and Barrel Extension Group.**

## 4202. General Assembly

To assemble the gun, replace the groups and assemblies in reverse order from disassembly.

**a. Barrel Buffer Assembly and Barrel Buffer Body Group.** Replace the barrel buffer assembly in the barrel buffer body group with the key on the spring guide to the right. This key must fit in its slot in the right side of the barrel buffer body. Turn the barrel buffer tube until the screwdriver slot (in the rear of the tube) is vertical, arrow pointing to the right. The stud on the tube lock will now engage the serrations in the barrel buffer tube to keep the tube from turning. Push the barrel buffer assembly fully forward.

**b. Barrel Buffer Group and Barrel Extension Group.** To join the two groups together, hold the barrel buffer group in the right hand, with the index finger supporting the accelerator. Join the notch on the shank of the barrel extension group with the cross groove in the piston rod of the barrel buffer assembly. At the same time, align the breech lock depressors with their guideways in the sides of the barrel extension, ensuring that the tips of the accelerator are against the rear end of the barrel extension; claws against the shank (see figure 4-18). Push the groups together. As the accelerator rotates to the rear, press down its tips to ensure positive locking of groups. Place the groups in the receiver, and push them forward until the barrel buffer body spring lock snaps into position. When the parts are properly locked in place, the barrel buffer tube should protrude about 1 1/8 inches from the rear of the barrel buffer body group.



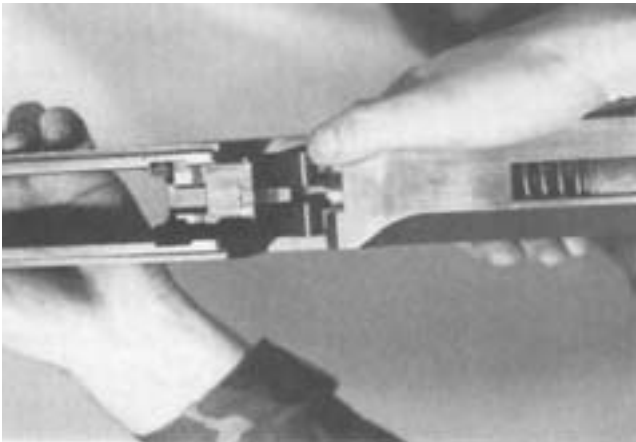

Figure 4-15. Separating the Groups.



Figure 4-16. Separating the Barrel Buffer Assembly From the Barrel Buffer Body Group.

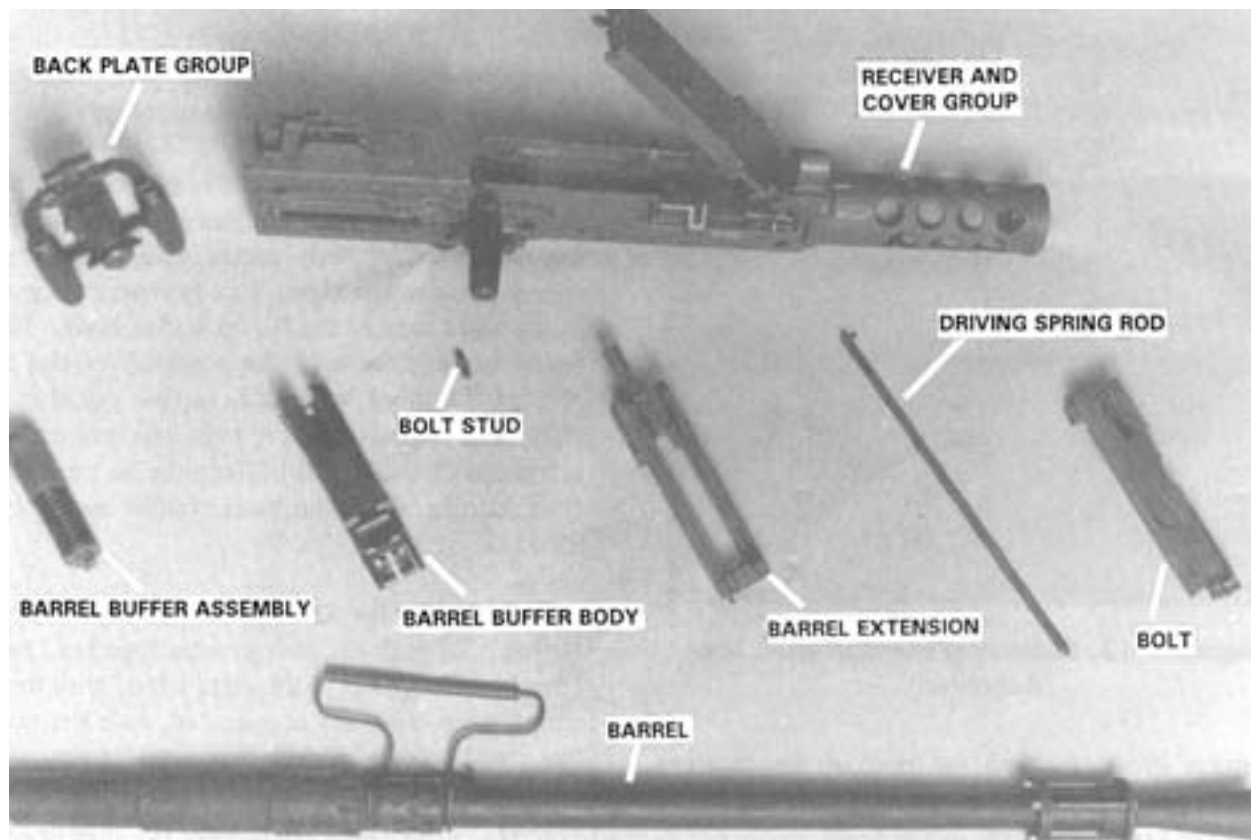

Figure 4-17. The Eight Major Groups and Assemblies.

**c. Bolt Group.** Place the bolt in the receiver with the top of the cocking lever forward and the extractor down. Push the bolt forward into the receiver. As the front end of the bolt approaches the tips of the accelerator, look into the side plate of the receiver, and press down on the rear end of the bolt to ensure the front end of the bolt clears the accelerator tips. Raise the rear of the bolt and continue to push it forward until the bolt latch release engages the notches in the top of the receiver.

#### NOTE

The barrel extension, barrel buffer, and bolt groups may be assembled and returned to the receiver together

**d. Bolt Stud.** Align the stud hole with the clearance hole and replace the bolt stud, ensuring that the shoulder of the stud is inside the side plate.

**e. Driving Spring Rod Assembly.** Press up on the bolt latch and push the bolt all the way forward by pushing on the bolt and stud only. Place the end of the driving spring rod in its hole in the rear of the bolt, and push forward on the driving spring group and the barrel buffer tube. Press in and to the right on the head of the driving spring rod and place the retaining head in its seat in the right side plate.

#### NOTE

At this time, the barrel buffer should be completely inside the receiver. If not, the barrel buffer body spring is not properly seated.

**f. Back Plate Group.** Hold the back plate with the latch down and the trigger up; place the back plate guides in their guideways. Hold out on the latch lock and tap the back plate into position until the latch snaps into place. Release the latch lock, and pull up on the back plate group to ensure it is firmly seated.

**g. Barrel Group.** Pull the retracting slide handle to the rear until the lug on the barrel locking spring is visible through the 3/8-inch hole in the right side plate. Place the smallest loop of a caliber .50 link, or suitable spacer, between the trunnion block and the barrel extension. Screw the barrel all the way into the barrel extension; then unscrew the barrel two notches. Remove the link and close the cover. This completes general assembly.

**h. Function Check.** To check for correct assembly, the gunner ensures that the bolt is forward and the cover is closed. With the bolt latch release lock engaged (up position), the gunner pulls the retracting slide handle to the rear. The bolt will be engaged by the latch assembly and held to the rear. The gunner returns the retracting slide handle to the forward position and releases the firing pin. The gunner then disengages the bolt latch release lock (down position), pulls the retracting slide handle to the rear, and returns it to the forward position. This completes the function check and indicates that the gun is correctly assembled.



**Figure 4-18. Joining the Barrel Extension Group and Barrel Buffer Group.**

### 4203. Detailed Disassembly and Assembly

The term detailed disassembly, as it is used in this manual, refers only to those disassembly procedures authorized for the operator level. This is not to be confused with procedures authorized for 2d echelon maintenance (unit armorers) or above. Detailed disassembly of any of the groups beyond that described in this document IS NOT AUTHORIZED except by qualified ordnance personnel.

To replace damaged or broken parts within major groups or assemblies, knowledge of detailed disassembly and assembly is required. Detailed disassembly and assembly involves the bolt, barrel buffer, barrel extension, cover, receiver, and back plate groups.

a. **Bolt Group.** Figure 4-19 shows a detailed disassembled bolt group.

#### (1) Detailed Disassembly

(a) *Extractor.* Rotate the extractor upward, and remove it from the bolt, freeing the bolt switch. The ejector and ejector spring are not removed from the extractor. See figure 20.

(b) *Bolt Switch and Bolt Switch Stud.* Lift out the bolt switch and pull out the bolt switch stud. See figure 4-21. On some models the bolt switch stud may be staked so that it cannot be removed.



Figure 4-19. Bolt Group, Exploded View.



**Figure 4-20. Removing the Extractor.**

(c) *Cocking Lever Pin and Cocking Lever.* Rotate the top of the cocking lever toward the rear of the bolt and remove the cocking lever pin. Lift out the cocking lever. See figure 4-22.

**NOTE**

The rounded nose of the cocking lever is down and to the rear of the bolt

(d) *Sear Stop and Pin.* Before removing the sear stop and pin (on some models the accelerator stop and lock), press down on the top of the sear to release the firing pin. Use the thin end of the cocking lever to pry the sear stop (accelerator stop lock) out of its groove in the bolt, and into the center recess (see figures 4-23 and 4-24). Turn the bolt over and drift the sear stop pin free from engagement with the firing pin spring (shake out the accelerator stop lock) (see figures 4-25 and 4-26). Turn the bolt over and lift the sear stop and pin from the bolt (see figure 4-27). If the pin does not come out freely, place the thin end of the cocking lever under the sear stop, against the pin, and pry it out of the bolt.

(e) *Sear Slide.* Press down on the sear and withdraw the sear slide. Withdraw the square end first. See figure 4-28.

(f) *Sear and Sear Spring.* To prevent loss of the sear spring, insert the thin end of the cocking lever between the coils of the sear spring. Lift out the sear and remove the sear spring. Leave the spring on the cocking lever. See figure 4-29.

(g) *Firing Pin Extension Assembly and Firing Pin.* Raise the front end of the bolt and allow the firing pin extension assembly and firing pin to fall into your hand (see figure 4-30). Separate the firing pin from its extension. This completes detailed disassembly of the bolt.

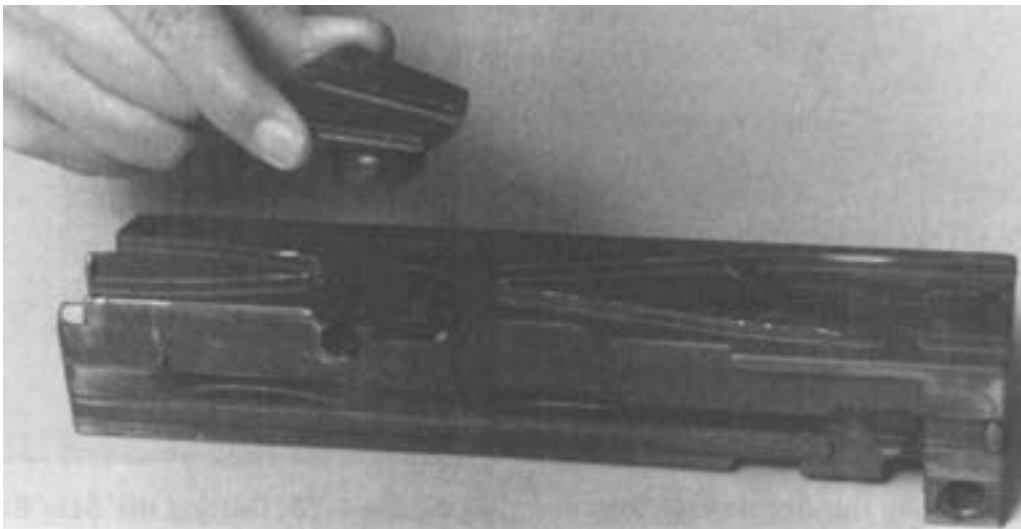

**Figure 4-21. Removing the Bolt Switch and Bolt Switch Stud.**

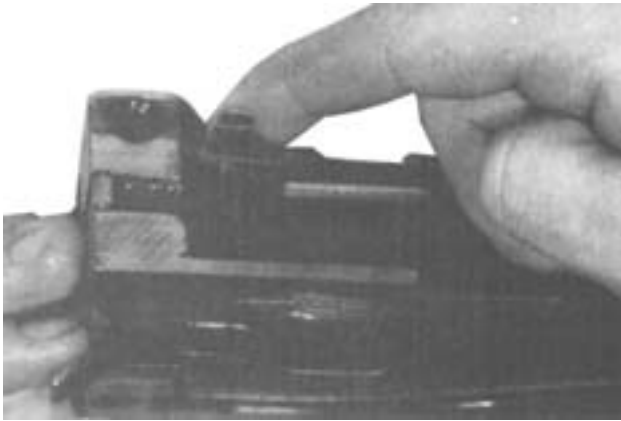

**Figure 4-22. Removing the Cocking Lever and Cocking Lever Pin.**

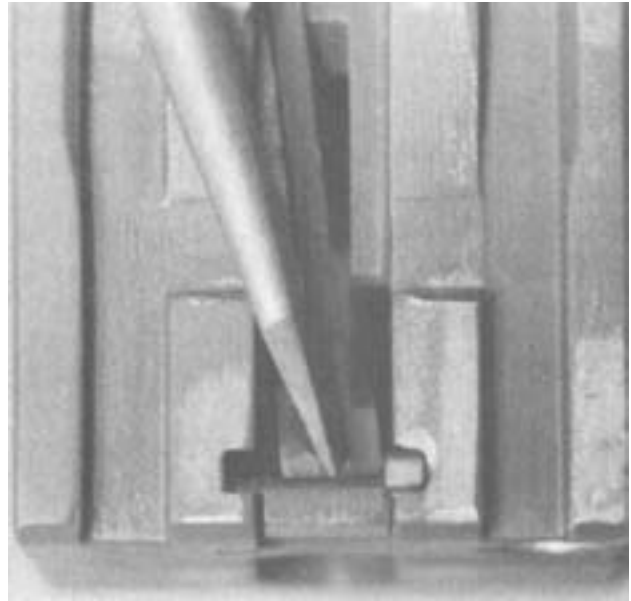

**Figure 4-23. Prying the Sear Stop into the Center Recess.**

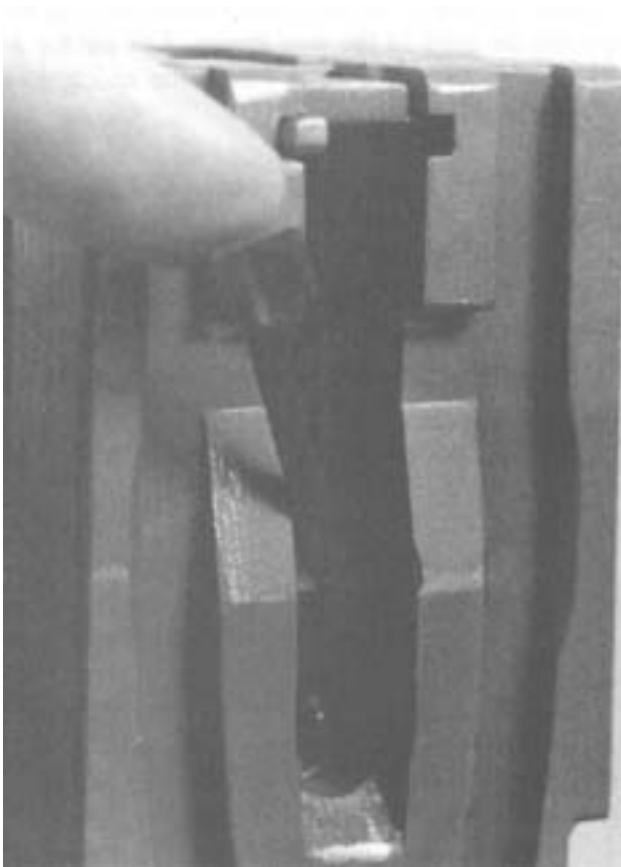

**Figure 4-24. Prying the Accelerator Stop Lock into the Center Recess.**

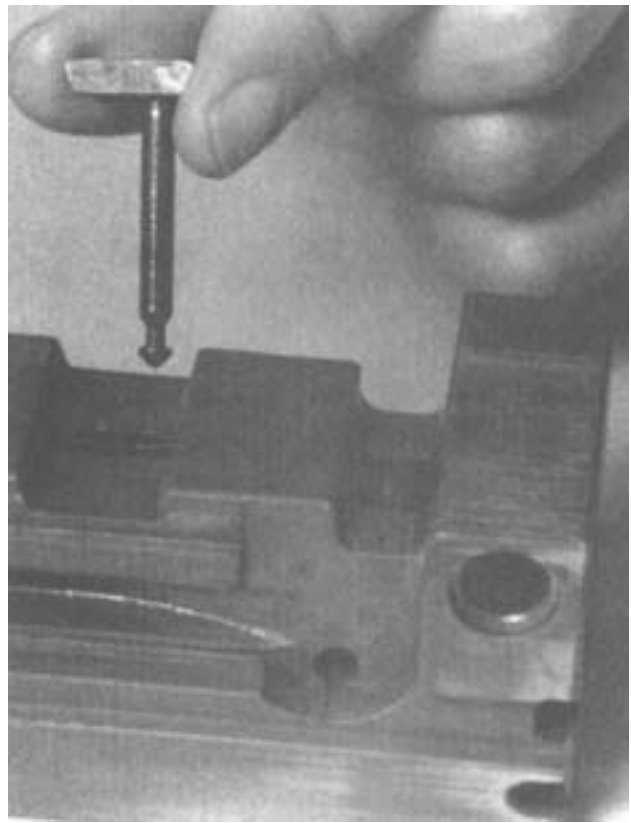

**Figure 4-25. Drifting the Sear Stop Pin Free From Engagement with the Firing Pin Spring.**



**Figure 4-26. Removing the Accelerator Stop Lock.**



**Figure 4-27. Removing the Accelerator Stop.**

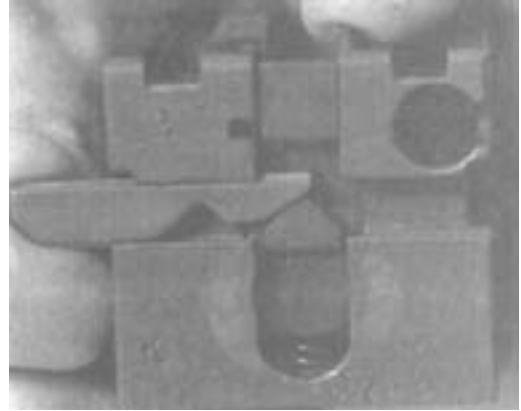

**Figure 4-28. Removing and Replacing the Sear Side.**

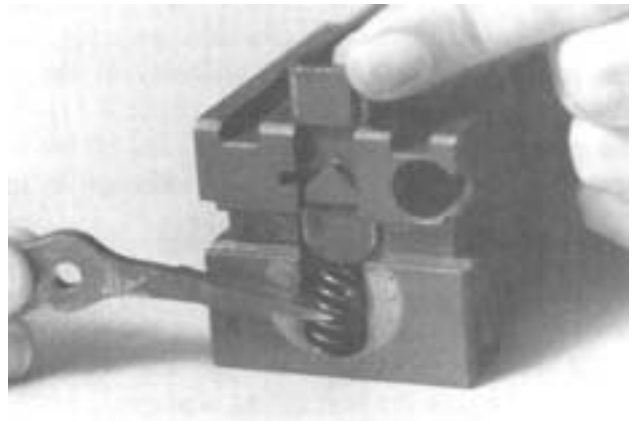

**Figure 4-29. Removing and Replacing the Sear and Sear Spring.**



**Figure 4-30. Removing the Firing Pin Extension Assembly and Firing Pin.**

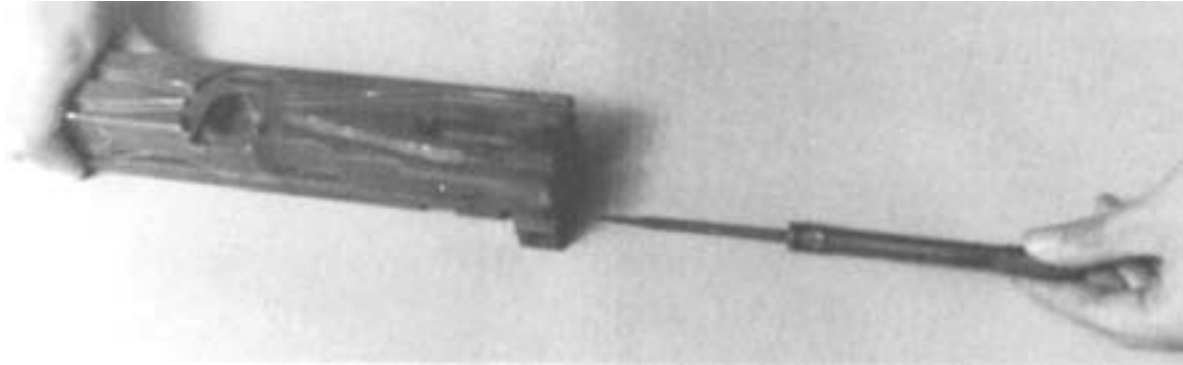

**Figure 4-31. Replacing the Firing Pin and Extension Assembly.**

## (2) Detailed assembly

(a) *Firing Pin and Extension Assembly.* Engage the rear end of the firing pin in its seating groove in the front end of the firing pin extension assembly. Insert the firing pin and extension assembly in the bolt, striker first, sear notch down (see figure 4-31). Push the extension assembly into the bolt, and tilt the front end down until the striker protrudes through its aperture in the face of the bolt.

(b) *Sear Spring and Sear.* With the sear spring still wedged on the cocking lever, replace the spring, and insert the sear in its slot, stud up, and notch to the front. Make sure the sear spring is properly seated in its recess in the bolt and the bottom of the sear.

(c) *Sear Slide.* Press down on the sear and replace the sear slide in its guideways. The slide may be inserted from either side, unless the gun is to be fired by the side plate trigger. In that case, the square end must be to the left.

(d) *Sear Stop and Pin.* Replace the sear stop and pin (accelerator stop and lock). Press down on the head of the pin (base of the accelerator stop) to force it into place (see figure 4-32). Swing the sear stop into its groove in the bolt.

(e) *Cocking Lever and Pin.* Replace the cocking lever, the rounded nose down and to the rear, the top of the cocking lever to the rear. Replace the cocking lever pin from the left side of the bolt. To test for correct assembly, cock the firing pin by rotating the top

of the cocking lever toward the front of the bolt; then rotate it to the rear and depress the sear. This should release the firing pin.

(f) *Bolt Switch Stud and Bolt Switch.* Replace the bolt switch and stud with the smaller end up. Place the bolt switch over the bolt switch stud, so that the groove marked L is continuous from the left-hand feed (see figure 4-33). The wider portion of the bolt switch will be to the front.

(g) *Extractor.* With the extractor arm vertical, replace the extractor stud in the extractor pivot hole of the bolt. Rotate the extractor forward; ensure that the collar is engaged in its slot in the bolt.



**Figure 4-32. Replacing the Sear Stop and Pin.**

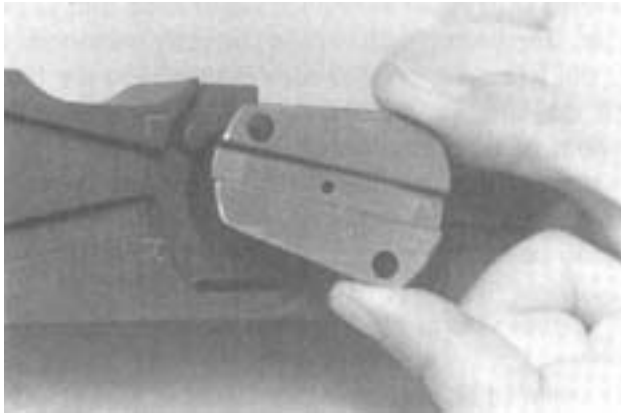

**Figure 4-33. Replacing the Bolt Switch and Stud.**

**b. Barrel Buffer Body Group. See figure 4-34.**

**(1) Detailed disassembly**

(a) *Barrel Buffer Tube Lock Assembly.* Turn the barrel buffer body group upside down. Pry up on the barrel buffer tube lock latch to disengage the latch before moving the lock body to the rear. Pry up the latch end of the assembly, so that the lug will clear the barrel buffer body. At the same time, press down on the front of the lock body to keep it from springing out.

Turn the accelerator back to push the barrel buffer tube assembly out of its slot.

(b) *Barrel Buffer Body Spring Lock.* In most cases, the barrel buffer body spring lock is staked and will not be removed.

(c) *Accelerator Pin and Accelerator.* Drift the accelerator pin out and remove the accelerator. This completes detailed disassembly of the barrel buffer body group.

**(2) Detailed assembly**

(a) *Accelerator and Accelerator Pin.* Replace the accelerators with the tips up and the claws to the rear. Replace the accelerator pin so that the ends are flush with the sides of the barrel buffer body group.

(b) *Barrel Buffer Tube Lock Assembly.* Turn the barrel buffer body upside down. Hold the assembly against the barrel buffer body, lug down. With the thumb of one hand press the forward winged part into the circular opening in the slot. With the other hand, raise the rear of the assembly enough to lift the lug over the buffer body. Push the assembly forward until the rear winged part (barrel buffer tube lock latch) snaps into the circular opening in the slot. This completes assembly of the barrel buffer body group.

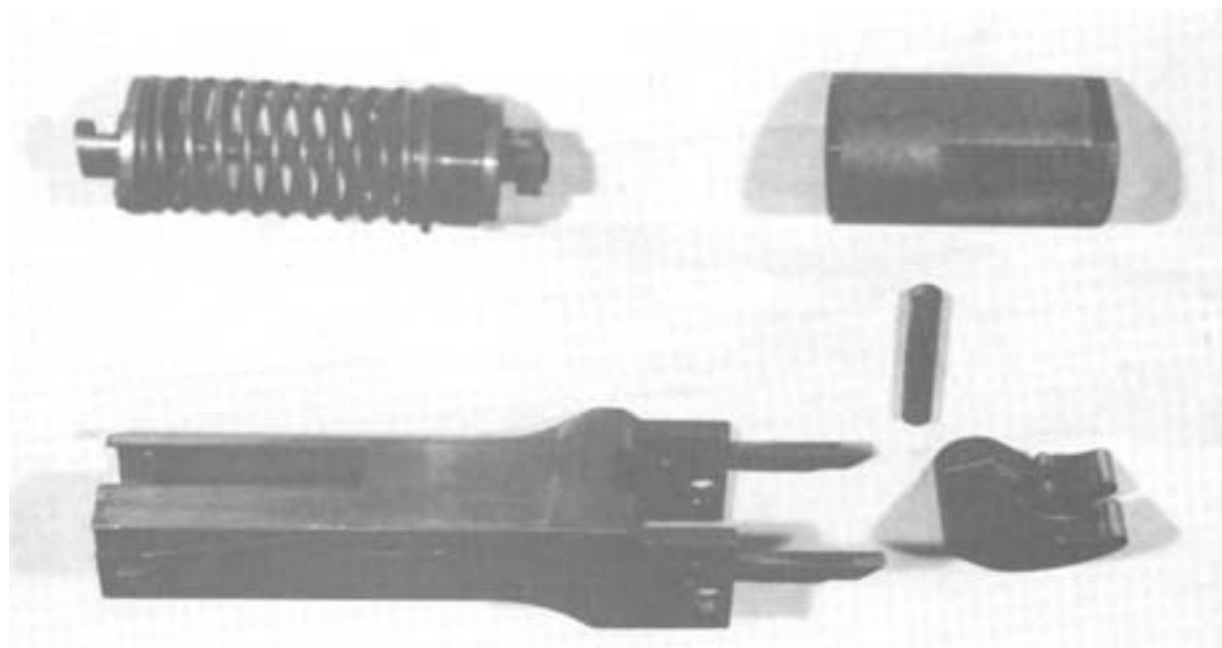

**Figure 4-34. Barrel Buffer Body Group, Exploded View.**



### c. Barrel Extension Group

#### (1) Detailed disassembly. See figure 4-35.

(a) *Breech Lock Pin and Breech Lock.* Drift the lock pin out and remove the breech lock from the bottom of the barrel extension group. The top of the breech lock may have a wide, single beveled edge, or a double beveled edge. In earlier models the top may be flat; the newer models may have a large slot. Guns currently manufactured have the breech lock with the slot on top for use with the accelerator stop and lock. When the accelerator stop and lock replaces the sear stop and pin, the breech lock with the slot will be used.

(b) *Barrel Locking Spring.* The barrel locking spring should already be staked to the barrel extension; it should not be removed. This completes detailed disassembly of the barrel extension group.

(2) **Detailed assembly of breech lock and breech lock pin.** Replace the breech lock from the bottom of the barrel extension. Make sure that the wide, single beveled edge (double beveled edge) is up and to the front. The breech lock will be correctly positioned in its slot

when the beveled edge is up and to the front and the hole for the breech lock pin is toward the bottom of the barrel extension. Replace the breech lock pin so that the ends of the pin are flush with the sides of the barrel extension. This completes assembly of the barrel extension group.

### d. Cover Group

#### (1) Detailed disassembly. See figure 4-36.

(a) *Cover Pin.* With the cover closed, remove the cotter pin and drift the cover pin out of the receiver. Unlatch the cover and rotate it up and forward to remove the cover from the trunnion block (see figure 4-37). Place the cover group (top up) on a flat, sturdy surface, with the latch end to the front and the hinged end toward you.

(b) *Belt Feed Lever and Lock Pin.* Remove the belt feed lever pin (cotter pin). Push the belt feed lever to the right, until the toe end of the belt feed lever (engaging the slide) is in line with the slot in the cover. Lift the belt feed lever off its pivot stud. Ensure the shoulder headless pin and spring do not fly out. See figure 4-38.

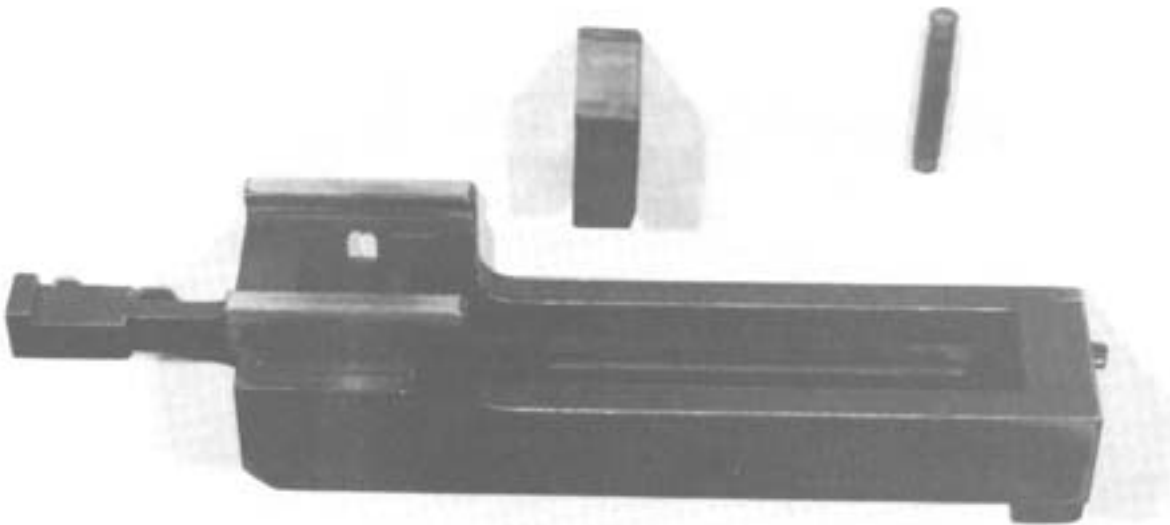

Figure 4-35. Barrel Extension Group with New Type Breech Lock.

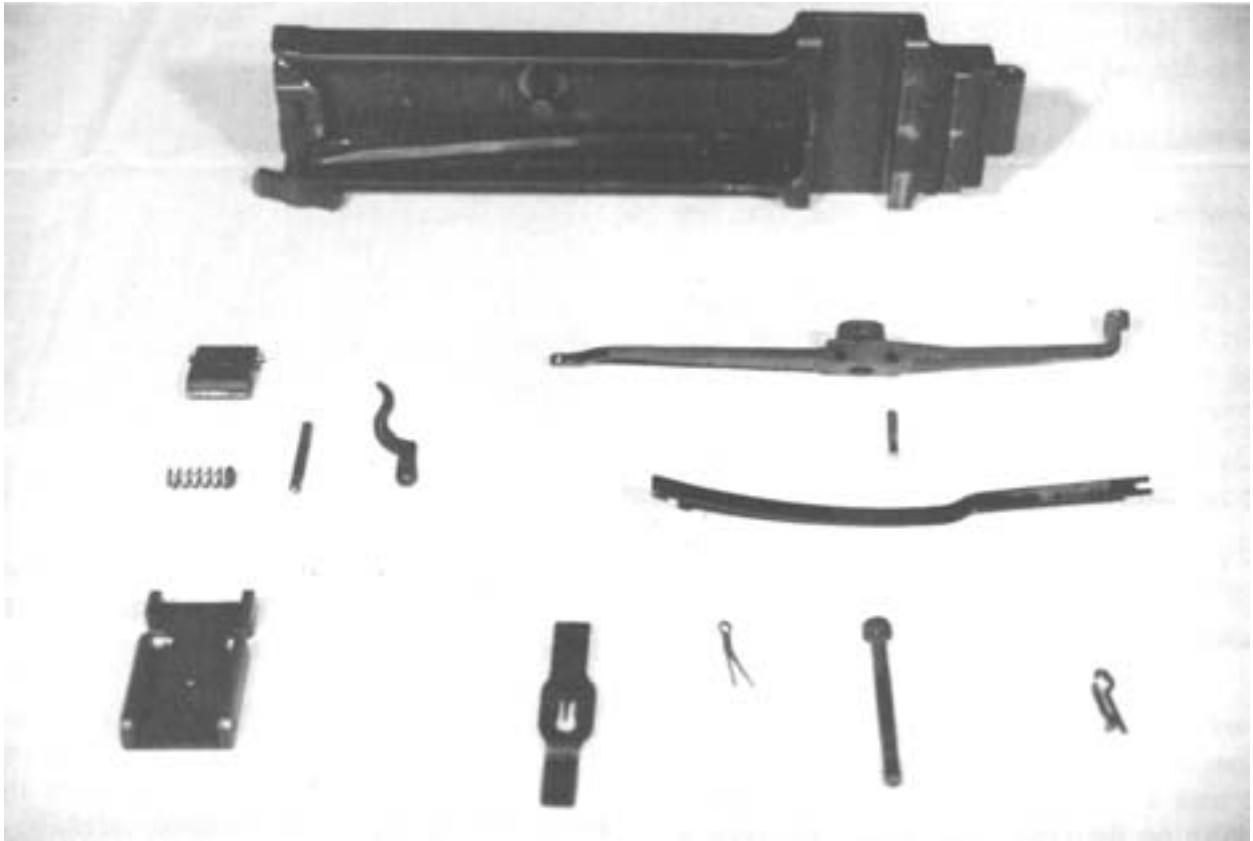

Figure 4-36. The Cover Group, Exploded View.

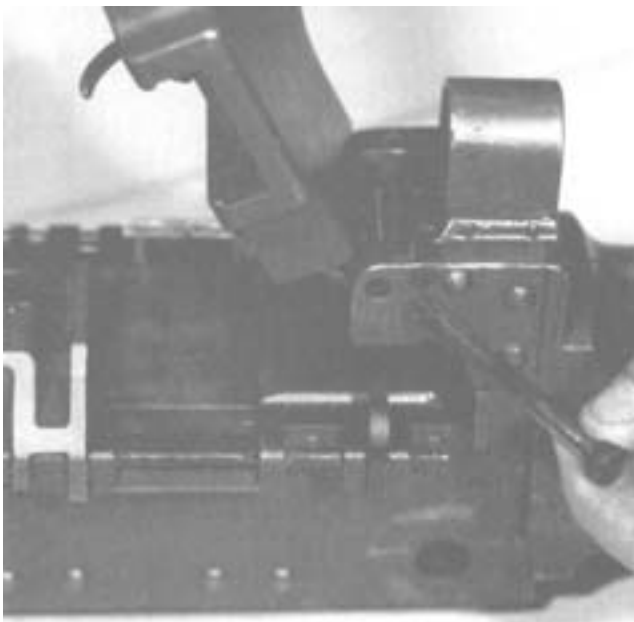

Figure 4-37. Removing the Cover Group.

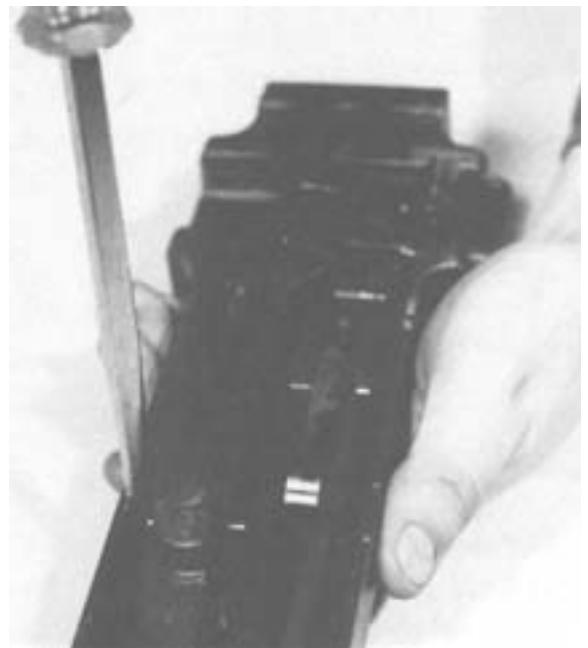

Figure 4-38. Removing the Belt Feed Lever.

(c) *Shoulder Headless Pin and Spring.* Remove these from their seat in the side of the belt feed lever. See figure 4-39.

(d) *Belt Feed Slide.* To remove the belt feed slide:

- Remove the belt feed slide from either side. See figure 4-40.
- Drift the belt feed pawl out, maintaining pressure on the belt feed pawl to prevent the spring from flying out. Use any available punch or M2 .50 cal combination as shown in figure 4-41.
- Slowly release pressure and remove the belt feed pawl and arm. See figure 4-42.
- Disengage the belt feed pawl arm from the belt feed pawl. See figure 4-43.
- Remove the belt feed pawl spring.

(e) *Cover Latch Spring.* Pry the hooked end of the spring out of its groove in the cover, and shift it to the left until it rests on the cover extractor spring. Press down on the cover latch spring and slide it away from the cover latch. Make sure that it rides on the top of the cover extractor spring. When the enlarged hole in



**Figure 4-39. Removing the Shoulder Headless Pin and Spring.**

the spring meshes with the cover latch spring stud, remove the spring from its stud.

(f) *Cover Extractor Spring.* Press down on the cover extractor spring and pry the end of the spring out of its recess in the cover extractor cam (see figure 4-44). This spring, if not handled carefully, can cause injury. Disengage the opposite end of the spring from the cover extractor spring stud. This completes detailed disassembly of the cover spring.

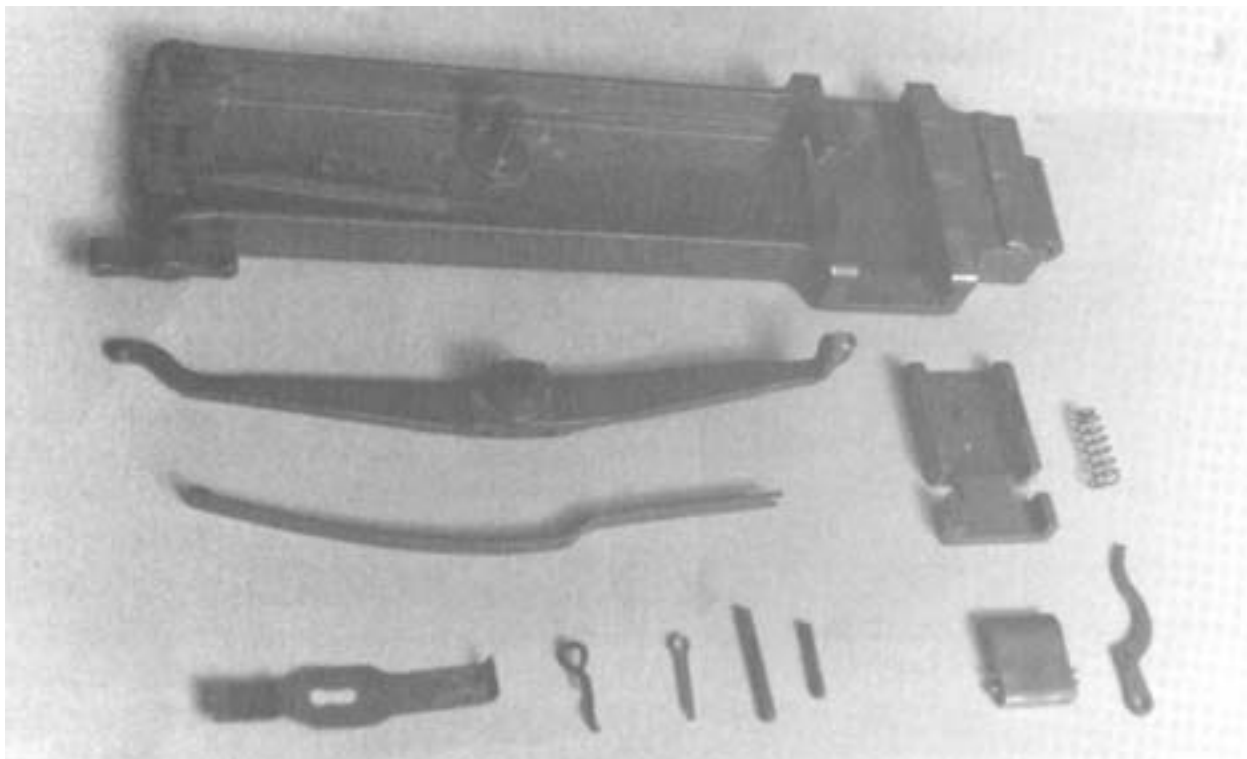

**Figure 4-40. Belt Feed Slide.**

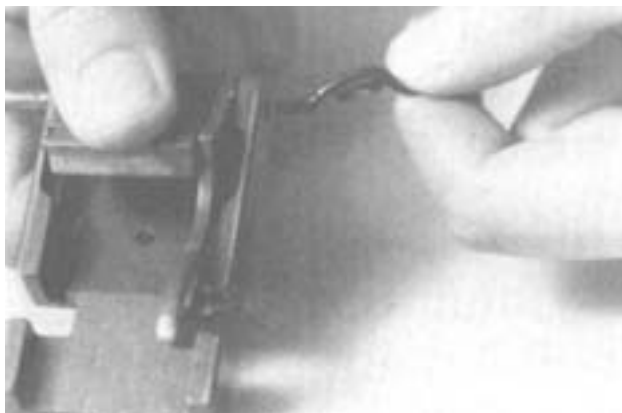

**Figure 4-41. Drifting Out the Belt Feed Pawl Pin.**

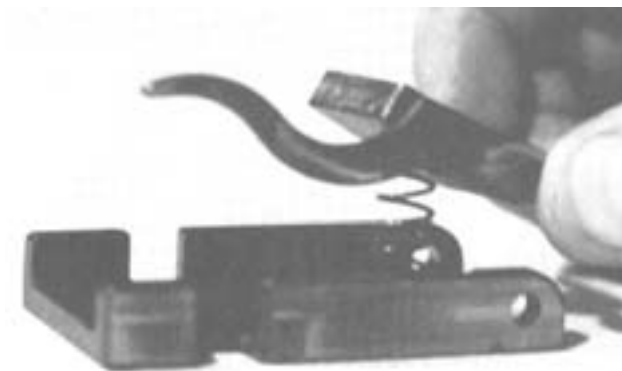

**Figure 4-42. Removing the Belt Feed Pawl and Arm.**



**Figure 4-43. Disengaging the Belt Feed Pawl Arm From the Belt Feed Pawl.**

**(2) Detailed assembly**

(a) *Cover Extractor Spring.* Place the cover in the same position as for detailed disassembly. Hook the slotted end of the spring under the cover extractor stud with the projection pointing in the direction of its recess. Exercising caution, press down, and seat the projection of the spring in its recess in the cover extractor cam.

(b) *Cover Latch Spring.* Place the cover latch spring inside the cover with the enlarged hole meshing with the cover latch spring stud, the hooked end down (resting on the cover extractor spring). Press down on the cover latch spring and slide it toward the latch. Pry up on the latch end of the spring so that it rides up over the projecting wing of the cover latch. Snap the hooked end of the spring into its groove in the cover. See figure 4-45.

(c) *Belt Feed Slide.* To reassemble the belt feed slide:

- Replace the belt feed pawl arm on the belt feed pawl.



**Figure 4-44. Removing the Cover Extractor Spring.**

### NOTE

There are two pins on each side of the belt feed pawl. The larger is the belt feed pawl arm pin; the smaller is the belt feed pawl arm locating pin. See figure 4-43. For a left-hand feed, the belt feed pawl arm must be placed over the pins so that the belt feed pawl arm is toward the latch end of the cover, when the assembled slide is returned to the cover.

- Place the small end of the belt feed pawl spring over the belt feed pawl spring stud (inside the belt feed slide). Place the assembled pawl and arm over the spring so that the large end of the spring is seated in the recess in the pawl, with the projecting oval (loop) of the spring away from the belt feed pawl arm. See figure 4-46.
- Align the pinholes in the pawl, arm, and slide; replace the belt feed pawl pin. Make sure that the pin is flush with the sides of the slide.
- Replace the belt feed slide in its guideways, with the belt feed pawl to the left, arm toward the latch. See figure 4-47.

(d) *Shoulder Headless Pin and Spring.* Replace these in their seats in the side of the belt feed lever. For left-hand feed, the spring and pin are seated in the hole nearest the belt feed lever lug. See figure 4-46.

(e) *Belt Feed Lever and Lock Pin.* Place the belt feed lever over the pivot stud, lug up and to the left. With a thumb at either end of the lever, press down and turn the lever until the shoulder headless pin is against the inside of the cover. Pivot the lever until it is aligned with the slots of the cover and slide. Press the lever down as far as it will go. Move the lug end all the way to the right. Maintain a downward pressure, and snap the lug end all the way to the left so that the shoulder headless pin is properly positioned in the cover (see figure 4-48). Replace the lock pin (cotter pin) in the pivot stud. Make sure that the toe end of the lever moves laterally in its slot without binding.

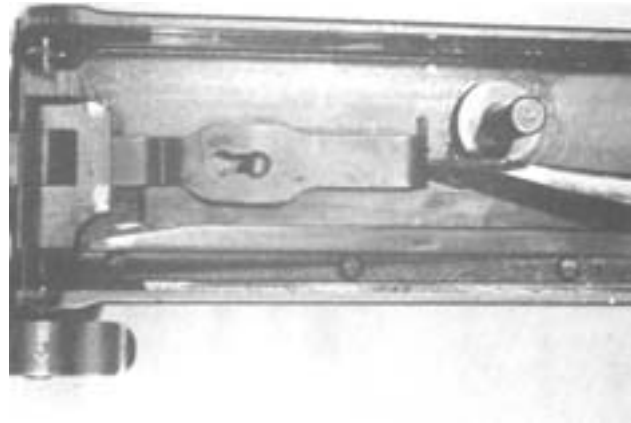

**Figure 4-45. Replacing the Cover Latch Spring.**

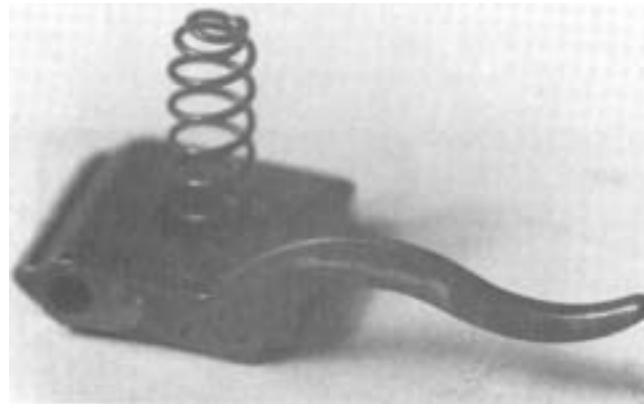

**Figure 4-46. Seating the Belt Feed Pawl Spring (Left-Hand Feed).**



**Figure 4-47. Replacing the Belt Feed Slide in its Guideways (Left-Hand Feed).**



**Figure 4-48. Snapping the Belt Feed Lever Lug to Seat the Shoulder Headless Pin.**

(f) *Cover Pin.* To replace the cover group on the receiver, place the latch end of the cover in position, with the latch engaging the top plate. With the heel of your hand, tap the hinged end downward into position. Align the pin holes and replace the cover pin. Insert the cotter pin in the cover pin and spread the ends. This completes assembly of the cover group.

#### **e. Receiver Group**

##### **(1) Detailed disassembly**

(a) *Belt Holding Pawl, Spring(s), and Pin.* Press down on the spring belt holding pawl and withdraw the belt holding pawl pin to the rear. Remove the belt holding pawl and springs, being careful not to lose the springs. The split belt holding pawl assembly includes a left-hand and a right-hand holding pawl, connected by a belt holding pawl sleeve; two belt holding pawl springs are used. Guns of earlier manufacture use a single belt holding pawl adapted for either one or two springs.

(b) *Cartridge Stop Assembly, Front Cartridge Stop, and Belt Holding Pawl Pin.* Withdraw the belt holding



**Figure 4-49. Removing the Trigger Lever Pin Assembly.**

pawl pin from the right side of the receiver. Remove the cartridge stop assembly (or rear cartridge stop and link stripper on guns of earlier manufacture) and front cartridge stop from the right side of the receiver.

(c) *Trigger Lever Pin Assembly and Trigger Lever.* Release the hinged lock from the left side plate. Turn the pin clockwise and withdraw the pin to the left. Remove the trigger lever from inside the receiver. Guns of earlier manufacture may have a trigger lever pin assembly without the hinged lock. In this case, lift the lock of the pin out of the small hole in the left side plate and rotate the lock end downward 90 degrees until it is just forward of a vertical position. Withdraw the pin to the left (see figures 4-49 and 4-50). This completes detailed disassembly of the receiver group.

##### **(2) Detailed assembly**

(a) *Trigger Lever and Trigger Lever Pin Assembly.* Replace the trigger lever in the receiver, with the long end forward and the bowed surface upward, between the top plate bracket and the bolt latch bracket (see figure 4-51). The trigger lever should project about 1/8 inch beyond the timing adjustment nut. Align the hole in the trigger lever with the holes in the receiver. Position the trigger lever pin assembly so that the key on the pin will pass through the keyway in the left side plate. Push the trigger lever pin assembly all the way in and turn the pin 90 degrees to the left, or counterclockwise. Turn the lock flat against the side of the receiver (with the lock without the hinge, turn the lock counterclockwise until the lock fits in the small hole in the side plate).

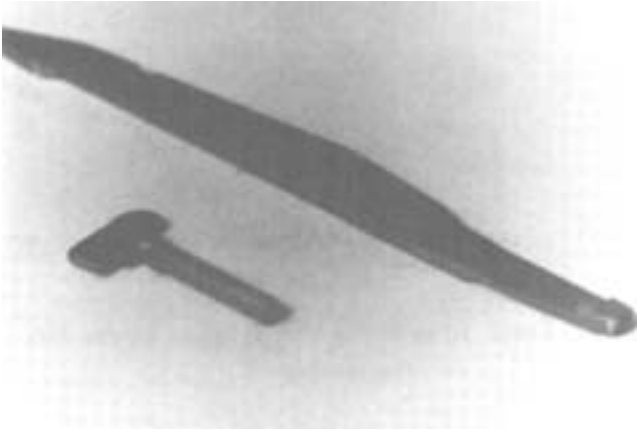

**Figure 4-50. Trigger Lever and Trigger Lever Pin Assemblies.**

(b) *Cartridge Stop Assembly, Front Cartridge Stop, and Belt Holding Pawl Pin.* Install the cartridge stop assembly (or rear cartridge stop and link stripper) and front cartridge stop, on the right side of the receiver. Replace the belt holding pawl pin.

(c) *Belt Holding Pawl, Spring(s), and Pin.* Place the belt holding pawl in position on the left side of the receiver, first seating the springs. Depress the pawl and insert the belt holding pawl pin. This completes assembly of the receiver group.

**f. Back Plate Assembly.** The back plate assembly is not disassembled by the operator.

---

### Section 3 Headspace and Timing

---

The M2 .50 cal's headspace and timing must be set manually by the operator. Correctly set headspace and timing is essential for the safe and effective operation of the weapon. This section describes the procedures required for proper adjustment of headspace and timing.

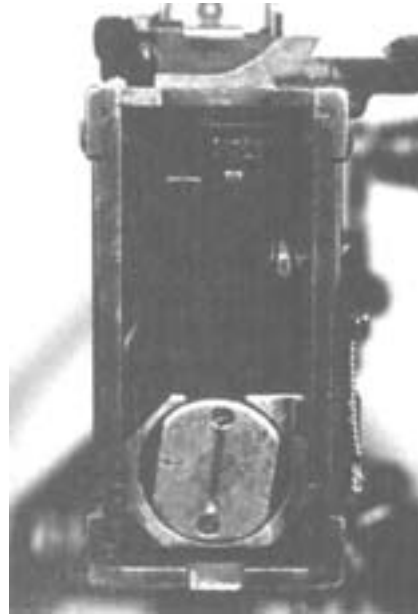

**Figure 4-51. Trigger Lever Replaced (Rear View).**

#### 4301. Headspace

Headspace is the distance between the face of the bolt and the base of the cartridge case fully seated in the chamber. Headspace adjustment is correct when the recoiling groups are fully forward and there is no independent rearward movement between the bolt, barrel, and barrel extension.

Correct headspace is important because improper adjustment can cause improper functioning of the gun and, frequently, injury to personnel and/or damage to parts. Headspace is checked and set prior to firing when the gun is assembled, when the barrel or any major group or assembly within the receiver is replaced, and when there is any doubt that correct headspace is set.

The headspace and timing gage consists of a headspace gage and two timing gages. These gages provide an accurate means of checking the adjustment of headspace and timing.

#### NOTE

The headspace and timing gage should be kept with the gun at all times.

Using the gage, the distance between the face of the bolt and the chamber end of the barrel can be accurately determined by following these procedures:

- Raise the cover, retract the recoiling parts (described in para. 4403), and screw the barrel all the way into the barrel extension. Then unscrew the barrel two notches.
- Cock the gun. Pull the retracting slide handle all the way to the rear and then return it to its most forward position.

### NOTE

Be careful not to depress the trigger because this will cause the firing pin to be released. If the pin is forward the gage cannot be inserted in the T-slot far enough to give an accurate determination.

### CAUTION

The firing pin should never be released with the gage in the T-slot as this could damage the firing pin and gage.

- Pull the retracting slide handle back until the barrel extension is about 1/16 inch from the trunnion block. This will ensure that the locking surfaces of the breach lock and the bolt are in proper contact. This prevents the driving spring group and weight of the parts from giving a false determination. See figure 4-52.
- Insert the *GO* end of the headspace gage in the T-slot, between the face of the bolt and the rear end of the barrel. If the *GO* end of the gage enters freely down to the center ring of the gage, then attempt to insert the *NO GO* end of the gage. If the *GO* end enters, and the *NO GO* end does not enter, correct headspace is set.
- If the *GO* end of the gage does not enter freely, headspace is too tight. When this condition exists the barrel must be unscrewed one click (notch) at a time (checking with the gage after every click), until the *GO* end of the gage enters freely. To complete the adjustment, attempt to insert the *NO GO* end of the gage; if it does not enter correctly, headspace is set. Remember to screw the barrel or to unscrew it from

the barrel extension. The lug on the barrel locking spring must be aligned with the 3/8-inch hole in the right side plate. See paragraph 4302b.

- If the *NO GO* end of the gage enters the T-slot, headspace is too loose. The barrel must be screwed into the barrel extension (one click at a time) checking with the gage after each click, until the *GO* end enters and the *NO GO* end does not.
- Remove the gage.

### 4302. Timing

Timing is the adjustment of the weapon so that firing takes place when the recoiling parts are between .020 and .116 inches out of battery to prevent contact between the front end of the barrel extension and the trunnion block. Timing is correctly set when the recoiling parts are locked together, firing takes place just before the parts are in battery (fully forward), and when the gun fires on the *FIRE* gage and does not fire on the *NO FIRE* gage. Timing must be checked and/or set each time headspace is set, or whenever timing is questionable.

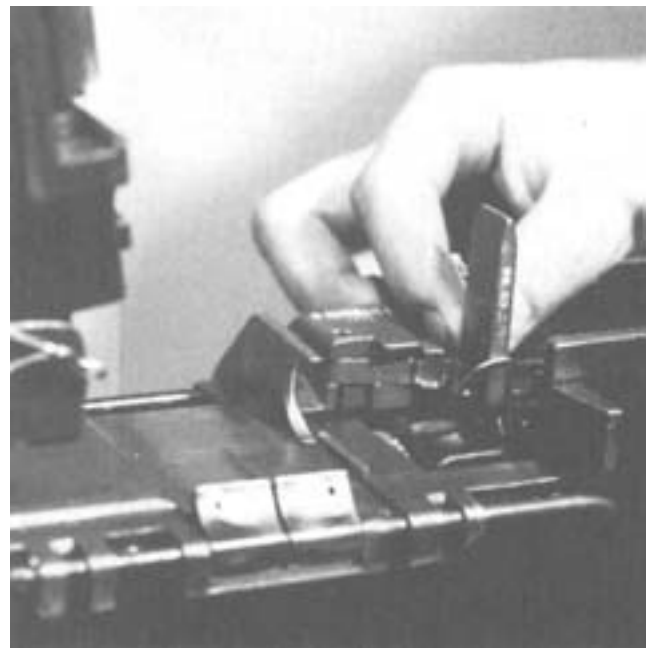

Figure 4-52. Inserting the Headspace Gage.



The following procedures are used to check and/or set the timing:

- Ensure that the gun has correct headspace adjustment.
- Cock the gun. Pull the retracting slide handle all the way to the rear and return it to its most forward position. Press the bolt latch release and allow the bolt to go forward.

### NOTE

Do not depress the trigger.

- Raise the extractor and pull the retracting slide handle back until the front end of the barrel extension is about 1/4 inch from the trunnion block.
- Insert the *NO FIRE* timing gage between the barrel extension and the trunnion block, placing the beveled edge of the gage on the barrel notches. See figure 4-53.
- Let the barrel extension close slowly on the gage.
- Depress the trigger firmly, attempting to release the firing pin. The firing pin should not release. If the firing pin *does* release, the gun is timed to fire too early.



Figure 4-53. Inserting the Timing Gage.

- To correct this, pull the retracting slide handle to the rear and allow the bolt to go forward. Insert the first gage, remove the back plate, and screw the timing adjustment nut to the left until it rests on the trigger lever (see figure 4-54). Press firmly UP on the trigger lever, attempting to fire. Rotate the timing adjustment nut to the right, one notch at a time, firmly pressing up on the trigger lever after each notch, attempting to fire the weapon.
- When the firing pin is released, turn the timing adjustment nut two additional notches to the right and replace the back plate.
- Cock the weapon and allow the bolt to go forward. Insert the *NO FIRE* gage between the receiver block and the barrel extension and attempt to fire the weapon by depressing the trigger (see figure 4-55). The weapon should not fire. If the weapon does not fire, a mechanical defect exists and the gunner should notify his organizational ordnance personnel.

### CAUTION

Do not attempt to cock the gun with the back plate off.

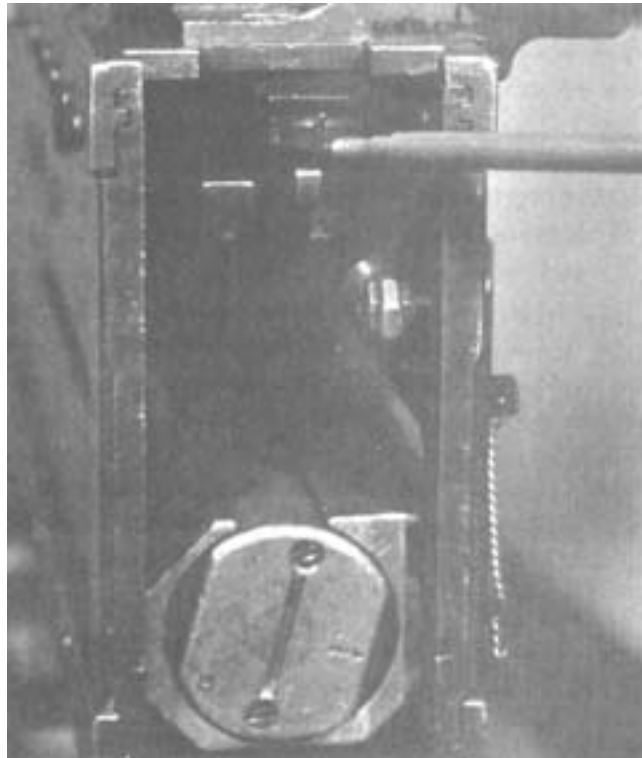

Figure 4-54. Rotating the Timing Adjustment Nut to the Left.



**Figure 4-55. Depressing the Trigger.**

- Replace the *NO FIRE* gage with the *FIRE* gage and attempt to fire. The weapon should fire.
- When all of the above procedures have been completed, the weapon is correctly timed.

---

### Section 4 Functioning

---

The cycle of functioning is broken down into eight basic steps. More than one step may occur simultaneously during the cycle of functioning. These steps are feeding, chambering, locking, firing, unlocking, extracting, ejection, and cocking. By understanding how the M2 .50 cal functions, you will more easily be able to recognize and correct malfunctions and stoppages which occur during firing.

With the M2 .50 cal, the recoiling groups must be manually operated to place the first round in the chamber. The cycle of operation begins with the first round positioned over the belt holding pawl. The recoiling groups are in their forward position.

#### 4401. Feeding

When the bolt is fully forward, the belt feed slide is in the cover and the ammunition belt is held in the feedway by the belt holding pawl. Figures 4-56 shows the bolt fully forward, belt feed slide in the cover, and the ammunition belt held in the feedway by the belt holding pawl. Figure 4-57 shows the bolt fully forward, belt feed slide in the cover, and the ammunition belt held in the feedway by the belt holding pawl.

As the bolt moves to the rear, the cam grooves guide the belt feed lever, pivoting the lever and moving the slide out the side of the cover (see figure 4-58). The belt is held stationary by the belt holding pawl, while the belt feed pawl pivots, compressing its spring, and rides up over the link holding the first round (see figure 4-59).

When the bolt is all the way to the rear, the belt feed slide moves out far enough to allow the belt feed pawl spring to force the pawl down behind the first round. See figure 4-60.

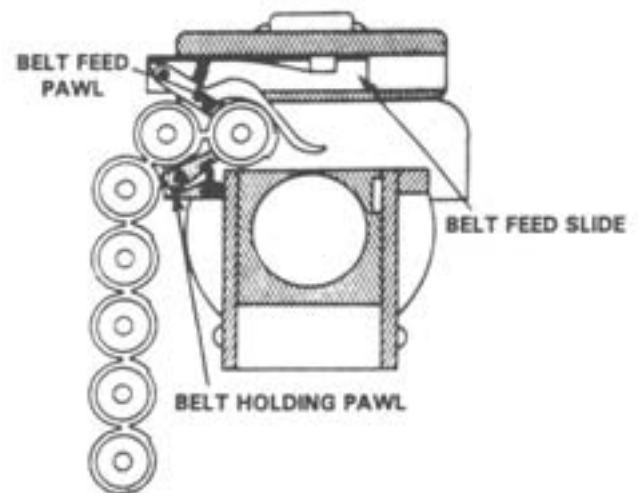

**Figure 4-56. Feeding (Rear View).**

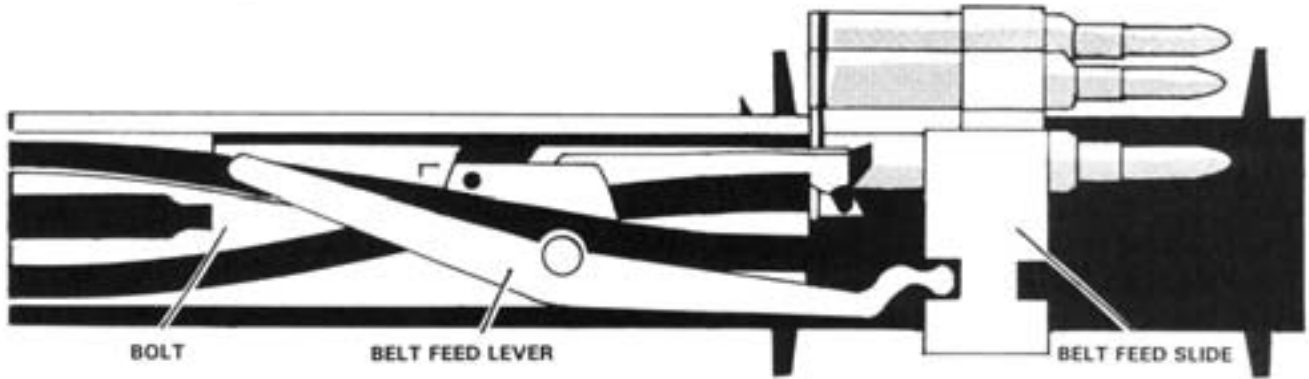

Figure 4-57. Feeding (Top View).

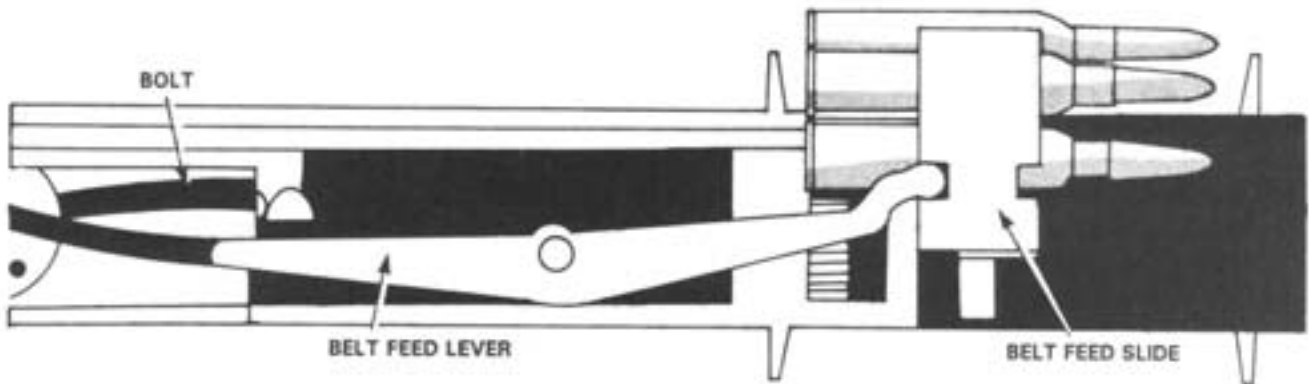

Figure 4-58. Belt Feed Slide Moving Out of the Side of the Cover.

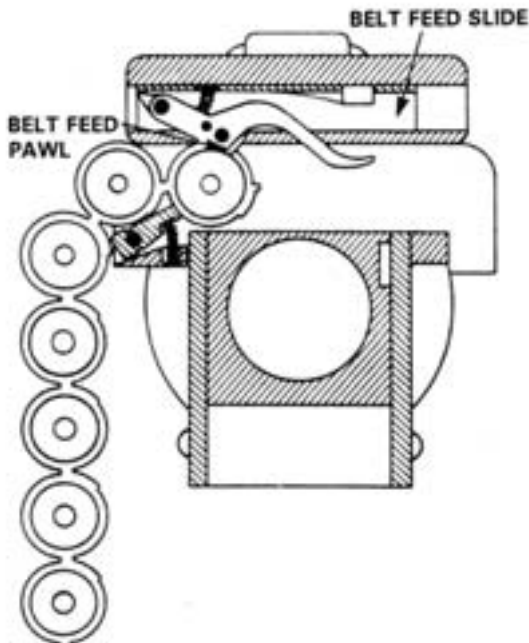

Figure 4-59. Belt Feed Pawl Riding Over the First Round

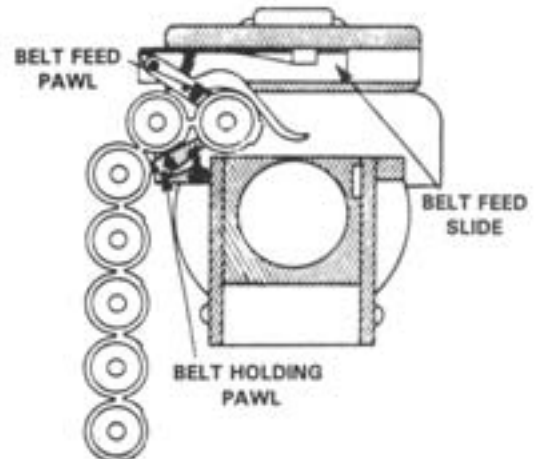
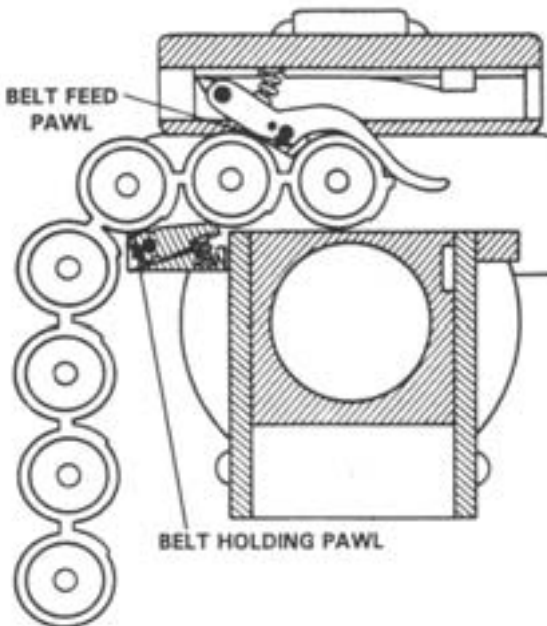

Figure 4-60. Belt Feed Pawl Behind the First Round.

As the bolt moves forward, the belt feed lever moves the slide back into the receiver. The belt is pulled in by the belt feed pawl. The next round rides over the belt holding pawl, compressing its spring and forcing the pawl down until the round has passed over the pawl. See figure 4-61.

When the bolt is fully forward, the slide is back in the cover; the first round is engaged by the extractor. The extractor grips the first round in the feedway and, as the recoiling parts move to the rear, withdraws it from



**Figure 4-61. Belt Feed Slide Moving Inside the Cover.**

the ammunition belt. Initially, the grip of the extractor is held secure by the downward pressure of the cover extractor spring.

### NOTE

If for any reason a round is not extracted from the belt, the belt feed pawl arm will ride up over the round, holding up the belt feed pawl to prevent double feeding.

As the bolt continues its movement to the rear, the cover extractor cam forces the extractor down, causing the cartridge to enter the T-slot in the bolt. As the extractor is forced down, the extractor lug, riding along the top of the extractor switch, forces the rear end of the extractor switch downward. Near the end of the rearward movement, the extractor lug overrides the end of the switch and the switch snaps back up into position.

### 4402. Chambering

As the bolt moves forward, the round is held by the T-slot and the extractor assembly. The extractor stop pin (on the left side of the bolt) permits the extractor assembly to go down only far enough to align the round with the chamber. As the bolt continues forward, the round is chambered. As this action takes place, the extractor lug rides up the extractor cam, compressing the cover extractor spring and snaps into the groove in the next cartridge base through the pressure of the spring. See figure 4-62.

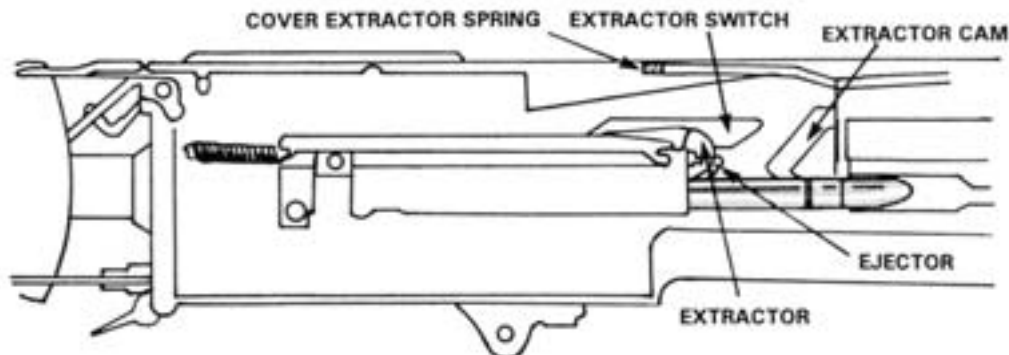

**Figure 4-62. Chambering.**

### 4403. Locking

Initially, the bolt is forced forward in counterrecoil by the energy stored in the driving spring assembly and the compressed buffer disks. At the start of counterrecoil, the barrel buffer body tube lock keeps the accelerator tips from bouncing up too soon and catching in the breech lock recess in the bolt. After the bolt travels forward about 5 inches, the lower rear projection of the bolt strikes the tips of the accelerator, turning the accelerator forward. This unlocks the barrel extension from the barrel buffer body group and releases the barrel buffer spring. The barrel buffer spring expands, forcing the piston rod forward.

Since the cross groove in the piston rod engages the notch on the barrel extension shank, the barrel extension and barrel are also forced forward by the action of the barrel buffer spring. Some of the forward motion of the bolt is transmitted to the barrel extension through the accelerator. As the accelerator rotates forward, the front of the accelerator speeds up the barrel extension; at the same time, the accelerator tips slow down the bolt.

Locking begins 1 1/8 inches before the recoiling groups (bolt, barrel extension, and barrel) are fully forward. The breech lock in the barrel extension rides up the breech lock cam in the bottom of the receiver into the breech lock recess in the bottom of the bolt, locking the recoiling groups together. The

recoiling groups are completely locked together three-fourths of an inch before the groups are fully forward. See figure 4-63.

### 4404. Firing

As the trigger is pressed down, it pivots on the trigger pin so that the trigger cam on the inside of the back plate engages and raises the rear end of the trigger lever. That, in turn, pivots on the trigger lever pin assembly, causing the front end of the trigger lever to press down on the top of the sear stud. The sear is forced down until the hooked notch of the firing pin extension is disengaged from the sear notch. The firing pin and firing pin extension are driven forward by the firing pin spring. The striker of the firing pin hits the primer of the cartridge, firing the round. See figure 4-64.

For automatic firing, the bolt latch release must be locked, or held depressed, so that the bolt latch will not engage the notches in top of the bolt. Hold the bolt to the rear, as in single shot firing. The trigger is pressed and held down. Each time the bolt travels forward in counter-recoil, the trigger lever depresses the sear, releasing the firing pin extension assembly. The firing pin automatically fires the next round when the forward movement of the recoiling groups is nearly completed. The gun should fire about 1/16 inch before the recoiling groups are fully forward. At the instant

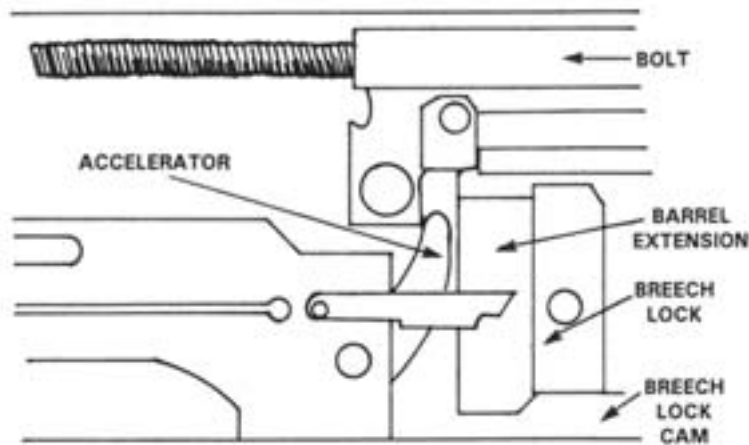

Figure 4-63. Locking.

of firing, the parts are in battery; i.e., the proper position for firing. Only the first round should be fired with the parts fully forward. The gun fires automatically as long as the trigger and bolt latch are held down, and ammunition is fed into the gun.

#### 4405. Unlocking

At the instant of firing, the bolt is locked to the barrel extension and against the rear end of the barrel by the breech lock, which is on top of the breech lock cam and in the breech lock recess in the bottom of the bolt.

When the cartridge explodes, the bullet travels out of the barrel. The force of recoil drives the recoiling groups rearward. During the first  $\frac{3}{4}$  inch, the recoiling groups are locked together. As this movement takes place, the breech lock is moved off the breech lock cam stop, allowing the breech lock depressors (acting on the breech lock pin) to force the breech lock down, out of its recess from the bottom of the

bolt. At the end of the first  $\frac{3}{4}$  inch of recoil, the bolt is unlocked, free to move to the rear, independent of the barrel and barrel extension.

As the recoiling groups move to the rear, the barrel extension causes the tips of the accelerator to rotate rearward. The accelerator tips strike the lower rear projection of the bolt, accelerating the movement of the bolt to the rear. The barrel and barrel extension continue to travel to the rear an additional  $\frac{3}{8}$  inch or an approximate total distance of  $1 \frac{1}{8}$  inches, until they are stopped by the barrel buffer assembly. See figure 4-65, step 1.

During the recoil of  $1 \frac{1}{8}$  inches, the barrel buffer spring is compressed by the barrel extension shank since the notch on the shank is engaged in the cross groove in the piston rod head. The spring is locked in the compressed position by the claws of the accelerator, which engage the shoulders of the barrel extension shank. After its initial travel of  $\frac{3}{4}$  of an inch, the

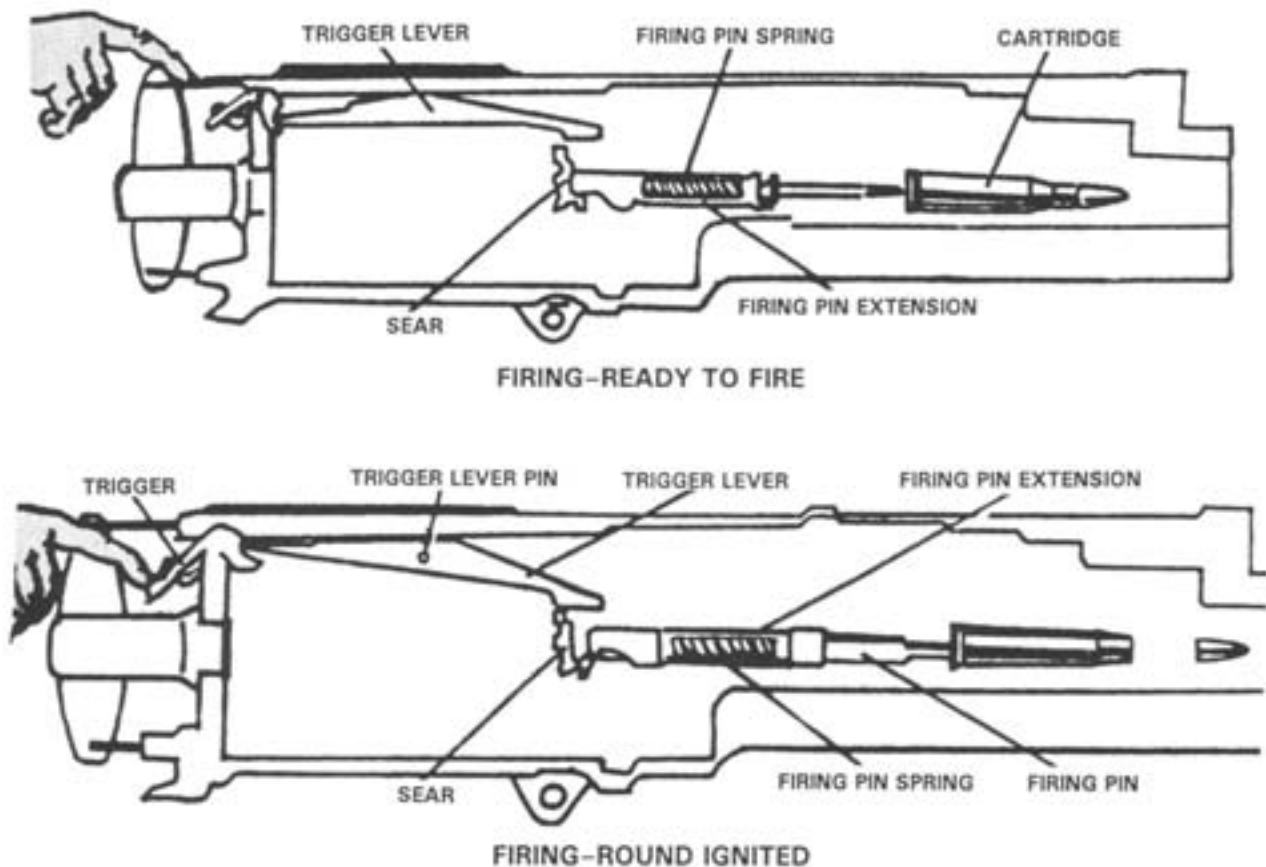

Figure 4-64. Firing.

bolt travels an additional 6 3/8 inches to the rear after it is unlocked from the barrel and barrel extension, for a total of 7 1/8 inches. During this movement, the driving springs are compressed. The rearward movement of the bolt is stopped as the bolt strikes the buffer plate. Part of the recoil energy of the bolt is stored by the driving spring rod assembly, and part is absorbed by the buffer disks in the back plate. See figure 4-65, step 2.

#### 4406. Extracting

The empty case, held by the T-slot, has been expanded by the force of the explosion; therefore, it fits snugly in the chamber. If the case is withdrawn from the chamber too rapidly, it may be torn. To prevent this, and to ensure slow initial extraction of the case, the top forward edge of the breech lock and the forward edge of the lock recess in the bolt

are beveled. As the breech lock is unlocked, the initial movement of the bolt away from the barrel and barrel extension is gradual. The slope of the locking faces facilitates locking and unlocking and prevents sticking. The leverage of the accelerator tips on the bolt speeds extraction, after it is started, by kicking the bolt to the rear to extract the empty case from the chamber.

#### 4407. Ejecting

As the bolt starts its forward movement (counter-recoil) the extractor lug rides below the extractor switch, forcing the extractor assembly farther down, until the round is in the center of the T-slot. The round, still gripped by the extractor, ejects the empty case from the T-slot. The last empty case of an ammunition belt is pushed out by the ejector.

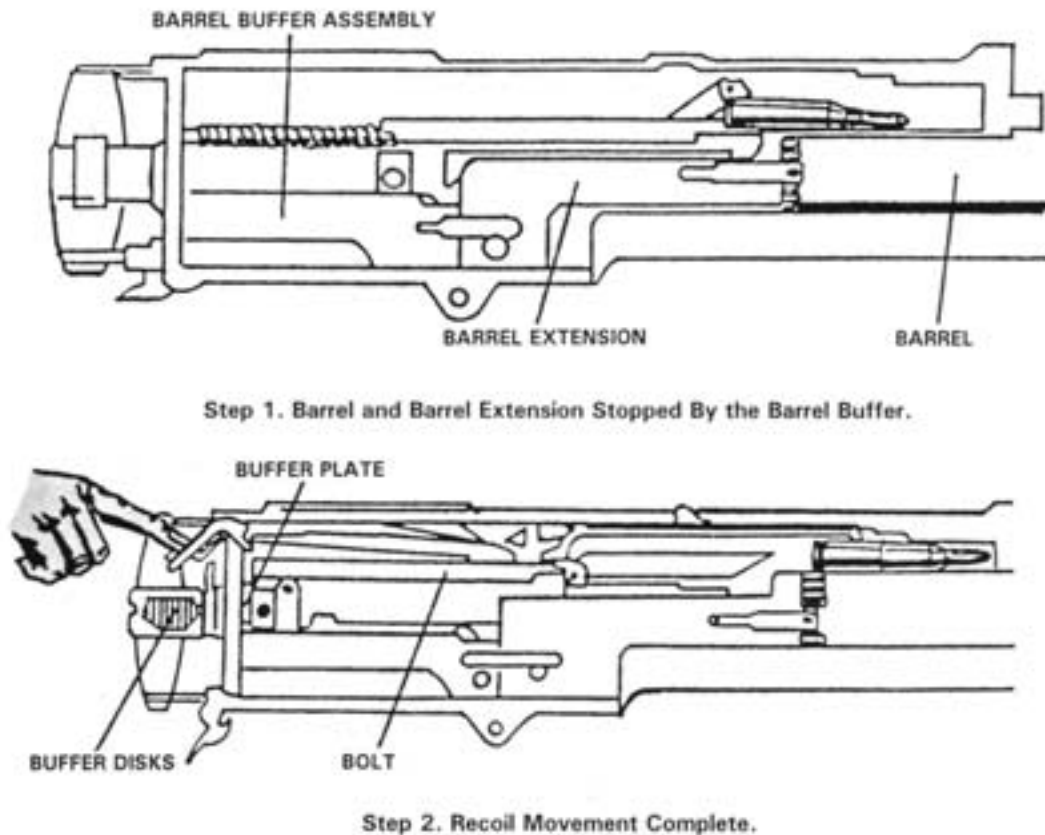

Figure 4-65. Unlocking.

### 4408. Cocking

When the recoiling groups are fully forward, the top of the cocking lever rests on the rear half of the V-slot in the top plate bracket. As the bolt moves to the rear, the top of the cocking lever is forced forward. The lower end pivots to the rear on the cocking lever pin. The rounded nose of the cocking lever, which fits through the slot in the firing pin extension, forces the extension to the rear, compressing the firing pin spring against the sear stop pin (accelerator stop). As the firing pin extension is pressed to the rear, the hooked notch of the extension rides over the sear notch, forcing the sear down. The sear spring forces the sear back up after the hooked notch of the firing pin extension has entered the sear notch. The pressure of the sear and firing pin springs hold the two notches locked together. There is a slight overtravel of the firing pin extension in its movement to the rear, to ensure proper engagement with sear. As the bolt starts forward, the overtravel is taken up and completed when the cocking lever enters the V-slot of the top plate bracket, and is cammed towards the rear. Pressure on the cocking lever is relieved as the bolt starts forward.

---

## Section 5 Malfunctions and Stoppages

---

Machine gunners must have a detailed understanding of the many component parts of their weapon, what those parts do during functioning, and what mechanical problems may be encountered during firing. This knowledge ensures that those problems can be quickly assessed and corrective action taken.

### 4501. Malfunctions

A malfunction is any failure of the gun to function satisfactorily.

**a. Sluggish Operation.** Instead of firing at its normal rate, a sluggish gun fires very slowly. Sluggish

operation is usually due to human failure to eliminate excessive friction caused by dirt, lack of proper lubrication, and burred parts, or by tight headspace adjustment or incorrect timing.

**b. Runaway Gun.** A runaway gun is when a gun continues to fire after the trigger is released; firing is uncontrolled. If the cause is present before the gun is fired, the gun will start to fire when the recoiling groups move into battery the second time. If the defect occurs during firing, the gun will continue firing when the trigger control mechanism is released.

A runaway gun may be caused by the following:

- Bent trigger lever, forward end of the trigger lever sprung downward.
- Burred beveled contacting surfaces of the trigger lever and sear.
- Jammed or broken side plate trigger.

To remedy uncontrolled automatic fire—

- Keep the gun laid on target and let the gun fire out all remaining ammunition.
- In an emergency, twist the ammunition belt. This causes the gun to jam, and may damage the feeding mechanism.
- Replace broken, worn, or burred parts. Check the side plate trigger and trigger control mechanism, when applicable.

### 4502. Stoppages

A stoppage is any interruption in the cycle of operation caused by the faulty action of the gun or ammunition. Immediate action is required by the gunner to reduce a stoppage (see paragraph 4503). The most common stoppages with M2 .50 cal are failure to feed, failure to chamber, or failure to fire. The procedures outlined in figure 4-66 will assist in troubleshooting and reducing most stoppages without analyzing their cause in detail.



NATURE OF STOPPAGE	USUAL CAUSES	OTHERS CAUSES
Failure to feed.	Defective ammunition belt. Defective feed mechanism. Defective extractor.	Improperly loaded belt. Short round.
Failure to chamber.	Broken part or obstruction in T-slot or chamber. Separated (ruptured) case.	Thick or thin rim, bulged round, set back primer.
Failure to lock.	Incorrect headspace.	Broken parts. Battered breech lock. Barrel breech lock cam. Faulty breech lock cam adjustment.
Failure to fire.	Defective parts in firing mechanism. Defective ammunition. Incorrect timing.	
Failure to unlock.	Broken parts in receiver.	Worn or faulty breech lock cam, or adjustment.
Failure to extract.	Dirty chamber.	Defective cartridge case.
Failure to eject.	Defective ejector.	Burred T-slot.
Failure to cock.	Broken sear. Worn sear notch. Weak sear spring. Worn hooked notch on firing pin extension.	Broken cocking lever.

Figure 4-66. Causes of Stoppages.

### 4503. Immediate Action

Immediate action is that action taken by the gunner and/or crew to reduce a stoppage, without investigating its cause, and quickly return the gun to action. Immediate action is performed by the gunner; however, every crew member must be trained to apply immediate action. Hang fire and cook off are two terms used to describe ammunition conditions that should be understood in conjunction with immediate actions.

A hang fire occurs when the cartridge primer has detonated after being struck by the firing pin but there is some problem with the propellant powder that causes it to burn too slowly creating a delay in firing.

A cook off occurs when the intense heat of the barrel, as a result of prolonged or rapid firing, causes the unintended firing of a cartridge if it remains in the chamber exposed to that heat for too long.

Both a hang fire and cook off can cause injury to personnel or damage to the weapon. To avoid these, always keep the round locked in the chamber with the cover closed in the first 5 seconds after a misfire occurs. This prevents an explosion outside of the gun in the event of a hang fire.

If the barrel is hot, the round must be extracted within the next 5 seconds to prevent a cook off. When more than 150 rounds have been fired in a 2-minute period, the barrel is hot enough to produce a cook off.

If the barrel is hot and the round cannot be extracted within the 10 second total, it must remain locked in the chamber, with the cover closed, for at least 5 minutes to allow cooling of the barrel. This guards against a cook off occurring with the cover open. If the cook off did occur with the cover open, injury to personnel and damage to the weapon could result.

The immediate action procedures for the M2 .50 cal are as follows (see figure 4-67):

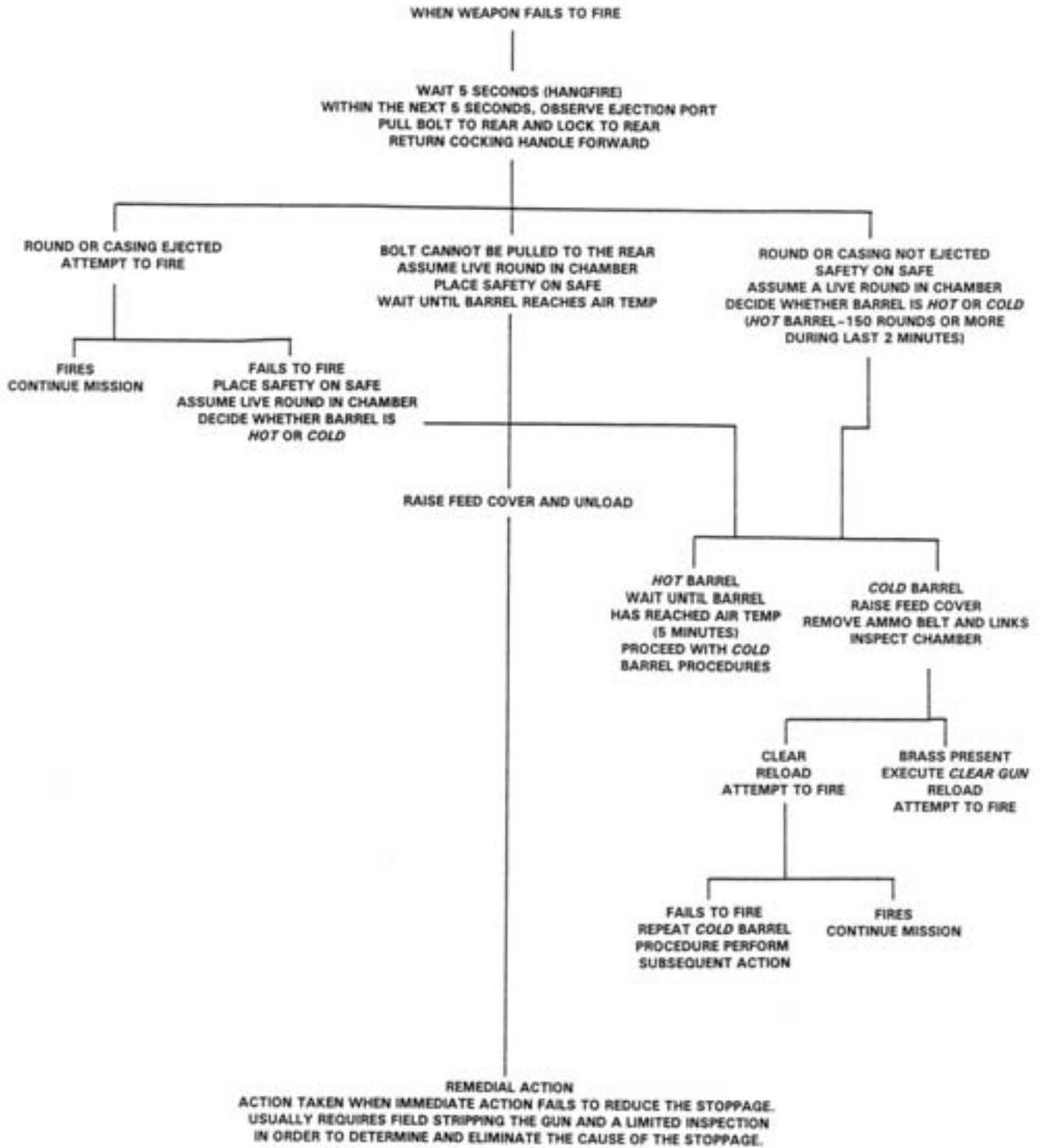

Figure 4-67. Immediate Action.

If gun fails to fire, wait 5 seconds, a hang fire may be causing the misfire. In the next 5 seconds, pull the bolt to the rear (check for ejection and feeding of belt), release it, relay on the target and attempt to fire.

### NOTE

When the bolt latch engages the bolt and holds it to the rear, the gunner must return the retracting slide handle to its forward position. If the bolt latch release and trigger are depressed at the same time, the bolt goes forward and the weapon should fire automatically.

If the gun again fails to fire, wait 5 seconds, pull the bolt to the rear (engage with bolt latch if applicable), and return the retracting slide handle to its forward position.

- Determine if the barrel is hot or cold before continuing.
- If the barrel is cold, open the cover, remove the belted ammunition and inspect the weapon.
- If the barrel is hot, take action as described above.

### 4504. Remedial Action

When immediate action fails to reduce a stoppage, its cause must be investigated, usually by disassembling the weapon and inspecting the appropriate parts (see figure 4-66). Parts may have to be replaced before the gun can be returned to action. Two other problems may be detected and corrected without the need for disassembly. They are:

**a. Removal of a Cartridge From the T-Slot.** If the cartridge does not fall out, hold the bolt to the rear, and with the extractor raised, use a length of cleaning rod to push the cartridge out the bottom of the receiver.

**b. Removal of a Ruptured Cartridge.** A ruptured (separated) cartridge case may be removed with a cleaning rod or ruptured cartridge extractor. To remove a ruptured cartridge with the ruptured cartridge extractor (caliber .50, 41-E-557-50, 7160041), raise the cover and pull the bolt to the rear. Place the ruptured cartridge extractor in the T-slot of the bolt in the same manner as that of a cartridge, so that it is

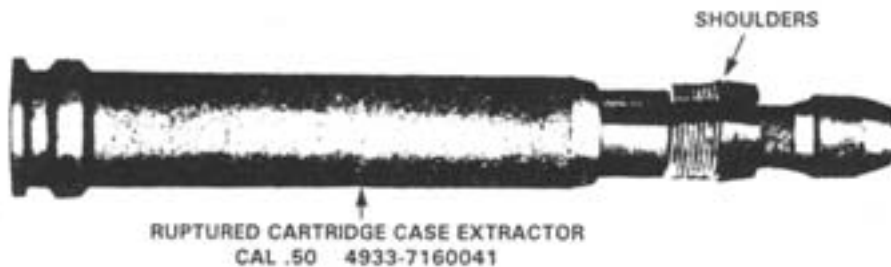

Figure 4-68. Ruptured Cartridge Case Extractor.

held in line with the bore by the ejector of the extractor assembly of the gun. With the ruptured cartridge extractor aligned with the bore and held firmly in the T-slot, let the bolt go forward into battery. This forces the extractor through the ruptured case, and the shoulders will spring out in front of the case. Pull the bolt to the rear and remove the ruptured case and extractor. See figure 4-68. Always check head-space and timing after a ruptured cartridge occurs, and set if necessary.

---

## Section 6

### MOUNTS AND ACCESSORIES

---

The principal ground mount used with the M2 .50 cal is the tripod mount, M3. The tripod mount, M3 is designed for use against ground targets. The three principal vehicular mounts used with the M2 .50 cal are the HMMWV mount; the M66 truck ring mount; and M4 pedestal mount. The M2 .50 cal is also mounted in the up-gunned weapons station on the

AAVP-7A1 and externally mounted on the M1A1 tank. The principal night vision sight used with the M2 .50 cal is the AN/TVS-5.

### 4601. Tripod Mount, M3

The M3 mount is the standard ground mount of the M2 .50 cal (see figure 4-69). It is a folding tripod with three telescopic, tubular legs connected at the tripod head. The total weight of the M3 is 44 pounds, which includes the traversing and elevating (T&E) mechanism and pintle. Each leg ends in a metal shoe that can be stamped into the ground for greater stability. The two trail legs are joined together by the traversing bar. The traversing bar serves as a support for the T&E mechanism, which in turn supports the rear of the gun. The tripod head furnishes a front support for the mounted gun which is further supported by the short front leg.

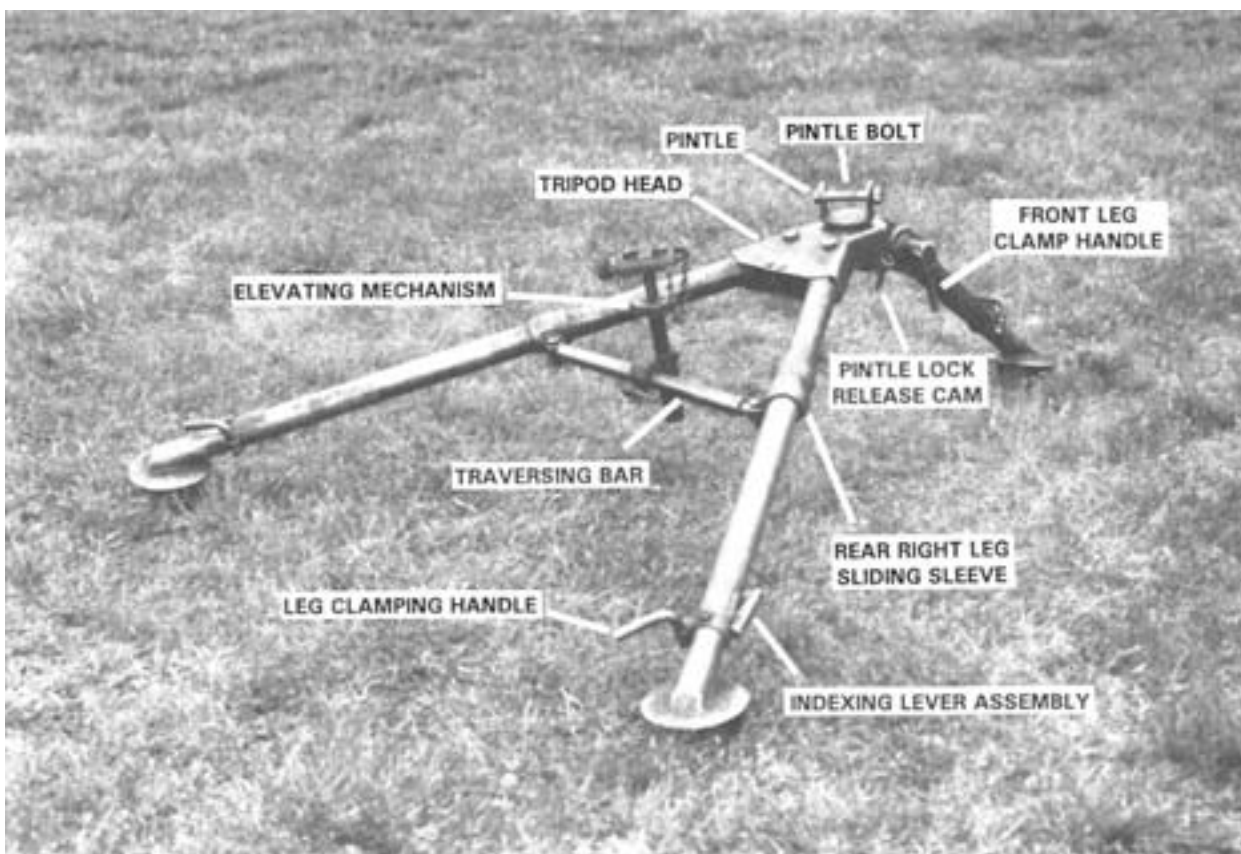

Figure 4-69. Tripod Mount, M3.

When the tripod is emplaced on flat terrain, with all extensions closed, the adjustable front leg should form an angle of about 60 degrees with the ground. This places the gun on a low mount, about 12 inches above the ground. To raise the tripod farther off the ground, extend the telescopic front and trail legs (enough to keep the tripod level and maintain the stability of the mount). To adjust the front leg, turn the front leg clamp screw handle counterclockwise to loosen the front leg clamp screw nut. Adjust the leg to the desired angle, and tighten the front leg clamp. To extend any of the tripod legs, unscrew the leg clamping handle, press down on the indexing lever, and extend the leg to the desired length. Align the stud on the indexing lever with one of the holes in the tripod leg extension. Release pressure on the indexing lever,

allowing the stud to fit the desired hole. Tighten the leg clamping handle.

**a. Traversing and Elevating Mechanism.** See figure 4-70.

**(1) Traversing mechanism.** The traversing mechanism consists of a traversing bar, slide, and screw assembly. The traversing bar, graduated in 5-mil increments and fits between the trail legs of the tripod. The traversing slide and screw assembly are clamped in place on the traversing bar by the traversing slide lock lever. When the traversing slide is locked to the traversing bar, the traversing hand wheel should be centered. The traversing slide is properly mounted when the lock lever is to the rear and the traversing hand wheel is positioned to the left.

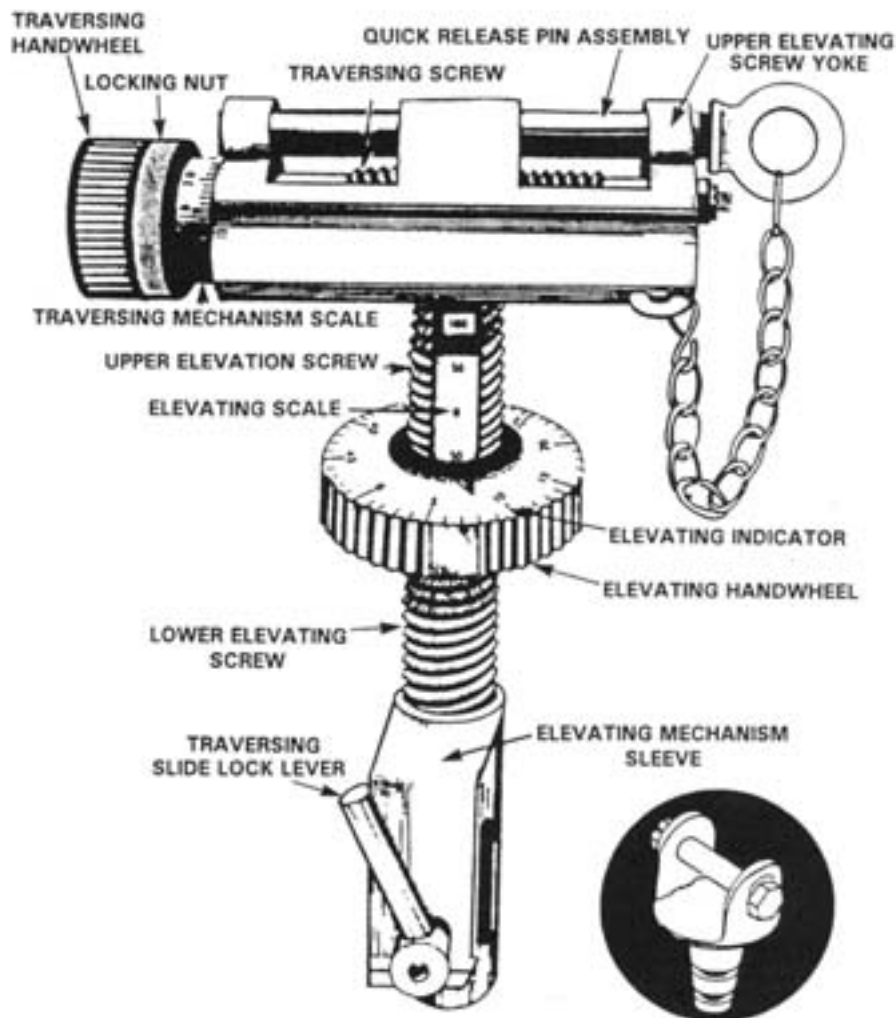

Figure 4-70. T&E Mechanism and Pintle.

To make changes in direction, loosen the traversing slide lock lever and move the slide along the traversing bar. This permits traverse of 400 mils left or right of the 0 index in the center of the traversing bar. Readings on the traversing bar are taken from the left side of the traversing slide. Changes of 50 mils or less in deflection, can be made by turning the traversing hand wheel of the screw assembly. The hand wheel allows a traverse of 50 mils left or right of center. One click in the traversing hand wheel signifies 1-mil change in direction.

**(2) Elevating mechanism.** The elevating mechanism consists of an upper and lower elevating screw and is connected to the gun by inserting the quick release pin assembly through the holes in the upper elevating screw yoke and the rear mounting lugs of the receiver. A scale, graduated in mils, is fitted to the upper screw to indicate elevation. This scale is marked to show 250 mils in depression and 100 mils in elevation from the 0 setting.

The elevating hand wheel is graduated in 1-mil increments up to 50 mils and is fastened to the elevating screw by a screw lock. This synchronizes the hand wheel graduations with those on the upper elevating screw. A spring actuated index device produces a clicking sound when the hand wheel is turned. Each click equals a 1-mil change in elevation. The hand wheel is turned clockwise to depress the barrel and counterclockwise to elevate.

**b. Pintle.** The gun is connected to the tripod mount, M3 by a pintle (see figure 4-70). This pintle is attached to the machine gun by a pintle bolt through the front mounting hole in the receiver. The tapered stem of the pintle seats in the tripod head and is held secure by a pintle lock and spring. To release the pintle, raise the pintle lock, releasing the cam.

## 4602. Vehicle Mounts

**a. Types.** The M2 .50 cal can be mounted on the HMMWV armament carrier, M4 pedestal mount, and M66 ring mount. It is also found in the turret of the AAVP-7A1, and on the M1A1 tank.

The MK64, MOD 5 cradle is used to mount the M2 .50 cal and the MK-19 on the HMMWV armament carrier (see figure 4-71) and on the M4 pedestal mount on M151 series vehicles (see figure 4-72). More information concerning mounting the M2 .50 cal on these vehicles is contained in TM 08686A-13&P/1.



**Figure 4-71. HMMWV Mount With MK64 MOD 5 Cradle.**

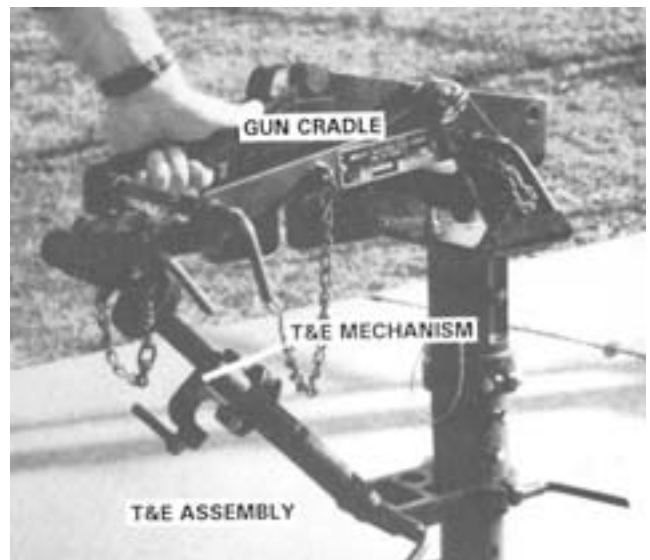

**Figure 4-72. M4 Pedestal Mount With MK64 MOD 5 Cradle.**

The M66 truck ring mount also uses the MK64 cradle to mount the gun onto the mounts roller carriage which is on a circular track (see figure 4-73). The cradle can be rotated in the pintle sleeve of the carriage and can be adjusted for elevation. The carriage is guided on the track by rollers. The track is secured to the vehicle by supports.

**b. Accessories.** There are two accessories needed to mount the M2 .50 cal on vehicles: the pintle adapter and the traversing and elevating mechanism mount assembly.

**(1) Pintle adapter.** The upper end of the pintle adapter has a hole that is shaped to accept the M4 cradle's pintle. The adapter is equipped with a quick-release pintle that secures the carriage and cradle. The lower end of the adapter is shaped to fit the mounting hold in the upper end of the M4 pedestal, HMMWV weapons platform, and the M66 ring mount. It is secured by the pintle lock on the vehicle pedestal. See figure 4-74.

**(2) T&E mechanism mount assembly.** This assembly adapts the T&E so that it secures the carriage and cradle to the M4 pedestal or HMMWV weapons platform pedestal and provides fire control adjustments (see figure 4-75). The lower end of the assembly is attached to the pedestal by a train lock clamp. It may be released for traverse or locked in position by a train lock handle. Two positioning clamps are provided to prevent up or down movement of the traversing lock clamp on the M4 pedestal. When used on the HMMWV weapons platform pedestal, only one clamp is required above the traversing lock clamp. A standard M2 .50 cal traversing mechanism composes the upper end of the T&E assembly. It is attached to the lower rear holes in the M4 cradle by a retaining pin. For more on the T&E mechanism, see chapter 5, section 5.

### 4603. Night Vision Sight, AN/TVS-5

The AN/TVS-5 is a portable, battery-operated electro-optical instrument used for passive night observation and fire. It amplifies natural light such as moonlight, starlight, and skyglow. The sight does

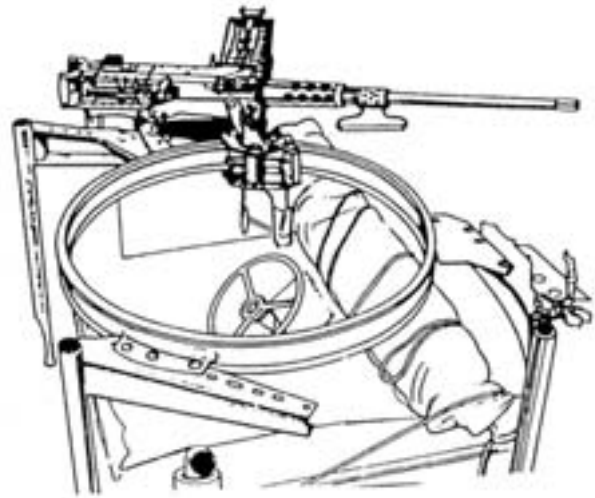

Figure 4-73. M66 Truck Ring Mount.

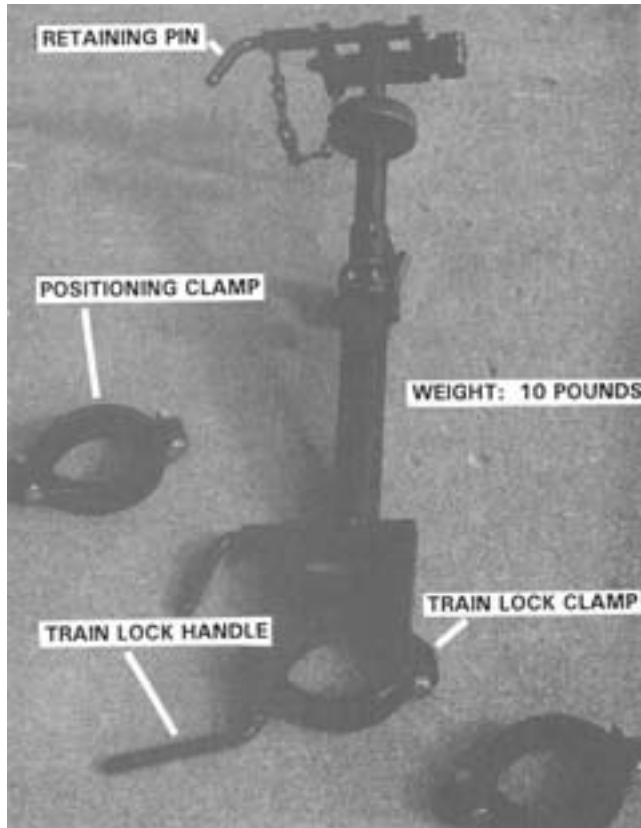

Figure 4-74. Pintle Adapter.

not emit visible infrared light that can be detected by the enemy. The AN/TVS-5 may also be used with the MK19. For more on the AN/TVS-5, see TM 11-5855-214-10.

**a. Installation.** To install the AN/TVS-5—

- Release the catch at the left side of the cartridge cover and raise the cover to the UP position.
- Position the M2 mounting bracket assembly over the breech of the machine gun and slide it to the rear until it stops.
- Swing the three locking cams to the rear to secure the bracket to the weapon side cam first, followed by the two top locking cams.
- Close the cartridge and secure it with the catch.



**Figure 4-75. T&E Mechanism Mount Assembly.**

- Install the sight on the mounting bracket assembly by positioning it in the groove at the top rear of the bracket so that the scribe line on the bracket is aligned with the scribe line in the sight mounting adaptor. Tighten the lever screw to secure the sight to the bracket. It will be easier to tighten the lever screw if you place an empty cartridge case over the lever arm to increase the amount of leverage applied.

**b. Use of the Reticle Cell.** The proper reticle cell must be installed in the AN/TVS-5 before the sight can be used for aimed fire of the M2 .50 cal. The AN/TVS-5 is normally equipped with a reticle for the M2 .50 cal and M85. If not, installation of the proper reticle must be performed by direct support of higher category maintenance.

**(1) M2 .50 cal/M85 reticle pattern.** The vertical lines at the top of the reticle indicate range in hundreds of meter to a 6-foot tall standing person. Measurement is made from the horizontal line to the top or bottom of the vertical line (see figures 4-76 and 4-77).

The horizontal line of the range scale indicates the range in hundreds of meters to a 20-foot wide target (such as a tank viewed from the side). Place the left edge of the target at the left side of the horizontal line. The range to the target is read at the right edge of the target. The M2 .50 cal aiming points for ranges from 400 to 1,200 meters are shown as small dots in a vertical line through the center of the reticle. Use the center of the horizontal lines for ranges of 0-250 meters. Locate the target, estimate the range, and adjust the weapon to place the proper aiming point on the target.

**(2) MK-19/M2 .50 cal reticle pattern.** See figure 4-78. Aiming points are the same as the M2 .50 cal/M85 reticle. The stadia lines are used to determine range to a 20-foot wide target. Manipulate the sight picture so that the target fills the space between the stadia lines in order to determine the corresponding range to the target. MK-19 aiming points for stationary targets are aligned vertically in the center of the reticle. Aiming points for a target moving 10 mph are located vertically to the left and right of the stadia lines.

**c. Field Zeroing.** The AN/TVS-5 may be zeroed during daylight or darkness. For the zeroing procedure, see paragraph 2505.c.

---

## Section 7 Maintenance

---

Care, cleaning, and maintenance determine whether or not the gun will function properly when needed. The bore and chamber must be properly maintained to preserve accuracy. Because of the close fit of working surfaces and the high speed at which the gun operates, the receiver and moving parts must be kept clean, correctly lubricated, and free from burrs, rust, dirt, or grease to ensure proper, efficient functioning. The care, cleaning, lubrication, and adjustment of the mounts used with the gun are no less important. The functioning of the gun and mount together determine overall effectiveness. All accessories and equipment used with the gun and mount, including ammunition, must be properly maintained.



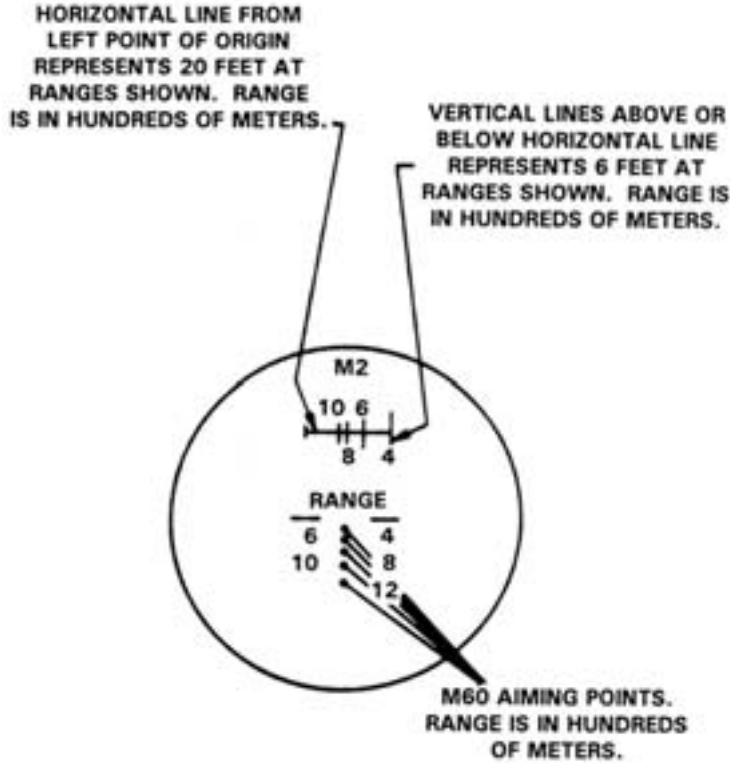

Figure 4-76. M2 .50 Cal and M85 Reticle Pattern.

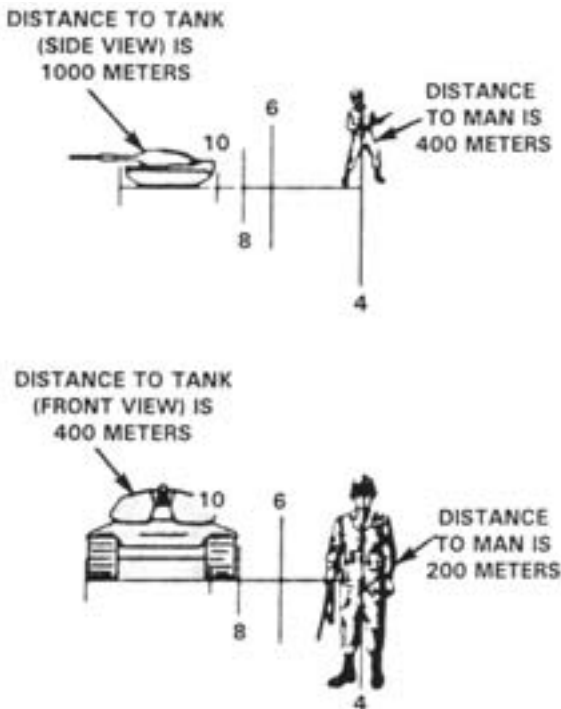

Figure 4-77. Use of Ranging Symbols M2 and M85.

### 4701. Cleaning Materials and Lubricants

a. **Cleaning Materials.** CLP is a special cleaning solution and lubricant containing teflon that can be used to clean and preserve all the metal parts of the weapons system. It may be used as a lubricant during normal operation of the gun also. RBC can be used to clean the bore of the machine gun barrel after firing. Immediately after using bore cleaner, dry the bore and any parts of the gun exposed to the bore cleaner; then apply a thin coat of CLP or lubricating oil. Dry cleaning solvent can also be used to clean all metal parts of the weapons system. This material dries out the metal severely so a thin coat of CLP or lubricating oil should be applied afterwards. This cleaning material is especially useful when cleaning the gun in preparation for changing the type of lubricant used.

If RBC and CLP are not available, hot or cold water can be used; however, warm or hot, soapy water is recommended. After using soap and water, dry the parts immediately and apply a thin coat of CLP.

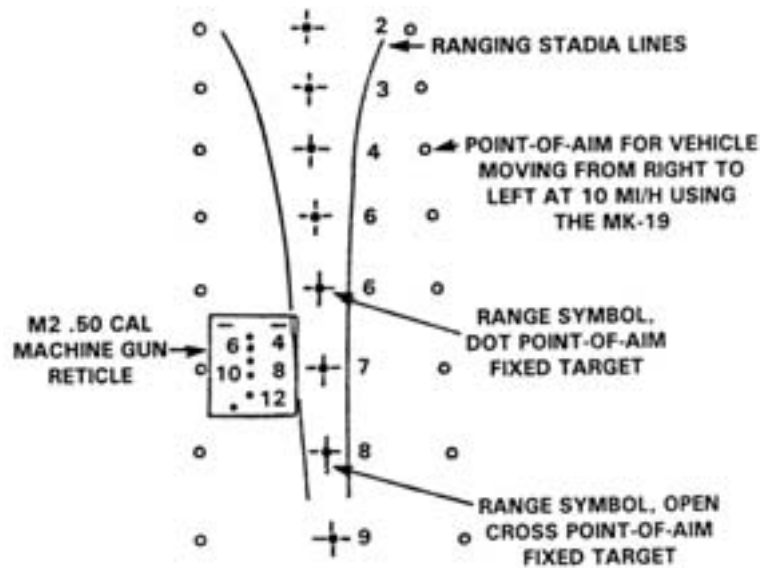

Figure 4-78. Dual-Purpose Sight (Under Development).

**b. Lubricants.** LSA is the preferred lubricant for use on all friction producing parts during operation of the gun in normal conditions. It will not burn off the gun as it heats up during operation nor will rain or excess moisture wash it off. LAW should be used during operation of the gun in sustained temperatures below 0 degrees Fahrenheit (-18 degrees Celsius). See the cold climate conditions in paragraph. 4704.

#### 4702. Care and Cleaning Before, During, and After Firing

Gun crews must conduct procedures for the care and cleaning of their weapons system before, during, and after firing. These procedures are outlined in figure 4-79.

#### 4703. Normal Maintenance Procedures

Each gun should be cleaned as soon after firing as possible and each time it is exposed to field conditions. In

combat conditions the gun should be cleaned and lubricated daily whether or not it has been fired. If possible, keep the gun covered with a canvas, tarpaulin, or poncho when not in use. During normal training conditions, inspect the gun daily for rust, and maintain a light coat of CLP on all metal parts. In ideal conditions, when the gun is not used and is kept in a clean place, it may only be necessary to disassemble and clean it every three to five days. The gun should be disassembled, cleaned, and lubricated in a clean, dry location where it is least exposed to dirt and moisture.

#### 4704. Special Maintenance Procedures

**a. Climatic Conditions.** Extremely cold, hot, dry, and tropical climates affect the gun and its functioning. Care should be taken under these climatic conditions to ensure that the gun is cleaned daily with the prescribed lubricants and protected from the elements by some sort of cover if possible.

WEAPON PART	BEFORE	DURING FIRING OR TEMPORARY CESSATION	AFTER
Bore.	Make sure it is clear and clean.		Clean and lightly oil.
Moving parts.	Oil lightly and test for worn or broken parts. They should function without excessive friction,	Lubricate working parts. Observe the function of the gun to anticipate failures.	Check adjustment.
Headspace and timing.	Check adjustment by guage and correct if necessary.	Watch for bulged cases to prevent a ruptured (separated) case. If a separated case occurs, remove it and readjust headspace.	Check adjustment.
Rear sight and windage knob.	See that the sight is clean and functions properly. Set sight at 1000, windage at zero.	Keep properly set.	Clean and oil. Set at 1000, windage at zero.
Spare parts and tools.	Clean and oil spare parts and tools. Check kits for completeness. Examine newly drawn parts.	Keep available.	Clean and oil. Check and replace damaged or missing parts.
Ammunition.	Have an adequate supply; clean, correctly loaded, and in good condition. DO NOT OIL.	Keep correctly aligned with the feedway. Check resupply. Protect from sun, moisture, and dirt. Watch for link stoppage.	Clean, store carefully, and replenish supply.

Figure 4-79. Care and Cleaning Procedures Before, During, and After Firing.

(1) **Cold climates.** The weapon must be kept free of excess lubrication and moisture. If the weapon is brought indoors, allow it to come to room temperature, and then wipe it dry and proceed with cleaning and lubrication. Lubricate the gun with LSA or CLP and keep it covered outdoors as much as possible. In sustained temperatures below 0 degrees Fahrenheit (-18 degrees Celsius), the weapon should be lubricated with LAW.

(2) **Hot, humid climates.** Inspect the gun more frequently for signs of rust. Keep the gun free of moisture and lightly lubricated with CLP.

(3) **Hot, dry climates.** Inspect and clean the weapon daily. Avoid excess lubrication as this will attract dust, grit and sand.

**b. Nuclear, Biological, and Chemical Conditions.** If contamination is anticipated, apply lubricant

to all outer surfaces of the machine gun (do not lubricate ammunition). Keep the gun covered as much as possible. If the gun is contaminated, decontaminate by following the procedures outlined in FM 3-5, *Nuclear, Biological, and Chemical Decontamination*, then clean and lubricate.

#### 4705. Inspection

When inspected, the machine gun should be completely assembled and mounted with headspace and timing properly set. Inspecting personnel should look for dirt, cracks, burrs, and rust. Operate the gun manually to ensure that it is functioning properly. The inspection procedures shown in figure 4-80 can be used as a guide for crew members or inspecting personnel to ensure that the gun and equipment are properly maintained.

UNIT	INSPECTION
1. GUN	
a. Barrel	Inspect the bore and chamber for rust. See that they are clean and lightly oiled.
b. Moving parts	See that they are clean and lightly oiled. Operate the retracting slide handle and bolt latch release several times to see that the parts function without excessive friction.
c. Headspace and timing	Check with the gauges to ensure that headspace and timing are correct.
d. Rear sight and windage knob	Ensure that the sight is in good condition, clean, free of grease or dirt, and lightly oiled. Elevation should be set at 1000, windage zero, and the sight should be down.
2. MOUNT (M3, MK64, M66, or M4)	See that it is cleaned, lightly lubricated, and that all clamps are securely tightened. It should function properly and be complete.
3. SPARE PARTS AND TOOLS	Inspect to see that they are clean and lightly oiled. See that spare parts kits are complete and in good condition. Replacement parts should be requisitioned and newly drawn parts examined.
4. T&E	See that it is clean, lightly lubricated, and that both handwheels work properly.
5. AMMUNITION	See that ammunition is properly stored and that boxes and ammunition are in good condition and not oiled.

Figure 4-80. Inspection Checklist.

---

## Section 8 Ammunition

---

This section describes the ammunition used in the M2 .50 cal. All machine gunners must be able to recognize the types of ammunition available and know how to care for that ammunition.

The M2 .50 cal cartridge consists of a cartridge case, primer, propelling charge, and bullet. The term bullet refers only to the small arms projectile. The term ball ammunition refers to a cartridge having a bullet that has a metallic jacket and lead core.

### 4801. Classification

Based on use, the principal classification of the several types of ammunition used with the machine gun are as follows:

- a. **Ball.** For use in marksmanship training and against personnel and light material targets.
- b. **Tracer.** To aid in observing fire. Secondary purposes are for incendiary effect and for signaling.
- c. **Armor Piercing.** For use against armored aircraft and lightly armored vehicles, concrete shelters, and other bullet-resisting targets.

- d. **Incendiary.** For incendiary effect, especially against aircraft.
- e. **Armor-Piercing Incendiary.** For combined armor-piercing and incendiary effect.
- f. **Armor-Piercing Incendiary Tracer.** For combined armor-piercing and incendiary effect with the additional tracer feature.
- g. **Sabot Light Armor Penetrator.** For use against light armored vehicles and aircraft. Also called SLAP.
- h. **Sabot Light Armor Penetrator-Tracer.** For use against light armor vehicles and aircraft with the additional tracer feature. Also called SLAP-T
- i. **Blank.** For simulated fire (contains no bullet).
- j. **Ball, Plastic Practice.** For use in scaled range training. For example, where range restrictions limit or prohibit use of one of the other types of live ammunition.
- k. **Tracer, Plastic Practice.** For use with the SLAP-T in scaled range training.
- l. **Dummy.** A dummy is completely inert. For use in nonfiring training such as gun drill and to practice loading and unloading procedures.

#### 4802. Identification

- a. **Marking.** The contents of original boxes or containers may be readily identified by markings on the box. They indicate, by stencil, the number of rounds in the box or container, the caliber, the code symbol, and the lot number.

- b. **Code Symbol.** The code symbols for machine gun ammunition indicate the grade as well as contents and type of inner packing. To provide proper identification, the abbreviated markings are stenciled in yellow on each metal ammunition container, together with the re-packed lot number.

- c. **Ammunition Marking.** Ammunition can be identified by its physical characteristics. Colors painted on the tips of the bullet aid in this identification. The physical characteristics and tip colors used to identify M2 .50 cal ammunition types can be found in figure 4-81.

- d. **Ammunition Grades.** The grades for caliber .50 cal ammunition are as follows:

- AC aircraft and antiaircraft machine guns.
- MG Ground machine guns.
- 3 Unserviceable, not to be issued or used.

More than one grade may be authorized for ammunition. As an example, AC or MG ammunition may be used for both aircraft and antiaircraft machine guns and ground machine guns. Ammunition that cannot be identified is considered grade 3, but is not classified unserviceable until every effort has been made to establish its identity. Ammunition placed in grade 3 (due to loss of lot number) and identification as having been in serviceable lots issued to a specific organization, may be reissued after visual inspection for local training purposes (graded for training purposes only) in ground machine guns. It will not be used for overhead fire. See figure 4-82 on pages 50 and 51.

CARTRIDGE TYPE	DODAC NO.	IDENTIFICATION
Ball (M2)	1305-A552	Plain metal bullet.
Ball (M33)	1305-A555	Plain metal bullet.
Tracer (M1)	1305-A591	Tip is painted red.
Tracer (M17)	1305-A571	Tip is painted brown.
Armor Piercing (M2)	1305-A526	Tip is painted black.
Incendiary (M1)	1305-A562	Tip is painted blue.
Armor-Piercing Incendiary (M8)	1305-A531	Tip is aluminum or tip is painted blue with an aluminum ring.
Armor-Piercing Incendiary Tracer (M20)	1305-A542	Tip is painted red with an aluminum ring.
Saboted Light Armor Penetrator (M903)	1305-A518	Round is a Tungsten penetrator in an amber-tinted sabot.
Saboted Light Armor Penetrator-Tracer (M962)	N/A	Round is a Tungsten penetrator in a red-tinted sabot.
Blank (M1A1)	1305-A598	No bullet.
Ball, Plastic Practice (M858)	1305-A603	Blue plastic bullet and case.
Tracer, Plastic Practice (M680)	1305-A595	Blue plastic bullet with red tip and plastic case.
Dummy (M2)	1305-A560	Three holes are drilled in the cartridge case and there is no primer.

Figure 4-81. Characteristics and Tip Colors of M2 .50 Cal Ammunition.

### 4803. Ballistic Data

The approximate maximum range and average muzzle velocity of some of the different types of M2 .50 cal ammunition authorized for use in the machine gun are as shown in figure 4-83.

Figure 4-84 lists the maximum penetration in inches for armor-piercing cartridge, caliber .50, M2, fired

from the 45-inch barrel (muzzle velocity 2935 feet per second).

Figure 4-85 lists the maximum penetration in inches for ball cartridge, caliber .50, M2, fired from the 45-inch barrel (muzzle velocity 2,935 feet per second).

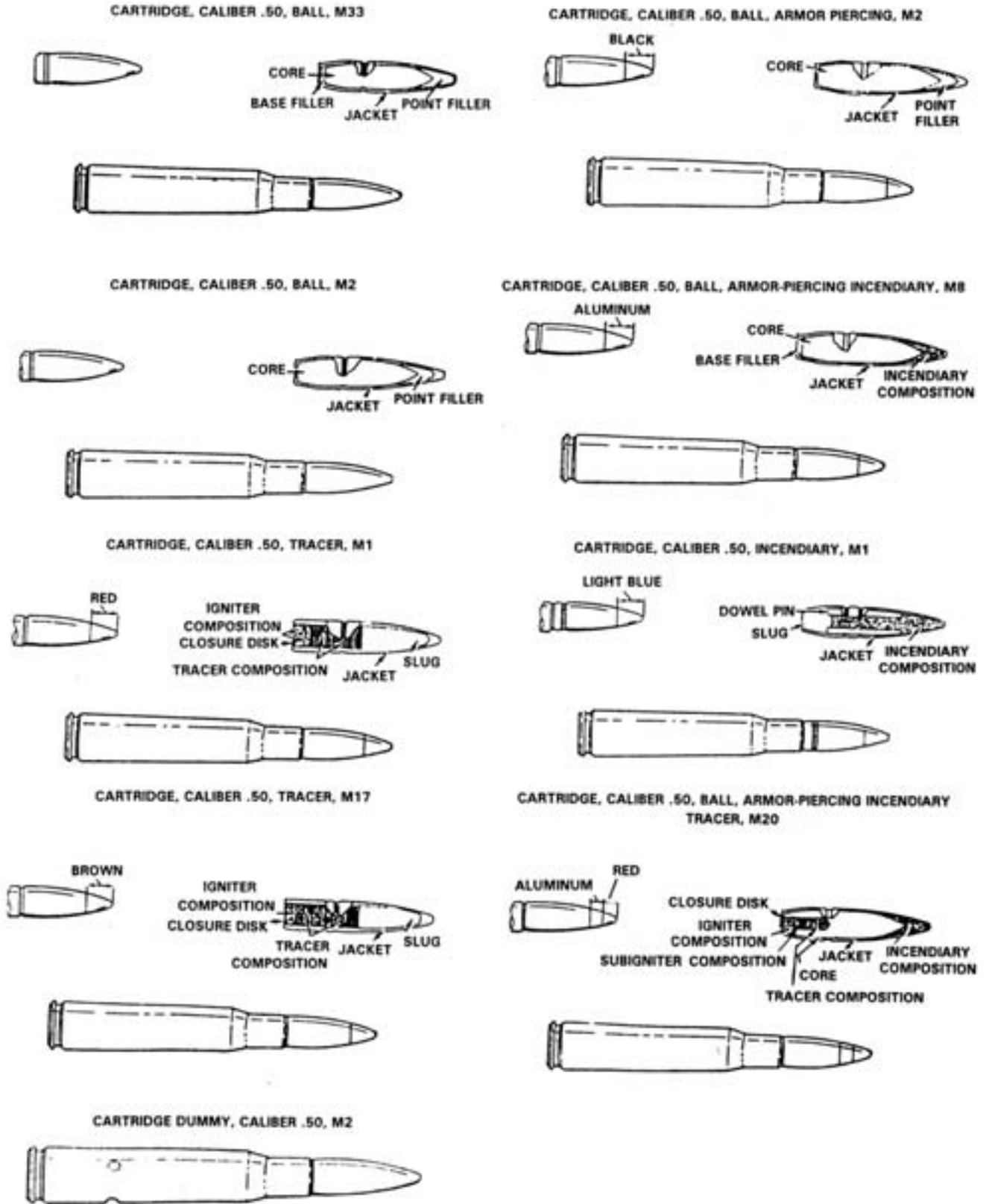
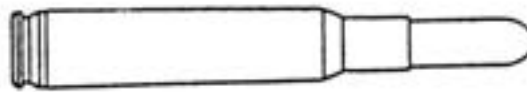
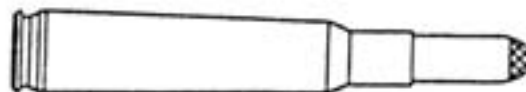

Figure 4-82. M2 .50 Cal Ammunition.

CARTRIDGE, CALIBER .50, BALL, PLASTIC PRACTICE, M858



CARTRIDGE, CALIBER .50, TRACER, PLASTIC PRACTICE, M860



CARTRIDGE, .50 CALIBER, SABOTED LIGHT ARMOR PENETRATING (SLAP) M903

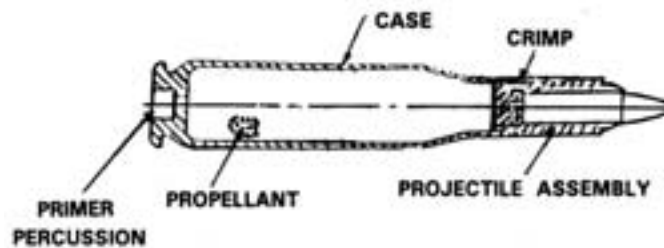

Figure 4-82. M2 .50 Cal Ammunition—Continued.



	PROJ TYPE	PROJ DIA (MM)	PROJ WT(GM)	M.V. (FPS)	TOF(S) 1200M	TOF(S) 2500M	TGT MEAN RAD(MIL)	ARMOR PENETRATION (MM)		CARTRIDGE DIMENSIONS		
								500M	1200M	L (MM)	D (MM)	WT (GM)
M33	Ball	12.7	45.8	2810	2.6	7.7	0.4	8	4	137	21	119
M2	AP	12.7	45.8	2810	2.6	7.7	0.4	19	10	137	21	119
M8	API	12.7	42.9	2910	2.5	6.9	0.4	16	8	137	21	114
M20	APIT	12.7	41.3	2910	2.7	7.8	0.5	21	11	137	21	111
M903 (SLAP)	APDS	7.7	22.6	4000	1.2	3.2	0.7	34	23	137	21	98

Maximum Range : 7600 Meters.

Figure 4-83. Ballistic Data.

MATERIAL	INCHES AT:		
	200 M	600 M	1500 M
Armor plate (homogeneous)	1.0	0.7	0.3
Armor plate (face-hardened)	0.9	0.5	0.2
Sand (100 lb dry w/cu ft)	14	12	16
Clay (100 lb dry w/cu ft)	28	27	21

Figure 4-84. Maximum Penetration for Armor-Piercing Cartridge, M2 .50 Cal.



Figure 4-86. Ammunition Box.

MATERIAL	INCHES AT:		
	200 M	600 M	1500 M
Sand (100 lb dry w/cu ft)	14	12	6
Clay (100 lb dry w/cu ft)	28	26	21
Concrete	2	1	1

Figure 4-85. Maximum Penetration for Ball Cartridge, M2 .50 Cal.

**4804. Ammunition Packaging**

M2 .50 cal ammunition is packaged in a metal box containing 100 linked rounds. Each box of 100 rounds weighs approximately 35 pounds. See figure 4-86.

**4805. Storage**

Store ammunition of all classes away from heat sources; i.e., open flame, radiators, heaters, and hot water pipes. Ammunition should be stored under cover. If it is necessary to leave ammunition in the open, keep it at least 6 inches from the ground and covered with a double thickness of tarpaulin. Place the tarpaulin so it gives maximum protection and allows free circulation of air. Dig suitable trenches to prevent water from flowing under the ammunition pile.

## 4806. Care, Handling, and Preservation of Ammunition

Ammunition containers should not be opened until the ammunition is to be used. Ammunition removed from the airtight containers, particularly in damp climates, is likely to corrode.

Protect ammunition from mud, dirt, and water. If the ammunition gets wet or dirty, wipe it off prior to use. Wipe off light corrosion as soon as it is discovered. Heavily corroded cartridges should be replaced.

Use caution during firing to ensure that ammunition is kept out of the dirt. Dirt picked up during firing will act as an abrasive in the chamber and could cause a malfunction that may result in injury to personnel and/or damage to equipment.

DO NOT expose ammunition to direct rays of the sun. If the powder is hot, excessive pressure may be developed when the gun is fired.

DO NOT oil or grease ammunition. Dust and other abrasives will collect on it and could damage the operating parts of the gun.

DO NOT fire dented cartridges, cartridges with loose projectiles, or other defective rounds.

DO NOT fire over friendly troops any ammunition graded and marked FOR TRAINING USE ONLY. Only specially approved lots of ammunition can be used for overhead fire. The packaging of this ammunition is clearly stamped FOR OVERHEAD FIRE.

DO NOT fire ammunition (other than blank ammunition) until it has been positively identified by ammunition and grade.

---

## Section 9 Operation and Firing

---

Operation includes loading and unloading the gun, clearing the gun, and allowing the bolt to go forward.

### 4901. Half Loading and Loading

To half load the gun, the gunner ensures the bolt is forward and the cover is closed. The squad leader inserts the double loop end of the ammunition belt in the feedway until the first round is engaged by the belt holding pawl. The gunner grasps the retracting slide handle with the right hand, palm up, and vigorously jerks the bolt to the rear and releases the retracting slide handle. If the bolt latch release lock is engaging the bolt latch release, the bolt and retracting slide handle will move forward under pressure of the driving spring group, half loading the gun. However, if the bolt latch release is up and free of the bolt latch release lock, the bolt latch will hold the bolt and the retracting slide handle to the rear. The retracting slide handle must be returned to its most forward position prior to releasing the bolt. To complete half loading, press the bolt latch release, allowing the bolt to go forward.

To fully load the gun, the procedure is the same as in half loading, except it requires the gunner to pull and release the bolt twice.

### 4902. Single Shot Operation

To fire the gun single shot, the bolt latch release must be in the up position. The latch engages the notches on top of the bolt when the bolt is to the rear after each round is fired. When the bolt latch release is depressed the latch assembly is raised, allowing the

bolt to be driven forward into battery. The gun may then be fired by pressing the trigger. When the bolt latch release is locked down by the bolt latch release lock on the buffer tube sleeve, the gun functions as an automatic weapon.

### 4903. Precautions During Operation

Ensure that the cover, once raised, remains in the raised position, with the barrel remaining in the gun, before allowing the bolt to go forward. If the cover is lowered when the bolt is to the rear, the belt feed lever lug will not fit into its proper groove in the bolt. Thus, parts may be damaged as the bolt goes forward. In the cover assembly, the belt feed lever lug is held to the left by the action of the shoulder headless pin and spring, just above the pivot.

If the bolt is allowed to go forward with the barrel out of the gun, parts may be damaged when the bolt slams forward. The added weight and cushioning effect of the barrel act as a buffer and protect the parts from damage.

To allow the bolt to go forward with the barrel out of the gun, pull the retracting slide handle all the way to the rear, engaging the bolt stud in the notch in the rear of the retracting slide. Maintain a steady pressure to the rear on the retracting slide handle. Press the bolt latch release and allow the bolt to ride slowly forward.

### 4904. Unloading and Clearing the Gun

**a. Unloading.** To unload the gun, the gunner unlocks the bolt latch release (if applicable) and then pulls the retracting slide handle to the rear and holds it there. The squad leader then removes the round that was ejected out of the bottom of the gun. The gunner then raises the cover and the squad leader removes the ammunition belt from the feedway. The gunner then examines the chamber and T-slot. If there is a round on the T-slot the gunner pulls the bolt an additional 1/16 inch to the rear and pushes the round up and out of the T-slot by reaching under the gun and forcing the round up the face of the bolt. In darkness, the gunner must feel the chamber and T-slot to see if it is clear.

**b. Clearing.** To clear the gun, additional precautions are taken. After the steps above have been

accomplished, a wooden block, extending above and below the receiver approximately 1 inch, is inserted in the receiver between the bolt and the rear of the barrel. A cleaning rod is then inserted in the muzzle end of the barrel, pushed through the bore until it can be seen in the receiver, and immediately removed. See figure 4-87.



Figure 4-87. Clearing the Gun.

---

### CAUTION

---

During any temporary cessation of fire, where it is not necessary to unload to clear the gun, the bolt should be latched to the rear to prevent accidental firing.

---

### 4905. Positions for Firing

The M2 .50 cal can be fired from the prone or sitting position with the gun mounted on the tripod in low position, or from a sitting position with the gun mounted on the tripod in high position.

**a. Prone Position.** In the prone position, the gunner is between the trail legs with his body extending directly to the rear of the gun (see figure 4-88). The inside of his feet are as flat as possible on the ground, legs well spread, toes turned outward. His left elbow rests on the ground with the left hand placed on the elevating handwheel, palm down. The gunner lightly grasps the right spade grip with his right hand, thumb in position to press the trigger. The position of the body varies according to the physique of the individual so that the eye is in the proper position to align the sights.

**b. Sitting Position.** In the sitting position, the gunner sits directly between the trail legs of the tripod. Depending on his physique the gunner can sit with his legs crossed right over left (see figure 4-89), or extended. With his legs crossed, his right foot can be placed on the traversing slide locking lever to ensure that the T&E stays locked down during firing. With his legs extended, he can place them under the rear legs of the tripod or over the top of them (see figure 4-90). He grasps the elevating hand wheel with his left hand, palm down. He lightly grasps the right spade grip with his right hand, thumb in position to press the trigger. His right arm will



**Figure 4-88. Prone Position.**



**Figure 4-89. Sitting Position, Legs Crossed.**



**Figure 4-90. Sitting Position, Legs Extended.**

be placed on the outside of his right leg pushing to the right to take up slack in the T&E.

**c. HMMWV, Pedestal or Truck Mount.** With the HMMWV, pedestal or truck mounts, the gunner places both hands on the spade grips, locks his elbows into the sides of his body with his body forward and chest against his hands, thumbs in position to press the trigger. Brace the body and arms firmly during firing.

---

### **Section 10 Gun Drill**

---

The M2 .50 caliber machine gun, employed on the M3 tripod, requires a crew of three to put it into action

and keep it operating. Gun drill gives the gun crew fundamental training in the operations of the machine gun and the confidence in their ability to put the gun into action with precision and speed. Precision is attained by learning and practicing correct procedures, to include inspecting the gun before firing and observing safety procedures. Once precision is attained, speed and teamwork can be developed. Rotation of duties during training is essential so that every crew member becomes familiar with the duties of each position in the gun crew.

### **NOTE**

Live ammunition is *never* used for a gun drill. Only dummy ammunition should be used for this type of training.

### 41001. Crew Equipment

In addition to their individual arms and equipment, machine gun crewmen carry the following:

Squad Leader	Tripod One box of ammunition
Gunner	Binoculars M2 compass Receiver w/T&E mechanism and pintle attached Headspace and timing gauge
Ammunition Bearer	Barrel Barrel cover One box of ammunition

### 41002. Form for Gun Drill

The squad leader gives all commands from the position of attention. The squad members repeat all commands from the squad leader.

The first command given by the squad leader is **FALL IN**. At this time the squad members form up on line with five paces between each person and their equipment and ammunition one pace to their front.

The next command given is **TAKE EQUIPMENT**. The squad members now take one step forward and pick up their equipment with both hands.

The final command is **FORM FOR GUN DRILL**. At this time the squad will face to the right in this order: squad leader, gunner, and ammunition bearer. The squad then assumes the prone position. Once in position, the squad places the equipment in the following order (see figure 4-91):

- The squad leader places the tripod to his left (trail legs to the rear, front leg uppermost), ammunition to his right, and latch to the front.
- The gunner places the receiver across his front, back plate to the right, and retracting slide handle upward.
- The ammunition bearer places the barrel to his right, muzzle to the rear and ammunition box to his left front with latch to the right front.

- If other members are assigned, they place ammunition boxes in front, one foot apart, latches to the right front.

### 41003. Examination of Equipment Before Firing

Once the squad is in the prone position, the squad leader gives the command **EXAMINE EQUIPMENT BEFORE FIRING**.

**a. Squad Leader.** The squad leader inspects the M3 tripod to ensure that—

- The indexing levers and clamps on the front and trail legs function properly, and the legs are in the short (low) position.
- Front legs and trail legs are closely folded; front leg clamp is hand tight.
- Sleeve lock latch and pintle lock release cam are in working order; pintle lock release cam is down.
- Pintle bushing is free of dirt and burrs.
- Metallic links of the ammunition are clean (open the ammunition box).



**Figure 4-91. Crew Formed in Column.**

- Ammunition belt is properly loaded and placed in the box, the double loop end up.
- Ammunition box is closed and locked after ammunition is inspected.

**b. Gunner.** The gunner inspects the receiver group to ensure that—

- Barrel support and breech bearing are free of dirt.
- Pintle is free of dirt.
- Feed mechanism and bolt switch are properly assembled to feed from left (raises the cover for proper inspection).
- Striker projects through the aperture in the face of the bolt (now closes the cover).
- Rear sight is set at 1,000 yards (900 meters); windage is zero.
- T&E mechanism is securely attached to the receiver.
- Traversing hand wheel is centered.
- Elevating screws are equally exposed (about 2 inches) above and below the elevating hand wheel.
- Back plate is latched and locked in place.
- Bolt latch release is locked in the down position by the bolt latch release lock.

- Gunner pulls the bolt to the rear and rides the bolt home.

**c. Ammunition Bearer.** The ammunition bearer inspects the barrel and ammunition box to ensure that—

- Barrel is clear.
- Barrel carrier assembly is securely attached to the barrel.
- Barrel bearing is free of dirt.
- Metallic links of the ammunition are clean (open the ammunition box).
- Ammunition belt is properly loaded and placed in the box, double loop end up.
- The ammunition box is closed and latched after the ammunition is inspected.

When the ammunition bearer completes his inspection, he moves to the gunners position with the barrel in his right hand and ammunition in his left hand. With the aid of the gunner the ammunition bearer screws the barrel into the barrel extension. See figure 4-92. The headspace and timing adjustment is now made by the gunner. The ammunition bearer remains on the left and on line with the gunner. See figure 4-93.



**Figure 4-92. Screwing the Barrel Into the Barrel Extension.**



**Figure 4-93. Crew Ready to Place the Gun Into Action.**

**d. Reporting.** At the completion of the inspection, a report is rendered to the squad leader as follows:

- The ammunition bearer reports: **AMMUNITION BEARER CORRECT** (or he states any deficiencies).
- The gunner reports: **GUNNER AND AMMUNITION BEARER CORRECT** (or he states any deficiencies).
- The squad leader would report: **SQUAD ALL CORRECT** (or he states any deficiencies) if he has to report to a senior.

#### **41004. Placing the Gun into Action**

To place the gun into action, the squad leader commands and signals **GUN TO BE MOUNTED** (pointing to the position where the gun is to be mounted); **FRONT** (pointing in the direction of fire); and **ACTION** (vigorously pumping his fist in the direction of the designated gun position).

At the command/signal **ACTION**, the squad leader grasps the left trail leg near the center with his left hand. Jumping to his feet and grasping the tripod head

with his right hand, he lifts the tripod across the front of his body with the front leg up, and carries the tripod to the desired location (see figure 4-94). Upon arrival at the position, he places the trail leg shoes on the ground with the front leg pointing upward. With his right hand on the tripod head, he slides his left hand down on the left trail leg and, with a snapping motion, pulls the left leg to the left, engaging the sleeve latch. Steadying the tripod with his left hand on the front leg, he loosens the front leg clamp with his right hand (see figure 4-95), positions the front leg with his left hand, and tightens the front leg clamp with his right hand. He then aligns the tripod for direction, drops the mount to the ground, stamps the right and left trail shoes with his right or left foot, and assumes the prone position behind the mount.

The gunner and ammunition bearer move together. When the tripod is nearly mounted, the gunner and ammunition bearer jump to their feet. The gunner places both hands on the spade grips; the ammunition bearer grasps the ammunition box with his left hand and the gun-carrying handle with his right hand. Both men lift the gun off the ground and move rapidly to the gun position. At the gun position, the ammunition



bearer places the ammunition box on the line and two feet to the left of the tripod head, latch facing the tripod. The gunner, assisted by the ammunition bearer, inserts the pintle into the pintle bushing. The ammunition bearer stamps the front shoe into the ground with his left foot, releases the carrying handle, lowers his right hand, and lifts the gun pintle lock release cam. See figure 4-96. The squad leader can assist if required. When the gun pintle is fully seated, he presses the pintle lock release cam down with his right hand, then turns to his left and retrieves the ammunition box which the squad leader left in his original location. The ammunition bearer places this ammunition box to the rear of the ammunition box that he previously placed next to the tripod head, latch facing the tripod. He then turns to the left and returns to his original position.

The gunner holds the spade grip with the right hand, and with his left hand, lowers the T&E mechanism to the traversing bar, ensuring that the traversing

hand wheel is to the left and the lock lever is to the rear. The squad leader moves into position to the left of the gun with his feet to the rear, and his head on line with the feedway. He unlatches and raises the cover of the ammunition box, removes the ammunition belt, and inserts the double looped end into the feedway and taps the cover with his right hand to ensure that it is closed.

With his right hand, palm up, the gunner grasps the retracting slide handle, and vigorously jerks it to the rear and releases it. The gun is half loaded (see figure 4-97). He then assumes the correct gunner's position directly behind the gun, legs spread and heels down. His right hand lightly grasps the right spade grip with the thumb in position to depress the trigger. His left hand is on the elevating hand wheel, palm down, with his thumb near the slide lock lever. He rests on his left elbow, head as close to the rear sight as possible. He then tells the squad leader UP (see figure 4-98).



**Figure 4-94. Squad Leader Moving the Tripod Into Position.**



**Figure 4-95. Emplacing the Mount.**



**Figure 4-96. Mounting the Gun.**



**Figure 4-97. Half Loading the Gun.**

#### **41005. Taking the Gun Out of Action**

After the report **UP** is given, the squad leader then gives the command **OUT OF ACTION**. The gunner then raises the top cover with his left hand. The squad leader lifts the ammunition out of the feedway,

replaces the ammunition in the box, and closes and latches the box. The gunner closes the cover, pulls the retracting slide handle to the rear with the right hand, palm up, releases it, presses the trigger with his right thumb, and loosens the traversing slide lock lever with his left hand. He then rises to his feet, grasping



**Figure 4-98. Crew Ready for Action.**



**Figure 4-99. Taking the Gun Out of Action.**

both spade handles. At this time the ammunition bearer arrives at the gun position. With his left hand on the ammunition box, he places his right foot on the front leg shoe. With his right hand, he reaches down and lifts up the pintle lock release cam and grasps the carrying handle. See figure 4-99.

The gunner and ammunition bearer lift the gun from the tripod, turn right, and carry the gun back to their original position. They put the gun down, muzzle to the left, retracting slide handle up. The gunner kneels down, then pulls the retracting slide handle to the rear, and aligns the lug on the barrel locking spring with

the 3/8 inch hole in the right side of the receiver. The ammunition bearer unscrews the barrel from the receiver, picks up the ammunition box and barrel, moves five paces to the rear, and remains in a standing position with the ammunition box to his left, latch to the front.

The gunner rotates the bolt latch release lock to the right and releases the bolt latch. He checks his sights to ensure that they are properly set (1,000 yards), then assumes the prone position.

The squad leader assumes a kneeling position behind the tripod and releases the sleeve lock latch with his right hand, rises to his feet, grasps the front leg with his left hand, and rotates the tripod to its vertical position on the trail legs. With his right hand he loosens the front leg clamp, folds the front leg down and tightens the clamp. With his right hand on the tripod head, he rotates the tripod on its right trail leg, releases the



**Figure 4-100. Folding the Trail Legs.**

sleeve latch, and folds the left trail leg against the right with his left hand (see figure 4-100). Holding the tripod head with his right hand, trail legs with his left, he lifts the tripod across the front of his body, with the front leg up. He turns to the right and returns to his original position.

At this time the ammunition bearer comes forward, picks up the remaining ammunition box, and places it to the right of the squad leader, latch to the front. The ammunition bearer returns to his original position and assumes the prone position. The squad leader places the tripod on the ground, assumes a prone position to the right of the tripod and announces **UP**.

#### **41006. Duties of Crew**

To hand-carry gun and equipment, the squad leader commands **SECURE EQUIPMENT, FOLLOW ME**. At this command—

- The gunner moves forward toward the new position carrying the receiver on either shoulder, spade grips to the front.
- The squad leader carries the tripod over either shoulder and the ammunition box in one of his hands.
- The ammunition bearer carries his ammunition box in his left hand, and the barrel in his right hand, muzzle to the rear, or on his right shoulder, muzzle to the front.

#### **41006. Carrying the Tripod-Mounted Gun**

When a gun is mounted on the tripod it can be moved over short distances by dragging it, or with two or three men carrying it in step.

- a. Dragging.** The gun is dragged when limited cover or the situation requires the gun to be moved in this manner. The gunner and squad leader will drag the gun to the desired position. See figure 4-101.
- b. Two-Man Carry.** With the gunner on the right and squad leader on the left, each one grasps the front leg of the tripod with their forward hand and trail legs



**Figure 4-101. Dragging the Gun Into Position.**

with the other hand just above the traversing bar. See figure 4-102.

**c. Three-Man Carry**

(1) **Hot barrel.** The gunner is in the rear grasping the trail legs of the tripod. The squad leader, on the left, and ammunition bearer, on the right, each grasp the carrying handle. They also each carry an ammunition can in their free hand. See figure 4-103.

(2) **Cold barrel.** As with a hot barrel, the gunner remains to the rear grasping the trail legs of the tripod. The squad leader and ammunition bearer, however, now grasp the front leg of the tripod. See figure 4-104.)

---

**CAUTION**

---

Carrying the gun by the barrel may cause damage to the barrel support and the barrel extension.

---



---

**Section 11  
Qualification Firing**

---

In the hands of a properly trained Marine, the M2 .50 cal can provide a unit with decisive firepower. Proper training of M2 .50 cal crew members to deliver accurate and responsive fires takes time, attention to detail, and hard work. In the hands of an untrained person, this machine gun is a hazard to friendly personnel and units.



**Figure 4-102. Two-Man Carry.**

Prior to being assigned as a M2 .50 cal crewman, a Marine should already be qualified on the M60 machine gun.

It is essential that instructors and demonstration personnel be thoroughly trained and rehearsed in their duties before group instruction commences.



**Figure 4-103. Three-Man Carry—Hot Barrel.**

Each exercise is first explained and demonstrated. Each man is then given practical work in the exercise and supervised by coaches. Finally, the men are given an examination in order to determine their progress and proficiency.

If a sufficient number of machine guns are available, it is preferable to assign a coach and four men to one gun.

Training prescribed herein, including courses to be fired, should be conducted on the M60 machine gun prior to training with the M2 .50 cal. This method permits the M2 .50 cal gunners to receive the maximum machine gun training without excessive expenditure of M2 .50 cal ammunitions.



**Figure 4-104. Three-Man Carry—Cold Barrel.**

#### **41101. Phases of Training**

Marksmanship training is divided into two major phases:

- Preparatory marksmanship training.
- Range firing.

These phases are further broken down into progressive steps, and should be taught in the order outlined herein.

The following must be observed during marksmanship training:

- Each student will be proficient in mechanical training and crew drill before he receives instruction in machine gun marksmanship.
- No man will be allowed to fire on the range until he has received thorough training in preparatory marksmanship, regardless of previous qualifications.

### 41102. Fundamentals of Marksmanship

To become accurate and proficient in machine gun marksmanship, a Marine must be thoroughly trained in the following fundamentals:

- Accurate delivery of initial round (burst) of fire on either stationary or moving targets.
- Mechanical skill in manipulating the gun and rapid shifting of fire to new targets.
- Adjustment of fire by the following methods:
  - Observation of strike.
  - Observation of flight of tracer.
  - Frequent relaying of the gun during firing.
  - Speed in combining these fundamentals when delivering fire.
- Speed in combining these fundamentals when delivering fire.

### 41103. Preparatory Exercises

**a. Purpose.** The purpose of the preparatory exercises in marksmanship training is to teach the essentials of marksmanship. A thorough, carefully supervised course in the preparatory exercises conserves time and ammunition during range practice. The preparatory exercises consists of the following steps:

- Positions for firing and introductory manipulation with both the tripod- and vehicular-mounted machine gun.
- Sighting and aiming exercises.

- Sight setting and laying exercises.
- Manipulation exercises.
- Fire adjustment.
- Range determination.
- Tracking and leading exercises.
- Examination before range firing.

**b. Order of Instruction.** The first five steps are listed in the order of instruction. They must be taught in that order. Since range determination is not based on the material covered in any of the other steps, it may be taught any time before the examination. Tracking and leading will be conducted after 10-meter firing, but before firing on moving targets. Every man who is to fire on the range, including those who have previously qualified, will receive complete instructions in the preparatory exercises. The instructor ensures that each man is tested thoroughly and graded in the exercises before he is allowed to fire. Men with an unsatisfactory rating will be given additional instruction until a satisfactory rating is obtained.

### 41104. Equipment for Training

- One sighting bar.
- One M2 .50 cal and mount complete (tripod and vehicular mounts).
- One 1/2-inch aiming paster per gun.
- One vehicle silhouette aiming target per gun.
- One target frame per gun, covered with blank paper and equipped with braces for mounting.
- One 10-meter machine gun target per gun.
- Material for blackening sights.

### 41105. Positions for Firing

The M2 .50 cal can be fired from the prone or sitting position as described in paragraph 4806.

### 41106. Introductory Manipulation

To give the gunner practice in manipulation, the following procedure is used: the coach stands about 10 paces in front of the gun and uses hand signals to indicate the direction in which the gunner is to move the muzzle. The gunner manipulates the hand wheels, observed by the coach who makes necessary corrections. When the gunner reacts quickly, and can manipulate the gun as indicated, he is ready to continue his instructions. See figure 4-105.

### 41107. Sighting and Aiming Exercises

**a. First Sighting and Aiming Exercise (Sighting Bar).** The purpose of the first sighting and aiming exercises is to teach the correct sight alignment and sight picture. When the top center of the front sight blade is in the center of the peep sight, the sights are correctly aligned. A correct sight picture is one in which the sights are correctly aligned, with the top of the front sight blade just touching the bottom center of the target (see figure 4-106). All men will be required to demonstrate proficiency in obtaining the correct sight alignment and a correct sight picture with a sighting bar (see figure 4-107).

**b. Second Sighting and Aiming Exercise (With Gun).** The purpose of the second sighting and aiming

exercise is to apply the preceding lesson to sight alignment of the machine gun sights on a target. A M2 .50 cal target is placed 10 meters from the pintle (see figure 4-108).

The coach uses a demonstration crew of two assistants who are placed at the gun. One acts as the coach and the other as the pupil during the demonstration. The exercise is first explained and then demonstrated. The coach shows the gunner the correct sight picture. The coach then moves the gun off the target and requires the gunner to move the gun back on the correct sight picture using the hand wheels.

The coach checks and critiques the alignment made by the gunner. Practical work is then conducted using the method demonstrated.

### 41108. Sight Setting and Laying Exercises

**a. Sight Setting Exercise.** The purpose of this exercise is to teach the method of setting the rear sight, and to develop accuracy and speed in its use. The exercise is first explained and demonstrated. The sight slide is set at the desired range by turning the elevating screw knob. The hair line through the peep sight is used as an index in setting the sight at the desired graduation.



Figure 4-105. Manipulation.

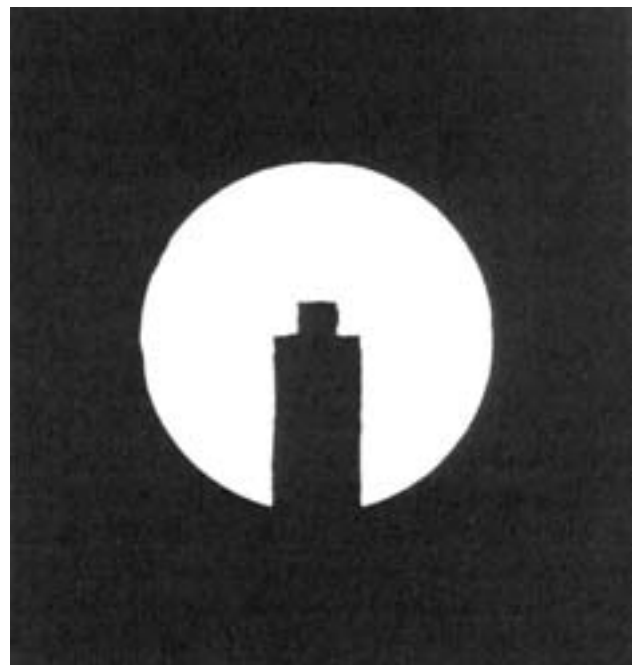

Figure 4-106. Correct Sight Picture.



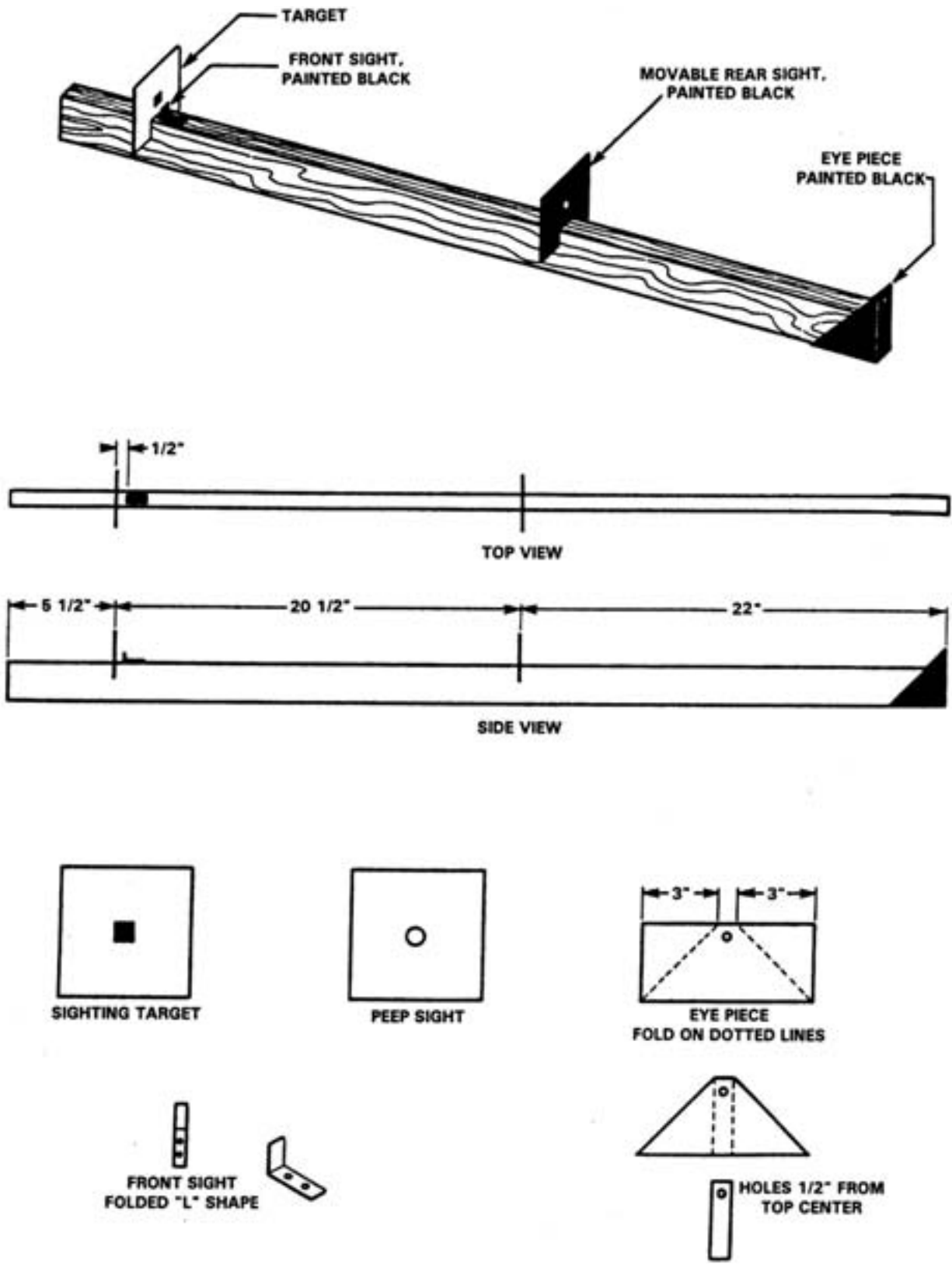

Figure 4-107. Sighting Bar.

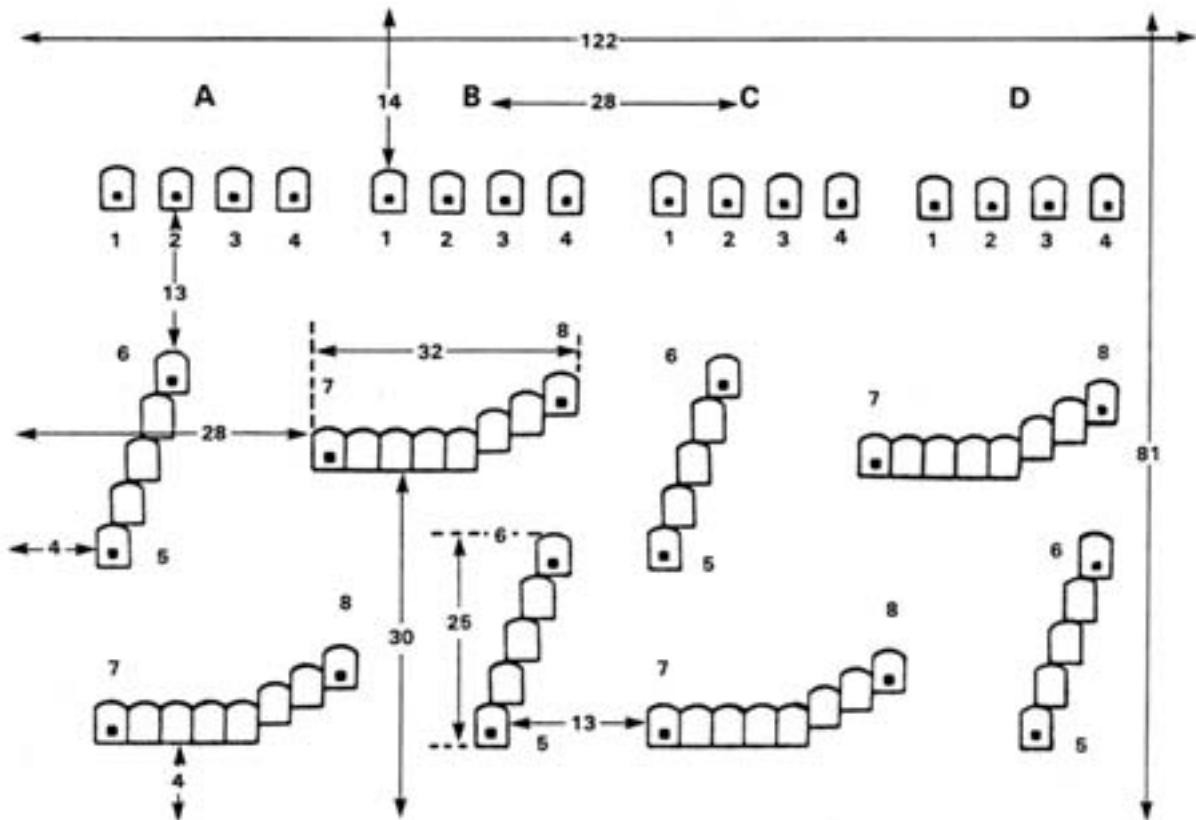

Figure 4-108. M2 .50 Cal Targets.

To demonstrate the exercise, the instructor has one demonstrator take the gunner's position at the gun and another at the coach's position. The exercise is demonstrated as follows:

- The instructor announces the range: e.g., **EIGHT HUNDRED**.
- The pupil repeats the range, sets the sight at the announced range, then assumes the correct gunner's position and reports **UP**. The coach checks the setting of the slide and points out any errors.

All men go to their groups, work in pairs, and go through the exercise until each man has become proficient in accurate and rapid sight setting.

**b. Sight Setting and Layout.** The purpose of the sight setting and laying exercise is to develop accuracy and speed in laying the gun on an aiming point, and to give additional practice in sight setting.

The instructor explains that the exercise starts with the sight leaf down and the slide at 1,000 yards, that ranges less than 1,000 or greater than 1,800 will not be announced.

To demonstrate the exercise, the instructor has one demonstrator take the gunner's position at the gun and another the coach's position. The exercise is demonstrated as follows:

- The coach announces an aiming point and range.

(For example: **1) PASTER NUMBER 5. 2) ONE TWO HUNDRED.**)

After giving the first element, the coach pauses long enough to permit the gunner to repeat it and then gives the second element.

- The gunner repeats both elements, raises the sight leaf, and sets the sights. Upon completing the sight setting, he manipulates the gun by turning the T&E hand wheels until the sights are accurately aligned on the designated aiming point. He then assumes the correct gunner's position and announces **UP**.
- The coach checks the sight setting and lay at the completion of the exercise.

All men go to their groups, and instruction is continued.

#### **41109. Manipulation Exercises**

Manipulation is the process of shifting the direction of the gun from one definite point to another definite point. After the gunner understands the principles of sighting and aiming, and can assume a satisfactory firing position, he is given instruction in manipulating the gun to obtain an accurate initial lay, then to shift the direction of the gun to successive points with proficiency.

**a. Manipulation Exercise.** The coach ensures that the following instructions are understood and followed:

- (1) A machine gun target is placed out 10 meters from the pintle for this manipulation exercise.
- (2) Manipulation of the gun for great shifts in direction is obtained by releasing the traversing slide lock lever and moving the slide to the right (left). Small changes in direction are made by turning the traversing hand wheel with the left hand. One click on the T&E hand wheel moves the strike 1 mil, or 1 centime-

ter on the target. See section 5 of chapter 5 for detailed information on the T&E mechanism.

(3) Manipulate for elevation by rotating the elevating handwheel with the left hand.

(4) Traversing and searching the target is accomplished by laying on the initial aiming paster (number 5 or 6) and then shifting to each of the other numbered pasters in order (5 through 10 or its reverse). All major shifts in traverse (e.g., 5 to 10; 6 to 9; or the reverse) are done by loosening the traversing slide lock lever. When shifting from pasters number 5 to 6, 7 to 8, or the reverse, use the T&E hand wheels.

(5) Upon receiving the command, the gunner repeats the instruction, sets the sight, lays the gun on the designated paster, assumes the correct gunner's position, and reports **UP**.

(6) At the command **FIRE**, the pupil repeats the command, simulates firing two single shots, then shifts to the next paster and simulates firing until the exercise is completed. The gunner aims at each paster.

(7) While the gunner is performing these operations, the coach:

- Checks the sight setting and initial lay.
- Checks the gunner's position.
- Sees that the gunner simulates firing a shot(s) before manipulating the gun.
- Checks for proper manipulation.
- Checks the lay and critiques the exercise at completion.

#### **b. Announcement of Instructions (Example)**

- **PASTER NUMBER 5 (6) TO PASTER NUMBER 6 (5).**
- **ONE THOUSAND.**
- **TRAVERSE AND SEARCH.** At the command **FIRE**, the instruction proceeds as described in 41109a, bullets 4, 5, and 6.

### 41110. Observation and Adjustment of Fire

The purpose of observation and adjustment practice is to teach the adjustment of fire by observing the strike of the bullets, the flight of tracers, or by frequent relaying on the target using the sights.

**a. Observation.** When firing on the 10-meter range, the strike of the bullet is visible on the target.

When firing at greater distances, the strike of the bullet on the ground may cause dust to rise which is visible to the gunner; however, during wet weather, the strike cannot always be seen. In this event, the tracers will allow the gunner or crew to note the strike of the burst in relation to the target.

**b. Adjustment.** Using the mil relation, one click of the traversing handwheel or elevating hand wheel moves the strike of the bullet one half an inch on the target at a range of 10 meters.

When firing on the 10-meter range, adjust, moving the shot group a required number of centimeters vertically or horizontally until the center of the group is on the aiming paster. Should the gunner's initial burst strike the target 2 centimeters (approximately 3/4 inch) to the left and 3 centimeters (approximately 1 1/8 inch) below the aiming paster, he adjusts his fire by traversing right four clicks, and elevating six clicks before firing again.

When firing on field targets, adjustment is made by moving the burst into the target. One click (mil) on the traversing hand wheel will move the strike one half meter at 500 meters, or 1 meter at 1,000 meters; however, the distance one click (mil) in the elevating hand wheel will move the strike depends on the range to the target and the slope of the ground. The gunner determines the number of mils necessary to move the center of the strike into the target and he manipulates the gun the required number of mils. This does not require the use of sights. For example, should the gunner fire on a target at 500 meters and observe the strike 10 meters to the right of the target and short about 50 meters, he would traverse the gun to the left

20 clicks (mils) and add one or more clicks (mils) depending on the slope of the ground.

The gunner may use the adjusted aiming point method to adjust the fire. In this method the gunner must use his sights. He selects an aiming point which will place the next burst on the target. For example, should the gunner fire on a target at 500 meters and estimate that the strike is 20 meters short and 10 meters to the right of the target, he would rapidly select an aiming point approximately 20 meters beyond the target and 10 meters to the left of the target, lay on that aiming point, and fire.

### 41111. Range Determination and Windage Corrections

Range determination is the process of determining distance between two points. There are two methods of estimating range by eye—mental unit of measure (yardstick) and the appearance of objects. The gunner needs training and practice in both methods over varied terrain and under varied conditions of light and weather. A definite system of range determination, frequently practiced, is the only way to make estimation by eye reliable. For information on range estimation by eye, see section IV, chapter 5.

### 41112. Tracking and Leading Exercises

The gunner normally completes a course of instruction in firing a machine gun at stationary targets before instruction is given in firing at moving targets.

Battlefield targets may be either moving or stationary. The technique of engaging a moving target differs from that of engaging a stationary target. The gun must be aimed ahead of the target a sufficient distance to cause the bullet and target to arrive simultaneously at the same point. This distance is measured in target lengths. One target length as seen by the gunner is one lead. Leads are measured from the center of mass. (See figure 4-109.) The lead necessary depends upon range, speed, and direction of movement of the target. To hit the target, the gunner aims at a point ahead of the target equal to the estimated number of leads,

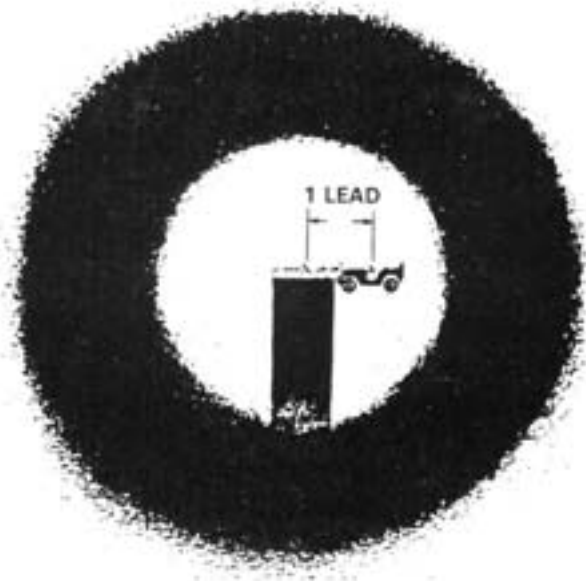
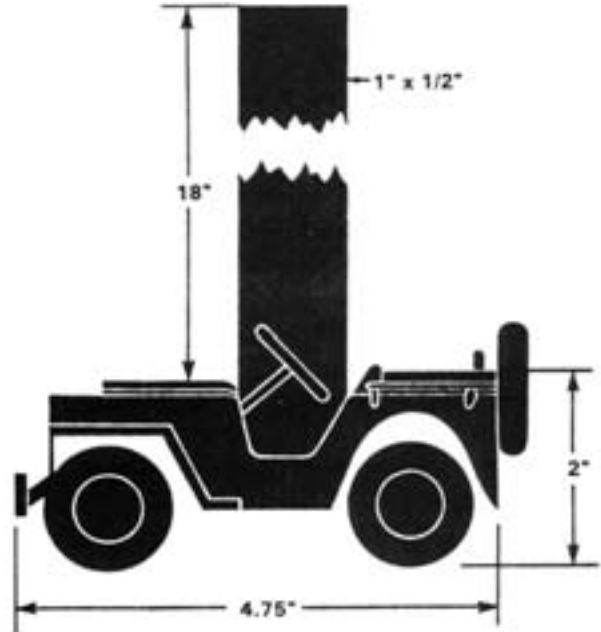

**Figure 4-109. Sight Picture With One Target Length Lead.**

maintains this lead by tracking the target (manipulating the gun at the same angular speed as that of the target), and then fires. Fire is adjusted by observation of strike and/or tracer.

**a. Target Construction.** In order to perform tracking and leading exercises, a target must be fabricated. The target must consist of a light colored background and a movable dark colored vehicle silhouette. The light colored background can be fabricated by tacking cardboard or paper to a standard 12.7-meter target frame. The movable vehicle silhouette is fabricated from cardboard as shown in figure 4-110. A Marine designated as a target handler moves the vehicle silhouette in front of the light colored background by means of the 18-inch silhouette extension tab.

**b. Tracking.** Tracking consists of maintaining correct alignment of the sights (with or without a lead) on a moving target by moving the gun at the same angular speed as that of the target.



**Figure 4-110. Aiming Target Used in Tracking and Leading Exercises.**

The gunner is required to aim at a prescribed point (center of mass) on the target and maintain that aim during uniform movement of the target. As instruction progresses, speeds used should differ from successive runs of the target. Speeds, at which 10-meter targets should be run to represent speeds at various ranges, are shown in figure 4-111.

TARGET SPEEDS IN MPH	TARGET SPEEDS IN INCHES PER SECOND CORRESPONDING TO—		
	300 M	500 M	900 M
7½	6	4	2
15	12	8	4
30	24	15	9

**Figure 4-111. Target Speeds, 10-Meter Moving Targets.**

The target handler must have practice in moving the target silhouette across the blank target at the varying speeds.

### c. Leads

(1) **Lead table.** Mathematical computation or use of voluminous lead tables to obtain exact leads to be used on a moving target are impractical in combat. The simple lead table shown below gives amount of lead necessary to hit a target moving at right angles (0 degrees) to direction to hit at speed and ranges indicated. See figure 4-112.

SPEED IN MPH	RANGE OF TARGET		
	300M	500M	900M
15	½ target length	1 target length	2 target lengths

**Figure 4-112. Lead Table.**

(2) **Correction changes.** The gunner must make corrections as conditions change. If the target speed is 7 1/2 mph, the amount of lead is half that shown in the table; at 30 mph, double that shown. The angle at which the target is moving also alters the amount of lead taken. (If the angle between line of fire and line of travel of the target is less than 45 degrees, use half of the lead shown in the table.) For a target moving directly toward the gun, the line of aim is placed on the center of the lower edge of the target, depending on range and slope of the ground. The lower edge is used for longer ranges and for broken ground. For a target moving directly away from the gun, the line of aim is placed similarly on the center or upper edge of the target. Too much lead is better than too little because the target runs into the fire, also the observation of a strike is easier. Intelligent use of the lead table includes immediate application of fire with estimated lead followed by necessary corrections based upon observation of strike and/or tracer.

(3) **Lead exercises (10 meter).** The target handler places his marking silhouette on the blank target, traces around it, and holds it in place for the gunner to aim.

The gunner is required to take a position at the gun. The coach designates a direction (right or left), speed,

and range for the vehicle. The gunner moves the point of aim through the target silhouette and aims at a point ahead of target equal to the prescribed lead from the center of mass.

The gunner then directs the target handler to move the marking silhouette until the center of the target is at the point of aim. He then repeats this procedure three times for each target lead announced.

Following the gunner's instructions, he moves the marking silhouette until the gunner commands **HOLD**. He then places a pencil dot at this point and returns the silhouette to the original position. This procedure is followed until the gunner has completed three tries for each target announced by the coach. The three pencil dots for each target should be enclosed in a circle 1 centimeter in diameter.

The exercise should be conducted for varying right and left leads.

**d. Tracking and leading.** Combine tracking and leading exercises at 10 meters. After the gunner has gained proficiency in tracking the target, he is required to repeat the tracking exercises while using the proper lead to simulate firing when his sights are properly aligned.

As a further exercise in tracking and leading, the gunner may be required to track and lead moving targets at greater range. A vehicle can be run at right angles to the line of aim at ranges between 500 and 1,000 yards, and at varying speeds that average 15 mph.

### 41113. Preliminary Gunner's Test

Preliminary gunner's tests should be held periodically in order to ensure that proficiency with the M2 .50 cal is maintained by all crewmen. Preliminary gunner's test, if given, should be given prior to range firing. The recommended preliminary gunner's test has a possible score of 100 points. A score of 80 should be required for satisfactory completion of the test. See figure 4-113.

### 41114. Range Firing

The purpose of range firing is to teach the Marine to apply the fundamentals of marksmanship as stated in paragraph 41102. Range firing is conducted upon completion of preparatory marksmanship training. Range firing begins with instruction firing. Each student completes instruction firing before firing for record. Once record firing is begun, the table is completed before additional instructional firing is undertaken.

Instructional firing is practice firing on a marksmanship range with the help of an instructor. The coach and pupil method may be used. Instruction firing teaches the accurate delivery of fire, mechanical skill in manipulating the gun to engage various types of targets, and observation and adjustment of fire within the time prescribed.

Record firing records results and is used as a basis for a Marine's classification in marksmanship. Record firing is a test of the gunner's proficiency in all phases of instruction in machine gun marksmanship and furnishes the means for classification according to the proficiency attained.

Information on the course to be fired, procedures to be used, range configuration, and the duties of range personnel are contained in FM 23-65, *Browning Machinegun, Caliber .50 HB, M2*. Information on field target firing and familiarization firing can also be found in FM 23-65.

ACTION	POINTS
Remove the groups from the receiver.	5
Disassemble and assemble the bolt.	5
Disassemble and assemble the oil buffer body group.	5
Assemble the machine gun.	5
Demonstrate and explain the setting of correct headspace.	10
Demonstrate and explain setting the correct timing.	10
Demonstrate application of the first phase of immediate action.	5
Explain one phase of functioning (as directed by the examining officer).	5
Explain why the machine gun will not fire automatically with the cover unlatched.	5
Inspect a loaded belt and make any corrections necessary to prepare it for firing (belt has at least one of each of the following: short round, bent round, loose bullet, broken link, and round not pushed fully into the link).	5
Explain and demonstrate checks to be made before firing.	5
Explain the full care and cleaning of the gun after firing.	15
Explain how gun is targeted at 10 meters	10
Demonstrate and explain care, adjustment, and lubrication of the M3 mount.	10
<b>TOTAL</b>	<b>100</b>

Figure 4-113. Preliminary Gunner's Test.

## Chapter 5

### MACHINE GUN, 40MM, MK-19 MOD 3

*“Howard held fire until the tanks and infantry had passed across his front, passed his crouching outposts, were beyond him and headed for Company D’s position. Then, only then, did he let go. Every rifle, automatic rifle and machine gun loosed off in a hurricane of aimed fire. The NKPA soldiers were blasted off the tanks, dropped in the road, and cut down in swaths....”*

*“Then all hell broke loose. The high-velocity 90mm guns of the Marine Pershings opened fire. The 5th Marines’ recoilless rifles zeroed in with long blasts; so did those from the 1st Marines across the road. Roise’s 3.5-inch rockets wooshed....”*

*“...the remaining T-34’s were blown to pieces by a storm of shot and shell.”*

—Combat encounter involving Company D, 5th Marines  
in the defense near Ascom City, South Korea,  
17 September 1950<sup>9</sup>



**Korea, on the “Quantico” Line  
Marine Machine Gun Team Awaiting an Expected Chinese Counterattack.**



## Table of Contents

### Section 1. Introduction

5101	General Data
5102	Sights
5103	Safety
5104	Role of the MK-19

### Section 2. Disassembly, Assembly, and Nomenclature

5201	General Disassembly
5202	General Assembly
5203	Detailed Disassembly and Assembly

### Section 3. Functioning

5301	Feeding
5302	Chambering
5303	Locking
5304	Firing
5305	Unlocking
5306	Extraction
5307	Ejection
5308	Cocking

### Section 4. Malfunctions and Stoppages

5401	Malfunctions
5402	Stoppages
5403	Immediate Action
5404	Remedial Action

### Section 5. Mounts and Accessories

5501	Tripod Mount, M3
5502	Gun Cradle
5503	Vehicle Mounts
5504	Night Vision Sight, AN/TVS-5

### Section 6. Maintenance

5601	Cleaning Materials and Lubricants
5602	Care and Cleaning Before, During, and After Firing
5603	Normal Maintenance Procedures
5604	Special Maintenance Procedures
5605	Inspection

### Section 7. Ammunition

5701	Identification
5702	Types
5703	Ballistic Data
5704	Packaging
5705	Storage
5706	Care, Handling, and Preservation

### Section 8. Operation and Firing

5801	Functioning Check
5802	Loading
5803	Charging the Gun
5804	Firing
5805	Clearing and Unloading the Gun
5806	Positions for Firing

### Section 9. Gun Drill

5901	Crew Equipment
5902	Form for Gun Drill
5903	Examination of Equipment Before Firing
5904	Placing the Gun into Action
5905	Taking the Gun Out of Action
5906	Duties of Crew
5907	Carrying the Tripod-Mounted Gun
5908	Marksmanship Training and Qualification Firing

## List of Figures

5-1	The MK-19 MOD 3 Machine Gun	5-10	Removing the Feed Tray Cover Retaining Pin
5-2	Front Sight	5-11	Removing the Feed Slide Assembly
5-3	Rear Sight	5-12	Lifting the Locking Pin
5-4	Safety	5-13	Rotation of Sear Housing Assembly
5-5	Five Main Groups, Exploded View	5-14	Inserting the Bolt and Backplate Assembly Into Receiver
5-6	Five Main Groups	5-15	Depressing the Sear While Sliding the Bolt Assembly Forward
5-7	Removing the Bolt and Backplate Pin	5-16	Receiver Assembly, Detailed Disassembled
5-8	Removing the Bolt and Backplate Assembly		
5-9	Removing the Secondary Drive Lever		

5-17	Retracting the Drive Lever Lock	5-37	Pedestal Mount M4
5-18	Removing the Primary Drive Lever and Vertical Cam	5-38	M66 Ring Mount
5-19	Removing the Alignment Guide Assembly	5-39	HMMWV Weapons Station
5-20	Removing the Ogive Plunger	5-40	Pintle Adapter
5-21	Removing of Round Positioning Block	5-41	T&E Mechanism Mount Assembly
5-22	Removal of Lock Plunger	5-42	Procedures Before, During, and After Firing
5-23	Position of Drive Levers, Bolt to Rear	5-44	40mm Ammunition Box
5-24	Round Positioned In Feeder, Bolt to Rear	5-43	MK-19 40mm Ammunition
5-25	Round Picked Up by Extractors	5-45	Ammunition Belt With Female Link on First Round
5-26	Round Cammed Down Onto Face of Bolt	5-46	Placement of Round Across Primary Feed Pawls
5-27	Round Positioned Against Round Positioning Block, Bolt Forward	5-47	Moving Primary Drive Lever to the Right
5-28	Round Positioned on Face of Bolt, Ready to Chamber	5-48	Attach Feed Throat to Feeder
5-29	Chambering/Locking	5-49	Rotating Charger Handles Down and Pulling to Rear
5-30	Firing/Unlocking	5-50	Clearing Rounds From Gun
5-31	Extracting/Ejecting/Feeding/Cocking	5-51	Mounting the Cradle on Tripod
5-32	Lowering Charger to Stop Runaway Gun	5-52	Attaching the T&E to the Tripod
5-33	Corrective Action for Stoppages	5-53	Gunner Moving into Position
5-34	M3 Tripod	5-54	Placing and Securing the MK-19 into the Cradle
5-35	MK64 MOD 5 Cradle	5-55	Inserting the First Round into the Feeder
5-36	MK64 MOD 5 Cradle Mounted on the M3 Tripod		

## Chapter 5

# Machine Gun, 40mm, MK-19 MOD 3

---

### Section 1 Introduction

---

The MK-19 is an air cooled, blowback-operated, fully automatic weapon (see figure 5-1). The ammunition is fed into the gun by a disintegrating metallic link belt. The weapon features a barrel which prevents cookoff even after prolonged firing. A flash suppressor is fixed to the muzzle of the barrel. The slotted configuration suppresses vibration during firing and dissipates flash and smoke. The MK-19 is employed from a tripod or from a variety of vehicles. Each MK-19 machine gun crewman should have ready access to TM 08521A-10/1A, a detailed, pocket-size, operators reference manual.

### 5101. General Data

#### Weights/measurements:

Total system weight (gun, cradle, and tripod) . . . . .	140.6 pounds
Weight of gun . . . . .	75.6 pounds
Weight of gun cradle (MK64 MOD5) . . . . .	21 pounds
Weight of M3 tripod . . . . .	44 pounds
Length of gun . . . . .	43.1 inches
Muzzle velocity . . . . .	790 feet per second
Rifling . . . . .	Right hand, uniform twist, one turn in 48 inches

#### Ranges:

Maximum . . . . .	2,212 meters
Maximum effective	
Point target . . . . .	1,500 meters
Area target . . . . .	2,212 meters



Figure 5-1. The MK-19 MOD 3 Machine Gun.

Ammunition:

Caliber .....	40 millimeter
Types in use .....	High explosive, dual purpose; high explosive, target practice; and dummy
Basic load of ammunition per gun (vehicle mount) .....	400 rounds
Weight of 48 rounds (HE or HEDP) in container .....	.62 pounds

Rates of fire:

Sustained .....	40 rounds per minute
Rapid .....	60 rounds per minute
Cyclic .....	325-375 rounds per minute

Manipulation (tripod mount, tripod controlled):

Elevation .....	100 mils
Depression .....	250 mils
Traverse .....	800 mils (400 left/400 right)

**5102. Sights**

The front sight on the MK-19 is a fixed sight (see figure 5-2). The rear leaf sight is mounted on a spring-type dovetail base (see figure 5-3). It can be folded forward to the horizontal when the gun is to be moved or when utilizing the battle sight. The range plate on the rear sight leaf is marked at each 100 meters, beginning at 300 meters through 1,500 meters. Range changes may be made by either the elevation wheel or the slide release. Generally, major changes in elevation are made with the slide release while minor adjustments are made with the elevation wheel. When utilizing the elevation wheel, two clicks equal 1 mil. In addition, the rear sight may be adjusted for windage. By turning the windage screw two clicks for each mil, windage may be adjusted up to 10 mils either side of zero. The battle sight enables the gunner to look down the barrel when the leaf sight is in the horizontal position. The night vision sight AN/TVS-5 can be mounted on the rear sight housing.

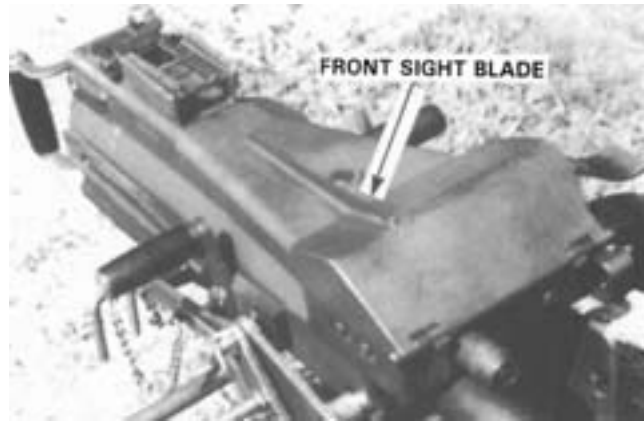

**Figure 5-2. Front Sight.**

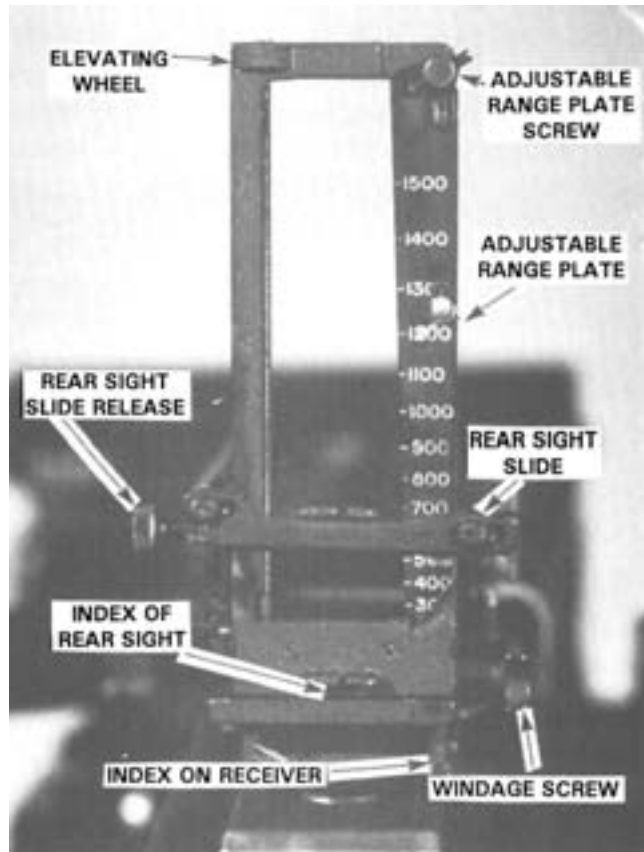

**Figure 5-3. Rear Sight.**

### 5103. Safety

The safety is located on the sear assembly (see figure 5-4). It has an *S* (*SAFE*) and an *F* (*FIRE*) position. To ensure the safety functions properly, first ensure the gun is clear. With the feedtray cover closed, pull the bolt to the rear, place the safety on *S* and attempt to fire. The bolt should not go forward. Put the safety on *F* and attempt to fire. The bolt should spring forward.

### 5104. Role of the MK-19

The MK-19 provides support in both the offense and defense. Its capability for a heavy volume of close, accurate, and continuous fire support makes it a highly responsive weapon with which to suppress and destroy enemy personnel, fortifications, and vehicles in support of an attack. Its capability for both long range and close defensive fires make it an



Figure 5-4. Safety.

ideal weapon in the defense. Its fragmentation producing effects are devastating against attacking dismounted infantry. Its ability to effectively penetrate lightly armored vehicles prevents the enemy from remaining mounted and rapidly closing with friendly defensive positions.

---

## Section 2

### Disassembly, Assembly, and Nomenclature

---

The MK-19 can be disassembled and assembled without the use of force. Disassembly and assembly can be accomplished by utilizing only an expended casing and a cartridge link. As the weapon is disassembled, place the parts (in the order in which they are removed) on a clean, flat surface to facilitate ease in assembly.

Disassembly and assembly may be divided into two categories; general and detailed. General disassembly involves separation of the weapon into main groups. This is also known as fieldstripping and is a practice that stems from past experience in combat situations. The intent behind designating main groups for a weapon and the practice of field stripping is to allow the operator to quickly break the weapon down into a set of major components that can be hastily cleaned to keep the weapon ready for action. The idea is to disassemble the weapon just far enough to conduct basic cleaning without having to contend with numerous assemblies and parts. Detailed disassembly involves the removal of some of the component parts and assemblies from the main groups. When the situation and conditions permit, the operator can take the time to completely disassemble and thoroughly clean the weapon. Complete general and detailed disassembly is normally the expected routine in garrison after the completion of firing and/or field training, but this may also be conducted in a field environment when necessary to ensure the proper functioning and maintenance of the weapon. Only qualified ordnance personnel are authorized to disassemble the weapon beyond that described in this publication.

## 5201. General Disassembly

General disassembly separates the MK-19 into five main groups. These groups include the receiver (with chargers, sight, barrel, and flash suppressor assembly), feed slide assembly and tray, feed tray cover (top cover), sear, and the bolt and backplate with grips attached. See figures 5-5 and 5-6.

### a. Removing the Bolt and Backplate Assembly

- Ensure the gun is clear and ride the bolt forward.
- Pull straight out on the bolt and backplate pin utilizing a spent casing. See figure 5-7.
- Pull out the assembly until it clicks.
- Place the gun on F.
- Depress the sear, support the assembly with both hands, and pull rearward to remove. See figure 5-8.

### b. Removing the Feed Slide Assembly and Feed Tray

- Hold the top cover straight up.
- Remove the secondary drive lever by pushing down on the point post from outside the feed tray cover and pulling the lever to the rear until it disengages. See figure 5-9.
- Fold down the feed tray with feed slide assembly.
- Pull the retaining pins straight out from both sides.
- Lift off the cover. See figure 5-10.
- Lift off the feed tray and feed slide assembly. See figure 5-11.

### NOTE

It is permissible to separate the feed slide assembly from the feed tray. Move the feed slide assembly to line up the tabs with slots in the tray, then lift off the feed slide assembly.

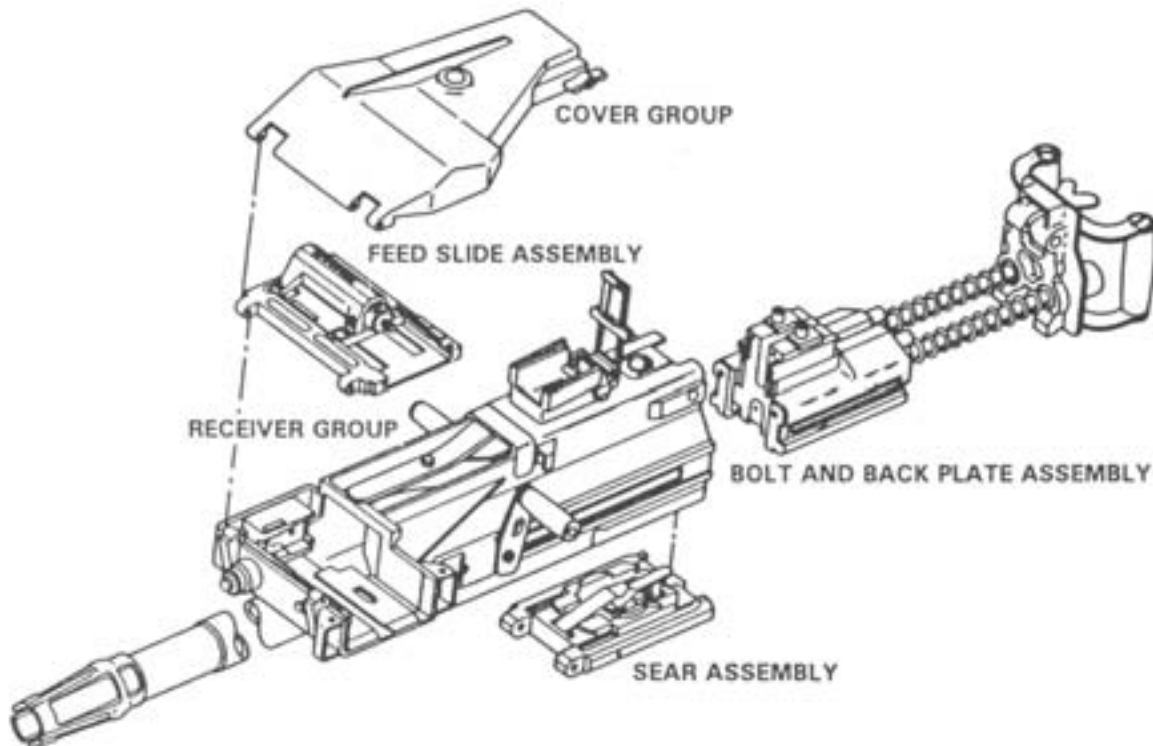

Figure 5-5. Five Main Groups, Exploded View.

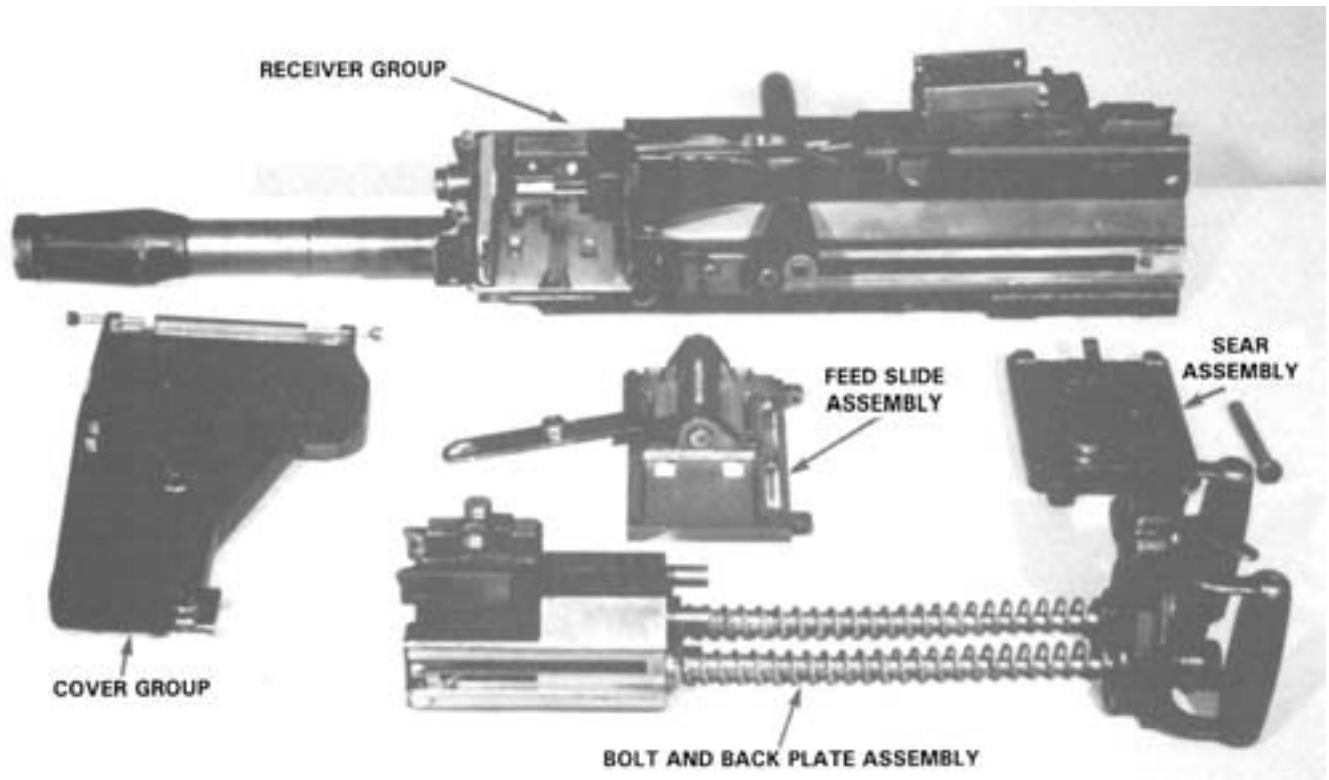

Figure 5-6. Five Main Groups.



Figure 5-7. Removing the Bolt and Backplate Pin.



Figure 5-8. Removing the Bolt and Backplate Assembly.



**Figure 5-9. Removing the Secondary Drive Lever.**

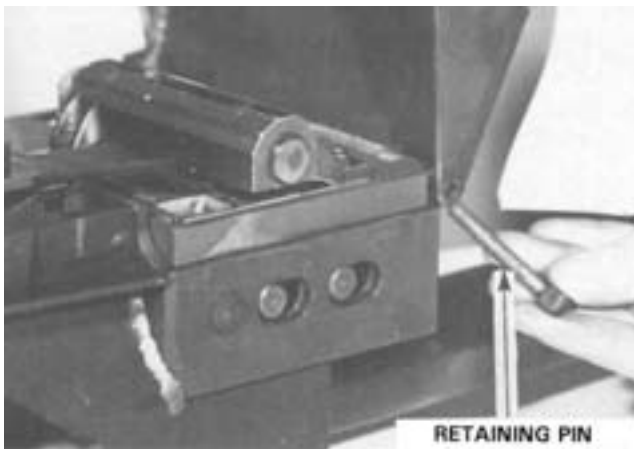

**Figure 5-10. Removing the Feed Tray Cover Retaining Pin.**

**c. Removing the Sear Assembly**

- Turn the receiver on its side and place the safety on *F*.
- Lift the lockpin with cartridge link. See figure 5-12.

- Press the receiver sear (located under the safety) and rotate the sear housing assembly 90 degrees in either direction. See figure 5-13.
- Put the safety in the *S* position and lift out the sear housing assembly.

**5202. General Assembly**

To properly assemble the five major groups of the gun, replace the groups in reverse order of their removal.

**a. Attaching the Sear Housing Assembly**

- Ensure that the sear spring is held in position and line up the assembly at a 90-degree angle to the barrel centerline.
- Turn the assembly 90 degrees toward the barrel centerline until the assembly locks into position.

**b. Attaching the Feed Slide Assembly and the Feed Tray**

- Lower the feed slide assembly and tray into position.



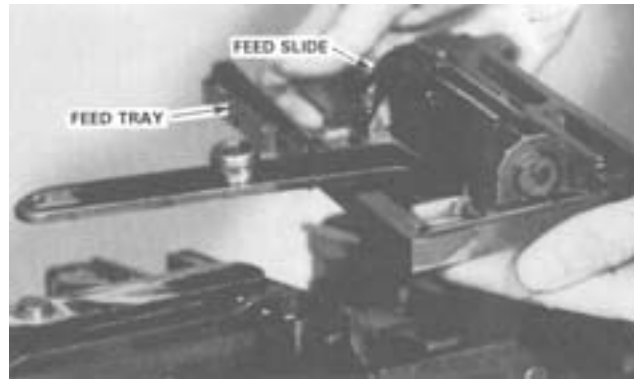

Figure 5-11. Removing the Feed Slide Assembly.



Figure 5-12. Lifting the Locking Pin.

**c. Attaching the Feed Tray Cover (Top Cover)**

- Align pinholes in feed tray cover with pinholes in feed tray assembly.
- Hold the cover straight up and insert the feed tray cover retainer pins into both sides of the cover.

**d. Replacing the Secondary Drive Lever**

- Lift the feed slide assembly and the feed tray.
- Insert the forked end of the secondary drive lever between the feed slide assembly and the feed tray.

- Press the raised pivot post through the hole in the feed tray cover. Press the feed tray firmly against the feed tray cover.

**e. Insert the Bolt and Backplate Assembly**

- Ensure the cocking lever is forward.
- Insert the bolt and backplate assembly into the receiver. See figure 5-14.

---

**CAUTION**

---

Before inserting assembly, put cocking lever in forward position.

---



**Figure 5-13. Rotation of Sear Housing Assembly.**

- Press the receiver sear and slide the bolt assembly forward until the retainer pin holes in the backplate and receiver are aligned. See figure 5-15.
- Insert the backplate retainer pin to lock the assembly in position.

#### **5203. Detailed Disassembly and Assembly**

The term detailed disassembly, as it is used in this manual, refers only to those disassembly procedures authorized for the operator level. This is not to be confused with procedures authorized for 2d echelon maintenance (unit armorers) or above. Detailed disassembly of any of the groups beyond that described in this manual is **NOT AUTHORIZED** except by qualified ordnance personnel. Detailed disassembly of the receiver assembly is authorized by operators to the degree shown in this section. See figure 5-16.

##### **a. Disassembling the Receiver Group**

###### **(1) Removing the primary drive lever and vertical cam**

- Reach under the top of the receiver and locate the drive lever lock. Slide the lock 1/4 inch to the rear. See figure 5-17.

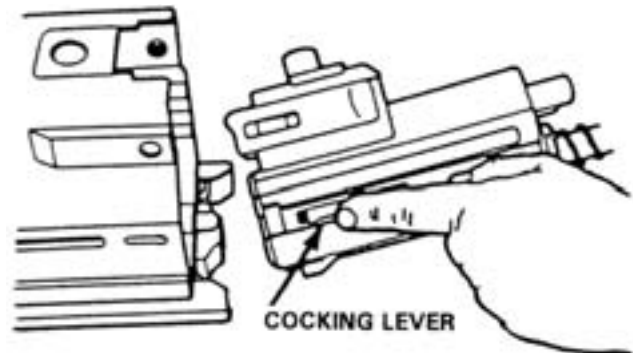

**Figure 5-14. Inserting the Bolt and Backplate Assembly Into Receiver.**



**Figure 5-15. Depressing the Sear While Sliding the Bolt Assembly Forward.**

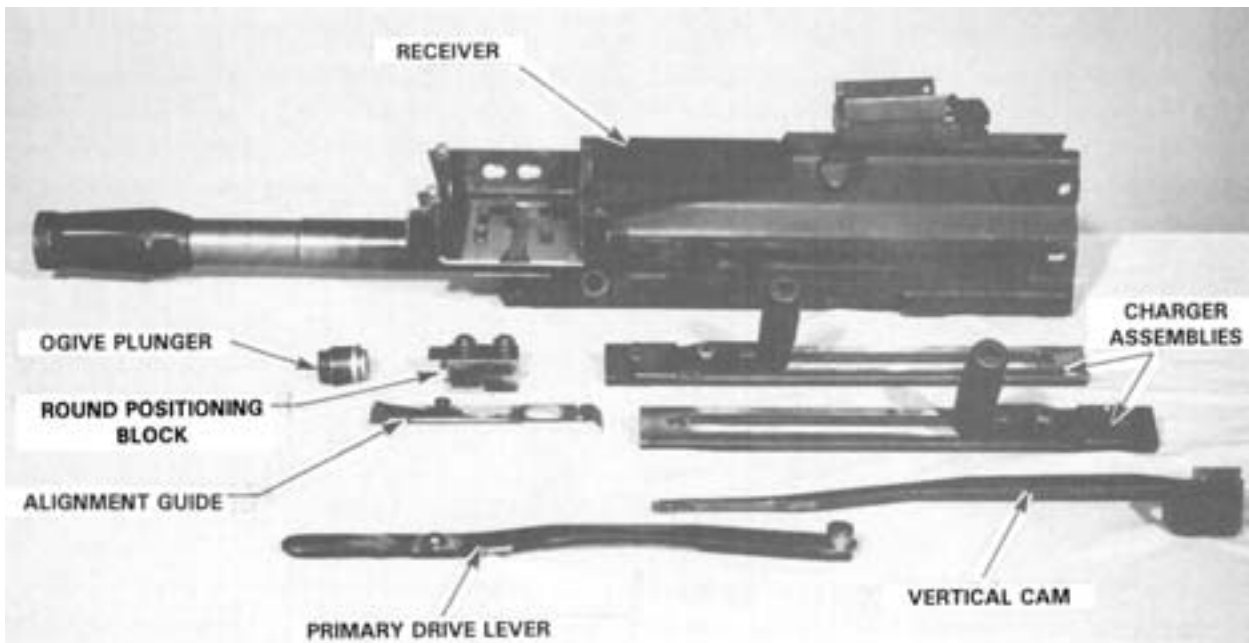
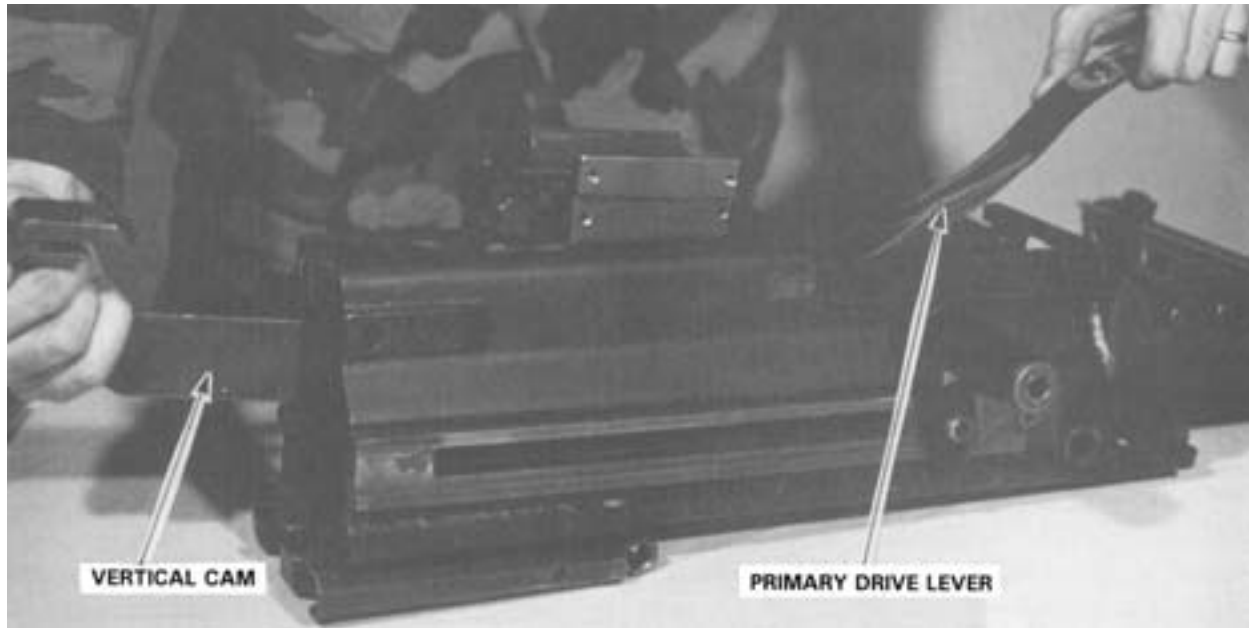

Figure 5-16. Receiver Assembly, Detailed Disassembled.

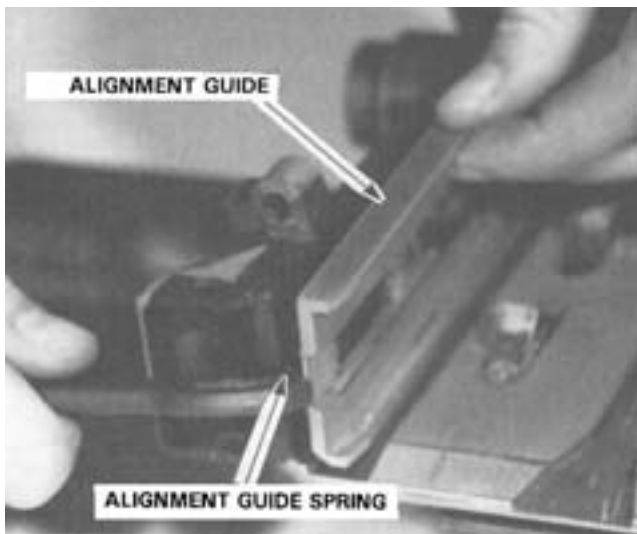

Figure 5-17. Retracting the Drive Lever Lock.

- Press down on the primary drive lever pivot post which releases both the primary drive and the vertical cam.
  - Pull out the lever and cam from their respective ends of the receiver. See figure 5-18.
- (2) Removing the alignment guide**
- Depress the alignment guide spring. Insert the cartridge link into the slot in the feeder mouth.
  - Slide the alignment guide toward the feeder mouth.
  - Pull back and lift out the alignment guide. See figure 5-19.
- (3) Removing the ogive plunger.** After removing alignment guide, remove ogive plunger by pushing rearward on the forward edge. See figure 5-20.



**Figure 5-18. Removing the Primary Drive Lever and Vertical Cam.**



**Figure 5-19. Removing the Alignment Guide Assembly.**



**Figure 5-20. Removing the Ogive Plunger.**

**(4) Removing the round positioning block**

- Depress the round positioning block and slide it toward the muzzle end of the gun.
- Pull the round positioning block away from the receiver. See figure 5-21.

**(5) Removing the charger assemblies (both sides).**  
See figure 5-22.

- Retract lock plunger with link or spent case.
- Slide charger all the way rearward.
- Pull charger away from receiver.

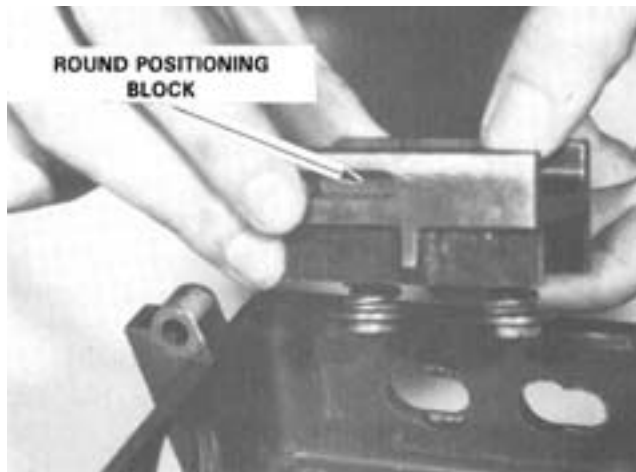

**Figure 5-21. Removing of Round Positioning Block.**



**Figure 5-22. Removal of Lock Plunger.**

#### **b. Detailed Assembly of the Receiver Group**

##### **(1) Attaching the charger assembly (both sides)**

- Rotate charger handle to the straight up position.
- Line up lugs on charger with slots in receiver rails and insert charger lugs into slots.
- Hold charger tightly against rail and slide charger forward until it locks in place.

##### **(2) Attaching the round positioning block**

- Insert block locks into slots (tang end forward).
- Push against block and slide it toward the rear until block locks in place.

**(3) Inserting the ogive plunger assembly.** With the round positioning block in place, slide the ogive plunger assembly in the slot.

**(4) Inserting the alignment guide assembly.** Once the ogive plunger is in position—

- Insert alignment guide into slot at mount.
- Engage lug on the guide to slot in receiver.
- Slide the guide toward the ogive plunger until it locks in place.

##### **(5) Replacing the vertical cam and primary drive lever**

- Slide the vertical cam assembly through the rear of the receiver.
- Engage forked end in the notch.
- Hold vertical cam in position and insert primary drive lever from the opposite end of receiver.
- Engage pivot post of lever through holes in receiver and vertical cam.
- Slide the drive lever lock forward.

---

### **Section 3 Functioning**

---

The cycle of functioning is broken down into eight basic steps. More than one step may occur simultaneously during the cycle of functioning. These steps are feeding, chambering, locking, firing, unlocking, extracting, ejection, and cocking. By understanding how the MK-19 functions, it will be easier to recognize and correct malfunctions and stoppages which occur during firing.

### 5301. Feeding

Feeding is the action of placing the round into position on the face of the bolt in preparation for chambering. When the bolt moves forward, it forces the primary drive lever to move to the right. The primary drive lever pulls the secondary drive lever with it. The secondary drive lever, which pivots in the feed tray cover, pushes the feed slide assembly to the left along the rails of the feed tray (see figure 5-23). This causes the pawls of the feed slide assembly to

be positioned onto a new round in the feeder. After the gun is fired, the bolt moves to the rear, stripping the round from the feeder. It is cammed downward into the extractors on the face of the bolt where it is in position for chambering. See figures 5-24, 5-25, and 5-26. Simultaneously, the primary drive lever is pulled to the left and the secondary drive lever is pulled with it. The feed assembly moves to the right and the pawls force the new round against the round positioning block in a position ready for feeding (see figure 5-27).

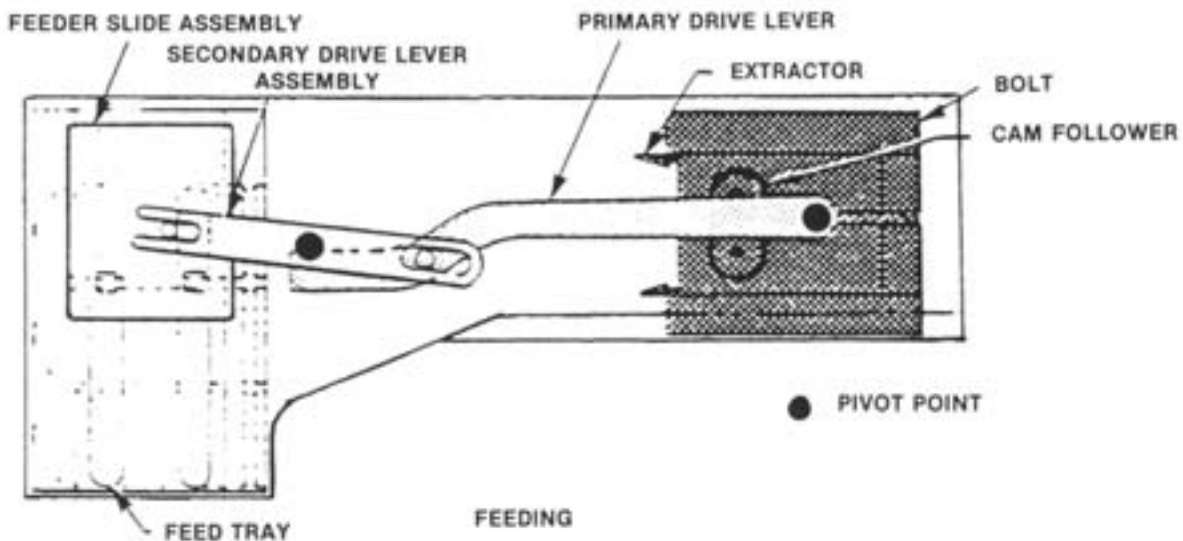

Figure 5-23. Position of Drive Levers, Bolt to Rear.

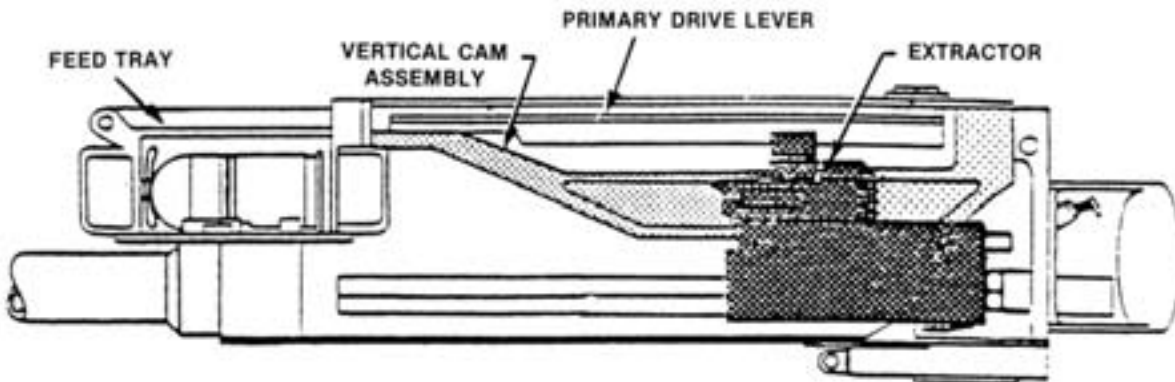

Figure 5-24. Round Positioned In Feeder, Bolt to Rear.

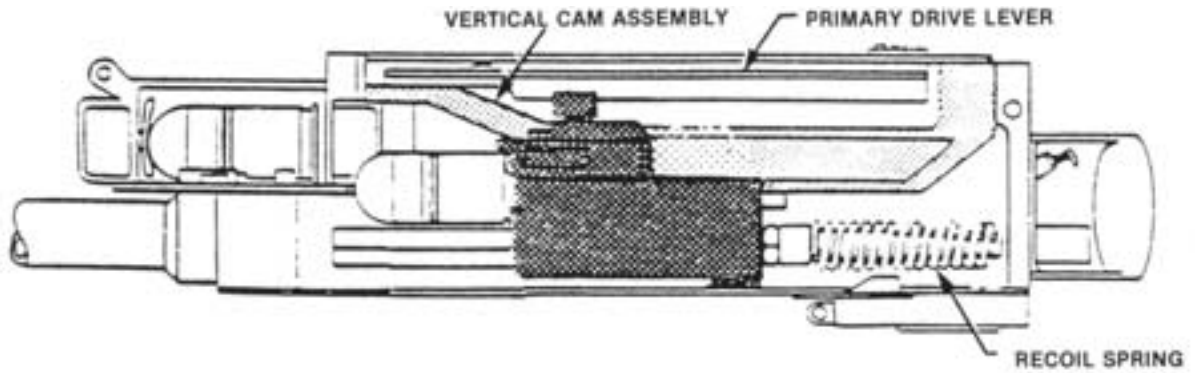

Figure 5-25. Round Picked Up by Extractors.

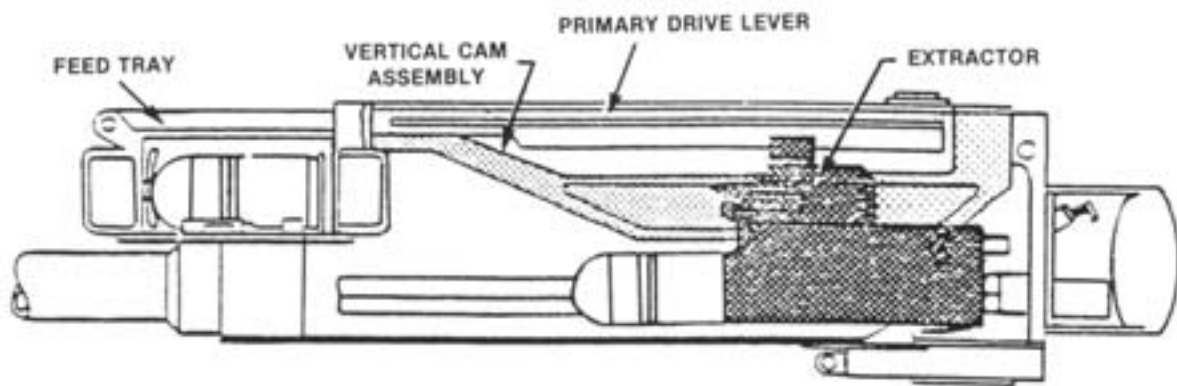

Figure 5-26. Round Cammed Down Onto Face of Bolt.

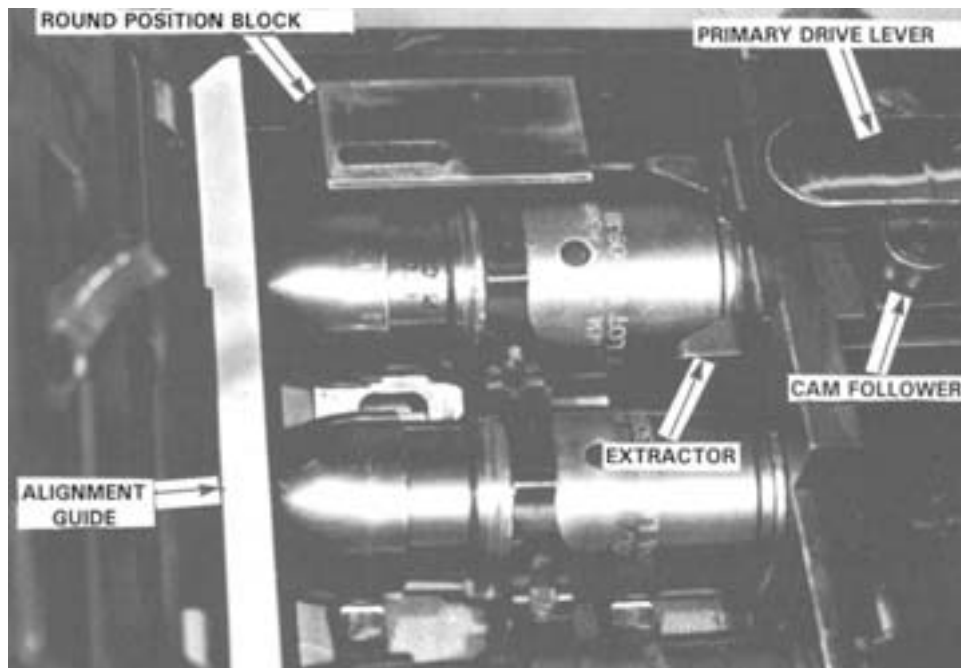

Figure 5-27. Round Positioned Against Round Positioning Block, Bolt Forward.

### 5302. Chambering

Figure 5-28 shows the round positioned on the face of the bolt ready to be chambered. By depressing the trigger, the sear is depressed, permitting the recoil springs to drive the bolt forward on the rails. As the bolt nears the forward end of the rail, the nose of the round enters the rear of the chamber. The round is fully chambered when the leading edge of the casing comes into contact with the rear of the chamber and the bolt is in the forward-most position (see figure 5-29).

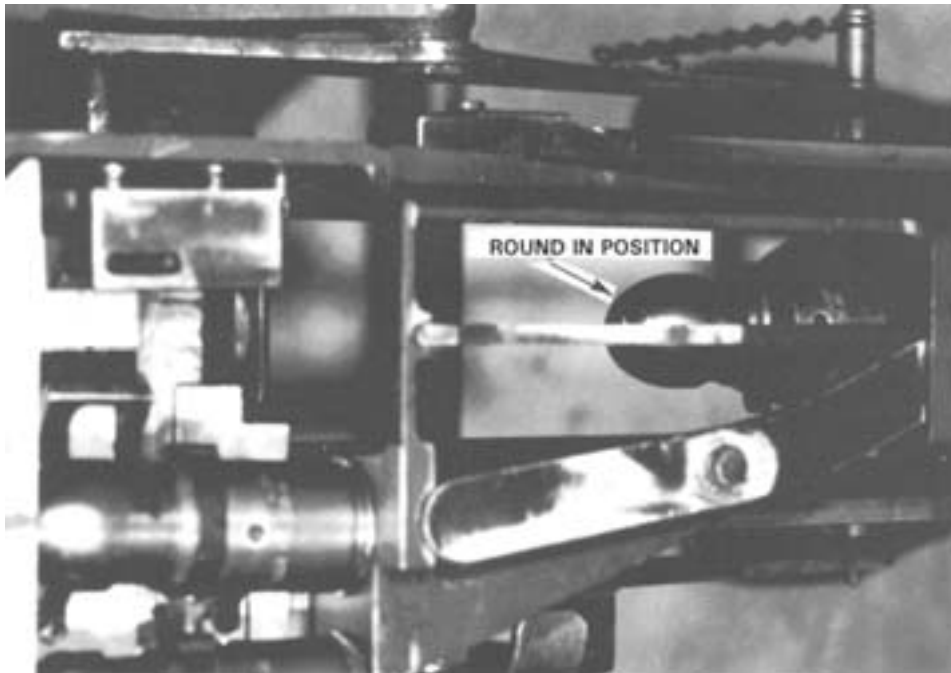

Figure 5-28. Round Positioned on Face of Bolt, Ready to Chamber.

### 5303. Locking

Locking is accomplished when the bolt reaches the forward end of the rail and the round is momentarily held in the forward-most position by the recoil springs. This is not locking as found in the gas or recoil operated weapons. In blowback operation, the only force which holds the bolt and round in position is the spring tension and weight of the bolt. The bolt and round are held in this position until the pressure of the recoil springs is overcome by the rearward movement of the bolt caused by the expansion of gas during firing.

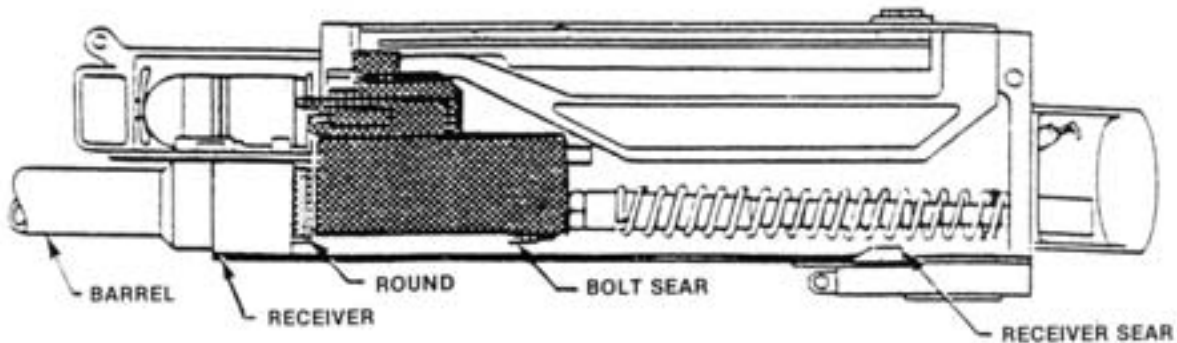

Figure 5-29. Chambering/Locking.



### 5304. Firing

As locking occurs, the cocking lever is indexed to the rear. This allows the firing pin mechanism to release the firing pin on the face of the bolt. As the bolt's forward motion is arrested, the firing pin is driven by the firing pin spring into the primer of the round. See figure 5-30.

### 5305. Unlocking

As the round fires, the pressure of the burning powder overcomes the tension of the recoil spring and the bolt moves to the rear.

### 5306. Extraction

The initial rearward movement of the bolt along the rails pulls the casing out of contact with the receiver then the extraction of the spent casing is accomplished. See figure 5-31.

### 5307. Ejection

The vertical cam forces a new round into position on the face of the bolt and ejects the spent casing out through the ejection port. See figure 5-31.

### 5308. Cocking

Simultaneously with ejection, the cocking lever is cammed forward by the rail, cocking the firing pin.

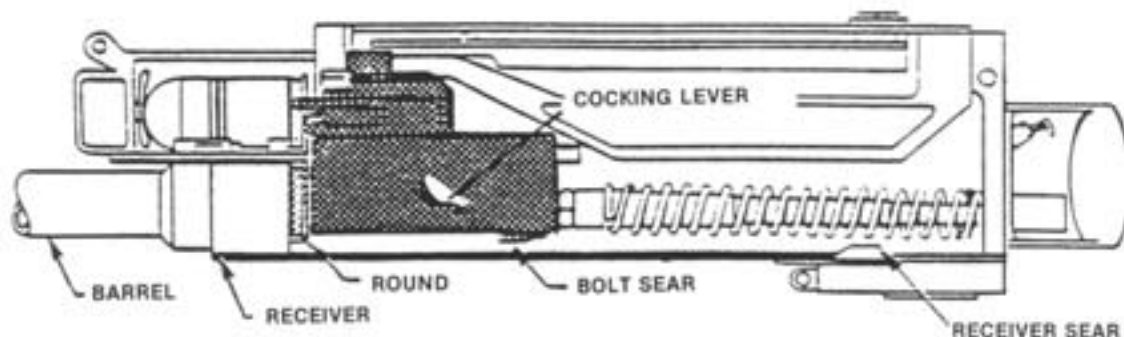

Figure 5-30. Firing/Unlocking.

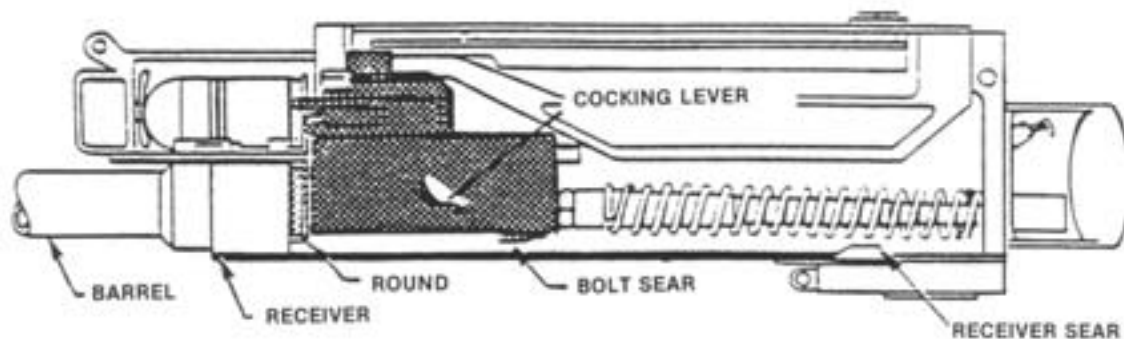

Figure 5-31. Extracting/Ejecting/Feeding/Cocking.

---

## Section 4

### Malfunctions and Stoppages

---

Machine gunners must have a detailed understanding of the many component parts of their weapon, what those parts do during functioning, and what mechanical problems may be encountered during firing. This knowledge ensures that those problems can be quickly assessed and corrective action taken.

#### 5401. Malfunctions

A malfunction is a failure of the gun to function satisfactorily. Defective ammunition or improper operation of the gun by a crew member is not considered a malfunction of the gun.

**a. Sluggish Operation.** Sluggish operation of the gun is usually due to excessive friction caused by dirt, carbon buildup, lack of proper lubrication, or burred parts. To correct the problems, the gunner should inspect the gun for worn and damaged parts and replace them as required. Keep the gun clean, and lubricate as required.

**b. Runaway Gun.** A runaway gun is a gun that continues to fire after the trigger has been released. It may be caused by worn parts or short recoil of the bolt assembly. To correct the problem, hold the fire on the target until feeding is stopped or the ammunition is expended. The best method of stopping the gun depends on several factors such as the amount of ammunition remaining on the belt and how the gun is mounted. If ammunition is not a factor and the gun is employed in the free gun mode, the gunner keeps the rounds on target until the rounds on the belt have been fired.

#### NOTE

Do not twist or attempt to break the ammunition belt.

If the gun is mounted on either the M3 or vehicle mount with the traversing and elevating (T&E) mechanism attached, the gunner holds the grip with one hand. With the other hand, he presses the

charger handle and locks and lowers one charger handle. This interrupts the cycle of function and the weapon ceases to fire (see figure 5-32). Lowering the charger handle to interrupt the cycle of operation can damage the gun.



**Figure 5-32. Lowering Charger to Stop Runaway Gun.**

**c. Firing Out of Battery.** This is a serious malfunction. A round is being fired before it is fully seated in the chamber. If this occurs, the gunner should see smoke, a flash, or powder blowback from the bottom of the gun. The following safety procedure should be used:

- Cease fire immediately.
- Place weapon on *S*.
- Clear the area around the gun of all personnel and ammunition.
- Notify safety and ordnance personnel.
- Do not attempt to fire the weapon again until it has been inspected and fixed by higher echelon maintenance personnel.

#### 5402. Stoppages

A stoppage is any interruption in the cycle of functioning caused by faulty action of the gun or ammunition. Stoppages must be reduced quickly and firing resumed. This is accomplished by immediate action.

### 5403. Immediate Action

Immediate action is that action taken by the gunner/crew to reduce the stoppage, without investigating the cause, and quickly return the gun to action.

#### a. During Peacetime and Training

- 1 Clear the area of personnel.
- 1 Wait 10 seconds.
- 1 Pull bolt to the rear. (Catch the round as it is ejected.)

#### WARNING

**If immediate action of a stoppage (bolt forward) results in the extraction of a spent cartridge, the crew will initiate subsequent action for a suspected obstruction in the barrel before attempting to fire again. (See paragraph 5403C[1]).**

- 1 Push charger handles forward and up.
- 1 Attempt to fire.
- 1 If nothing happens:
  - 1 Put gun on *S*.
  - 1 Wait 10 seconds.
  - 1 Pull bolt to the rear. (Catch round as it is ejected.)
  - 1 Open the cover, unload, and clear the weapon.

#### b. During Extreme Combat Situations.

- 1 Press charger handle locks and rotate charger handles down.
- 1 Pull and lock the bolt to the rear.
- 1 Push the charger handles forward and up to their locked position.
- 1 Relay the gun on target and attempt to fire.

**c. Subsequent Action.** Two potentially serious stoppages may occur with the MK-19 that require different procedures from those described above.

**(1) Bore Obstruction.** This means that part of the previous round may be lodged in the barrel and could possibly prevent the next warhead from passing safely through it. The gunner/crew should be alert for a muffled report from the gun when it fires, smoke and debris from the bottom of the receiver, and/or the failure of the warhead to leave the muzzle. The safety procedures are as follows:

- 1 Cease fire immediately.
- 1 Place the weapon on *S*.
- 1 Clear the area around the gun of personnel and ammunition.
- 1 Notify safety, explosive ordnance disposal, and ordnance personnel.

**(2) Jammed Bolt.** The bolt may jam as the gunner is attempting to pull it to the rear. He will not be able to pull and lock it to the rear or release rearward tension and ride it forward.

#### WARNING

**Do not open the top cover. This could allow the bolt to spring forward suddenly with a round on the face of the bolt. If that round fires while the cover is open, serious injury to personnel and damage to equipment could occur. The following safety procedure should be used:**

- 1 Put the gun on *S*.
- 1 Press the charger handle locks and rotate the charger handles down.
- 1 Pull the charger handles to the rear as far as possible and maintain rearward pressure on the handles while the squad leader/assistant gunner lifts the top cover.
- 1 Pull the charger handles to the rear until the bolt locks to the rear. Ensure the bolt will stay to the rear

before releasing rearward tension on the charger handles. Rotate them to their upright position.

- Remove the round from the face of the bolt using a length of cleaning rod.
- Press the charger handle locks and rotate the charger handles down.
- Place the weapon on F, depress the trigger, and ride the bolt home.
- Ensure the feed slide assembly is to the left and that the secondary drive lever is engaged with the feed slide pin.
- Close the top cover.

#### 5404. Remedial Action

When immediate action fails to reduce a stoppage, remedial action must be applied. This involves investigating the cause of the stoppage and may require disassembly of the weapon and replacement of parts to correct the problem. See figure 5-33, pages 5-23 through 5-25.

---

### Section 5 Mounts and Accessories

---

The MK-19 can be fired from either a ground or vehicle mount. A set of maintenance equipment and a mount and gun record book are issued with each MK-19 to help care for and operate the weapons system.

#### 5501. Tripod Mount, M3

The M3 tripod provides a stable and durable mount for the MK-19. (The M3 tripod is also used for the M2 .50 cal.) Firing the gun from the tripod permits a high degree of accuracy and control (see figure 5-34, page 5-26). For more information, see chapter 4, section VI, paragraph 4602.

#### 5502. Gun Cradle

The MK64 MOD 5 cradle is used to support the MK-19, connecting it to either the M3 tripod or to vehicle mounts. The gun is connected to these mounts by the cradle's pintle. The pintle seats in the tripod head and is held secure by a pintle lock and spring. The pintle is released by raising the pintle lock which releases the cam. The cradle also features a stow bracket to hold the weapon in position during movement (when vehicle mounted) and has a mounting plate on the left side for inserting an ammunition canister mounting bracket (for use when vehicle mounted). As a safety device, the cradle has a safety stop that prevents the gun muzzle from going too low. The T&E mechanism is attached to the cradle and permits accurate delivery of fire. See figures 5-35 and 5-36, page 5-26.

#### 5503. Vehicle Mounts

**a. Types.** The MK-19 mounts on the M4 pedestal mount, the M66 ring mount, and the HMMWV weapons station.

**(1) Pedestal mount, M4.** This is designated for installation on M151 series vehicles; e.g., the fast attack vehicle (see figure 5-37, page 5-27). The mount is composed of a pintle socket, pintle clamping screw, column, and braces. See TM 9-1005-245-14 for information on the pedestal. For information on mounting the MK-19, see TM 9-1010-231-13&P.

**(2) M66 ring mount.** This mount is designed for installation on 2-, 5-, and 10-ton trucks or on combat vehicles (see figure 5-38, page 5-27). It consists of a machine gun mount, pintle socket, pintle clamping screw, ring assembly, brake assembly, and backrest assembly. The multiple-type ring assembly has a fixed ring for mounting to the vehicle. It also has a revolving ring that carries the pintle socket for the stepped type machine gun mount, the pintle shanks, a brake assembly, and the backrest assembly. See TM 9-1003-245-14 for additional M66 ring mount information and TM 9-1010-231-13&P for information on mounting the MK-19.

PROBLEM	CHECK FOR	CORRECTIVE ACTION
Gun won't fire.	Misfire. Ammunition jammed. Rounds aligned straight.	Follow instructions for immediate action. Clear jam. Align rounds.
	Female link first.	If male-end of link is first, remove link rounds. Replace ammunition with other end of belt, female link first.
	Broken links.	If links are broken, replace with new linked ammunition.
	Bad ammunition.  1) Examine the round. The round is defective if the primer is deeply indented.  2) If primer is not indented, firing pin could be defective.	Remove round from bolt face. (If bolt is forward, pull back slightly on one charging handle as the round is removed from the bolt.)  Dispose of bad round as directed by current procedures and attempt to fire next round. If same problem occurs, replace ammunition belt.  Pin must be replaced by armorer.
	Short recoil. Round is deformed and/or partially chambered. Perform immediate action, then check for—  1) Carbon buildup in the chamber.  2) Dry or obstructed receiver rails.  3) Dirty gun.	<b>IMMEDIATE ACTION:</b> Slide belted rounds out of feeder. Remove deformed round from chamber. Pull bolt to rear.  Clean bore and chamber with bore cleaner and brush.  Lubricate or clear obstruction.  Field strip gun. Clean. Inspect. Lube.
	<b>CAUTION</b> Before proceeding, slowly release bolt to forward position.	
	4) Loose, broken, or burred feeder or feed slide assembly parts.  5) Loose, broken, or burred bolt assembly parts after removal of the bolt and backplate assembly.  6) Bad timing.	All worn, burred, or defective parts must be repaired by the armorer.  All worn, burred, or defective parts must be repaired by the armorer.  Armorer must adjust timing.

Figure 5-33. Corrective Action for Stoppages.

PROBLEM	CHECK FOR	CORRECTIVE ACTION
Gun won't fire— Continued.	Bad firing pin.	Check the firing pin if the primer on the round is not indented.
	1) Firing pin tip fails to spring forward.	Report defect to the armorer.
	2) Firing pin dirty.	Clean and lube bolt face.
	3) Firing pin chipped or broken.	Report defects to the armorer.
	Defective feeder or feed slide assembly.	
	1) Press pawls to determine if they are weak or broken.	Report defects to the armorer.
2) Feed slide assembly binding.	Remove feed slide assembly and tray. Clean. Inspect. Lube.	
3) Link guide badly worn.	Report defects to the armorer.	
	Bolt won't pick up round.	
	1) Spent case in chamber.	Remove case.
	2) Check extractors:	
	- Dirt clogged.	Scrape out dirt, especially on sides. Clean. Lube.
	- Weak or damaged.	Report defect to the armorer.
	Bolt drops round before firing.	Dispose of dropped live round as required by current directives.
	1) Weak/damaged bolt fingers or extractors.	Report defects to the armorer.
	Bad cocking lever.	Remove bolt and backplate assembly.
	1) Examine cocking lever (left side of bolt) for wear or damage.	Report defects to the armorer.
	<p><b>CAUTION</b></p> <p>Reassemble bolt and backplate with cocking lever in the forward position.</p>	

Figure 5-33. Corrective Action for Stoppages—Continued.

PROBLEM	CHECK FOR	CORRECTIVE ACTION
Gun won't fire— Continued.	Receiver rails binding.	Test by pulling the bolt to the rear. Ease it forward (hold on to one charging handle while you press the trigger).
	Binding rails.	Remove chargers. Inspect receiver rails for dirt or burrs. Clean and lube rails. Report burns or bent rails to the armorer.
Sluggish or erratic firing.	Dirty bore or chamber.	Clean bore and chamber.
	Weak recoil springs.	Report weak spring to the armorer.
	Bent guide rods.  1) Pull out bolt and backplate assembly until it <i>clicks</i> .  2) Push against springs to test for weakness. Note if rods are bent.	Report bent guide rods to the armorer.
	Timing needs adjustment.	Report defect to armorer.
Runaway gun (uncontrolled automatic fire).		<b>IMMEDIATE ACTION:</b> Keep gun (when operated as free gun) pointed down range until ammunition is exhausted. If gun is mounted on tripod, hold weapon on target while lowering one charging handle. Gun will stop firing.
	Damaged sear. Remove receiver sear housing and check sear components.	The armorer must repair defects.
	Defective trigger. Trigger feels loose or doesn't operate.	Have the armorer check the trigger mechanism.
Gun fires too soon out of battery.	<div style="border: 1px solid black; background-color: black; color: white; padding: 5px;"> <p><b>WARNING</b></p> <p>Do not operate weapon until it has been checked out and repaired by an armorer. The weapon could be dangerous.</p> </div>	
Gun ceases to fire.	Recharge and attempt to fire one time.	Go to stoppage table.

Figure 5-33. Corrective Action for Stoppages—Continued.

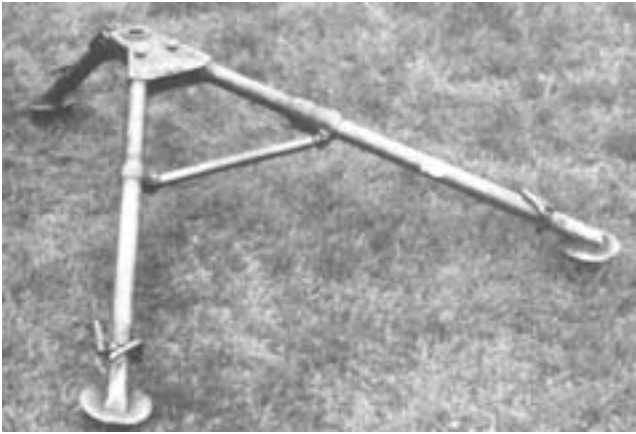

**Figure 5-34. M3 Tripod.**



**Figure 5-36. MK64 MOD 5 Cradle Mounted on the M3 Tripod.**



**Figure 5-35. MK64 MOD 5 Cradle.**





Figure 5-37. Pedestal Mount M4.

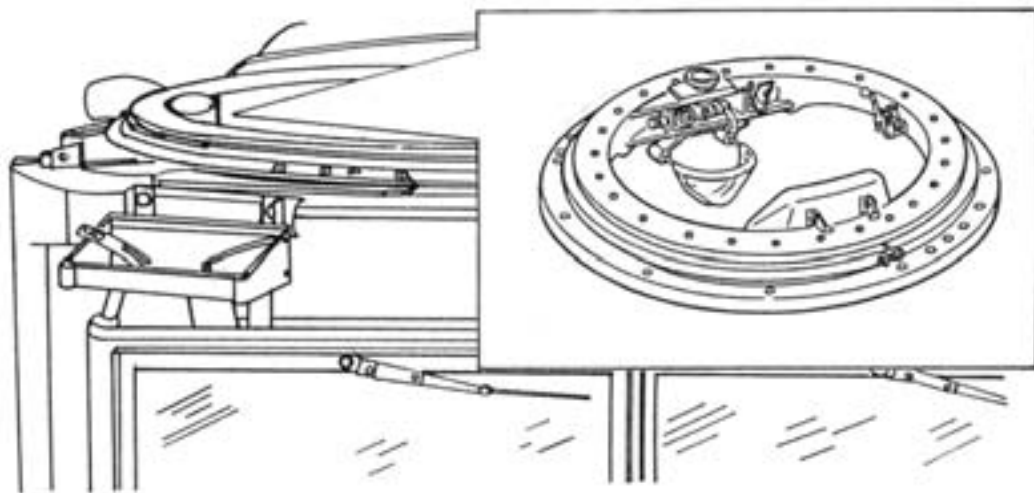

Figure 5-38. M66 Ring Mount.

(3) **HMMWV weapons station.** This consists of a rotating platform with a pedestal that accepts the MK64 MOD 5 cradle (see figure 5-39). The pedestal is detachable with a quick release pin. For information on weapons stations, see TM 9-1010-231-13&P.

**b. Accessories.** There are two accessories needed to mount the MK-19 on vehicles.

(1) **Pintle adapter.** The upper end of the pintle adapter has a hole that is shaped to accept the M4 cradle's pintle. The adapter is equipped with a quick-release pintle that secures the carriage and cradle. The lower end of the adapter is shaped to fit the mounting hold in the upper end of the M4 pedestal, HMMWV weapons platform, and the M66 ring mount. It is secured by the pintle lock on the vehicle pedestal (see figure 5-40).

(2) **T&E mechanism mount assembly.** This assembly adapts the T&E so that it secures the carriage and cradle to the M4 pedestal or HMMWV weapons platform pedestal and provides fire control adjustments (see figure 5-41). The lower end of the assembly is attached to the pedestal by a train lock clamp. It may be released for traverse or locked in position by a train lock handle. Two positioning clamps are provided to prevent up or down movement of the traversing lock clamp on the M4 pedes-



Figure 5-39. HMMWV Weapons Station.

tal. When used on the HMMWV weapons platform pedestal, only one clamp is required above the traversing lock clamp. A standard caliber .50 traversing mechanism composes the upper end of the T&E assembly. It is attached to the lower rear holes in the M4 cradle by a retaining pin.

#### 5504. Night Vision Sight, AN/TVS-5

The AN/TVS-5 is a portable, battery-operated, electro-optical instrument used for passive night observation and fire. It amplifies natural light such as moonlight, starlight, and skyglow. The sight does not emit visible infrared light that can be detected by the enemy. The AN/TVS-5 may also be used with the M2. See TM 11-5855-214-10 for more information on the AN/TVS-5.

**a. Installation.** The M2 mounting bracket is used to install the AN/TVS-5 on the MK-19. With the MK-19 mounted on the tripod—

- Slide the mounting bracket over the rear sight housing of the gun. The bracket slides from the muzzle end of the weapon.
- Lock down the locking cams of the mounting bracket in the following sequence: side cam, left top cam, right top cam.



Figure 5-40. Pintle Adapter.

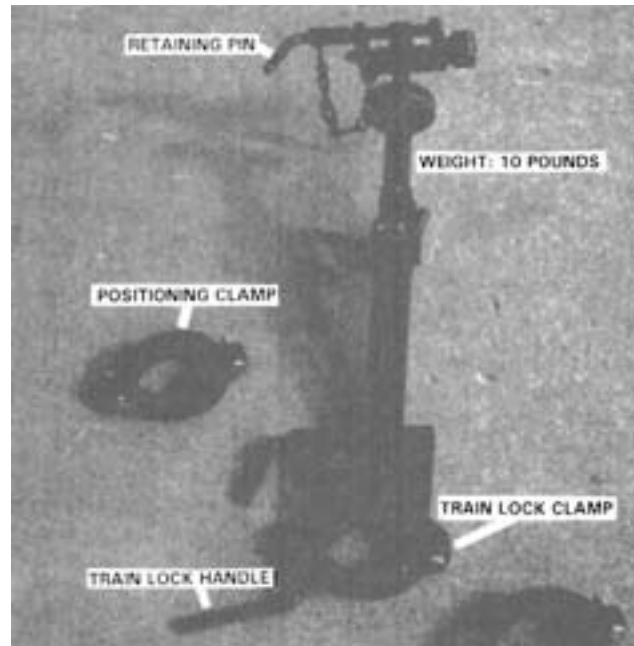

Figure 5-41. T&E Mechanism Mount Assembly.

- Place the AN/TVS-5 on the mounting bracket by positioning it in the groove at the top rear of the bracket so that the scribe line on the bracket is aligned with the scribe line in the sight mounting adapter.
- Insert the lever screw from the bottom of the mounting bracket into the sight mounting adapter. Tighten the lever screw.

**b. Use of the Reticle Cell**

(1) **Proper reticle cell.** The proper reticle cell must be installed in the AN/TVS-5 before the sight can be used for aimed fire of the MK-19. The AN/TVS-5 should be equipped with a dual-purpose reticle pattern for both the M2 and MK-19. Installation of the proper reticle must be performed by authorized maintenance personnel.

(2) **Dual-purpose reticle pattern.** The M2 aiming points are as on the M2/M85 reticle. The stadia lines are used to determine range to a 20-foot wide target. Manipulate the sight picture so that the target fills the space between the stadia lines in order to determine the corresponding range to the target. MK-19 aiming points for stationary targets are aligned vertically in the center of the reticle. Aiming points to lead a target moving 10 mi/h are located vertically to the left and right of the stadia lines.

**c. Field Zeroing.** To field zero—

- Select a suitable target of known range in the hundreds of meters from 500 to 700.
- Sight in on the target with the weapon's zeroed daylight sights. Use the proper range setting.
- Lower the daylight sight without disturbing the alignment of the weapon.

- Mount the AN/TVS-5. Place the sight into operation.
- Adjust the azimuth and elevation actuators until the proper range mark comes to bear on the target.
- Fire one or two rounds to settle the sight on the weapon.
- Tighten the sight mounting bracket and the lever screw.
- Refire on the target, making any necessary adjustments to the sight, until the target can be hit using the proper range mark.

---

## Section 6 Maintenance

---

Care, cleaning, and maintenance determine whether or not the gun will function properly when needed. The bore and chamber must be properly maintained to preserve accuracy. Because of the close fit of working surfaces and the high speed at which the gun operates, the receiver and moving parts must be kept clean; correctly lubricated; and free from burrs, rust, dirt, or grease to ensure proper, efficient functioning. The care, cleaning, lubrication, and adjustment of the mounts used with the gun are no less important. The functioning of the gun and mount together determine overall effectiveness. All accessories and equipment used with the gun and mount, including ammunition, must be properly maintained.

### 5601. Cleaning Materials and Lubricants

**a. Cleaning Materials.** CLP is a special cleaning solution and lubricant containing Teflon™ that can be used to clean and preserve all the metal parts of the weapons system. It may be used as a lubricant during normal operation of the gun also.

RBC can be used to clean the bore of the machine gun barrel after firing. Immediately after using bore cleaner, dry the bore and any parts of the gun exposed to the bore cleaner and then apply a thin coat of CLP or lubricating oil.

Dry cleaning solvent can also be used to clean all metal parts of the weapons system. This material dries out the metal severely so a thin coat of CLP or lubricating oil should be applied afterwards. This cleaning material is especially useful when cleaning the gun in preparation for changing the type of lubricant used.

When RBC and CLP are not available, hot or cold water can be used; however, warm or hot, soapy water is recommended. After using soap and water, dry the parts immediately and apply a thin coat of CLP.

**b. Lubricants.** LSA-T is the preferred lubricant for use on all friction producing parts during operation of the gun in normal conditions. Lubricate the weapon with LSA-T in temperatures between 0 degrees Fahrenheit and 215 degrees Fahrenheit. It will not burn off the gun as it heats up during operation nor will rain or excess moisture wash it off.

LAW should be used during operation of the gun in sustained temperatures below 0 degrees Fahrenheit (-18 degrees Celsius). See cold climate conditions in paragraph 5604.

### 5602. Care and Cleaning Before, During, and After Firing

Figure 5-42 is an operational checklist for procedures to be followed before, during, and after firing the MK-19. At no time should the bolt and backplate assembly be immersed in cleaning solvent, as it dilutes the grease in the packed bearings.

### 5603. Normal Maintenance Procedures

Each gun should be cleaned as soon after firing as possible and each time it is exposed to field conditions. In combat conditions the gun should be cleaned and lubricated daily, whether it has been fired or not. If possible, keep the gun covered with a canvas, tarpaulin, or poncho when not in use. During normal training conditions, inspect the gun daily for rust and maintain a light coat of CLP on all metal parts. In ideal conditions, when the gun is not used and is kept

WEAPON PART	BEFORE FIRING	DURING FIRING	AFTER FIRING
Bore	Ensure it is clear and clean.		Clean and oil lightly.
Moving parts	Oil lightly and test for worn or broken parts. They should function without excessive friction.	Lubricate working parts. Observe the functioning of the gun to anticipate failures.	Inspect, clean, and oil lightly.
Ammunition	Ensure correct type is used and that it is clean and dent free. Ensure all ogives are tight. Have an adequate supply on hand.	Keep correctly aligned in the feed tray. Check resupply. Protect from sun, moisture, and dirt. Watch for link stoppage.	Clean, store carefully, and replenish supply.
Top cover	Inspect for dents or damage.	Keep closed and locked down.	Lube properly after cleaning.
Line of fire	Ensure line of fire is clear of all obstructions.	Cease fire if any obstruction appears in the line of fire.	

Figure 5-42. Procedures Before, During, and After Firing.

in a clean place, it may only be necessary to disassemble and clean it every 3 to 5 days. The gun should be disassembled, cleaned, and lubricated in a clean, dry location where it is least exposed to dirt and moisture.

#### 5604. Special Maintenance Procedures

**a. Climatic Conditions.** Extremely cold, hot, dry, and tropical climates affect the gun and its functioning. Care should be taken under these climatic conditions to ensure that the gun is cleaned daily with the prescribed lubricants and protected from the elements by some sort of cover if possible.

**(1) Cold climates.** The weapon must be kept free of excess lubrication and moisture. If the weapon is brought indoors, allow it to come to room temperature, wipe it dry, and proceed with cleaning and lubrication. Lubricate the gun with LSA or CLP and keep it covered outdoors as much as possible. In sustained temperatures below 0 degrees Fahrenheit (-18 degrees Celsius), the weapon should be lubricated with LAW.

**(2) Hot, humid climates.** Inspect the gun more frequently for signs of rust. Keep the gun free of moisture and lightly lubricated with CLP.

**(3) Hot, dry climates.** Inspect and clean the weapon daily. Avoid excess lubrication, as this will attract dust, grit, and sand.

**b. Nuclear, Biological, and Chemical (NBC) Conditions.** If contamination is anticipated, apply lubricant to all outer surfaces of the machine gun (do not lubricate ammunition). Keep the gun covered as much as possible. If the gun is contaminated, use the procedures outlined in FM 3-5, *NBC Decontamination*, to decontaminate. Once decontaminated, clean and lubricate.

#### 5605. Inspection

Ensure there are no signs of dirt or corrosion during the inspection and examine each part for serviceability. Inspection begins with the weapon disassembled into its five main groups.

**a. Receiver Assembly**

- Housing must not show any cracks.
- Receiver rails must not be cracked, bent, or burred.
- Feed pawls must not exhibit weak spring action or burrs.
- Barrel must be free from carbon and not show any deformity in the lands or grooves.
- Flash suppressor must not be dented or cracked.
- Rear sight must move to the horizontal position without difficulty. The dove tail portion must not be dented and the number on the range scale must be visible.
- Ogive plunger head and round positioning block springs must not be weak.
- Charger assemblies must not be burred on grooved edges.
- Vertical cam must not be burred or scratched on the chromed edge.
- Primary drive lever must not be burred, especially around pivot posts.
- Secondary drive lever must not be burred on the pivot post or forked end. Retaining ring must be on pivot post.
- Aluminum buildup must be removed from vertical cam. If present, armorer can remove it with fine steel wool.

**b. Feed Slide Assembly**

- Feed pawls and feed tray pawls must not be burred or binding.
- Guide rails on tray must not be burred.

**c. Feed Tray Cover (Top Cover)**

- Housing must not be cracked.
- Latch must not be binding or loose.

**d. Bolt and Backplate Assembly**

- Cocking lever must not be broken or be worn on the rear tip.
- Guide rods must not be bent or binding.
- Recoil springs must not be weak.
- Backplate pin must have retaining ring.
- Safety wire must be attached to pin.

**e. Sear Housing Assembly.** Inspect for burrs on any part, especially on the rear shoulder of the sear.

**f. Mounts and T&E Mechanism**

- Clicks should be clearly heard and felt as the T&E mechanism is manipulated. The numbers on the scale should be easily visible.
- Cradle should fit snugly onto the M3 or M4 mount.
- Sleeve latch should function and the traversing bar should be tight and all numbers should be easily visible.

---

**Section 7**  
**Ammunition**

---

**5701. Identification**

Forty millimeter ammunition for the MK-19 can be identified by markings on its packaging and by the physical characteristics of the rounds, such as color and markings (see text below and figure 5-43, pages 34 and 35). Ammunition for the MK-19 is linked with M16A2 links. These links can be identified by four, finger-like tabs holding the rotating band.

**5702. Types**

**a. High Explosive.** High explosive (HE) projectiles are used for fragmentation effect against light materials and fortifications and personnel. There are

two types of HE rounds: M383 (DODAC 1310-B571) and M384 (DODAC 1310-B470). Their fillers and body materials differ, although performance traits are the same. The casings are olive drab with a yellow ogive and yellow markings.

**b. High Explosive Dual Purpose.** High explosive dual purpose (HEDP) ammunition has a high explosive projectile with an internally shaped charge capable of armor penetration as well as fragmentation effect. They are used against lightly armored vehicles, medium and light materials and fortifications, and personnel. The M430 HEDP round (DODAC 1310-B542) is the standard round for the MK-19. The casings are olive drab with a yellow ogive and yellow markings.

**c. Practice.** Practice rounds have a solid, nonexplosive projectile. One type contains a flash charge inside to simulate explosion upon impact. They are used in range gunnery practice. There are two types of practice rounds: the M918 with a flash charge inside the projectile (DODAC 1310-B584) and the M385 with a solid projectile (DODAC 1310-B480). The M918 is blue with a blue ogive and brown band and black markings. The M385 is blue with a blue ogive and black markings.

**d. Dummy.** Dummy rounds are completely inert. They are used in training; e.g., a gun drill or loading, unloading, and cleaning procedures. The M922 dummy round (DODAC 1310-B472) is green with a gold ogive and black markings.

### 5703. Ballistic Data

**a. HE Rounds: M383 and M384.** These rounds inflict personnel casualties in the target area with ground burst effects. Their effective casualty radius is 15 meters. Their arming distance is from 18 to 36 meters.

**b. HEDP Round: M430.** This round penetrates 2 inches of steel armor at 0 degrees obliquity and inflicts personnel casualties in the target area with ground burst effects. Its effective casualty radius is 15 meters. Its arming distance is from 18 to 40 meters.

**c. Practice Rounds.** Upon impact, the M918 produces a flash, smoke, and a loud report to simulate the explosion of the HEDP round. Its arming distance is 18 to 30 meters. The M385 duplicates the trajectory and time of flight of the HE rounds but is inert and has no blast effect in the target area.

### NOTE

In training, targets should not be engaged at less than 200 meters with HE or HEDP ammunition. In combat, the minimum safe distance for target engagement is 75 meters.

### 5704. Packaging

HE and HEDP ammunition is packaged in metal cans. The HE ammunition can contains 48 linked rounds (M383 and M430) per can and the HEDP ammunition can contains 50 rounds (M384) per can. A full can weighs approximately 60 pounds (see figure 5-44).

Practice ammunition is packaged in metal cans. The M918 can contains 40 linked rounds. The M385 can contains 50 rounds. A full can weighs approximately 60 pounds.

Dummy ammunition is packaged in small metal cans with 10 linked rounds in each.



Figure 5-44. 40mm Ammunition Box.

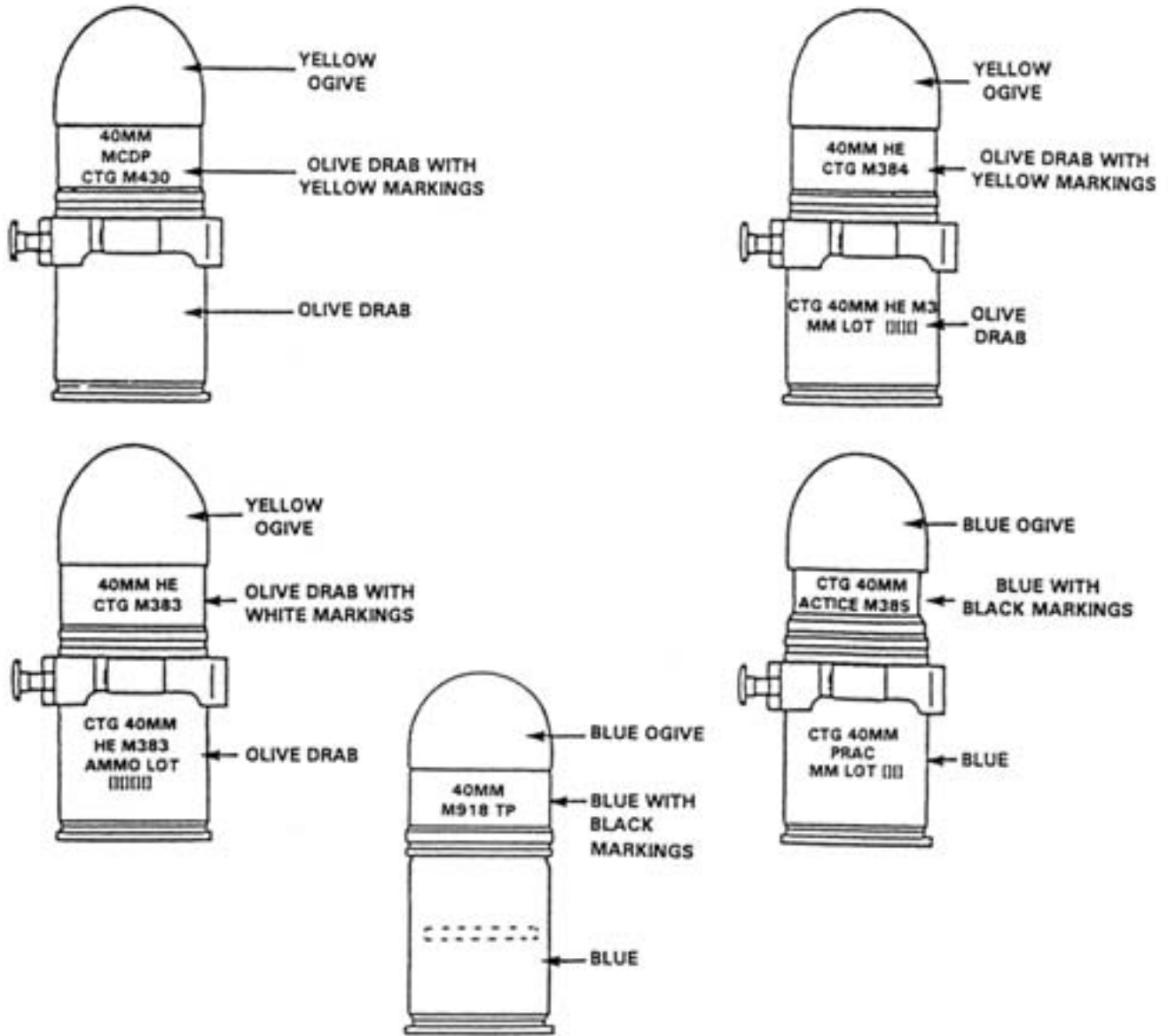

DUMMY ROUNDS—10-ROUND BELT, LINKED



Figure 5-43. MK-19 40mm Ammunition.



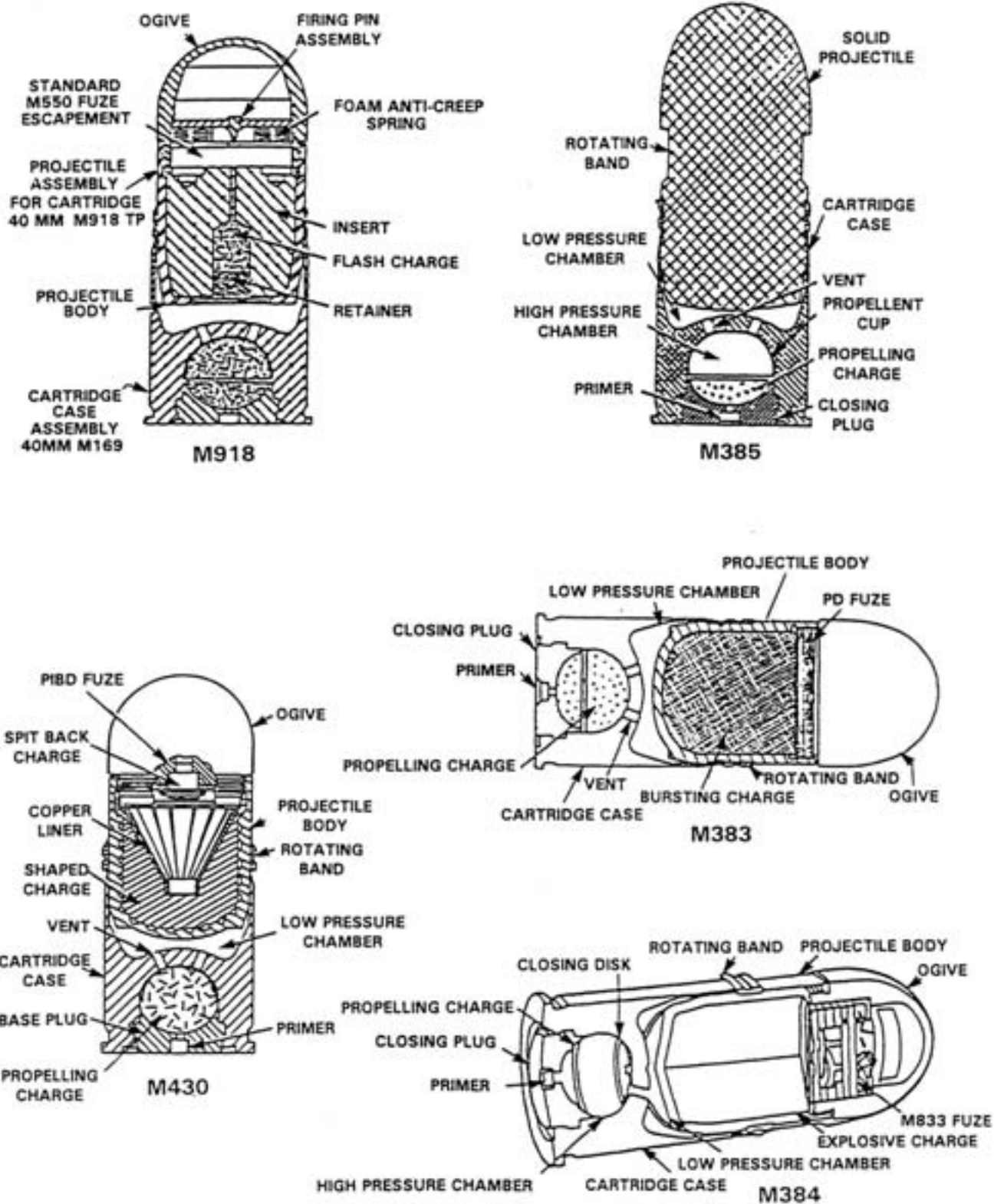

Figure 5-43. MK-19 40mm Ammunition—Continued.

### 5705. Storage

Store ammunition of all classes away from heat sources; e.g., open flames, radiators, heaters, hot water pipes. Ammunition should be stored under cover. If it is necessary to leave ammunition in the open, keep it at least 6 inches from the ground and covered with a double thickness of tarpaulin. Place the tarpaulin so it gives maximum protection and allows free circulation of air. Dig suitable trenches to prevent water from flowing under the ammunition pile.

### 5706. Care, Handling, and Preservation

Ammunition containers should not be opened until the ammunition is to be used. Ammunition removed from the airtight containers, particularly in damp climates, is likely to corrode. Protect ammunition from mud, dirt, and water. If the ammunition gets wet or dirty, wipe it off prior to use. Wipe off light corrosion as soon as it is discovered. Heavily corroded cartridges should be replaced.

Use caution during firing to ensure that ammunition is kept out of the dirt. Dirt picked up during firing will act as an abrasive in the chamber and could cause a malfunction that may result in injury to personnel and/or damage to equipment.

DO NOT expose ammunition to direct rays of the sun. If the powder is hot, excessive pressure may be developed when the gun is fired.

DO NOT oil or grease ammunition. Dust and other abrasives will collect on it and could damage the operating parts of the gun.

DO NOT fire dented cartridges, cartridges with loose projectiles, or other defective rounds.

DO NOT fire over friendly troops any ammunition graded and marked FOR TRAINING USE ONLY.

Only specially approved lots of ammunition can be used for overhead fire. The packaging of this ammunition is clearly stamped FOR OVERHEAD FIRE.

DO NOT fire ammunition (other than blank ammunition) until it has been positively identified by ammunition and grade.

---

## Section 8 Operation and Firing

---

Operation of the MK-19 includes loading, unloading, clearing, and charging the gun.

### 5801. Functioning Check

Prior to operating the gun, the gunner should conduct a functioning check which includes the following steps:

**a. Inspecting the Feed Tray Assembly and Chamber.** Open feed tray cover and inspect the feed tray assembly and chamber to ensure the gun is clear.

**b. Checking the Safety.** With the cover closed and the bolt to rear:

- Place the safety on *S*.
- Pull the trigger. The bolt should not go forward.
- Place the safety on *F*.
- Pull the trigger. The bolt should spring forward.

**c. Checking Under the Feed Tray Cover.** With the bolt forward:

- Open the feed tray cover.
- Inspect the firing pin and bolt face for signs of worn or damaged parts.
- Move the secondary drive lever back and forth to ensure that it moves freely.
- Press the feed pawls to check for spring pressure.

**d. Closing the Cover.** Ensure that the secondary drive lever is to the right and engaged under the feed tray. Slide the feed slide to the left and ensure that the bolt is forward before closing the cover.

### 5802. Loading

When the gun is mounted on the M3 tripod, ammunition is fed directly from the can. When mounted on the vehicle mount, first attach the ammunition can bracket to the slots on the gun cradle and set the ammunition can on the bracket, securing with the retaining pin.

To feed the ammunition into the gun, start by attaching the feed throat to the feeder. The gunner then squeezes the spring loaded pins on the feed throat and inserts it into the slots on both sides of the feeder. With the bolt forward, and the cover raised—

- Insert the first round into the feeder, female link first (see figure 5-45).
- Push the round across the first feed pawl (see figure 5-46).
- Move the feed slide assembly to the left (see figure 5-47).
- Close the cover.

### 5803. Charging the Gun

Charging the gun places the first round in position so it may be fired. Charging the initial round into

the gun begins by attaching the feed throat to the feeder (see figure 5-48). With the bolt forward and the weapon on *F*.

- Insert the first round, female link first.
- Push the round across the first pawl until it clicks and move the feed slide assembly to the left.
- Close the feed cover. If it does not close easily, manipulate the feed slide assembly.



**Figure 5-46. Placement of Round Across Primary Feed Pawls.**

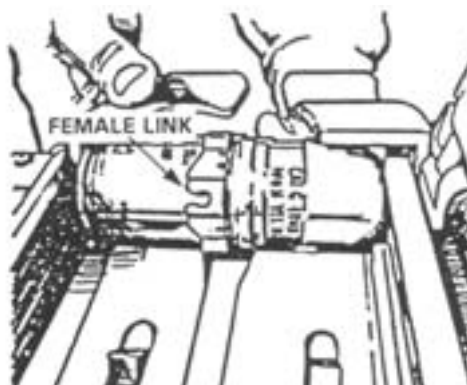
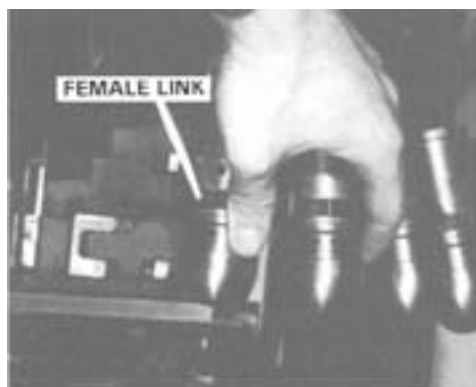

**Figure 5-45. Ammunition Belt With Female Link on First Round.**

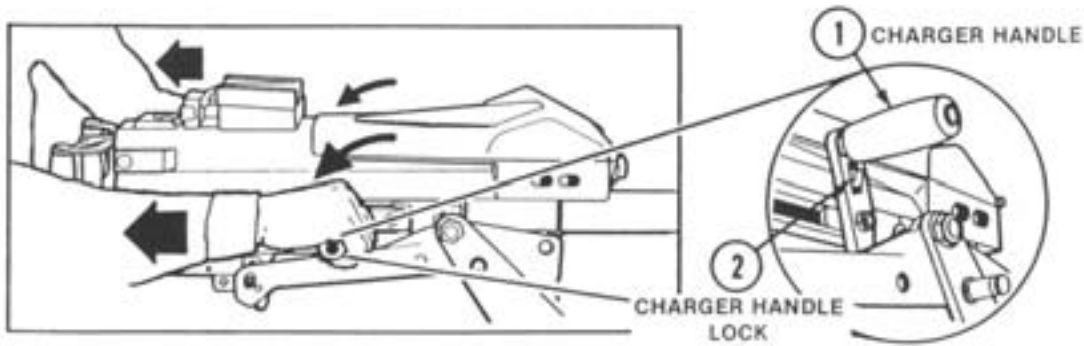

**Figure 5-47. Moving Primary Drive Lever to the Right.**



**Figure 5-48. Attach Feed Throat to Feeder.**

- Grasp the charger handles and press the charger handle locks up and in.
- Rotate the charger handles down and pull them to the rear (see figure 5-49).
- Press the locks and push the charger handles forward and up to the original position.
- Place the safety on F and press the trigger, the bolt will spring forward, loading the first round on to the face of the bolt.
- Pull the charger handles to the rear which places the bolt and round in position to fire.
- Press the charger handle locks and return the handles to the forward and up position.
- The weapon is prepared to fire. Put the safety on S until ready to fire.



**Figure 5-49. Rotating Charger Handles Down and Pulling to Rear.**

### 5804. Firing

To fire the MK-19—

- Place the safety on *F*.
- Place the charger handles in the forward and up position.
- Place hands on the control grips, thumb(s) on the trigger.
- Press the trigger to *F*.
- Fire in 3 to 5 round bursts.

### 5805. Clearing and Unloading the Gun

**a. Clearing.** Observe the following procedures:

- Put the weapon on *S* and keep it pointed down range.
- Charge the weapon and leave the charger handles to the rear and down. **DO NOT** open the cover.
- Insert a length of cleaning rod through the right hand receiver rail as close to the face of the bolt as possible.
- Push down on the casing (the round may be live or spent) forcing it off the face of the bolt and out the bottom of the gun. The squad leader/assistant gunner should catch the round as it falls out.
- Dispose of the live round per applicable directives.

**b. Unloading.** To unload the gun: open the cover, reach beneath the feeder, and press the primary and secondary positioning pawls (see figure 5-50). At the same time, slide the linked rounds out of the feeder and feed tray.

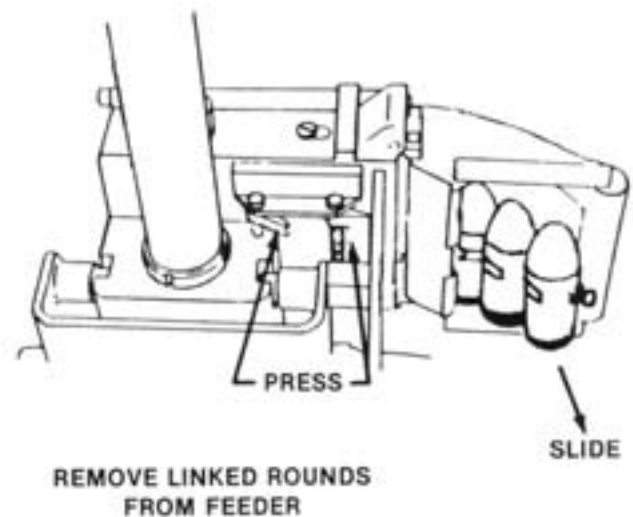

**Figure 5-50. Clearing Rounds From Gun.**

### 5806. Positions for Firing

The MK-19, like the M2 .50 cal, can be fired from the tripod mount or vehicle mount. On the tripod mount, it can be fired with the gunner in the prone or sitting position. When fired from the vehicle mount, the gunner is in the standing position. The details of the various firing positions are the same as for the M2 .50 cal and can be found in paragraph 4906. The only difference between the weapons relative to the firing position is one of terminology. What are called spade

grips on the M2 .50 cal are called control grips on the MK-19. Both the spade and control grips look alike and serve the same function.

---

## Section 9 Gun Drill

---

The MK-19 machine gun, employed on the ground on the M3 tripod, requires a crew of three to put the gun into action and keep the weapon supplied with ammunition. The purpose of a gun drill is to develop precision, speed, skill, and teamwork in the procedures for examining equipment, putting the gun into action, and taking the gun out of action. Generally, crew duties in a gun drill with the MK-19 are the same as those for the M2 .50 cal, therefore figures from that chapter will be referred to in this section. Precision is stressed. Once precision is attained, speed and teamwork can be developed. Duties should be rotated during a gun drill to allow each member of the crew to become familiar with the duties of the other members.

### 5901. Crew Equipment

In addition to individual arms and equipment, crew members carry the following equipment for the tripod-mounted MK-19:

- The squad leader carries the M3 tripod and one box of ammunition.
- The gunner carries the MK-19, M2 compass, and binoculars.
- The ammunition bearer carries the MK64 MOD5 cradle with attached T&E mechanism and one box of ammunition.

### 5902. Form for Gun Drill

The section or squad leader commands, **FORM FOR GUN DRILL**. The crew forms in column, one man in front of the gunner, one behind. There are five paces between men, in the following order: squad leader, gunner, and ammunition bearer. When the crew members reach their correct positions, they assume the prone position with equipment arranged as follows (see figure 4-91):

- The squad leader places the tripod to his left, trail legs to the rear, front leg uppermost; ammunition box to his right, latch to the front.
- The gunner places the MK-19 across his front, flash suppressor to the left, top cover up.
- The ammunition bearer places the cradle to his right, pintle and T&E mechanism outboard, ammunition box to his left front, latch to the front.
- If other members are present, ammunition boxes are placed in front, one foot apart, latches to the right (front).

Duties are rotated to ensure that each member learns and is capable of performing the duties of the other members.

### 5903. Examination of Equipment Before Firing

When the crew is formed and equipped, the squad leader commands, **INSPECT EQUIPMENT BEFORE FIRING**. At this command, the crew proceeds as follows:

- a. **Squad Leader.** The squad leader inspects the M3 tripod to ensure that—
  - Indexing levers and clamps on the front and trail legs function properly, and the legs are in the short (low) position.

- Front leg and trail legs are closely folded. Front leg clamp is hand tight.
- Sleeve lock latch and pintle lock release cam are in working order. Pintle lock release cam is down.
- Pintle bushing is free from dirt and burrs.
- Ammunition is clean, serviceable, and placed in the box correctly (female link first).
- Ammunition box is closed and locked.

**b. Gunner.** The gunner inspects the MK-19 to ensure that—

- The chamber is clean by inspecting the feed tray assembly and the chamber.
- The cover is closed, the bolt is forward, and the safety is on *F*.
- The charger assemblies are forward and locked in the up position.

**c. Ammunition Bearer.** The ammunition bearer inspects the cradle and ammunition box to ensure that—

- The cradle is properly prepared by checking that the pintle swings freely and is free of dirt, and all pins and bolts are properly seated on the cradle.
- The T&E mechanism is properly prepared by ensuring that the traversing hand wheel is centered and the elevating screws are equally exposed (about 2 inches) above and below the elevating hand wheel.
- The ammunition is clean, serviceable, and placed in the box correctly (female link first).
- The ammunition box is closed and locked.

**d. Reporting.** At the completion of the inspection, a report is rendered as follows:

- The ammunition bearer reports: **AMMUNITION CORRECT** (or any deficiencies).
- The gunner reports: **GUN AND AMMUNITION CORRECT** (or any deficiencies).

- The squad leader reports: **ALL CORRECT** (or any deficiencies).

#### 5904. Placing the Gun into Action

To place the gun into action, the section leader or squad leader commands and signals, GUN TO BE MOUNTED (pointing to the position where the gun is to be mounted), FRONT (pointing in the direction of fire), ACTION (vigorously pumping his fist in the direction of the designated gun position).

At the command or signal ACTION, the squad leader grasps the left trail leg near the center with his left hand. Springing to his feet and grasping the tripod head with his right hand, he lifts the tripod across the front of his body with the front leg up, and carries the tripod to the desired location (see figure 4-94). Upon arrival at the position, he places the trail leg shoes on the ground with the front leg pointing upward. With his right hand on the tripod head, he slides his left hand down on the left trail leg and, with a snapping motion, pulls the left leg (to the left) to engage the sleeve latch. Steadying the tripod with his left hand on the front leg, he loosens the front leg clamp with his right hand, positions the front leg with his left hand, and tightens the front leg clamp with his right hand (see figure 4-95). He then aligns the tripod for direction, drops the mount to the ground, stamps the right and left trail shoes with his right or left foot, and assumes the prone position behind the mount.

When the tripod is nearly mounted, the ammunition bearer jumps to his feet and grasps the ammunition box in his left hand and the cradle with his right hand. At the gun position, the ammunition bearer places the ammunition box on line with and 2 feet to the left of the tripod head, latch facing the tripod. The ammunition bearer hands the cradle to the squad leader. The squad leader inserts the pintle into the pintle bushing (see figure 5-51). The ammunition bearer stamps the front shoe of the tripod into the



**Figure 5-51. Mounting the Cradle on Tripod.**



**Figure 5-53. Gunner Moving into Position.**

ground with his left foot. The squad leader lifts the gun pintle lock release cam, and when the gun pintle is fully seated, he presses down the pintle lock release cam with his right hand. The squad leader attaches the T&E mechanism to the traversing bar on



**Figure 5-52. Attaching the T&E to the Tripod.**

the tripod (see figure 5-52). After he gives the cradle to the squad leader and stamps the front shoe of the tripod, the ammunition bearer turns to his left and retrieves the ammunition box which the squad leader left in his original location. The ammunition bearer places this ammunition box to the rear of the ammunition box he previously placed next to the tripod head, latch facing the tripod. He then turns to the left and returns to his original position.

When the squad leader has completed placing the cradle on the mount, the gunner grasps the gun with his left hand on the barrel and his right hand on either grip. He lifts the gun from the ground and moves rapidly to the gun position (see figure 5-53). Upon arrival, the squad leader assists in mounting the gun by positioning the cradle and steadying the gun as it is lowered into the cradle. Then the gun is secured to the cradle (see figure 5-54).

With his right hand, the gunner opens the top cover. The squad leader inserts the first round into the feeder, female link first (see figure 5-55). He then pushes the first round across the feed pawl and moves the feeder slide assembly to the left; the gunner closes the top cover. The gunner pulls the charger handles to the rear and returns them to the upright position. He presses the trigger, thus positioning the round on the





**Figure 5-54. Placing and Securing the MK-19 into the Cradle.**

face of the bolt. The gunner pulls the charger handles to the rear a second time and returns them to the upright position. He then places the safety on *S*. The squad leader raises the rear sight and the gunner announces **UP**.

### **5905. Taking the Gun Out of Action**

To take the gun out of action, the squad leader commands **OUT OF ACTION**.

The gunner raises the top cover with his right hand; the squad leader lifts the ammunition out of the feed

tray and places it in the ammunition box. He then removes the round from the face of the bolt, attaches it to the ammunition belt, and closes the ammunition box. The gunner closes the top cover.

The squad leader releases the gun from the cradle. The gunner lifts the gun off the mount and moves to a position 10 paces to the rear of the tripod, placing the gun on the ground across his front, flash suppressor to the left and top cover up. He then assumes the prone position.

Once the gunner has moved away from the tripod, the ammunition bearer, moves forward and kneels to the



**Figure 5-55. Inserting the First Round into the Feeder.**

left of the tripod. The squad leader removes the cradle and gives it to the ammunition bearer. The ammunition bearer takes the cradle in his right hand, picks up the front ammunition box with his left hand, and moves to his original position. He lays the cradle on the ground to his right, the front of the cradle forward, pintle and T&E mechanism outboard; he places the ammunition can on the ground to his left, latch to the front. He remains standing.

The squad leader assumes a kneeling position behind the tripod and releases the sleeve lock latch with his right hand. He rises to his feet, grasps the front leg with his left hand, and rotates the tripod to a vertical position on the trail legs. With his right hand, he loosens the front leg clamp, folds down the front leg, and then tightens the clamp. With his right hand on the tripod head, he rotates the tripod on the right trail leg, releases the sleeve latch, and folds the left trail leg against the right with his left hand (see figure 4-100). Holding the tripod head with his right hand, trail legs with his left, he lifts the tripod across the front of his body with the front leg up. He turns to the right and returns to his original position.

At this time, the ammunition bearer comes forward, picks up the remaining ammunition box, and places it to the right of the assistant gunner, latch to the front.

The ammunition bearer returns to his original position and assumes the prone position. The assistant gunner places the tripod on the ground, assumes a prone position to the right of the tripod, and announces **UP**.

### **5906. Duties of Crew**

To hand carry the gun and equipment, the squad leader commands **SECURE EQUIPMENT, FOLLOW ME**. At this command, the gunner moves forward toward the new position carrying the receiver on either shoulder, spade grips to the front. The squad leader carries the tripod over either shoulder and the ammunition box in one of his hands. The ammunition bearer carries his ammunition box in his left hand and the cradle in his right hand.

### **5907. Carrying the Tripod-Mounted Gun**

When the gun is mounted on the tripod, it can be moved for short distances by dragging, or by a two- or three-man carry. (In the two- or three-man carry, men should move in step to make carrying easier.) These procedures are similar to those used with the M2 .50 cal.

- a. Dragging.** The gun is dragged when limited cover or the situation requires the gun to be moved in this manner. The team gunner and squad leader drag the mounted gun to the desired position. See figure 4-101.
- b. Two-Man Carry.** With the gunner on the right and squad leader on the left, each grasps the front leg with his forward hand and a trail leg with the other hand, just above the traversing bar. See figure 4-102.
- c. Three-Man Carry.** The gunner is behind the tripod with a trail leg in each hand. The squad leader is on the left and the ammunition bearer on the right. Each grasps the front leg. In addition, the squad leader and ammunition bearer each carry an ammunition box in their free hand. See figure 4-103.

### **5908. Marksmanship Training and Qualification Firing**

The principles discussed in chapter 4, section 10, Qualification Firing, are applicable to the MK-19 as well as the M2 .50 cal. The exercises and other information provided there should be used in training Marines with either weapon.

## Chapter 6

### EMPLOYMENT AND GUNNERY

*“...there was little to stop the Japanese from moving farther west and spreading out over all of Wilkes Island unless fire from machine-guns 9 and 10 could aid the main defense line to keep the enemy bottled up around the abandoned 3-inch guns. Gun 9 was already delivering flanking fire against these Japanese, and the enemy advance was temporarily checked. The Takano troops now turned their attacks to knock out this machine gun, but its position was well prepared and well camouflaged. Although nearly surrounded, the Marines on this gun continued to hold and repel attacks which kept up until dawn.”*

—Machine gun position number 9, Wilkes Island,  
22 and 23 December 1941<sup>10</sup>



**World War II, Iwo Jima  
Marine Machine Gun Team Fires on Japanese Positions**

## Table of Contents

### Section 1. Introduction

- 6101 Employment Considerations
- 6102 Sequence of Training

### Section 2. Characteristics of Fire

- 6201 Trajectory
- 6202 Burst of Fire
- 6203 Cone of Fire
- 6204 Beaten Zone
- 6205 Dead Space
- 6206 Danger Space

### Section 3. Classes of Fire

- 6301 Classes of Fire with Respect to the Ground
- 6302 Classes of Fire with Respect to the Target
- 6303 Classes of Fire with Respect to the Gun

### Section 4. Range Determination

- 6401 Methods of Range Determination
- 6402 Lateral Distance Measurement

### Section 5. Traversing and Elevating Mechanism

- 6501 Traversing Bar and T&E Mechanism Method

### Section 6. Fire Control

- 6601 Chain of Fire Control
- 6602 Sectors of Fire
- 6603 Rates of Fire
- 6604 Adjustment of Fire
- 6605 Fire Commands

### Section 7. Methods of Target Engagement

- 6701 Distribution of Fire
- 6702 Point Targets
- 6703 Wide Targets
- 6704 Deep Targets
- 6705 Oblique Targets
- 6706 Area Targets
- 6707 Moving Targets

### Section 8. Overhead Fires

- 6801 Rules
- 6802 Use of Binocular in Applying Safety Rules
- 6803 Troop Safety Zones

### Section 9. Techniques of Predetermined Fire

- 6901 Methods of Laying the Machine Gun
- 6902 M2 Compass Method
- 6903 Using the T&E Mechanism

### Section 10. Final Protective Lines

- 61001 Sectors of Fire
- 61002 Methods of Laying Final Protective Lines
- 61003 Rates of Fire on the Final Protective Line
- 61004 Laying the Gun for a Principal Direction of Fire

### Section 11. Range Cards

- 61101 Orientation
- 61102 Recording Information

### Section 12. Firing From Defilade Position

- 61201 Defilade Position
- 61202 Selecting a Firing Position
- 61203 Laying the Gun for Direction
- 61204 Laying the Gun for Elevation
- 61205 Determining Mask Clearance
- 61206 Adjustment of Fire
- 61207 Constructing a Terrain Profile

### Section 13. Machine Gunner's Mathematics

- 61301 The Mil (A Unit of Angular Measure)
- 61302 The Mil Formula (WERM Formula)

### Section 14. Antiaircraft Gunnery

- 61401 Employment
- 61402 Target Course Definitions
- 61403 Requirements for a Hit
- 61404 Lead
- 61405 Target Engagement
- 61406 Tracer Observation

**Section 15. Firing Positions**

61501	T-Shaped Position
61502	Horseshoe-Shaped Position
61503	Two-Hole Position

**Section 16. Wire Communication**

61601	Equipment
61602	Installing a Field Wire Loop

**List of Figures**

6-1	Trajectory	6-29	Elevation Reading
6-2	Cone of Fire	6-30	Firing for Effect on a Predetermined Target
6-3	Effective Beaten Zone	6-31	Field Expedient—Base Stake Method
6-4	Effect of Ground Slopes on the Beaten Zone	6-32	Field Expedient—Aiming Stake Method
6-5	Effect of Range on Beaten Zone (Example Shown for the M240G)	6-33	Field Expedient—Horizontal Log Method
6-6	Danger Space and Dead Space	6-34	Field Expedient—Notched Stake Method
6-7	Grazing Fire	6-35	View Through Binocular; Use of Auxiliary Aiming Point
6-8	Plunging and Grazing Fire	6-36	Method of Laying When the Ground is Level or Uniformly Sloping
6-9	Classes of Fire With Respect to the Target	6-37	Method of Laying When There is a Break in the Uniform Slope (For Ranges Less Than 600 Meters)
6-10	Classes of Fire With Respect to the Gun	6-38	Dead Space
6-11	Estimating Angles in Mills With the Hand	6-39	Standard Range Card Form
6-12	Traversing Bar and T&E Mechanism (T&E Reading of L5-50/3)	6-40	Range Card With a Principal Direction of Fire
6-13	Traversing Method, Using a Squad of Guns, Both Flanks Visible to the Gunners	6-41	Minimum and Maximum Position Defilade, Partial Defilade, and Direct Lay Areas
6-14	Traversing Method, Using a Squad of Guns. Target for Heavy Machine Gun More than 100 Mills in Width (Medium Machine Gun More Than 50 Mills)	6-42	Aiming Point Method
6-15	Traversing Method Using a Section (Minus) of Guns. Target More Than 100 Mills in Width (Each Squad of Guns Covers the Entire Target)	6-43	Map and Compass Method
6-16	Traversing Method, Using a Squad of Guns; Both Flanks Invisible to the Gunners	6-44	Angles of Elevation, Angle of Site, and Quadrant Elevation
6-17	Engaging a Deep Enfilade Target With a Pair of Guns, Ends Visible to Gunners	6-45	Profile Example
6-18	Squad of Guns Engaging a Shallow or Oblique Target	6-46	Profile Line (Map Contour Interval is 10 Feet)
6-19	Sample Figure Command	6-47	Marking of Elevation
6-20	Vehicle Lead Table	6-48	Terrain Profiling
6-21	Moving Target Aiming Points	6-49	Sample Terrain Profile
6-22	Componenets of Minimum Clearance	6-50	The Mil
6-23	Theory Behind the Gunner's and Leader's Rule	6-51	Estimating Distance Between Two Objects
6-24	Application of the Gunner's and Leader's Rules	6-52	Estimating Mask Clearance
6-25	Gunner's Rule	6-53	Estimating Range Using Known Width
6-26	Leader's Rule	6-54	March Column with Four M2 .50 Cals (Added)
6-27	M240G Gunner's and Leader's Rule Data	6-55	Diagram Showing Midpoint, Approaching Leg, and Receding Leg
6-28	Direction Reading	6-56	Target Course Names
		6-57	Lead Angle, Moving Ground Target
		6-58	Lead Angle, Aerial Target
		6-59	Midpoint Leads
		6-60	Amount of Lead Necessary for Various Angles of Approach
		6-61	Superimposition

6-62	Illusion of Curvature	6-68	Firing Secondary Sector
6-63	Localized Vision	6-69	Digging T-Shaped Position
6-64	Line and Lead Information, Based on Tracer Sensings	6-70	No Secondary Section (L-Shaped Position)
6-65	Off-Line Tracer Sensings for Incoming, Outgoing, Directly at the Gun, and Very Steep Diving Course	6-71	Horseshoe-Shaped Machine Gun Position
6-66	A Hit	6-72	Two-Hole Machine Gun Position
6-67	T-Shaped Position; Firing Primary Sector	6-73	Installation of the Wire Loop
		6-74	Connection of the Wire Loop
		6-75	Connection of Other Telephones to the Wire Loop

## Chapter 6

# Employment and Gunnery

---

### Section 1 Introduction

---

Technique of fire is the method of delivering and controlling effective fire. Each member of the machine gun crew must be trained in the standard methods of applying fire, both as a crew member and as a gunner, and he must perform his assigned task automatically and effectively.

The simplest and most effective technique of delivering fire with the machine gun, mounted on its ground or vehicular mounts, is to align the sights of the gun on the target and properly apply fire. This technique of fire is called direct laying. At times, techniques of fire other than direct laying are more appropriate and effective. When delivering overhead fire and fire from position defilade, the gunner must use the appropriate techniques described in sections 7 and 11 of this chapter.

Before the machine gun can be employed to the best advantage using any firing technique, certain fundamentals must be understood and applied. These include—

- Characteristics of fire.
- Classes of fire.
- Range determination.
- Fire control and fire commands.
- Target designation.
- Methods of engaging targets.
- Overhead fire.
- Predetermined fire.
- Final protective fires.
- Range cards.

- Firing from position defilade.
- Machine gunner's mathematics.
- Firing positions.

This chapter discusses the above subjects, which apply to all phases of techniques of fire and all machine guns.

### 6101. Employment Considerations

To be most effective, a machine gun should be employed from a tripod mount on the ground, using a traversing and elevating (T&E) mechanism. While a machine gun may be employed from a vehicle mount while on the move, this lessens the accuracy of fire and generally decreases the survivability of the vehicle and personnel. When the gun must be employed from a vehicle, the leader seeks a firing position that provides the greatest possible degree of cover for the vehicle and crew. Crews should be trained to remove the gun from the vehicle mount and employ it from a tripod even during temporary halts. Mounting and dismounting drills should be standardized and practiced regularly. Machine guns have capabilities and limitations just as any weapon system does. Machine guns, though powerful weapons, do not stand alone. They are most effectively employed in concert with other weapons in an attempt to achieve a synergistic effect where the fires of one weapon compliment or augment the fires of another. The capabilities and limitations of every available weapon must be considered in order to achieve this in a tactical plan.

**a. The Squad Automatic Weapon.** Some examples of employment options using the squad automatic weapon (SAW) are as follows:

(1) **Offense.** In the offense, the SAW can augment a base of fire, adding their high volume of fire to help suppress and destroy enemy personnel on an objective. The SAW can also move with assault elements adding considerable firepower in the assault and immediately upon consolidation on the objective. This frees the medium machine gun teams/squads to be more effectively employed in a base of fire rather than trying to keep up with the assault, which can severely limit their ability to effectively engage targets.

(2) **Defense.** In the defense, the SAW can augment the final protective line (FPL) and principal direction of fire (PDF) of machine guns, or they can cover dead space in those FPLs with direct fire. SAWs can also be assigned their own PDFs to cover likely avenues of approach or other priority targets areas. The SAW's lighter weight and easier portability (in comparison to medium or heavy machine guns) make it well suited for ambush patrols because of the need for speed of movement and stealth in those operations. More important, however, is the weapon's capability for a high volume of accurate fire. The fire power provided by two or three SAWs can be devastating against personnel caught in an ambush's kill zone.

In the past, when small units lacked a weapon with the capabilities of the SAW, medium machine guns were considered essential to the conduct of a squad- or platoon-sized ambush, ensuring success through their high volume of accurate fire. In some cases machine guns may still be critical to success in an ambush, but unit leaders should carefully consider the mission of the ambush patrol before arbitrarily assigning machine guns to it. Medium machine guns have to be pulled out of the defense to go along on ambush patrols. This can weaken part of the defense for the duration that the patrol is out. Even if guns for ambush patrols can be obtained from units in the reserve or elsewhere, someone's fire power in the main defense is usually diminished to accommodate the patrol. Medium or even heavy machine guns may be needed for an ambush in situations such as when fixed fire from a tripod-mounted weapon using a T&E is considered crucial to the successful engagement of targets in the ambush, or when vehicles or other

equipment is to be engaged as well as personnel, or for some other compelling reason which the commander or unit leader decides is critical to the success of the mission. Short of situations such as those, SAWs may provide all the fire power to a squad or platoon sized ambush patrol that is needed.

**b. The M240G.** The M240G, as the Corps' medium machine gun, provides a high volume of accurate fire beyond the range capabilities of other small arms found in the rifle company. It is best employed tripod mounted. Tripod mounting the gun provides the most accurate means of delivering fire, especially at maximum effective range, and use of the T&E mechanism allows precision manipulation of that fire. It can be employed from the bipod but this should be done only in hasty situations, such as chance contact, or as a last resort when some significant problem prevents the use of the tripod. Other employment considerations include—

(1) **Offense.** In the offense the preferred method for employing the M240G is by section from a base(s) of fire from which the guns can mass their fires in a continuous, accurate, heavy volume that will produce a telling effect against enemy personnel and equipment. The weight of massed medium machine gun fire is significant and must not be underestimated. The goal is to mass the fires of the guns, not the guns themselves. The principles of dispersion, employment in pairs, and cover and concealment need not be violated to achieve the massing of machine gun fire. An observer(s) should be used to direct and adjust the fires whenever possible so that the guns can be positioned in defilade for greater protection. Although employing medium machine guns in smaller elements down to squad size is an option in the offense (primarily through attachment to subordinate elements), employing them in this manner should be carefully considered and used reluctantly. Used in this manner their fires tend to be added in a more piecemeal fashion, with reduced effect, as compared to the weight of fire that can be introduced by the section as a whole. During movement to contact, the guns can be used to over watch a unit's movement especially when negotiating terrain that impedes mobility such as crossing streams or steep draws. In difficult terrain



guns can also over watch from a moving unit's flanks, advancing by bounds with one squad always in position to fire. Security for the guns must be a matter of priority in these instances. In chance contact, the force that establishes fire superiority first and then exploits it with a rapid assault, most often prevails. When contact is initiated, machine gunners must move rapidly in the direction of enemy contact, searching for positions that will allow them to quickly add the weight of their fires against the enemy.

**(2) Defense.** In the defense, once again, the machine gun section should be employed as a whole in general support of the overall unit. The fires of the machine gun section are controlled by the unit leader, such as the rifle company commander, who is advised by the machine gun section leader and weapons platoon commander. Whenever grazing fire can be attained, the M240G should be assigned the mission of firing an FPL. The guns should generally be positioned on the flanks with interlocking FPLs and sectors of fire across the unit's front. All dead space in an FPL should be covered by other weapons systems. When terrain or mission prevent the effective use of an FPL then a PDF will be assigned to M240Gs. PDFs are typically designed to cover likely avenues of approach or areas where the enemy may mass. Often a mix of FPLs and PDFs will be assigned to a section of guns in the defense in order to best cover the frontage; however, only one mission, either an FPL or PDF, should be assigned per gun squad. The M240G can be employed from defilade firing positions and can effectively engage in indirect fire. See section 13, in this chapter, for information on firing from position defilade, appendix A for the pertinent firing tables and appendix H for information on firing and adjusting indirect machine gun fires.

**c. The M2 .50 Cal and MK-19.** These heavy machine guns provide high volumes of accurate fire at ranges beyond the capabilities of small arms, and medium machine guns. The lethality of their ammunition make them ideal for engaging troop concentrations, lightly armored vehicles, other vehicles, fortified positions, aircraft, and other equipment. The MK-19 and the M2 .50 cal are often located in the

same organization, as in the heavy machine gun platoon, weapons company of the infantry battalion. Tables of organization do not dedicate sufficient personnel to simultaneously operate both weapons provided by tables of equipment. Consequently, the commander must decide what mix of heavy machine guns to employ. The commander considers the following issues when making his decision.

**(1) Effect against armor.** The MK-19, with its high explosive dual-purpose round, is effective against light armor. It will penetrate 2 inches of homogeneous steel with 0 degrees obliquity out to 2,200 meters. It should be noted, however, that it is difficult to effectively engage moving vehicles with the MK-19 because its 40mm ammunition has a high angle of trajectory, slow time of flight, and can suffer adverse aerodynamics (drift), that becomes especially pronounced at ranges greater than 1,000 meters (see table 1 in appendix C). The M2 .50 cal, when firing the sabot light armor penetrator (SLAP) round, is highly effective against light armor targets out to ranges up to 1,500 meters. At that range the SLAP round will penetrate 3/4 of an inch of steel armor at 0 degrees obliquity. The M2 .50 cal can be effectively employed against moving vehicles.

**(2) Effect against personnel.** The MK-19's high explosive or high explosive, dual-purpose round make it very effective against personnel, with an effective casualty radius of 15 meters. The M2 .50 cal is also an effective weapon against personnel because of its high volume of fire and 700 meters of grazing fire. These characteristics make the M2 .50 cal well suited for the assignment of an in the defense against infantry attack.

**(3) In the defense.** The MK-19, with its high trajectory, is not suitable for an FPL in the defense and should normally be assigned a PDF to cover an avenue of approach, an obstacle, a defile, a choke point, or dead space in the FPL of a flatter trajectory weapon. The M2 .50 cal, however, can be assigned either an FPL or PDF to good effect. Depending on the protection and mobility of the enemy, vehicle-mounted heavy machine guns may be included in a counter attack force. Heavy machine guns may be

employed with anti-armor weapons and other elements in task organized combined antiarmor teams (CAAT) with missions assigned such as; conducting anti-armor ambushes forward of the forward edge of the battle area (FEBA), supporting a combat outpost, or reinforcing a counter attack force.

**(4) In the offense.** The mix of heavy machine guns employed in the offense depends on the nature of the enemy—especially the type and degree of protection—and the terrain and vegetation. Some guns may need to remain mounted in order to keep up with an attack, such as with a mechanized unit, or if mobility is not an issue the unit leader may want to dismount them in a base of fire in order to take advantage of the added accuracy of tripod-mounted guns. The CAATs mentioned above can be very useful in the offense also. In this role they can act as a motorized scout element that seeks to find and maintain contact with the enemy while the unit's main body maneuvers to engage, or they can conduct a route reconnaissance and provide reports about the trafficability of a unit's planned route of march. A CAAT, creatively task organized with a mix of heavy machine guns, anti-armor weapons, engineers, forward observers, etc., can be an effective independent maneuver element whose capabilities add flexibility to an offensive plan.

**(5) Effect against aircraft.** The M2 .50 cal has limited effectiveness against aircraft. The most effective caliber .50 ammunition to engage aircraft with are: armor piercing, armor piercing incendiary, and SLAP. While the MK-19's fragmentation producing ammunition could be effective against stationary aircraft, such as helicopters in a landing zone, the ammunition's slow time of flight make the weapon ineffective against moving aircraft.

**(6) Effect of firing through vegetation.** The M2 .50 cal can be employed effectively through light vegetation, while the 40mm round fired from the MK-19 may detonate prematurely when fired through the same vegetation.

**(7) Indirect firing and fire from defilade.** Because of its high trajectory compared to most machine guns, the MK-19 can effectively employ indirect fire against some defilade enemy positions. It can also be employed very effectively from defilade firing positions. Indirect firing requires that the guns be laid for deflection on some reference point other than the target and that there be an observer in communication with the guns who can adjust rounds on the target. For example, using observation posts on the military crest to adjust rounds, the MK-19 can be employed effectively in a reverse-slope defense to engage the advancing enemy on the forward slope. The M2 .50 cal can also be employed from defilade firing positions and can effectively engage in indirect fire. With the M2 .50 cal, proper use of firing tables and indirect fire techniques can yield effective fire against targets at considerably greater distances than the listed maximum effective range of the weapon. (See section 13 of this chapter, for information on firing from position defilade, appendices B and C for the pertinent firing tables, and appendix H for information on firing and adjusting indirect machine gun fires.)

**(8) Complementary effects.** The high angle of fire of the MK-19 and the flatter trajectory of the M2 can be employed effectively in tandem in many situations, the characteristics of one complementing the other. For example, the M2 .50 cal can be used to pin the enemy down while the MK-19 is used to drop high explosive (HE) or high explosive dual purpose (HEDP) on top of the enemy.

## 6102. Sequence of Training

Mechanical training, gun drill, and marksmanship are completed before training in technique of fire. Some training in range estimation by eye and characteristics of machine gun fire are necessary before conducting range practice; however, training in machine gun marksmanship is a prerequisite to instruction in technique of fire.

## Section 2 Characteristics of Fire

The gunner's knowledge of the machine gun cannot be complete until he learns something of the action and effect of the projectiles when fired. This section discusses various characteristics of machine gun fire, including trajectory, cone of fire, and beaten zone.

### 6201. Trajectory

The trajectory, or path of a projectile through the air, is influenced by several factors. The major factors influencing the trajectory are the velocity of the bullet, the gravity of the earth, the rotation of the bullet, and the resistance of the air. To overcome the influence of these factors, it is necessary to elevate the bore above a straight line from the muzzle of the gun to the target. The amount of elevation for any given range is automatically provided by the graduations on the rear sight of a rifle or machine gun. Because of this elevation of the axis of the bore, the projectile, when it leaves the muzzle, does not travel in a straight line to the target. It starts on the prolongation of the axis of the bore and rises above the line of aim. Then, under the influence of gravity, and the resistance of

the air, the projectile begins to fall, following a curved path until it intersects the line of aim again at the target. The curved path followed by the projectile is called the trajectory (see figure 6-1). The farther the bullet travels, the greater the curvature of this path. The highest point on the trajectory (maximum ordinate) is a point approximately two-thirds of the range from the gun to the target.

### 6202. Burst of Fire

The number of shots in a burst of fire is limited by several factors, including the size and shape of the target, ground formation, and ammunition supply. For normal ground targets, the number of rounds in each burst varies from about 6 to 20 for the heavy machine gun, and from 6 to 12 for the medium machine gun.

### 6203. Cone of Fire

When a burst is fired, the vibrations of the gun and tripod, variations in ammunition, and conditions of the atmosphere give each bullet a trajectory differing slightly from that of the others. The resulting group of trajectories is known as the cone of fire (see figure 6-2). For the M240G, at ranges up to 700 meters over level or uniformly sloping ground, the lower bound of

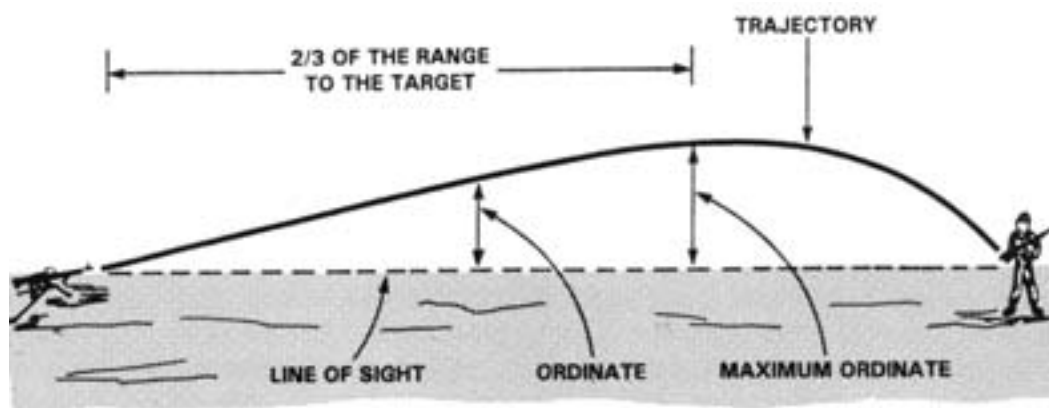

Figure 6-1. Trajectory.

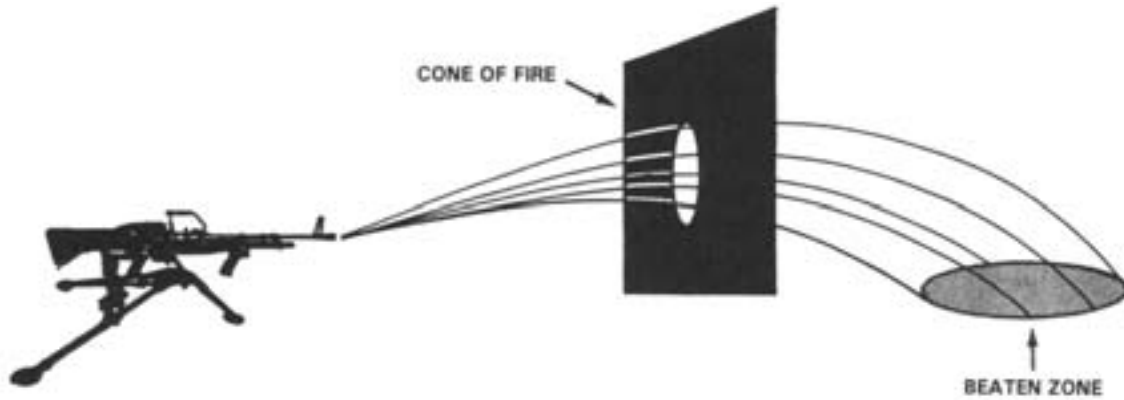

Figure 6-2. Cone of Fire.

the cone of fire does not rise above the height of a standing man (1.8 meters). With each increase in elevation of the gun, there is a further rise of the cone above the ground.

#### 6204. Beaten Zone

The beaten zone is the area on the ground upon which the cone of fire falls.

**a. Effect of Slope of Ground.** When the cone of fire falls on level ground which is at the same height as the gun, the lengths of the beaten zone are as shown in figure 6-3. The maximum length is obtained when the slope of the ground approximates the angle

of fall of the bursts. On rising ground, the length of the pattern is shortened. The minimum length occurs where the slope of the ground is perpendicular to the cone of fire at the point of impact. See figure 6-4.

**b. Effect of Range.** As the range increases, the beaten zone becomes shorter and wider. The beaten zone remains 2 mils wide at any range. See figure 6-5.

**c. Center of Impact.** The center of the beaten zone is called the center of impact (see figure 6-3). It has been found that 82 percent of the shots are uniformly grouped around the center of impact. These comprise the effective beaten zone. The remaining 18 percent of the shots are so scattered that they are considered to be outside of the effective beaten zone.

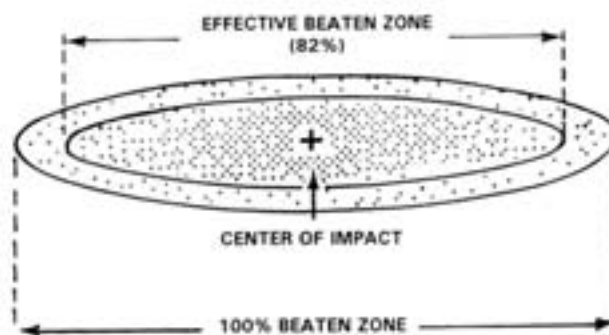

Figure 6-3. Effective Beaten Zone.

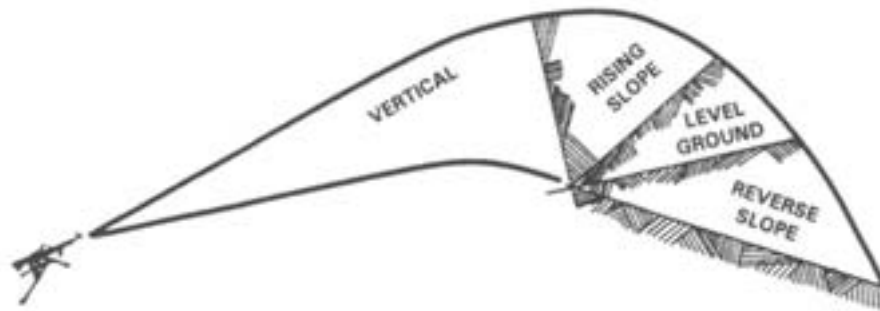

Figure 6-4. Effect of Ground Slopes on the Beaten Zone.

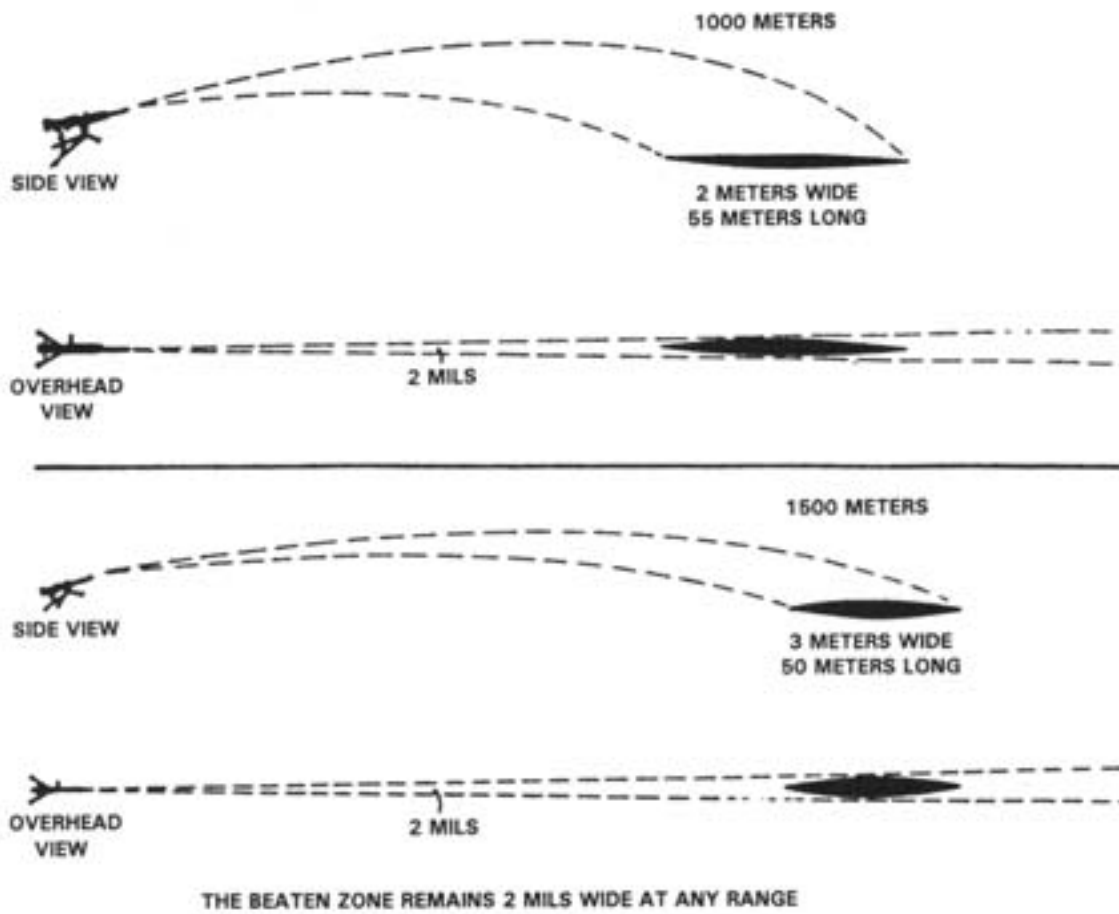

Figure 6-5. Effect of Range on Beaten Zone (Example Shown for the M240G).

### 6205. Dead Space

Dead space is an area within the maximum range of a weapon which cannot be covered by fire or observation from a particular position because of intervening obstacles, the nature of the ground, the characteristics of the trajectory, or the limitations of the pointing capabilities of the weapon. The identification of dead space in the FPL, a mission assigned to machine guns in the defense, is particularly critical. Dead space in the FPL that is not covered by other weapons systems could provide the enemy the opportunity to penetrate friendly lines. See figure 6-6, paragraphs 6206 and 6301 and appendix G for more detail.

### 6206. Danger Space

This is the area from the muzzle of the gun, out to and including the beaten zone, where a standing man (measured as 1.8 meters tall) **will** be hit, somewhere on his body, by some part of the cone of fire (see figure 6-6). When firing over flat or uniformly sloping terrain at ranges less than 850 meters, the M240G's trajectory does not rise above 1.8 meters. Beyond 850 meters the gun's trajectory does rise more than 1.8 meters. This figure of 1.8 meters is used as an estimate of the height of a standing man in tactical planning. Danger space is an important tactical consideration when planning the employment of machine guns. The likelihood of enemy casualties can be estimated at various ranges by using the concept of

danger space and the appropriate firing tables. See appendix A, M240G Firing Tables or appendix B, M2 .50 Cal Firing Tables.

Danger space should be considered along with grazing fire in assigning an FPL mission to a gun. It must be remembered, however, that effective danger space is based on the height of an average man standing **upright**. Even over uniformly sloping terrain sufficient dead space can exist along the line of fire, because of the characteristics of the trajectory, for the enemy to exploit by crouching down or crawling in order to move under the fire. For example; for the M240G, the maximum dead space, in ideal conditions on uniformly sloping ground, is 55 inches with the weapon sighted at 700 meters. This maximum dead space occurs at approximately 1/2 the range; 350 meters. A man running in a low crouch could get lower than 55 inches and therefore quickly move underneath the cone of fire in this example.

---

## Section 3 Classes of Fire

---

Machine gun fire is classified with respect to—

- The ground.
- The target.
- The gun.

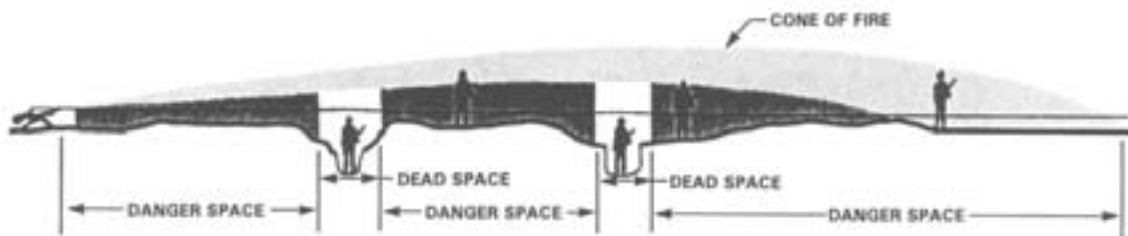

**Figure 6-6. Danger Space and Dead Space.**

### 6301. Classes of Fire with Respect to the Ground

**a. Grazing Fire.** Fire approximately parallel to the ground where the *center of the cone of fire does not rise above 1 meter*. When firing over level or uniformly sloping terrain, the maximum extent of grazing fire obtainable for the M240G is approximately 580 meters. This figure is rounded to 600 meters to simplify calculations in tactical planning and to accommodate the rear sights of the M240G which are graduated in 100 meter increments. The maximum extent of grazing fire obtainable for the M2 .50 cal is approximately 680 meters, rounded to 700 meters for the same reasons given for the M240G. On level or uniformly sloping ground danger space exists along the entire range of grazing fire. Grazing fire is the primary consideration when assigning the mission of an FPL to a machine gun, because it ensures a minimal

amount of dead space in the trajectory of the cone of fire. For example; For the M240G, the maximum dead space, in ideal conditions on uniformly sloping ground, is 31 inches for a weapon sighted at 600 meters. This maximum dead space occurs at approximately 1/2 that range; 300 meters. A man would have to crawl in order to move underneath the cone of fire in this example, significantly hampering the speed of his advance. See figures 6-7 and 6-8 and appendix G for more details.

**b. Plunging Fire.** Fire in which the angle of fall of the rounds, with reference to the slope of the ground, is such that the danger space is practically confined to the beaten zone, and the length of the beaten zone is materially shortened. Plunging fire is obtained when firing from high ground into low ground, when firing from low ground into high ground, and when firing at long ranges. See figure 6-8.

SIGHTED RANGE (m)	MAXIMUM ORDINATE (m)	MAXIMUM DEAD SPACE (m)	MAXIMUM COVERAGE (m)
500	.75	.4 (15")	560
600	1.2	.8 (31")	680
700	1.8	1.4 (55")	760

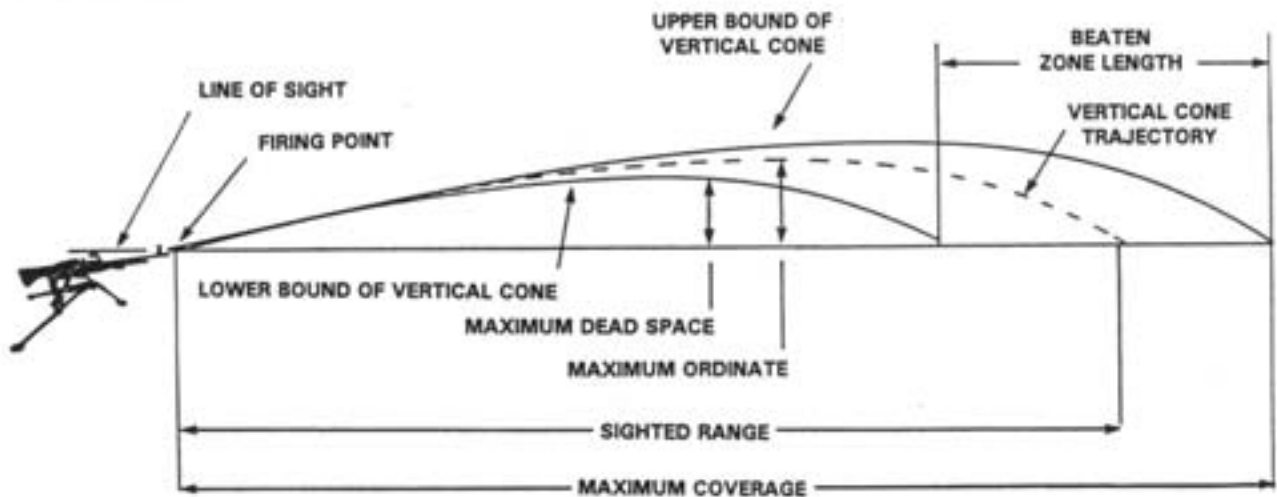

Figure 6-7. Grazing Fire.

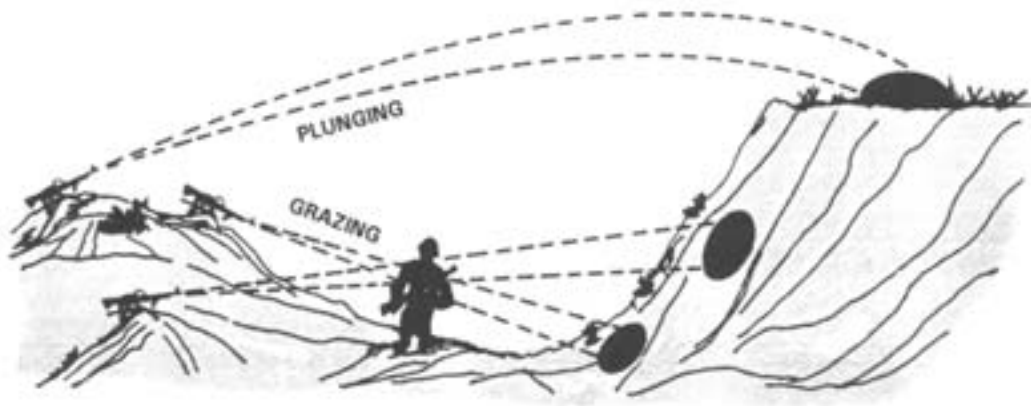

Figure 6-8. Plunging and Grazing Fire.

### 6302. Classes of Fire with Respect to the Target

- a. **Frontal Fire.** The long axis of the beaten zone is at a right angle to the long axis of the target. See figure 6-9.
- b. **Flanking Fire.** Delivered against the flank of a target. See figure 6-9.
- c. **Oblique Fire.** The long axis of the beaten zone is at an angle, but not a right angle, to the long axis of the target. See figure 6-9.
- d. **Enfilade Fire.** The long axis of the beaten zone coincides or nearly coincides with the long axis of the target. This class of fire is either frontal or flanking and is the most desirable class of fire with respect to the target, because it makes maximum use of the beaten zone. See figure 6-9.

### 6303. Classes of Fire with Respect to the Gun

- a. **Fixed Fire.** Fire delivered on a point target. Little or no manipulation is required. After the initial burst the gunner will follow any change or movement of the target without command. See figure 6-10.

- b. **Traversing Fire.** Fire distributed against a wide target requiring successive changes in the direction of the gun. When engaging a wide target requiring traversing fire, the gunner should select successive aiming points throughout the target area. These aiming points should be close enough together to ensure adequate target coverage, but not so close as to be wasteful of ammunition by concentrating a heavy volume of fire in a small area. See figure 6-10.

- c. **Searching Fire.** Fire distributed in depth by successive changes in the elevation of the gun. The amount of elevation change depends upon the range and slope of the ground. See figure 6-10.

- d. **Traversing and Searching Fire.** Fire delivered both in width and depth by changes in direction and elevation. It is employed against a target whose long axis is oblique to the direction of the fire. See figure 6-10.

- e. **Swinging Traverse.** Employed against targets which require major changes in direction but little or no change in elevation. Targets may be dense, of considerable width, in relatively close formations moving slowly toward or away from the gun, or vehicles or mounted troops moving across the front. The traversing slide lock lever is loosened enough to permit the gunner to swing the gun laterally. See figure 6-10.



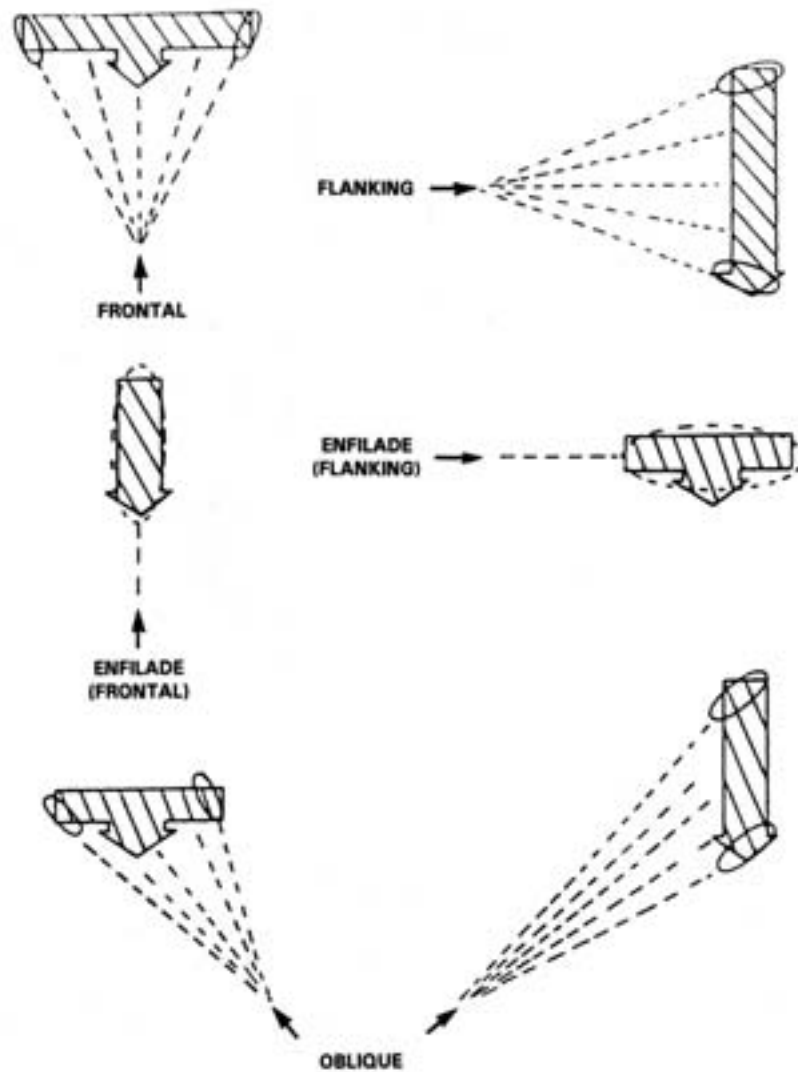

Figure 6-9. Classes of Fire With Respect to the Target.

**f. Free Gun.** Fire delivered against moving targets which must be quickly engaged and which require rapid changes in both direction and elevation. Exam-

ples are aerial targets, vehicles, mounted troops, or infantry in close formation moving rapidly toward or away from the gun position.

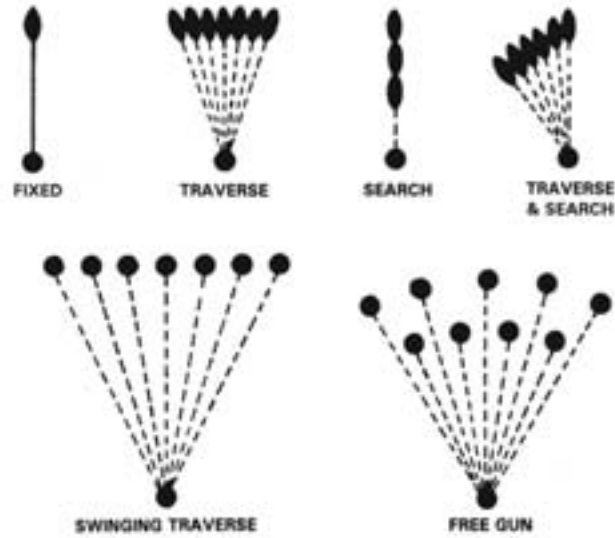

Figure 6-10. Classes of Fire With Respect to the Gun.

---

## Section 4 Range Determination

---

Under combat conditions, ranges are seldom known in advance. Also, damp ground or poor visibility often make adjustment of fire by observation impossible. Under such conditions, the cone of fire may miss the target completely, although there is an error in range no greater than 100 meters. Therefore, correct range determination is highly important for effective machine gun fire. The maximum usable range is that amount of range visible to either the leader or gunner but still within the maximum effective range of the machine gun.

### 6401. Methods of Range Determination

There are many methods for determining range. Some of these are estimating by eye, firing the gun, measuring range from a map or aerial photograph, stepping off the distance, or securing the information from

other units. Ranges are determined to the nearest 100 meters for machine gun firing. In combat, the most commonly used methods are estimating by eye and observed fire.

**a. Estimating by Eye.** Estimating by eye is the method most often used in the field. First, it is important to realize certain conditions affecting the appearance of objects. Light and terrain can sometimes make objects seem much nearer or more distant than they really are. (Although, the effect of these conditions on the appearance of objects within the first 100 meters is negligible.) Whenever the appearance of objects is used as a basis for range estimation, the observer makes allowances for the following effects.

Objects seem nearer when—

- Object is in a bright light.
- Color of the object contrasts sharply with the color of the background.
- Looking over water, snow, or a uniform surface like a wheat field.

- Looking from a height downward.
- In the clear atmosphere of high altitudes.
- Looking over a depression most of which is hidden.
- Looking down a straight road or railroad track.

Objects seem more distant when—

- Looking over a depression, most of which is visible.
- There is poor light or fog.
- Only a small part of the object can be seen.
- Looking from low ground toward higher ground.

In some cases, much of the ground between the observer and the target is hidden from view and the application of the unit of measure to the hidden portion of the ground is impossible. In such cases, the appearance of objects is the only guide. If there is a considerable stretch of visible ground extending from the flat edge of a depression to the target, it is best to estimate the distance to the far edge of the depression, judging by the appearance of objects, and then to apply the unit of measure over the remaining distance to the target.

There are two methods of estimating by eye; the 100-meter unit of measure method and the appearance-of-objects method.

**(1) 100-Meter unit of measure method.** To use this method, the gunner must be able to visualize a 100-meter distance on the ground. With this distance in mind, he can mentally determine how many of these 100-meter units there are between his position and the target. In training, his estimates should be checked by pacing off the distance. Familiarity with the 100-meter unit and its appearance on different types of ground and at different distances enables the estimator to apply it with relative accuracy. Application of the unit of measure beyond 500 meters is difficult. For this reason, in ranges over 500 meters, it is better to select a point halfway to the target, apply the 100-

meter unit up to that point, and multiply the estimated distance by 2.

**(2) An alternate method of estimation.** Another method of estimating ranges is by memorizing the appearance of objects, vegetation, and the amount of detail that can be distinguished at a few key ranges. By learning details that can be distinguished on the appearance of a man at 300, 500, 700, and 1,000 meters, a fairly reliable range estimation can be made when a man is in the vicinity of the target.

**b. Observed Firing.** In determining the range using the observed fire technique, the gunner opens fire on the target by the estimated range, moves the center of impact into the target by means of the T&E mechanism, resets the rear sight so that the line of aim is on the target, notes the sight setting on the rear sight, and announces it as the range to the target. All guns are then laid, and fire is opened on the unit leader's command. To use this method, all guns are zeroed previously so that the range determined for one gun may be used for the others.

When the ground in the vicinity of the target permits no observation of strike, or when it is desired to obtain surprise, fire is adjusted on a point which does offer observation and which is known to have the same range as the target. The gunner lays his gun on the target when ordered.

When engaging targets in a tree or building, fire is adjusted on the ground at the foot of the tree or building where the strike of the bullets is visible. The range thus determined is taken as the range to the target. The gunner announces the range and elevates his gun until it is laid on the target.

## 6402. Lateral Distance Measurement

In addition to the ability to determine range accurately, the gunner needs a quick method of measuring lateral distance right or left from a reference point to a target.

When the gun is mounted on the tripod, width can be measured by aiming on a point and manipulating the traversing hand wheel, counting the clicks from one point of aim to another point of aim. Each click equals 1 meter at 1,000 meters, or 1/2 meter at 500 meters. This method is accurate but time consuming.

The finger measurement method is not a method of range determination but only a method of measuring the lateral distance (in fingers) between two points. To measure the distance in fingers between a reference point and a target, extend the arm with the palm outward, the fingers cupped, and the elbow locked. Close one eye, raise the index finger, and sight along its edge, placing the edge of the finger along the flank of the target or reference point. Note the space remaining between the two points, and then fill this space by raising fingers until the space is covered. The measurement from the reference point to the target is then stated as being one or more fingers, depending on how many fingers are raised to cover

this distance. General guidelines for mil equivalent can be found in figure 6-11.

---

## Section 5

### Traversing and Elevating Mechanism

---

The T&E mechanism, when properly employed, enables the gunner to accurately engage targets during periods of reduced visibility and fire from defilade positions, as well as to engage enemy positions located on reverse slopes. By utilizing the T&E mechanism, the machine gun is firmly locked into the desired position. The gunner can apply the data necessary to engage a desired target, shift to other targets, and by reapplying the original data, the gunner can rapidly and accurately reengage the original target. In addition, by calculating and applying the quadrant elevation, the gunner can engage targets from a defilade position and fire on enemy positions on reverse slopes (see section 12, chapter 6). The information

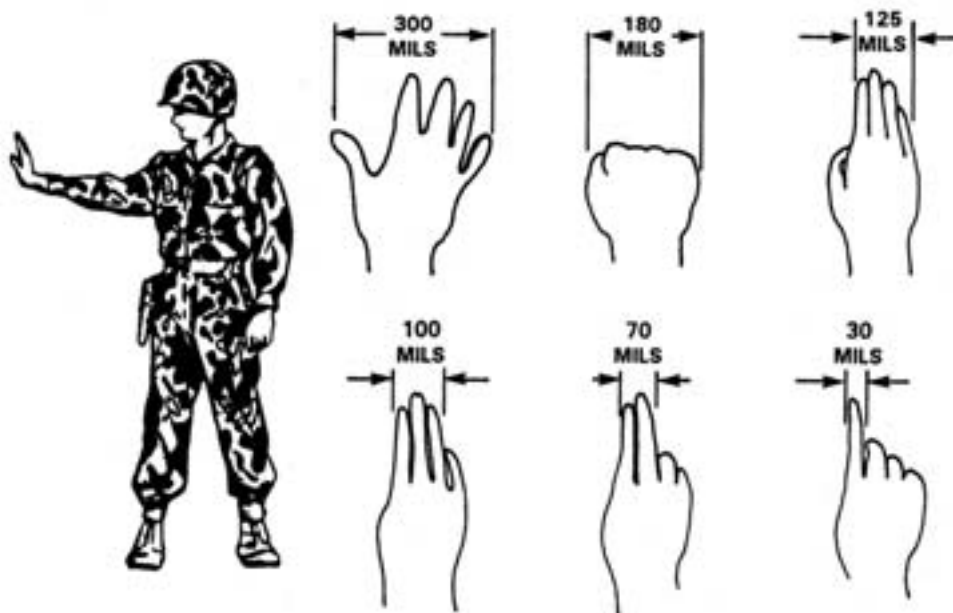

**Figure 6-11. Estimating Angles in Mils With the Hand.**

contained in this section pertains to the use of the T&E mechanism for all of the machine guns discussed in this manual.

### 6501. Traversing Bar and T&E Mechanism Method

Direction and elevation readings constitute the data necessary to engage preselected target areas during periods of limited visibility. These readings are measured by and recorded from the traversing bar and T&E mechanism. All measurements are recorded in mils.

#### a. Preliminary Steps

(1) **Positioning the traversing mechanism.** Turn the traversing hand wheel toward your body as far as it will go, then turn it away two complete revolutions. Check the traversing hand wheel scale to ensure the 0 on the scale is lined up with the 0 index line before and after the two revolutions. The traversing mechanism can be positioned at night by turning the traversing hand wheel toward your body as far as it will go, and then turning it away 50 clicks (two revolutions).

(2) **Laying the gun for direction.** To lay the gun for direction when an FPL has been assigned, lock the traversing slide on that end of the traversing bar which is opposite to the direction of the FPL. Pick up the rear legs of the tripod and shift the tripod until the muzzle of the gun points along the FPL. If an FPL has not been assigned, the gun will be laid for direction on the center of the primary sector. In this case, lock the left edge of the traversing slide on the 0 graduation on the traversing bar. The left edge of the traversing bar slide is always used as the index. Pick up the rear legs of the tripod and shift the tripod until the muzzle of the gun is laid on the center of sector. Once the gun is laid for direction, emplace the tripod firmly by digging in the tripod shoes or by placing sandbags on the tripod legs. This is done to ensure greater stability and prevent accidental movement of the tripod.

b. **Direction Readings.** Direction readings are obtained and recorded to all targets within the pri-

mary sector of fire with the exception of the FPL. The FPL needs no direction reading since the traversing slide is positioned to the extreme right or left of the traversing bar. To obtain direction readings to targets other than the FPL, loosen the traversing slide lock lever and slide the traversing bar slide along the traversing bar until the gun is laid on the center of a point target and on either flank of a linear target. Lock the traversing bar and read the direction reading from the scale on the traversing bar (see figure 6-12). If the left edge of the traversing slide does not fall exactly on a 5-mil graduation (tick-mark), move the left edge of the traversing bar slide back to the next smaller graduation, and use the traversing hand wheel to complete the initial lay. This technique will keep the muzzle of the gun moving in the same direction when laying on a target.

For example, in laying the gun on target, the gunner finds that the left edge of the traversing bar slide falls between the LEFT 300 and LEFT 305 graduations on the traversing bar. He moves the left edge of the traversing bar slide back to the LEFT 300 graduations and pulls on the traversing hand wheel to center the gun on target. Assuming he traversed LEFT 3 mils (clicks) with the traversing hand wheel, his direction reading is LEFT 303 (LEFT 300 on the traversing bar plus LEFT 3 on the traversing hand wheel). Had he initially moved the traversing bar slide to the LEFT 305 graduation, he would have had to push the traversing hand wheel (i.e., move the muzzle to the right) 2 mils to center on the same target. In this case he would have to subtract the hand wheel reading of RIGHT 2 from his traversing bar reading of LEFT 305 in order to obtain the proper direction reading of LEFT 303. The technique of moving the traversing bar slide to the next smaller graduation provides for greater simplicity and consistency.

#### NOTE

When the traversing hand wheel is used to lay on a target, it must be reset to zero before laying on another target.

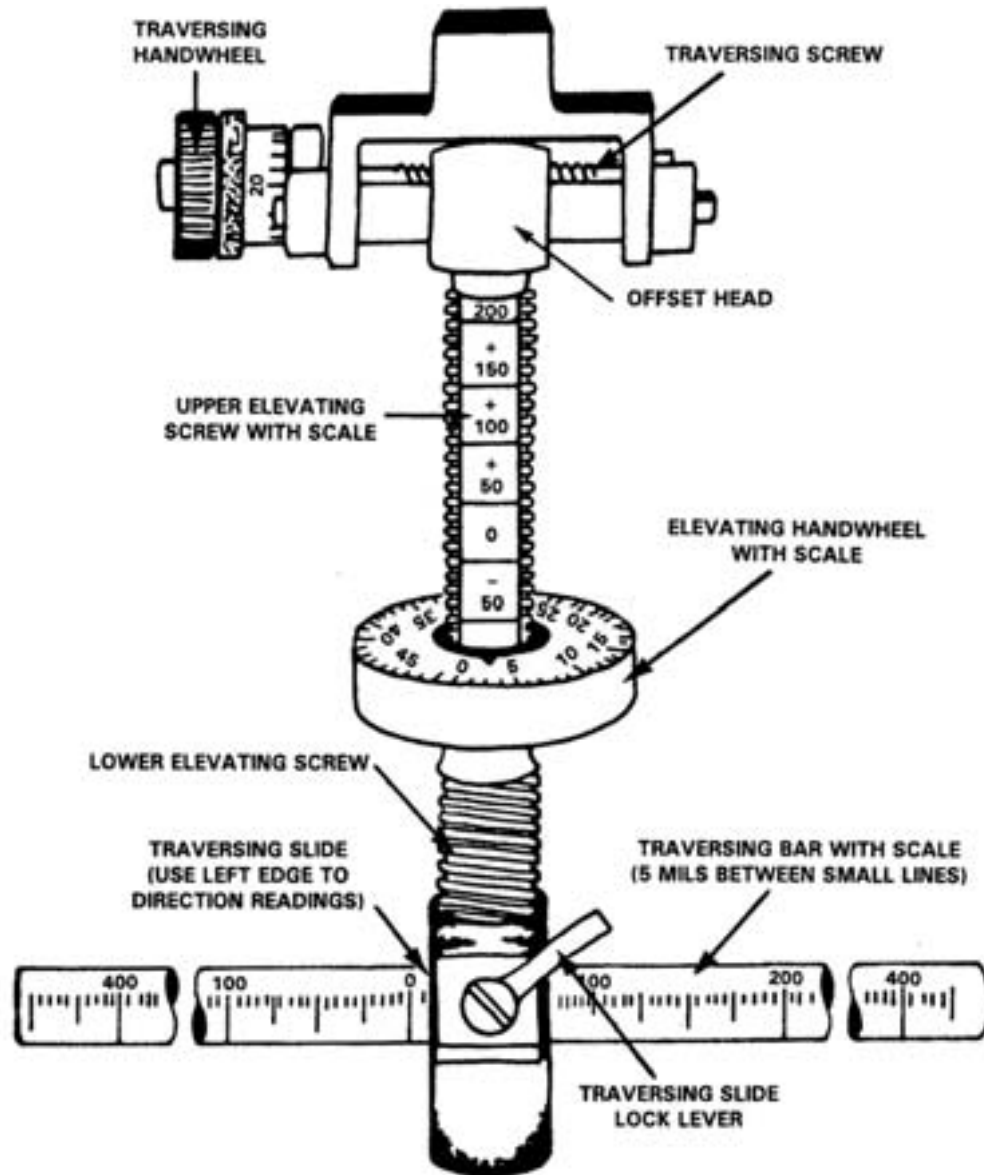

Figure 6-12. Traversing Bar and T&E Mechanism (T&E Reading of L5-50/3).

When the left edge of the traversing slide is on a graduation to the left of 0 graduation on the traversing bar, the direction reading is recorded as LEFT that number of mils (the muzzle of the weapon moves to the left). After taking a direction reading of a linear target, the width of the target is measured in mils by traversing across the target using the traversing hand wheel. The traversing mechanism must be repositioned before moving to another target.

**c. Elevation Readings.** After obtaining the direction reading to a target, an elevation reading

is obtained before moving to another target. To obtain this reading, the gun is laid on the base of the target.

The elevation reading is obtained from two scales. The first portion of the reading is taken from the engraved scale on the upper elevating screw plate. The second portion is taken from the engraved scale on the top of the elevating hand wheel, using the indicator as the index (see figure 6-12). The two portions of the elevation reading are separated by a slash (/) when they are recorded.

The engraved scale on the upper elevating screw plate is graduated in 50-mil increments from -200 mils to +200 mils. There is an index line below each number and a PLUS or MINUS sign above each number, with the exception of the 0 (see figure 6-12). The zero reading has no sign. In obtaining the elevation reading, the gunner should lower his head until his eyes are on line with the top of the elevating hand wheel. The first portion of the reading is the number and plus or minus sign above the first visible index line. As in figure 6-10, this would be a -50 reading. The scale on the elevating hand wheel is graduated in 1-mil increments for a total of 50 mils. Locate the graduation on line with the indicator (see figure 6-10). The entire reading is recorded as -50/3.

An elevation reading is valid on only one mechanism. If data are placed on another mechanism using the same mount and gun, the data could be inaccurate. The number of threads exposed on the lower elevation screw must remain the same both when obtaining and using data (see figure 6-12). If the number of threads is increased or decreased after the data are recorded, accurate fire cannot be placed on the target. For example, when a gun is freed to engage a secondary sector, should the base of the T&E mechanism rotate, the data are only correct if the gunner ensures that the same number of exposed threads is replaced on the mechanism. To replace the elevation reading of -50/3 on the T&E mechanism, manipulate the elevating hand wheel until the horizontal line below -50 is visible at eye level, with the hand wheel indicator on 3.

**(1) Elevation reading by firing.** To ensure a correct elevation reading to a target, the gunner should fire and adjust on this target.

**(2) Elevation reading without firing.** Data may be obtained on targets without firing and adjusting as mentioned in the preceding paragraph. This is accomplished using the dry-fire method of laying the gun. In using this method, the range to the target is determined by eye; this range is placed on the rear sight and the gun is laid on the center base of the target. The direction and elevation readings are then taken.

Range determination is critical, because any discrepancy will cause an error in the elevation when the target is engaged. The dry-fire method of obtaining data is used only when firing is not possible or when the situation is such that firing would disclose the position of the gun. To check the elevation, refer to the appropriate firing tables. See appendices A, B, and C.

---

## Section 6 Fire Control

---

Fire control of machine guns includes all operations connected with the preparation and actual application of fire to a target. It implies the ability of the leader to open fire at the instant he desires, adjust the fire of his guns upon the target, regulate the rate of fire, shift fire from one target to another, and cease firing. The ability to exercise correct fire control depends primarily on the discipline and correct technical training of the gun crew. Failure to exercise correct fire control results in danger to friendly troops, loss of surprise effect, premature disclosure of position, misapplication of fire on unimportant targets, loss of time in securing adjustments, and waste of ammunition.

### 6601. Chain of Fire Control

The chain of fire control follows the chain of command. Fire control of the machine gun fire unit is executed by the section and squad leaders.

**a. Weapons Platoon Leader.** Usually the platoon leaders give their instructions orally and directly to the section leaders. These orders assign a mission to the section (or squad), or give the firing position area the section (or squad) occupies and the targets it engages, or the sector of fire it covers, and the exact location of friendly troops that may be endangered by the fire of the section. Frequently, the technique used in engaging targets is prescribed. The section leaders (or squad leaders) may be assembled for this purpose, or the platoon leader may go to the section leader (or squad leaders) and give them individual orders. With the section (or squads) widely separated as they may

be in a defensive situation, the platoon leader may send written instructions to the section (or squad) leaders. He is rarely able to issue fire commands orally, especially after firing has begun.

**b. Section Leader.** The machine gun section leader in the weapons platoon is responsible for both the tactical and technical employment of his section. It is his responsibility to pass on to his squads the information received from the platoon leader as to the firing position area, targets to be engaged, sector of fire, friendly troops who may be endangered by fire of the section, and fire adjustment of the section.

**c. Squad Leader.** The squad leader carries out the instructions of the section or platoon leader. He is responsible for fire control and fire discipline within his squad. The squad leader concentrates on the observation and adjustment of fire. Besides assisting in the service of the gun, the number 2 man (ammo man) watches the squad, section, or platoon leader for signals; he cannot do this if he observes the fire. The number 2 man transmits all commands to the gunner or the squad leader. The squad leader is responsible for picking the exact firing position.

## 6602. Sectors of Fire

A sector of fire is a section of terrain designated by specific boundaries and covered by fire by the unit to which it is assigned. Sectors of fire vary in size but are generally limited to the area which can be engaged without moving the tripod, when the machine gun is so mounted.

## 6603. Rates of Fire

The greatest surprise and shock effect is obtained by combining the maximum rate of fire with the simultaneous opening of fire of all guns for at least the first few bursts. Fleeting targets are engaged as soon as possible and with the maximum fire available. The initial delivery of fire using the rapid rate facilitates adjustment of fire. When the rate of fire is not specified, the rapid rate is used. In all cases, unless other-

wise ordered, the first few bursts are at the rapid rate; thereafter, the prescribed rate is used.

## 6604. Adjustment of Fire

Fire is adjusted by observation of strike, observation of tracers, and frequently relaying or checking the aim.

**a. Initial Adjustment of Fire.** The gunner sets his sights with the range to the target, lays on the target, fires an aimed burst, and observes the strike or tracer. When the initial burst is correct, he continues to fire (manipulating if necessary) until the target is covered.

**(1) Firing from the tripod.** When the initial burst is not correctly placed, the gunner determines from the strike or tracer the amount of traverse and search required to place the next burst on the target and manipulates the gun accordingly with the T&E handwheels. He makes large range corrections by resetting the sights and relaying on the target.

**(2) Firing from the bipod.** When the initial burst is not correctly placed, the gunner may either change the elevation and windage on the sights, or he may select a new aiming point to place the next burst on the target. He adjusts body position for small correction in elevation and deflection. He makes larger range corrections by resetting the sights and relaying on the target.

**b. Subsequent Corrections and Adjustments.** Observation and adjustment of fire is the most important element of fire control. It is continuous throughout the action. The gunner is trained to observe and adjust his own fire without command and to check his laying frequently. He is trained to anticipate the action of the enemy after fire is open, and to shift his fire to cover any changes in the formation or location of his target. If the gunner fails to do these things, the squad leader promptly corrects him by announcing or signaling subsequent fire commands. This responsibility to adjust fire continues through the chain of command to the platoon leader. When subsequent fire commands are issued, the gunner makes the required corrections or adjustments and continues to engage the target without further command to fire.



(1) **Firing from the tripod.** When firing the gun on the tripod, subsequent commands are given as corrections in elevation and/or deflection at which the last burst was fired. These corrections are habitually given in mils and are announced or signaled as: ADD, DROP, RIGHT, or LEFT so many mils. Changes in deflection and elevation such as: RIGHT 2; ADD 5, are made with the T&E hand wheels.

(2) **Firing from the bipod.** When firing a machine gun on the bipod, subsequent commands should be given relative to the impact of the previous burst. These corrections should be announced as: ADD, DROP, LEFT, or RIGHT so many meters. The word meters is omitted as it is the standard unit of measure.

### 6605. Fire Commands

Fire commands are the means by which fire control is exercised. Fire commands are the instructions issued to the gun crews that enable them to properly engage the desired targets. There are two types of fire commands—initial and subsequent. Initial fire commands are issued to engage targets and to shift fire to new targets. Subsequent fire commands are issued to adjust fire, change the rate of fire, and cease fire. The following explanation is based on employment of the guns by squad (two machine gun teams). A good fire command is as brief as clarity will permit. It contains all necessary elements given in proper sequence. It is given clearly and at a rate that can be easily understood by the gunners. The gunner repeats each element to ensure understanding. It is most improbable that a complete initial fire command would ever be issued during a fire fight. The leader determines which elements of a fire command are obvious to the gunners and which elements must be given to them. Some targets may necessitate including all elements. Others may be engaged with only the alert, range, and command to fire. For example: FIRE MISSION, SEVEN HUNDRED, FIRE. The procedures outlined are used to accustom machine gunners to issue and execute instructions in a definite, logical sequence. The use of complete fire commands in training makes this sequence second nature for machine gunners, preparing them for fragmentary fire commands in combat.

a. **Initial Fire Commands.** The elements contained in the initial fire command are identical to those utilized for the infantry unit leader. The acronym ADDRAC can be utilized to remember the elements.

**A LERT**  
**D IRECTION (only when not obvious)**  
**D ESCRIPTION (only when not obvious)**  
**R ANGE**  
**A SSIGNMENT/METHOD**  
**(division, manipulation, rate; all only as required)**  
**C ONTROL**

(1) **Alert.** The alert is the first element of the initial fire command. Its purpose is to designate the gun crews and ready them to receive and execute the fire command. **FIRE MISSION** is announced for all targets. When both guns of a squad are to fire, the squad leader announces **FIRE MISSION**. If only one gun is to fire, then **NUMBER ONE, FIRE MISSION** or **NUMBER TWO, FIRE MISSION** is given. When the squad leader desires to alert both guns, but only wants one gun of the squad to fire, he announces **FIRE MISSION, NUMBER ONE** or **FIRE MISSION, NUMBER TWO**.

(2) **Direction.** When the target is not obvious, the gunners must be told to look in a particular direction to see it. Direction is given as **FRONT, RIGHT (LEFT) FRONT, RIGHT (LEFT) FLANK**, etc. An indistinct target may be indicated by the use of a reference point. The selected reference point must be an easily recognizable terrain feature or object which is in or near the target area. When a reference point is used, it is announced as **REFERENCE**. For clarity, the word **TARGET** always precedes the target description when a reference point is used. When the selected reference point is within the target area, the target may be indicated as extending so many mils, meters, or fingers from the reference point. When using this method, the words mils and meters are always implied for bipod-mounted guns. Examples of the use of reference points within the target area are:

**REFERENCE: BUNKER; TARGET: TROOPS EXTENDING RIGHT TWO FIVE, LEFT TWO FIVE; AND REFERENCE: TANK; TARGET: TROOPS EXTENDING SHORT ONE ZERO, OVER TWO ZERO.**

If the selected reference point is not within the target area, a typical command would be:

**REFERENCE: LONE TREE, RIGHT FIVE ZERO; TARGET: MACHINE GUN IN EDGE OF WOODS.**

When a reference point within the target area is used to designate the target, the range announced is that to the reference point. When the reference point is outside the target area, the range to the target is announced. An obscure target may be identified by first designating an obvious feature (reference point) and then leading the gunner, step by step, to the target by naming successive reference points until his attention is directed to the target itself. For example, **REFERENCE: RED ROOFED HOUSE, RIGHT OF HOUSE, HEDGE, CENTER OF HEDGE, GATE, ABOVE GATE; TARGET: MACHINE GUN.**

With a tripod-mounted gun, the interval between the reference point and the target is measured by laying the gun on the reference point and manipulating the designated number of mils to the target. With the gun on the bipod, the gunner must measure this interval in meters or fingers.

In addition to designating targets orally, the following methods may be used, depending on the situation:

(a) *Firing.* Designating an indistinct target by firing a machine gun is a simple, rapid, and accurate method. However, it may cause loss of surprise and premature disclosure of the gun position. The leader designating the target announces the general direction of fire if it is not obvious. He then lays one gun on the target and commands WATCH MY BURSTS. He fires one or more bursts on the target and completes the designation orally; for example, MIDPOINT, RIGHT (LEFT) FLANK or NEAR (FAR) END. He designates midpoint and flanks or ends. The minimum number of bursts necessary will be used. A similar

procedure may be accomplished by firing a rifle from the gun positions. The use of tracer ammunition will facilitate observation of fire.

(b) *Laying the Gun.* Laying the gun on a target is a simple and accurate method and does not sacrifice surprise. To use this method, the leader goes to each gun, lays it on the target, and requires the gunners to check the lay. The gunners open fire simultaneously on command of the leader.

(3) **Description.** A target description is a word or two used to inform the gunner of the nature of his target. The following words are examples of target descriptions: troops (any dismounted enemy personnel); machine gun (any automatic weapon); tank (any armored vehicle); if several targets are in view, the particular target, or part of a target, which is to be engaged may be described as leading truck, right building, far end, halted column, etc. If the target is obvious, no description is necessary.

(4) **Range.** This element follows the target description and is announced in meters. The words range and meters are not used. The range is announced in even digits, hundreds, or thousands. For example: FOUR FIVE ZERO, THREE HUNDRED, ONE HUNDRED, ONE THOUSAND.

(5) **Assignment/Method.** This element is utilized only when specific assignments are required to divide the target, assign class of fire, or to designate a rate of fire.

(a) *Division.* This element is given only when required and is discussed in detail under engagement of targets.

#### NOTE

It is announced as: **NUMBER ONE RIGHT HALF, NUMBER TWO LEFT HALF; or NUMBER ONE RIGHT TWO-THIRDS, NUMBER TWO LEFT TWO-THIRDS; or NUMBER ONE RIGHT TWO-THIRDS, NUMBER TWO LEFT ONE-THIRD.**

(b) *Manipulation.* This element prescribes the class of fire with respect to the gun which is required to effectively engage the target. It is announced as:

**FIXED, TRAVERSE, SEARCH, TRAVERSE AND SEARCH, SWINGING TRAVERSE, or FREE GUN.** This is only given when the required manipulation is not obvious.

(c) *Rate.* The greatest surprise and effect is obtained by a pair of guns opening fire simultaneously at the rapid rate of fire. Regardless of the rate of fire announced, gunners always open and adjust their fire at the rapid rate. They use the prescribed rate thereafter. The rate of fire to be used may be sustained, rapid, or cyclic. The factors influencing the selection of the rate of fire are the size and nature of the target and ammunition supply.

The sustained rate of fire is measured in rounds per minute and is the rate at which a machine gun may be fired indefinitely without damage from overheating. The sustained rate is directed by announcing **SUSTAINED**. The rapid rate of fire is measured in rounds per minute and is the rate at which a machine gun may be fired for a limited period of time without danger of damage from overheating. The rapid rate permits a high volume of fire to be delivered for a fixed and relatively short period of time. Gunners will automatically employ the rapid rate unless another rate is announced.

(6) **Control.** For immediate engagement of the target, the command **FIRE** or the arm-and-hand signal to fire is given without pause. It is often of great importance that machine gun fire be withheld for surprise and maximum effect, and that both guns of a pair open fire at the same time. To ensure this, the leader may preface the command or signal to commence firing with the words **AT MY COMMAND** or **ON MY SIGNAL**. When the gunners are ready to engage the target, they report **UP** to the team leaders who signal **READY** to the squad leader, or they may announce **NUMBER ONE (TWO) UP**. The squad leader then gives the command or signal to fire.

### NOTE

Fire commands should be as brief and concise as possible; therefore, obvious information is omitted when possible. All initial fire commands must contain **ALERT, RANGE, and COMMAND**. The remaining elements may be omitted only if they are obvious.

b. **Repeating and Correcting Initial Fire Commands.** If the gunner fails to understand any element of the fire command, he may request a repetition of the element by announcing the misunderstood element with a rising inflection in his voice to denote a question. When repeating any portion of the fire command, the leader will preface it with the words, **THE COMMAND WAS . . .** In fire commands, an incorrect portion is corrected by announcing **CORRECTION** and then giving the correct command. For example, to correct a wrong range command of 500 meters to 600 meters, the command would be **CORRECTION, SIX HUNDRED**.

c. **Subsequent Fire Commands.** When adjusting fire, the deflection correction must always be given first.

**CEASE FIRE** is announced when the leader wishes to interrupt fire for any reason. It indicates that the gun crew will remain on the alert and that additional instructions will follow. Firing is renewed by announcing a subsequent fire command or by announcing a new fire command. Firing is resumed with the same data by using the command **FIRE**.

To allow the gun crew to relax between fire missions, the termination of the alert is announced. It is **CEASE FIRING, END OF MISSION**.

---

## Section 7

### Methods of Target Engagement

---

#### 6701. Distribution of Fire

Fire, to be effective, is distributed over the entire target. Improper distribution results in gaps between beaten zones and allows a part of the enemy to escape or to use his weapons without effective opposition.

a. **Factors Affecting Distribution.** There is no fixed rule as to the maximum width of a target that may profitably be engaged by a single machine gun, although it is preferable that targets be 100 mils or less in width in the case of the heavy gun on the tripod, and 50 mils or less in width in the case of the medium gun on the tripod or bipod mounts. When possible, targets exceeding the above widths are not

assigned to a single gun. This is because the traversing screw on the elevating mechanism of the tripod limits the amount of traverse that can be secured without readjusting the traversing slide lock lever. Major shifts in the gunner's body position are required when firing the gun on the bipod mount. Also, wider targets require appreciable time to traverse and a continuous volume of fire is not placed over the entire target. Finally, the amount of ammunition required for a wider target is excessive for a single gun.

**b. Machine Gun Fire Unit.** A squad of guns is the machine gun fire unit. Whenever practical, at least two guns are assigned the same mission, although occasions may arise when single guns may profitably be employed. The assignment of a squad of guns to a single mission ensures continuous fire should either gun be put out of action, provides a greater volume of fire on the target, and reduces the time required to cover the target.

**c. Manipulation.** Manipulation is the process of moving the machine gun between bursts so that fire is distributed over a wide, deep, or oblique target.

**(1) Bipod.** Manipulation is done by selecting a series of aiming points along the path of the target and firing a succession of aimed bursts until the assigned portion of the target is covered. The gunner observes the width and length of the beaten zone of the initial burst and each succeeding aiming point is selected far enough from the preceding burst to allow an overlap of the beaten zones as the target is covered.

**(2) Tripod.** Traversing fire is accomplished in 2-mil increments, firing after each manipulation, to ensure overlap of the beaten zones. On level or uniformly sloping ground, searching fire is usually accomplished in 2-mil increments, firing after each manipulation; however, when the ground is irregular, the beaten zone is observed on the ground to determine the amount of search to apply between bursts to ensure overlap of the beaten zones.

## 6702. Point Targets

Targets having a width or depth no greater than the beaten zone for the ground on which they are located

are considered as point targets and are engaged by fixed fire. The command for this type of fire is **FIXED**. Gun crews are trained to follow any movement or change in formation by the enemy after the initial burst of fire.

## 6703. Wide Targets

**a. Using a Squad of Guns.** When a pair of guns engage frontal targets which are 100 mils or less in width for the heavy gun and 50 mils or less in width for the medium gun, and are also less than the length of the beaten zone in depth, the normal traversing method is used. Each gun delivers the initial burst of fire 2 mils outside its corresponding flank of the target; its fire is adjusted on that point, and it is traversed across the target to a point 2 mils outside the other flank. Each gun is traversed back and forth between these two points, covering the entire target until **CEASE FIRING** is given (see figure 6-13). The command for this type of fire is **TRAVERSE**. An example of a fire command used to engage the type target just described is as follows:

**FIRE MISSION**

**RIGHT FRONT**

**TROOPS**

**EXTENDING FROM DEAD**

**TREE RIGHT TO CLEARING SEVEN**

**FIVE ZERO TRAVERSE AT MY SIGNAL**

(The signal to fire is given after the gunner announces **UP**.)

When the target measures more than 100 mils for the heavy guns and 50 mils for the medium guns in width, and is less than the length of the beaten zone in depth, the leader assigns half (or any other portion) of the target to one gun and the remaining half (portion) to the other gun. One portion may be much less than the other for purposes of increasing the density of fire on the smaller portion. In either case, each gun fires the initial burst 2 mils outside its respective flank and covers its portion as described in subparagraph (1) and as shown in

figure 6-14. The command would be, for example, **NUMBER 1, RIGHT HALF; NUMBER 2, LEFT HALF; TRAVERSE.**

Another example for a fire command used to engage this type of target is as follows:

**FIRE MISSION**

**RIGHT FRONT**

**TROOPS, EXTENDING**

**FROM DEAD TREE RIGHT TO CLEARING**

**EIGHT HUNDRED**

**NUMBER 1, RIGHT ONE-THIRD; NUMBER 2, LEFT TWO-THIRDS**

**TRAVERSE AT MY COMMAND**

(The command to fire is given when both gunners announce UP.)

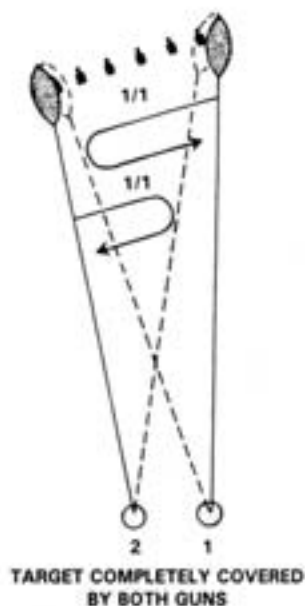

**Figure 6-13. Traversing Method, Using a Squad of Guns, Both Flanks Visible to the Gunners.**

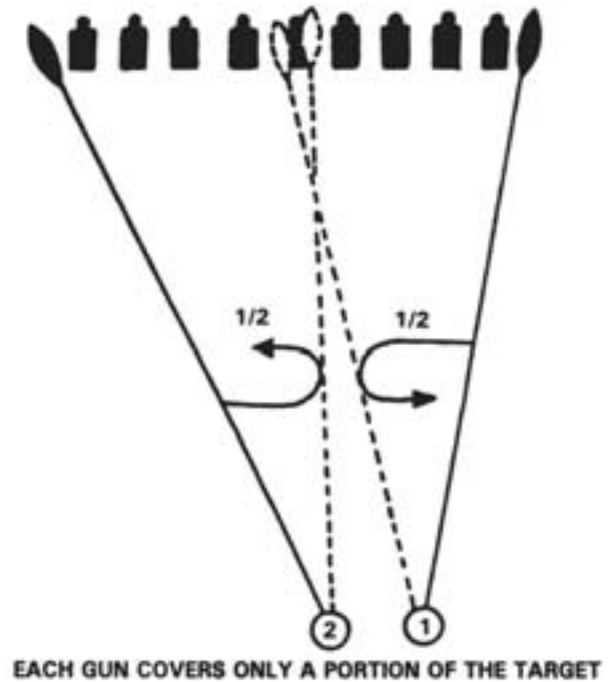

**Figure 6-14. Traversing Method, Using a Squad of Guns. Target for Heavy Machine Gun More than 100 Mils in Width (Medium Machine Gun More than 50 Mils).**

**b. By Section (Minus) Using Four Machine Guns.** Each squad (pair of guns) engages the entire target as prescribed except when engaging extremely wide targets (see figure 6-15). In engaging extremely wide targets, each squad may be assigned one-half (or any other portion) of the target. Each portion is assigned and designated separately as an individual target. Each squad covers its assigned portion of the target by either of the methods previously described, depending upon the width of the target.

**c. Engaging Wide Targets, Flanks of Which are Not Readily Identifiable by the Gunner.** When the flanks of a target are not easily identifiable to the gunner, the target may be identified by firing a gun or rifle, laying the guns, or by using a reference point which is visible to the gunner and in the vicinity of the target. The first two methods are simple and accurate, and once the flanks of the target are identified, the target is engaged in the same manner as described for a squad of guns. The reference point method of

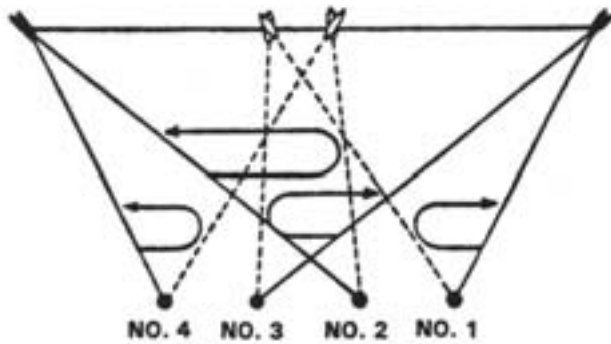

**Figure 6-15. Traversing Method Using a Section (Minus) of Guns. Target More Than 100 Mils in Width (Each Squad of Guns Covers the Entire Target).**

designating an indistinct target may also be used as described below.

When the selected reference point is outside the target area, the gunner may be directed to the target by announcing the interval to the right or left (over or short) between the reference point and the target. With either the medium or the heavy gun on a tripod mount, the gunner measures the interval between the reference point and the flank of the target by laying on the reference point, with the sights set at the range to the target, and shifting the gun the designated number of mils. The interval over or short between the reference point and the target must be measured with the gun in mils (using computed search method) or by estimating the interval in meters.

With a bipod mount, the gunner lays directly on the designated flank of the target by first measuring the interval between the reference point and that flank of the target (in sights or fingers) and, if necessary, by estimating the interval over or short between the reference point and the target (in meters).

When each gun (on bipod or tripod mount) is laid on the right or left flank respectively, its fire is adjusted on the flank, and the target is engaged in the same manner as described for either the medium or heavy gun on a tripod mount.

The flanks of an indistinct target may be identified to the gunner as extending so many mils (or so many sights, fingers, or yards with the medium gun on bipod mount) from a reference point within the target area. In this method, each gun is laid initially on the announced reference point (initial aiming point), its fire adjusted on this point, and traversed to the right or left respectively, the prescribed distance to its corresponding flank and then back across the target the total prescribed distance to the other flank, firing after each manipulation (see figure 6-16). Each gun is traversed back and forth across the entire target until cease firing is given. The lay of each gun is checked as it passes the reference point (initial aiming point). Examples of fire commands that may be used when the flanks of the target are not easily identifiable to the gunner are as follows:

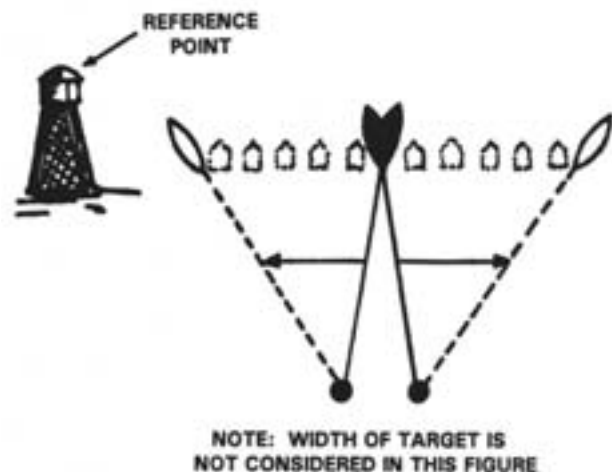

**Figure 6-16. Traversing Method, Using a Squad of Guns; Both Flanks Invisible to the Gunners.**

The leader designates the target by firing one gun:

**FIRE MISSION**

**LEFT FLANK**

**WATCH MY BURSTS** (or **TRACERS**)

(Lays and fires gun at left flank.) **LEFT FLANK**

(Lays and fires gun at right flank.) **RIGHT FLANK**

**TROOPS**

**NINE HUNDRED**

**TRAVERSE AT MY COMMAND**

**FIRE** (Given after gunners announce **UP**.)

The leader designates the target by using a reference point outside the target area (machine guns are on tripod mounts):

**FIRE MISSION**

**RIGHT FRONT**

**REFERENCE: DEAD TREE**

**RIGHT SIX ZERO MILS; DROP THREE FIVE ZERO METERS**

(or drop so many mils using computed search)

**TARGET: TROOPS EXTENDING**

**RIGHT FIVE ZERO MILS**

**SIX HUNDRED**

**TRAVERSE AT MY COMMAND**

**FIRE** (Given after gunners announce **UP**.)

The leader designates the target by using a reference point outside the target area (machine gun on tripod mounts):

**FIRE MISSION**

**RIGHT FRONT**

**REFERENCE: DEAD TREE**

**RIGHT ONE SIGHT (FINGER); DROP THREE FIVE ZERO**

**METERS**

**TARGET: TROOPS EXTENDING, RIGHT ONE SIGHT (FINGER)**

**SIX HUNDRED**

**TRAVERSE AT MY COMMAND**

**FIRE** (Given after gunners announce **UP**.)

The leader designates the target by using a reference point within the target area (machine gun on tripod mounts):

**FIRE MISSION**

**FRONT**

**REFERENCE: LONE TREE**

**TARGET: TROOPS EXTENDING**

**RIGHT TWO ZERO MILS; LEFT, THREE ZERO MILS SEVEN HUNDRED**

**TRAVERSE AT MY COMMAND**

**FIRE** (Given after gunners announce **UP**.)

**d. Using a Single Gun.** The single gun is laid just outside either flank (or on a reference point with the target area), its fire adjusted on the flank (or reference point), and traversed back and forth, covering the entire target until cease firing is given. In other words, it engages the target in the same manner as either gun of a squad as previously described. The leader may designate the flank on which he desires fire to be placed initially. An example of a fire command for a wide target which is to be engaged by a single medium machine gun on a bipod mount is as follows:

**FIRE MISSION**

**FRONT**

**TROOPS EXTENDING FROM DEAD TREE**

**RIGHT ONE SIGHT (OR FINGER)**

**FIVE HUNDRED**

**TRAVERSE AT MY COMMAND** (The signal to fire is given after the gunner announces **UP**.)

**e. Swinging Traverse.** The swinging traverse method used against massed or rapidly moving targets at short ranges is described earlier in this chapter. An example of a fire command for a swinging traverse is as follows:

**FIRE MISSION**

**LEFT FRONT**

**TRUCKS**

**SWINGING TRAVERSE**

**FIRE**

## 6704. DEEP TARGETS

### a. Using a Pair of Guns

(1) **Stationary deep target, ends visible to gunner.** See figure 6-17. Deep targets which are stationary or have limited mobility require only searching fire to cover them effectively. When the ends are visible to the gunners, the number 1 gun is laid initially on the near end of the target; and the number 2 gun is laid initially on the far end. The fires on each gun are adjusted on these initial aiming points and searched to the far and near ends of the target, respectively. After searching the full extent of the target, the direction of search of each gun is reversed, and both guns are searched up and down between these two limits, covering the entire target until cease firing is given. In determining the sight setting to be placed on the guns, the depth of the target is considered when firing a squad of guns. If the depth of the target is estimated to be 200 meters or less, the range announced for both

guns is that to the midpoint of the target, thus taking advantage of the length of the beaten zones to ensure fire on the target with the initial bursts.

If the target extends over 200 meters in depth, the range to the near end is announced for number 1 gun, and that to the far end for the number 2 gun. The command for this type of fire is SEARCH. When the target is 200 meters or less in depth and is to be engaged by a squad of guns (or by a single gun), the fire command may be as follows:

#### FIRE MISSION

#### FRONT

#### HALTED COLUMN

#### SEVEN HUNDRED (midrange)

#### SEARCH

#### AT MY COMMAND

#### FIRE (Given after gunner announces UP.)

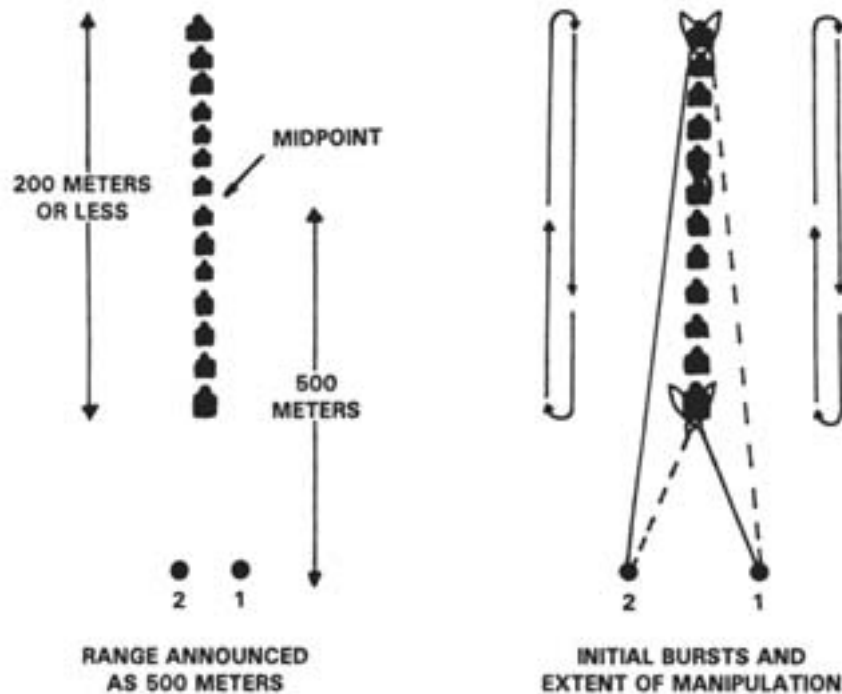

Figure 6-17. Engaging a Deep Enfilade Target With a Pair of Guns, Ends Visible to Gunners.



When the target is over 200 meters in depth and is to be engaged by a squad of guns, the fire command may be as follows:

### **FIRE MISSION**

#### **LEFT FRONT**

#### **TROOPS ALONG RIGHT EDGE OF WOODS**

#### **NUMBER 1, SIX HUNDRED; NUMBER 2, NINE HUNDRED**

#### **SEARCH AT MY COMMAND**

**FIRE** (Given after gunners announce **UP**.)

**(2) Stationary deep target, ends invisible to gunner.** If the ends of the target are not visible to the gunner, the target may be identified by firing a gun or rifle (tracer), laying the guns, or by using a reference point which is visible to the gunner and in the vicinity of the target. The first method (firing the gun) is the quickest and simplest method of designating an indistinct target. Once the limits of the target are identified, the target is engaged in the same manner as described in subparagraph (1). When designation by tracer (firing a gun or rifle) is likely to disclose the gun position, or otherwise destroy the element of surprise, the reference point method may be used.

When the selected reference point is outside the target area, the gunner may be directed to the target by announcing the interval over or short (right or left) between the reference point and the target.

With either the medium or the heavy gun on a tripod mount, the gunner measures the interval right or left between the reference point and the target by laying on the reference point, with the sights set at the range to the midpoint of the target and shifting the gun the designated number of mils. The interval over or short between the reference point and the end of the target may be measured with the gun in mils (using computed search method) or by estimating the interval in meters.

With the bipod mount, the gunner lays directly on the designated end of the target by first estimating the interval over or short between the reference point and the end of the target (in meters) and, if necessary, by measuring the interval right or left between the reference point and the target (in sights or fingers).

When the number 1 and number 2 guns (on the bipod or the tripod mount) are laid on the near or far end, respectively, their fires are adjusted individually on those ends, and the target is engaged in the same manner as described for either the medium or heavy gun on a tripod mount in subparagraph (1).

The limits of an indistinct deep target are identified to the gunners as extending so many meters (or mils) from a reference point within the target area. In this method, both guns are laid initially on the announced reference point (initial aiming point), with their sights set at the range to the reference point, and their fire adjusted on this point. The number 1 gun is searched down, firing after each manipulation, until it has reached the near end of the target as designated in meters (or mils); the number 2 gun is searched up, firing after each manipulation, until it has reached the far end of the target. When each gun has reached the near and far end, respectively, the direction of search is reversed, and both guns are searched up and down between these two limits, covering the entire target until cease firing is given.

**(3) Computed search method.** When it is desired to describe the depth of a target in mils, the leader computes the amount of search from the reference point in mils by the following method:

- Determine the ranges to the near or far ends of the target.
- From the firing tables, find the required angles of elevation (AE) in mils for both ranges and determine the difference.
- The difference between the angle of elevation is the amount of search required on level ground with the gun and target at the same elevation. (If the fire is plunging, the amount of search is increased.) If the computed amount of search is an odd number of mils, it is increased to an even total so that the search can be made in 2-mil increments.

For example, (computed from firing tables for 7.62 ball ammunition, appendix A) a deep target has been sighted, the ends of which are not visible to the gunners. A suitable reference point within the target at 1,100 meters distance is visible. The depth of the target is estimated as 200 meters and the reference point appears to be midway between the ends. Thus, the

range to the near end is 1,000 meters and to the far end is 1,200 meters. The angle of elevation for a range of 1,000 meters is 16.2 mils; for 1,200 meters, 24.1 mils; the difference being 8 mils. This target extends 4 mils over and 4 mils short of the reference point. Searching in 2-mil increments, the gunners cover the target by searching 4 mils over and 4 mils short of the reference point. This target is described to the gunners as follows:

**TARGET,  
TROOPS EXTENDING  
OVER 4 MILS; SHORT 4 MILS.**

When the ends of the target are not visible to the gunners (using a reference point within the target area), the fire command would be as follows:

**FIRE MISSION  
RIGHT FRONT  
REFERENCE: LONE BUSH  
TARGET: TROOPS EXTENDING SHORT TWO  
MILS, OVER FOUR MILS  
SIX HUNDRED (range to reference point)  
SEARCH  
AT MY COMMAND  
FIRE (Given after gunners announce UP.)**

The leader designates the target by using a reference point outside the target area (machine guns on tripod mounts). An example of this type fire command is as follows:

**FIRE MISSION  
LEFT FRONT  
REFERENCE: DEAD TREE  
RIGHT THREE ZERO MILS; ADD SIX MILS  
TARGET: TROOPS EXTENDING OVER  
TWO MILS  
NINE HUNDRED  
SEARCH  
AT MY COMMAND  
FIRE (Given after gunners announce UP.)**

**(4) Target moving away from the gun position.** When the target is moving rapidly away from the guns, both guns are laid on the far end with the range to that point and searched down.

**(5) Target moving toward the gun position.** If the target is moving rapidly toward the gun positions, both guns are laid on the near end with the range to that point and searched up. The element of the fire command for covering a rapidly approaching or receding target is **BOTH GUNS: NEAR (FAR) END; SEARCH.**

**b. By Section (Minus) Using Four Machine Guns.** A section (minus) of four guns uses the same method as a pair of guns, each squad (pair of guns) engaging the target as if it were acting alone. In case it becomes necessary to switch the fire of one squad of guns to another target, the original target is still covered by the remaining squad.

**c. Subdivision of a Deep Target.** A deep target need never be subdivided since the elevating mechanism of either the medium or heavy gun allows enough search to cover any deep target within the maximum usable range for direct laying (2,000 meters).

**d. Using a Single Gun.** The single gun is laid on the near end of the target with a range to the midpoint, its fire adjusted on the near end, and then searched up and down covering the entire target. When a reference point within the target area is used, the single gun is laid on the announced reference point with the range to the reference point, its fire adjusted on this point, searched down to the near end, and then searched up and down covering the entire target, until cease firing is given.

## 6705. Oblique Targets

Using a squad of guns, oblique targets are engaged with combined traversing and searching fire (see figure 6-18). The gunner employs enough search while firing to keep the center of impact of the beaten zone on the target. The range announced in the initial fire command is determined in the same manner as for a deep target.

**(1) Flanks invisible.** If the flanks of the target are not easily identifiable by the gunner, the target may be designated in the same manner as described earlier in this chapter. A reference point within the target area; however, is not used as an initial aiming point because of the difficulty in describing the obliquity of the target.

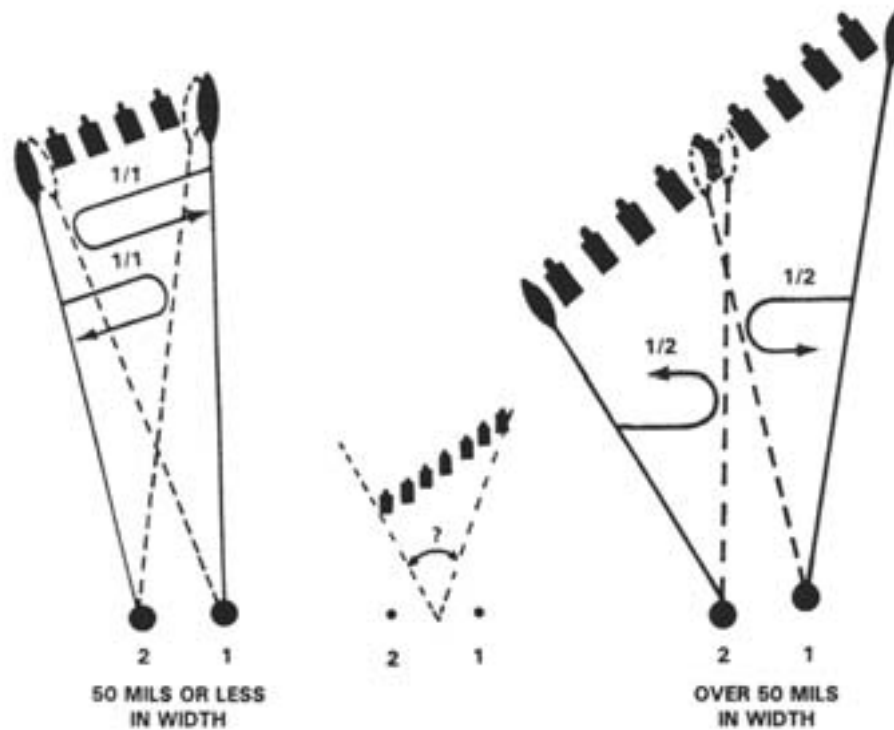

Figure 6-18. Squad of Guns Engaging a Shallow or Oblique Target.

(2) **By section (minus) using four guns.** A section (minus) of four guns uses the same method as a squad of guns, each squad engaging the target as if it were acting alone. In case it becomes necessary to switch the fire of one squad of guns to another target, the original target is still covered by the remaining squad.

(3) **Using a single gun.** The single gun is laid initially on the near flank, and then traversed and searched back and forth, covering the entire target until cease firing is given.

b. **Fire Commands.** Examples of fire commands used for oblique targets are:

When the target is not wide enough to necessitate subdivision, is 200 meters or less in depth, and is to be engaged by a squad of guns (or by a single gun):

**FIRE MISSION  
RIGHT FRONT**

**TROOPS EXTENDING FROM BLACK  
STUMP - RIGHT TO LONE PINE  
SEVEN HUNDRED (midrange)  
TRAVERSE AND SEARCH  
AT MY SIGNAL**

(Signal to fire given after gunners announce UP.)

When the target measures 100 mils or less in width, is 200 meters or less in depth, and is to be engaged by a section (minus) of four guns:

**SQUAD 1, SQUAD 2  
FIRE MISSION  
FRONT TROOPS TO THE RIGHT OF RED BANK  
SEVEN HUNDRED (midrange)  
TRAVERSE AND SEARCH  
AT MY SIGNAL**

(Signal to fire given after gunners announce UP.)

When the target is wide enough to necessitate subdividing, is over 200 meters in depth, and is to be engaged by a squad of guns or by a section (minus) of four guns:

#### FIRE MISSION

#### FRONT

#### TROOPS EXTENDING FROM TRUCK - RIGHT TO BRIDGE

NUMBER 1 (and 3 if section [minus] of four guns is engaging the target),

#### SEVEN HUNDRED

NUMBER 2 (and 4 if section [minus] of four guns is engaging the target),

#### ONE THOUSAND

NUMBER 1 (and 3),

RIGHT HALF NUMBER 2 (and 4),

#### LEFT HALF TRAVERSE AND SEARCH

#### AT MY SIGNAL

(Signal to fire given after gunners announce UP.)

### 6706. Area Targets

Targets which cannot be covered by either traversing fire or searching fire alone, or by combined traversing and searching fire (as in the case of oblique targets) are called area targets. The area which can be covered effectively by a squad of guns or by a section (minus) of four guns is small because of the time and ammunition required for this type.

#### a. Using a Squad of Guns

(1) **Flanks visible.** When the flanks of the target are visible to the gunners, the guns are laid just outside their corresponding flanks. Each gun then fires traversing fire across its assigned portion of the target, changes elevation the total amount prescribed in the initial fire command, traverses back to the flank from which traversing fire was started, and ceases firing. A typical manipulation element of the fire command would be **TRAVERSE, SEARCH UP 4 (MILS)** or **SEARCH UP 100 (METERS)**. Further firing over the area is on the leader's orders.

(2) **Flanks invisible.** When the flanks of the target are invisible to the gunners, the leader indicates their location and the point at which each gun fires its initial burst, either by firing one gun, by laying both guns, by firing a gun or rifle, or by use of a reference point. When the location of the flanks or the reference point (which may be the initial aiming point) have been announced, the procedure to cover the area is the same as when the flanks are visible.

b. **By Section (Minus) Using Four Guns.** A section (minus) of four guns uses the same method as a squad of guns, with each squad of guns within the section (minus) engaging the target as if it were acting alone.

c. **Using a Single Gun.** The single gun uses the same method of engaging an area target as described previously for either gun of a squad.

d. **Fire Commands.** Figure 6-19 is a sample fire command. Examples of fire commands used for area targets are:

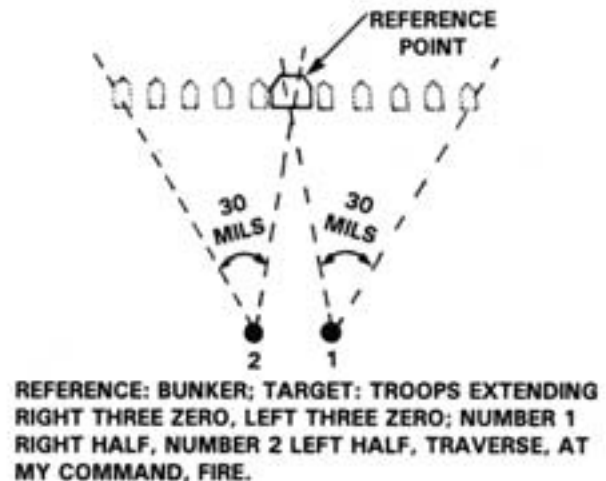

Figure 6-19. Sample Fire Command.

When there is no reference point along the near or far edge of the target, the leader must lay the guns for the initial burst and complete the fire command orally.

**FIRE MISSION****FRONT**

(Lays each gun on the right and left flank, respectively)

**AREA: TROOPS IN GREEN PATCH**

**NINE HUNDRED**

**TRAVERSE**

**SEARCH UP THREE MILS**

(or up so many meters)

**AT MY COMMAND**

**FIRE** (Given after gunners announce UP.)

Using a reference point at the far edge of the target:

**FIRE MISSION****FRONT**

**REFERENCE: BLACK STUMP**

**TARGET: TROOPS IN AREA**

**EXTENDING RIGHT TWO ZERO MILS;**

**LEFT THREE ZERO MILS**

**EIGHT HUNDRED** (range to reference point)

**TRAVERSE: SEARCH DOWN THREE MILS** (or down so many meters)

**AT MY COMMAND**

**FIRE** (Given after gunners announce UP.)

**6707. Moving Targets**

The engagement of moving targets with the MK-19 poses special problems because of the slow velocity of the round compared to most machine guns. In general, leads must be increased by four times when using the MK-19 as opposed to the M2 .50 cal. For additional information on tracking and leading moving targets see paragraph 41113 in chapter 4.

The fundamentals used to hit moving targets are the same as those needed to hit stationary targets. However, the procedures to engage moving targets vary as the angle, speed, and range of the target vary. Targets moving directly at the gunner are engaged the same as a stationary target; there is no change in the application of the fundamentals. But fast-moving targets at varying ranges and angles do require changes in the application of steady position and aiming. For aerial target engagement, see section 14 in this chapter.

**a. Leads.** To hit a moving target, the gun must be aimed ahead of the target a sufficient distance to cause the bullet and target to arrive at the same time at the same point. This distance is measured in target lengths. One target length as seen by the gunner is one lead. Leads are measured from the center of mass. The sample lead table in Figure 6-20 gives the amount of lead needed to hit a moving target moving at right angles to the gunner at speed and ranges indicated. The gunner makes adjustments as conditions change. If target speed is 7 1/2 miles per hour, the amount of lead is half that shown on the table; at 30 miles per hour, double that shown. The angle the target moves also changes the lead. If the target is moving on an oblique angle, only half the lead is required. For a target moving directly at the gunner, the aiming point is below the center base of the target depending on range and slope of the ground. For a target moving directly away from a gunner, the aiming point is above the center base of the target (see figure 6-21). Too much lead is better than too little because the target moves into the beaten zone, and observation of the strike of the rounds is easier in relation to the target.

SPEED IN MPH	RANGE OF TARGET		
	300 M	500 M	900 M
15	½ target length	1 target length	2 target lengths

Figure 6-20. Vehicle Lead Table.

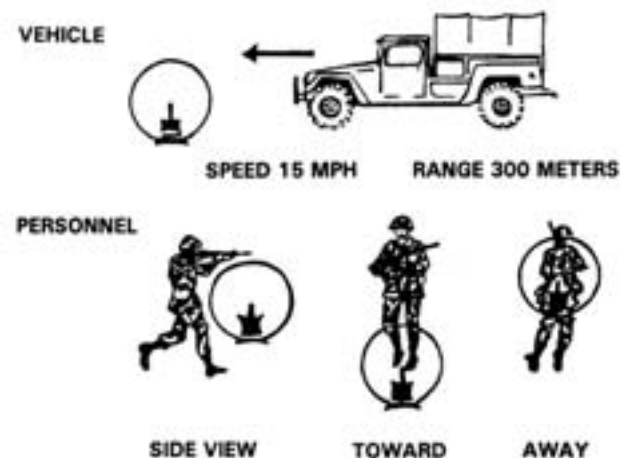

Figure 6-21. Moving Target Aiming Points.

## NOTE

An individual with a combat load can run as fast as 8 miles per hour for short periods on the battlefield.

**b. Tracking Techniques.** The gunner aims at a point ahead of the target equal to the estimated number of leads, maintains this lead by tracking the target (manipulates the weapon at the same angular speed as that of the target), and then fires. Tracking puts the gunner in position for a second burst if the first one misses.

**c. Trapping Techniques.** The gunner establishes an aiming point forward of the target and along the target path. He presses the trigger as the target reaches the appropriate point in regard to lead.

**d. Bipod Techniques.** For targets moving directly away or at the gunner using a bipod, the same procedures are used. From a prone position, the gunner may be required to adjust his position quickly depending on range, angle, and speed of the target.

**(1) Steady position.** If appropriate lead cannot be achieved by shifting your shoulders right or left (traverse) or by moving your elbows closer or farther apart (search), redistribute your weight to your elbows and toes and raise your body off the ground. Using your toes, shift your body right or left in the opposite direction of the target and pivot on your elbows until you are well ahead of the target. Rapidly assume a steady position, obtain the sight picture, lead and engage the target. Trapping is the preferred technique. In order to apply this method, the bipod legs must move freely. When firing from a fighting position, you must be flexible enough to track any target in your sector. If lead cannot be achieved, slide the bipod legs in the appropriate direction (left or right) ahead of the target and continue as in the prone position. Trapping is still the preferred technique. If the terrain does not permit sliding the weapon left or right, lift the bipod legs off the ground and place them where you can aim ahead of the target, reestablish a steady position, and continue as before.

**(2) Aim.** You must determine angle, speed, and range quickly; acquire the appropriate lead; and engage the target. Align the front sight post in the proper relationship to lead the target. For targets moving directly away, place the front sight post above center of mass. For targets moving directly at you, align the front sight post below center of mass. For all other targets, align the front sight post with center base of the target with the appropriate lead.

**(3) Breath control.** There are no changes except that you must hold your breath quickly because of the fleeting nature of moving targets.

**(4) Trigger control.** There is no change in the application of this fundamental.

---

## Section 8 Overhead Fires

---

Overhead fire is fire delivered over the heads of friendly troops. A machine gun on a tripod is capable of delivering this type of fire because of the small and uniform dispersion of the cone of fire. In the attack, the use of overhead fire permits the machine gun to support the advance of rifle units.

## NOTE

Overhead fire is not delivered when the gun is mounted on the bipod, unless the vertical interval of the troops below the gun target line is such as to make safety obvious.

The center of the cone of fire must clear the heads of the friendly troops by a prescribed distance. See figure 6-22. This distance, known as minimum clearance, is found by adding together the following elements:

- The height of a man, standing, taken as 1.8 meters.
- Half the vertical dimension of the 100 percent cone of fire at the range to the troops.
- A margin of safety equal to the vertical distance which extends a 5-mil angle at the gun or 3 meters, whichever is greater.

- An additional allowance to compensate for a 15-percent error in range determination.

To obtain this minimum clearance, the gun is elevated so that the center of the cone of fire is raised from the feet of the friendly troops, to minimum clearance above their heads. The amount of the elevation change to give this minimum clearance is known as the safety angle and is the difference between the angle of elevation to hit the troops and the angle of elevation for troop safety.

### 6801. Rules

**a. Corresponding Range on Level or Uniformly Sloping Ground.** When the gun is fired from the tripod with the required safety angle, the center of impact determines the shortest range at which fire can be delivered over the heads of friendly troops. The range from the gun to the point of strike is called the **corresponding range**. When the ground is level or uniformly sloping between the gun and the target, the corresponding range for the safety angle used is obtained by converting the angle of elevation for troop safety, which is expressed in mils, into range. For example, with the M240G, the angle of elevation for troop safety for troops at a range of 600 meters, with 7.62 ball ammunition, is 23.2 mils (see appendix A, firing tables for 7.62 ball ammunition, table II). In table II (firing table for 7.62 ball ammunition), the range for 23.2 mils is 1,175 meters (even figure to the nearest 25 above the exact figure of 1,162 meters), which is the corresponding range when troops are 600 meters in front of the gun. Thus, no target at a closer range than 1,175 meters can be engaged over level or

uniformly sloping ground when the troops are 600 meters from the gun. The same data can be determined for the M2 machine gun by using table II of appendix B.

**b. Uneven Terrain.** Level or uniformly sloping ground between the gun and target will seldom be found in the field. This prevents the use of standard overhead firing tables in all but a few cases. The problem presented to the gunner or leader planning the fires of guns is the determination of the exact point on the ground to which it is safe for friendly troops to advance without being hit by friendly overhead fire. The exact point on the ground where the lowest bullet hits in any given burst depends on the terrain, the gun position, and the target location. This exact point is impossible to practically calculate because of the infinite number of combinations possible. So, in order to fire over the heads of friendly troops in these instances, calculations must be based on other criteria. In figure 6-23 a line is shown that extends from the gun position to a point lower than the target by one half of the vertical cone height and the height of a standing man. A man could safely stand anywhere on or below the line between points "A" and "B." Point "A" is the point where the man's head touches the line of sight and point "B" is the point underneath the target. If a safety distance is added by drawing the line to point "C," as shown in figure 6-24, clearance is provided above the troop's heads even if they are standing directly under the target. Safety can be guaranteed at any point on or below that line regardless of the terrain profile. The line between "A" and "C" in figure 6-24 is the safety line. The line angle between the line of sight and the safety line is the safety angle. The

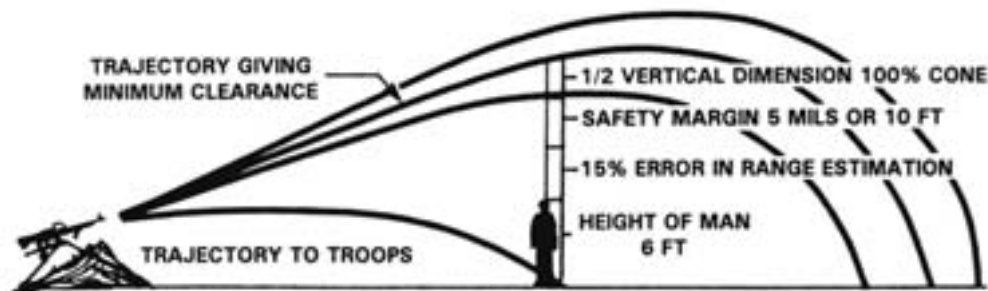

Figure 6-22. Components of Minimum Clearance.

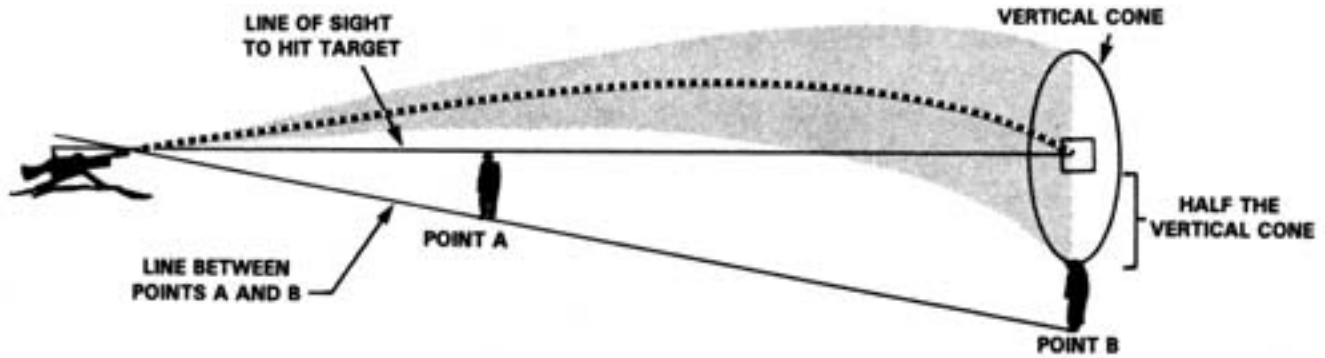

Figure 6-23. Theory Behind the Gunner's and Leader's Rule.

point where the line intersects the terrain is the safety limit. When friendly troops reach the safety limit they begin to rise above the safety line because the terrain slopes upward toward the target.

The gunner's and leader's rules allow the determination of the safety limit by setting the safety angle on the gun and looking across the gun's sights. The safety limit is determined by the intersection of the new line of aim and the ground. When the feet of the friendly troops reach this point the fire must be lifted or shifted.

(1) **Gunner's rule.** The gunner's rule is used to determine the safety limit when the range to the target is 850 meters or less and friendly troops are at least 350 meters in front of the gun position (see figure 6-25). The gunner applies this rule unless the safety limit has been determined and announced by the platoon or section leader. The rule is as follows:

- Lay the gun on the target with the sights set to hit the target. The range to target must be determined with the most accurate means available.

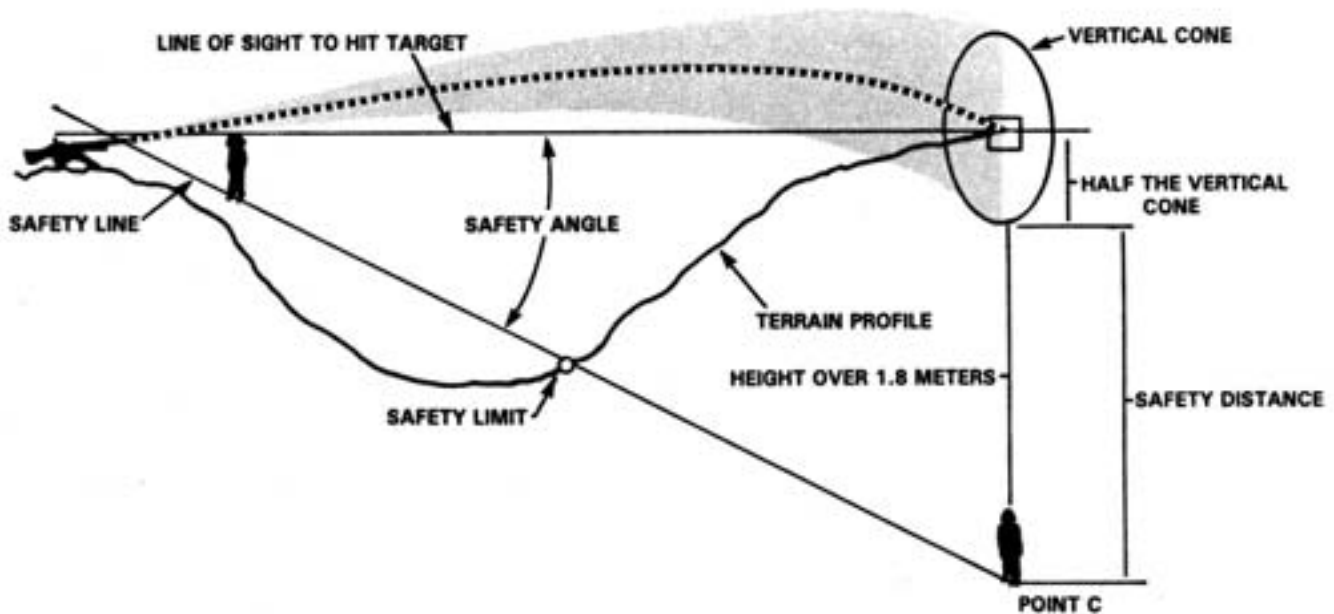

Figure 6-24. Application of the Gunner's and Leader's Rules.



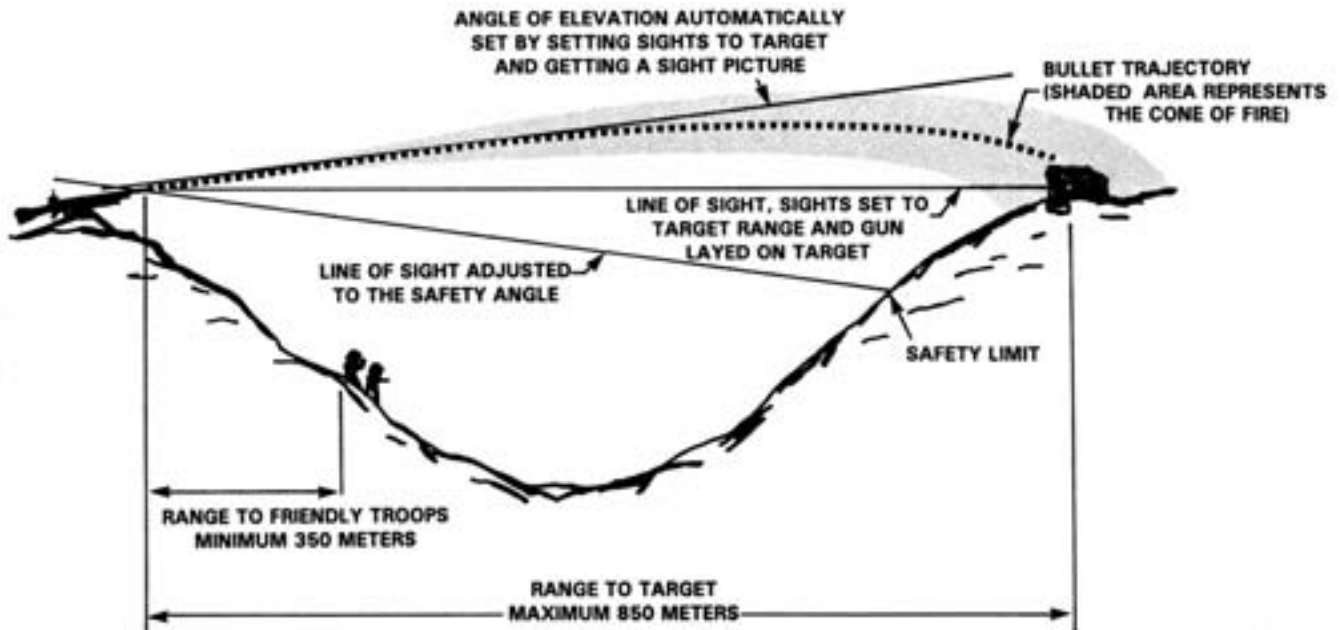

Figure 6-25. Gunner's Rule.

- Without disturbing the lay of the gun, set the line of aim. For the M240G, set the sight on 1,500 meters. For the M2 .50 cal, set the sight on 1,600 meters.
- Look through the sights and note the point where this new line of aim strikes the ground. This point is the safety limit. When the feet of the friendly troops pass this point, overhead fire must be ceased or shifted. It is not safe to continue firing when friendly troops have passed this point.
- Gunners report **SAFE** (friendly troops are not past the safety limit) or **NOT CLEAR** (friendly troops are past the safety limit) to indicate whether or not it is safe to fire. The gunner will report the location of the safety limit to the squad leader.
- Relay the gun back on to the target ensuring that the proper range to the target has been reset on the sights.

**(2) Leader's Rule.** The leader may want to orient his gunners on the safety limit using an identifiable terrain feature. The leader's rule is used to determine if

that terrain feature selected by the leader can be used as the safety limit. The rule is as follows:

- The leader selects an easily identifiable terrain feature to which he believes friendly troops can advance safely.
- The gunner(s) lays the gun on the target with the sights set to hit the target. The range to the target must be determined with the most accurate means available.
- Set the line of aim for the M240G. Leave the sight set to the target range. Using the T&E depress the muzzle of the gun by a number of mils equal to the range to target in hundreds of meters, plus an extra 20 mils. Example: Target range = 1,100 meters. Depress the muzzle by 11 mils (one mil equals one click on the elevating hand wheel) and then depress the muzzle another 20 mils for a total of 31 mils.
- Set the line of aim for the M2 .50 cal. Set the sight on 1,600 meters or the range to the target plus 500 meters, whichever is greater. Under no conditions should the sight be set less than 1,400 meters.

- Note the point where the new line of aim strikes the ground.
  - If the line of aim intersects the selected terrain feature, the selected feature is safe to use as the safety limit. Example: If the unit leader selected the center of the open area between the clumps of trees (A and B) in figure 6-26 as the terrain feature that he wanted to use as the safety limit then he could use that feature because the line of aim intersects the ground at that point and is, therefore, the “actual safety limit.”
  - If the line of aim intersects the ground above the selected terrain feature then the selected feature is safe to use as a safety limit. The leader may want to identify a new terrain feature if one is closer to the line of aim than the first feature selected. Example: If the unit leader had selected the pair of trees (B) in figure 6-26 as the terrain feature that he wanted to use for a safety limit then he could use them because they are located below the point where the line of aim intersects the ground. Friendly troops could advance to those trees without rising above the safety line.
  - If the line of aim is below the selected terrain feature, then a new terrain feature must be selected that is on or above the line of aim.

Example: If the unit leader had selected the single tree (A) in figure 6-26 as the terrain feature he wanted to use for a safety limit he would see that it cannot be used because the line of aim intersects the ground below it. If friendly troops did advance to (A) they would be well above the safety line and could possibly be hit by the machine gun's fire.

At ranges under 850 meters the leader's rule can be used to override the gunner's rule, if the application of the gunner's rule results in a safety limit that, in the leader's opinion, is too restrictive. For example, a terrain feature may be below the line of aim on the gunner's rule and deemed unsafe as a safety limit. When the leader's rule is applied that same terrain feature may be on or above the line of aim and therefore would be safe to use as the safety limit.

The gunner's rule, using sight settings to determine the safety angle, is quick and simple. It provides a very large margin of safety for friendly troops. The leader's rule is more complicated and allows the leader to “fine tune” the safety margin, giving his machine guns more time to engage the enemy, while still affording a high degree of safety to friendly

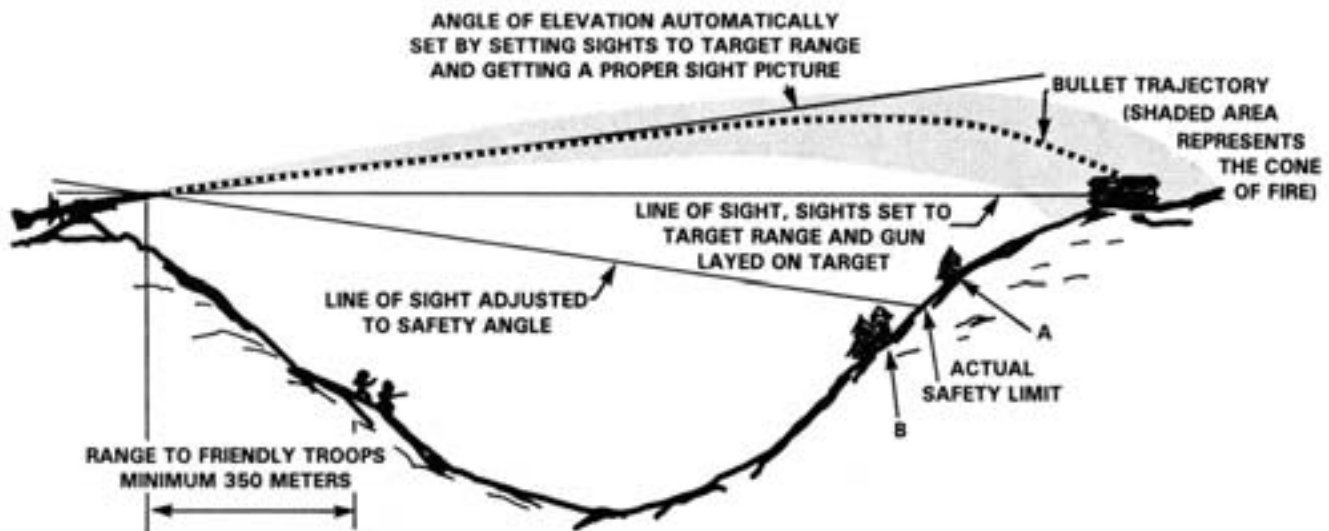

Figure 6-26. Leader's Rule.

RANGE (M)	GUNNER'S RULE				LEADER'S RULE		
	Sight Set@ (mils)	Safety Angle (mils)	Safety Distance (meters)	Height Over a Man (meters)	Safety Angle (mils)	Safety Distance (meters)	Height Over a Man (meters)
400	40.3	36.6	13.6	11.8	24	9.1	7.3
500	40.3	35.3	16.5	14.7	25	11.9	10.1
600	40.3	33.7	18.7	16.9	26	14.9	13.1
700	40.3	31.8	20.5	18.7	27	18.0	16.2
800	40.3	29.5	21.2	19.4	28	21.2	19.4
900					29	24.6	22.8
1000					30	28.3	26.5
1100					31	32.0	30.2
1200					32	35.9	34.1
1300					33	40.0	38.2
1400					34	44.2	42.4
1500					35	48.5	46.7
1600					36	52.9	51.1
1700					37	57.5	55.7
1800					38	62.1	60.3

Figure 6-27. M240G Gunner's and Leader's Rule Data.

troops. Figure 6-27 illustrates the M240G's safety margins allowed by both rules and demonstrates the safety of the leader's rule at ranges under 850 meters.

#### c. Procedure Before Friendly Troops Reach the Limit of Safety

(1) **Safety limit identified on the ground.** After the safety limit has been determined, the gunners and all leaders note some terrain feature by means of which the limit may be identified on the ground. In case safety has been determined by the platoon or section leader, he announces the limit of safety so that the gunners and squad leaders are able to identify it. When necessary, the limit is indicated with the rear sight of each gun, care being taken not to change the laying of the gun on the target.

(2) **Report by gunners.** When the gunner's rule is applied, the gunners report **SAFE** or **NOT CLEAR** to indicate whether or not it is safe to fire.

(3) **Checking laying while firing.** After determining or noting the safety limits, the gunner moves the sight

back to the range to the target in order to check, while firing, the laying on the target.

#### 6802. Use of Binocular in Applying Safety Rules

It is frequently desirable to determine safety for overhead fires before guns are placed in position. Safety may be approximately determined by means of the inverted sight leaf in the binocular. The gunner's and leader's rules are applied with the inverted sight leaf in the binocular in a manner similar to that with the rear sight on the gun. After the guns are emplaced, the safety is checked with the gun sights.

#### 6803. Troop Safety Zones

At times it may be imperative to deliver overhead fire even though the gunner's or the leader's rule indicates that it is not safe to fire. Such conditions will usually exist when the target is at a long range and the guns, troops, and target are about the same elevation.

To cover such cases, refer to the appropriate overhead fire table. Observe the following additional precautions when firing overhead fires with the M240G and the M2 .50 cal:

- Use depression stops to prevent the muzzle of the gun from being accidentally lowered below the limit of safety.
- Do not fire overhead fire through trees which are likely to deflect bullets into friendly troops.
- Do not use worn barrels or barrels that show evidence of previous overheating.
- Do not deliver overhead fires without use of tripod and T&E mechanism; tripod must be firmly emplaced.
- Unless the terrain or firing tables provide obvious safety, do not deliver overhead fire if the range from the gun to target is less than 350 meters or exceeds 850 meters.
- The commanders of troops required to move beneath overhead fires must be informed that such fires are planned.
- Ensure that all members of the gun crew are aware of the safety limit.
- Do not allow cones of fire to cross over the heads of friendly troops.
- Application of gunner's and leader's rules requires that the guns be accurately zeroed.
- Since the trajectories of the M240G tracer ammunition are unpredictable beyond 750 meters (which results from the round becoming unstable as the tracer material burns out), do not use tracer ammunition for overhead fires beyond this range.
- When the friendly troops reach the safety limit, firing ceases.

---

## Section 9

### Techniques of Predetermined Fire

---

#### 6901. Methods of Laying the Machine Gun

Mounting the machine gun on the tripod provides a stable platform from which the gun can be fired and enables the crew to engage targets utilizing both direct and indirect fire. These capabilities provide the means by which accurate data can be collected to enable the gunner to engage targets under all conditions of visibility. In all cases, care must be taken not to disturb the mount once initial readings have been taken from the T&E mechanism, as this will provide inaccurate data and may endanger friendly troops.

#### 6902. M2 Compass Method

The most accurate method of engaging targets is to utilize the M2 compass method. This method enables the gunner to measure the horizontal and vertical angles and thereby place the proper elevation on the T&E mechanism to engage the desired target without adjusting onto the target and revealing the gun position.

In order to engage the desired target, the section or squad leader determines the quadrant elevation angle (see section 11), and by placing the M2 compass on the flat portion of the feed tray cover, he duplicates that angle prior to firing.

#### 6903. Using the T&E Mechanism

Proper utilization of the T&E mechanism is what principally distinguishes the machine gun from the auto-

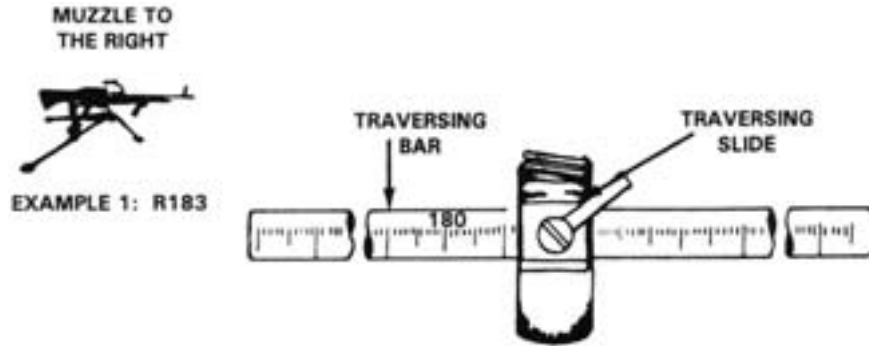

Figure 6-28. Direction Reading.

matic rifle. In order to engage targets, the gunner must be able to lay the machine gun on predetermined targets. This can be accomplished either by use of the T&E mechanism or one of the field expedient methods.

**a. T&E Method.** Direction and elevation readings constitute the data necessary to engage a predetermined target. These readings are taken from the traversing bar and the T&E mechanism. When possible, this data should be determined to the nearest mil.

- Determine direction to the nearest mil is determined by reading the mil setting on the traversing bar and either adding or subtracting the mil setting on the traversing hand wheel. See figure 6-28 and paragraph 6501.
- Determine elevation by reading the upper elevating screw and the elevating hand wheel. See figure 6-29.
- After the direction and elevation has been determined, record it on the range card for future use.
- When firing, the guns are allowed 2 mils of traverse in each direction (see figure 6-30). After firing the first burst, traverse 2 mils in one direction and fire, then 4 mils in the other direction (firing a burst after each 2 mil change); thus, bursts are fired 2 mils to the right and left of center. Normally, searching fire will not be necessary because of the length of the beaten zone, unless the target is being engaged with plunging fire.

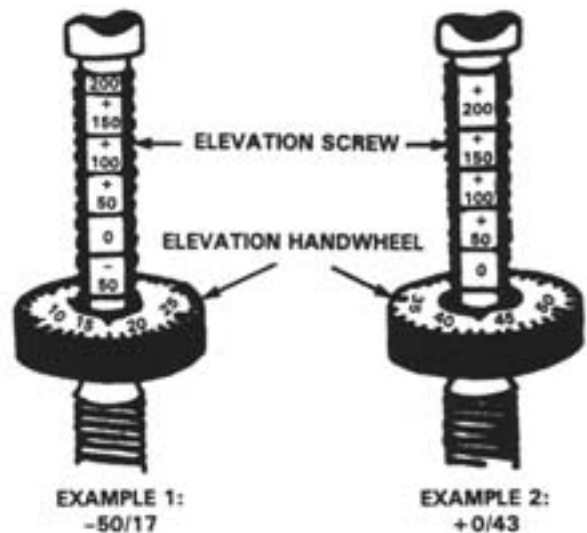
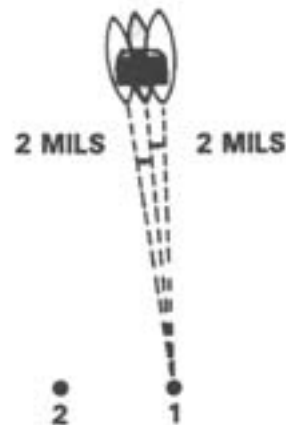

Figure 6-29. Elevation Reading.



NOTE THAT GUN #2 WOULD BE FIRING AND TRAVERSING ALSO

Figure 6-30. Firing for Effect on a Predetermined Target.

b. **Field Expedients.** Field expedients include the use of stakes and other devices to engage predetermined targets. The T&E method is more accurate, but it requires some light at the gun position; therefore, field expedients are used to supplement the T&E method.

(1) **Base stake method.** The base stake method is the simplest and most useful field expedient. Stakes are used to define the sector limits and the FPL. A stake is driven into the ground under the gas cylinder to pick up the elevation needed to fire the FPL (see figure 6-31). Note that the T&E mechanism is still in use. This field expedient in particular will seriously limit the ability to quickly and effectively engage targets outside the sector.

(2) **Aiming stake method.** Luminous tape, luminous paint, or some other suitable material is needed to use this technique. After the gun has been laid to hit the target, the following procedure is used. See figure 6-32.

- Place a strip of luminous tape or paint at least halfway up the rear of the front sight post and on the top of a stake.

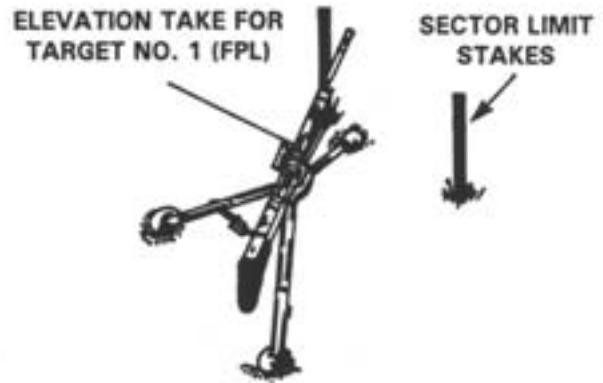

Figure 6-31. Field Expedient—Base Stake Method.

- Raise the rear sight slide to its uppermost position.
- Move the head slightly to the right so that the front sight post appears in the left corner of the rectangle formed by the rear sight slide and the rear sight lead. Maintaining the same positions and grip, direct the assistant gunner to drive the stake into

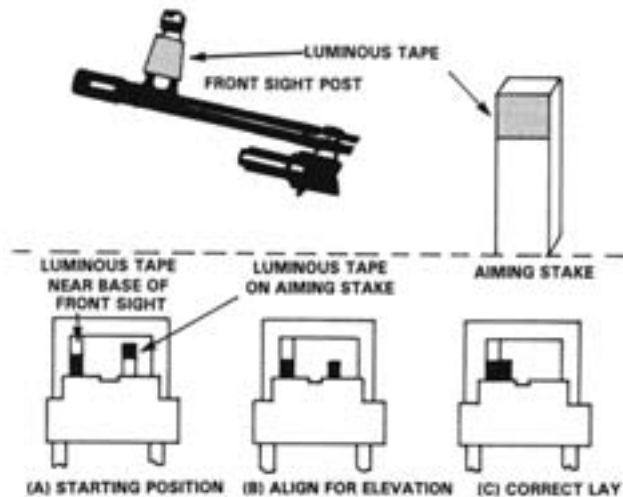

Figure 6-32. Field Expedient—Aiming Stake Method.

the ground about 1 meter in front of the gun. Align the stake so that the two pieces of luminous material are adjacent (aligned for direction) and the top edges of both pieces of material are level (aligned for elevation). One stake is set out for each target.

- To hit a target when it cannot be seen, raise the rear sight slide to its uppermost position and manipulate the gun until the correct sight picture is obtained.

3) **Horizontal log method.** This technique is used to define sector limits and fields of grazing fire. The FPL would be located along one of the sector stakes. A log or board is placed between the sector stakes in such a way that the barrel will be at the proper elevation to obtain grazing fire across the front. In this case, the tripod is used, but not the T&E mechanism. See figure 6-33.

(4) **Notched stake method.** If, for some reason, the bipod mount is being used instead of the tripod, targets can be made predetermined by the use of notched or forked stakes. The stakes are driven into the ground so that the butt stock rests in the notches when the gun is laid to hit the target. Shallow trenches or grooves are dug for the bipod feet. See figure 6-34.

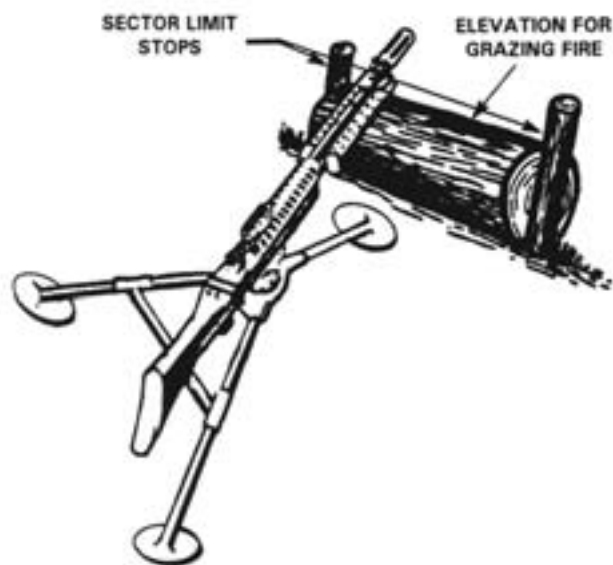

Figure 6-33. Field Expedient—Horizontal Log Method.

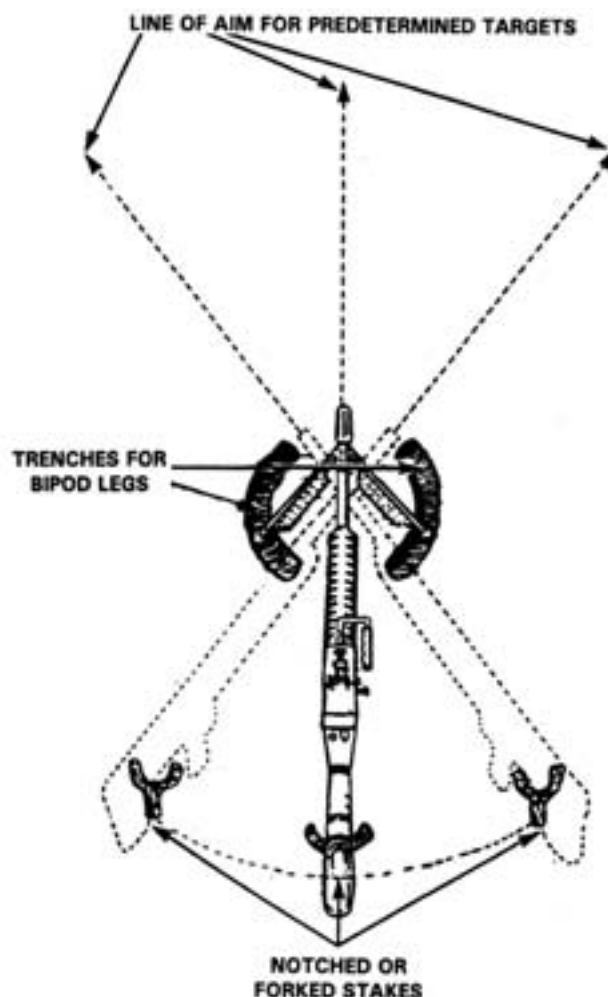

Figure 6-34. Field Expedient—Notched Stake Method.

(5) **Auxiliary aiming point method.** When the target is invisible to the gunner or is exceptionally difficult to see, fire may often be directed by use of an auxiliary aiming point, securing data by one of the two methods given below. The heavy machine gun may be laid by using an auxiliary aiming point that is not more than 20 mils off the gun-target line (10 mils with the medium machine gun).

(6) **Binocular method.** The leader selects a clearly defined object in the vicinity of the target (see figure 6-35). Using the inverted sight leaf, he aligns on the target that graduation which corresponds with the

range to the target (1.050). Keeping the binocular in that position, he reads the graduation on the scale opposite the auxiliary aiming point. When the auxiliary aiming point is not on the gun-target line, the deflection is read on the horizontal mil scale of the binocular. Using these readings as the sight setting and deflection, for example, range 1,350 sight right 20, the gunner lays on the object selected as the auxiliary aiming point and fires, distributing the fire as ordered by the unit leader. See figure 6-35.

(7) **Gun method.** Data for auxiliary aiming points may be determined by means of the rear sight slide and windage scale on the gun. The gun is first laid on the target with the correct sight setting to hit the target, and when the tactical situation permits, the initial lay is verified by firing. Then, without disturbing the lay of the gun, the rear sight is manipulated so that the line of aim is directed at some clearly defined object (stump, bush, or aiming stake) which the gunner is always able to see, no matter what the visibility conditions may be. The settings on the rear sight and the windage gauge are recorded. Then, when fire is to be placed on the target, the leader announces these settings in his fire command and orders the gunner to lay on the auxiliary aiming point. An example of a fire command is:

**FIRE MISSION**  
**FRONT**  
**AUXILIARY AIMING POINT**  
**BLACK STUMP**  
**1,350 SIGHT**  
**RIGHT 20**  
**FIXED**  
**AT MY COMMAND**  
**FIRE**

---

### Section 10 Final Protective Lines

---

An FPL is a predetermined line along which grazing fire is placed to stop an enemy assault. The fire is usually fixed as to direction and elevation and can be fired under all conditions of visibility. When fixed fire is incapable of producing the maximum effective grazing fire, because of irregularities in the terrain, some searching fire may be used in conjunction with the fire of other weapons to ensure that all of the FPL is covered. Except when targets are being engaged, the gun is laid on the FPL.

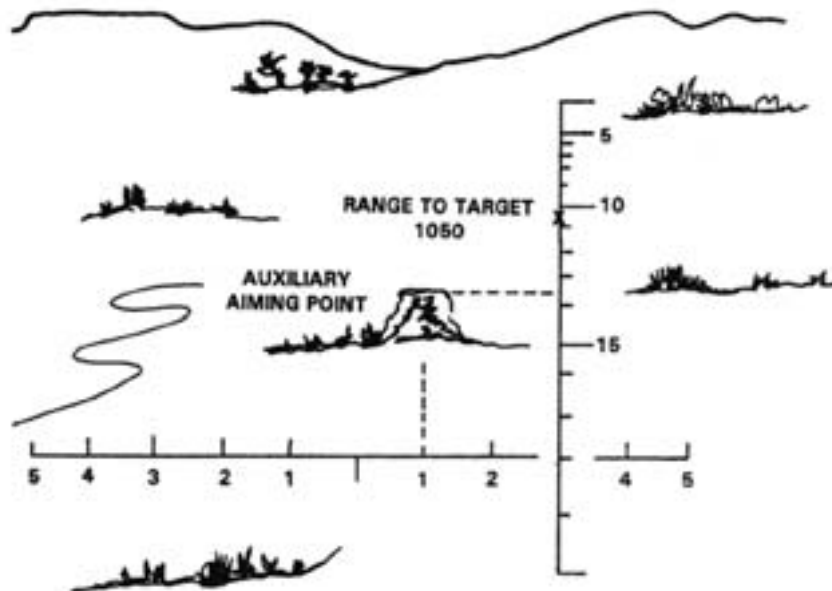

**Figure 6-35. View Through Binocular; Use of Auxiliary Aiming Point.**



### 61001. Sectors of Fire

In the defense, machine gun squads are assigned sectors of fire, the inner limits of which are usually, but not always, the bands of grazing fire placed along the FPL. The sector of fire should not exceed 800 mils (45 degrees). The machine gun fire unit is responsible for engaging the enemy within its sector, subjecting him to fire as he approaches, and finally forcing him to pass through coordinated bands of grazing fire before he can make his assault. When the sector of fire does not include an FPL, a zero line is used. It is desirable that the zero line approximately bisect the sector, and that it points toward a clearly defined landmark in the area.

### 61002. Methods of Laying Final Protective Lines

On level or uniformly sloping ground up to a range of 600 meters, (7.62mm, with the M240G) the center of the cone of fire does not rise above 1 meter. The entire cone of fire does not rise more than 1.8 meters. The length of the forward half of the beaten zone (50 meters) is added to the range (600 meters) in computing the total possible danger space on level or uniformly sloping ground; approximately 650 meters. However, level ground or ground that slopes uniformly for 600 meters is not often available. Two cases are given in the following paragraphs to illustrate the different types of terrain on which FPLs may be placed and the methods of laying the gun for elevation and direction to get the maximum amount of grazing fire in each case.

#### a. Level or Uniformly Sloping Ground

##### (1) Heavy gun

(a) *Direction.* The gunner lays the gun in the direction of the FPL or zero line and zeroes the dial.

(b) *Elevation.* The gunner selects an aiming point on the FPL or zero line at a range of approximately 600 meters (see figure 6-36). The assistant gunner measures the angle of quadrant elevation by means of an M2 compass or gunner's quadrant.

##### (2) Medium machine guns on tripods

(a) *Direction.* The gunner centers the traversing hand wheel mechanism and zeroes the traversing micrometer. Upon determining along which limit of the sector the FPL is to lie, the gunner sets the traversing slide toward that end of the traversing bar which is opposite the direction of the FPL. He then lifts the rear legs of the tripod and aligns the muzzle in the approximate direction of the line. By doing this, he obtains the maximum angle of traverse away from the FPL in the direction of the targets in his sector.

#### NOTE

Directional laying of the gun to the left requires that the traversing slide be set to the right of the zero mark on the traversing bar, and vice versa. For all readings of the traversing bar scale, the left edge of the traversing slide is used as an index.

If a zero line is used instead of an FPL, the gunner centers the traversing slide at zero on the traversing

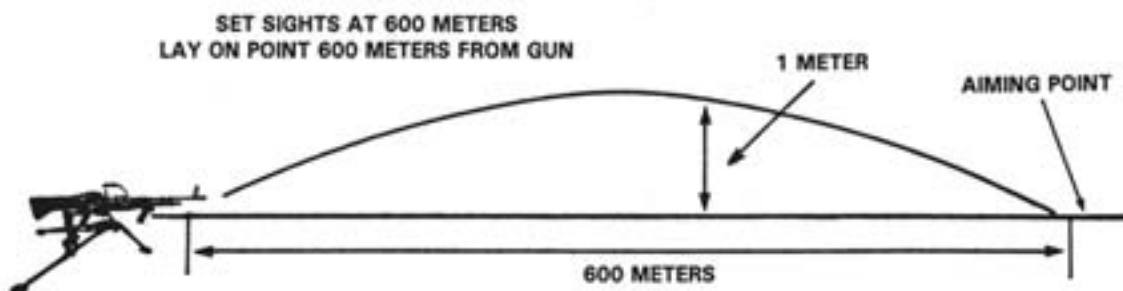

Figure 6-36. Method of Laying When the Ground is Level or Uniformly Sloping.

bar scale. He then lifts the rear legs of the tripod and aligns the gun on the designated line. The traversing bar reading of zero is indicated on the range card.

(b) *Elevation.* The gunner lays the gun on an aiming point on the FPL or zero line at a range of approximately 600 meters. He notes the sign and the first number whose graduation is visible above the elevating hand wheel on the elevating screw scale, then obtains the number on the elevating micrometer dial toward which the indicator is pointing. A combination of these numbers, when replaced on the gun, allows the gun to be laid for the same elevation.

#### b. Irregularly Sloping Ground

(1) *Direction.* The gunner lays the gun by sighting in the desired direction, as previously described.

(2) *Elevation.* The gunner selects an aiming point on the ground and near the break in the uniform slope, and with a sight setting of the range to the selected point, lays the gun on that point and elevates it 2 mils by means of the elevating hand wheel. See figure 6-37.

c. *Dead Space.* Dead space, as discussed in this section, is that portion of the FPL that cannot be covered by grazing fire. Streams, ravines, and small depressions in the ground may allow passage under the grazing fire along the FPL. This dead space must be covered by other weapons (see figure 6-38). The location of dead space along the FPL should be accurately determined. This can be done by walking the trace of the FPL. Dead space exists any time the center mass of a man's chest drops below the line of aim. If personnel are unable to move beyond the gun position, observation of fire both from behind the gun and from the flank will assist in the location of dead space. (See appendix G for more detail.)

d. *Laying in the FPL.* Specific details concerning laying in an FPL are contained in appendix G.

#### 61003. Rates of Fire on the Final Protective Line

When the signal to fire the FPL is received, the gunner immediately begins firing on the FPL at the rapid



Figure 6-37. Method of Laying When There is a Break in the Uniform Slope (For Ranges Less Than 600 Meters).

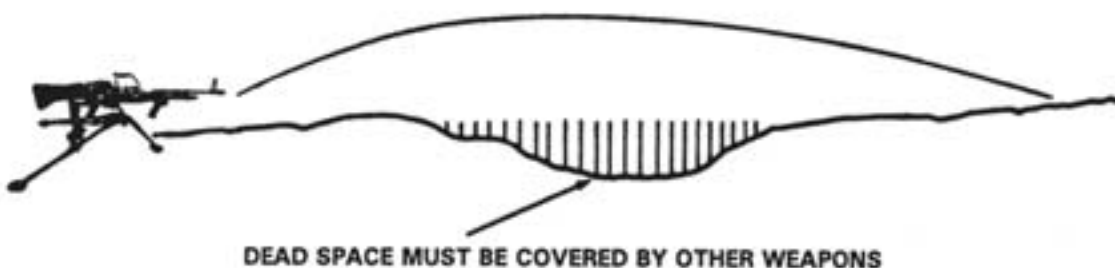

Figure 6-38. Dead Space.

rate for 2 minutes. From the 2-minute mark until the signal to cease fire is given, the gunner fires at the sustained rate of fire, unless otherwise directed.

#### **61004. Laying the Gun for a Principal Direction of Fire**

To engage a PDF, you are allowed to traverse and search over the entire dangerous avenue of approach, so the PDF is generally in the center of the sector. Lay the gun on the near end of the PDF and take the direction reading. Laying for elevation is accomplished by firing the PDF and adjusting the center of impact onto the near end of the avenue of approach. The gun is then fired employing traverse and search to cover the entire target. The number of mils of traverse and search necessary to cover the target should be recorded on the range card and a firing sequence established.

---

### **Section 11 Range Cards**

---

A range card is a rough sketch or drawing which serves as both a record of firing data and a document for defensive fire planning. Each gun makes a range card in duplicate using the available Standard Range Card form (DA Form 5517-R). See figure 6-39. In the event that a gun crew does not have this standard form, the range card should be drawn on any material available. One copy remains at the gun position as a record of firing data. The gunner uses the card to recall the data to fire on predetermined targets and as an aid in estimating ranges to other targets during good visibility. The other copy is sent to the next higher headquarters (usually the company), who use it to organize the defense and prepare a fire plan sketch. Regardless of the length of time the gun crew expects to occupy a position, preparation of a range card begins immediately. Revisions and improvements are made later as necessary. To construct a range card, the sketch first must be oriented, then the data obtained must be recorded.

#### **61101. Orientation**

A dot is drawn to signify the position of the gun. In order that higher headquarters can determine where the gun is located on the ground, the sketch is oriented (see figures 6-39 and 6-40). The gun position can be positively located by an 8-digit grid coordinate. Finally, the range card is signed by writing down the gun number, unit designation, and date. For security reasons, no higher unit designation than the company is shown. A separate range card is made for an alternate position. The cards are clearly marked, indicating either primary or alternate position.

#### **61102. Recording Information**

As the firing data is obtained, using any combination of the methods previously described, it is recorded on the range card. Particular attention is paid to the final protective fires, either the FPL or the PDF, whichever is assigned. This is the single most important piece of information of concern to superiors. Figure 6-39 shows a range card with an FPL and firing data recorded using the T&E method only. Figure 6-40 depicts a range card with a PDF and data recorded using a combination of traversing and elevating and field expedient methods (stakes).

- An FPL is drawn as a heavy line, shaded to signify grazing fire (see figure 6-39). Gaps are left in the heavy line to indicate dead space. The range is recorded to the near and far ends of the dead space and to the maximum extent of graze along the FPL. The firing data needed to engage this target and the magnetic azimuth (measured with a compass) is written on the range card. Although the range cards are not required to be drawn to scale, the magnetic azimuth will aid the higher headquarters to do so if necessary.
- The PDF is drawn as a solid line with an arrow, and the range is recorded to the near end of the avenue of approach. The firing data and a magnetic azimuth are also written in. See figure 6-40.

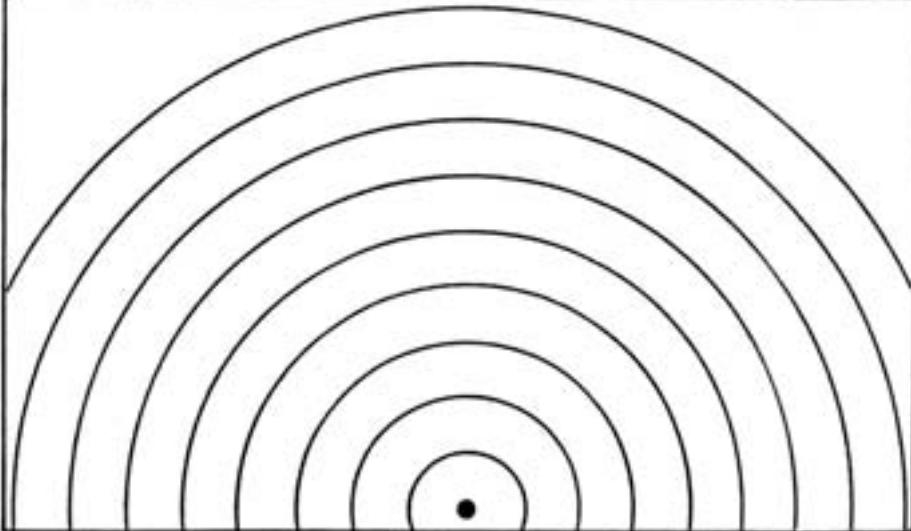
STANDARD RANGE CARD		
For use of this form see FM 7-7J. The proponent agency for TRADOC.		
SOD _____ PLT _____ CO _____	May be used for all types of direct fire weapons.	MAGNETIC NORTH
		

DATA SECTION					
POSITION IDENTIFICATION				DATE	
WEAPON			EACH CIRCLE EQUALS _____ METERS		
NO.	DIRECTION/ DEFLECTION	ELEVATION	RANGE	AMMO	DESCRIPTION
REMARKS:					

DA FORM 5517-R, FEB 86

Blank Form

Figure 6-39. Standard Range Card Form.

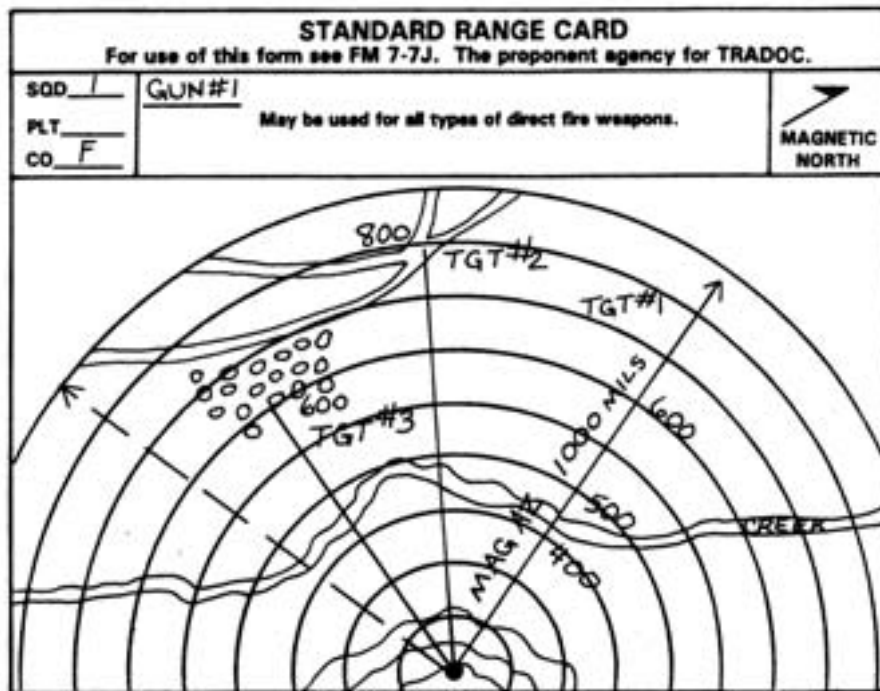

DATA SECTION					
POSITION IDENTIFICATION PRIMARY - GRID 84934577				DATE 9 AUG 95 / 0730	
WEAPON M 240G			EACH CIRCLE EQUALS METERS 100		
NO.	DIRECTION/ DEFLECTION	ELEVATION	RANGE	AMMO	DESCRIPTION
1	R 400	+50/10	600		FPL
2	L 100	+0/40	800		ROAD INTERSECTION
3	L 300	-50/20	600		ORCHARD
REMARKS:					

DA FORM 5517-R, FEB 88

Figure 6-39. Standard Range Card Form—Continued.

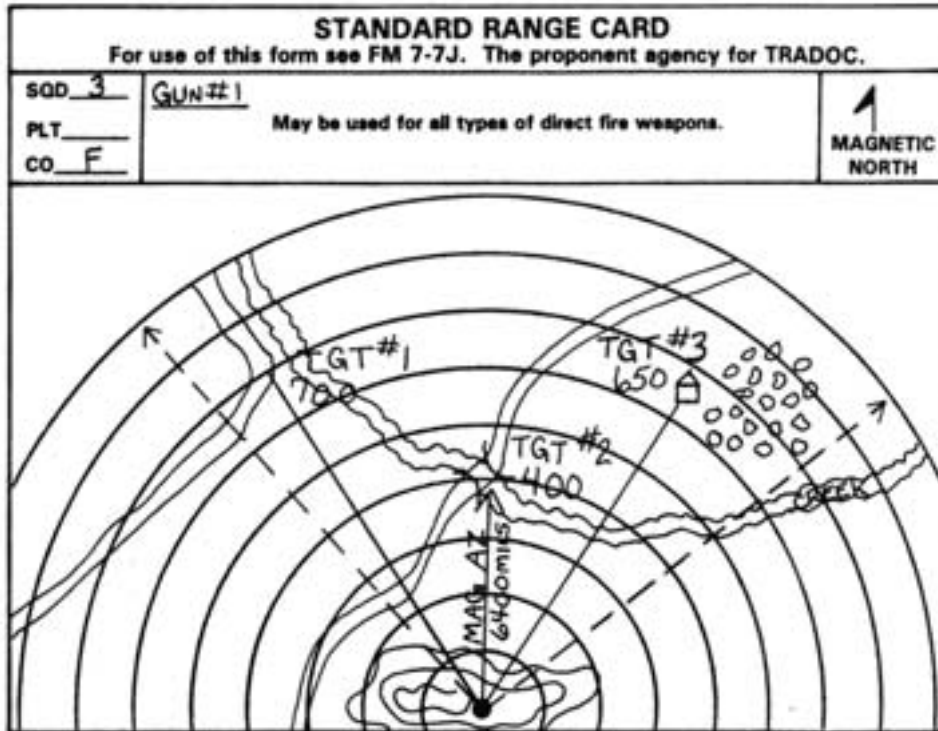

DATA SECTION					
POSITION IDENTIFICATION <u>PRIMARY-GRID 73856163</u>				DATE <u>9 AUG 95/0900</u>	
WEAPON <u>m240G</u>			EACH CIRCLE EQUALS <u>100</u> METERS		
NO.	DIRECTION/ DEFLECTION	ELEVATION	RANGE	AMMO	DESCRIPTION
1	STAKE #1	STAKE #1	700		BEND IN ROAD
2	00	-100/42	400		BRIDGE (PDF)
3	STAKE #2	STAKE #2	650		BARN
REMARKS:					

DA FORM 5517-R, FEB 86

Figure 6-40. Range Card With a Principal Direction of Fire.

- Sector limits are designated by dashed lines and named either the right or left sector limit. The firing data is recorded. The elevation reading from the T&E is recorded when using the T&E method. It is shown in figure 6-34. The elevation data for the field expedient method is based on the placement of the stakes and is not recorded on the card. The sector limits in this example are also based on the limiting stakes.
- Other targets of tactical significance are predetermined, then sketched and recorded on the range card.
- The targets are numbered consecutively from the FPL. The FPL is always target number 1. When a principal direction of fire is assigned, targets are numbered starting from either side.

---

## Section 12

### Firing From Defilade Position

---

To achieve maximum accuracy and effective fire, a machine gun must be employed using direct lay. However, at times the tactical situation may make it desirable to employ a machine gun from a defilade

position. A defilade position is one in which the gun and crew are hidden from enemy observation by an intervening land mass called a mask. A position offers partial defilade when the mask offers some protection against direct fire but the gunner can engage targets using direct lay. Partial defilade positions are desirable when the mission cannot be accomplished from a defilade position. See figure 6-41.

The physical factors that effect the ability to bring fire to bear on a target from a defilade position are the range to the target, the trajectory of the round, and the height of the mask between the gun and target. The MK-19, with its relatively high trajectory, is the best-suited machine gun for employment from a defilade position.

To engage a target from defilade positions, the target must be identified and the fire adjusted by an observer who sees the target. The gun crew must know direction, elevation, and mask clearance.

Firing from a defilade position is often most effective in a defensive situation in which the gun or guns can be carefully laid and fires registered on likely targets. In this manner, the MK-19 can be employed effectively in a reverse-slope defense.

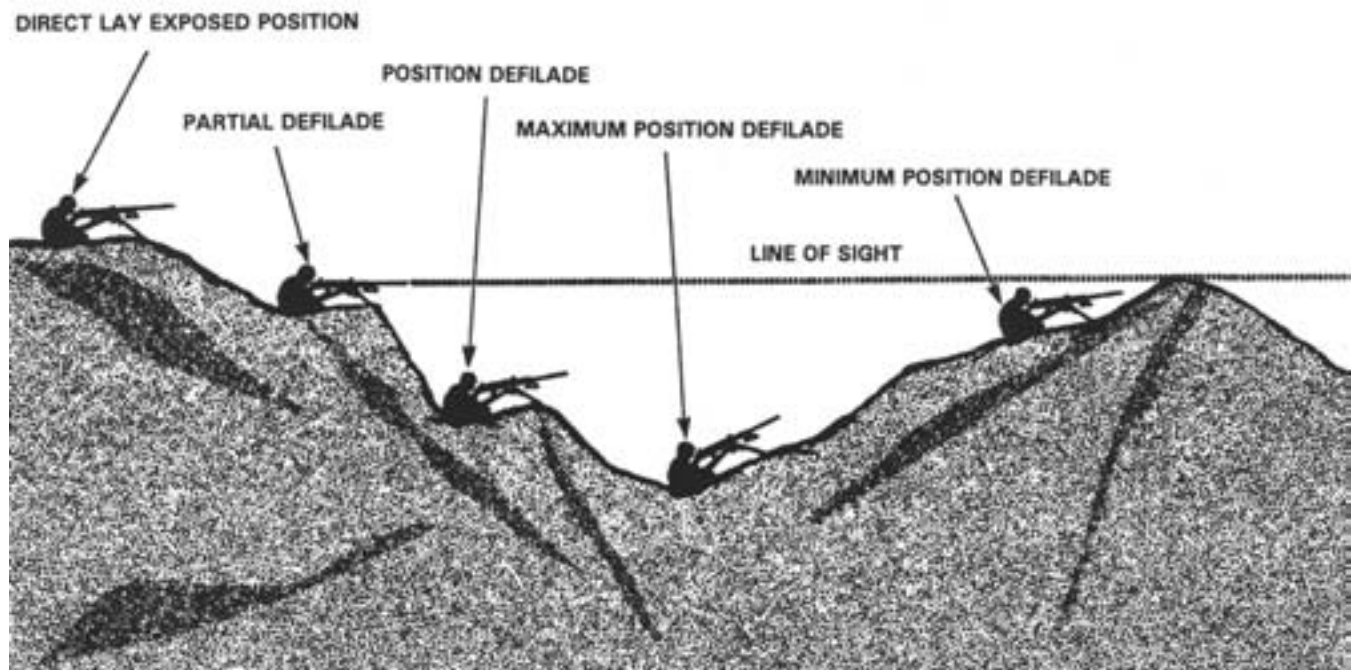

Figure 6-41. Minimum and Maximum Position Defilade, Partial Defilade, and Direct Lay Areas.

### 61201. Defilade Position

**a. Advantages.** A defilade position offers the following advantages:

- The gun and crew have cover and concealment.
- The crew has some freedom of movement in and around the position.
- Control and supply are facilitated.
- The smoke and flash of the gun may be concealed.

**b. Disadvantages.** A defilade position has the following disadvantages:

- Rapidly moving ground targets are not easily engaged because adjustment of fire must be made through an observer.
- Targets close to the mask often cannot be engaged.

### 61202. Selecting a Firing Position

The platoon or section leader indicates the approximate location of the gun. The squad leader selects the exact position. To select a position in minimum position defilade, the squad leader, knowing the approximate height above the ground of the gunner's eyes when the gunner is in position behind the gun, moves up the slope until, sighting from that height, he has the target in view above the mask. He then moves down the slope, sighting from the same height, to the point at which the target is again masked. He marks this point as the gun position. He may use a cleaning rod, on which the correct sighting height has been noted, as an aid in selecting the position and to make the selected position.

While the squad leader selects the position, the gun crew examines equipment and mounts the gun under cover. Upon the squad leader's signal, the crews move the guns to the selected firing positions.

### 61203. Laying the Gun for Direction

**a. Direct Alignment Method.** The observer posts himself on the gun-target line and in a position where he can see the target. He aligns the gun approximately by having the gunner shift the tripod. The gunner then loosens the traversing slide and, directed by the observer, moves the gun right or left until it is aligned on the target.

**b. Use of an Aiming Point.** A prominent landmark visible to the gunner through his sights is selected as an aiming point (see figure 6-42). An aiming point on the gun-target line and at an equal or greater range than the target is desirable; however, an aiming point on the mask can be used.

When the aiming point is on the gun-target line, lay the gun on the aiming point, thereby aligning it on the target.

When the aiming point is not on the gun-target line, measure the deflection by means of binocular or compass. This measured deflection is laid off with the gun.

**c. Aiming Stake Method.** When no natural aiming point is available, an aiming stake may be set out, and the gun aligned on the target as described in the preceding paragraph.

**d. Map and Compass Method.** Locate the gun position and target on a map and draw a line between the two points. Orient the map to the terrain and place the line of sight of the compass along the gun-target line drawn on the map. The magnetic azimuth indicated by the compass index is announced to the guns as the direction of lay (see figure 6-43). Employing this method in conjunction with the infantry plotting board and terrain profiling techniques permits the machine gun to be employed from maximum defilade positions delivering indirect fire and allows the observer to move off the gun-target line. See appendices E and H and paragraph 61207 in this chapter for detailed instructions.



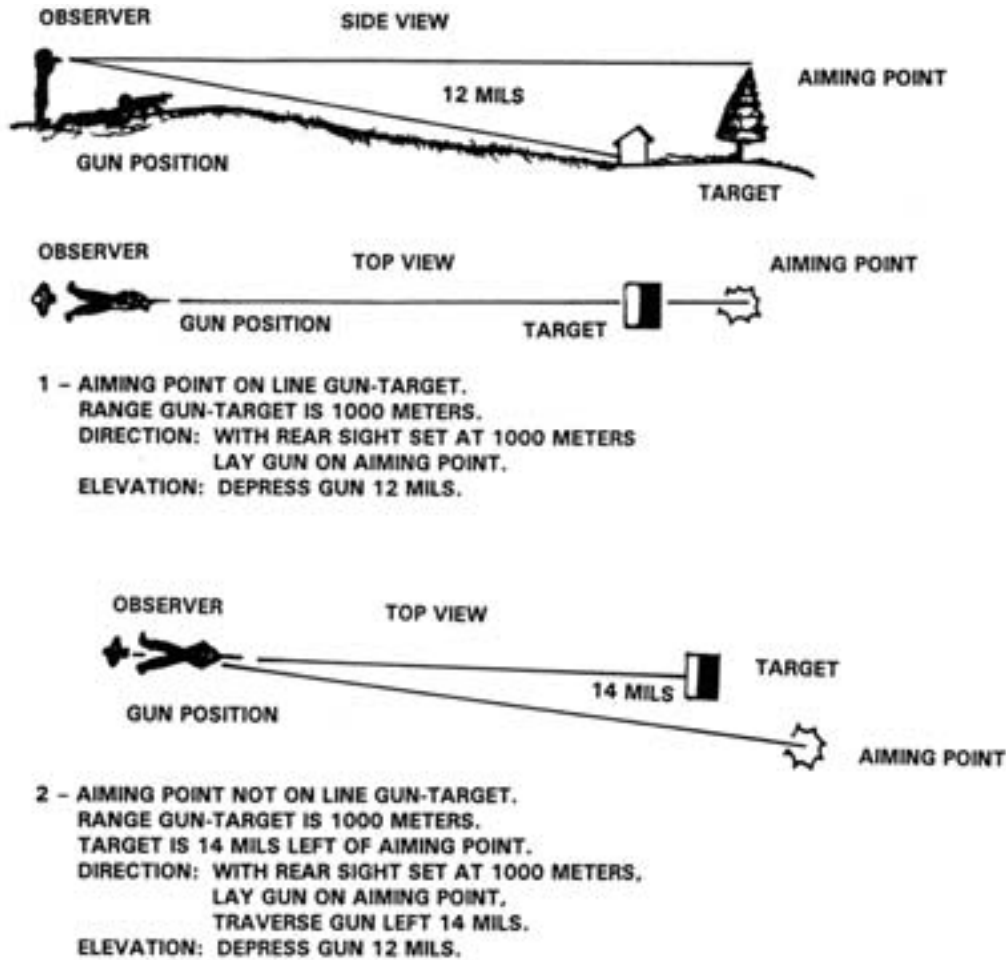

Figure 6-42. Aiming Point Method.

### 61204. Laying the Gun for Elevation

The gun can be laid for elevation using the aiming point method or by using the appropriate firing tables, which includes the computed and measured quadrant elevation methods.

**a. Aiming Point Method.** An aiming point from the gun position is selected, preferably at a point at a greater range and higher elevation than the target. The range to the target is determined. The leader, using binoculars, measures the vertical angle in mils from the aiming point to the base of the target. He then lays the gun on the aiming point with the sight setting to hit the target, and directs the gunner to manipulate the gun through the number of mils measured. For example: The range to a target is 1,300 meters. The angle

read from the aiming point down to the base of the target is 12 mils. The sight is set at 1,300 meters and the gun is laid on the aiming point. The muzzle is then depressed 12 mils.

### b. Using the Firing Tables

(1) **Angle of elevation (A&E).** A straight line between the chamber of the gun and the target is called the line of sight (see figure 6-44). The bullet begins its flight in prolongation of the axis of the bore. However, because of the action of gravity and air resistance, it falls in a gradual curve. As a result, it is necessary to elevate the axis of the bore above the line of sight to hit a target at a given range. The vertical angle above the line of sight through which the axis of the bore is raised so that the bullet will carry to the target is called the

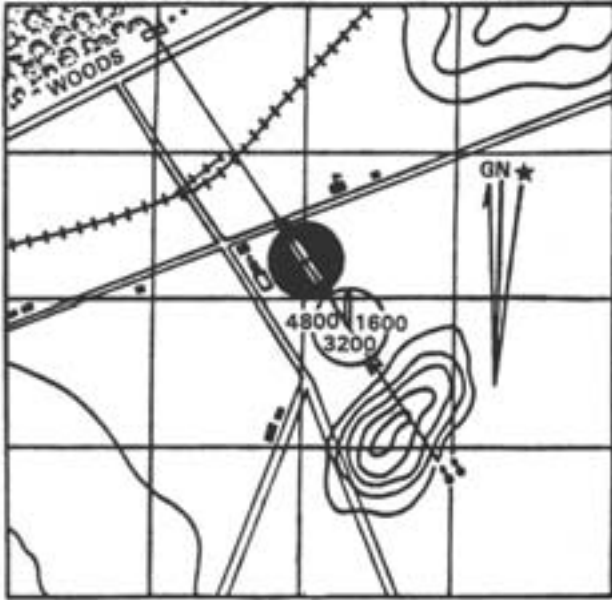

**Figure 6-43. Map and Compass Method.**

angle of elevation. Thus, the angle of elevation is always positive (plus), is constant for any given range, and increases as the range increases. For example: to hit a target at a range of 1,000 meters with the M240G, elevate the gun so that the bore forms an angle of +17 mils with the line of site.

(2) **Angle of site (AS).** When the gun and target are not at the same elevation, an additional angle must be taken into consideration. This angle is the vertical angle formed by the line of site and a horizontal line through the chamber of the gun. It is called the angle of site. When the target is at a higher elevation than the gun, the angle of site is positive (plus). When the target is lower than the gun, the angle of site is negative (minus). See figure 6-44.

(3) **Quadrant elevation (QE).** The angle of quadrant elevation is the angle formed by the line extending through the axis of the bore toward the target and a horizontal line through the gun (see figure 6-44). The quadrant elevation is positive (plus) whenever the gun

is aimed above the horizontal, and negative (minus) whenever the gun is aimed below the horizontal. The quadrant elevation is the algebraic sum of the angle of elevation and angle of site; that is, if the angle of site is positive, it is added to the angle of elevation; if the angle of site is negative, it is subtracted from the angle of elevation.

(a) *Quadrant of Elevation When Gun and Target are on the Same Horizontal Plane.* The target is a range of 1,000 meters and on the same horizontal plane as the gun. Therefore, elevate the gun to form an angle of 16 mils with the line of site (since +16 mils is the angle of elevation for a range of 1,000 meters). (See fig. 6-44 [1].) The angle of sight is 0, because the line of site coincides with the horizontal; therefore, the quadrant elevation is +16 mils (the algebraic sum of the angle of elevation [+16] and the angle of site [0]).

(b) *Quadrant of Elevation When the Target is Higher Than the Gun.* The target is at a range of 1,000 meters and at greater elevation than the gun (see figure 6-44 [2]). To hit the target, fire the gun at an angle equal to the angle of elevation for the range (+ 16 mils) plus the angle of site. The angle of site is +5 mils; therefore, lay the gun with a quadrant elevation of +16 and +5, or a total of +21 mils.

(c) *Quadrant of Elevation When the Target is Lower Than the Gun.* The target is at a range of 1,000 meters but at a lesser elevation than the gun (see figure 6-44 [3]). To hit the target, fire the gun at an angle equal to the angle of elevation for the range (+ 16 mils) minus the angle of site. The angle of site is -5 mils; therefore, lay the gun with a quadrant elevation of +16 and -5, or a total of +11 mils. Figure 6-44 illustrates a case where the target is at a range of 1,000 meters and the angle of site is -20 mils. Since the angle of elevation is +16 mils, the quadrant elevation is the combination of +16 mils and -20, or an algebraic sum of -4 mils. Negative or minus angles of quadrant elevation are not common, but may be encountered on certain types of terrain.

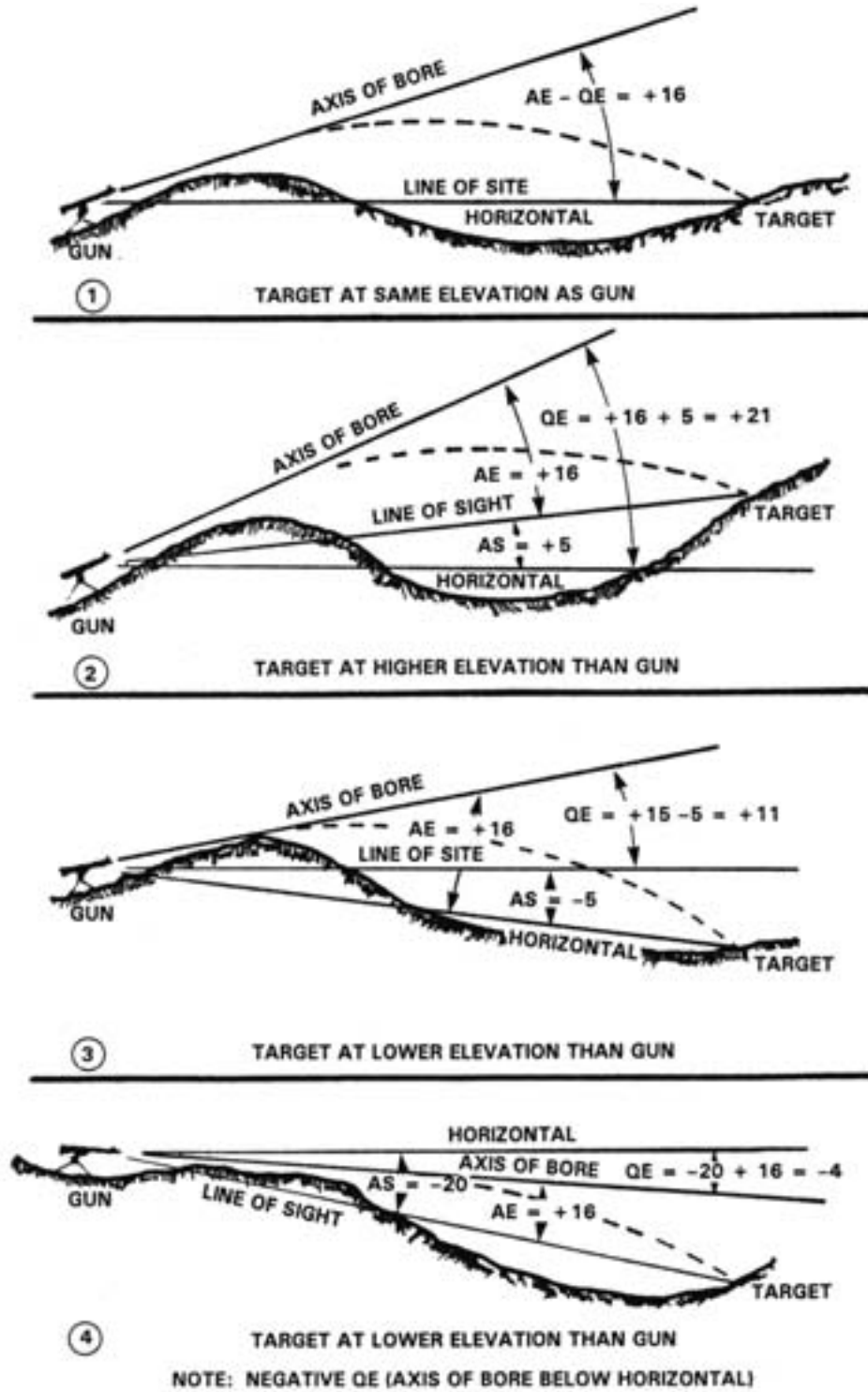

Figure 6-44. Angles of Elevation, Angle of Site, and Quadrant Elevation.

### c. Computed Quadrant Elevation Method (Heavy Gun)

Determine the range to the target by the most accurate means available and obtain the corresponding angle of elevation from the firing tables. Determine the angle of site by use of the aiming circle or the binocular. When the binocular is used, determine the angle of site by measuring in mils the vertical interval between the target and the estimated horizontal.

In estimating the horizontal, assume the distant horizon to be at an angle of site of zero, or at the same elevation as the gun position. Determine the angle of quadrant elevation by algebraically adding this data. Place the quadrant elevation on the gun with the M2 compass.

### d. Measured Quadrant Elevation Method (Heavy Gun)

#### NOTE

These methods may also be used with the medium and general purpose machine guns with slight variation.

Locate the gun in partial defilade and lay it on the target by direct laying methods. Then measure the quadrant elevation with the M2 compass.

Move the gun into position defilade and place the measured quadrant elevation on the gun. For each meter difference in elevation between the position in partial defilade and the firing position, add 1 mil to the quadrant elevation when firing at a range of 1,000 meters, 1/2 mil when firing at 2,000 meters, etc.

### 61205. Determining Mask Clearance

After the gun has been laid, it is necessary to determine whether or not the entire cone of fire will clear the mask, if mask clearance is not obvious.

**a. Visual Method.** When the range to the mask is not more than 300 meters, mask clearance will exist when the axis of the bore is elevated 2 mils or more

above the gun-mask line. Mask clearance can be checked after the gun has been laid on the target by depressing the muzzle of the gun 2 mils and sighting along the lower edge of the barrel in line with the axis of the bore. If the sight taken clears the mask, mask clearance exists.

**b. By Use of Firing Tables.** The range to the mask is determined and the corresponding angle of elevation for mask clearance is found in the firing tables. The range corresponding to this angle of elevation is set on the gun sight. If the line of aim through the sights clears the mask, mask clearance exists.

### 61206. Adjustment of Fire

Under field conditions, even the most practical methods of quickly laying the gun on the target will not normally result in an initial burst on target. Rapid adjustment of fire on target is essential. When possible, the gun or guns are registered on one or more likely targets and the data from the T&E mechanism recorded. In adjusting fires, the observer can shift from one of these known targets.

By locating himself on or near the gun-target line, the observer simplifies adjustments. When not located on the gun-target line, the observer uses the visual method, making all corrections as if he were on the gun-target line. The observer makes all corrections in mils, using the WERM formula as necessary (see paragraph 61302). Lateral adjustments for the gun are simple, since one click on the T&E mechanism equals 1 mil of adjustment. Range adjustments for the guns are more difficult, requiring experience to know the proper mil corrections.

Adjustment of fire must be bold, aggressive, and continuous. Creeping fire should be avoided. The initial burst of fire should be long enough to ensure that the observer sees it. When time permits, fires can be adjusted using a plotting board and the firing tables contained in appendices A, B, and C. See appendices E and F for more on the use of the M17 plotting board and its use for adjusting machine gun fire.

### 61207. Constructing a Terrain Profile

A profile or side view (cross section) of the ground along a selected line or direction can be used to determine where friendly and enemy forces can see each other. It can also be used to plan fires; i.e., where to place the guns to obtain grazing fire, where dead space is located, etc. In short, con-

structing a terrain profile will enable the gunner to obtain that fixed, flanking enfilade, grazing fire. A terrain profile is also useful when employing machine guns to deliver indirect fire on a target (see figure 6-45). To construct a terrain profile, first locate your position on the map, and determine the direction of fire, or profile line. See figure 6-46.

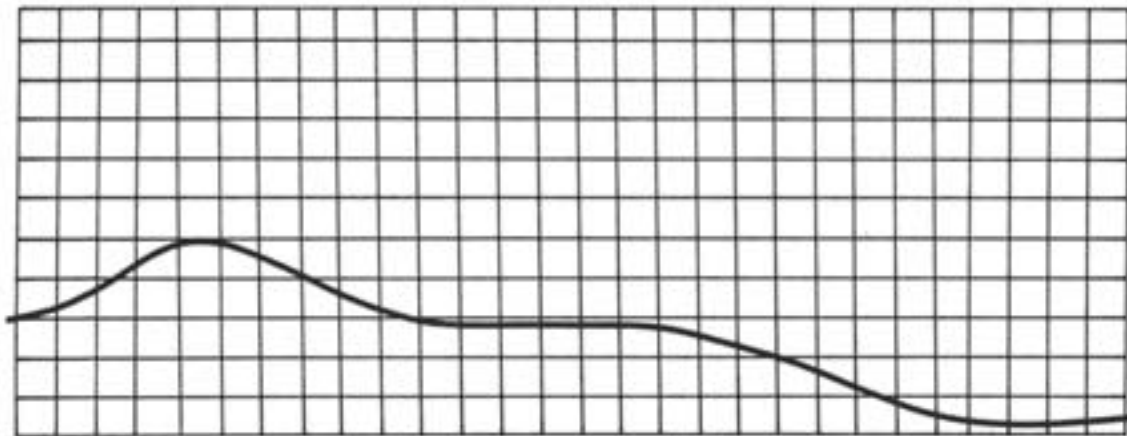

Figure 6-45. Profile Example.



Figure 6-46. Profile Line (Map Contour Interval is 10 Feet).

Place the edge of a lined piece of paper along the profile line (direction of fire). All points of known elevation are tick marked on the edge of the paper; the points of known elevation are the contour lines. (Any paper with evenly spaced horizontal lines, such as graph or notebook paper, may be used. The wider the spacing of the line the greater the vertical exaggeration in the profile; however, this does not affect the information.) See figure 6-47.

Draw perpendiculars down across the horizontal lines for each marked point, and identify the high and low points along the profile. See figure 6-47.

The last step is to connect all the points with a smooth curve. See figure 6-48.

Based on the terrain profile in figure 6-49, it is possible to obtain fixed, flanking-enfilade, grazing fire out to maximum effective range by placing a machine gun squad at about 80 meters of elevation. The rest of the defense can now be laid in on this anchor point. Profiles for the other guns are constructed in the same

manner. If a profile of the entire frontage is required, take several profile lines and apply the data to the map.

---

## Section 13

### Machine Gunner's Mathematics

---

#### 61301. The Mil (A Unit of Angular Measure)

The machine gunner bases much of his work on the measurement and application of angles. The width of a target, for example, is measured by constructing an angle which has imaginary lines from the flanks of the target to the gunner's position (observer's position).

Angles can be measured in degrees, mils, and other units. In most cases, the mil is used for calculating firing data. The mil is a subdivision of a complete circle. There are 6,400 mils in a circle or approximately 17.8 mils in 1 degree. Conversely, 1 mil equals .05625 degrees.

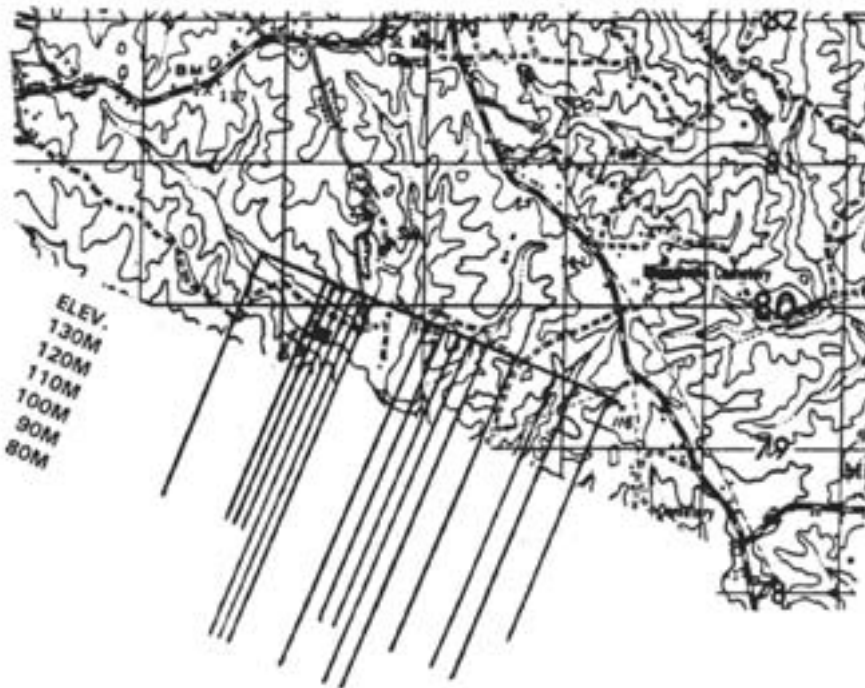

Figure 6-47. Marking of Elevation.

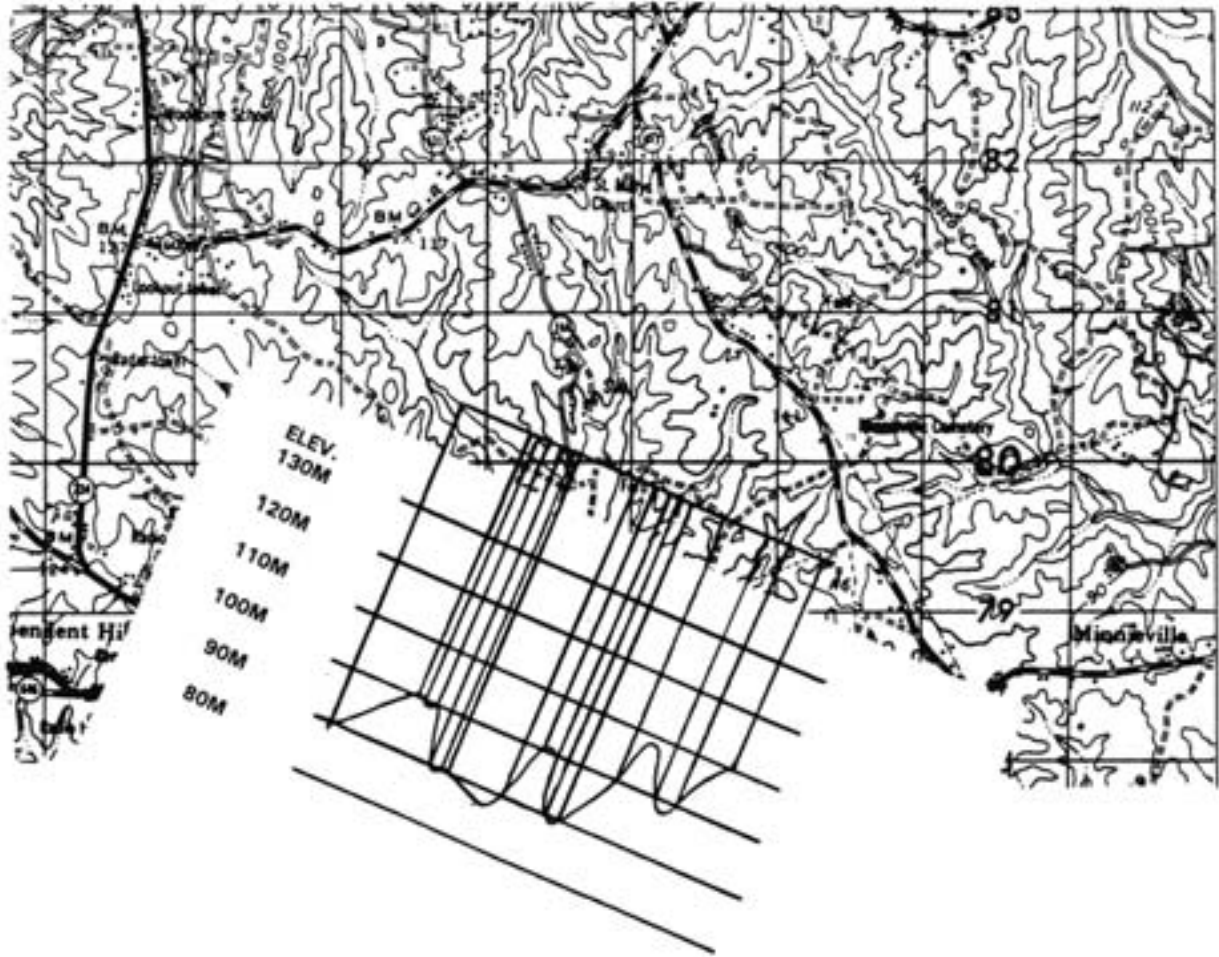
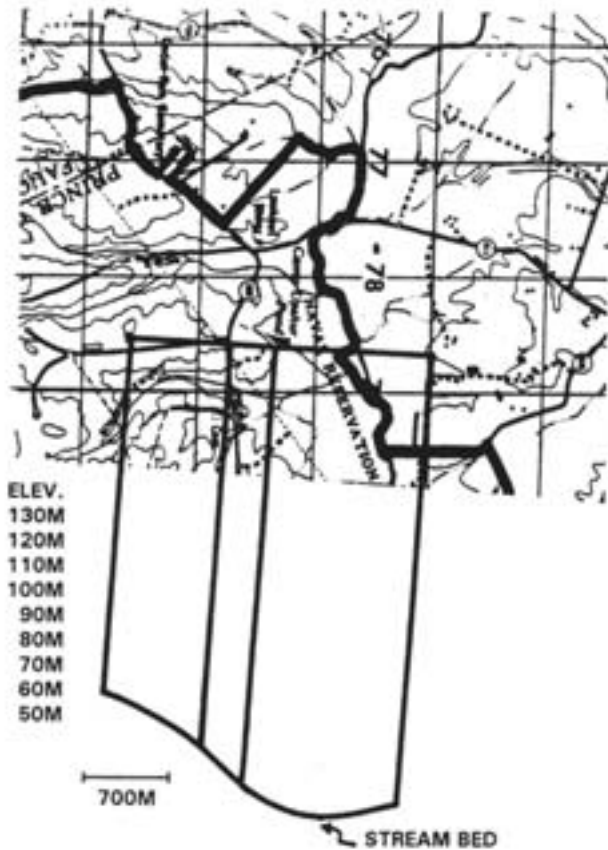

Figure 6-48. Terrain Profiling.



**Figure 6-49. Sample Terrain Profile.**

Because a constant mathematical relationship exists between angles and sides in a right-angled triangle, the mil is particularly useful in determining lateral distance when range is known and in determining range when the lateral distance is

known. For example, in figure 6-50, the distance from B to C measures 1 mil. If the range from A to B and C is 1,000 units (meters, yards, feet, etc.), the distance between B and C will be 1 unit (meters, yards, feet, etc.).

While the mil is not an exact mathematical calculation, the degree of error involved, in angles less than 350 mils, is considered negligible. For example, if the range to an enemy position is 1,000 meters and the position measures 25 mils wide, it follows that the enemy position is 25 meters wide.

It should be remembered that the number of mils in an angle can be determined in several ways. As previously discussed in chapter 5, section 4, the gunner may use binoculars, a compass, the traversing and deviating mechanism, or by using the hand/finger method.

### **61302. The Mil Formula (WERM Formula)**

Combining the above principles, a useful equation called the WERM formula has been developed.

$$\text{Width} = \text{Range} \times \text{Mils}$$

This may be expressed in several different ways mathematically. The most useful are:

$$W = R \times M$$

$$R = W/M$$

**where:**

**W = Width in meters**

**R = Range in thousands of meters**

**M = Mils**



**Figure 6-50. The Mil.**



Any one of the elements of the formula can be determined knowing the other two. For example, in figure 6-51, an observer desires to know the distance between two objects (A and B). He estimates the range to be 1,200 meters, and he reads the angle AOB with his binocular to be 40 mils. We know the following:

$R = 1,200/1,000 = 1.2$  (thousands of meters)  
 $M = 40$  mils;  
 $W = ?$

**Substituting in the formula:  $W = 1.2 \times 40$  or  
 $W = 48$  meters**

As stated previously, by knowing any two of the three variables in the WERM formula, the third may be calculated. In figure 6-52, an object is on the line of fire between the gun and the target. To determine if there is mask clearance, the gunner would estimate the range to the obstacle, measure the height of the obstacle in mils, and determine the height in meters by using the formula  $W = R \times M$ .

In figure 6-53, an observer desires to determine the range to a target without the use of a map. The target is an armored personnel carrier known to be 10 meters long. The gunner measures the width of the vehicle to

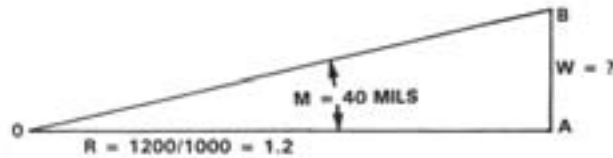

Figure 6-51. Estimating Distance Between Two Objects.

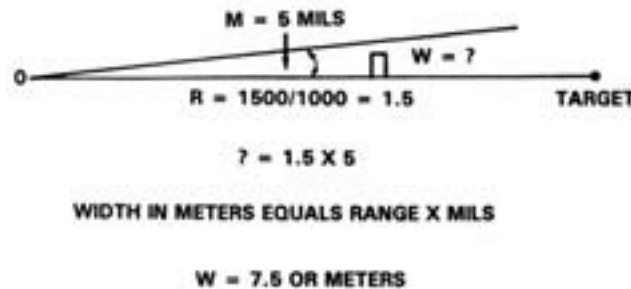

Figure 6-52. Estimating Mask Clearance.

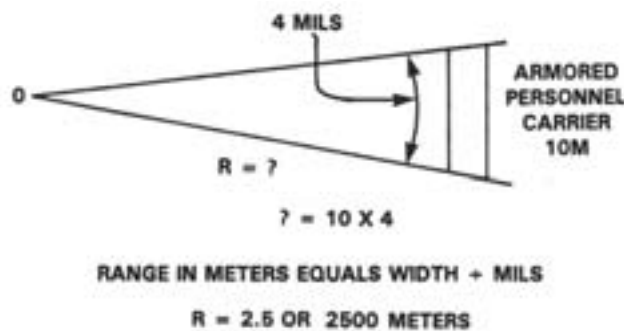

Figure 6-53. Estimating Range Using Known Width.

be 4 mils and determines the range by using the formula,  $R = W/M$ .

---

## Section 14 Antiaircraft Gunnery

---

Individual M2 .50 calcs can provide units with a self-defense capability against hostile low-flying, low-performance aircraft. These guns are employed in the air defense role as part of the unit's local defense. The machine guns are not components of an integrated and coordinated air defense system. Normally, the following rules for engagement apply:

- Attack aircraft identified as hostile.
- Attack aircraft committing a hostile act.

Unless otherwise directed, hostile aircraft within range of the gun (approximately 800 meters maximum effective range) should be engaged. Surveillance, reconnaissance, and liaison aircraft; troop carriers; helicopters and drones are typical targets.

### 61401. Employment

Employment of machine guns used for air defense is guided by the following defense design factors:

- The mission of air defense machine gun defense is to impose maximum attrition upon the attacking enemy.
- Machine gun defenses are designed to combat low-flying, low-performance aircraft.
- Defense design should produce an equally balanced defense that is effective in all directions, unless a forced route of aircraft approach exists. Defense design should weigh those routes of approach which are likely to be used.
- Machine guns should be sited so that the maximum number of targets can be engaged, continuous fire can be delivered, and the most likely routes of approach are covered.

Machine guns used to defend march columns should be interspersed in the convoy, with emphasis on the lead and rear elements. See figure 6-54.

Target selection and engagement control depend upon visual means. The sites selected for the guns must provide maximum observation and unobstructed sectors of fire. Units furnished M2 .50 calcs in sufficient numbers should site them within mutual support distances of 90 to 360 meters. Each gun is assigned a primary and secondary sector of fire. Weapon crews maintain constant vigilance in their primary sectors of fire, regardless of the sector in which the guns are actually engaged. For detailed coverage of aircraft recognition and identification, see FM 44-80, *Visual Aircraft Recognition*.

The M2 .50 cal is provided to forward area units on a table of allowance basis. Issue is determined by tactical considerations and type of unit (artillery, armor, engineer, infantry) concerned.

### 61402. Target Course Definitions

#### a. General. See figure 6-55.

- (1) **Course line.** The line along the course in which the target is flying.
- (2) **Midpoint.** The point along the course of any target at which the target is nearest the gun position.
- (3) **Approaching leg.** That part of the course in which the target is flying toward midpoint.
- (4) **Receding leg.** That part of the course in which the target is flying away from midpoint.
- (5) **Angle of approach.** The angle formed by the gun, present position of the target, and the course line. The angle of approach at midpoint is always 1,600 mils.

**b. Target Course Names.** Aircraft may fly any of the following types of courses (see figure 6-56):

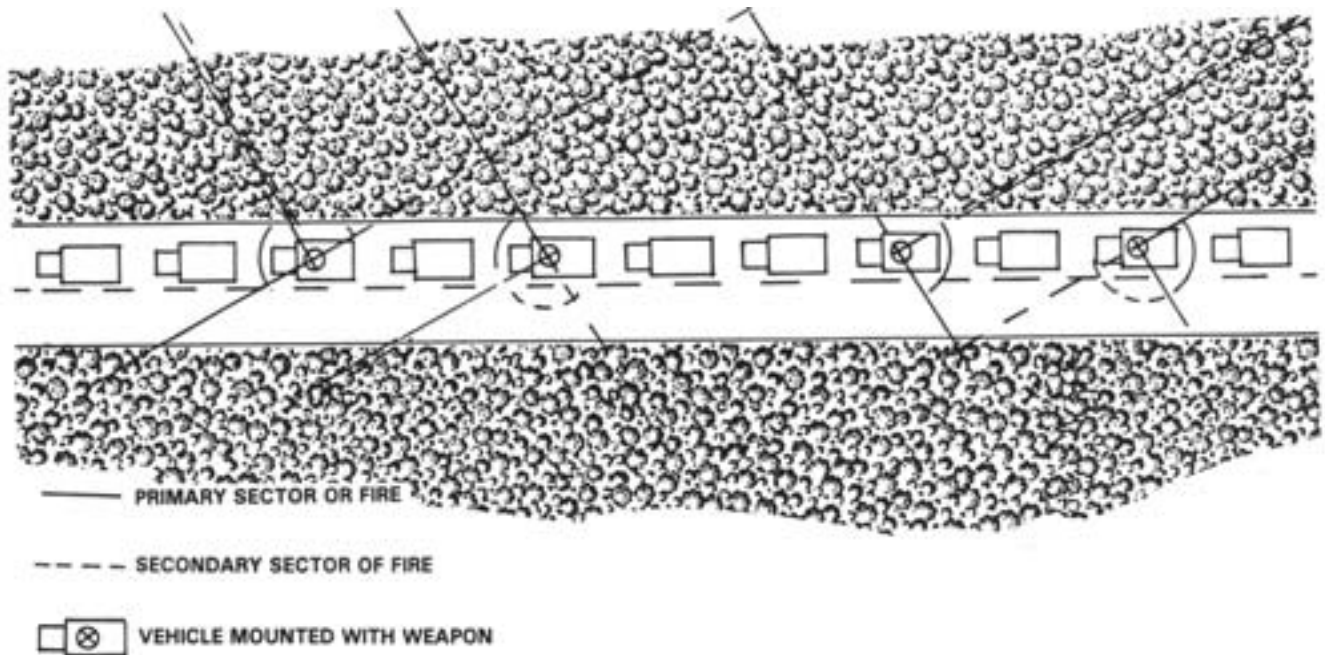

Figure 6-54. March Column with Four M2 .50 Cals (Added).

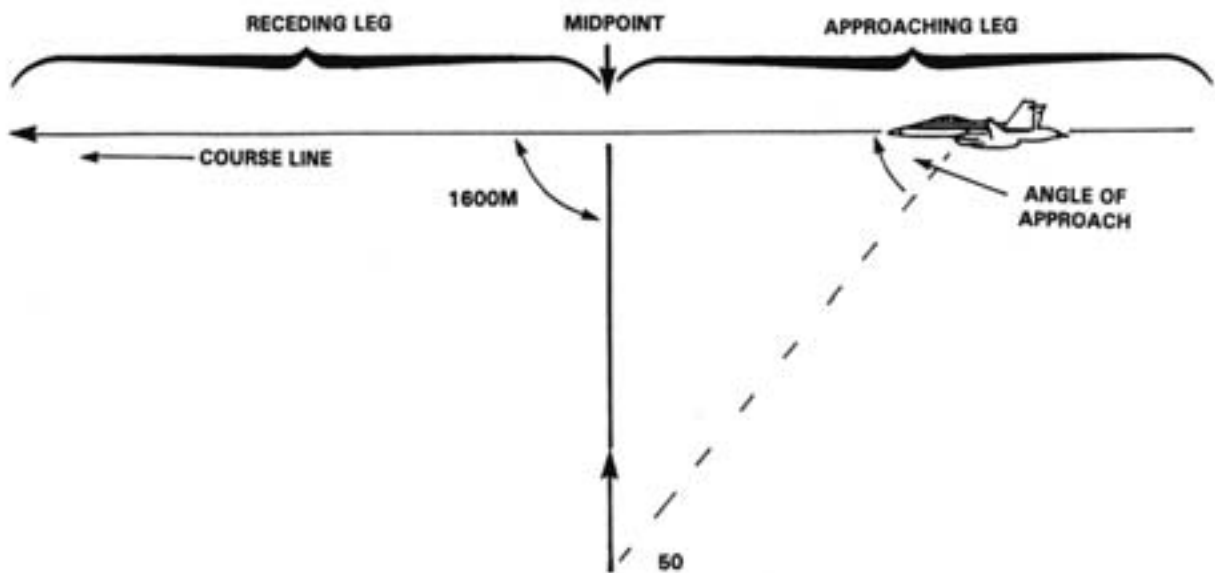

Figure 6-55. Diagram Showing Midpoint, Approaching Leg, and Receding Leg.

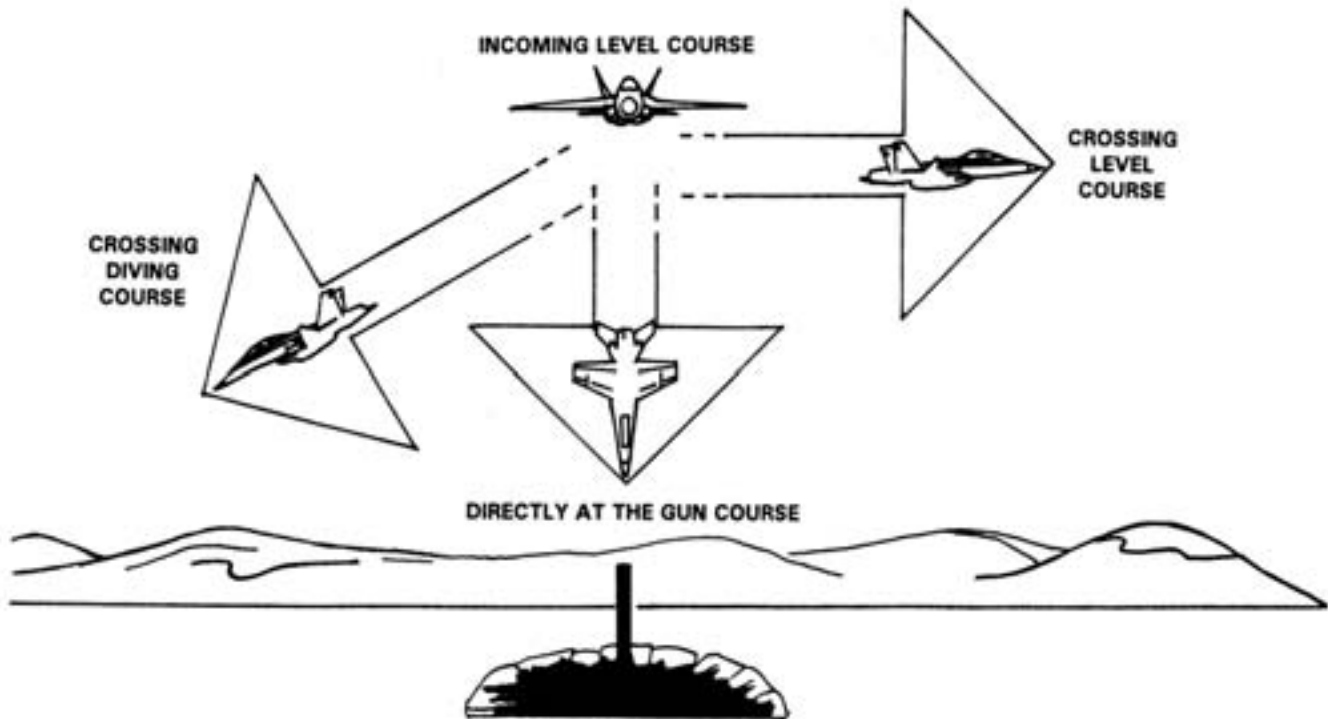

Figure 6-56. Target Course Names.

- (1) **Level.** In a level course, the target is flying at a constant altitude.
- (2) **Diving.** In a diving course, the target is flying with altitude decreasing.
- (3) **Climbing.** In a climbing course, the target is flying with altitude increasing.
- (4) **Incoming.** An incoming course is one in which the target will fly directly over the gun.
- (5) **Outgoing.** An outgoing course is one in which the target is flying away from the gun.
- (6) **Crossing.** A crossing course is any course not incoming or outgoing.
- (7) **Directly at the gun.** This type of course is one in which the target is flying toward the pintle center of the gun.

### 61403. Requirements for a Hit

To engage enemy aircraft effectively, the gunner must accurately estimate the future position of the target and point his gun in such a manner that the fired rounds and the aircraft will arrive at the estimated point at the same time. The problem can be compared to that of a machine gun firing up a hill. Laying the gun in elevation is accomplished by tracking the target. In figure 6-57, despite the fact that the vehicle is moving along the side of a hill, the machine gunner concerns himself with only a one-lead angle measured along the slope of the hill. If the vehicle is replaced by air space (see figure 6-58), it is apparent that the gunner's problem in figure 6-58 is identical to that in figure 6-57. (There is a faster speed in the case of the aircraft.) To hit the target, the gunner must fulfill two requirements—line and lead.

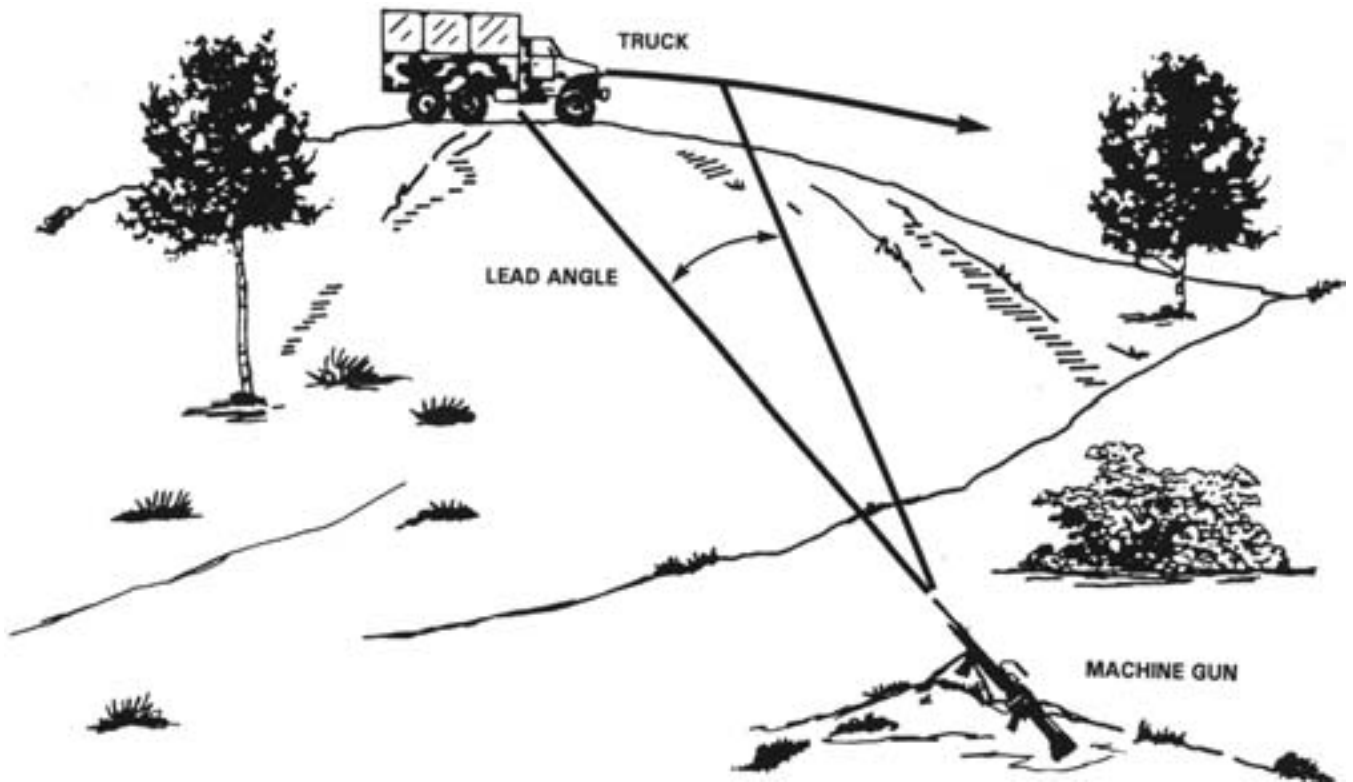

Figure 6-57. Lead Angle, Moving Ground Target.

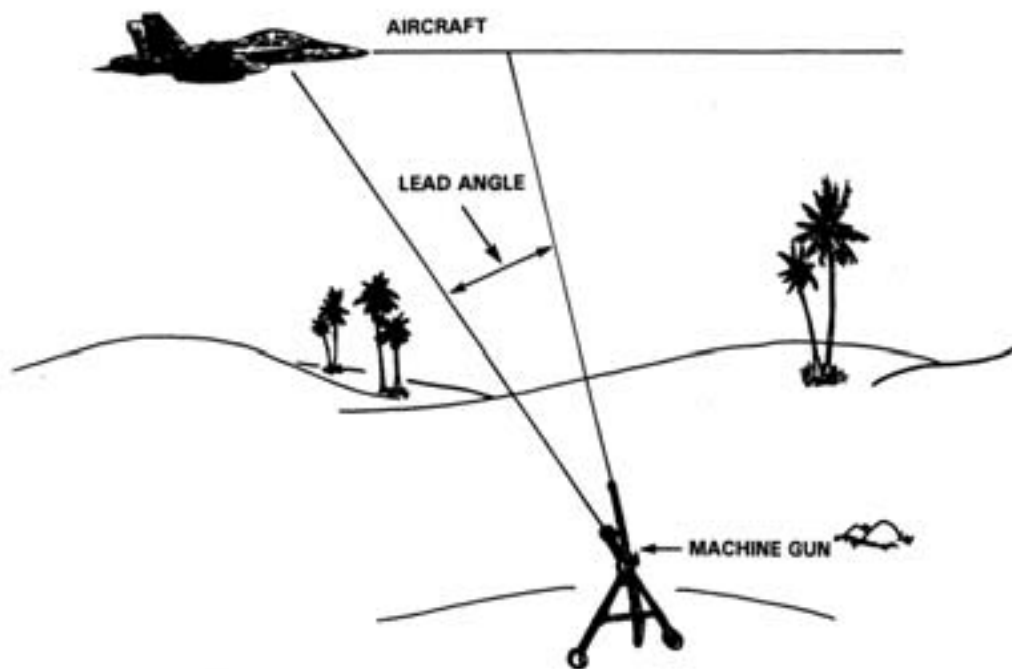

Figure 6-58. Lead Angle, Aerial Target.

**a. Line Requirement for a Hit.** The line requirement demands that the gunner cause the round to intersect the target course line. The vertical mass of the target affords the gunner a small angular (elevation) tolerance in fulfilling the line requirement. The size of this angle varies directly with the diameter of the fuselage and inversely with the range to the target.

**b. Lead Requirement for a Hit.** The lead requirement demands that the gunner cause the round to intersect the target. Angular tolerance in fulfilling the lead requirement is provided by the horizontal mass of the target. The magnitude of this angle varies directly with the length of the target fuselage and the sine of the angle of approach. It varies inversely with the range to the target.

#### 61404. Lead

The gunner has no sighting devices for setting initial leads on the M2 .50 cal on the M3 or vehicle mount. The discussion in this paragraph presents the magnitude of leads in anti-aircraft firing.

Prior to opening fire, the gunner estimates the amount his gun will lead the target. This estimate is based upon an understanding of the magnitude of the lead required under varying conditions of target speed, target range, and angle of approach. For example, a target, traveling 600 miles per hour, flies a crossing course that causes it to pass at a midpoint range of 460 meters from the gun position. To hit the aircraft at this midpoint, the gunner aims and fires his weapon at a point on the target course line 165 meters ahead of the target. (The time of flight for a caliber .50 round for a range of 460 meters is 0.6 second. A speed of 600 miles per hour is approximately 275 meters per second. During the time of flight of the projectile, the target will have traveled  $0.6 \times 275$  or 165 meters.) Using the mil relation rule, with a range of 460 meters and 165 meters as the distance traveled by the aircraft, the lead required to hit the target at midpoint is 360 mils.

Lead for specific midpoint ranges may be calculated on the basis of target speed. For a midpoint range of 460 meters, the midpoint lead required is 60 mils or 27 meters for each 100 miles per hour of target speed. The length of the target is a convenient unit of measure in establishing initial leads. The estimated lead is divided by the length of the target to determine the number of apparent target lengths which the gunner will lead the target. Midpoint leads expressed in meters, mils, and apparent target lengths for selected targets, target speeds, and midpoint ranges are contained in figure 6-59.

As the angle of approach increases up to midpoint, the amount of lead necessary also increases. When the target passes midpoint and continues on the receding leg, the amount of lead decreases, while the angle of approach continues to increase. The amount of lead necessary at midpoint is called full lead. Figure 6-59 is based on targets at or near midpoint.

Figure 6-60 gives the fraction of full lead necessary for various angles of approach.

To simplify the lead problem, the following rules may be used as a guide in determining initial leads:

- Crossing courses:
  - When the target is on the approaching or receding leg, open fire with a three-fourths full estimated lead.
  - When the target is at midpoint, open fire with a full estimated lead.
- Directly at the gun course: Open fire with no lead.
- All courses: Observe tracers and make corrections accordingly.

#### 61405. Target Engagement

**a. Sequence of Events.** The following are the gunner's actions to bring the target under fire:

- Estimate the necessary lead.

MIDPOINT LEADS (BASED UPON FTA 0.50-H-1)						
AIRCRAFT (TYPE)	AVERAGE LENGTH AIRCRAFT (METERS)	SPEED (MPH)	MIDPOINT RANGE (METERS)	MIDPOINT LEAD		
				Meters	Mils	Apparent Target Lengths*
Fighter	7	600	920	378	414	414
Fighter	7	600	460	165	360	18
Fighter	7	400	920	252	276	27.6
Fighter	7	400	460	109	240	12
Fighter	7	200	920	126	138	13.8
Fighter	7	200	460	54	120	6
Transport	21	200	920	126	138	6
Transport	21	200	460	54	120	2.6
Liaison	7	100	920	62	69	7.7
Liaison	7	100	460	27	60	3.3

\* Drop all fractions in estimating lead in target lengths.

Figure 6-59. Midpoint Leads.

ANGLE OF APPROACH IN MILS	LEAD
0 - 100 (Approaching Leg)	0
100 - 500 (Approaching Leg)	½
500 - 800 (Approaching Leg)	¾
800 - 1600 (Approaching Leg)	Full
1600 - 2400 (Approaching Leg)	½

Figure 6-60. Amount of Lead Necessary for Various Angles of Approach.

- Elevate the weapon until the axis of the bore is aligned with the target-course line and apply the estimated lead.
- Open fire and observe only the tracers in the vicinity of the target.
- Elevate or depress the gun until line shots are obtained.

- Correct the lead until hits are obtained, using tracer observation.

**b. Techniques.** The gunner fires continuously throughout the engagement. Since the large amount of smoke created by continuous fire tends to restrict visibility, the gunner keeps his head and eyes high above the gun to observe the tracers. When there is doubt as to the tracers positions, he increases his lead. It is important that the gunner initially opens fire with an adequate lead, and once established, his tracking is not reversed. If his initial lead is too great, the tracking rate is slowed and he allows the target to catch up with his tracers.

The dispersion cone is excessive when the gun is fired as a free weapon. To offset this, the gunner seizes the grips firmly with both hands and braces the gun with his body. When firing from the vehicle mount, the gunner stands erect and makes changes in elevation by moving his hands and arms up and down. For a change in azimuth, he shifts his feet and moves around the mount.

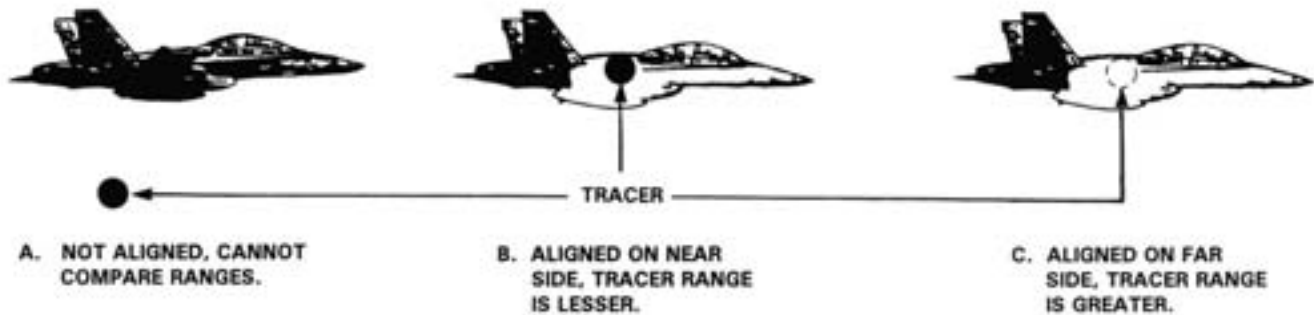

Figure 6-61. Superimposition.

### 61406. Tracer Observation

To make adjustments during firing, the gunner must know the location of the round with respect to the target. Tracer ammunition provides this information. However, the gunner must be trained to observe tracers correctly to produce a hit. Where target courses and target speeds can be fixed, valid lead data is obtained from a tracer observer located down course from the gun (see FM 44-2, Air Defense Artillery Employment Automatic Weapons M42/M55). Under normal conditions, valid sensings are obtained only if the tracer observer is stationed as close to the gun as possible.

#### a. Principles

(1) **Superimposition.** In observing tracers, the gunner utilizes the principle of superimposition. By aligning the tracer with the target, the gunner compares the range from his eye to the target and from his eye to the tracer. In figure 6-60, it can be seen that regardless of the range to the target, he can compare the range to the tracer and the range to the target as long as the two are superimposed. Lead can be judged on the basis of these comparisons. Because of the common tendency of gunners to attempt to judge lead when tracers are not aligned with the target, the first basic principle of tracer observation must be stressed. Fulfill the line requirement before attempting to judge lead.

(2) **Localized vision.** In figure 6-61, the tracer is shown as a single spot in the sky, moving directly away from the gunner's eye. In actual practice, the tracer does not appear as a fixed spot, but rather as a curved path (see figure 6-62). This apparent curvature of the tracer path is

called the illusion of curvature. Once a round is fired, it moves in a straight line directly away from the gun. Gravity causes the trajectory to curve down toward the earth; but under no conditions, other than wind or drift, does the round move to the left or right. The illusion of curvature occurs because the gunner is concentrating upon a moving reference point, the target. As the tracer moves along its path, the distance between the target and the tracer is reduced to the point that the eye relates the two separate motions. The illusion of curvature then takes place. The point of maximum apparent curvature is referred to as the tracer hump. Here, the tracer path appears to curve sharply into a direction opposite from that in which the target is moving. The gunner must focus his attention on the immediate vicinity of the target, just as if he were looking through a telescope with a restricted field of view (see figure 6-63). The gunner's (observer's) vision must be localized to the immediate vicinity of the target.



Figure 6-62. Illusion of Curvature.





**Figure 6-63. Localized Vision.**

(3) **Read nose-to-tail.** In certain types of target courses, particularly incoming and outgoing, the tracer may intersect the gunner's line of vision to the target in two places. Here, the gunner first sees the tracer passing the target in a tail-to-nose direction. Lead information, based upon a sensing of a tracer that appears to pass the target in this direction, is invalid. The target actually crosses the tracer path only once, entering the path nose first and leaving tail last. Because of the illusion of curvature, the gunner sees this passage when the tracer appears to float by the target in a nose-to-tail direction. Lead when the tracer passes the target nose-to-tail.

**b. Line Information**

**(1) Level and nonlevel crossing courses**

(a) *High.* When the tracer is above the target course line. See figure 6-64A.

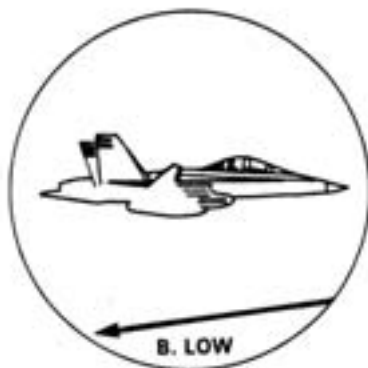

**Figure 6-64. Line and Lead Information, Based on Tracer Sensings.**

(b) *Low.* When the tracer is below the target course line. See figure 6-64B.

(c) *Line.* When the tracer intersects a line from the gunner's eyes, through the target to infinity. This line might be described as the gunner's line of vision through the target to infinity (see figures 6-64C and 6-64D). In referring to a tracer that is aligned with the target, the term line is omitted, and only the lead sensing is mentioned. (The tracer must be aligned with the target before a lead sensing can be made.)

(2) **Other Courses.** For incoming, outgoing, directly at the gun, and very steep diving courses, off-line sensings change from high or low to left and right. See figure 6-65.

### c. Lead Information

(1) **Ahead.** If the tracer intersects the gunner's line of vision beyond the target; i.e., if a portion of the tracer's path is hidden by the target the round is ahead, the lead is too great. See figure 6-64C.

(2) **Astern.** If the tracer passes between the gunner's eye and the target, the sensing is astern or too little lead. See figure 6-64D.

(3) **Hit.** If the tracer path terminates in the target itself, the sensing is lead correct, a hit. See figure 6-66.

---

## Section 15

### Firing Positions

---

As time permits, machine gun crews prepare primary, alternate, and supplementary firing positions that provide cover and concealment without restricting effective fire.

In any of the positions described in this section, the gun is lowered by digging firing platforms where the gun will be placed. The platforms must not be so low that the gun cannot be traversed across its sectors of fire. Lowering the gun reduces the height of frontal cover needed.

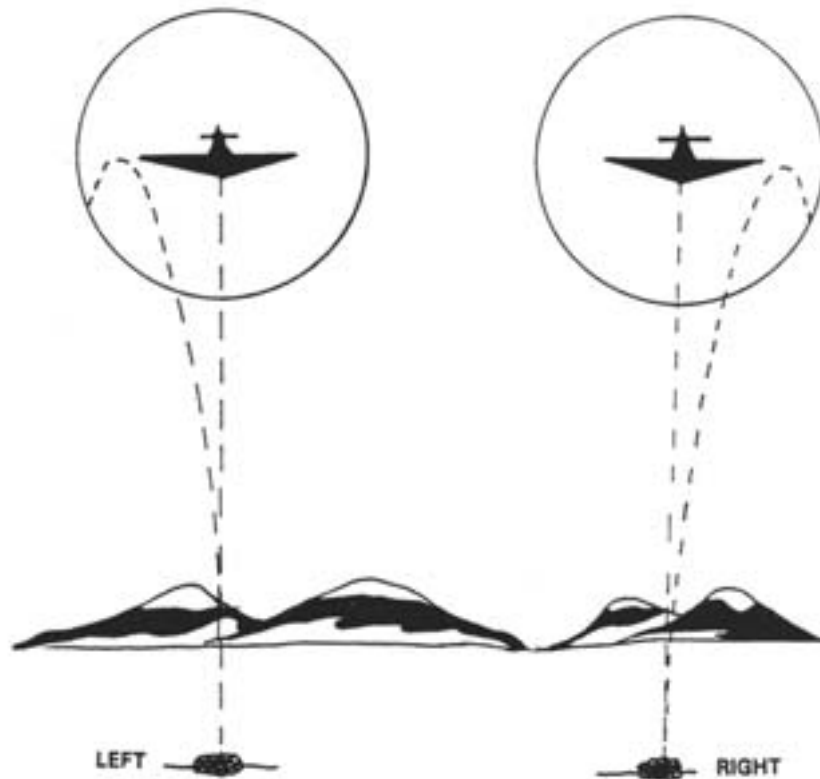

**Figure 6-65. Off-Line Tracer Sensings for Incoming, Outgoing, Directly at the Gun, and Very Steep Diving Course.**



**Figure 6-66. A Hit.**

In a 3-man crew, the ammunition bearer digs a 1-man fighting position to the flank where he can provide security for the gun, observe and fire into the crew's primary and alternate sectors of fire, and also see the gunner and assistant gunner. The ammunition bearer's position must be close enough to the gun position to allow him to bring ammunition or replace one of the gunners. When possible, the two positions are connected by a crawl trench.

### 61501. T-Shaped Position

The T-shaped position is the preferred type of firing position. This position provides primary and alternate sectors of fire and cover to the front. The primary sector of fire is usually to the oblique so the gun can fire lengthwise across the unit's front. See figures 6-67, 6-68, and 6-69.

With the M240G, the tripod is used on the side that covers the primary sector of fire and the bipod legs are used on the side that covers the secondary sector of fire. When changing from primary to secondary sectors, the machine gun is moved but the tripod stays in place.



**Figure 6-67. T-Shaped Position; Firing Primary Sector.**



**Figure 6-68. Firing Secondary Sector.**



**Figure 6-69. Digging T-Shaped Position.**



**Figure 6-70. No Secondary Section (L-Shaped Position).**

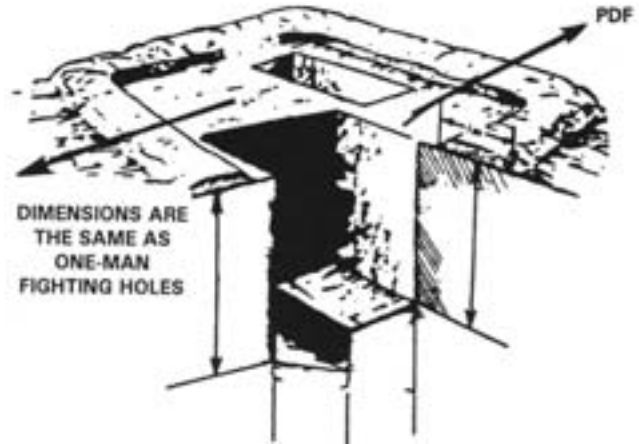

**Figure 6-72. Two-Hole Machine Gun Position.**

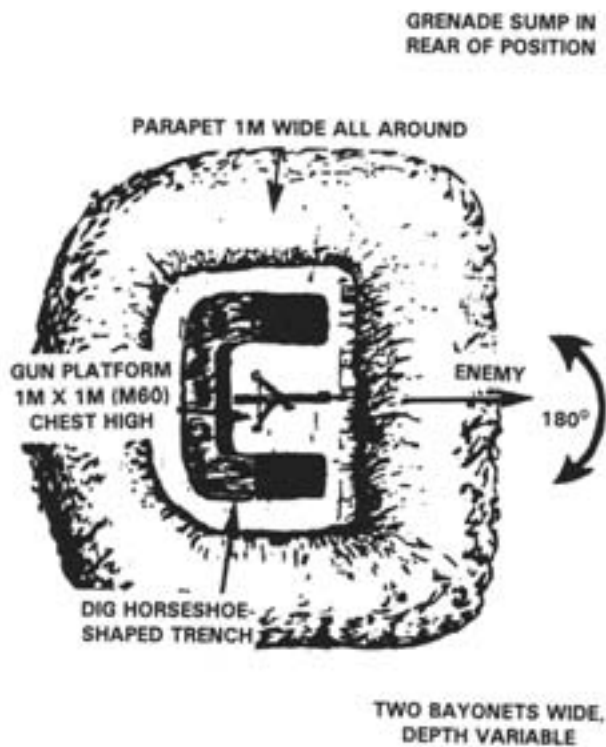

**Figure 6-71. Horseshoe-Shaped Machine Gun Position.**

The hole is dug about armpit deep. When frontal cover is high and thick enough, the spoilage is used to build flank and rear cover. Grenade sumps should be located at the end of each leg of the position. When only one sector of fire is assigned, only half the position is dug. See figure 6-70.

### 61502. Horseshoe-Shaped Position

The open end of the horseshoe is toward the enemy. This type of position allows for easy 180-degree traverse across the front but provides less frontal cover than the T-shaped position and less protection against indirect fire than the 2-hole position. The firing platform is located within the horseshoe. Spoilage is used to provide cover all around the position. See figure 6-71.

### 61503. Two-Hole Position

This position uses two one-man fighting holes at 90-degree angles. This position provides excellent protection for the gunner and assistant gunner but allows for only limited traverse of the gun. Each hole is dug as a standard one-man hole. When switching from the primary to the alternate sector of fire, the gunner and the assistant gunner switch roles. See figure 6-72.

## Section 16

### Wire Communication

In the defense, wire communication is preferred over the use of radios in controlling defensive fires because it is more secure and less vulnerable to the problems associated with the electro-magnetic spectrum such as interruption or degradation as a result of weather conditions. Machine gun positions, as key elements in the defense, should be connected to leaders in the chain of command, especially with the individual with authority to order the firing of the final protective fires. While wiremen and/or other communications personnel may be available to assist in wiring the gun positions, machine gunners should know how to conduct this task on their own. Once the defense has been set and the guns positioned, the gun section should be wired in immediately.

#### 61601. Equipment

The following is a list of the gear and equipment normally required to do this:

- WD-1/TT or WD-1A on reel, one each.
- Operational 2-wire tactical field telephone, four each.
- Tool equipment, TE-33.
- Site where field wire can be laid.
- Reel unit (RL-31E or CE-11), one each (as required).
- Tag, four each, pre-prepared.
- Stake, four each (as required).
- Hammer, one each (as required).

#### 61602. Installing a Field Wire Loop

Perform the following steps to install a field wire loop:

- Lay out the field wire from position A to each position in turn, until all positions are connected; complete the loop by returning to position A. See figure 6-73.

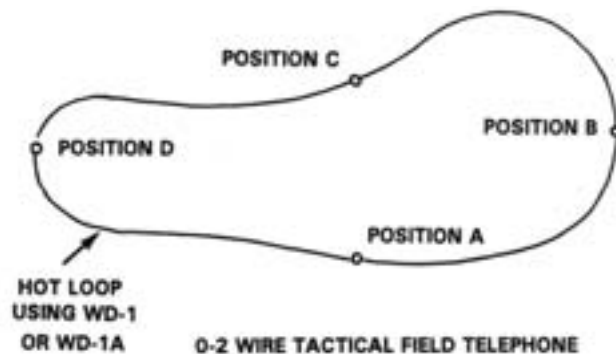

**Figure 6-73. Installation of the Wire Loop.**

- Keep the wire behind the individual positions.
- Tie the wire to a fixed object, or stake, near each position and leave enough slack in the wire for connections.
- Connect the two-wire tactical telephone at position A to the wire loop. First, strip 1/2 inch of insulation off the two wires at each end of the wire loop. Then, connect one of the wires from each end of the wire loop to one binding post of this telephone and the other wire from each end of the loop to the other binding post. See figure 6-74.

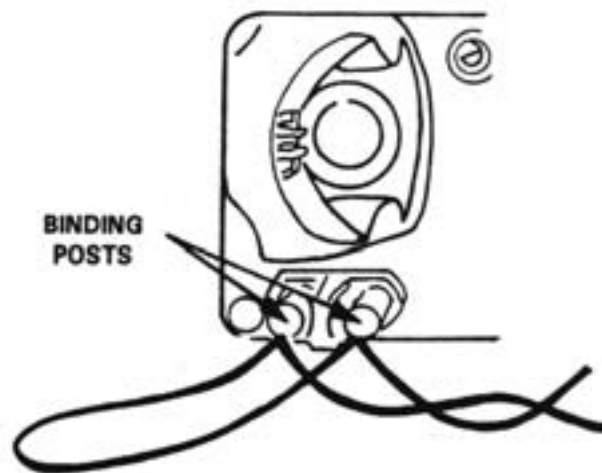

**Figure 6-74. Connection of the Wire Loop.**

- Connect the other telephones to the wire loop. Go to each position and pick up the wire. Cut the insulation on one conductor without cutting the wire strands. Use the TL-13-A pliers or TL-29 knife. Grasp the insulation on either side of the cut and pull the insulation apart to expose 1/2 inch of wire strands on each conductor. See figure. 6-75.
- Repeat these steps on the other conductor. Slide an exposed 1/2 inch section of one conductor into one binding post of the telephone. Slide the exposed 1/2 inch section of the other conductor into the other binding post of the telephone. Repeat these steps until each telephone is connected in the wire loop.
- Conduct a communications check. Use any telephone connected to the wire loop to ring down the circuit. If all positions ring, and are able to answer

and be heard, the wire loop is installed correctly. If any position does not then the connections need to be checked and the line tried again.

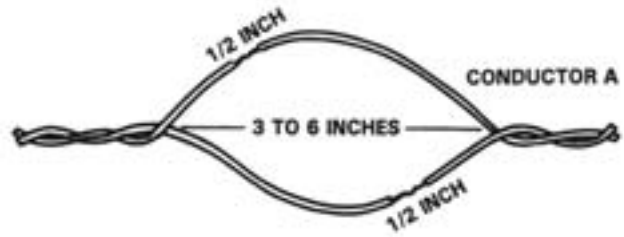

**Figure 6-75. Connection of Other Telephones to the Wire Loop.**

## Appendix A

# M60E3/M240G Firing Tables

### Table I

#### **Angles of Elevation, Dimension of Cone and Beaten Zone, Angles of Fall, Time of Flight, and Drift—How to Use**

The angle of elevation required to engage a target on flat or uniformly sloping ground is listed for the indicated ranges.

The mil difference between two successive angles of elevation has been calculated to permit subsequent changes in the quadrant elevation without recalculation.

The vertical 100 percent cone, effective 82 percent beaten zone, angle of fall, and time of flight are listed to assist in determining effect on target.

For ranges not in even hundreds and for ranges not tabulated, the desired information must be determined by interpolation.

Example: the range to the target is 1,000 meters. The angle of elevation is 16.2 mils. The difference between the AE of 900 meters and 1,000 meters is 3.1 mils. The vertical 100 percent cone is 3.3 mils or 3.2 meters. The effective 82 percent beaten zone is 2 mils and 2 meters wide as well as 50 meters long. The angle of fall is 33 mils and the time of flight to the target is 2.11 seconds.

Table I

**Angles of Elevation, Dimension of Cone and Beaten Zone,  
Angles of Fall, Time of Flight, and Drift—How to Use**

Cartridge, Ball, M59

FT 7.62-A-2

Range	Angle of Elevation	Difference	Effective 82% Beaten Zone							
			Vertical 100% Cone		Width		Length		Angle of Fall	Time of Flight
			mil	m	mil	m	m	m		
100	0.7		2.7	0.3					1	0.13
200	1.6	0.9	2.4	0.5					2	0.27
300	2.6	1.0	2.1	0.6					3	0.42
400	3.7	1.1	2.4	0.9					5	0.58
500	5.0	1.3	2.4	1.2	2	1	86		7	0.76
600	6.5	1.5	2.5	1.5					10	0.97
700	8.3	1.8	2.7	1.8					14	1.21
800	10.5	2.2	2.8	2.2					19	1.48
900	13.1	2.6	3.1	2.7					26	1.78
1000	16.2	3.1	3.3	3.2	2	2	50		33	2.11
1100	19.9	3.7	3.6	3.9					42	2.46
1200	24.1	4.2	3.8	4.5					51	2.83
1300	28.8	4.7	4.1	5.2					61	3.22
1400	34.0	5.2	4.4	6.0					72	3.63
1500	39.7	5.7	4.7	6.9	2	3	42		84	4.06
1600	45.9	6.2	5.1	7.9					97	4.51
1700	52.6	6.7	5.4	9.1					111	4.98
1800	59.9	7.3	5.9	10.5					128	5.37
1900	67.8	7.9	6.4	12.0					146	5.99
2000	76.4	8.6	7.0	13.8	2	4	42		166	6.54
2100	85.8	9.4	7.6	15.7					188	7.12
2200	96.1	10.3	8.4	18.0					213	7.73
2300	107.3	11.2	9.0	20.4					240	8.38
2400	119.4	12.1	10.0	23.4					271	9.06
2500	132.5	13.1	10.8	26.5	3	6	43		304	9.78
2600	146.8	14.3	11.9	30.3					341	10.54
2700	162.5	15.7	13.0	34.5					381	11.35
2800	179.9	17.4	14.4	39.4					425	12.25
2900	199.2	19.3	15.9	45.3					475	13.15
3000	220.6	21.4	17.6	51.8	3	9	46		527	14.15
3100	244.4	23.8	19.8	60.2					585	15.23
3200	271.1	26.7	22.1	69.4					648	16.41
3300	301.7	30.6	25.1	81.3					716	17.72
3400	337.7	36.0	28.5	95.1					790	19.20
3500	381.2	43.5	33.1	113.9	3	12	50		871	20.91
3600	437.4	56.2	39.1	138.2					962	23.04
3700	532.7	95.3							1088	26.42
3725	608.5	75.8							1167	28.96



Table II

## Overhead Fire—How to Use

*Troop distance* in column 1 is the distance in meters from the gun to the friendly troops over whose heads it is desired to fire.

The quadrant elevation required to strike the ground upon which the troops stand, plus a definite angle of safety gives the *minimum quadrant elevation* which can be fired, without danger, over the troops.

The safety angle varies with the range. The minimum quadrant elevation which can be fired with safety over the heads of friendly troops comprises the following factors:

- Safety angle (corresponding to troop distance).
- Angle of elevation (corresponding to troop distance).
- Angle of site.

The safety angle plus the angle of elevation constitutes the *minimum angle of elevation* which can be fired over

the heads of troops at the given troop distance. Minimum angles of elevation are listed in column 2.

*Corresponding range* in column 3 is the minimum range expressed in graduations on the rear sight that will give the required clearance. Both the exact and even figures to the nearest 25 meters above are given. When troops to be fired over are visible, the safety angle can be measured by setting the corresponding range (even figures should be used).

Example: Friendly troops are visible and at a distance of 700 meters from the gun. The gun is laid to hit the target. Without disturbing the lay of the gun, the rear sight is set at 1,225 meters. In order that it be safe to fire, the line of aim must clear the troops.

**Note:** The current sight only displays a range up to 1,800 meters. For ranges beyond 1,800 meters, the procedures outlined in appendix F should be utilized.

**Table II**  
**Overhead Fire—How to Use**

Cartridge, Ball, M59

FT 7.62-A-2

1		2		3	
		Correspondence Range			
Troop Distance	Minimum Angle of Elevation	Difference	Exact Figure	Even Figure (To Nearest 25 Above)	
meters	mils	mils	meters	meters	
100	77.0		2006	2025	
200	40.6	-36.4	1515	1525	
300	29.5	-11.1	1314	1325	
400	25.1	-4.4	1222	1225	
500	23.3	-1.8	1182	1200	
600	23.2	-0.1	1178	1200	
700	25.0	1.8	1220	1225	
800	27.9	2.9	1280	1300	
900	31.5	3.6	1351	1375	
1000	35.8	4.3	1432	1450	
1100	41.2	5.4	1524	1525	
1200	47.1	5.9	1618	1625	
1300	53.9	6.8	1718	1725	
1400	61.6	7.7	1821	1825	
1500	70.0	8.4	1926	1950	
1600	79.6	9.6	2034	2050	
1700	90.0	10.4	2141	2150	
1800	101.9	11.9	2252	2275	
1900	114.7	12.8	2361	2375	
2000	128.8	14.1	2472	2475	
2100	144.2	15.4	2582	2600	
2200	161.6	17.4	2694	2700	
2300	181.3	19.7	2807	2825	
2400	203.7	22.4	2921	2925	
2500	228.5	24.8	3033	3050	
2600	256.9	28.4	3147	3150	
2700	289.2	32.3	3259	3275	
2800	328.0	38.8	3373	3375	
2900	375.5	47.5	3487	3500	
3000	438.4	62.9	3601	3625	

### Table III

#### Mask Clearance—How to Use

*Mask distance* in column 1 is the distance in meters from the gun to the highest point of the mask. The minimum quadrant elevation which will clear a mask is such that the lowest shot in the cone will just graze the highest point on the mask. Such a quadrant elevation comprises the following factors:

- Angle of clearance (corresponding to mask distance).
- Angle of elevation (corresponding to mask distance).
- Angle of site to mask.

The angle of clearance is based on the lower one-half of the vertical dimension of the cone. The angle of clearance plus the angle of elevation constitute the *minimum angle of elevation* which will afford clearance at any given mask distance.

Minimum angles of elevation are listed in column 2. If the quadrant elevation to the target

equals or exceeds the minimum quadrant elevation, clearance exists.

*Corresponding range* in column 3 is the mil angle of required mask clearance expressed in graduations on the rear sight. When the mask is visible, the required mask clearance can be measured by setting the corresponding range on the rear sight.

Example: The mask is visible and is at a distance of 700 meters from the gun. The gun is laid to hit the target; without disturbing the lay of the gun, the rear sight is set at 810. If the *line of aim* clears the mask, it is practicable to fire.

**Note:** The current sight only displays a range up to 1,800 meters. A new sight is currently under development. For ranges beyond 1,800 meters, the procedures outlined in appendix F should be utilized.

**Table III**  
**Mask Clearance**

1		2		3	
Mask Distance	Minimum Angle of Elevation	Difference		Correspondence Range	
		Mils	Mils	Meters	Nearest 10 Meters
100	2.41	3	1	289	290
200	3.37	4	1	370	370
300	4.47	5	1	454	460
400	5.57	6	1	538	540
500	6.7	7	1	625	630
600	8.67	8	1	717	720
700	8.56	9	1	810	810
800	12.94	13	4	896	900
900	15.76	16	3	986	990
1000	19.23	20	4	1082	1090
1100	22.71	23	3	1176	1180
1200	27.57	28	5	1274	1280
1300	32.44	33	5	1370	1370
1400	37.7	38	5	1465	1470
1500	43.54	44	6	1562	1570
1600	49.78	50	6	1658	1660
1700	56.68	57	7	1756	1760
1800	64.08	65	8	1853	1860
1900	72.35	73	8	1953	1960
2000	81.47	82	9	2054	2060
2100	91.56	92	10	2156	2160
2200	102.8	103	11	2260	2260
2300	114.80	115	12	2362	2370
2400	127.91	128	13	2465	2470
2500	142.36	143	15	2569	2570
2600	158.41	159	16	2674	2680
2700	176.44	177	18	2779	2780
2800	196.11	197	20	2884	2890
2900	218.46	219	22	2990	2990
3000	242.49	243	24	3092	3100

**Table IVa****Target Above Gun—How to Use**

This table combines the angle of sight with the angle of elevation when the target is above the gun and gives directly the quadrant elevation in mils. For ranges not in even hundreds, and for vertical intervals (VI's) not tabulated, the elevation must be determined by interpolation

Example: The range to the target is 1200 meters. The VI is +30 meters. In the column headed 1200, look opposite the number 30 in the column headed VI. The quadrant elevation is 50.4 mils.

**Table IVa**  
**Quadrant Elevation in Mils, Knowing Range, and Vertical Interval in Meters—Target Above Gun**

VI in Meters	Horizontal Distance From the Gun in Meters														
	100	200	300	400	500	600	700	800	900	1000	1100	1200	1300	1400	1500
100	800.7	473.9	330.4	253.4	206.4	175.2	153.5	138.2	127.2	119.5	114.2	110.9	109.2	108.9	109.8
95	774.6	453.3	315.0	241.4	196.5	166.9	146.4	131.9	121.6	114.4	109.5	106.6	105.2	105.2	106.3
90	747.2	432.3	299.5	229.3	186.7	158.6	139.2	125.6	115.9	109.3	104.9	102.3	101.3	101.5	102.9
85	718.3	411.0	283.9	217.1	176.8	150.3	132.0	119.3	110.3	104.2	100.2	98.0	97.3	97.8	99.4
80	688.0	389.2	268.1	204.9	166.9	141.9	124.8	112.9	104.6	99.0	95.5	93.7	93.3	94.1	95.9
75	656.2	367.1	252.2	192.6	156.9	133.6	117.6	106.6	99.0	93.9	90.9	89.4	89.3	90.3	92.4
70	622.8	344.6	236.1	180.3	146.9	125.2	110.4	100.2	93.3	88.8	86.2	85.1	85.3	86.6	88.9
65	587.8	321.7	220.0	167.9	136.9	116.8	103.1	93.9	87.6	83.7	81.5	80.8	81.3	82.9	85.4
60	551.2	298.5	203.7	155.5	126.8	108.3	95.9	87.5	81.9	78.5	76.8	76.4	77.3	79.1	81.9
55	512.9	275.0	187.3	143.0	116.8	99.9	88.6	81.1	76.2	73.4	72.1	72.1	73.3	75.4	78.4
50	473.0	251.1	170.8	130.5	106.7	91.5	81.4	74.7	70.5	68.2	67.4	67.8	69.2	71.6	74.9
45	431.4	227.0	154.3	117.9	96.6	83.0	74.1	68.3	64.8	63.0	62.7	63.4	65.2	67.9	71.4
40	388.3	202.7	137.6	105.3	86.5	74.5	66.8	62.0	69.1	57.9	57.9	59.1	61.2	64.1	67.8
35	343.7	178.1	120.9	92.7	76.3	66.1	59.5	55.5	53.4	52.7	53.2	54.7	57.1	60.3	64.3
30	297.6	153.3	104.1	80.0	66.1	57.6	52.2	49.1	47.6	47.5	48.5	50.4	53.1	56.6	60.8
25	250.3	128.3	87.3	67.3	56.0	49.1	44.9	42.7	41.9	42.3	43.7	46.0	49.0	52.8	57.2
20	201.8	103.1	70.4	54.6	45.8	40.5	37.6	36.2	36.1	37.1	39.0	41.6	45.0	49.0	53.7
15	152.4	77.8	53.5	41.9	35.6	32.0	30.2	29.8	30.4	31.9	34.2	37.2	40.9	45.2	50.1
10	102.2	52.5	36.5	29.1	25.4	23.5	22.9	23.3	24.6	26.7	29.4	22.8	36.8	41.4	46.5
05	51.6	27.0	19.5	16.4	15.2	15.0	15.6	16.8	18.8	21.5	24.7	28.4	32.7	37.6	43.0

**Table IVb**  
**Target Below Gun—How to Use**

This table combines the angle of site with the angle of elevation when the target is below the gun and gives directly the quadrant elevation in mils. For ranges not in even hundreds for VI's not tabulated, the elevation must be determined by interpolation.

Example: The range to the target is 1200 meters. The VI is -30 meters (target below gun). In the column headed 1200, look opposite the number 30 in the column headed VI. The quadrant elevation is -2.6 mils.

**Table IVb**  
**Quadrant Elevation in Mils, Knowing Range, and Vertical Interval in Meters—Target Below Gun**

VI in Meters	Horizontal Distance From the Gun in Meters														
	100	200	300	400	500	600	700	800	900	1000	1100	1200	1300	1400	1500
-5	-50.1	-23.8	-14.4	-9.0	-5.2	-2.0	.9	3.9	7.3	11.0	15.1	19.6	24.6	30.0	35.8
-10	-100.8	-49.2	-31.3	-21.7	-15.4	-10.5	-6.3	-2.4	1.5	5.7	10.3	15.2	20.4	26.1	32.2
-15	-150.9	-74.6	-48.3	-34.7	-25.5	-19.0	-13.6	-8.8	-4.2	.4	5.4	10.7	16.3	22.3	28.6
-20	-200.3	-99.9	-65.2	-47.2	-35.7	-27.5	-20.9	-15.2	-9.9	-4.7	.6	6.3	12.2	18.4	25.0
-25	-248.8	-125.0	-82.1	-59.9	-45.9	-35.9	-28.1	-21.5	-15.5	-9.8	-4.1	18	8.0	14.5	21.4
-30	-296.1	-150.0	-98.9	-72.5	-56.0	-44.4	-35.4	-27.9	-21.2	-14.9	-8.7	-2.6	3.9	10.6	17.7
-35	-342.2	-174.8	-115.7	-85.2	-66.2	-52.9	-42.7	-34.2	-26.8	-19.9	-13.3	-6.8	-3	6.7	14.1
-40	-386.8	-199.4	-132.4	-97.8	-76.3	-61.3	-49.9	-40.6	-32.5	-25.0	-17.9	-11.0	-4.2	2.8	10.4
-45	-429.9	-223.8	-149.0	-110.4	-86.5	-69.8	-57.2	-46.9	-38.1	-30.1	-22.5	-15.3	-8.1	-1.0	6.7
-50	-471.5	-247.9	-165.6	-122.9	-96.5	-78.2	-64.4	-53.3	-43.8	-35.2	-27.2	-19.5	-12.1	-4.7	3.0
-55	-511.4	-271.7	-182.1	-135.5	-106.6	-86.6	-71.6	-59.6	-49.4	-40.3	-31.8	-23.7	-16.0	-8.3	-7
-60	-549.7	-295.2	-198.4	-147.9	-116.6	-95.0	-78.9	-65.9	-55.0	-45.3	-36.4	-28.0	-19.9	-11.9	-4.0
-65	-586.3	-318.4	-214.7	-160.3	-126.7	-103.4	-86.1	-72.3	-60.7	-50.4	-41.0	-32.2	-23.8	-15.5	-7.4
-70	-621.3	-341.3	-230.9	-172.7	-136.7	-111.8	-93.3	-78.6	-66.3	-55.5	-45.6	-36.4	-27.7	-19.2	-10.8
-75	-654.7	-363.8	-246.9	-185.1	-146.6	-120.2	-100.5	-84.9	-71.9	-60.5	-50.2	-40.6	-31.6	-22.8	-14.2
-80	-686.5	-385.9	-262.8	-197.3	-156.6	-128.5	-107.6	-91.2	-77.5	-65.6	-54.8	-44.9	-35.5	-26.4	-17.6
-85	-716.8	-407.0	-278.6	-209.5	-166.5	-136.8	-114.8	-97.5	-83.2	-70.6	-59.4	-49.1	-39.4	-30.0	-20.9
-90	-745.6	-429.0	-294.2	-221.7	-176.4	-145.1	-122.0	-103.8	-88.7	-75.7	-64.0	-53.3	-43.2	-33.6	-24.3
-95	-773.1	-450.0	-309.8	-233.8	-186.2	-153.4	-129.1	-110.0	-94.3	-80.7	-68.6	-57.5	-47.1	-37.3	-27.7
-100	-799.0	-470.6	-325.1	-245.8	-196.0	-161.7	-136.3	-116.3	-99.9	-85.7	-73.2	-61.7	-51.0	-40.9	-31.1



**Table V****Ordinates in Meters—How to Use**

The figures indicate the height in meters of the center of the cone above the line of site at any distance from the gun. The negative figures indicate the distance of the center of the cone below the line of site at any distance from the gun.

Example: At a range of 900 meters (column of figures at left) and at a distance of 700 meters from the gun (line of figures under distance from the gun), the center of the cone is 3 meters above the line of site.

**Table V—Part 1**  
**Ordinates in Meters**

Cartridge, Ball, M59

FT 7.62-A-2

Range Meters	Horizontal Distance From the Gun — Meters							
	100	200	300	400	500	600	700	800
0	0	0	0	-1	-2	-4	-6	-9
100	0	0	0	-1	-2	-3	-5	-8
200	0	0	0	-1	-2	-3	-5	-7
300	0	0	0	0	-1	-2	-4	-6
400	0	0	0	0	0	-1	-3	-5
500	1	1	1	1	0	-1	-2	-4
600	1	1	1	1	1	0	-1	-3
700	1	2	2	2	2	1	0	-2
800	1	2	3	3	3	2	1	0
900	2	3	4	4	4	4	3	2
1000	2	4	5	6	6	6	5	4
1100	2	4	6	7	8	8	8	7
1200	3	5	7	9	10	11	11	10
1300	3	6	9	11	13	14	14	14
1400	4	7	10	13	15	17	18	18
1500	4	8	12	15	18	20	22	23
1600	5	10	14	18	21	24	26	28
1700	6	11	16	20	24	27	30	33
1800	6	12	18	23	27	31	35	38
1900	7	14	20	26	31	36	40	44
2000	8	16	23	29	35	40	45	50
2100	9	18	26	33	39	45	51	57
2200	10	20	29	37	44	51	58	65
2300	11	22	32	41	50	58	66	74
2400	12	24	35	46	56	66	75	84
2500	14	27	39	51	63	74	85	95
2600	15	30	44	57	70	83	95	106
2700	17	33	49	64	78	92	106	119
2800	18	36	54	71	87	103	118	133
2900	20	40	60	79	97	115	132	149
3000	22	44	66	87	108	128	147	166
3100	25	49	73	97	120	142	164	185
3200	28	55	82	108	134	159	183	207
3300	31	62	92	121	150	178	206	233
3400	35	70	104	137	169	201	233	264
3500	41	80	119	157	194	231	267	302
3600	48	94	139	184	228	271	313	354
3700	57	115	172	228	284	339	393	446

**Table V—Part 1**  
**Ordinates in Meters (Continued)**

Cartridge, Ball, M59

FT 7.62-A-2

Horizontal Distance From the Gun — Meters								
900	1000	1100	1200	1300	1400	1500	1600	Range Meters
-12	-16	-21	-27	-35	-44	-54	-66	0
-11	-15	-20	-26	-34	-43	-53	-65	100
-10	-14	-19	-25	-33	-42	-52	-64	200
-9	-13	-18	-24	-32	-41	-51	-63	300
-8	-12	-17	-23	-30	-39	-49	-61	400
-7	-11	-16	-22	-29	-38	-48	-60	500
-6	-9	-14	-20	-27	-36	-46	-58	600
-4	-7	-11	-17	-25	-34	-44	-55	700
-2	-5	-9	-15	-22	-31	-41	-52	800
0	-3	-7	-12	-19	-27	-37	-48	900
2	0	-4	-9	-15	-23	-32	-43	1000
5	3	0	-5	-11	-18	-27	-37	1100
9	7	4	0	-6	-13	-21	-31	1200
13	12	9	5	0	-7	-15	-25	1300
18	17	15	11	6	0	-8	-18	1400
24	23	21	18	13	7	0	-9	1500
29	29	28	25	21	16	9	0	1600
35	36	35	33	30	25	18	10	1700
41	42	42	41	39	35	29	21	1800
47	49	50	50	48	45	40	33	1900
54	57	59	60	59	56	52	46	2000
62	66	69	71	71	69	65	60	2100
71	76	80	83	84	83	80	76	2200
81	87	92	96	98	98	96	93	2300
92	99	105	110	113	114	113	111	2400
104	112	119	125	129	131	132	131	2500
117	126	134	141	147	151	153	153	2600
131	142	152	160	167	172	176	178	2700
147	160	171	181	189	196	201	205	2800
165	179	192	204	214	222	229	234	2900
184	200	215	229	241	251	260	267	3000
205	224	241	257	271	284	295	304	3100
230	251	271	289	306	322	336	347	3200
259	283	306	327	347	366	383	397	3300
293	321	348	373	397	419	439	457	3400
336	369	401	431	459	485	509	531	3500
394	433	471	507	541	573	602	628	3600
497	547	595	641	685	726	764	799	3700

## Appendix B

# M2 .50 Cal Firing Tables

### Table I

#### **Angles of Elevation, Dimension of Cone and Beaten Zone, Angles of Fall, Time of Flight, and Drift—How to Use**

The angle of elevation required to engage a target on flat or uniformly sloping ground is listed for the indicated ranges.

The change in elevation and range for each 100 meters in range has been calculated to permit subsequent changes in the quadrant elevation without recalculation.

The time of flight, maximum ordinate, angle of fall, remaining velocity and drift are listed to assist in determining effect on target.

For ranges not in even hundreds and for ranges not tabulated, the desired information must be determined by interpolation.

Example: The range to the target is 1,000 meters. The angle of elevation is 10.1 mils. The change in elevation between 900 meters and 1,000 meters is 1.5 mils. At 1,000 meters, the change of elevation of 1 mil will change the range 66 meters. The time of flight is 1.6 seconds and the maximum ordinate is 3 meters. The angle of fall is 15 mils, the remaining velocity is 482 meters per second, and the drift is 0.2 mils right.

**Table 1**

**Angles of Elevation, Dimension of Cone and Beaten Zone,  
Angles of Fall, Time of Flight, and Drift**

**FT.50-H-2**

**Muzzle Velocity, 853.4 M/S**

**3  
Cartridge, AP, M2  
Cartridge, Ball, M2**

Range	Elev	Change in		Time of Flight	Maximum Ordinate	Angel of Fall	Remaining Velocity	Drift
		Elev	Range					
		for						
		100M	1 Mil					
		Change in						
Meters	Mils	Mils	Meters	Sec	Meters	Mils	M/S	Mils
0	0.0	0.7	150	0.0	0	0	853	0.0
100	0.7	0.7	140	0.1	0	1	813	0.0
200	1.5	0.8	130	0.2	0	1	772	0.0
300	2.3	0.8	121	0.4	0	3	733	0.0
400	3.1	0.9	112	0.5	0	4	694	0.1
500	4.1	1.0	103	0.7	1	5	656	0.1
600	5.1	1.2	95	0.8	1	6	618	0.1
700	6.2	1.2	87	1.0	1	8	582	0.1
800	7.4	1.3	79	1.2	2	10	547	0.1
900	8.7	1.4	72	1.4	2	12	514	0.2
1000	10.1	1.5	66	1.6	3	15	482	0.2
1100	11.7	1.6	60	1.8	4	18	452	0.2
1200	13.4	1.8	55	2.0	5	21	424	0.2
1300	15.2	2.0	50	2.2	6	25	398	0.3
1400	17.3	2.2	46	2.5	8	30	374	0.3
1500	19.5	2.4	42	2.8	10	35	353	0.3
1600	22.0	2.6	39	3.1	12	41	335	0.4
1700	24.7	2.8	36	3.4	14	48	323	0.4
1800	27.7	3.0	33	3.7	17	55	313	0.4
1900	30.8	3.2	31	4.0	21	62	304	0.5
2000	34.2	3.5	29	4.3	25	70	297	0.5
2100	37.8	3.7	27	4.7	29	78	290	0.6
2200	41.6	4.0	25	5.0	34	86	284	0.7
2300	45.7	4.2	24	5.4	39	95	278	0.7
2400	49.9	4.4	23	5.8	45	104	272	0.8
2500	54.4	4.6	22	6.1	51	113	267	0.8
2600	59.0	4.8	21	6.5	58	123	262	0.9
2700	63.9	5.0	20	6.9	66	133	257	0.9
2800	68.9	5.2	19	7.3	74	143	252	1.0
2900	74.2	5.4	18	7.7	83	154	247	1.1
3000	79.7	5.6	18	8.1	92	166	242	1.2
3100	85.4	5.8	17	8.6	102	178	237	1.3
3200	91.3	6.0	17	9.0	113	190	233	1.4
3300	97.4	6.2	16	9.4	124	203	229	1.5
3400	103.8	6.4	16	9.9	137	216	224	1.6
3500	110.4	6.7	15	10.3	150	230	220	1.7

## Table II

### Overhead Fire—How to Use

*Troop distance* in column 1 is the distance in meters from the gun to the friendly troops over whose heads it is desired to fire.

The quadrant elevation required to strike the ground upon which the troops stand, plus a definite angle of safety given the *minimum quadrant elevation* which can be fired, without danger, over the troops.

The safety angle varies with the range. The minimum quadrant elevation which can be fired with safety over the heads of friendly troops comprises the following factors:

- Safety angle (corresponding to troop distance).
- Angle of elevation (corresponding to troop distance).
- Angle of site.

The safety angle plus the angle of elevation constitutes the *minimum angle of elevation* which can be fired over the heads of troops at the given troop distance. Minimum angles of elevation are listed in column 2.

*Corresponding range* in column 3 is the minimum range expressed in graduation on the rear sight that will give the required clearance. Both the exact and even figures to the nearest 25 meters above are given. When troops to be fired over are visible, the safety angle can be measured by setting the corresponding range (even figures should be used).

Example: Friendly troops are visible and at a distance of 700 meters from the gun. The gun is laid to hit the target. Without disturbing the lay, ensure the rear sight is set at 1,580 meters. In order to ensure that it is safe to fire, the line of aim must clear the troops.

**Table II**  
**Overhead Fire**

1		2		3	
Troop Distance		Minimum Angle of Elevation		Corresponding Range	
				Exact Figure	Even Figure (To Nearest 10 Meters)
Meters	Mils	(Exact Figure)	Difference Mils	Meters	Meters
100	77	(76.68)		2944	2950
200	41	(40.39)	36	2165	2170
300	33	(32.40)	8	1946	1950
400	24	(24.00)	9	1671	1680
500	22	(21.74)	2	1586	1590
600	22	(21.10)	0	1562	1570
700	22	(21.56)	0	1579	1580
800	23	(22.70)	1	1625	1630
900	25	(24.26)	2	1681	1690
1000	26	(26.00)	1	1743	1750
1100	29	(28.16)	3	1814	1820
1200	31	(30.48)	2	1887	1890
1300	33	(33.04)	2	1964	1970
1400	36	(35.84)	3	2044	2050
1500	39	(38.87)	3	2127	2130
1600	43	(42.19)	4	2314	2320
1700	46	(45.87)	3	2304	2310
1800	50	(49.90)	4	2400	2400
1900	55	(54.29)	5	2495	2500
2000	59	(58.95)	4	2595	2600
2100	64	(63.94)	5	2701	2710
2200	70	(69.31)	4	2808	2810
2300	75	(75.02)	5	2915	2920
2400	81	(81.00)	6	3022	3030
2500	88	(87.31)	7	3132	3140
2600	94	(93.90)	6	3274	3280
2700	101	(100.80)	7	3387	3390
2800	108	(108.00)	7	3500	3500
2900	116	(115.50)	8	3615	3620
3000	124	(123.40)	8	3730	3730
3100	132	(131.70)	8	3845	3850
3200	141	(140.30)	9	3960	3960
3300	150	(149.30)	9	4076	4080
3400	159	(158.80)	9	4192	4200
3500	169	(168.80)	10	4308	4410

**Table II**  
**Overhead Fire (Continued)**

1		2		3	
Troop Distance		Minimum Angle of Elevation		Corresponding Range	
				Exact Figure	Even Figure (To Nearest 10 Meters)
Meters	Mils	(Exact Figure)	Difference Mils	Meters	Meters
3600	180	(179.40)	11	4424	4430
3700	191	(190.50)	11	4540	4540
3800	202	(202.00)	11	4656	4670
3900	214	(213.90)	12	4772	4780
4000	227	(226.40)	13	4888	4890
4100	240	(239.40)	13	5005	5010
4200	253	(253.00)	13	5122	5130
4300	268	(267.50)	15	5238	5240
4400	284	(283.10)	16	5353	5360
4500	300	(299.40)	16	5469	5470
4600	317	(316.90)	17	5585	5590
4700	336	(335.70)	19	5702	5710
4800	356	(355.80)	20	5818	5820
4900	378	(377.70)	22	5933	5940
5000	402	(401.80)	24	6047	6050
5100	429	(428.40)	27	6161	6170
5200	459	(458.40)	30	6276	6280
5300	494	(493.50)	35	6391	6400
5400	540	(539.60)	46	6505	6510



### Table III

#### Mask Clearance—How to Use

*Mask distance* in column 1 is the distance in meters from the gun to the highest point of the mask. The minimum quadrant elevation which will clear a mask is such that the lowest shot in the cone will just graze the highest point on the mask. Such a quadrant elevation comprises the following factors:

- Angle of clearance (corresponding to mask distance).
- Angle of elevation (corresponding to mask distance).
- Angle of site to mask.

The angle of clearance is based on the lower one-half of the vertical dimension of the cone. The angle of clearance plus the angle of elevation constitute the *minimum angle of elevation* which will afford clearance at any given mask distance.

*Minimum angles of elevation* are listed in column 2. If the quadrant elevation to the target equals or exceeds the minimum quadrant elevation, clearance exists.

*Corresponding range* in column 3 is the mil angle of required mask clearance expressed in graduations on the rear sight. When the mask is visible, the required mask clearance can be measured by setting the corresponding range on the rear sight.

Example: The mask is visible and is at a distance of 700 meters from the gun. The gun is laid to hit the target; without disturbing the lay, the rear sight is set at 890. If the *line of aim* clears the mask, it is practicable to fire.

**Table III**  
**Mask Clearance**

1		2		3	
Mask Distance	Minimum Angle of Elevation		Difference	Corresponding Range	
Meters	Exact Figure	Mils	Mils	Round UP	
				Meters	Meters
100	3.0	0		388	390
200	3.6	4	4	450	450
300	4.4	5	1	530	530
400	5.3	6	1	618	620
500	6.3	7	1	708	710
600	7.4	8	1	800	800
700	8.5	9	1	885	890
800	9.7	10	1	971	980
900	11.0	11	1	1057	1060
1000	12.4	13	2	1141	1150
1100	13.9	14	1	1228	1230
1200	15.6	16	2	1319	1320
1300	17.5	18	2	1409	1410
1400	19.5	20	2	1500	1500
1500	21.6	22	2	1584	1590
1600	24.0	24	2	1674	1680
1700	26.7	27	3	1767	1770
1800	29.6	30	3	1861	1870
1900	32.8	33	3	1959	1960
2000	36.1	37	4	2052	2060
2100	39.7	40	3	2150	2150
2200	43.5	44	4	2246	2250
2300	47.6	48	4	2345	2350
2400	51.9	52	4	2444	2450
2500	56.5	57	5	2547	2550
2600	61.2	62	5	2668	2670
2700	66.1	67	5	2768	2770
2800	71.1	72	5	2868	2870
2900	76.4	77	5	2968	2970
3000	81.9	82	5	3069	3070
3100	87.7	88	6	3171	3180
3200	93.6	94	6	3273	3280
3300	99.7	100	6	3376	3380
3400	106.2	107	7	3478	3480
3500	113.0	114	7	3580	3580

**Table III**  
**Mask Clearance (Continued)**

1		2		3		
Mask Distance		Minimum Angle of Elevation		Difference	Corresponding Range	
Meters	Exact Figure	Mils	Mils	Meters	Round UP Meters	
3600	120.0	120	6	3682	3690	
3700	127.3	128	8	3784	3790	
3800	135.0	135	7	3886	3890	
3900	142.8	143	8	3988	3990	
4000	151.1	152	9	4089	4090	
4100	159.5	160	8	4190	4190	
4200	168.2	169	9	4291	4300	
4300	177.2	178	9	4392	4400	
4400	186.4	187	9	4493	4500	
4500	195.9	196	9	4594	4600	
4600	205.7	206	10	4695	4700	
4700	216.1	217	11	4796	4800	
4800	226.9	227	10	4897	4900	
4900	238.3	239	12	4998	5000	
5000	250.2	251	12	5098	5100	
5100	262.5	263	12	5198	5200	
5200	275.3	276	13	5297	5300	
5300	288.7	289	13	5396	5400	
5400	302.8	303	14	5494	5500	
5500	317.8	318	15	5592	5600	
5600	333.6	334	16	5690	5700	
5700	350.3	351	17	5788	5790	
5800	368.1	369	18	5884	5890	
5900	387.2	388	19	5980	5980	
6000	407.7	408	20	6076	6080	
6100	430.0	430	22	6171	6180	
6200	454.7	455	25	6265	6270	
6300	482.7	483	28	6359	6360	
6400	514.9	515	32	6452	6460	

**Table IVa****Target Above Gun—How to Use**

This table combines the angle of sight with the angle of elevation when the target is above the gun and gives directly the quadrant elevation in mils. For ranges not in even hundreds, and for VI's not tabulated, the elevation must be determined by interpolation.

Example: The range to the target is 1200 meters. The VI is +30 meters. In the column headed 1200, look opposite the number 30 in the column headed VI. The quadrant elevation is 39.0 mils.

**Table IVa**

**Quadrant Elevation in Mills, Knowing Range, and Vertical Interval in Meters—Target Above Gun**

VI in Meters	Horizontal Distance From the Gun in Meters																								
	100	200	300	400	500	600	700	800	900	1000	1100	1200	1300	1400	1500	1600	1700	1800	1900	2000	2100	2200	2300	2400	2500
5	52	27	19	16	14	14	13	14	14	15	16	18	19	21	23	25	28	30	33	37	40	44	48	52	56
10	102	52	36	29	24	22	21	20	20	20	21	22	23	25	26	28	31	33	36	39	43	46	50	54	58
15	152	78	53	41	35	31	28	26	26	25	25	26	27	28	30	32	34	36	39	42	45	49	52	56	60
20	202	103	70	54	45	39	35	33	31	30	30	30	31	32	33	35	37	39	41	44	47	51	54	58	62
25	250	128	87	67	55	47	43	39	37	36	35	35	35	35	36	38	40	42	44	47	50	53	57	60	64
30	298	153	104	79	65	56	50	46	43	41	39	39	39	39	40	41	43	45	47	49	52	55	59	63	67
35	344	178	121	92	75	64	57	52	48	46	44	43	43	43	43	44	46	47	50	52	55	58	61	65	69
40	388	202	137	105	85	73	64	58	54	51	49	47	47	46	47	47	49	50	52	55	57	60	63	67	71
45	431	227	154	117	95	81	72	65	60	56	53	51	50	50	50	51	52	53	55	57	60	62	66	69	73
50	473	251	170	130	106	90	79	71	65	61	58	56	54	54	53	54	55	56	58	60	62	65	68	71	75
55	513	275	187	142	116	98	86	77	71	66	63	60	58	57	57	57	58	59	60	62	64	67	70	73	77
60	551	298	203	155	126	107	93	84	76	71	67	64	62	61	60	60	61	62	63	65	67	69	72	75	79
65	588	321	220	167	136	115	100	90	82	76	72	68	66	65	64	63	64	64	66	67	69	72	74	77	81
70	623	344	236	180	146	123	108	96	88	81	76	73	70	68	67	67	67	67	68	70	72	74	77	80	83
75	656	367	252	192	156	132	115	103	93	86	81	77	74	72	70	70	70	70	71	72	74	76	79	82	85
80	688	389	268	204	166	140	122	109	99	91	86	81	78	75	74	73	73	73	74	75	77	79	81	84	87
85	718	411	283	216	176	148	129	115	105	96	90	85	82	79	77	76	76	76	76	77	79	81	83	86	90
90	747	432	299	229	185	157	136	121	110	102	95	90	86	83	81	79	79	79	79	80	81	83	85	88	91
95	775	453	315	241	195	165	144	128	116	107	99	94	90	86	84	82	82	81	82	83	84	86	88	90	93
100	801	474	330	253	205	173	151	134	121	112	104	98	93	90	87	86	85	84	84	85	86	88	90	92	95

**Table IVb****Target Below Gun—How to Use**

This table combines the angle of site with the angle of elevation when the target is below the gun and gives directly the quadrant elevation in mils. For ranges not in even hundreds, and for VI's that are not tabulated, the elevation must be determined by interpolation.

Example: The range to the target is 1200 meters. The VI is -30 meters (target below gun). In the column headed 1200, look opposite the number 30 in the column headed VI. The quadrant elevation is -12.0 mils.

**Table IVb**

**Quadrant Elevation in Mills, Knowing Range, and Vertical Interval in Meters—Target Below Gun**

VI in Meters	Horizontal Distance From the Gun in Meters																								
	100	200	300	400	500	600	700	800	900	1000	1100	1200	1300	1400	1500	1600	1700	1800	1900	2000	2100	2200	2300	2400	2500
5	-50	-24	-15	-10	-6	-3	-1	+1	3	5	7	9	11	14	16	19	22	25	28	32	35	39	43	48	52
10	-101	-49	-32	-22	-16	-12	-8	-5	-3	0	+2	5	7	10	13	16	19	22	25	29	33	37	41	46	50
15	-151	-75	-49	-35	-26	-20	-16	-12	-8	-5	-2	+1	3	6	9	12	16	19	23	27	31	35	39	43	48
20	-200	-100	-65	-48	-37	-29	-23	-18	-14	-10	-7	-4	0	+3	6	9	13	16	20	24	28	32	37	41	46
25	-249	-125	-82	-60	-47	-37	-30	-24	-20	-15	-11	-8	-4	-1	+3	6	10	13	17	21	26	30	35	39	44
30	-296	-150	-99	-73	-57	-46	-37	-31	-25	-20	-16	-12	-8	-4	-1	+3	7	11	15	19	23	28	32	37	42
35	-342	-175	-116	-86	-67	-54	-45	-37	-31	-25	-21	-16	-12	-8	-4	0	+4	8	12	16	21	25	30	35	40
40	-387	-200	-133	-98	-77	-63	-52	-43	-36	-31	-25	-21	-16	-12	-8	-3	+1	5	9	14	18	23	28	33	38
45	-430	-224	-149	-111	-87	-71	-59	-50	-42	-36	-30	-25	-20	-15	-11	-7	-2	+2	7	11	16	21	26	31	36
50	-472	-248	-166	-123	-97	-80	-66	-56	-48	-41	-35	-29	-24	-19	-14	-10	-5	-1	+4	9	14	18	24	29	34
55	-511	-272	-182	-136	-107	-88	-74	-62	-53	-46	-39	-33	-28	-23	-18	-13	-8	-3	+1	6	11	16	21	27	32
60	-550	-295	-199	-148	-118	-96	-81	-69	-59	-51	-44	-37	-32	-26	-21	-16	-11	-6	-1	+4	9	14	19	24	30
65	-586	-319	-215	-161	-128	-105	-88	-75	-65	-56	-48	-42	-36	-30	-24	-19	-14	-9	-4	+1	6	12	17	22	28
70	-621	-341	-231	-73	-138	-113	-95	-81	-70	-61	-53	-46	-39	-34	-28	-22	-17	-12	-7	-1	+4	9	15	20	26
75	-655	-364	-247	-186	-148	-122	-102	-88	-76	-66	-58	-50	-43	-37	-31	-26	-20	-15	-9	-4	+1	7	12	18	24
80	-687	-386	-263	-198	-157	-130	-110	-94	-82	-71	-62	-54	-47	-41	-35	-29	-23	-17	-12	-6	-1	+5	10	16	22
85	-717	-408	-279	-210	-167	-138	-117	-100	-87	-76	-67	-59	-51	-44	-38	-32	-26	-20	-15	-10	-3	+2	8	14	20
90	-746	-429	-295	-222	-177	-146	-124	-107	-93	-81	-71	-63	-55	-48	-41	-35	-29	-23	-17	-11	-6	0	+6	12	18
95	-773	-450	-310	-234	-187	-155	-131	-113	-98	-86	-76	-67	-59	-52	-45	-38	-32	-26	-20	-14	-8	-2	+4	10	16
100	-799	-471	-325	-246	-197	-163	-138	-119	-104	-91	-81	-71	-63	-55	-48	-41	-35	-29	-23	-17	-11	-5	+1	7	14

**Table V****Ordinates—How to Use**

The figures indicate the height in meters of the center of the cone above the line of site at any distance from the gun. The negative figures indicate the distance of the center of the cone below the line of site any distance from the gun. Example: At a range of 900 meters (col-

umn of figures at left) and at a distance of 700 meters from the gun (line of figures under distance from the gun), the center of the cone is 2 meters above the line of site. At a distance of 2100 meters from the gun, the center of the cone is -59 meters below the line of site.



**Table V—Part 1**  
**Ordinates in Meters**

**Caliber .50 M2**

Range (Meters)	Horizontal Distance (Meters)									
	100	200	300	400	500	600	700	800	900	1000
100	0	0	-1	-1	-1	-2	-3	-5	-7	-9
200	0	0	0	0	-1	-2	-3	-5	-7	-9
300	0	0	0	0	0	-1	-3	-4	-6	-8
400	0	0	0	0	0	-1	-2	-3	-5	-7
500	0	0	0	0	0	-1	-2	-3	-4	-6
600	0	1	1	1	0	0	-1	-2	-3	-5
700	0	1	1	1	1	1	0	-1	-2	-4
800	0	1	2	2	2	2	1	0	-1	-2
900	0	1	2	2	2	2	2	1	0	-1
1000	1	2	3	3	3	3	3	2	1	0
1100	1	2	3	3	4	4	4	3	3	2
1200	1	2	3	4	5	5	5	4	4	3
1300	1	3	4	5	6	6	6	6	6	5
1400	1	3	4	5	6	7	8	8	8	7
1500	2	3	5	6	7	9	9	10	10	9
1600	2	4	6	7	9	10	11	12	12	12
1700	2	5	7	9	10	11	13	14	14	14
1800	3	5	8	10	11	13	15	16	16	17
1900	3	6	9	11	13	15	17	18	19	20
2000	3	6	10	12	15	17	19	21	22	23
2100	4	7	10	13	16	19	21	23	25	26
2200	4	8	11	15	18	21	24	26	28	30
2300	4	8	12	16	20	24	27	29	32	34
2400	5	9	14	18	22	26	30	32	35	38
2500	5	10	15	20	24	28	33	36	39	43
2600	5	11	16	22	26	31	36	39	43	47
2700	6	12	18	24	29	34	39	43	47	52
2800	7	13	19	25	31	37	43	47	52	57
2900	7	14	21	27	34	40	46	52	57	62
3000	8	15	22	29	36	43	49	56	61	67
3100	8	16	24	32	39	46	53	60	66	72
3200	8	17	26	34	42	50	57	64	71	78
3300	9	18	27	36	45	53	61	69	76	83
3400	9	19	29	39	48	56	65	74	82	89
3500	10	20	31	42	51	61	70	79	88	96
3600	11	22	33	44	55	65	75	85	94	102
3700	12	23	35	47	58	69	80	91	100	110
3800	13	25	38	50	62	74	85	96	107	117
3900	14	27	40	53	66	78	90	102	113	125
4000	14	28	42	56	69	82	95	107	120	133
4100	15	30	45	59	73	87	101	114	128	141
4200	16	32	48	63	77	92	107	121	135	149
4300	16	33	50	66	82	98	113	128	143	158
4400	17	35	52	69	86	103	119	135	151	166
4500	18	37	55	73	91	108	126	143	159	176

**Table V—Part 2**  
**Ordinates in Meters**

**Caliber .50 M2**

Range (Meters)	Horizontal Distance (Meters)									
	1100	1200	1300	1400	1500	1600	1700	1800	1900	2000
100	-12	-15	-18	-22	-28	-34	-40	-47	-55	-64
200	-11	-14	-17	-21	-26	-32	-38	-45	-53	-62
300	-10	-13	-16	-20	-25	-31	-37	-44	-52	-61
400	-9	-12	-15	-19	-24	-30	-36	-43	-51	-60
500	-8	-11	-14	-18	-23	-28	-34	-41	-49	-58
600	-7	-9	-13	-17	-21	-26	-32	-39	-47	-56
700	-6	-8	-11	-15	-20	-25	-30	-37	-45	-54
800	-4	-6	-9	-13	-18	-23	-28	-35	-43	-52
900	-3	-5	-8	-11	-16	-20	-26	-33	-41	-50
1000	-2	-4	-6	-9	-13	-18	-23	-31	-39	-48
1100	0	-2	-4	-7	-11	-16	-21	-28	-36	-45
1200	2	0	-2	-5	-9	-13	-18	-25	-33	-41
1300	4	2	1	-3	-6	-10	-15	-22	-29	-37
1400	6	5	3	1	-3	-7	-12	-18	-25	-33
1500	8	7	5	3	2	-4	-9	-14	-21	-29
1600	11	10	9	6	3	2	-5	-10	-17	-24
1700	14	13	12	10	7	4	2	-6	-12	-19
1800	17	16	15	14	11	8	5	2	-6	-13
1900	20	20	19	18	16	13	10	5	2	-7
2000	23	24	24	23	21	19	15	11	6	1
2100	27	28	29	28	27	24	21	17	13	7
2200	31	32	33	33	32	30	27	24	20	15
2300	36	37	38	38	38	37	34	31	27	23
2400	40	42	44	44	44	43	41	38	35	30
2500	45	47	49	50	50	50	49	46	43	38
2600	51	53	55	56	57	57	57	54	51	47
2700	56	59	61	63	65	65	65	63	60	56
2800	61	65	68	70	72	73	73	71	69	66
2900	66	70	74	77	79	81	81	80	79	76
3000	72	76	81	84	87	89	90	90	89	87
3100	78	83	88	92	95	98	99	100	100	98
3200	84	89	95	100	103	106	108	109	110	110
3300	90	96	102	108	112	116	118	120	121	122
3400	97	104	110	116	121	125	129	131	133	133
3500	104	112	118	125	130	136	140	143	145	145
3600	111	120	127	134	140	146	151	155	158	159
3700	119	128	136	144	151	157	162	167	171	173
3800	127	136	145	154	162	169	175	180	184	187
3900	135	145	155	164	172	180	187	193	198	201
4000	144	155	165	175	184	192	199	206	212	217
4100	153	164	175	186	196	205	213	220	227	232
4200	162	174	186	198	209	218	227	235	242	248
4300	172	185	197	209	221	232	241	250	258	266
4400	182	196	209	222	235	246	257	267	276	284
4500	192	207	221	235	249	262	273	284	294	303

**Table V—Part 3**  
**Ordinates in Meters**

**Caliber .50 M2**

Range (Meters)	Horizontal Distance (Meters)									
	2100	2200	2300	2400	2500	2600	2700	2800	2900	3000
100	-74	-86	-100	-114	-129	-147	-165	-185	-206	-229
200	-73	-85	-98	-112	-128	-145	-163	-183	-204	-227
300	-71	-83	-97	-111	-126	-143	-161	-181	-202	-225
400	-69	-81	-95	-109	-124	-140	-158	-178	-199	-222
500	-67	-79	-92	-106	-122	-138	-156	-176	-196	-219
600	-65	-77	-90	-104	-119	-135	-153	-173	-193	-216
700	-63	-75	-88	-101	-116	-132	-150	-170	-190	-212
800	-61	-72	-85	-98	-113	-129	-147	-166	-187	-208
900	-59	-70	-82	-95	-110	-126	-144	-162	-183	-204
1000	-57	-67	-79	-92	-106	-122	-140	-158	-179	-200
1100	-54	-64	-75	-88	-102	-118	-136	-154	-175	-196
1200	-50	-60	-71	-83	-98	-114	-132	-150	-170	-191
1300	-46	-56	-67	-79	-93	-109	-126	-145	-165	-186
1400	-42	-51	-62	-75	-88	-104	-120	-139	-159	-180
1500	-37	-46	-57	-69	-83	-98	-115	-133	-152	-174
1600	-32	-41	-51	-63	-77	-92	-108	-126	-145	-166
1700	-27	-36	-46	-57	-71	-85	-101	-119	-138	-158
1800	-20	-29	-39	-51	-64	-78	-94	-111	-130	-150
1900	-14	-23	-33	-44	-57	-71	-86	-103	-121	-140
2000	-7	-16	-26	-37	-49	-62	-77	-93	-111	-130
2100	0	-8	-18	-29	-41	-53	-67	-83	-101	-120
2200	8	1	-9	-19	-31	-43	-58	-73	-91	-109
2300	16	9	2	-10	-21	-33	-47	-62	-80	-98
2400	24	18	10	4	-11	-23	-36	-51	-68	-86
2500	33	27	20	11	5	-12	-25	-39	-55	-72
2600	43	37	30	21	11	6	-13	-27	-42	-58
2700	52	47	41	33	23	12	6	-13	-28	-44
2800	62	58	52	44	35	25	13	6	-14	-30
2900	73	69	64	56	48	38	27	14	5	-16
3000	84	81	76	69	61	51	41	28	15	4
3100	96	93	89	82	75	65	55	43	30	16
3200	108	105	101	95	88	80	70	59	46	33
3300	120	117	114	109	102	95	86	75	64	51
3400	132	130	127	123	117	110	102	92	82	69
3500	145	144	141	138	133	127	119	110	100	88
3600	160	159	156	153	149	144	137	128	119	107
3700	175	174	172	169	166	162	156	148	138	127
3800	190	190	189	186	184	180	175	167	159	148
3900	205	206	206	204	202	199	194	188	180	170
4000	220	222	223	223	222	219	214	208	202	193
4100	236	239	242	242	241	239	235	231	224	216
4200	253	257	260	261	262	260	258	254	248	240
4300	272	276	279	282	283	283	281	277	273	266
4400	291	296	300	303	305	305	303	301	297	292
4500	310	316	321	325	328	328	328	327	324	219

**Table V—Part 4**  
**Ordinates in Meters**

**Caliber .50 M2**

Range (Meters)	Horizontal Distance (Meters)									
	3100	3200	3300	3400	3500	3600	3700	3800	3900	4000
100	-254	-280	-308	-338	-371	-405	-442	-481	-523	-567
200	-252	-278	-306	-336	-369	-403	-440	-488	-526	-564
300	-249	-275	-303	-334	-366	-401	-437	-512	-540	-560
400	-246	-272	-300	-331	-363	-397	-433	-472	-513	-557
500	-243	-269	-297	-327	-360	-393	-429	-468	-509	-553
600	-240	-265	-293	-323	-255	-289	-425	-464	-505	-549
700	-236	-262	-289	-318	-351	-385	-421	-459	-500	-544
800	-232	-258	-285	-314	-347	-381	-416	-454	-495	-539
900	-228	-254	-281	-310	-342	-376	-411	-449	-490	-534
1000	-224	-250	-277	-305	-336	-370	-406	-444	-485	-529
1100	-219	-245	-272	-300	-331	-365	-401	-439	-480	-523
1200	-214	-239	-266	-295	-326	-359	-395	-433	-473	-516
1300	-209	-234	-260	-289	-320	-353	-388	-426	-466	-509
1400	-203	-228	-254	-283	-313	-346	-381	-418	-458	-500
1500	-197	-221	-247	-276	-306	-339	-373	-409	-449	-491
1600	-189	-214	-240	-268	-298	-331	-365	-401	-439	-481
1700	-181	-205	-231	-258	-289	-321	-355	-391	-429	-471
1800	-172	-196	-221	-248	-278	-310	-344	-380	-418	-460
1900	-162	-185	-210	-237	-267	-298	-332	-368	-407	-448
2000	-151	-174	-199	-226	-256	-287	-319	-355	-394	-435
2100	-140	-163	-188	-215	-244	-274	-307	-342	-380	-421
2200	-130	-152	-176	-202	-231	-261	-293	-328	-365	-405
2300	-118	-140	-163	-188	-216	-246	-279	-313	-350	-389
2400	-106	-127	-149	-174	-201	-231	-264	-298	-334	-372
2500	-92	-113	-136	-160	-187	-216	-248	-281	-317	-355
2600	-77	-98	-121	-146	-172	-200	-231	-263	-299	-236
2700	-63	-83	-106	-130	-156	-183	-213	-245	280	-318
2800	-48	-68	-90	-113	-138	-166	-195	-227	-261	-298
2900	-33	-52	-73	-96	-120	-147	-177	-209	-242	-278
3000	-17	-35	-55	-78	-102	-129	-158	-189	-221	-257
3100	3	-18	-37	-59	-83	-110	-138	-168	-200	-235
3200	17	0	-19	-40	-64	-90	-117	-146	-178	-212
3300	36	19	3	-21	-44	-68	-95	-124	-155	-189
3400	55	39	20	6	-22	-47	-73	-101	-132	-165
3500	75	59	41	21	8	-24	-49	-77	-107	-140
3600	94	79	62	43	42	10	-25	-52	-82	-114
3700	114	100	84	65	45	24	11	-26	-55	-87
3800	136	122	106	89	69	48	26	12	-28	-59
3900	159	146	131	113	95	75	53	28	12	-30
4000	182	170	156	139	121	102	80	56	29	11
4100	206	195	181	166	149	130	108	84	59	31
4200	231	221	208	194	177	159	138	115	90	62
4300	257	248	236	222	207	189	169	147	122	96
4400	284	276	265	252	237	221	202	181	157	131
4500	313	305	295	283	269	253	235	216	193	167

**Table V—Part 5**  
**Ordinates in Meters**

**Caliber .50 M2**

Range (Meters)	Horizontal Distance (Meters)									
	4100	4200	4300	4400	4500	4600	4700	4800	4900	5000
100	-614	-663	-716	-772	-832	-895	-961	-1031	-1105	-1185
200	-610	-660	-713	-769	-829	-892	-958	-1058	-1102	-1182
300	-607	-656	-709	-765	-825	-887	-854	-1024	-1098	-1177
400	-603	-653	-706	-761	-820	-882	-949	-1019	-1093	-1172
500	-599	-649	-701	-757	-815	-877	-944	-1014	-1088	-1167
600	-595	-644	-696	-752	-810	-872	-939	-1009	-1083	-1162
700	-591	-639	-691	-747	-805	-867	-933	-1004	-1078	-1156
800	-585	-634	-686	-741	-799	-861	-927	-997	-1071	-1150
900	-579	-628	-680	-735	-794	-855	-921	-990	-1064	-1143
1000	-574	-623	-675	-729	-787	-849	-914	-983	-1057	-1157
1100	-568	-617	-668	-722	-780	-842	-907	-976	-1049	-1127
1200	-561	-609	-660	-714	-773	-834	-899	-968	-1041	-1119
1300	-553	-601	-652	-706	-765	-826	-890	-959	-1031	-1109
1400	-545	-592	-643	-698	-756	-817	-881	-949	-1021	-1098
1500	-536	-583	-634	-688	-746	-807	-870	-938	-1010	-1086
1600	-526	-573	-623	-677	-735	-796	-859	-926	-997	-1074
1700	-515	-562	-612	-665	-722	-782	-846	-912	-983	-1060
1800	-502	-550	-600	-653	-709	-768	-832	-898	-969	-1045
1900	-492	-537	-586	-639	-694	-753	-816	-883	-954	-1030
2000	-478	-524	-572	-624	-679	-738	-800	-867	-937	-1012
2100	-463	-509	-557	-608	-663	-721	-783	-849	-919	-913
2200	-447	-492	-540	-591	-646	-703	-765	-831	-900	-974
2300	-430	-475	-523	-573	-627	-684	-746	-811	-880	-953
2400	-413	-457	-504	-555	-608	-665	-726	-791	-859	-932
2500	-395	-439	-485	-535	-588	-645	-705	-769	-837	-909
2600	-377	-420	-466	-515	-567	-623	-683	-747	-814	-885
2700	-357	-400	-445	-494	-546	-601	-661	-724	-790	-861
2800	-337	-379	-424	-473	-524	-578	-637	-699	-766	-836
2900	-316	-358	-403	-450	-501	-555	-613	-674	-740	-809
3000	-295	-336	-380	-427	-478	-531	-587	-648	-712	-781
3100	-273	-313	-357	-403	-453	-506	-562	-621	-685	-753
3200	-250	-289	-332	-378	-428	-480	-535	-595	-658	-725
3300	-226	-265	-307	-352	-401	-453	-508	-566	-630	-696
3400	-201	-239	-281	-325	-373	-424	-478	-537	-600	-665
3500	-175	-213	-254	-298	-344	-394	-448	-506	-568	-633
3600	-148	-186	-226	-269	-315	-364	-418	-475	-535	-599
3700	-121	-157	-197	-239	-284	-333	-386	-442	-502	-565
3800	-92	-128	-166	-208	-253	-300	-352	-408	-467	-530
3900	-62	-97	-136	-176	-220	-267	-318	-373	-431	-493
4000	-32	-66	-103	-143	-186	-232	-283	-337	-394	-455
4100	8	-34	-70	-109	-152	-197	-247	-300	-357	-417
4200	33	4	-36	-74	-116	-161	-209	-262	-317	-377
4300	67	35	2	-38	-79	-123	-170	-222	-277	-336
4400	102	71	37	7	-40	-83	-130	-181	-236	-293
4500	139	108	75	39	13	-42	-88	-138	-192	-248

**Table V—Part 6**  
**Ordinates in Meters**

**Caliber .50 M2**

Range (Meters)	Horizontal Distance (Meters)			
	5100	5200	5300	5400
100	-1270	-1360	-1456	-1557
200	-1266	-1356	-1451	-1552
300	-1262	-1351	-1446	-1547
400	-1257	-1346	-1440	-1541
500	-1251	-1340	-1435	-1535
600	-1246	-1335	-1429	-1529
700	-1240	-1328	-1423	-1523
800	-1233	-1321	-1416	-1516
900	-1226	-1314	-1408	-1508
1000	-1218	-1306	-1400	-1499
1100	-1209	-1297	-1391	-1490
1200	-1201	-1288	-1381	-1480
1300	-1190	-1277	-1370	-1469
1400	-1179	-1266	-1359	-1457
1500	-1168	-1255	-1347	-1447
1600	-1155	-1241	-1333	-1431
1700	-1141	-1227	-1318	-1415
1800	-1125	-1211	-1301	-1397
1900	-1109	-1193	-1283	-1379
2000	-1091	-1174	-1264	-1360
2100	-1071	-1154	-1244	-1339
2200	-1051	-1134	-1223	-1317
2300	-1030	-1113	-1201	-1294
2400	-1008	-1090	-1177	-1269
2500	-985	-1066	-1152	-1244
2600	-961	-1041	-1127	-1219
2700	-936	-1016	-1100	-1191
2800	-910	-989	-1073	-1163
2900	-883	-962	-1046	-1135
3000	-855	-934	-1017	-1105
3100	-827	-905	-987	-1074
3200	-797	-874	-955	-1043
3300	-767	-843	-923	-1009
3400	-735	-810	-889	-974
3500	-702	-776	-855	-939
3600	-668	-741	-820	-904
3700	-633	-705	-783	-866
3800	-596	-668	-745	-827
3900	-559	-629	-705	-786
4000	-520	-590	-665	-745
4100	-481	-551	-624	-703
4200	-441	-509	-582	-660
4300	-398	-465	-537	-614
4400	-354	-420	-491	-567
4500	-309	-374	-444	-519

## Table VI

### Searching Reverse Slopes—How to Use

To find a position to search a reverse slope, compute from the map the average drop in meters in 100 meters of slope to be searched. In the column headed by this gradient, note the range opposite a VI of zero. This is the range to search the slope when the gun and target are on the same level. On the map, measure back this range from the target and find the VI of this point. Below or above the zero line in the same column, depending upon whether the target is below or above this point, find the range opposite the VI. Move forward or back to this range, and if the VI is not materially changed, the position is suitable. If the VI is materially changed, repeat the operation until a suit-

able position is found. Often a movement to the right or left will secure the proper VI.

Example: It is desired to search a slope with an average drop of 10 meters in 100 meters. In the column under that gradient, and opposite a VI of zero, is found the range 2862. Measure back on the map 2862 meters from the target. Suppose the target is 30 meters below the position found. In the same column, opposite a VI of 30 meters below the gun is found the range 2756. Move forward to a point 2756 meters from the target and determine the QE for that range. Set the QE on the gun and engage the target.

**Table VI**  
**Searching Reverse Slopes**

**Caliber .50 M2**

		Number of Meters Drop															
	Meters	0	1	2	3	4	5	6	7	8	9	10	11	12	13	14	15
	90	2225	2321	2417	2513	2609	2702	2789	2876	2959	3041	3124	3201	3279	3352	3422	3490
	80	2179	2280	2377	2475	2571	2667	2758	2846	2933	3015	3097	3176	3254	3328	3402	3470
VI	70	2129	2235	2336	2436	2534	2630	2723	2814	2903	2987	3069	3151	3229	3307	3380	3450
	60	2079	2188	2291	2393	2494	2592	2688	2781	2873	2960	3042	3124	3204	3282	3357	3430
Above	50	2026	2138	2246	2353	2454	2555	2653	2749	2840	2930	3015	3097	3179	3257	3335	3410
	40	1968	2085	2198	2311	2411	2515	1615	2711	2805	2897	2987	3072	3154	3232	3310	3387
Gun	30	1905	2027	2145	2259	2366	2475	2575	2674	2774	2865	2957	3044	3136	3207	3288	3362
	20	1836	1963	2090	2208	2321	2431	2535	2639	2740	2835	2927	3014	3100	3182	3264	3341
	10	1758	1898	2031	2154	2272	2386	2495	2600	2701	2801	2892	2994	3070	3157	3239	3317
	0	1673	1824	1966	2094	2217	2336	2451	2560	2665	2766	2862	2954	3045	3127	3214	3292
	10	1565	1738	1891	2033	2162	2286	2401	2515	2625	2726	2827	2923	3015	3102	3185	3267
	20	1410	1634	1809	1961	2101	2230	2351	2470	2581	2691	2792	2888	2980	3072	3159	3242
VI	30		1491	1712	1879	2034	2170	2299	2424	2540	2649	2756	2853	2949	3042	3130	3217
	40			1582	1787	1957	2107	2243	2342	2493	2606	2716	2818	2916	3012	3103	3190
Below	50				1675	1870	2034	2180	2317	2443	2564	2676	2783	2884	2982	3073	3160
	60				1473	1763	1954	2113	2257	2390	2516	2633	2746	2849	2949	3043	3133
Gun	70					1610	1854	2037	2192	2332	2463	2585	2703	2811	2914	3010	3105
	80						1731	1947	2124	2272	2408	2539	2661	2774	2879	2979	3075
	90							1836	2042	2208	2353	2490	2617	2735	2844	2945	3045



## Table II

### M2 .50 Cal Trajectory Chart—How to Use

To determine the quadrant elevation to a target at a given range and VI, with the trajectory chart, find the point of intersection of the vertical line corresponding to the given range and the horizontal line corresponding to the given VI (plus, if the target is above the gun; minus, if below). If this point lies on a black trajectory curve, the elevation in mils may be read directly from the curve, either at the right or left. If the point lies between two curves, multiply the proportion of the distance from the lower curve to the upper by 10 and add this to the elevation shown on the lower curve.

Example: The range to the target is 1600 meters; VI, 10 meters. Plot the target directly above the range of 1600 meters and to the right of the VI of 10 meters.

This point lies 0.9 of the distance from the curve for an elevation of 20 mils to that for 30 mils. Multiply  $0.9 \times 10 = 9$ . The quadrant elevation to the target is  $20 + 9 = 29$  mils.

If it is required to clear a mask at a given range and VI, plot the mask in the same way as the target. At the same range, locate the position of the trajectory to the target. Above these points, at the top of the chart, is given the distance of the lowest shot below the center of the cone. Measure off this distance below the trajectory and plot the position of the lowest shot. If this is above the mask it will be cleared. If it falls only a small distance below the mask, it may still be practical to fire, as the majority of shots may clear the mask.

## Appendix C

# MK-19 MOD 3 Firing Table

### Table I

#### Angles of Elevation, Dimensions of Cone and Beaten Zone,

#### Angles of Fall, Time of Flight, and Drift—How to Use

The quadrant elevation required to engage a target on flat or uniformly sloping ground is listed for the indicated ranges.

The time of flight, drift, angle of fall, and the velocity at impact are listed to assist in determining effect on target.

For ranges not in even hundreds and for ranges not tabulated, the desired information must be determined by interpolation.

Example: The range to the target is 1,000 meters. The quadrant elevation on flat or uniformly sloping ground is 123.4 mils. The time of flight is 5.36 seconds, the drift is 6.2 mils right, the angle of fall is 168.5 mils, and the velocity at impact is 150.8 meters per second.

Table I

**Angles of Elevation, Dimension of Cone and Beaten Zone,  
Angles of Fall, Time of Flight, and Drift**

**Projectile, 40mm: HE, M384**

<b>Range</b>	<b>Quadrant Elevation</b>	<b>Time of Flight</b>	<b>Drift</b>	<b>Angle of Fall</b>	<b>Impact Velocity</b>
<b>Meters</b>	<b>Mils</b>	<b>Sec</b>	<b>Mils</b>	<b>Mils</b>	<b>M/Sec</b>
100	8.9	.42	.4	9.2	229.2
200	18.5	.87	.8	19.7	218.7
300	28.6	1.34	1.3	31.6	208.6
400	39.5	1.83	1.8	44.9	199.0
500	51.2	2.35	2.3	60.0	189.9
600	63.6	2.89	2.9	77.0	181.2
700	77.0	3.46	3.6	96.1	173.0
800	91.3	4.06	4.4	117.5	165.1
900	106.7	4.69	5.2	141.5	157.2
1000	123.4	5.36	6.2	168.2	150.8
1100	141.3	6.06	7.3	198.7	144.2
1200	160.8	6.80	8.5	232.6	138.1
1300	182.0	7.59	10.0	270.4	132.3
1400	205.2	8.44	11.6	312.9	127.0
1500	230.7	9.34	13.5	360.3	122.2
1600	259.0	10.31	15.7	413.3	117.8
1700	290.6	11.36	18.3	472.4	114.0
1800	326.9	12.52	21.4	539.3	110.7
1900	369.0	13.83	25.3	614.8	108.1
2000	420.2	15.35	30.3	701.9	106.2
2100	487.9	17.27	37.6	807.7	105.3
2200	613.2	20.55	53.1	973.3	106.7

**Table II**  
**Overhead Fire—How to Use**

**Column 1** is the range in meters from the gun to the target.

**Column 2** is the elevation in mils when using the tripod and T&E.

**Column 3** is the time of flight in seconds from the gun to the target. This is especially important when coordinating target suppression and troop movement. While the round takes on .9 seconds to arrive on target when fired from 200 meters out, it takes 21.5 seconds to impact when fired 2057 meters.

**Column 4** shows the maximum ordinate of the round.

**Column 5** is the distance the round travels from the gun until it reaches a height of 5 meters. For example, when the MK19 M430 round is fired at a target 700 meters away, the initial danger area extends from the gun down range 75 meters before its trajectory will rise more than 5 meters above the ground. For the purpose of this table, 5 meters is used as a safety height. The safety height comprises the following factors: the height of a standing man (1.8 meters) + 3.2 meters for round, weather, and terrain variation.

**Column 6** is the distance the round travels with a trajectory of more than 5 meters. It is in this dead space that overhead fire of friendly troops is safe. For example, when firing at a target 1300 meters down range, column 6 shows that from 27 to 1283 meters down range the round's trajectory will be more than 5 meters above level ground and it will be safe to move friendly troops under this trajectory.

**Column 7** is the distance from the gun at which the trajectory of the round goes below the 5 meter safety height. This target danger area is in relationship to the trajectory of the M430 round and is not based on the fragmentation pattern of the exploding round. However, when integrating target suppression and troop movement, the 15 meter effective casualty radius of the bursting M430 round must be considered.

For ranges less than 600 meters, overhead fire with MK19 in the direct fire mode is not recommended.

The provisional data in this table is computer generated. When necessary the numbers have been rounded up to ensure troop safety.

**Table II**  
**MK-19 MOD 3 Direct Fire Table (Provisional Data)**

Range to Target	Quadrant Elevation (Mils)	Time of Flight (Seconds)	Max Ord	Initial Danger Space	Dead Space	Target Danger Space
100	9.0	.4	.2	0-100		
200	19	.9	.9	0-200		
300	30	1.4	2.2	0-300		
400	40	1.9	4.2	0-400		
500	52	2.4	7.0	0-500		
600	66	3.0	10.7	0-93	93-525	525-600
700	80	3.5	15.5	0-75	75-639	639-700
800	95	4.2	21.5	0-58	58-754	754-800
900	112	4.9	29.0	0-50	50-862	862-900
1000	130	5.6	38.2	0-42	42-970	970-1000
1100	150	6.3	49.4	0-36	36-1075	1075-1100
1200	171	7.1	63	0-30	30-1180	1180-1200
1300	195	8.0	79.6	0-27	27-1283	1283-1300
1400	222	9.0	99.6	0-23	23-1386	1386-1400*
1500	252	10.0	124	0-21	21-1488	1488-1500*
1600	287	11.1	154	0-18	18-1590	1590-1600*
1700	327	12.4	191	0-16	16-1689	1689-1700*
1800	375	13.8	239	0-13	13-1787	1787-1800*
1900	435	15.6	304	0-11	11-1891	1891-1900*
2000	525	18.0	407	0-9	9-1995	1995-2000*
2057	667	21.5	578	0-7	7-2054	2054-2057*

\* Target danger area is stated in terms of trajectory of the M430 round in relationship to the 5 meter safety height. It is not based on the effective casualty radius (ECR) of the bursting round. However, the commander must consider the 15 meter ECR when integrating target suppression and troop movement.

**Table III**  
**Indirect Overhead—How to Use**

**Column 1** is the range in meters from the gun to the target.

**Column 2** is the elevation in mils when using the tripod and T&E.

**Column 3** is the time of flight in seconds from the gun to the target. This is especially important when coordinating target suppression and troop movement. The delay of 30.7 to 33.1 seconds must be considered when planning target suppression.

**Column 4** shows the maximum ordinate of the round.

**Column 5** is the distance the round travels from the gun until it reaches a height of 5 meters. For example, when the MK19 M430 round is fired at a target 1500 meters down range, the initial danger area extends from the gun down range 2 meters before its trajectory will rise more than 5 meters above the ground. For the purpose of this table, 5 meters is used as a safety height. The safety height comprises the following factors:

The height of a standing man (1.8 meters) + 3.2 meters for round, weather, and terrain variation.

**Column 6** is the distance the round travels with a trajectory of more than 5 meters. It is in this dead space that overhead fire of friendly troops is safe. For example, when firing at a target 1300 meters down, column 6 shows that from 2 to 1299 meters down range the round's trajectory will be more than 5 meters above level ground and it will be safe to move friendly troops under this trajectory.

**Column 7** is the distance from the gun at which the trajectory of the round goes below the 5 meter safety height. This target danger area is in relationship to the trajectory of the M430 round and is not based on the fragmentation pattern of the exploding round. However, when integrating target suppression and troop movement, the 15 meter effective casualty radius must be considered.

The provisional data in this table was computer generated. The quadrant elevations are based on a maximum safe elevation of 70.5 degrees. At quadrant elevations in excess of 70.5 degrees, the M430 round becomes unstable and begins to tumble points over tail. Current tripod and T&E allows maximum elevation of approximately 65 degrees.

After the gun has been laid, it must be determined whether or not the entire cone of fire will clear the mask. When the range to the mask is not more than 450 meters, mask clearance exists when the axis of the bore is elevated 7 mils or more above the gun-mask line. After the gun has been laid on the target, the gun-mask clearance can be checked by depressing the muzzle of the gun 2 mils and sighting along the bottom of the receiver and the barrel support. If this line of sight clears the mask, mask clearance exists for the cone of fire. Do not forget to return the 2 mils of elevation to the gun before firing.

When the range to the mask is more than 450 meters, see Table V, appendix C or appendix H for guidance.

Table III

## MK-19 MOD 3 M430 Indirect Fire Table (Provisional Data)

Range to Target	Quadrant Elevation (Mils)	Time of Flight (Seconds)	Max Ord	Initial Danger Space	Dead Space	Target Danger Space
900	1253	33.1	1201.8	0-2	2-899	899-900*
1000	1230	32.9	1188.2	0-2	2-998	998-1000*
1100	1210	32.9	1175.6	0-2	2-1098	1098-1100*
1200	1189	32.8	1161.3	0-2	2-1199	1199-1200*
1300	1170	32.8	1147.5	0-2	2-1299	1299-1300*
1400	1147	32.8	1130.2	0-2	2-1399	1399-1400*
1500	1124	32.8	1111.2	0-2	2-1499	1499-1500*
1600	1097	32.7	1088.2	0-3	3-1598	1598-1600*
1700	1063	32.5	1056.9	0-3	3-1698	1698-1700*
1800	1024	32.1	1018.0	0-3	3-1798	1798-1800*
1900	980	31.5	970.3	0-3	3-1898	1898-1900*
2000	928	30.7	910.9	0-4	4-1998	1998-2000*

\* Target danger area is stated in terms of trajectory of the M430 round in relationship to the 5 meter safety height. It is not based on the effective casualty radius (ECR) of the bursting round. However, the commander must consider the 15 meter ECR when integrating target suppression and troop movement.

**Table IVa****Target Above Gun—How to Use**

This table combines the angle of site with the angle of elevation when the target is above the gun and gives directly the quadrant elevation in mils. For ranges not in even hundreds, and for VI's not tabulated, the elevation must be determined by interpolation.

Example The range to the target is 1200 meters. The VI is +30 meters. In the column headed 1200, look opposite the number 30 in the column headed VI. The quadrant elevation is 187.0 mils.



**Table IVa**  
**Quadrant Elevation in Mils, Knowing Range, and Vertical Interval in Meters—Target Above Gun**

VI in Meters	Horizontal Distance From the Gun in Meters																					
	100	200	300	400	500	600	700	800	900	1000	1100	1200	1300	1400	1500	1600	1700	1800	1900	2000	2100	2200
100	809.1	491.1	356.8	289.2	252.4	232.0	222.6	219.2	220.8	226.9	235.9	248.3	263.5	282.0	303.5	329.1	358.3	393.5	434.4	490.8	570.2	
95	782.9	470.5	341.4	277.1	242.6	223.7	215.4	212.9	215.1	221.7	231.2	243.9	259.4	278.1	299.9	325.4	354.9	390.2	430.9	487.1	565.6	
90	755.5	449.5	325.9	265.0	232.7	215.4	208.2	206.5	209.4	216.6	226.5	239.5	255.4	274.3	296.2	321.9	351.5	386.8	427.5	483.5	561.1	
85	726.7	428.1	310.2	252.9	222.7	207.0	201.0	200.1	203.7	211.4	221.8	235.1	251.3	270.4	292.5	318.4	348.0	383.4	424.1	480.4	556.7	
80	696.3	406.3	294.4	240.6	212.8	198.6	193.8	193.8	198.0	206.3	217.0	230.8	247.2	266.6	288.9	314.9	344.6	380.0	420.7	476.2	552.3	
75	664.5	384.1	278.5	228.3	202.9	190.2	186.5	187.3	192.3	201.0	212.3	226.4	243.1	262.7	285.2	311.4	341.2	376.7	417.3	472.6	547.9	
70	631.1	361.6	262.4	215.9	192.8	181.8	179.2	181.0	186.6	195.9	207.6	222.0	239.0	258.9	281.6	307.8	337.8	373.3	413.9	468.9	543.6	
65	596.1	338.7	246.2	203.5	182.7	173.4	171.9	174.6	180.9	190.7	202.9	217.6	234.9	255.0	277.9	304.3	334.4	370.0	410.5	465.4	539.4	
60	559.5	315.5	229.9	191.1	172.7	165.0	164.7	168.2	175.3	185.6	198.1	213.2	230.8	251.2	274.3	300.9	331.0	366.6	407.1	461.8	535.2	720.5
55	521.2	292.0	213.5	178.5	162.6	156.5	157.4	161.8	169.5	180.4	193.4	208.9	226.8	247.3	270.6	297.4	327.6	363.3	403.7	458.3	531.1	700.4
50	481.3	268.1	197.0	166.0	152.5	148.0	151.1	155.4	163.8	175.2	188.6	204.5	222.7	243.5	267.0	293.8	324.2	359.9	400.4	454.7	527.0	687.4
45	439.7	244.1	180.4	153.4	142.4	139.5	142.8	149.0	158.0	170.0	183.9	200.1	218.6	239.7	263.3	290.4	320.9	356.6	398.0	451.2	522.9	676.8
40	396.5	219.7	163.8	140.8	132.3	131.0	135.5	142.5	152.3	164.9	179.1	195.8	214.5	235.8	259.7	286.9	317.5	355.3	393.7	447.6	518.9	667.6
35	351.9	195.1	147.0	128.2	122.1	122.6	128.3	136.1	146.5	159.7	174.4	191.4	210.4	232.0	256.1	283.4	314.1	350.0	390.4	444.2	514.9	659.2
30	305.9	170.2	130.2	115.5	111.9	114.0	120.9	129.8	140.9	154.5	169.7	187.0	206.4	228.1	252.4	279.9	310.7	347.6	387.0	440.8	510.9	651.5
25	258.5	145.2	113.4	102.8	101.7	105.6	113.6	123.3	135.1	149.3	164.9	182.6	202.3	224.3	248.8	276.4	307.4	343.3	383.7	437.3	507.0	644.3
20	210.0	120.1	96.5	90.1	91.5	97.0	106.3	116.9	129.4	144.1	160.2	178.2	198.2	220.5	245.2	272.9	304.0	340.0	380.4	433.9	503.1	637.6
15	160.6	94.8	79.6	77.4	81.3	88.5	99.0	110.5	123.7	139.0	155.5	173.9	194.1	216.7	241.5	269.4	300.6	336.7	377.1	430.4	499.2	631.1
10	110.4	69.4	62.6	64.6	71.1	80.0	91.7	104.1	117.9	133.8	150.7	169.5	190.1	212.8	237.9	266.4	297.3	333.4	373.8	427.0	495.4	624.9
5	59.9	44.0	45.6	58.9	60.9	71.4	84.3	97.7	112.2	128.6	146.1	165.1	186.0	209.0	234.3	262.5	293.9	330.2	370.5	423.6	491.6	618.9

**Table IV b****Target Below Gun—How to Use**

This table combines the angle of site with the angle of elevation when the target is below the gun and gives directly the quadrant elevation in mils. For ranges and VI's that are not tabulated, the elevation must be determined by interpolation.

Example The range to the target is 1200 meters. The VI is -30 meters (target below gun). In the column headed 1200, look opposite the number 30 in the column headed VI. The quadrant elevation is 134.6 mils (negative).

**Table IVb**

**Quadrant Elevation in Mils, Knowing Range, and Vertical Interval in Meters—Target Below Gun**

VI in Meters	Horizontal Distance From the Gun in Meters																					
	100	200	300	400	500	600	700	800	900	1000	1100	1200	1300	1400	1500	1600	1700	1800	1900	2000	2100	2200
-5	-41.9	-7.2	11.6	26.4	40.5	54.4	69.7	84.8	100.7	118.3	136.6	156.4	177.9	201.4	227.0	255.6	287.2	323.6	365.6	416.9	484.1	607.6
-10	-92.6	-32.2	-5.5	13.6	30.3	45.9	62.4	78.4	95.0	113.0	130.8	152.0	173.8	197.5	223.4	252.1	283.9	320.3	362.4	413.5	480.3	602.2
-15	-142.8	-58.0	-22.5	.9	20.1	37.4	55.1	71.9	89.3	107.9	127.0	147.7	169.7	193.7	219.8	248.7	280.6	317.1	359.1	410.1	476.6	596.9
-20	-192.2	-83.3	-39.4	-11.4	9.8	28.9	47.8	65.5	83.6	102.7	122.4	143.3	165.7	189.9	216.2	245.2	277.2	313.8	355.9	407.1	473.0	591.8
-25	-240.6	-108.4	-56.3	-24.1	0.0	20.4	40.4	59.1	77.9	97.6	117.7	138.9	161.6	186.1	212.6	241.7	273.9	310.6	352.6	403.4	469.3	586.7
-30	-288.0	-133.4	-73.1	-36.8	-10.1	11.9	33.1	52.7	72.2	92.5	112.9	134.6	157.3	182.3	209.0	238.3	270.6	307.3	349.4	400.1	465.7	581.8
-35	-344.0	-158.2	-89.9	-49.4	-20.2	3.4	25.8	46.3	66.5	87.3	108.2	130.4	153.3	178.5	205.4	234.8	267.3	304.1	346.2	396.8	462.1	577.0
-40	-378.7	-182.8	-106.6	-62.1	-30.4	-4.4	18.5	39.9	60.8	82.0	103.5	125.9	149.2	174.7	201.8	231.4	263.9	300.8	342.9	393.5	458.5	572.2
-45	-421.8	-207.2	-123.3	-74.7	-40.5	-13.0	11.3	33.5	55.1	76.9	98.8	121.5	145.2	170.9	198.2	227.9	260.6	297.6	339.7	390.2	454.9	567.6
-50	-463.4	-231.3	-139.9	-87.3	-50.6	-21.4	4.0	27.2	49.3	71.8	94.0	117.2	141.2	167.1	194.6	224.5	257.3	294.3	336.5	386.9	451.4	563.0
-55	-503.3	-255.1	-156.4	-100.0	-60.7	-29.9	-3.3	20.8	44.7	66.6	89.4	113.0	137.3	163.3	191.0	221.1	254.0	291.1	333.3	383.7	447.8	558.5
-60	-541.6	-278.6	-172.7	-112.2	-70.7	-38.2	-10.7	14.4	38.0	61.5	84.7	108.5	133.3	159.5	187.4	217.7	250.7	287.9	330.1	380.4	444.3	554.1
-65	-578.2	-301.8	-189.0	-124.7	-80.8	-46.7	-17.8	8.0	32.3	56.3	79.9	104.2	129.2	155.7	183.8	214.2	247.4	284.7	326.9	377.1	440.8	549.7
-70	-613.2	-324.7	-205.1	-137.1	-90.8	-55.1	-25.0	.8	26.6	51.2	75.3	99.8	125.2	151.9	180.3	210.8	244.1	281.5	323.7	373.9	437.4	545.4
-75	-646.5	-347.2	-221.2	-149.4	-100.8	-63.5	-32.2	-4.7	20.9	46.0	70.6	95.5	121.2	148.2	176.7	207.4	240.8	278.3	320.6	370.7	433.9	541.1
-80	-678.4	-369.3	-237.1	-161.7	-110.8	-71.9	-39.5	-11.0	15.3	41.0	65.9	91.2	117.2	144.4	173.1	204.0	237.6	275.1	317.4	367.4	430.0	536.9
-85	-708.6	-391.1	-252.9	-173.9	-120.7	-80.2	-46.7	-17.4	9.6	35.9	61.2	85.9	113.1	140.6	169.5	200.6	234.3	271.9	314.2	364.2	427.0	532.8
-90	-737.5	-412.4	-268.6	-186.0	-130.6	-88.5	-53.8	-23.7	4.0	39.7	66.6	92.6	119.1	146.6	176.0	207.2	241.0	278.7	321.1	371.1	432.6	528.7
-95	-764.9	-433.4	-284.1	-198.2	-140.5	-96.9	-61.0	-30.0	-1.7	25.1	51.9	78.2	105.1	133.1	162.4	193.8	227.7	265.5	307.9	357.8	420.3	524.6
-100	-791.0	-453.9	-299.4	-210.2	-150.3	-105.1	-68.2	-36.3	-7.2	20.5	47.2	73.9	101.1	129.3	158.8	190.4	224.5	262.3	304.8	354.6	416.9	520.6

**Table V****Trajectory Chart—How to Use**

To determine the quadrant elevation to a target at a given range and VI, with the trajectory chart, find the point of intersection of the vertical line corresponding to the given range and the horizontal line corresponding to the given VI (plus, if the target is above the gun; minus, if below). If this point lies on a black trajectory curve, the elevation in mils may be read directly from the curve. If the point lies between two curves, multiply the proportion of the distance from the lower curve to the upper by 10 and add this to the elevation shown on the lower curve. If it is required to clear a mask at a given range and VI, plot the mask in the same way as the target. At the same range, locate the position of the trajectory to the target. Above these points, at the top of the chart, is given the distance of

the lowest show below the center of the cone. Measure off this distance below the trajectory and plot the position of the lowest shot. If this is above the mask, it will be cleared. If it falls only a small distance below the mask, it may still be practical to fire, as the majority of shots may clear the mask.

Example: The range to the target is 1500 meters; VI, 15 meters. Plot the target directly above the range of 1500 meters and to the right of the VI of 0 meters. This point lies 0.8 of the distance from the curve for an elevation of 200 mils to that for 250 mils. Multiply  $0.8 \times 50 = 240$  mils. The quadrant elevation to the target is  $200 + 40 = 240$  mils.

## Appendix D

# Destruction of Machine Guns

## 1. General

The decision to destroy the gun to prevent its capture and use by the enemy is a command decision and will be ordered and carried out only on authority delegated by the major unit (battalion and above) commander.

The machine gun and mount are destroyed *only* when they are subject to capture or abandonment. Destruction must be as complete as circumstances permit.

Lacking time for complete destruction, only those parts essential to operation of the gun are destroyed, beginning with those parts most difficult for the enemy to duplicate. The same parts of each gun are destroyed to prevent the reconstruction of a complete gun from several damaged guns.

## 2. Methods of Destruction

### a. Disassembly and Smashing

(1) **M2.** Disassemble as completely as time permits. Use the barrel as a sledge. Raise the cover and smash the cover forward and down, toward the barrel support. Smash the backplate group. Remove the firing pin from the bolt; place the striker in the hole in the face of the bolt and bend it until broken. Remove the barrel buffer tube lock assembly from the barrel buffer body group and bend and deform it. Smash and bend the breech lock depressors. Place the barrel extension in the rear of the receiver. With the barrel extension shank protruding, knock off the shank by

striking it with the barrel at the sideplate corners nearest the feedway. Smash the extractor.

(2) **M240G.** Disassemble as completely as time permits. Using the barrel or some other heavy equipment, smash the cover, feedtray, receiver group, operating group, buffer, stock, and gas cylinder.

(3) **MK-19.** Disassemble as completely as time permits. Remove the bolt and backplate assembly and smash it against the receiver assembly, disfiguring the bolt and backplate assembly to a point where it will no longer fit into the receiver assembly. Smash the top cover assembly using the bolt and backplate assembly or some other heavy object.

(4) **Disposal of parts.** Bury the disassembled weapon in suitable holes or dump parts into streams, mud, snow, sumps, or latrines.

(5) **Mounts and traversing mechanism.** The mount and traversing and elevating mechanism can be destroyed by smashing them with the machine gun barrel or other heavy objects. Bend the tripod legs.

**b. Thermite Grenade.** By placing a thermite grenade on the cover assembly, cover group, or top cover, as appropriate, with the gun material on the tripod, the gun and mount will be destroyed. Component parts should be placed near the grenade to ensure their destruction.

**c. Demolitions.** Composition 4 (C4) molded inside the receiver and around the mount, when exploded, will render the machine gun inoperable.

## Appendix E

# Infantry Plotting Board M17

### 1. Description

The M17 plotting board is a fire-control instrument designed to help the operator in computing and plotting firing data. It consists of a transparent, rotatable plotting disk attached to a flat base. (See figure E-1.) It is sturdy, simple to operate, accurate, and easily adaptable to use in the field. It is carried in a durable canvas case. In addition to the M17 plotting board, there are still many M10 infantry plotting boards in use. The M10 and the M17 are almost identical; the only difference being that the triple map scale dis-

played on the bottom right of the base is in meters on the M17 and in yards on the M10. Both the M17 and M10 plotting boards can be used in executing the procedures outlined in this appendix and in appendix F.

**a. Base.** The base (see figure E-2) is square on one side and semicircular on the other. Printed on the base and directly under the disk is a circular area marked with a rectangular grid printed in red. Note the *red base index line with the arrow*. The index line is graduated outward from the center (pivot point) from 0 to 20 in hundreds of meters. These numbers are spaced

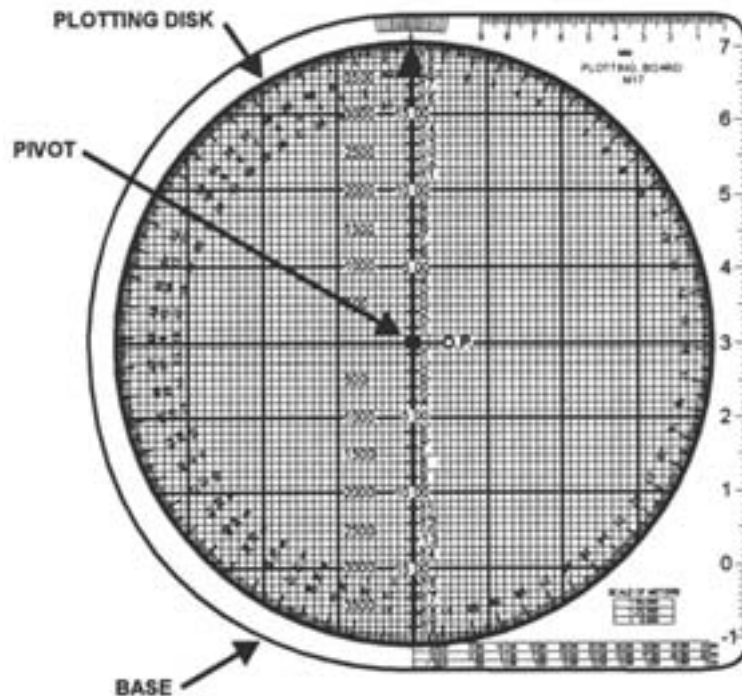

Figure E-1. M17 Plotting Board.

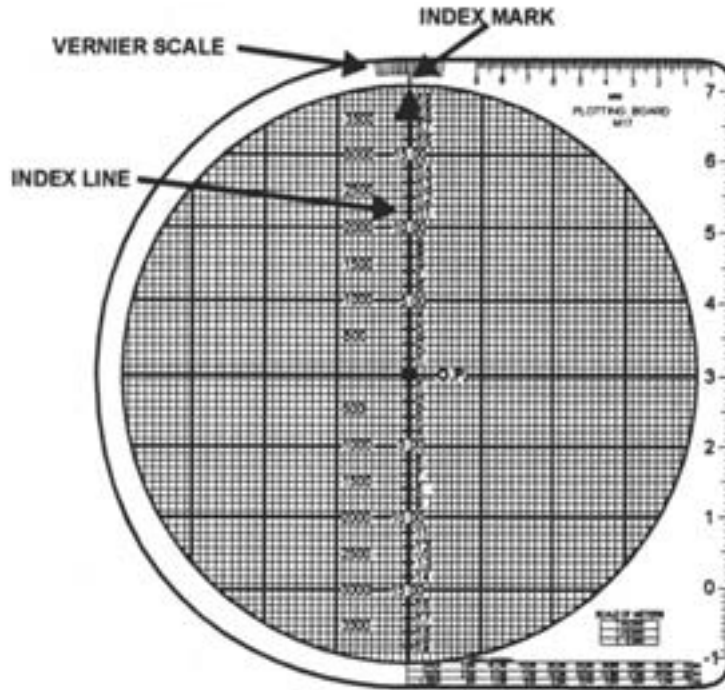

Figure E-2. Base.

at every second horizontal fine line. Each small grid square is, therefore, 50 meters on a side. To the left of the index line are figures giving double values for the grid squares. At this scale, each small grid square is 100 meters on a side. However, *any value may be assigned to the small grid square which best suits the problem at hand.*

The red arrow of the base index line points to a red "0" and a fine red line which extends to the edge of the plotting board (through the center of the vernier scale). This fine red line is the *index mark* on the base *at which all deflections or azimuths are read.* The base is oriented when the *red arrow* of the index line is at the top (pointing away from the operator) and the square side is to the operator's right. The pivot point, designated by the letters OP, represents

the location of the observation post, or of a firing position, as desired.

Besides the grid scales, there are printed on the base three scales for measuring and a vernier scale for greater accuracy in using the mil scale on the disk. These scales are:

- At the bottom of the base is a *triple map scale* in meters (yards with the M10) with its legend above it, with representative fractions of 1/50,000; 1/25,000; and 1/5,000. These representative fractions refer respectively to the top, middle, and lower scales. Use these scales to transfer data to or from a map or firing chart which has one of these scales.
- At the right side is a *scale of inches* in 10ths, numbered from 0 to 7 inches and having an extension divided into 20ths.

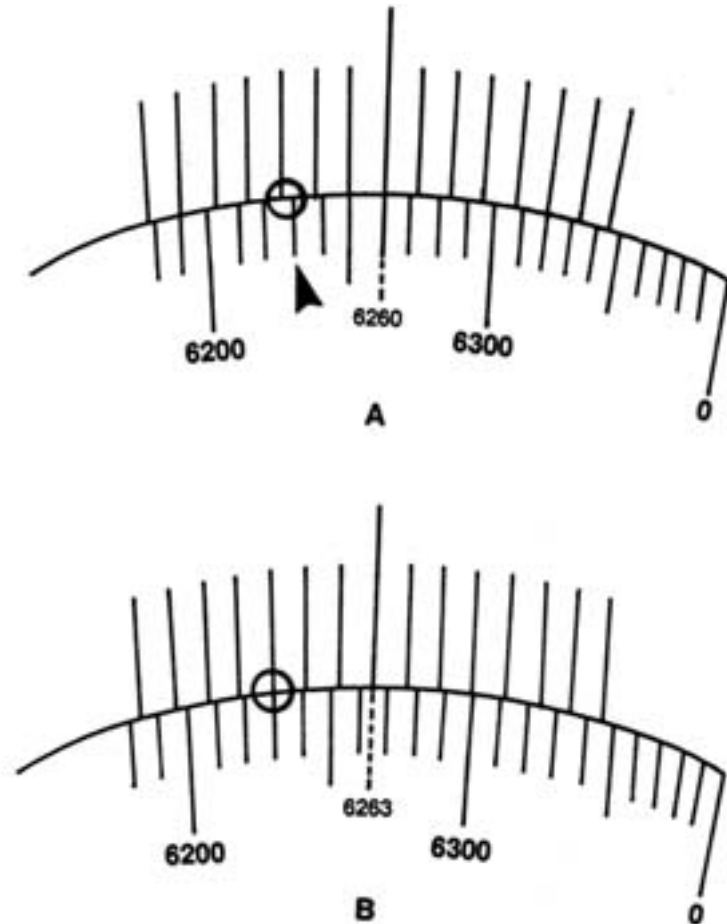

Figure E-3. Example of Use of Vernier Scale.

- At the top is a *scale in centimeters*, divided into millimeters, and numbered from 1 to 9.
- Opposite the red arrow of the index line is a *vernier scale* for use with the mil scale on the disk. By means of this scale, it is possible to lay off an azimuth reading with great accuracy by using the method illustrated below. For example, to lay off an azimuth of 6,263 mils:
  - Set the graduation on the mil scale which represents 6,260 mils opposite the 0 line of the vernier scale. (See figure E-3A.)
  - To add the final 3 mils, count, on the vernier scale, three lines to the left from the 0 line.
  - Note the line on the mil scale which lies next inside it (toward the 0 line of the vernier scale),

and rotate the top disk until the two lines coincide. The desired azimuth is now directly opposite the point of the index line as shown in figure E-3B.

**b. Plotting Disk.** The plotting disk (see figure E-4) is made of a plastic material that is roughened on the upper surface to receive pencil marks. Four scales and a fine black line are printed on the disk.

A complete mil scale (referred to later as the mil scale) is printed in black, running around the outer edge in a clockwise direction to conform to the compass for plotting azimuth angles. This scale is divided in 10-mil increments and numbered in hundreds of mils from 0 to 6400.



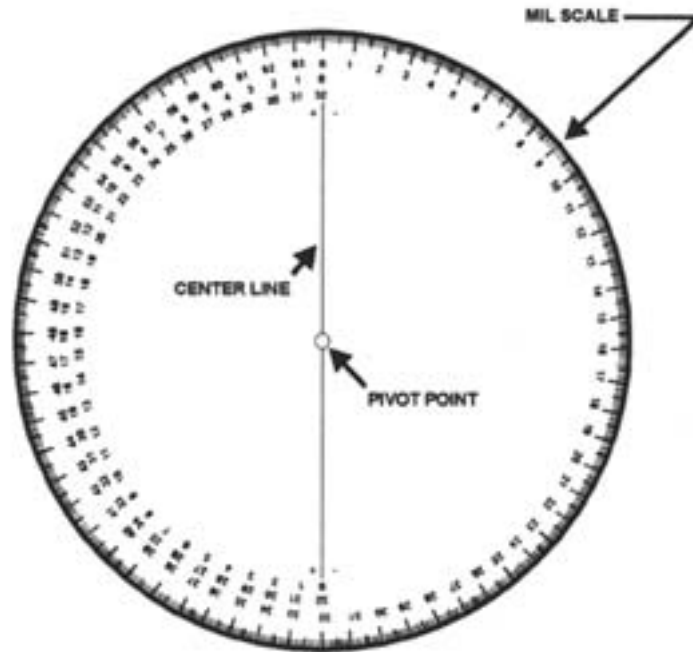

**Figure E-4. Rotatable Plotting Disk.**

A supplementary scale (the middle scale) is printed in red, running counterclockwise from 0 to 3200 and 3200 to 500. This middle scale is numbered in hundreds of mils. It is used in computing angles of site for weapons other than mortars.

A second supplementary mil scale (the inner scale) is printed in black and runs clockwise. The 0 of this scale appears under the 3200 on the *mil scale*. This scale is numbered in hundreds of mils from 0 to 3200. It is used in computing angles of site for weapons other than mortars.

## 2. Operations With Plotting Board

**a. General.** The theory of operation of the plotting board is basically simple, and the accuracy of the results obtained is limited by the exactness of the

operator. The plotting board is used to plot accurately the relative positions of the machine guns, registration points, and targets, and to determine the direction and distance between these points. Since the size of the dots placed on the board affects the accuracy of the data determined, dots must be made as small as possible. To make it easier to locate these small dots, they may be encircled. In computing the data, be careful to use the dot and not the circle.

Any arbitrary point on the disk may be selected as the machine gun position or the OP. Whenever possible, the center (pivot point) of the board is used to represent the machine gun position.

To plot a point with a given azimuth and distance from another point, proceed as follows:

- Use the pivot as the first point.
- Rotate the disk until the stated azimuth is indicated over the index line.
- To determine the distance on the plotting board from the first point to the second point, divide the stated distance by 50 or 100, depending on which scale on the base is used. The result is the number of squares on the base between the two points. Count off the number of squares or fractions of squares thus determining from the first point *toward the top of the plotting board*, and plot the second point. The second point may be plotted also by measuring off the stated distance from the first point *toward the top of the plotting board using the range scales on the base*.

When two or more points have been placed on the plotting board in this manner, it is possible to determine the distance between any two given points and the azimuth from one point to the other.

To determine the azimuth between two plotted points, the operator must remember that all parallel lines have the same azimuth. Therefore, when a particular azimuth is rotated over the index, every vertical line on the grid is pointing along the same azimuth. This means also that the azimuth of any of the vertical lines of the grid is read at the index mark. To find the azimuth of a given point with respect to another, rotate the disk until the two pencil dots lie along one of the vertical lines on the grid base or until they are the same distance from the same vertical line with the given dot (target) toward the top of the plotting board. The azimuth may then be read on the mil scale at the index on the base.

Determine the range between the dots in meters by counting the number of small grid graduations separating them when in this position and multiplying this number by 50 or 100, depending on which scale on the base is used. The range can also be determined by measuring the distance, using one of the range scales on the base.

**b. Sample Problem One.** This problem determines the azimuth and range from a new machine gun firing position to the target:

**(1) Given.** Machine gun position at the center (pivot point) of the disk.

- Machine gun position to new position: Azimuth 4,150 mils; distance 550 meters.
- Machine gun position to target: Azimuth 5,750 mils; distance 1,500 meters.

**(2) Procedure.** To determine the azimuth and range from the new machine gun position to the target, using the range scale along the index line (where the smallest grid graduation represents 50 meters), proceed as follows:

- Rotate the disk until 4150 mils is read over the index on the base. Mark the disk with a pencil dot over the index line at the 550-meter graduation. This dot represents the location of the new mortar position.
- Rotate the disk until 5750 mils is read over the index on the base. Mark the disk with a pencil dot over the index line at the 1500-meter graduation. This dot represents the location of the target.
- Rotate the disk until an imaginary line connecting the two pencil dots becomes parallel with the index line. Rotate it in such a direction *that the dot representing the location of the target (TGT) is toward the top of the board*.
- The azimuth GUN-TGT is then read at the index mark on the base as 6110 mils. The total number of meters between the pencil dots when in the parallel position (1,400 meters above the horizontal grid line passing through the pivot plus 200 meters below) is the range GUN-TGT: 1,600 meters.

**c. Sample Problem Two.** This problem involves the solving of survey notes:

(1) **Given.** A machine gun squad is placed in position by team, each team in a different location. The first team is plotted at the pivot point of the plotting board. The second team is located (surveyed) with reference to the first team by compass and pacing. A traverse of two legs is made to the second team from the first team as follows:

- First leg: Azimuth 4,800; distance 200 meters.
- Second leg: Azimuth 5,400, distance 250 meters.

(2) **Procedure.** To plot the location of the second team with reference to the first team, proceed as follows:

- Use the range scale along the index line.
- Rotate the disk until azimuth 4800 is at the index. Count up 200 meters along the red index line and make a pencil dot.
- Rotate the disk until azimuth 5400 is at the index. From the pencil dot just plotted, count up to 250 meters and make a pencil dot. This is the location of the second team. The same procedure would be used to locate the other machine gun teams of the section.
- To determine the azimuth and direction from the first team to the second team, rotate the disk until the plotted location of the second team is toward the top of the plotting board and is on the same vertical line or the same distance from the same vertical line as the first team plot (in this case on the red index line). The azimuth is 5,120 mils and the distance is 425 meters.

**d. Other Uses for Plotting Board.** In addition to the examples illustrated above, the plotting board can be used to compare angles of size, to make simple sketches which require azimuths and pacing, to follow azimuths for various paced distances, to indicate the friendly frontline, and as a firing chart to compute firing data for one or more indirect fire weapons.

### 3. Plotting Board Used as an Observed Firing Chart

The plotting board is used as an observed firing chart on which the locations of the registration points are plotted in relation to the firing position from data obtained by registration firing (fire adjustment).

The pivot point of the plotting board is arbitrarily selected as the location of the base machine gun (usually left flank gun) in the firing position. The registration data (GUN-TGT range and corrected magnetic azimuth) determined by adjusting on the registration point are then used to plot the location of the registration point with respect to the firing position. New targets reported by OPs are plotted on the firing chart with respect to the registration points or other reference points (such as targets previously adjusted upon, or OP locations) whose chart locations are known. An observed firing chart permits accurate firing at night or under conditions of poor visibility on any target whose chart location is known.

The observed firing chart is used to:

- Plot the location of the registration point with respect to the firing position (base machine gun).
- Plot the location of OPs when their location is known or desired.
- Plot new targets reported by OPs with respect to reference points (such as reference points, or previously fired targets) whose chart locations are known.
- Plot new targets by polar coordinates when the observer's location is known.
- Plot new targets by grid coordinates when the observer has a map.
- Determine the GUN-TGT range and direction.
- Determine special corrections for each machine gun to fit a target of special shape.

- Mass fires of the section on any target whose chart location is known.
- Plot the location of friendly forward elements (front line troops).

Frequently the observer requesting indirect machine gun fire support does not have a map to determine coordinates. His target designation is usually made with reference to a point whose chart location is known. When a new target is reported with reference to a target previously fired upon and plotted on the firing chart, the firing data (range and direction) is determined with the plotting board. When the fire mission is completed, the target is replotted using the adjusted fire data (data for replot). However, if too many targets are plotted on the plotting board, the chart (plotting board) becomes so cluttered with detail that it hampers the conduct of subsequent fire adjustments. Therefore, it is desirable to plot on the plotting board only those targets that are likely to be used by observers as reference points for reporting the location of new targets.

If a new target is reported with reference to a previous target whose chart location is known and whose plot has been removed from the plotting board, the latter target (reference point) is replotted on the plotting board for this particular fire mission. The data for replotting this target (reference point) on the plotting board is obtained from the target data worksheet.

Maps and photomaps may be used to plot targets on the firing chart which are located and reported by map or photomap coordinates.

Firing data (range and deflection) is determined on the plotting board with respect to the previously plotted point. A protractor and ruler or a compass are used in determining initial firing data from a map.

#### **4. Plotting Board Used for Indirect Fire**

For detailed information concerning utilization of the infantry plotting board in computing data for indirect fire, see appendix F.

## Appendix F

# Adjustment of Indirect Machine Gun Fire

### 1. General

**a. Accuracy.** Since indirect machine gun fire is very difficult to adjust, it is imperative that firing data be obtained and computed accurately. To do this requires a knowledge of the characteristics of fire, machine gun drill, control instruments, mil formula, and firing tables. The computation of firing data demands exactness and close attention to detail. Proficiency in this is acquired by practice in solving indirect laying problems.

**b. Source of Firing Data.** These data are obtained from a map, terrain measurement, or by the terrain-observer-gun (TOG) method. The TOG method is the more accurate but is more complex to compute. It is explained in greater detail in paragraph 2. The map method is more practical and is more applicable to rapid field utilization. The map method is also explained in paragraph 2.

### 2. Fundamentals

**a. Essential Factors of Indirect Laying.** Four essential factors must be considered in indirect laying. These are direction, elevation, mask clearance, and troop safety.

**b. TOG Method.** The observer occupies an observation post (OP) from which he can see the gun position (if possible), the mask, friendly troops if present, and the targets. The observer draws a diagram to scale of these various positions in relation to the OP, using a compass to determine their magnetic azimuths and a map to determine their distance from the OP. He also measures the angle of site to targets, guns, and mask. The data obtained are recorded. The M17 plotting board provides a rapid and convenient means of calculating and plotting TOG data.

**c. Map Method.** Plot accurately on the map the positions of single guns or of the flank guns of a battery, target flanks, friendly troops, and the initial aiming point (IAP). Draw lines connecting the gun positions with the appropriate target and from the single gun or base gun of the squad or section to the IAP. Locate the probable mask by inspection or as described in chapter 6, section XII. Obtain ranges by applying the map scale and vertical intervals (VIs) by means of the map contour lines. Quadrant elevation (QE) for target, clearance, and safety are extracted from the appropriate table IVa or IVb. The section leader/fire direction noncommissioned officer (NCO) computes direction changes from the plotting board and then conducts a map inspection. This technique is further explained in paragraph 3b.

### 3. Technique

**a. General.** Adjustment of indirect machine gun fire can be accommodated by a combination of data from both the M10/M17 plotting board and information extracted from the appropriate firing tables contained herein.

The plotting board will usually be maintained by the machine gun section leader (fire direction NCO) or other personnel as designated by the weapons company commander. The fire direction NCO should be located at the gun position and have positive communications (radio or wire) with the observer.

#### b. Procedure

**(1) Adjustment or Correction to Machine Gun Indirect Fire.** Adjustment or correction to machine gun indirect fire is a factor of both deflection or direction (traverse right or left) and elevation (range). The adjustment or correction for deflection is taken from

the plotting board, regardless of machine gun type. Corrections or adjustment to range are dependent upon the specific ballistics characteristics of the type round and must be extracted from the appropriate firing table.

**(2) Use of Plotting Board.** The pivot point of the plotting board becomes the location of the base gun. The base gun (all guns) are laid on the gun-target (GUN-TGT) azimuth. All guns set zero deflection to correspond to the GUN-TGT azimuth. (Machine guns are normally positioned 50 meters apart.) The beaten zone for four machine guns, each laid on the GUN-TGT line with a range to target of 1,400 meters, is as depicted in figure F-1.

The fire direction NCO rotates the disk until the azimuth read over the index on the base is the same as the azimuth on which the guns are laid. A mark (?<sup>1</sup>) is then made on this line, The GUN-TGT line at the appropriate range. Figure F-3 shows a GUN-TGT direction of 1400 mils at a range of 1,400 meters.

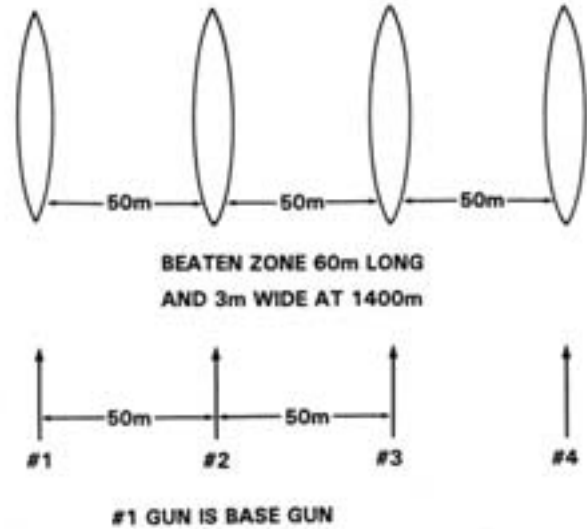

Figure F-1. Parallel Sheaf.

**Note:** Only gun #1 (base gun) is laid on the true GUN-TGT line, the other three guns are laid on the same GUN-TGT azimuth which result in four parallel sheafs. In order to maximize the effects of indirect fire, guns #2, #3, and #4 must be adjusted so their beaten zone will correspond to that of gun #1. Once adjusted, further corrections on searching-traversing will be in unison. A single, four-gun sheaf as depicted in figure F-2 is accomplished through application of the width equals range times mils (WERM) rule.

**Example:** A reconciliation of the problem depicted in figure F-1 to that shown in figure F-2 is accomplished as follows:

- Gun #1 is laid on the true GUN-TGT line. All guns laid on GUN-TGT azimuth. Guns 50 meters apart. Range to target is 1,400 meters.
- Adjustment for gun #2:
 
$$\frac{R}{WM} = \frac{1,400 \text{ meters or } 1.4 \text{ meters}}{50 \text{ meters}} = 70 \text{ mils}$$

Command: Gun #2, left 70.
- Adjustment for gun #3:
 
$$\frac{R}{WM} = \frac{1.4 \text{ meters}}{*100 \text{ meters}} = 140 \text{ mils}$$

\*Gun #3 is 100 meters from gun #1.  
Command: Gun #3, left 140.
- Adjustment for gun #4:
 
$$\frac{R}{WM} = \frac{1.4 \text{ meters}}{150} = 210 \text{ mils}$$

Command: Gun #4, left 210.
- The beaten zone for the four guns now corresponds to that depicted in figure F-2. The searching and traversing commands will now be the same for all guns.

**Figure F-2. Single Sheaf (After Application of the WERM Rule).**

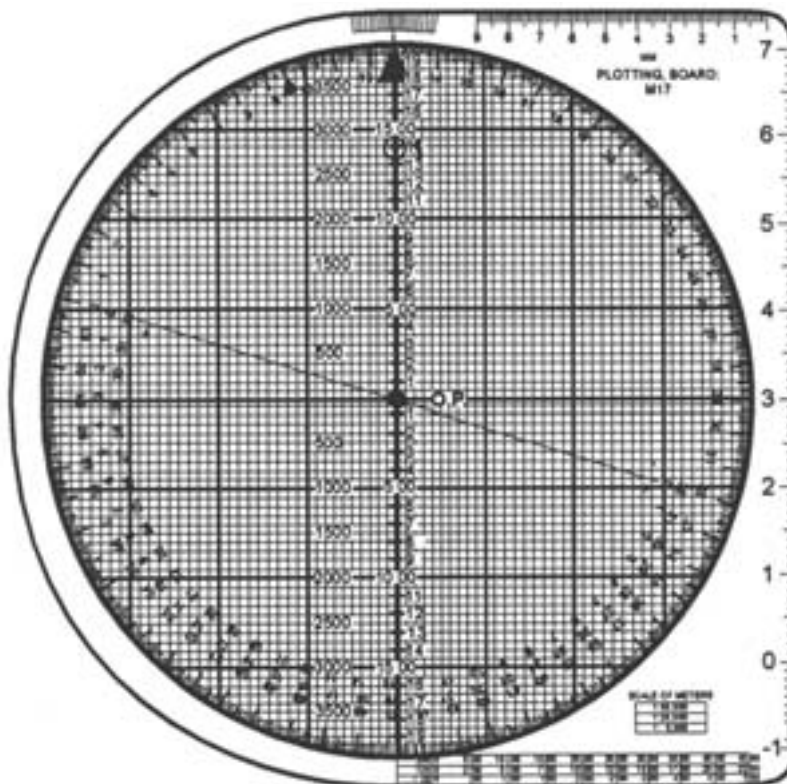

**Figure F-3. GUN-TGT Azimuth  
(GUN-TGT Azimuth of 1400 Mils; Range 1,400 Meters).**

As soon as the observer reports the observer-target (O-T) direction, the fire direction NCO marks with an OP symbol (D) the graduation on the mil scale of the plotting board which corresponds to the O-T direction reported by the observer. Figure F-3 shows an O-T direction of 950 mils.

After orienting the plotting board on the O-T direction, the machine gun section leader alerts the observer that they are prepared to fire an initial burst. A 40- to 50-round burst is fired by gun #1 and the observer is informed that the rounds are on the way. The fire direction NCO plots subsequent corrections reported by the forward observer (FO) by moving right or left as directed by the observer from the previous plot along a grid line perpendicular to the index line on the base and adding or dropping as directed by the observer

along the index line or one of the grid lines parallel to it. Figure F-4 shows the plot of the observer's subsequent correction of: **RIGHT TWO HUNDRED, ADD TWO HUNDRED**. Subsequent corrections throughout an adjustment are plotted in a similar manner for each volley fired, moving from the location of the previously plotted point (target location).

After plotting the forward observer's corrections, the fire direction NCO rotates the disk of the plotting board until the pencil dot representing the last correction from the observer is directly over the index line on the base. The direction is then read on the base, and a deflection correction announced to the guns. The range at which the next volley is fired is determined by referring to the range scale along the index line. (See figure F-5.)

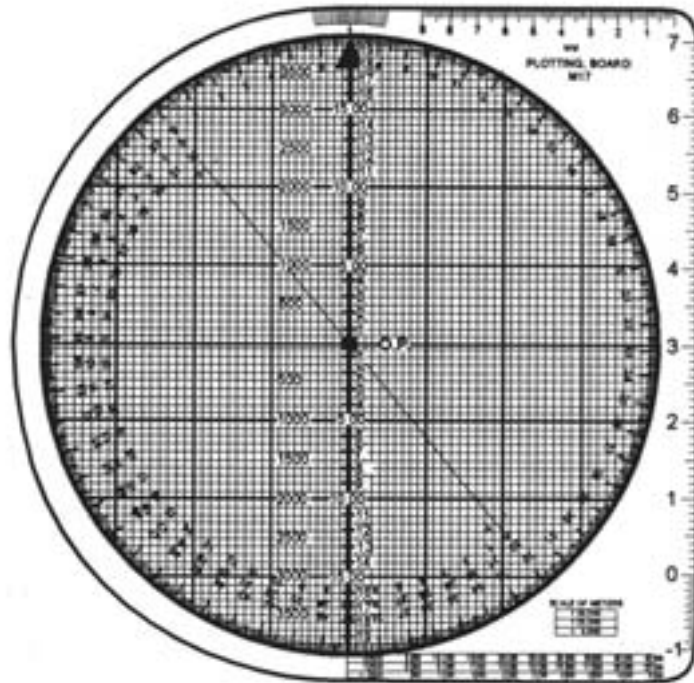

Correction: RIGHT 200 METERS, ADD 200 METERS.

Plotter moves from initial plotted point (#1) right four small grid graduations (200 meters), up four small grid graduations, and marks initial registration point with a pencil dot (⊙).

Figure F-4. Observer's Corrections.

After the deflection change is given, the correction in elevation to account for the new range must be determined. Evaluation or target distance data is computed in accordance with the instructions contained in the following paragraphs.

**(3) Correction for Range.** *The correction for range is dependent upon the specific weapon system and must be extracted from the various tables contained in appendix A (M240G), appendix B (M2 .50 cal), or appendix C (MK-19). Regardless of the weapon, three requirements must be considered. These requirements include:*

- Quadrant elevation (always required).

- Mask clearance (may not be a factor). Mask is any terrain feature or object that screens the target from the gun.
- Overhead fire (troop safety; may not be a factor).

**(4) Elevation Data.** To obtain the quadrant elevation of the guns to the target, it is necessary to know ranges and the vertical interval (relative vertical location of the target in relation to the gun; i.e., target located above or below gun location) of the guns to the target. By means of a map, plot the locations of both the guns and target. Determine the elevation of both and the distance (height) the target is above or below the guns. Once



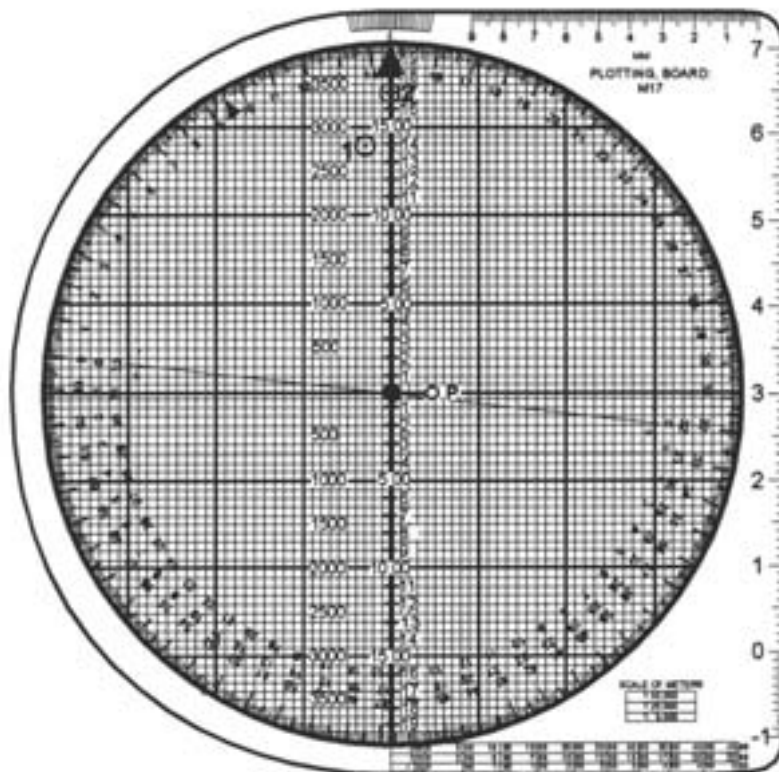

Corrections show a deflection of 1,460 mils and a range of 1,650 meters.  
Command for deflection change: RIGHT 60 MILS.

**Figure F-5. Deflection Correction.**

height relationship of the gun to target has been established, table IVa or table IVb (in appropriate appendix A, B, or C) is used to determine QE. For example, the target is located on an elevation that is 10 meters higher than the gun, and the range to target is 1,200 meters. The weapon being utilized is the caliber .50 machine gun. Table IVa (target above gun), appendix B (M2 .50 cal Firing Tables) is used. The table is entered at the appropriate VI, in this case 10, and is read across until the horizontal distance corresponds to target range. The resulting figure is the QE in mils. The correct QE for the above example is 22 mils. (See figure F-6). The elevation is placed on the machine gun by utilizing the clinometer contained in the M2 compass. Set the announced elevation on the clinometer; place the M2 compass on a flat surface on the feed cover; then raise

or lower the gun using the elevation hand wheel on the traversing and elevating mechanism.

**(5) Mask Clearance and Troop Safety.** Once the QE to target is determined, requirements for the rounds clearing any terrain elevation (mask) between the guns and target and friendly troop safety must be considered and calculations made to determine if the current QE will provide sufficient height to accommodate mask clearance and troop safety. The QE's for mask and/or troop safety may be obtained by determining VI and range to mask and/or troops from a map, and using the appropriate table IVa or IVb, substituting range to mask and/or troops for range to target, and moving across until the corresponding QE is obtained. (See figure F-6.)

Known VI	Range to Target																				QE in Mils					
VI	Horizontal Distance From the Gun in Meters																									
In Meters	100	200	300	400	500	600	700	800	900	1000	1100	1200	1300	1400	1500	1600	1700	1800	1900	2000	2100	2200	2300	2400	2500	
5										15	16	18	19	21	23	25	28	30	33	37	40	44	48	52	56	
10										20	21	22	23	25	28	31	33	36	39	43	46	50	54	58		
15										25	26	28	27	28	30	32	34	36	39	42	45	49	52	56	60	
20										30	30	30	31	32	33	35	37	39	41	44	47	51	54	58	62	
25										35	35	35	35	35	36	38	40	42	44	47	50	53	57	60	64	

Figure F-6. Quadrant Elevation, Table IVa, Target Above Gun.

The QE gun to target, minus the QE gun to mask and/or troops, equals the angle of mask or troop clearance. Obtain required mask clearance for the range (gun to mask) from the appropriate table III (mask clearance), and the required safety angle for the range gun to troop from the appropriate table II (overhead fire). If the angles of mask or troop clearance equal or exceed the required mask clearance or troop safety, respectively, the mask will be cleared and the troops will be safe.

The following examples of the map method are provided as sample problems and offer opportunity to gain proficiency in working with the various tables. Each example (figures F-7 through F-15) contains a schematic of the problem to include type weapon, VI's to target, mask, and troops; appropriate ranges; and a worksheet explaining data computation.

For shorter ranges, and when the troops and/or mask can easily be identified, clearance can be determined by use of the rear sight as explained as follows:

- Lay the gun to hit the target. Without moving the piece, set the sight at the corresponding range for troop safety or mask clearance as given in tables II and III. If the line of sighting thus established clears the mask (or troops), it is practicable to fire.

If no tables are available, the procedure is as follows: If the range to the mask is less than 500 meters, set the sight at the range to the mask plus 425. If the line of sighting thus established clears the mask, the cone of fire will clear. If the range to mask is 500 meters or greater, set the sight at the range to mask plus 300, and see if this line of sighting clears the mask. If there are friendly troops, the procedure is similar. The sight is set at the range to the troops plus 650, or at 1,525, whichever is the greater. This gives results which are sufficiently accurate for all practical purposes.



**TARGET DATA WORKSHEET**

MAP#      GUN AT Grid TARGET AT Grid MASK I AT Grid MASK II N/A  
 Troops at N/A

INFORMATION	CALCULATIONS
1. TARGET DIRECTION (MILS):	<u>as given</u>
2. RANGES	
A. GUN - TARGET:	<u>1850</u>
B. GUN - MASK I:	<u>600</u>
C. GUN - MASK II:	<u>N/A</u>
D. GUN - TROOPS:	<u>N/A</u>
	} <span style="border: 1px solid black; padding: 2px;">map distance</span>
3. ELEVATION (METERS)	
GUN:	<u>20</u>
TARGET:	<u>20</u>
MASK I:	<u>25</u>
MASK II:	<u>N/A</u>
TROOPS:	<u>N/A</u>
	} <span style="border: 1px solid black; padding: 2px;">obtained from map contour</span>
4. ELEVATION DATA (FROM MAP & TABLES)	
A. GUN - TARGET	<u>0</u>
VI, GUN - TGT:	<u>28</u>
QE, GUN - TGT:	<u>0</u>
B. GUN TO MASK I	<u>+5</u>
VI, GUN - MASK:	<u>14</u>
QE, GUN - MASK I:	<u>0</u>
C. GUN TO MASK II	<u>N/A</u>
VI, GUN - MASK II:	<u>N/A</u>
QE, GUN - MASK II:	<u>N/A</u>
D. GUN TO TROOPS	<u>N/A</u>
VI, GUN - TROOPS:	<u>N/A</u>
QE, GUN - TROOPS:	<u>N/A</u>
	} <span style="border: 1px solid black; padding: 2px;">same elevation</span>
	} <span style="border: 1px solid black; padding: 2px;">obtained from table IVa</span>
	} <span style="border: 1px solid black; padding: 2px;">obtained from table I no vi - gun &amp; target on same elevation</span>
	} <span style="border: 1px solid black; padding: 2px;">must interpolate 1800m = 27.7m 1900m = 30.8m 1850 = 28.3 or 28</span>
5. CLEARANCE/SAFETY	
A. MASK I CLEARANCE	
ANGLE CLEARANCE:	<u>14</u>
REQUIRED CLEARANCE:	<u>7.4</u>
MASK I WILL BE CLEARED:	YES <input checked="" type="checkbox"/> X
	NO <input type="checkbox"/>
B. MASK II CLEARANCE	<u>N/A</u>
ANGLE CLEARANCE:	<u>N/A</u>
REQUIRED CLEARANCE:	<u>N/A</u>
MASK II WILL BE CLEARED:	YES <input type="checkbox"/>
	NO <input type="checkbox"/>
C. TROOP SAFETY	<u>N/A</u>
ANGLE CLEARANCE:	<u>N/A</u>
REQUIRED CLEARANCE:	<u>N/A</u>
TROOPS WILL BE SAFE:	YES <input type="checkbox"/>
	NO <input type="checkbox"/>
	} <span style="border: 1px solid black; padding: 2px;">from table III</span>
	} <span style="border: 1px solid black; padding: 2px;">angle of clearance exceeds required clearance</span>
	} <span style="border: 1px solid black; padding: 2px;">QE:Tgt = 28 - QE mask I = 14 14 = angle of clearance</span>
6. FIRING DATA	
A. IAP	<u>as given</u>
B. MAG. AZ:	<u>as given</u>
C. QE:	<u>28</u>

Figure F-7. Example 1.

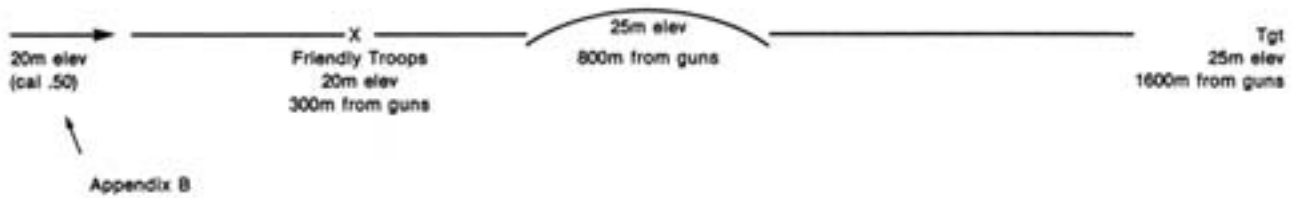

TARGET DATA WORKSHEET

MAP#      GUN AT Grid TARGET AT Grid MASK I AT Grid MASK II N/A  
 Troops at Grid

INFORMATION	CALCULATIONS
1. TARGET DIRECTION (MILS):	<u>as given</u>
2. RANGES	
A. GUN - TARGET:	<u>1600</u>
B. GUN - MASK I:	<u>800</u> — map distance
C. GUN - MASK II:	<u>N/A</u>
D. GUN - TROOPS:	<u>300</u>
3. ELEVATION (METERS)	
GUN:	<u>20</u>
TARGET:	<u>25</u> — map contour
MASK I:	<u>25</u>
MASK II:	<u>N/A</u>
TROOPS:	<u>20</u>
4. ELEVATION DATA (FROM MAP & TABLES)	
A. GUN - TARGET	
VI, GUN - TGT:	<u>+5</u> — from map - tgt 5m above gun
QE, GUN - TGT:	<u>25</u>
B. GUN TO MASK I	
VI, GUN - MASK I:	<u>+5</u> — from table IVa
QE, GUN - MASK I:	<u>14</u>
C. GUN TO MASK II	
VI, GUN - MASK II:	<u>N/A</u>
QE, GUN - MASK II:	<u>N/A</u>
D. GUN TO TROOPS	
VI, GUN - TROOPS:	<u>0</u> — same elevation
QE, GUN - TROOPS:	<u>2.3</u> — from table I - GUN-TGT same elev
5. CLEARANCE/SAFETY	
A. MASK I CLEARANCE	
ANGLE CLEARANCE:	<u>N/A</u>
REQUIRED CLEARANCE:	<u>N/A</u>
MASK I WILL BE CLEARED:	YES <u>    </u>
NO <u>    </u>	$\begin{array}{r} \text{QE tgt} = 25 \\ - \text{QE masks} = 14 \\ \hline 11 \end{array}$
B. MASK II CLEARANCE	
ANGLE CLEARANCE:	<u>11</u>
REQUIRED CLEARANCE:	<u>10</u>
MASK II WILL BE CLEARED:	YES <u>X</u>
NO <u>    </u>	$\begin{array}{r} \text{QE tgt} = 25 \\ - \text{QE trps} = 2.3 \\ \hline 22.7 \end{array}$
C. TROOP SAFETY	
ANGLE CLEARANCE:	<u>22.7</u>
REQUIRED CLEARANCE:	<u>22</u>
TROOPS WILL BE SAFE:	YES <u>X</u>
NO <u>    </u>	$\begin{array}{r} \text{QE tgt} = 25 \\ - \text{QE trps} = 2.3 \\ \hline 22.7 \end{array}$
6. FIRING DATA	
A. IAP	<u>    </u>
B. MAG. AZ:	<u>    </u>
C. QE:	<u>    </u>

Figure F-8. Example 2.

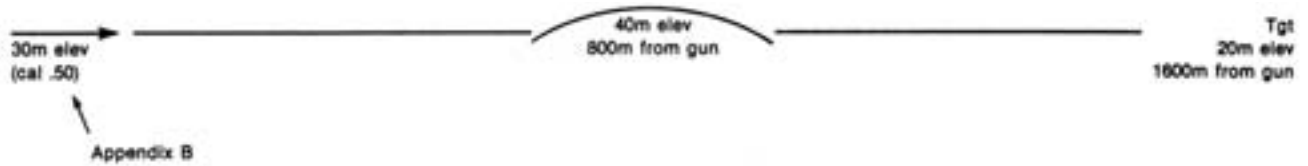

TARGET DATA WORKSHEET

MAP#      GUN AT Grid TARGET AT Grid MASK I AT Grid MASK II N/A  
 Troops at N/A

INFORMATION	CALCULATIONS
1. TARGET DIRECTION (MILS):	<u>as given</u>
2. RANGES	
A. GUN - TARGET:	<u>1600</u>
B. GUN - MASK I:	<u>800</u>
C. GUN - MASK II:	<u>N/A</u>
D. GUN - TROOPS:	<u>N/A</u>
	} map distance
3. ELEVATION (METERS)	
GUN:	<u>30</u>
TARGET:	<u>20</u>
MASK I:	<u>40</u>
MASK II:	<u>N/A</u>
TROOPS:	<u>N/A</u>
	} map contour
4. ELEVATION DATA (FROM MAP & TABLES)	
A. GUN - TARGET	
VI, GUN - TGT:	<u>- 10</u>
QE, GUN - TGT:	<u>16</u>
	} tgt 10m below gun
B. GUN TO MASK I	
VI, GUN - MASK:	<u>+ 10</u>
QE, GUN - MASK I:	<u>20</u>
	} mask 10m above gun
C. GUN TO MASK II	
VI, GUN - MASK II:	<u>N/A</u>
QE, GUN - MASK II:	<u>N/A</u>
	} table IVa
D. GUN TO TROOPS	
VI, GUN - TROOPS:	<u>N/A</u>
QE, GUN - TROOPS:	<u>N/A</u>
5. CLEARANCE/SAFETY	
A. MASK I CLEARANCE	
ANGLE CLEARANCE:	<u>- 4</u>
REQUIRED CLEARANCE:	<u>10</u>
MASK I WILL BE CLEARED:	YES <u>    </u>
	NO <u>  X  </u>
	} table III
B. MASK II CLEARANCE	
ANGLE CLEARANCE:	<u>N/A</u>
REQUIRED CLEARANCE:	<u>N/A</u>
MASK II WILL BE CLEARED:	YES <u>    </u>
	NO <u>    </u>
C. TROOP SAFETY	
ANGLE CLEARANCE:	<u>N/A</u>
REQUIRED CLEARANCE:	<u>N/A</u>
TROOPS WILL BE SAFE:	YES <u>    </u>
	NO <u>    </u>
	} angle clearance does not equal or exceed required clearance - must move guns.
	} QE guns = 16 - QE tgt = 20 - 4
6. FIRING DATA	
A. IAP	<u>    </u>
B. MAG. AZ:	<u>    </u>
C. QE:	<u>    </u>

Figure F-9. Example 3.

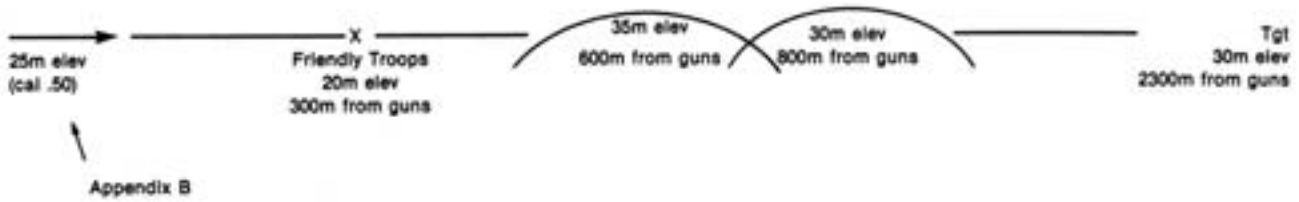

TARGET DATA WORKSHEET

MAP#      GUN AT Grid TARGET AT Grid MASK I AT Grid MASK II Grid  
 Troops at Grid

INFORMATION

CALCULATIONS

1. TARGET DIRECTION (MILS):

as given

2. RANGES

- A. GUN - TARGET:
- B. GUN - MASK I:
- C. GUN - MASK II:
- D. GUN - TROOPS:

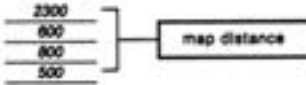

3. ELEVATION (METERS)

- GUN:
- TARGET:
- MASK I:
- MASK II:
- TROOPS:

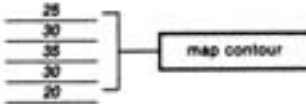

4. ELEVATION DATA (FROM MAP & TABLES)

- A. GUN - TARGET  
VI, GUN - TGT:  
QE, GUN - TGT:
- B. GUN TO MASK I  
VI, GUN - MASK I:  
QE, GUN - MASK I:
- C. GUN TO MASK II  
VI, GUN - MASK II:  
QE, GUN - MASK II:
- D. GUN TO TROOPS  
VI, GUN - TROOPS:  
QE, GUN - TROOPS:

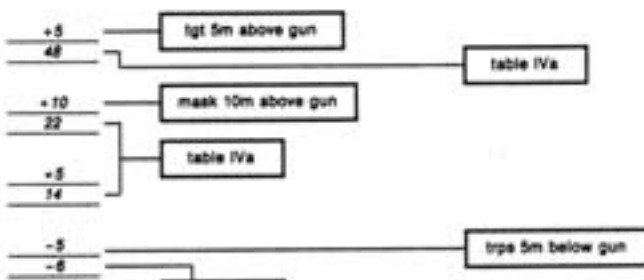

5. CLEARANCE/SAFETY

- A. MASK I CLEARANCE  
ANGLE CLEARANCE:  
REQUIRED CLEARANCE:  
MASK I WILL BE CLEARED: YES X  
NO
- B. MASK II CLEARANCE  
ANGLE CLEARANCE:  
REQUIRED CLEARANCE:  
MASK II WILL BE CLEARED: YES X  
NO
- C. TROOP SAFETY  
ANGLE CLEARANCE:  
REQUIRED CLEARANCE:  
TROOPS WILL BE SAFE: YES X  
NO

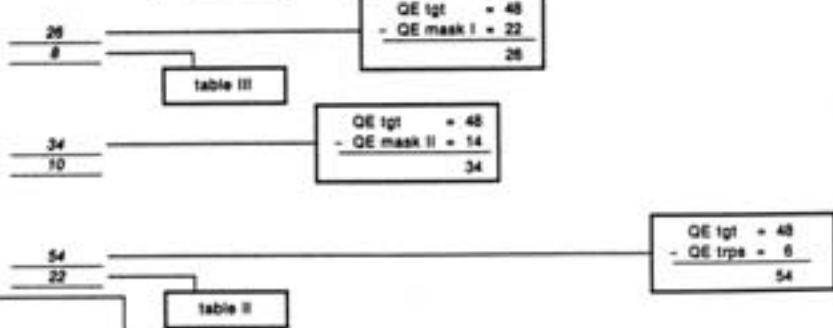

6. FIRING DATA

- A. IAP: as given
- B. MAG. AZ.: as given
- C. QE: 48

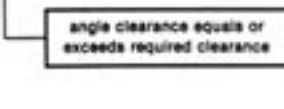

Figure F-10. Example 4.



TARGET DATA WORKSHEET

MAP#      GUN AT Grid TARGET AT Grid MASK I AT N/A MASK II N/A  
 Troops at Grid

INFORMATION

CALCULATIONS

1. TARGET DIRECTION (MILS): as given

2. RANGES  
 A. GUN - TARGET: 1300  
 B. GUN - MASK I: N/A  
 C. GUN - MASK II: N/A  
 D. GUN - TROOPS: 400      map distance

3. ELEVATION (METERS)  
 GUN: 20  
 TARGET: 35  
 MASK I: N/A  
 MASK II: N/A  
 TROOPS: 25      map contour

4. ELEVATION DATA (FROM MAP & TABLES)  
 A. GUN - TARGET  
 VI, GUN - TGT: +15      tgt 15m above gun  
 QE, GUN - TGT: 41      from table IVa (40.9 round to 41)  
 B. GUN TO MASK I  
 VI, GUN - MASK: N/A  
 QE, GUN - MASK I: N/A  
 C. GUN TO MASK II  
 VI, GUN - MASK II: N/A  
 QE, GUN - MASK II: N/A  
 D. GUN TO TROOPS  
 VI, GUN - TROOPS: +5      trps 5m above gun  
 QE, GUN - TROOPS: 16.4      from table IVa

5. CLEARANCE/SAFETY  
 A. MASK I CLEARANCE  
 ANGLE CLEARANCE: N/A  
 REQUIRED CLEARANCE: N/A  
 MASK I WILL BE CLEARED: YES       
 NO       
 B. MASK II CLEARANCE  
 ANGLE CLEARANCE: N/A  
 REQUIRED CLEARANCE: N/A  
 MASK II WILL BE CLEARED: YES X  
 NO       
 C. TROOP SAFETY  
 ANGLE CLEARANCE: 24.8  
 REQUIRED CLEARANCE: 25.1      table II  
 TROOPS WILL BE SAFE: YES       
 NO X      
$$\begin{array}{r} \text{QE tgt} = 41 \\ - \text{QE trps} = 16.4 \\ \hline 24.8 \end{array}$$

6. FIRING DATA  
 A. IAP:       
 B. MAG. AZ.:       
 C. QE: 41      angle clearance does not equal or exceed required clearance - move gun (100m to rear is sufficient)

Figure F-11. Example 5.

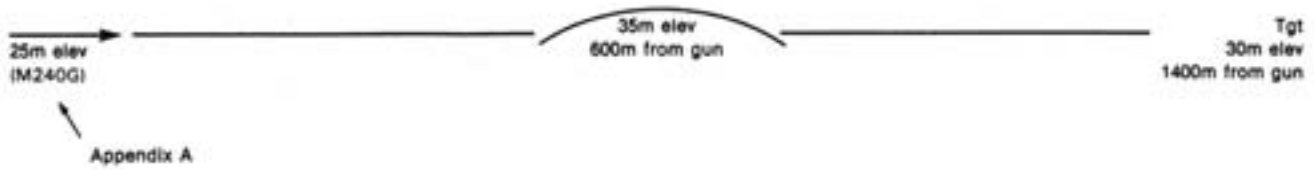

TARGET DATA WORKSHEET

MAP#      GUN AT Grid TARGET AT Grid MASK I AT Grid MASK II N/A  
 Troops at N/A

INFORMATION

CALCULATIONS

1. TARGET DIRECTION (MILS):

as given

2. RANGES

- A. GUN - TARGET:
- B. GUN - MASK I:
- C. GUN - MASK II:
- D. GUN - TROOPS:

1400 } **map distance**  
600  
N/A  
N/A

3. ELEVATION (METERS)

- GUN:
- TARGET:
- MASK I:
- MASK II:
- TROOPS:

25 } **map contour**  
30  
35  
N/A  
N/A

4. ELEVATION DATA (FROM MAP & TABLES)

- A. GUN - TARGET  
VI, GUN - TGT:  
QE, GUN - TGT:
- B. GUN TO MASK I  
VI, GUN - MASK:  
QE, GUN - MASK I:
- C. GUN TO MASK II  
VI, GUN - MASK II:  
QE, GUN - MASK II:
- D. GUN TO TROOPS  
VI, GUN - TROOPS:  
QE, GUN - TROOPS:

+5 } **tgt 5m above gun**  
37.5 } **table IVa**  
+10 } **mask 10m above gun**  
23.5  
N/A  
N/A  
N/A  
N/A

5. CLEARANCE/SAFETY

- A. MASK I CLEARANCE  
ANGLE CLEARANCE:  
REQUIRED CLEARANCE:  
MASK I WILL BE CLEARED: YES X  
NO
- B. MASK II CLEARANCE  
ANGLE CLEARANCE:  
REQUIRED CLEARANCE:  
MASK II WILL BE CLEARED: YES       
NO
- C. TROOP SAFETY  
ANGLE CLEARANCE:  
REQUIRED CLEARANCE:  
TROOPS WILL BE SAFE: YES       
NO

14.1 } **table III**  
8 } **angle clearance equals or exceeds required clearance**  
N/A  
N/A  
N/A  
N/A  
N/A  
N/A

QE tgt = 37.5  
 - QE mask I = 23.5  
 -----  
 14.1

6. FIRING DATA

- A. JAP
- B. MAG. AZ:
- C. QE:

as given  
as given  
38

Figure F-12. Example 6.





**TARGET DATA WORKSHEET**

MAP#      GUN AT Grid TARGET AT Grid MASK I AT Grid MASK II N/A  
 Troops at N/A

INFORMATION	CALCULATIONS
1. TARGET DIRECTION (MILS):	<u>as given</u>
2. RANGES	
A. GUN - TARGET:	<u>1200</u>
B. GUN - MASK I:	<u>600</u>
C. GUN - MASK II:	<u>N/A</u>
D. GUN - TROOPS:	<u>N/A</u>
	} map distance
3. ELEVATION (METERS)	
GUN:	<u>25</u>
TARGET:	<u>20</u>
MASK I:	<u>30</u>
MASK II:	<u>N/A</u>
TROOPS:	<u>N/A</u>
	} map contour
4. ELEVATION DATA (FROM MAP & TABLES)	
A. GUN - TARGET	
VI, GUN - TGT:	<u>-5</u>
QE, GUN - TGT:	<u>20</u>
	} tgt 5m below gun
	} table IVb
B. GUN TO MASK I	
VI, GUN - MASK:	<u>+5</u>
QE, GUN - MASK I:	<u>15</u>
	} mask 5m above gun
	} table IVa
C. GUN TO MASK II	
VI, GUN - MASK II:	<u>N/A</u>
QE, GUN - MASK II:	<u>N/A</u>
D. GUN TO TROOPS	
VI, GUN - TROOPS:	<u>N/A</u>
QE, GUN - TROOPS:	<u>N/A</u>
5. CLEARANCE/SAFETY	
A. MASK I CLEARANCE	
ANGLE CLEARANCE:	<u>5</u>
REQUIRED CLEARANCE:	<u>8</u>
MASK I WILL BE CLEARED:	YES <u>    </u>
	NO <u>X</u>
	} table III
	} QE tgt = 20 -QE mask = 15 5
B. MASK II CLEARANCE	
ANGLE CLEARANCE:	<u>N/A</u>
REQUIRED CLEARANCE:	<u>N/A</u>
MASK II WILL BE CLEARED:	YES <u>    </u>
	NO <u>    </u>
C. TROOP SAFETY	
ANGLE CLEARANCE:	<u>N/A</u>
REQUIRED CLEARANCE:	<u>N/A</u>
TROOPS WILL BE SAFE:	YES <u>    </u>
	NO <u>    </u>
	} angle of clearance does not equal or exceed required clearance - must move guns
6. FIRING DATA	
A. IAP	<u>    </u>
B. MAG. AZ:	<u>    </u>
C. QE:	<u>    </u>

Figure F-13. Example 7.

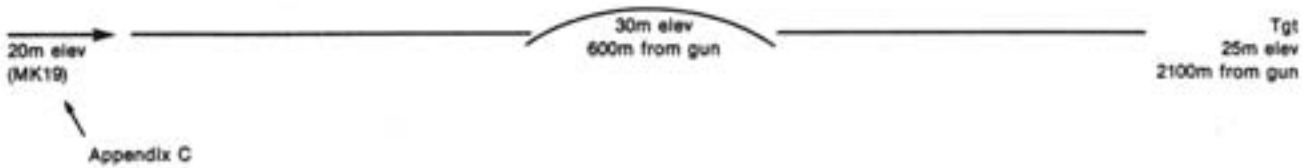

TARGET DATA WORKSHEET

MAP#      GUN AT Grid TARGET AT Grid MASK I AT Grid MASK II N/A  
 Troops at N/A

INFORMATION

CALCULATIONS

1. TARGET DIRECTION (MILS):

as given

2. RANGES

- A. GUN - TARGET:
- B. GUN - MASK I:
- C. GUN - MASK II:
- D. GUN - TROOPS:

2100 } map distance  
600  
N/A  
N/A

3. ELEVATION (METERS)

- GUN:
- TARGET:
- MASK I:
- MASK II:
- TROOPS:

20 } map contour  
25  
30  
N/A  
N/A

4. ELEVATION DATA (FROM MAP & TABLES)

A. GUN - TARGET

VI, GUN - TGT:

QE, GUN - TGT:

+5 } tgt 5m above gun  
497.8 } table IVa  
+10 } tgt 10m above gun  
80

B. GUN TO MASK I

VI, GUN - MASK:

QE, GUN - MASK I:

N/A  
N/A

C. GUN TO MASK II

VI, GUN - MASK II:

QE, GUN - MASK II:

N/A  
N/A

D. GUN TO TROOPS

VI, GUN - TROOPS:

QE, GUN - TROOPS:

N/A  
N/A

5. CLEARANCE/SAFETY

A. MASK I CLEARANCE

ANGLE CLEARANCE:

REQUIRED CLEARANCE:

MASK I WILL BE CLEARED: YES X

NO     

417.8  
      
411.8

QE tgt = 491.8  
 -QE gun = 80.0  
411.8

NOTE: QE step shown, but not needed since required clearance not available - must use table Va - troop safety not an issue.

B. MASK II CLEARANCE

ANGLE CLEARANCE:

REQUIRED CLEARANCE:

MASK II WILL BE CLEARED: YES     

NO     

N/A  
N/A

table II & III to be developed; table Va can be utilized to determine height at specific ranges when troop safety is not a factor.

C. TROOP SAFETY

ANGLE CLEARANCE:

REQUIRED CLEARANCE:

TROOPS WILL BE SAFE: YES     

NO     

N/A  
N/A

table Va indicates rounds will clear mask (height of rds between 350m and 400m at range of 800m.

6. FIRING DATA

A. IAP

B. MAG. AZ:

C. QE:

492

Figure F-14. Example 8.

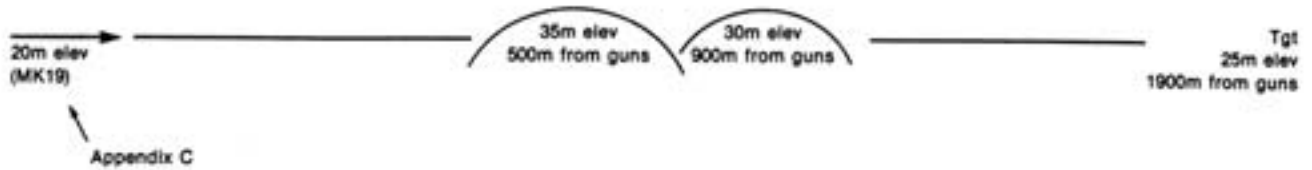

TARGET DATA WORKSHEET

MAP#      GUN AT Grid TARGET AT Grid MASK I AT Grid MASK II Grid  
 Troops at N/A

INFORMATION	CALCULATIONS
1. TARGET DIRECTION (MILS):	<u>as given</u>
2. RANGES	
A. GUN - TARGET:	<u>1900</u>
B. GUN - MASK I:	<u>500</u>
C. GUN - MASK II:	<u>900</u>
D. GUN - TROOPS:	<u>N/A</u>
	map distance
3. ELEVATION (METERS)	
GUN:	<u>20</u>
TARGET:	<u>25</u>
MASK I:	<u>35</u>
MASK II:	<u>30</u>
TROOPS:	<u>N/A</u>
	map contour
4. ELEVATION DATA (FROM MAP & TABLES)	
A. GUN - TARGET	<u>+ 5</u>
VI, GUN - TGT:	<u>370.5</u>
QE, GUN - TGT:	
B. GUN TO MASK I	<u>+ 15</u>
VI, GUN - MASK:	<u>81.3</u>
QE, GUN - MASK I:	
	tgt 5m above gun
	table IVa
C. GUN TO MASK II	<u>+ 10</u>
VI, GUN - MASK II:	<u>117.9</u>
QE, GUN - MASK II:	
	tgt 10m above gun
	table IVa
D. GUN TO TROOPS	<u>N/A</u>
VI, GUN - TROOPS:	<u>N/A</u>
QE, GUN - TROOPS:	<u>N/A</u>
5. CLEARANCE/SAFETY	
A. MASK I CLEARANCE	
ANGLE CLEARANCE:	<u>289.3</u>
REQUIRED CLEARANCE:	<u>370.5</u>
MASK I WILL BE CLEARED:	<u>289.3</u>
YES <u>X</u>	
NO <u>    </u>	
	QE tgt = 370.5 -QE mask I = 81.3 ----- 289.3
	table III to be developed - use table Va - troop safety not an issue
B. MASK II CLEARANCE	
ANGLE CLEARANCE:	<u>252.6</u>
REQUIRED CLEARANCE:	<u>370.5</u>
MASK II WILL BE CLEARED:	<u>252.6</u>
YES <u>X</u>	
NO <u>    </u>	
	QE tgt = 370.5 -QE mask II = 117.9 ----- 252.6
	table Va indicates both masks will be cleared at the given ranges
C. TROOP SAFETY	
ANGLE CLEARANCE:	<u>N/A</u>
REQUIRED CLEARANCE:	<u>N/A</u>
TROOPS WILL BE SAFE:	<u>N/A</u>
YES <u>    </u>	
NO <u>    </u>	
6. FIRING DATA	
A. IAP	<u>    </u>
B. MAG. AZ:	<u>    </u>
C. QE:	<u>371</u>

NOTE: QE step shown, but not needed since required clearance not available - must use table Va - troop safety not an issue.

Figure F-15. Example 9.

## Appendix G

# Final Protective Lines

### 1. General

Machine gun final protective lines (FPLs) are usually fired at a rapid rate for the first 2 minutes and a sustained rate thereafter. In order to keep the enemy beyond hand grenade range, these fires should be located at least 50 meters forward of the battle position.

### 2. Characteristics

Effective FPLs are characterized by three major features:

- Flanking fire
- Interlocking fire
- Grazing fire

FPLs should provide as much flanking fire as possible (see figure G-1). Flanking, enfilade fire is highly desirable for the FPL. Terrain and obstacles should be used to force enemy formations into positions where the fires of the FPL will be flanking and enfilade. For example, every attempt should be made to position guns toward the flank of the defense and align FPLs along the enemy side of tactical wire (see figure G-2). When the attacking enemy encounters the wire and slows or stops to negotiate it, flanking, enfilade fire from machine guns effectively engages them.

FPLs should also be interlocking (see figure G-3). This adds to the effectiveness of the fire plan by eliminating gaps in the FPLs and maximizing the coverage by fire across as much of the frontage as possible. Additionally, it provides mutual support between adjacent units.



Figure G-1. Example of the Increased Effect of Flanking Fire.

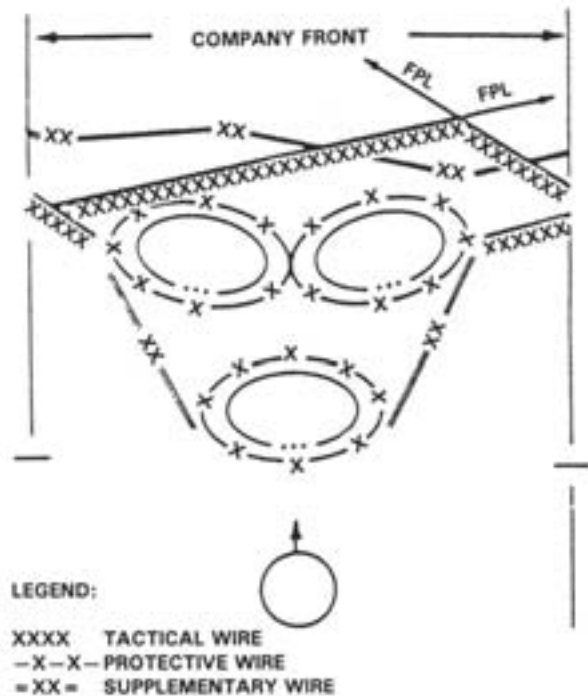

Figure G-2. Using Obstacles to Enhance the Effectiveness of the FPL.

FPLs should also be located to obtain maximum grazing fire (see figure G-4). The concept of grazing fire is to place a wall of bullets, in the form of the cone of fire, between an advancing enemy and friendly positions. This is done by sighting the weapon on the farthest range possible where the center of the cone of fire will remain approximately 1 meter above the ground. This ensures that the lower bound of the cone of fire is as close to the ground as possible to minimize the enemy's opportunity to move underneath it without being hit. Six hundred meters is the maximum range whereby grazing fire can be maintained with the M240G.

Identification of gaps in the FPL, called dead space, is critical. Dead space indicates areas on the FPL that cannot be adequately engaged by the machine gun's fires, and it requires the assignment of other weapons systems to cover the space. In perfect conditions, on uniformly sloping ground, and with the gun sighted at 600 meters, the maximum dead space on an FPL would be .8 meters (31 inches) (it would occur at approximately 300 meters). See figure G-5. This space would be difficult to move under without resorting to a low crawl, which would seriously impede the enemy's momentum in the attack. Since terrain is seldom uniformly sloping, any depressions in the ground along the FPL will aid the enemy in moving underneath it more quickly. This is why dead space in the FPL must be identified and marked. The FPL is indicated on maps, fire plan sketches, or overlays by drawing a wide black line to indicate grazing fire and effective danger space. A thin line is drawn whenever grazing fire is lost, the danger space is diminished, and dead space occurs (see figure G-6). Sections of dead space are drawn to scale showing the exact width

of the gap on the FPL. This is important in determining the type of weapon that will be used to cover the dead space.

It should be noted that the effectiveness of a machine gun's fire may not be completely cancelled by sections of dead space. First, continuous firing of the FPL will keep the enemy confined to the areas of dead space, impede his movement, and allow other weapons systems time to engage him. Secondly, it must be remembered that while we lay the gun for 600 meters, with grazing fire in mind, another consideration is that a *danger space* exists along that entire distance. Danger space takes the entire cone of fire into consideration, not just the center as with grazing fire. Danger space is essentially a measure of the entire "kill zone" created by the cone of fire which will hit a standing man at a prescribed range. The M240G's cone of fire does not rise above the height of a standing man (1.8 meters) out to a range of 700 meters. At this range, on uniformly sloping ground, the maximum dead space would be 1.4 meters (55 inches) and would occur at half of that range (350 meters). Although this dead space could allow the enemy to move under the FPL, enemy personnel who try to advance standing upright could still be hit at any point along the 700 meter long line of fire. The grazing fire measurement of 600 meters is used as the maximum range for a FPL instead of the 700 meter measurement of effective danger space since the 31 inch maximum dead space encountered when sighted at 600 meters is far more restrictive to enemy movement than the 55 inch maximum dead space encountered when sighted at 700 meters. Finally, although the FPL is a "fixed" firing mission, two clicks of elevation (either up or down) of searching manipulation with the traversing and elevating mechanism is permitted and encouraged during firing. This technique maintains a fixed line of fire

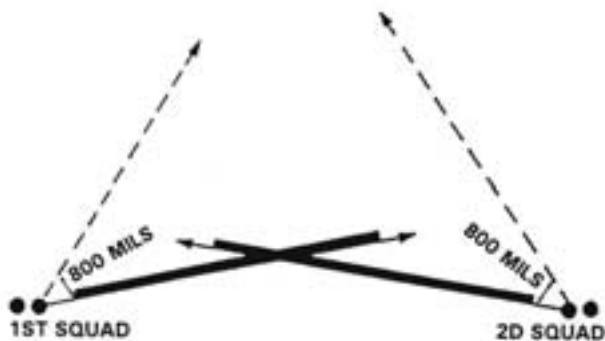

Figure G-3. Interlocking Machine Gun Fires.



Figure G-4. Grazing Fire Plotted to Scale.

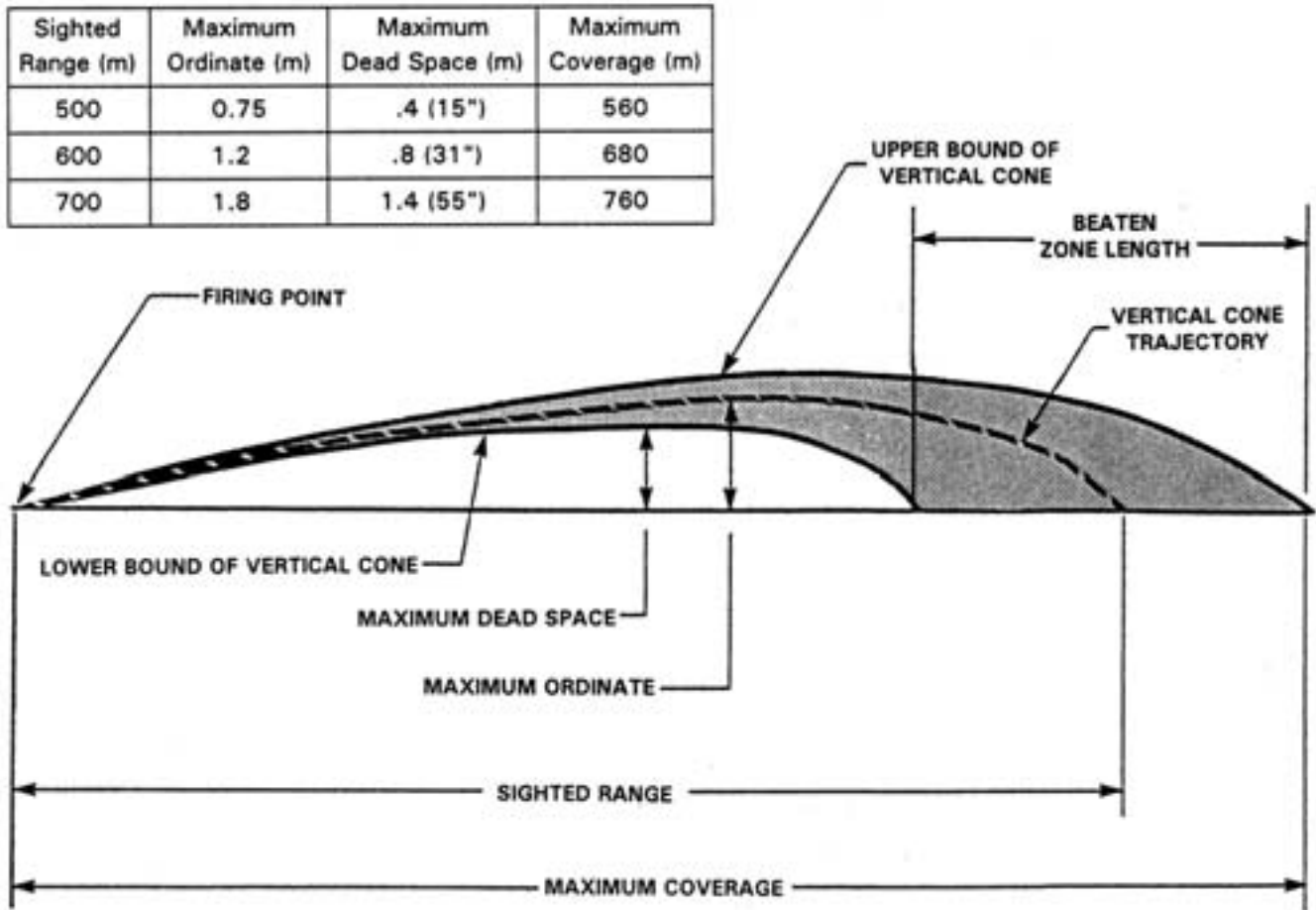

Figure G-5. Considerations in Measuring Dead Space.

while continually changing the height of the cone of fire and the location of the beaten zone, better covering the area along the line, including any sections of dead space.

gun is positioned correctly and locked into place on the tripod as it will be when firing the FPL. He then gets into a good firing position behind the gun, sets 600 meters on the rear sight, and aims in on a point

### 3. Walking the FPL

Once the machine gun unit leader has ensured that positions are occupied properly, machine guns are immediately set in firing positions to cover assigned sectors of fire and principal direction of fire (PDF) or FPLs. The squad leader points out definitive terrain features to each machine gun team when prescribing sectors of fire, PDFs and FPLs. When a FPL is assigned, it should be walked whenever practicable. Walking the FPL allows the team to determine the extent of the grazing fire and danger space available, and to locate and mark any dead space in the FPL. Prior to walking the FPL, the gunner ensures that the

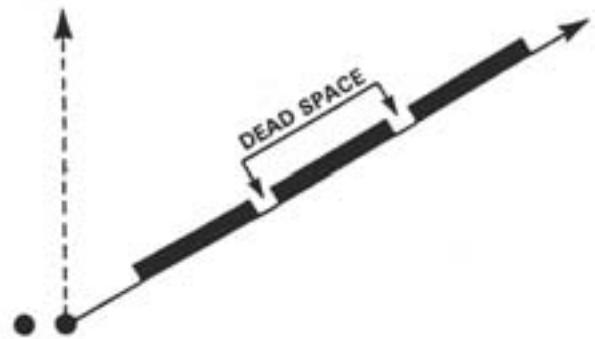

Figure G-6. Dead Space in FPL.

along the FPL that he estimates to be 600 meters away. The team leader or ammunition bearer then walks out along the FPL using a standard pace. (For accuracy the length of the individual's pace must be measured.) When the gunner can no longer observe the walker below the center mass of his chest, he shouts out **MARK**. The person walking the FPL then records the number of paces that he took to that point on a pace card. The individual then continues to walk the FPL. Once the gunner sees the walker's body below the center mass of his chest, he shouts out **MARK** again. The walker once again records the number of paces that he took to reach that spot. This procedure is continued until the walker reaches the limits of grazing fire (600 meters). Pace counts recorded in this manner show how far away each section of dead space is from the gun position and how wide the dead space is from near side to far side (see figure G-7).

#### NOTE

Using the center mass of the chest as the point where dead space begins to take into consideration the measure of grazing fire, danger space, maximum ordinate, and maximum dead space. Using the gunner's view of a person's waist (an approximate measure of the 1 meter height of grazing fire) as the point at which dead space begins is too limiting as a tactical measurement of fire over actual terrain and disregards the effective danger space created by the lower portion of the cone of fire. If, however, dead space is not marked until only a person's head is visible to the gunner, then a significant amount of dead space would have been overlooked and unmarked prior to that point (based on the measure of maximum dead space at 600 meters). The use of the center mass of the chest as the measuring point for dead space is a compromise between these two considerations.

#### 4. Preparation of Range Cards

Each team leader prepares two range cards containing information on the extent of dead space and grazing fire along the FPL and location of likely targets (see figure 6-39). Both teams of the machine gun squad normally are assigned the same sector of fire, and they fire the same FPL. Thus, each FPL is a double band of

machine gun fire. If both teams of the squad are positioned properly, approximately 35 to 50 meters apart, both team range cards will be similar, but not exactly alike. One copy of the range card, along with the pace card, is given to the squad leader who, from the information provided, determines the amount of dead space within each team FPL. The squad leader, in conjunction with the section leader, determines the number and position of mortar barrages required to cover the dead space in the squad FPL.

#### 5. Positioning of Mortar Barrages

Each rifle company contains three 60mm mortars, each of which can fire one barrage. The infantry battalion weapons company contains eight 81mm mortars, each of which can fire one barrage. Each 81mm and 60mm mortar barrage covers an area 50 meters wide by 50 meters deep. Within the infantry battalion, there is the capability to fire nine 60mm and eight 81mm mortar barrages for a total of 17 barrages. A rifle company will be allocated 81mm mortar barrages by the battalion commander. The number allocated depends on the terrain in front of each company, the enemy avenues of approach into each company's battle position, and the number of companies assigned forward battle positions. Normally, a rifle company is allocated two to three 81mm mortar barrages; thus, when added to its three organic 60mm mortar barrages, a company normally has five to six mortar barrages at its disposal.

Barrages should only be positioned where they are required to fill in gaps in the FPL of the machine gun squad. The squad FPL is the combined effect of both machine gun teams. In positioning the barrages, the maximum effect must be obtained from all weapons of the rifle company to fill in gaps on the FPL. In some instances, it may be impractical to use a barrage to cover dead space. In figure G-7, there are three areas of dead space in the FPL; MARK 1 to MARK 2 equals 38 meters; MARK 3 to MARK 4 equals 76 meters; MARK 5 to MARK 6 equals 84 meters. These areas of dead space are shown in figure G-8 as A, B, and C of the first team, first squad's FPL, respectively. To cover these three areas with 50-meter by 50-meter barrages would take five barrages (A=1 barrage; B=2 barrages; C=2 barrages). This would use all or most of the barrages at the company's disposal.

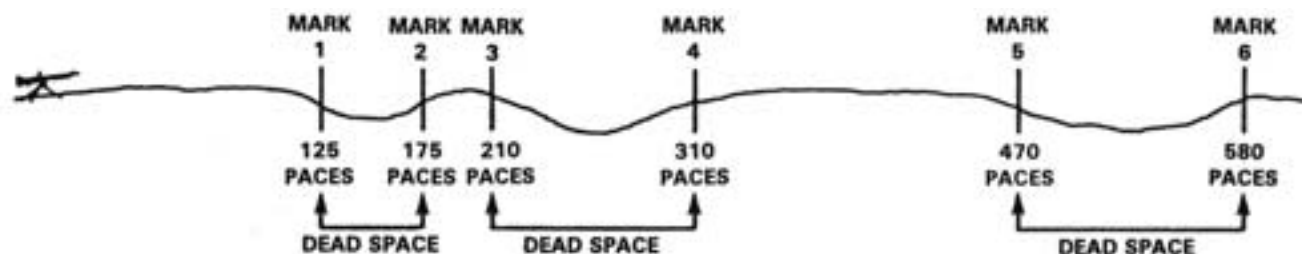

DEAD SPACE CARD			
LCpl SMITH		1 Pace = 30 Inches = .76 Meters	
Mark	Paces	Meters	
1	125	95 <sup>1</sup>	38 <sup>2</sup>
2	175	133	
3	210	160	76
4	310	236	
5	470	357	84
6	580	441	

<sup>1</sup> The distance in meters to the MARKS is arrived at by multiplying the paces at that MARK by the length of the pacer's stride.

For example, to find the distance to MARK 1, multiply 12 paces by .76 meters.

LCpl Smith's average pace is 30 inches.

$30 \div 39.37$  (inches per meter) equals .76 meters.

The table below is provided for quick reference.

PACE CONVERSION FROM INCHES TO METERS				
Inches = Meters	Inches = Meters	Inches = Meters	Inches = Meters	Inches = Meters
24 = 0.61	30 = 0.76	36 = 0.91	42 = 1.07	48 = 1.22
25 = 0.64	31 = 0.7	37 = 0.94	43 = 1.09	49 = 1.25
26 = 0.66	32 = 0.81	38 = 0.96	44 = 1.12	50 = 1.27
27 = 0.69	33 = 0.84	39 = 0.99	45 = 1.14	51 = 1.3
28 = 0.71	34 = 0.86	40 = 1.02	46 = 1.17	52 = 1.32
29 = 0.74	35 = 0.89	41 = 1.04	47 = 1.19	53 = 1.35

<sup>2</sup> To determine the length of each area of dead space along the FPL, subtract the distance (in meters) between the machine gun and the near edge of the dead space from the distance (in meters) between the machine gun and the far edge of the dead space. For example, the distance between the machine gun and MARK 5 is 357 meters; the distance between the machine gun and MARK 6 is 441 meters. Thus the length of the dead space between MARK 5 and MARK 6 is 84 meters (441 meters - 357 meters = 84 meters).

Figure G-7. Walking the FPL.



In discussing the mortar barrage requirements with the first squad leader, the section leader sees that dead space area C is covered by the FPL of the second squad (see figure G-9), reducing the first squad's mortar barrage requirement to two. The section leader then discusses the barrage requirements of all three squads with the platoon commander who, after reviewing the first squad's range and pace cards, decides that dead space A, because of the coverage provided by the second team of the first squad, its proximity to friendly troops, and its relatively small size, can be covered adequately by a fire team sector of fire with the automatic rifle PDF firing into the dead space. (See figure G-10). The coverage of dead space area B by the second team, first squad is better than that provided by the first squad. This dead space, although also covered by an automatic rifle PDF, is wide enough (76 meters) to warrant coverage by two mortar barrages. The platoon commander will submit

the first squad's FPL barrage recommendation to the company commander for approval.

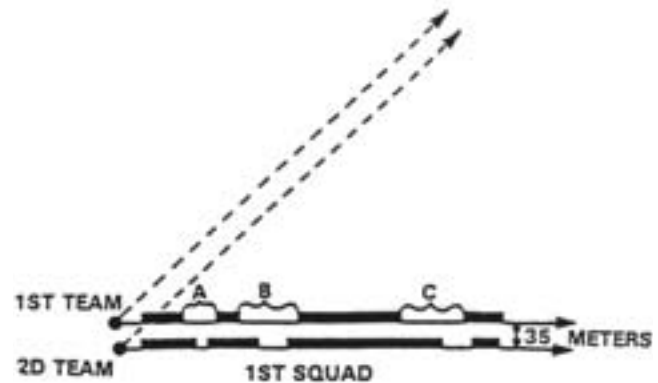

Figure G-8. Determining Dead Space.

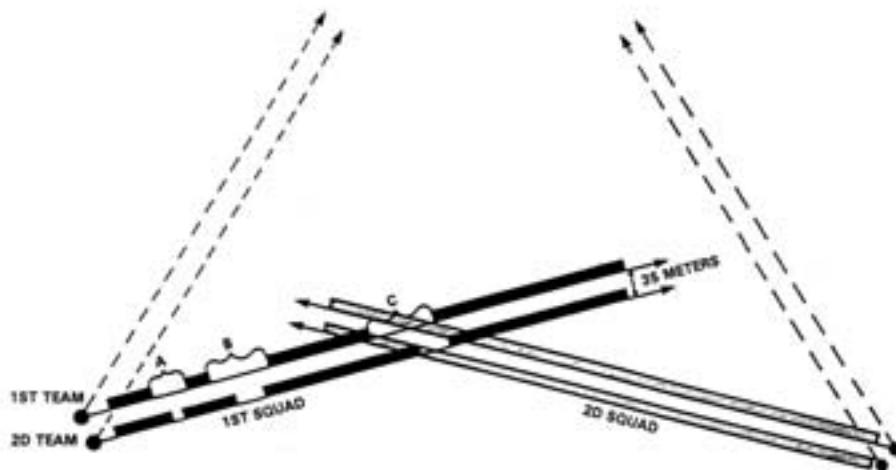

Figure G-9. Dead Space Covered by Direct Fire.

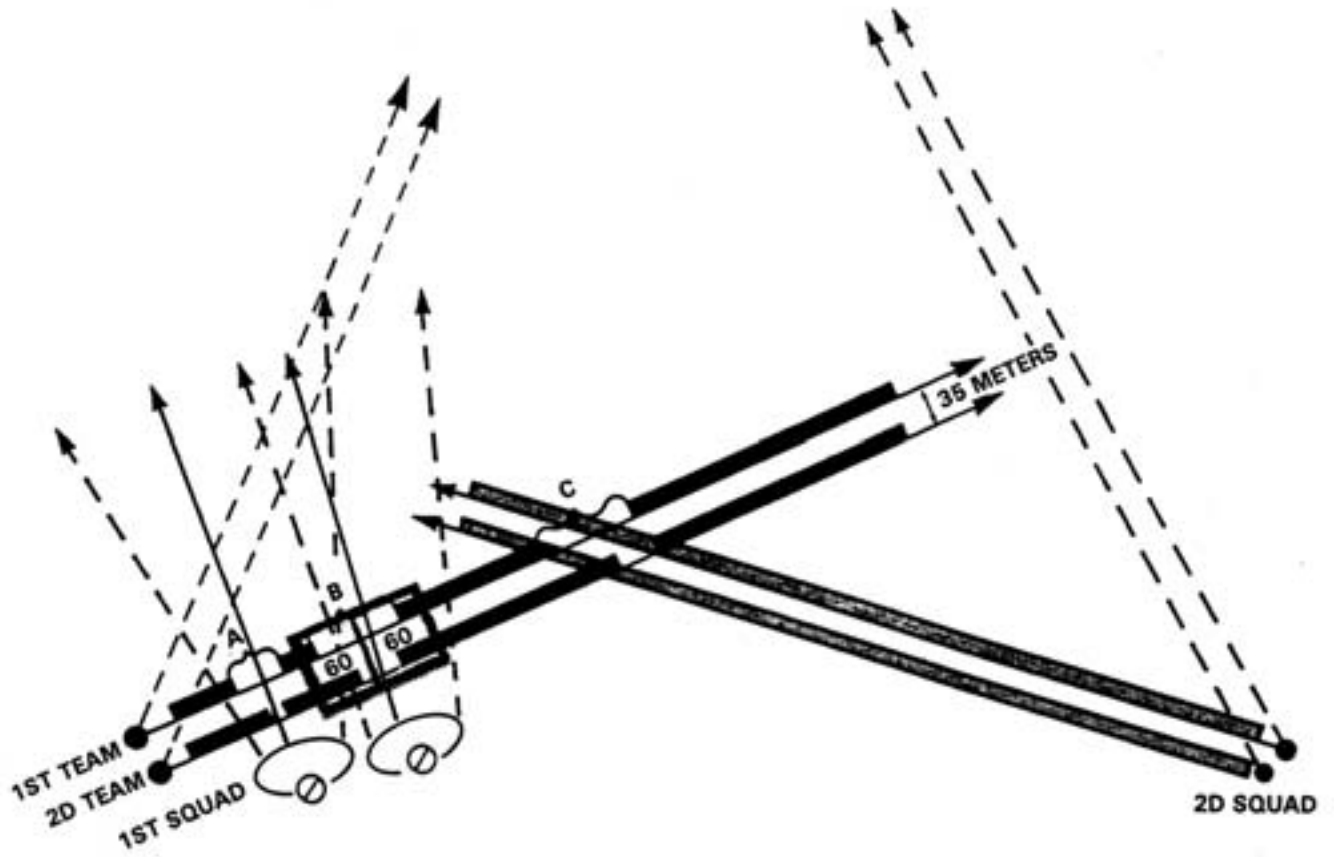

Figure G-10. Positioning of Mortar Barrages.

## Appendix H

# Acronyms and Abbreviations

AE . . . . .	angle of elevation	m . . . . .	meter
AS . . . . .	angle of site	mm . . . . .	millimeter
BFA . . . . .	blank firing adapter	MMG . . . . .	medium machine gun
BZO . . . . .	battlesight zero	mph . . . . .	miles per hour
CAAT . . . . .	combined antiarmor teams	NATO . . . . .	North Atlantic Treaty Organization
cal. . . . .	caliber	NBC . . . . .	nuclear, biological, and chemical
CLP . . . . .	cleaner, lubricant, and preservative	NCO . . . . .	noncommissioned officer
cm . . . . .	centimeter	NVE . . . . .	night vision equipment
C4 . . . . .	composition 4	NVG . . . . .	night vision goggle
DODAC . . . . .	Department of Defense Ammunition Code	OP . . . . .	observation post
FEBA . . . . .	forward edge of the battle area	OT . . . . .	observer-target
FO . . . . .	forward observer	PDF . . . . .	principal direction of fire
FPL . . . . .	final protective line	QE . . . . .	quadrant of elevation
GUN-TGT . . . . .	gun-target	RBC . . . . .	rifle bore cleaner
HE . . . . .	high explosive	SAW . . . . .	squad automatic weapon
HEDP . . . . .	high explosive dual purpose	SLAP . . . . .	sabot light armor penetrator
HMG . . . . .	heavy machine gun	SLAP-T . . . . .	sabot light armor penetrator-tracer
HMMWV . . . . .	high mobility, multipurpose wheeled vehicle	T&E . . . . .	traversing and elevating
IAL . . . . .	infrared aim light	TGT . . . . .	target
IAP . . . . .	initial aiming point	TOG . . . . .	terrain-observer-gun
ISWS . . . . .	individual served weapon sight	VI . . . . .	vertical interval
LMG . . . . .	light machine gun	WERM . . . . .	width equals range times mils
LSA . . . . .	liquid solvent agent		
LSA . . . . .	lubricant oil, weapons, semi-fluid		
LSA-T . . . . .	liquid solvent agent with Teflon™		
LAW . . . . .	lubricating oil arctic weapons		

## Appendix I

# References and Related Publications

### Field Manuals (FMs)

23-14	M249 Light Machine Gun in the Automatic Rifle Role.
23-27	MK19, 40-MM Grenade Machine Gun MOD 3
23-65	Browning Machine Gun, Caliber .50 HB, M2
3-5	NBC Decontamination
44-2	Air Defense Artillery Employment Automatic Weapons M42/M55
44-80	Visual Aircraft Recognition

### Technical Manuals (TMs)

08521A-10/1A	Machine Gun 40mm MK19 MOD 3
08670A-10/1A	M240 Machine Gun 7.62 mm (with change 1-3)
08670B-23&P/2 Supplement _1	M240G Machine Gun 7.62mm (1005-01-359-2714)
08686A-13&P/1	Machine Gun Mount MK64
9-1005-201-10	Operator's Manual for Machine Gun, 5.56MM, M249 W/Equipment (NSN 1005-01-127-7510) (EIC: 4BG) (TM-08671A-10/1)
9-1005-213-10	Operator's Manual for Machine Guns, Caliber .50; Browning, M2, Heavy Barrel Flexible, W/E (NSN 1005-00-322-9715) (EIC: 4AG) M48 Turret Type (1005-00-957-3893) (EIC: 4BB) Soft Mount (1005-LL-H11-5877) (Navy) Fixed Type Right Hand Feed (1005-00-122-9339) (Navy) Fixed Type Left Hand Feed (1005-00-122-9368) (Navy) Mounts, Machine Gun, Caliber .50, M3 Tripod W/E (1005-00-322-9716) (EIC: 4EA) M63 Antiaircraft W/E (1005-00-673-3246) (EIC: 4EC) (TM 02498A-10/1; TO 11W2-6-3-161; SW361-AB-MMO-010)
9-1005-245-14	Operator, Organizational, Direct Support and General Support Maintenance Manual Including Repair Parts and Special Tools Lists (Including Depot Maintenance Repair Parts and Special Tools) Various Machine Gun Mounts and Combinations Used on Tactical and Armored Vehicle Mounts, Machine Gun 1005-774-6861, 1005-854-4463 (M142), 1005-704-6650, 1005-836-7286, 1005-706-8880, 1005-654-0733, 1005-659-0045, Mounts, Machine Gun M48 Tank Cupola 1005-736-4875, 1005-834-6119; Pedestal, Gun Mounts 1005-419-7041 (m4), 1005-736-0400 (M31A1), 1005-706-9767 (M31C); Mounts, Gun Ring Machine Gun 1005-317-2425 (M36), 1005-317-2427 (M36A1), 1005-317-2428 (M66), 1005-702-8676 (M68), 1005-797-6451 (M68E1), 1005-797-6450 (M68E1 w/supports), 1005-219-8135 (M81), 1005-783-5494 (M548 Carrier), 1005-774-6836 (M548 Carrier) (Reprinted w/Basic Incl C1)

## Technical Manuals (TMs) (Continued)

- 9-1010-231-13&P (O) Operator's, Organization and Intermediate Maintenance with Repair Parts List and Components List Mount, Machine Gun, MK 64; MOD 4 (NSN 1010-01-128-4934); MOD 5 (1010-01-126-9063); MOD 6 (1010-01-179-7616); MOD 7 (1010-01-179-7616); MOD 8 (1010-01-179-7615); Used with Machine Gun, MK19 MOD 3, 40MM Machine Gun, M2, Caliber .50 Machine Gun, M60, 7.62MM Machine Gun, M60E3 7.62MM (TO 11W2-8-32-4; SW 363-D4-MMM-010/MK 64 TM 08686A-13&P1)
- 11-5855-214-10 Operator's Manual for Night Vision Sight, Crew Served Weapon, AN/TVS-5 (NSN 5855-00-629-5327)
- 11-5855-238-10 Operator's Manual for Night Vision Goggles Ground Use: AN/PVS-5 and AN/PVS-5A (NSN 5855-00-150-1820) (EIC: IPD) AN/PVS-5B (5855-01-228-0938) (EIC: IPV) AN/PVS-5C (5855-01-288-0936) (EIC: IPU) Aviation Use

## Fleet Marine Force Reference Publications (FMFRPs)

- 12-2 Infantry in Battle
- 12-6 Infantry Operations and Weapons Usage in Korea, Winter of 1950-51
- 12-34-I History of the U.S. Marine Corps Operations in Word War II: Pearl Harbor to Guadalcanal, Volume I
- 12-34-III History of the U.S. Marine Corps Operations in Word War II: Pearl Harbor to Guadalcanal, Volume III

## Miscellaneous

- Berry, Henry, *Hey Mac, Where Ya Been?* Living Memories of the U.S. Marines in the Korean War, St. Martin's Press, New York, 1988
- Heinl, Robert Debs, Jr., *Victory at High Tide: The Inchon-Seoul Campagin*, J.B. Lippincott Company, Philadelphia and New York, 1968
- Shaw, Henry I., *First Offensive: The Marine Campaign for Guadalcanal*, Marines in World War II Commemorative Series, Marine Corps Historical Center, Washington D.C., 1992

## kç É ë

1. FMFRP 12-2, *Infantry In Battle*, p. 249.
2. *Ibid*, p. 239.
3. *Ibid*, p. 239.
4. *Ibid*, p. 239.
5. *Ibid*, p. 248.
6. Henry Berry, *Hey Mac, Where Ya Been? Living Memories of the U.S. Marines in the Korean War*, (New York: St. Martin's Press, 1988), pp. 319–320.
7. Henry I. Shaw, *First Offensive: The Marine Campaign for Guadalcanal*, Marines in World War II Commemorative Series (Washington D.C.: U.S. Marine Corps Historical Center, 1992) pp. 37 and 38.
8. FMFRP 12-34-III, *History of the U.S. Marine Corps Operations in World War II: Central Pacific Drive*, p.390.
9. Robert Debs Heintz, Jr., *Victory At High Tide: The Inchon-Seoul Campaign* (Washington D.C.: The Nautical & Aviation Publishing Company of America, 1984) p. 130.
10. FMFRP 12-34-I, *History of the U.S. Marine Corps Operations in World War II: Pearl Harbor to Guadalcanal*, p. 144.