



# Standard Test Methods for Thickness and Density of Sprayed Fire-Resistive Material (SFRM) Applied to Structural Members<sup>1</sup>

This standard is issued under the fixed designation E605/E605M; the number immediately following the designation indicates the year of original adoption or, in the case of revision, the year of last revision. A number in parentheses indicates the year of last reapproval. A superscript epsilon ( $\epsilon$ ) indicates an editorial change since the last revision or reapproval.

*This standard has been approved for use by agencies of the U.S. Department of Defense.*

<sup>e1</sup> NOTE—Designation was changed to dual and units information was corrected editorially in August 2015.

## 1. Scope

1.1 These test methods cover procedures for determining thickness and density of sprayed fire-resistive material (SFRM) used in structural assemblies. These include sprayed fiber and cementitious types. The test methods are applicable to both laboratory and field procedures, as indicated in Section 7.

1.2 These test methods require the application of SFRM in accordance with the manufacturers' published instructions. The apparatus, materials, and procedure used to apply the SFRM for laboratory tests shall be the same as is used for the construction of either of the test assemblies described in Test Methods E119 and E84.

1.3 There is no intent in these test methods to establish levels of performance.

1.4 The values stated in either SI units or inch-pound units are to be regarded separately as standard. The values stated in each system may not be exact equivalents; therefore, each system shall be used independently of the other. Combining values from the two systems may result in non-conformance with the standard.

1.5 *This standard does not purport to address all of the safety concerns, if any, associated with its use. It is the responsibility of the user of this standard to establish appropriate safety and health practices and determine the applicability of regulatory limitations prior to use.*

## 2. Referenced Documents

### 2.1 ASTM Standards:<sup>2</sup>

<sup>1</sup> These test methods are under the jurisdiction of ASTM Committee E06 on Performance of Buildings and is the direct responsibility of Subcommittee E06.21 on Serviceability.

Current edition approved Aug. 1, 2015. Published August 2015. Originally approved in 1977. Last previous edition approved in 2011 as E605 – 93 (2011). DOI: 10.1520/E0605\_E0605M-93R15E01.

<sup>2</sup> For referenced ASTM standards, visit the ASTM website, www.astm.org, or contact ASTM Customer Service at service@astm.org. For *Annual Book of ASTM Standards* volume information, refer to the standard's Document Summary page on the ASTM website.

E84 Test Method for Surface Burning Characteristics of Building Materials

E119 Test Methods for Fire Tests of Building Construction and Materials

E631 Terminology of Building Constructions

## 3. Terminology

3.1 *Definitions*—For definitions of terms found in these test methods, refer to Terminology E631.

3.2 *Definitions of Terms Specific to This Standard:*

3.2.1 *density, n*—the weight<sup>3</sup> per unit volume of the SFRM.

3.2.2 *sprayed fire-resistive materials, n*—materials that are sprayed onto substrates to provide fire-resistive protection of the substrates.

3.2.3 *thickness, n*—the distance measured from the substrate sprayed with the SFRM, through the SFRM, to the outer surface of the SFRM.

## 4. Summary of Test Method

4.1 The basic properties of density and thickness are determined using a thickness gage, scales, steel rules, and templates.

## 5. Significance and Use

5.1 Certain properties, namely thickness and density, of SFRM are basic. It is the intent of these test methods to provide procedures to determine these properties.

## 6. Apparatus

6.1 *Steel Rule*, graduated in at least 1 mm [ $1/16$  in.] intervals.

6.2 *Thickness Gage*, consisting of a needle or a pin and a sliding disk perpendicular to the needle (see Fig. 1). The pin shall be of sufficient length for the thickness of the material to be measured. This gage shall be graduated in 1 mm [ $1/16$  in.] intervals. This disk shall be perpendicular to the needle at all times and shall have a friction device to grip the pin unless

<sup>3</sup> Although *mass* is determined, the term *weight* is used in these test methods as a field-accepted substitute.

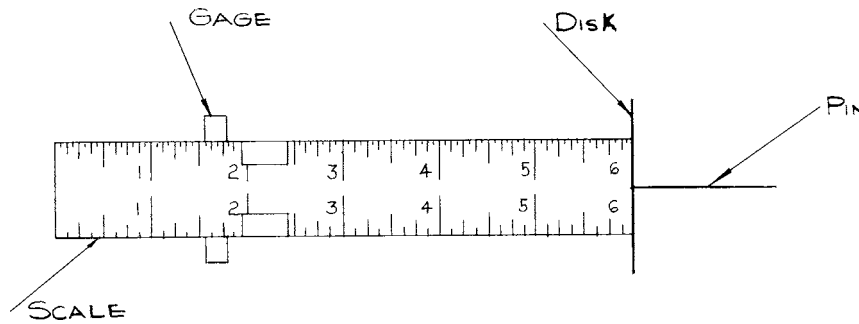

FIG. 1 Thickness Gage

purposely moved. The disk diameter shall be a minimum of 22 mm [ $7/8$  in.] and a maximum of 30 mm [ $1\frac{1}{8}$  in.], to permit contact with the surface of the specimen to be measured. For materials not readily penetrated by the depth gage, see 8.1.2.1 and Note 2.

6.3 Scales of sufficient capacity and sensitivity to weigh the test specimen to an accuracy of at least 0.1 g.

6.4 Rectangular Template of predetermined length and width having a minimum area of 310 cm<sup>2</sup> [48 in.<sup>2</sup>]. No dimension shall be less than 76 mm [3 in.].

6.5 Knife, or other suitable device for cutting the specimen.

6.6 Drying Oven, or other device capable of maintaining temperature and humidity conditions during the specimen curing cycle, in accordance with the SFRM manufacturer's requirements. (See Section 7.2.)

6.7 Unexpanded Polystyrene Beads, 500 mL—Designation C Bead with a nominal diameter of 1.0 mm [0.04 in.] (preferred) or lead shot—size #8 (alternate).

6.8 Graduated Cylinders, two 250 cm<sup>3</sup>.

6.9 Funnel—Polypropylene funnel having a top diameter of 150 mm [6 in.] and a bottom diameter of 28 mm [1.1 in.].

6.10 Beaker, 400 mL smooth wall type.

6.11 Screed, minimum 150 mm [6 in.] long rigid straight edge.

6.12 Pan—Two flat pans minimum 150 mm [6 in.] diameter with minimum 150 mm high rim.

## 7. Test Specimen

### 7.1 Laboratory Tests:

7.1.1 The test specimens shall be SFRM applied to 1.5 mm [0.06 in. (16 ga.)], 400 by 400 mm [16 by 16 in.] bare or galvanized steel plates.

7.1.2 The specimens shall be conditioned for a period of not less than 72 h at room temperature,  $20 \pm 5^\circ\text{C}$  [ $68 \pm 9^\circ\text{F}$ ] and a relative humidity not greater than 60 %, until successive weight readings, taken at 24 h intervals, differ by less than 1 %.

### 7.2 Field Tests:

7.2.1 As an alternate to 7.1.2, the specimens shall be force dried at a temperature of  $43 \pm 6^\circ\text{C}$  [ $109 \pm 10^\circ\text{F}$ ] and a relative humidity not greater than 60 % until successive readings, taken at 8 h intervals, differ by less than 1 %.

## 8. Procedure

### 8.1 Thickness:

8.1.1 Selected areas to be measured for thickness shall be a predetermined, repetitive pattern to ensure obtaining representative average thickness.

8.1.2 Determine the thickness by inserting the penetrating pin of the thickness gage perpendicular to and through the SFRM, to the substrate. When the point of the pin touches the substrate, move the sliding disk to the SFRM surface with sufficient force on the disk to register the average plane of the surface. Withdraw the gage to read the thickness in 1 mm [ $1/16$  in.] increments as shown by the position of the sliding clip indicator.

8.1.2.1 For the purpose of averaging measurements, any measurement 6 mm [ $1/4$  in.] or more, over the required design thickness, shall be recorded as the design thickness plus 6 mm. No individual measured thickness shall be more than 6 mm less, or more than 25 % less, than the required design thickness.

NOTE 1—Specific fire resistance rating criteria for beams, trusses, and columns may allow for a reduced thickness on flange tips. These thicknesses are to be averaged apart from other sections of the structural member. Also, some fire rating assemblies have different thickness requirements for crests and valleys of floor decks and should be averaged apart.

NOTE 2—Medium and high density SFRM may be too hard to test for thickness by standard procedure. It is recommended to check thicknesses immediately after application, and before curing.

The applicator shall adjust the thickness of the freshly applied SFRM to yield thickness after cure, in accordance with the SFRM manufacturer's recommendations.

If the product is cured and too hard to insert the thickness gage, drill small diameter holes into the product just large enough to accommodate the thickness gage pin. The thickness gage is then inserted into these holes and thickness is determined by the standard procedure. These holes are to be closed off immediately following the test using the same SFRM.

8.1.3 Conducting Thickness Testing—One bay per floor or one bay for each 10 000 ft<sup>2</sup>, whichever provides the greater number of tests. Thickness determinations for the following structural elements shall be conducted in each randomly selected bay: one selected area of metal deck, concrete slab, or wall section; one column; and one beam (joist or truss).

NOTE 3—The applicable building code governs. Consult the applicable building code for exact requirements and tolerances.

### 8.1.4 Tests for the Deck and Wall Section:

8.1.4.1 *Flat Decks*—In the preselected area, lay out a 300 mm [12 in.] square. Take four random symmetrical measurements within that square and report as an average. (See Note 1.)

8.1.4.2 *Fluted Decks*—In the preselected area, lay out a 300 mm [12 in.] square. Take four random symmetrical measurements within that square, one each of the following: valley, crest, and sides, and report as an average. (See Note 1.)

8.1.5 *Test for Beams, Joists (Trusses), and Columns:*

8.1.5.1 *Beams*—For each preselected beam, lay out one 300 mm [12 in.] length and take nine thickness measurements (see Fig. 2) at each end of the 300 mm length (see Fig. 3). (See Notes 1 and 2.)

8.1.5.2 *Joists (Trusses)*—For each preselected joist (truss), lay out one 300 mm [12 in.] length and take seven thickness measurements (see Fig. 4) at each end of the 300 mm length (see Fig. 5). (See Notes 1 and 2.)

8.1.5.3 *Columns*—For each preselected column, lay out one 300 mm [12 in.] length and take twelve thickness measurements (see Fig. 6) at each end of the 300 mm length (see Fig. 7). (See Notes 1 and 2.)

8.1.5.4 *Beams, Joists (Trusses), and Columns*—Average, separately, the 18 thickness measurements for the beams, the 14 thickness measurements for the joists (trusses), and the 24 thickness measurements for the columns. (A sample data sheet is shown in Fig. 8.) (See Notes 1 and 2.)

8.1.6 *Thickness Deficiency*—An item (deck, column, beam, or joist) is deficient if:

8.1.6.1 An individual measured thickness is more than 6 mm [ $\frac{1}{4}$  in.] less, or more than 25 % less, than the required fire resistance design thickness. (See Note 3.)

8.1.6.2 The calculated average thickness of the SFRM is less than that required by the design.

NOTE 4—A thickness to density correction formula is contained in certain fire resistance rating criteria or is available from some SFRM manufacturers. Consult the rating criteria and the SFRM manufacturer for specific information before citing for deficiency.

NOTE 5—If an item is deficient, then only that specific item fails. The remaining items in the bay, and like items in other areas of the building, shall not be deemed to have failed solely because the tested item has failed. (See 8.1.7.)

8.1.7 *Procedure in Case of Deficiency*—If an item is deficient, then it shall be corrected and retested, along with another of that specific item (that is, another column, if a column has failed, and so forth) selected at random.

8.2 *Density:*

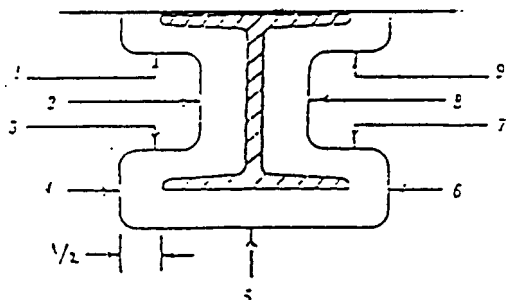
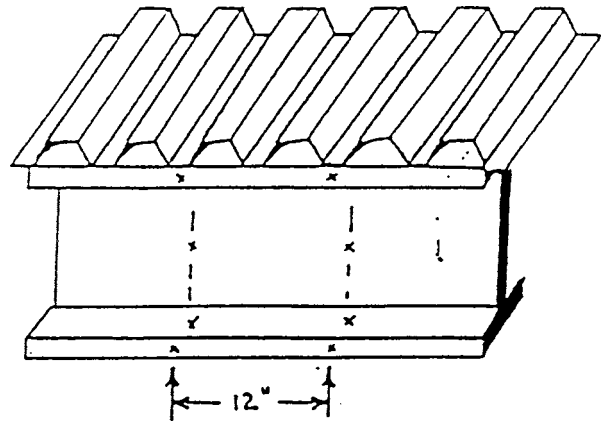

FIG. 2 Test Locations for Measuring Thickness of Fire-Resistive Materials on Beams



NOTE 1—Take nine measurements at each end of 12 in. length.

FIG. 3 Beam

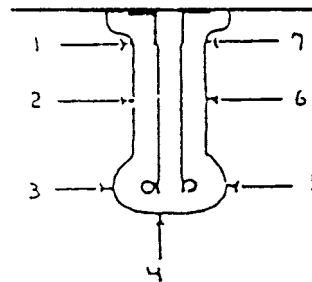
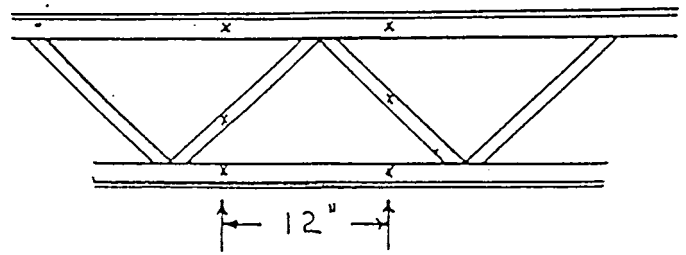

FIG. 4 Test Locations for Measuring Thickness of Fire-Resistive Materials on Joists (Trusses)



NOTE 1—Take 7 measurements at each end of 12 in. length.

FIG. 5 Joist

8.2.1 Conduct one density test at random on each of the following protected elements, per floor or per every 930 m<sup>2</sup> [10 000 ft<sup>2</sup>], whichever provides the greatest number of tests: the flat portion of the deck; a beam, either the bottom of the beam lower flange or the beam web; and a column, either the column web or the outside of one of the column flanges.

8.2.1.1 When density falls between the minimum average and minimum individual values of the fire resistance design, a similar, randomly selected element in the same area shall be tested. If the average density of the two elements is then met, the area passes. If the average is not met, then those elements in that area must be corrected.

8.2.2 *Length and Width*—Score the specimen around the perimeter of the template.

8.2.3 *Thickness*—Utilizing the procedure described in 7.1, take a minimum of twelve thickness measurements, symmetrically. Determine thickness measurements prior to the removal

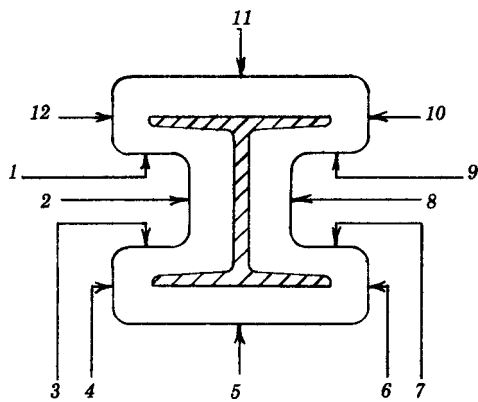
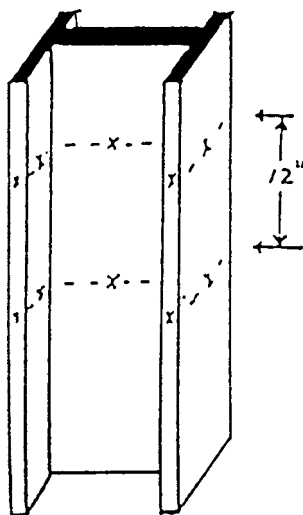

FIG. 6 Test Locations for Measuring Thickness of Fire-Resistive Materials on Beams and Columns



NOTE 1—Take 12 measurements at each end of 12 in. length.

FIG. 7 Column

of SFRM. Consider the average of these twelve measurements to be the thickness of the specimen.

8.2.4 *Weight*<sup>3</sup>—Cut the specimen through to the substrate, along the perimeter of the template. Carefully remove all of the in-place material from the substrate and cure in accordance with 7.2.

8.2.5 *Calculation of Density*—Calculate density as follows:

$$D = \frac{W}{l \times w \times t} \quad (1)$$

where:

- $D$  = density, kg/m<sup>3</sup> [lb/ft<sup>3</sup>],
- $W$  = constant weight of dried material, kg [lb],
- $l$  = length of the specimen, m [ft],
- $w$  = width of the specimen, m [ft], and
- $t$  = average thickness of the specimen, m [ft].

8.3 *Displacement Method:*

8.3.1 This is an alternative method to 8.2 for determining the in-place density of specimens with irregular surfaces or dimensions or for specimens that are difficult to remove from the substrate.

8.3.2 The minimum sample size recommended is 131 cm<sup>3</sup> [8 in.<sup>3</sup>].

8.3.3 The sample shall be cut to a uniform size, removing all uneven edges.

8.3.4 Cure the specimen in accordance with 7.1.2 or 7.2.

8.3.5 Determine weight.

8.3.6 *Volume Determination:*

8.3.6.1 Place the empty 400 mL beaker in the center of the flat pan and pour the unexpanded polystyrene beads or shot through the funnel until the excess beads (shot) fall over the rim of the beaker.

8.3.6.2 Hold the screed perpendicular to the rim of the beaker. Begin at the edge opposite the spout and screed off the excess beads (shot). One pass is all that is needed.

8.3.6.3 Discard the overflow that collects in the pan.

8.3.6.4 Pour all the beads (shot) remaining in the beaker into the graduated cylinders.

8.3.6.5 Return the empty beaker into the center of the pan and pour about 100 mL of beads (shot) poured from the graduated cylinder(s) into the beaker. Do not shake the beaker in any way.

8.3.6.6 Place the sample to be tested in the center of the beaker making sure no edge touches the side of the glass. Gently twist the sample if required.

8.3.6.7 Pour the remainder of the beads from the graduated cylinders over the sample, letting the excess beads (shot) flow over the top of the beaker into the pan. Do not leave any beads (shot) in the graduated cylinders.

8.3.6.8 Screed the excess beads (shot) off the top of the beaker (8.3.6.1) and remove the beaker from the pan.

8.3.6.9 Using the funnel, pour the beads (shot) collected in the pan into the empty graduated cylinder and read the volume displaced by the sample. Do not tap or shake the graduated cylinder when reading.

8.3.7 *Calculation of Density*—Calculate density as follows:

$$D = \frac{W \times 62.43}{V} \quad (2)$$

where:

- $D$  = density in lb/ft<sup>3</sup>,
- $W$  = constant weight of dried material, g, and
- $V$  = volume of sample dried in cm<sup>3</sup> (equal to the volume of beads displaced by the sample).

8.4 *Density Deficiency:*

8.4.1 An item (deck, column, beam, or joist) is deficient if:

8.4.1.1 An individual density is less than that allowed in the fire resistance design.

8.4.1.2 The calculated average density of the SFRM is less than that allowed by the respective fire resistance design. (See Notes 4 and 5.)

8.4.2 Procedure in Case of Deficiency—see 8.1.7 and Note 3.

## 9. Report

9.1 *Thickness*—Report the average, maximum, and minimum thickness of the test specimens, expressed in millimetres [inches].



## 10. Precision and Bias

10.1 The precision and bias of this test method has not been determined. A statement is being developed and will be added when completed.

*ASTM International takes no position respecting the validity of any patent rights asserted in connection with any item mentioned in this standard. Users of this standard are expressly advised that determination of the validity of any such patent rights, and the risk of infringement of such rights, are entirely their own responsibility.*

*This standard is subject to revision at any time by the responsible technical committee and must be reviewed every five years and if not revised, either reapproved or withdrawn. Your comments are invited either for revision of this standard or for additional standards and should be addressed to ASTM International Headquarters. Your comments will receive careful consideration at a meeting of the responsible technical committee, which you may attend. If you feel that your comments have not received a fair hearing you should make your views known to the ASTM Committee on Standards, at the address shown below.*

*This standard is copyrighted by ASTM International, 100 Barr Harbor Drive, PO Box C700, West Conshohocken, PA 19428-2959, United States. Individual reprints (single or multiple copies) of this standard may be obtained by contacting ASTM at the above address or at 610-832-9585 (phone), 610-832-9555 (fax), or [service@astm.org](mailto:service@astm.org) (e-mail); or through the ASTM website ([www.astm.org](http://www.astm.org)). Permission rights to photocopy the standard may also be secured from the Copyright Clearance Center, 222 Rosewood Drive, Danvers, MA 01923, Tel: (978) 646-2600; <http://www.copyright.com/>*

## 11. Keywords

11.1 density; sprayed fire-resistive materials; thickness