

ASME Y14.40.4-2002

(Identical to ISO 14617-4: 2002)

**GRAPHICAL SYMBOLS
FOR DIAGRAMS, PART 4:
ACTUATORS AND
RELATED DEVICES**

An American National Standard



**The American Society of
Mechanical Engineers**

ADOPTION NOTICE

ASME Y14.40.4, Graphical Symbols for Diagrams, Part 4: Actuators and Related Devices, was adopted on December 19, 2002 for use by the Department of Defense, DoD. Proposed changes by DoD activities must be submitted to the DoD Adopting Activity: Commander, U.S. Army TACOM-ARDEC, ATTN: AMSTA-AR-QAW-E, Picatinny Arsenal, NJ 07806-5000. Copies of this document may be purchased from The American Society of Mechanical Engineers (ASME), 22 Law Drive, PO Box 2900, Fairfield, NJ 07007-2900; <http://www.asme.org>.

Custodians:

Army — AR
Navy — SA
Air Force — 16
DLA — DH

Adopting Activity:

Army — AR

(Project DRPR-0372)

Review Activities:

Army — AT, AV, CE, CR, EA, MI, SM, TE
Navy — AS, CH, EC, MC, OS, SH, TD, YD
Air Force — 11, 13, 19, 68, 70, 71, 84, 99
DLA — CC, GS, IS
NSA — NS

AMSC N/A

AREA DRPR

DISTRIBUTION STATEMENT A. Approved for public release; distribution is unlimited.



The American Society of
Mechanical Engineers

A N A M E R I C A N N A T I O N A L S T A N D A R D

GRAPHICAL SYMBOLS FOR DIAGRAMS, PART 4: ACTUATORS AND RELATED DEVICES

ASME Y14.40.4-2002
(Identical to ISO 14617-4: 2002)

Date of Issuance: July 25, 2003

The next edition of this Standard is scheduled for publication in 2007. There will be no addenda or written interpretations of the requirements of this Standard issued to this edition.

ASME is the registered trademark of The American Society of Mechanical Engineers.

This code or standard was developed under procedures accredited as meeting the criteria for American National Standards. The Standards Committee that approved the code or standard was balanced to assure that individuals from competent and concerned interests have had an opportunity to participate. The proposed code or standard was made available for public review and comment that provides an opportunity for additional public input from industry, academia, regulatory agencies, and the public-at-large.

ASME does not "approve," "rate," or "endorse" any item, construction, proprietary device, or activity.

ASME does not take any position with respect to the validity of any patent rights asserted in connection with any items mentioned in this document, and does not undertake to insure anyone utilizing a standard against liability for infringement of any applicable letters patent, nor assumes any such liability. Users of a code or standard are expressly advised that determination of the validity of any such patent rights, and the risk of infringement of such rights, is entirely their own responsibility.

Participation by federal agency representative(s) or person(s) affiliated with industry is not to be interpreted as government or industry endorsement of this code or standard.

ASME accepts responsibility for only those interpretations of this document issued in accordance with the established ASME procedures and policies, which precludes the issuance of interpretations by individuals.

No part of this document may be reproduced in any form,
in an electronic retrieval system or otherwise,
without the prior written permission of the publisher.

The American Society of Mechanical Engineers
Three Park Avenue, New York, NY 10016-5990

Copyright © 2003 by
THE AMERICAN SOCIETY OF MECHANICAL ENGINEERS
All rights reserved
Printed in U.S.A.

CONTENTS

Foreword	iv
Committee Roster	v
1 Scope	1
2 References	1
3 Terms and Definitions	1
4 Basic Elements	2
5 Manually Operated Actuators	6
6 Automatic Actuators	9
7 Actuating Devices	11

FOREWORD

This Standard is the adoption as an American National Standard of ISO 14617-4:2002. The ASME Standards Committee Y14, Engineering Drawing Practices and Related Documentation, is responsible for this Standard and supervises the U.S. participation in the ISO Technical Committee 10 activity responsible for the development and maintenance of its counterpart ISO 14617-4 through the U.S. Technical Advisory Group for ISO/TC 10. This Standard is "identical" to ISO 14617-4:2002 as that term is defined in ISO/IEC Guide 21:1999 and the first in a series of standards providing graphical symbols for diagrams in a variety of technical disciplines. The titles of the series are:

- Part 1: General information and indexes
- Part 2: Symbols having general application
- Part 3: Connections and related devices
- Part 5: Measurement and control devices
- Part 6: Measurement and control functions
- Part 7: Basic mechanical components
- Part 8: Valves and dampers
- Part 9: Pumps, compressors and fans
- Part 10: Fluid power converters
- Part 11: Devices for heat transfer and heat engines
- Part 12: Devices for separating, purification, and mixing
- Part 15: Installation diagrams and network maps

Other parts are under preparation.

Suggestions for improvement of this Standard are welcomed. They should be sent to The American Society of Mechanical Engineers, Attention: Secretary, Y14 Main Committee, Three Park Avenue, New York, NY 10016. This Standard was approved as an American National Standard on December 19, 2002.

ASME STANDARDS COMMITTEE Y14

Engineering Drawing and Related Documentation Practices

(The following is the roster of the Committee at the time of approval of this Standard.)

OFFICERS

F. Bakos, *Chair*
K. E. Wiegandt, *Vice Chair*
C. J. Gomez, *Secretary*

COMMITTEE PERSONNEL

A. R. Anderson, Dimensional Control Systems, Inc.
J. B. Baker, Consultant
F. Bakos, Consultant
J. V. Burteigh, The Boeing Co.
R. A. Chadderdon, Southwest Consultants
M. E. Curtis, Jr., Rexnord Industries, Inc.
D. E. Day, Monroe Community College
B. Dinardo, U.S. Department of the Army, ARDEC
C. W. Ferguson, WM Education Services
L. W. Foster, L. W. Foster Associates, Inc.
C. J. Gomez, The American Society of Mechanical Engineers
B. A. Harding, Purdue University
K. S. King, Naval Surface Warfare Center, Dahlgren Division
A. Krulikowski, General Motors Powertrain
H. S. Lachut, Alstom Power Inc.
P. J. McCuiston, Ohio University
E. Niemiec, MTD Products, Inc.
K. E. Wiegandt, Sandia National Laboratory
B. A. Wilson, The Boeing Co.
P. Wreede, Consultant

SUBCOMMITTEE 40 — GRAPHIC SYMBOLS

B. A. Harding, *Chair*, Purdue University
K. Boehme, National Fluid Power Association
V. Charles, U.S. Department of the Army, ARDEC
M. D. Harlick, Boeing Commercial Airplanes
H. S. Lachut, Alstom Power Inc.
F. L. Shell, Jr., Consultant
B. S. Wood, Consultant

Graphical Symbols For Diagrams, Part 4: Actuators And Related Devices

1 SCOPE

This Standard specifies graphical symbols for basic elements in actuators, complete actuators, and actuating devices in diagrams.

For the fundamental rules of creation and application of graphical symbols in diagrams, see Y14.40.0.

For an overview of the ASME Y14 series, information on the creation and use of registration numbers for identifying graphical symbols used in diagrams, rules for the presentation and application of these symbols, and examples of their use and application, see Y14.40.1.

2 REFERENCES

The following references contain provisions that, through reference in this text, constitute provisions of this Standard. For dated references, subsequent amendments to, or revisions of, any of these publications do not apply. However, parties to agreements based on this Standard are encouraged to investigate the possibility of applying the most recent editions of the references indicated below. For undated references, the latest edition applies.

ASME Y14.40.0, Basic Rules for the Design of Graphical Symbols for Use in the Technical Documentation of Products

ASME Y14.40.1, Graphical Symbols for Diagrams, Part 1: General Information and Indexes

ASME Y14.40.2, Graphical Symbols for Diagrams, Part 2: Symbols Having General Application

ASME Y14.40.7, Graphical Symbols for Diagrams, Part 7: Basic Mechanical Components

ASME Y14.40.8, Graphical Symbols for Diagrams, Part 8: Valves and Dampers

Publisher: The American Society of Mechanical Engineers (ASME International), Three Park Avenue, New York, NY 10016; Order Department: 22 Law Drive, P.O. Box 2300, Fairfield, NJ 07007

3 TERMS AND DEFINITIONS

For the purposes of this Standard, the following terms and definitions apply.

3.1

actuator: part of a component for the displacement of the movable parts of, for example, a shut-off valve or an electromechanical switching device.

3.2

actuating device: actuator consisting of several functionally interrelated components or elements, the description of which needs a diagram.

EXAMPLE An actuator consisting of a fluid or electric motor, a set of auxiliary contacts, and a measuring transducer transmitting information on the actual position of the actuated device.

3.3

manual actuator: actuator for operation by human force

3.4

automatic: (control, operation) self-acting (not needing human intervention).

3.5

automatic actuator: actuator activated without human intervention.

EXAMPLE Actuation by a process variable or from a remote control unit.

3.6

automatic return device: device for returning movable parts, for example, those of a valve, to initial position (at rest position) after an actuating force has been removed

3.7

clutch: device for connecting and disconnecting working parts, for example, of a machine.

3.8

delay device: device providing a time interval between the instant when an actuating force is applied or removed and the instant when the consequent change of position or state of the affected parts starts.

3.9

detent: device that retains movable parts, for example those of a valve, in a certain position until sufficient force is applied to overcome the detaining force in order to move the parts to another position.

3.10

latching device: mechanical device giving movable parts, for example, those of a valve, the possibility to move in one direction but preventing them from returning until the latch has been released.

3.11

blocking device: mechanical device preventing movable parts, for example, those of a valve, from moving in any direction until the blocking device has been released.

3.12

trip-free device: (electromechanical switching) mechanical device ensuring that a, for example, circuit breaker trips and remains in tripped position independent of other operating commands.

3.13

interlocking device: mechanical device making the operation of movable parts of one component, for example, a contactor, dependent on the position or state of another component with movable parts.

3.14







operation: transfer of mechanical parts, for example, the closing member of a shut-off valve or the contacts of an electromechanical switching device.





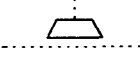

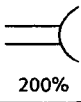



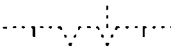

NOTE 1: The transfer direction can be defined as opening operation, closing operation, ON-operation, OFF-operation, etc.

NOTE 2: The term has a specific meaning in conjunction with electric measuring relays. An over/under... relay is operating when its characteristic quantity reaches the set value by increasing/decreasing value.

4 BASIC ELEMENTS

4.1 Symbols of a Basic Nature

Reference Number	Registration Number	Symbol Form/Shape	Symbol Description
4.1.1	2008		Mechanical gear pair.
4.1.2	2009		Clutch, disengaged in unactuated state.
4.1.3	2010		Clutch, engaged in unactuated state.
4.1.4	2011		Brake, disengaged in unactuated state.
4.1.5	2012		Brake, applied in unactuated state.
4.1.6	651	Form 1  200%	Delay device. The action is delayed when the direction of movement is towards the center of the arc. See R651 (4.2.1).
4.1.7	652	Form 2  200%	
4.1.8	653	 200%	Delay device. The action is delayed in both directions. See R651 (4.2.1).

Reference Number	Registration Number	Symbol Form/Shape	Symbol Description
4.1.9	654	 200%	Automatic return device. The return direction is towards the apex. See R652 (4.2.2) and R653 (4.2.3). For the use of the symbol together with symbols for valves, see R2101 (8-4.2.1).
4.1.10	2002		Spring. See R2001 (7-4.2.2).
4.1.11	655	 200%	Detent for detaining in a discrete position. See R652 (4.2.2).
4.1.12	656		Detent for detaining in a discrete position shown in disengaged position.
4.1.13	657		Detent for detaining in a discrete position shown in engaged position.
4.1.14	658		Indication of position without detention. Two positions are shown.
4.1.15	659	 200%	Detent for detaining in any position. See R652 (4.2.2).
4.1.16	660	 200%	Detent for detaining in any position; drift to the left permitted.
4.1.17	661	 200%	Latching device.
4.1.18	662		Latching device shown in disengaged position.
4.1.19	663		Latching device shown in engaged position.
4.1.20	664	 200%	Blocking device.
4.1.21	665		Trip-free mechanism. See R654 (4.2.4).
4.1.22	666	 200%	Interlocking device.

4.2 Application Rules for the Symbols in Para. 4.1

Reference Number	Registration Number	Application Rule
4.2.1	R651	The double line shall be attached to the symbol for the element of a component or device that is delayed. For examples, see X653 (4.5.3) and X654 (4.5.4).
4.2.2	R652	The symbol may be omitted if the behavior of the component is understood by the symbol for the actuator. Cf. 5.1, R683 (5.2.3), and R685 (5.2.5). For examples, see 5.5.
4.2.3	R653	In symbols for valves with spring return, the symbol may be replaced with symbol 2002 (4.1.10) for a spring. It shall then be located such that the spring is imagined to be released when the valve returns to its at-rest position, independent of the physical design. Cf. R2001 (7-4.2.2). For an example, see X688 (5.5.8).

Reference Number	Registration Number	Application Rule
4.2.4	R654	In the symbol, the connect points A to D of the figure below shall be used in the following way.
		A For mechanical connection to normal operation means.
		B For mechanical connection to actuated parts, for example, the contacts of an electromechanical switching device.
		C, D For mechanical connection to actuator with an overriding function.

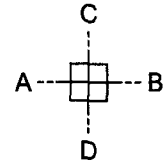

4.3 Symbol Giving Supplementary Information

None.

4.4 Application Rule for the Symbol in 4.3

None.

4.5 Application examples













Reference Number	Registration Number	Symbol Form/Shape	Symbol Description
4.5.1	X651	 402, 2009, IEC	Solenoid-operated clutch, disengaged at no-voltage.
4.5.2	X652	 403, 2012, IEC	Solenoid-operated brake applied at no-voltage.
4.5.3	X653	 404, 651, 652, IEC, IEC	Electromechanical all-or-nothing relay with three contacts, the second one delayed when the coil is energized, the third one delayed when the coil is de-energized.
4.5.4	X654	 404, 651, IEC, IEC, IEC	Electromechanical all-or-nothing relay, the whole relay delayed when the coil is energized.
4.5.5	X655	 403, 655, 2002, 2101, 2112	Spring-loaded safety valve detained open after operation.

Reference Number	Registration Number	Symbol Form/Shape	Symbol Description
4.5.6	X656	<p>404, 654, 655, 685, 701, IEC</p>	Manually operated multi-position control switch shown in position O (off), detained in positions P (parking) and D (drive), and with automatic return from position S to D. Cf. symbol 701 (5.3.1).
4.5.7	X657	<p>404, 654, 662, 681, IEC, IEC</p>	Manually operated control switch with a manually disengaged latch.
4.5.8	X658	<p>404, 654, 662, 681, IEC, IEC, IEC</p>	Manually operated control switch with an electrically disengaged latch.
4.5.9	X659	<p>171, 404, 665, 682, 741, 2002, IEC, IEC, IEC, IEC, IEC, IEC</p>	<p>Three-pole electromechanical switching device with:</p> <ul style="list-style-type: none"> - trip-free mechanism; - spring-operating mechanism; - electric motor for the recharge of the spring; - closing coil; - trip coil; - instantaneous overcurrent release; - thermal overload release

5 MANUALLY OPERATED ACTUATORS

5.1 Symbols of a Basic Nature

NOTE: For the interpretation of two parallel actuator symbols, see R681 (5.2.1).

Reference Number	Registration Number	Symbol Form/Shape	Symbol Description
5.1.1	681		Manual actuator. See R682 (5.2.2).
5.1.2	682		Manual actuator operated by pushing. See R682 (5.2.2) and R683 (5.2.3).
5.1.3	683		Manual actuator operated by pulling. See R682 (5.2.2) and R683 (5.2.3).
5.1.4	684		Manual actuator operated by pushing and pulling. See R682 (5.2.2) and R684 (5.2.4).
5.1.5	685		Manual actuator operated by turning. See R682 (5.2.2) and R685 (5.2.5).
5.1.6	686		Manual actuator in form of removable handle. See R682 (5.2.2) and R685 (5.2.5).
5.1.7	687		Manual actuator in form of key. See R682 (5.2.2) and R685 (5.2.5).
5.1.8	688		Manual actuator in form of lever. See R682 (5.2.2) and R684 (5.2.4).
5.1.9	689		Manual actuator in form of pedal. See R682 (5.2.2) and R683 (5.2.3).
5.1.10	690		Manual actuator in form of treadle. See R682 (5.2.2) and R684 (5.2.4).
5.1.11	691		Manual actuator with special shape for safety purpose, for example, emergency stop.
5.1.12	692		Device for restricted access to actuator, for example, a cover to be turned up.

5.2 Application Rules for the Symbols in Para. 5.1

Reference Number	Registration Number	Application Rule
5.2.1	R681	When symbols for two or more actuators (manual or automatic) are located in parallel, an OR-relation between the actuators exists if not otherwise indicated, for example, by symbol 142 (2-4.3.2.28) for an AND-function at the junction point.
5.2.2	R682	The function associated with each position may be indicated adjacent to the symbols, when applicable, by symbols 701 (5.3.1) to 704 (5.3.4). For examples, see X684 (5.5.4) to X687 (5.5.7).
5.2.3	R683	When the symbol for pushing, pulling, or pedal is used, automatic return is assumed. Thus, the symbol 654 (4.1.9) for automatic return may be omitted. For examples, see X681 (5.5.1) and X682 (5.5.2). On the other hand, if automatic return does not apply, symbol 655 (4.1.11) for a detent shall be used.

Reference Number	Registration Number	Application Rule
5.2.4	R684	When the symbol for pushing and pulling, lever, or treadle is used, automatic or nonautomatic return shall be indicated. For examples, see X683 (5.5.3) and X684 (5.5.4).
5.2.5	R685	When the symbol for turning, removable handle, or key is used, non-automatic return (detent) is assumed. Thus, symbol 655 (4.1.11) for a detent may be omitted. On the other hand, if detaining does not apply, the symbol for automatic return shall be used.

5.3 Symbols Giving Supplementary Information

NOTE: For the significance and application of the solid and dashed lines, see R701 (5.4.1).

Reference Number	Registration Number	Symbol Form/Shape	Symbol Description
5.3.1	701		Indication of positions of a controlled element having four positions and operated towards position 4 by turning clockwise. The actual position is position 2.
5.3.2	702		Indication of positions of a controlled element having four positions and operated by turning. The actuator can move only between positions 1 and 4 clockwise (and back counterclockwise). The actual position is position 1.
5.3.3	703		Indication of positions of a controlled element having three positions and operated by turning. The actuator can only be turned clockwise. The actual position is position 1.
5.3.4	704		Indication of positions of a controlled element having four positions and operated by turning. The actuator can only be turned 360° clockwise except for a movement from position 3 to position 2. The actual position is position 1.

5.4 Application Rules for the Symbols in Para. 5.3

Reference Number	Registration Number	Application Rule
5.4.1	R701	The actual position shall be indicated by a solid line, the other positions by dashed lines. The symbol shall be oriented such that it shows the real turning direction of the actuator, i. e. if the change from position 1 to position 4 in symbol 701 (5.3.1) would instead have implied a counterclockwise turning, then the symbol has to be mirror-imaged with the 'hinge point' to the left.

5.5 Application Examples

NOTE: See also examples X656 (4.5.6) to X658 (4.5.8).

Reference Number	Registration Number	Symbol Form/Shape	Symbol Description
5.5.1	X681		Control switch operated by pushing. When pushing, contact 13-14 closes and 21-22 opens. Automatic return is assumed in accordance with R683 (5.2.3).



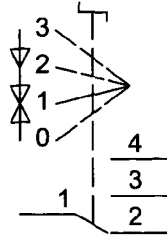
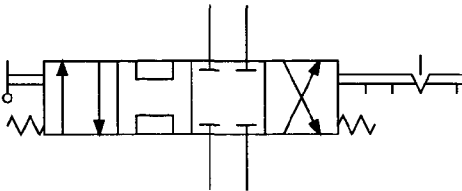





Reference Number	Registration Number	Symbol Form/Shape	Symbol Description
5.5.2	X682	<p>404, 683, IEC, IEC</p>	Control switch operated by pulling. When pulling, contact 13-14 closes and 21-22 opens. Automatic return is assumed in accordance with R683 (5.2.3).
5.5.3	X683	<p>404, 654, 684, IEC</p>	Control switch with three positions operated by pushing and pulling. When pulling, the path 1-2 is closed, when pushing the path 2-3 is closed, with automatic return to the mid-position in which position both paths are open.
5.5.4	X684	<p>404, 501, 654, 688, 701, IEC</p>	Control switch operated by a lever with four operation directions. When the lever is moved from position 0 (off) to B (backwards), the current path 11-13 is closed. When the lever is moved from 0 to F (forwards), path 11-12 is closed. When the lever is moved from 0 to L (left), the path 21-23 is closed, and when the lever is moved from 0 to R (right), path 21-22 is closed. The switch has an automatic return to position 0. The F-O-B operation and the R-O-L operation are independent of each other.
5.5.5	X685	<p>404, 654, 681, IEC</p>	Manually operated control switch with three positions, 0 (off), L (low), and H (high), with automatic return to position 0.
5.5.6	X686	<p>404, 654, 685, 701, IEC</p>	Control switch operated by turning, with four positions and automatic return from the two extreme positions ONCMD (on-command) and OFFCMD (off-command) to the nearest stable positions ONIND (on-indication) and OFFIND (off-indication).

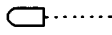
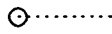



Reference Number	Registration Number	Symbol Form/Shape	Symbol Description
5.5.7	X687	 <p>404, 654, 685, 701, IEC</p>	Control switch operated by turning with four positions and automatic return from positions 0, 2, and 3 to position 1.
5.5.8	X688	 <p>242, 402, 658, 688, 2002, 2161, 2171, 2172</p>	<p>Directional control valve with four positions, operated by a lever and with one stable position and automatic return from the other positions.</p> <p>The left-/right-hand spring symbol indicates automatic return to the right or left.</p>

6 AUTOMATIC ACTUATORS

6.1 Symbols of a Basic Nature

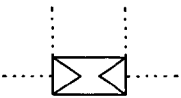
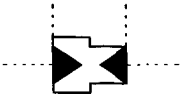
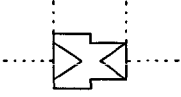
NOTE: For the interpretation of two parallel actuator symbols, see R681 (5.2.1).

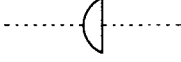
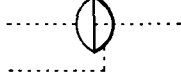
Reference Number	Registration Number	Symbol Form/Shape	Symbol Description
6.1.1	711		Plunger; tracer.
6.1.2	712		Roller.
6.1.3	713		<p>Cam profile.</p> <p>See R711 (6.2.1).</p>
6.1.4	714		Cam-operated actuator.
6.1.5	715		Fluid-level-operated actuator, for example, in the form of a float.
6.1.6	716		Flow-target-operated actuator, for example, in the form of a mechanical flag.
6.1.7	717		Single-acting hydraulic actuator.
6.1.8	718		Single-acting pneumatic actuator.
6.1.9	719		Double-acting hydraulic actuator.

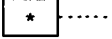
Reference Number	Registration Number	Symbol Form/Shape	Symbol Description
6.1.10	720		Double-acting pneumatic actuator.
6.1.11	721		Double-acting hydraulic actuator with different active areas.
6.1.12	722		Double-acting pneumatic actuator with different active areas.
6.1.13	723		Actuator in the form of a single-acting fluid cylinder.
6.1.14	724		Actuator in the form of a double-acting fluid cylinder.
6.1.15	725		Single-acting diaphragm actuator.
6.1.16	726		Double-acting diaphragm actuator.
6.1.17	2407		Actuator in the form of a hydraulic motor with alternative directions of flow.
6.1.18	2408		Actuator in the form of a pneumatic motor with alternative directions of flow.
6.1.19	733		Actuator operating when a characteristic quantity passes a set value. See R712 (6.2.2).

6.2 Application Rules for the Symbols in Para. 6.1

Reference Number	Registration Number	Application Rule
6.2.1	R711	The shape of the symbol shall correspond to that of the cam itself. For example, see X711 (6.5.1). A cam with circular form may be shown developed as in the symbol shown.
6.2.2	R712	The asterisk shall be replaced with a symbol in accordance with 2-4.3.4. For examples, see X716 (6.5.4) and X717 (6.5.5).

6.3 Symbol Giving Supplementary Information

None.

6.4 Application Rule for the Symbol in Para. 6.3

None.

6.5 Application Examples

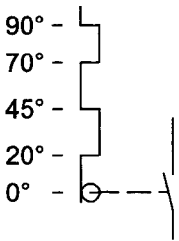
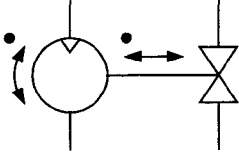
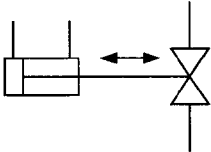
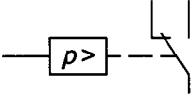
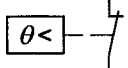
Reference Number	Registration Number	Symbol Form/Shape	Symbol Description
6.5.1	X711	 <p>404, 712, 713, IEC</p>	Cam profile and roller affecting a make contact. The contact is closed between 20° and 45° and between 70° and 90°.
6.5.2	X712	 <p>245, 256, 263, 403, 2101, 2406</p>	Actuator in the form of a pneumatic motor. When the motor rotates clockwise/counter-clockwise, the valve opens/closes. Cf. R2101 (8-4.2.1).
6.5.3	X713	 <p>245, 403, 724, 2101</p>	Actuator in the form of a double-acting fluid cylinder. When the cylinder moves to the left/right, the valve opens/closes. Cf. R2101 (8-4.2.1).
6.5.4	X716	 <p>171, 404, 733, IEC</p>	Pressure pilot switch operating when the actual pressure is greater than the set value.
6.5.5	X717	 <p>172, 404, 733, IEC</p>	Temperature pilot switch operating when the actual temperature is less than the set value.

7 ACTUATING DEVICES

7.1 Symbol of a Basic Nature

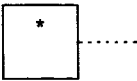
Reference Number	Registration Number	Symbol Form/Shape	Symbol Description
7.1.1	741		<p>Actuating device consisting of:</p> <ul style="list-style-type: none"> - a main element, for example, a lever for manual operation, a solenoid, a spring device for energy storing, and - auxiliary elements, for example, auxiliary contacts and a blocking device. <p>See R741 (7.2.1).</p>

7.2 Application Rule for the Symbol in Para. 7.1

Reference Number	Registration Number	Application Rule
7.2.1	R741	The asterisk shall be replaced with a symbol indicating the operation method.



7.3 Symbol Giving Supplementary Information

None.

7.4 Application Rule for the Symbol in Para. 7.3

None.

7.5 Application Examples

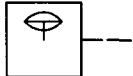
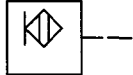
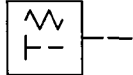
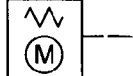
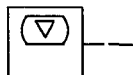
Reference Number	Registration Number	Symbol Form/Shape	Symbol Description
7.5.1	X741	 404, 723, 741	Actuating device, the main element of which is a single-acting fluid cylinder.
7.5.2	X742	 404, 741, 2406	Actuating device, the main element of which is a pneumatic motor.
7.5.3	X743	 404, 726, 741	Actuating device, the main element of which is a double-acting diaphragm actuator.
7.5.4	X744	 122, 404, 741	Actuating device, operating with touch effect.
7.5.5	X745	 404, 681, 741, 2002	Actuating device, spring-operated with manual spring charging.
7.5.6	X746	 404, 741, IEC, 2002	Actuating device, spring-operated with spring charging by an electric motor.
7.5.7	X747	 244, 404, 741, 2062	Actuating device operated by pneumatic power stored inside the actuator.

RELATED DOCUMENTS

Engineering Drawing and Related Documentation Practices	
Decimal Inch Drawing Sheet Size and Format	Y14.1-1995(R2002)
Metric Drawing Sheet Size and Format	Y14.1M-1995(R2002)
Line Conventions and Lettering	Y14.2M-1992(R1998)
Multiview and Sectional View Drawings	Y14.3M-1994(R1999)
Pictorial Drawings	Y14.4M-1989(R1999)
Dimensioning and Tolerancing	Y14.5M-1994(R1999)
Mathematical Definition of Dimensioning and Tolerancing Principles	Y14.5.1M-1994(R1999)
Certification of Geometric Dimensioning and Tolerancing Professionals	Y14.5.2-2000
Screw Thread Representation	Y14.6-2001
Gears and Splines	
Spur, Helical, Double Helical and Racks	Y14.7.1-1971(R1998)
Bevel and Hypoid Gears	Y14.7.2-1978(R1999)
Castings and Forgings	Y14.8M-1996(R2002)
Mechanical Spring Representation	Y14.13M-1981(R1998)
Optical Parts	Y14.18M-1986(R1998)
Types and Applications of Engineering Drawings	Y14.24-1999
Chassis Frames — Passenger Car and Light Truck — Ground Vehicle Practices	Y14.32.1M-1994(R1999)
Associated Lists	Y14.34M-1996(R2002)
Revision of Engineering Drawings and Associated Documents	Y14.35M-1997
Surface Texture Symbols	Y14.36M-1996(R2002)
Abbreviations and Acronyms	Y14.38-1999
Basic Rules for the Design of Graphical Symbols for Use in the Technical Documentation of Products	Y14.40.0-2002
Graphical Symbols for Diagrams, Part 2: Symbols Having General Applications	Y14.40.2-2002
Graphical Symbols for Diagrams, Part 3: Connections and Related Devices	Y14.40.3-2002
Graphical Symbols for Diagrams, Part 4: Actuators and Related Devices	Y14.40.4-2002
Graphical Symbols for Diagrams, Part 5: Measurement and Control Devices	Y14.40.5-2002
Graphical Symbols for Diagrams, Part 6: Measurement and Control Functions	Y14.40.6-2002
Graphical Symbols for Diagrams, Part 7: Basic Mechanical Components	Y14.40.7-2002
Graphical Symbols for Diagrams, Part 9: Pumps, Compressors, and Fans	Y14.40.9-2002
Digital Approval Systems	Y14.42-2002
Engineering Drawing Practices	Y14.100-2000
Graphic Symbols for:	
Plumbing Fixtures for Diagrams Used in Architecture and Building Construction	Y32.4-1977(R1999)
Railroad Maps and Profiles	Y32.7-1972(R1999)
Mechanical and Acoustical Elements as Used in Schematic Diagrams	Y32.18-1972(R1998)

The ASME Publications Catalog shows a complete list of all the Standards published by the Society. For a complimentary catalog, or the latest information about our publications, call 1-800-THE-ASME (1-800-843-2763).

ISBN 0-7918-2815-8

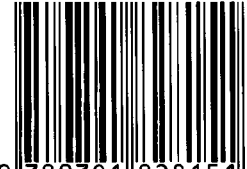

9 780791 828151



N17502