

\$16.95



This book shows non-destructive ways to open locks if you lose your keys. Since your resources are usually on the other side of the door when you're locked out, it shows how to improvise tools from garbage and common, everyday items. Multiple entrance options are provided in case of stubborn doors or limited materials. This is excellent practical knowledge to have if you ever need it.



HOW TO OPEN LOCKS WITH IMPROVISED TOOLS by HANS CONKEL \$16.95

**EVER BEEN
LOCKED
OUT?**

Expanded Edition

HOW TO OPEN LOCKS WITH IMPROVISED TOOLS

formerly published as
Lock Bypass Methods

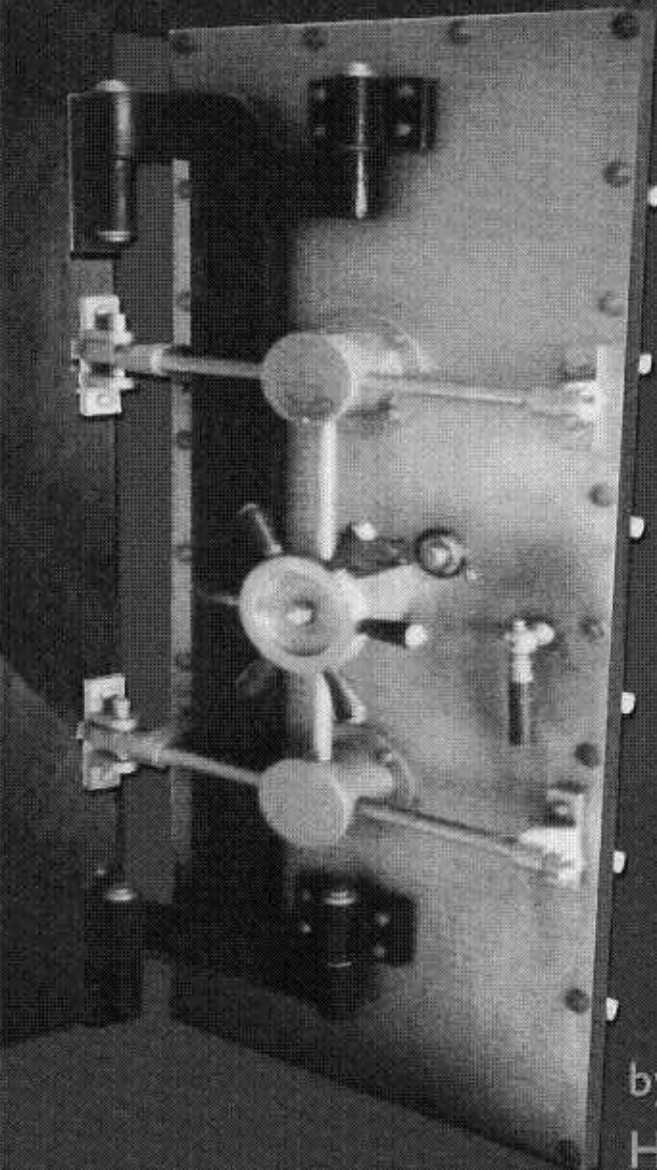

Practical,
non-destructive
ways of getting
back into just
about everything
when you lose
your keys

by
HANS CONKEL

Disclaimer

Read the following disclaimer before reading or using any of the information in this book. If you do not accept the terms of the disclaimer, do not use the information contained herein.

You are responsible for your own actions. The author, publisher, and distributors assume no liability for the use or misuse of the information in the book, and do not encourage or condone illegal behavior. Some of the methods described may result in damaged hardware or possible injury, due to the nature of the techniques. If you decide to practice or employ a technique described in the book, you do so at your own risk.

Great pains have been taken to ensure that the information in this book is accurate, practical, and useful. However, the author, publisher, and distributors can accept no liability for damage, loss, or injury caused by errors in, or omissions from, the information given.

To the maximum extent permitted by applicable law, the author, publisher, and distributors expressly disclaim all warranties and conditions, whether express or implied, and do not warrant that the material will meet the reader's requirements. In no event shall the author's, publisher's, or distributors' liability for any damages hereunder exceed the amounts received for the book in connection with this agreement.

HOW TO OPEN LOCKS WITH IMPROVISED TOOLS

PRACTICAL, NON-DESTRUCTIVE WAYS OF GETTING BACK INTO JUST ABOUT
EVERYTHING WHEN YOU LOSE YOUR KEYS

By Hans Conkel

formerly published as:

LOCK BYPASS METHODS

All Rights Reserved

Copyright © 1998, 2001 Level Four Publications, Inc.

No part of this book may be reproduced or transmitted in any form or by any means, electronic or mechanical, including photocopying, recording, or by any information storage or retrieval system, without permission in writing from the publisher.

For information address: LevelFourPublications@yahoo.com

ISBN 0-9666087-1-2

9 8 7 6 5 4 3 2 1

How to Open Locks with Improvised Tools

Practical, non-destructive ways of
getting back into just about everything
when you lose your keys

By Hans Conkel

TABLE OF CONTENTS

Warning	1	Automobiles	85
Guidelines to Successful Lock Bypass	3	Guidelines for Entering Door Cavities	91
Lock Picking	14	Tools	93
How Locks Work	17	Vertical Linkage Grabbers	93
Pin Tumbler Locks	18	Button Lifting Tool	95
Wafer Tumbler Locks	19	To Unlock A Vehicle with a Vertical Linkage	96
The Tension Wrench	20	Reaching the Electric Unlocking Button	97
Lock Picks	27	Horizontal Linkage	98
Bump Keys	30	To Use a Linkage Tool	98
The Pick Gun	32	Under the Window Tool	101
The Plug Spinner	34	Trunks	102
Lock Bypass	37	Tool Making	104
Slipping the Latch	38	Lock Picks	104
Quick Procedure to Bypass a Very Common Knobset	43	Materials for Lock Picks	107
Knob Removal	49	Tools Needed to Make Lock Picks	108
Grabbing the Inside Knob	54	How Big is a Lock Pick?	109
Lever Doors	59	Tension Wrenches	111
Push Bars	62	Emergency Lock Picks	112
Deadbolts	65	How to Make a Pick Gun	114
Padlocks, Cabinets, and Miscellaneous	74	How to Make a Plug Spinner	115
Deciphering Combination Locks	75	Wire Tools	116
Three or Four Dial Combination Locks	76	Preferred Materials for Linkage Tools	117
Cabinets	77	Bending Wire	120
Drawers	78	If Your Vehicle Has an Unshielded Vertical Linkage	121
Hinges	79	Security	122
File Cabinets	80	Around the House	123
Sliding Door Cabinets	80	Cars	126
U Bolt Bicycle Locks	81	Locked Luggage	128
Handcuffs	82	Warded Padlocks	128
		Safety Chain Opening	130
		Emergency Car Opening Tool	130

EFFECTIVE EMERGENCY LOCK PICKS

An excellent emergency pick can be made from a bobby pin and a couple of pieces of tape. Carefully unbend a bobby pin so that it lies flat. Remove the plastic tip from the straighter end. The tricky part is bending the tip of the tool into the shape of a rake pick. Put the tip of the bobby pin sideways into a keyhole where it fits snugly, and bent it to the left or right. When you bend the tip, the metal will try to twist and bend in its more natural direction, so be careful. Once the tip is bent, put some tape on the handle end so you have good control over the tip. Used carefully, this pick will last a long time.

Some pen caps have metal pocket clips, and these make passable tension wrenches in an emergency.

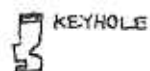
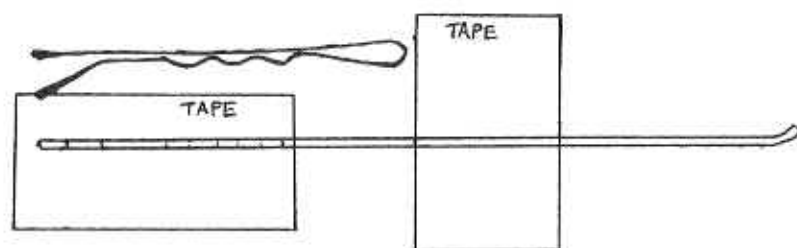

KEYHOLE



ENLARGED
CROSS
SECTION
OF BOBBY
PIN



BEND
THIS
WAY

REMOVE CLIP FROM CAP AND BEND
TIPS TO SHAPE CRUDE TENSION WRENCH

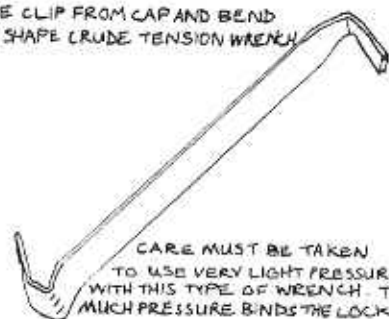

CARE MUST BE TAKEN
TO USE VERY LIGHT PRESSURE
WITH THIS TYPE OF WRENCH. TOO
MUCH PRESSURE BINDS THE LOCK.

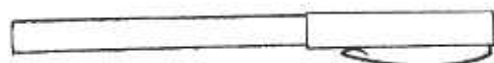

WARNING

Misuse of this information is illegal. Do not break into other people's property. It is wrong, it will make them upset, and it will make you a criminal. If you are caught, you are likely to go to jail, pay fines and restitution, and have a miserable time while making other people miserable.

Bypassing locks and picking locks are fun things to do. If you really enjoy doing it, you can make a living out of it. People will pay you to get into their cars when they've locked their keys in, or into their houses or cabinets or tool boxes when they've locked themselves out. It would be difficult for a thief to make as much money as a successful locksmith, who saves the day instead of ruining it for others. Keep in mind that the ability to be good at what you do will be dependent upon education at least as much as experience. Operating within a trade, you have access to information restricted from the general public and consistent calls to work on real problems to solve. This leads to a much more thorough and practical body of knowledge covering a broader range of applications.

If you like opening cars, you could apprentice with a locksmith, get a job as a lot attendant at a car sales lot, or be a tow truck driver. Police, firemen, paramedics, mechanics, and even some taxi drivers have tools and bypass locks when necessary. Universities usually have their own locksmiths that may use students for part-time work-study programs, and security guards at shopping malls usually perform lockout services for people who ask. Working legally does not have drawbacks. Working illegally does.

Changing a person's mind regarding ethical considerations is hard to do, but from a simply practical standpoint, misusing knowledge to the detriment of others does not gain a person as much as an ethical action. Worrying about being caught and jailed is a greater bother than following the proper legal channels to provide a service using similar techniques for the public. Being caught for a criminal act will usually make you unemployable for the legitimate use of these same skills. This will put a cap on your ability, education, and relative worth in the field.

The theft of property is also the theft of time. We are all given time at the same rate, to spend as we decide. Nobody can get time back, which makes how we spend it precious and important. A stolen stereo is only a commodity to the person who takes it, but it might mean the loss of several days spent working (possibly at a horrible job) to the person who bought it. If the person decides to replace it, that means another investment of time lost, not only for the replacement cost, but in lieu of what

that money was previously destined for – rent, food, child support, etc. This is why crime is so expensive to endure – it usually entails a loss of a significant portion of a victim's life. Murdering a few weeks of a person's life is not an admirable or acceptable act. Few people would be willing to toil for absolutely nothing if they were given the choice between that and taking the time off to educate themselves, have a vacation, or make a difference to others.

How people affect each other is a fair indicator of their worth as human beings. A theft or destruction of property that effectively cancels a week or so for a victim shows a criminal's emptiness and inconsideration.

Remember to look at what is effective. Whether you are on one side or another of an issue or a locked door, sticking merely to one side will not improve your understanding or your ability to function. Holding to a position regardless of the interests involved or other perspectives almost always has consequences outside of the narrow vision held and defended. Those consequences are eloquent testimony against a closed-minded person's right to exercise his will, and they demonstrate his irresponsibility. Regarding the multitudes of evils that willful inconsideration has produced – pollution, warfare, neglect, inefficiency and waste, destruction and failure – it makes very little sense to act with willful disregard to other positions. Acting with care toward what can happen and who will be affected, meeting possibilities and consequences responsibly and honorably, is the most intelligent way to use knowledge. Acting merely in self interest without regard to consequences is stupid, destructive, and wrong, though often profitable in a low and narrow fashion. It is intensely unlikely that selfishness justified by uninspired necessity will save the world or even let it go around much longer. Though human beings have always behaved this way, thus separating themselves from their potential, and probably always will, appeals should be made to the contrary. The attention and care you use to perform the procedures outlined in this book should make clear to you a parallel necessity to preserve the social framework we live in. It doesn't do much good to mess it up.

GUIDELINES TO SUCCESSFUL LOCK BYPASS

READ THIS ENTIRE CHAPTER. It contains information without which people fail, waste time, or break things. This information was distilled from instructing and correcting hundreds of people more eager to begin than to think. Thoughtfulness will allow you to avoid pitfalls you will invariably be mired in if armed only with techniques. This is the most important chapter in the book.

Make a habit of physically checking to see if you have your keys before going through a door or leaving a car. If you think you are holding them, look down and visually confirm it. If you think they're in your pocket, make sure by feeling them with your hand. This won't take any time if you do it on the way to the door, and it does prevent you from locking yourself out. Most people are preoccupied when they leave their keys behind. Merely thinking that you have your keys is not as reliable as actually checking to make sure.

If you do find yourself locked out, systematically go over all of the obvious factors that can get you in before attempting a bypass. Unless you make a conscious effort to go step by step and find out for sure whether an emergency even exists, you can make a fool of yourself trying to bypass a lock when it is unnecessary to do so. Go around and try every door – one may be unlocked. Retrieve a spare key if you have one, look for open windows, check all the obvious places (pocket, hand, string around neck, backpack, friend standing around, etc.) you may have left your keys. Common sense is difficult to employ when you're under stress, but it is important to keep hold of. Don't focus on subtleties without heeding the obvious.

Locks were made to be opened with a proper key or combination. Because they were not designed to be circumvented, you risk impairing their function when you fiddle with them. Aside from practice, which should be done in a controlled situation to develop the skills required for efficient bypass, do not attempt a bypass unless you have to. Calling a roommate or a spouse and waiting is the most reasonable solution to a lockout. If your car is locked and you carry towing insurance, it will cover the cost of opening your car without a deductible, though you may have to pay up front and then file a claim. Car clubs cover lockouts for their members. Many automakers have roadside assistance programs just a toll-free call away. These are great alternatives in an emergency. Do not use a bypass method to avoid embarrassment. If an apartment manager, co-

worker, or spouse has keys you can borrow, that is the most sensible way in. Needless difficulty often results in wasted time and money spent on repairs.

Your success in accomplishing a lock bypass technique is dependent upon the skill you apply to carry it out. Most of the methods shown are simple, and whether a person finds them easy, difficult, or impossible is determined by the quality of the lock and the door and by how well the technique is applied. Look at it as an engineering project that has to be completed by a contractor. There are plans, which look good on paper, that are to be used as a model to complete the job. It is hard to get a sense of what is really necessary to get the job done by merely looking at the paper. Often, there are complicating factors that must be dealt with that weren't expected, and a seasoned worker is more likely to cope with them than a daydreamer. It is important to practice these techniques if you want to be able to open a locked door in an emergency.

Oftentimes, successful bypass requires tools to be slipped in through narrow gaps, and this can be a tight fit. Frequently take measures to prevent friction or minimize it. Helper tools are useful when you need to guide, reinforce, or ease entry for the primary tool that you use. Although it adds more steps and requires more equipment, using a helper tool saves time and reduces the risk of damage. Oil or dish soap can be used to make parts of tools more slippery, and wedges may sometimes be inserted to relieve friction and widen gaps. It is OK to jam a tool between a wooden door and a sill. It may take great effort to move it up the side of the door bit by bit until it is in position, but that is OK. If nothing is in danger of breaking when you move a tool into position, do what it takes. Going through a struggle may be necessary to get it there. Once it's in place, don't force the mechanism - be gentle with it.

Never try to force a mechanical part to move. The most force you need apply to a lock is the same amount it would take to use the key or inside handle. Always keep this in mind. Car doors are particularly sensitive. If you reach inside one, it is important not to interfere with electrical wires or the window crank. If you use too much force on the linkage rods, they will break free of their plastic connectors and cease to function. Using force on delicate parts makes you your own worst enemy.

The quality of a tool has direct bearing on how much of your skill you can apply. Good tools can greatly speed up the completion of a task and prevent a lot of frustration. Be sure to craft the very best tools you can.

Of course, the tool you use had better be suitable for the job. This is especially important in this field, where the work is done within close tolerances and there is considerable chance of breaking something if you mess up. Since you are probably going to have to make your tools on the spot from what materials are available, it is important to consider all the possible entrance options and figure out which one you could most likely accomplish with your resources. You might save time and frustration by going out of your way and buying the right materials instead of making do with scrounged ones. However, if you keep your eyes open, it shouldn't be difficult to find what you need. All the tools are simple and are made from common items.

The greatest cause of failure is using the wrong method of entry. Many problems have specific solutions. Just as there are wrong answers to questions, there are wrong techniques to apply to certain locks. You might have half a dozen bypass ideas in mind, but you have to choose the right one to get the job done. An inappropriate method can ruin a lock, but it won't make it operate. Don't insist that reality conform to the boundaries of your knowledge or to a theory. A mental refusal to account for physical conditions does not invalidate or nullify their presence, but it does limit your effectiveness in coping with them. Having the wisdom to determine how much of what you know is specific to the lock in front of you and having the ability to apply that knowledge is at least as important as the knowledge itself. If you don't choose the right method, your chances of success are pretty slim. Pay attention to what is going on.

Bypass is usually indirect. Obvious, direct approaches are easily anticipated by lock makers, who take steps to prevent their success. Frustrated people tend to whack things to force them to comply with their wishes. Manufacturers know this and put enough material into their products to withstand a good measure of bludgeoning.

Skillful application of these techniques is important, because manufacturers are aware that frustrated people who cannot whack a lock open might try to jimmy it. They cleverly design certain inner mechanisms to break first in the event of extreme force. A lock is meant to keep people out. If it breaks in such a way that it *can't* be opened, it accomplishes its task. You need to work carefully to keep the parts that retract the latch in working order if you intend to reach your goal of getting in. Calling out a professional to repair or replace something you messed up is rarely less expensive than calling one out to open it.

Apply yourself. Don't expect the tool to do the work. You do the work using the tool. Take your time. If you give up too easily or lose

patience, you aren't allowing yourself a fair shot at it. Be sensitive to what you feel through your hands and respond accordingly. Do not be sloppy in the way you use your tools. A professional differs from the incompetent mostly in attitude, in the willingness to proceed carefully and with full attention.

Most of the techniques presented in this book were developed by trial and error. Maintain a critical, open-minded state. This book is by no means a final authority on the subject. It is an introduction. Use it to familiarize yourself with the methods and become competent at carrying them out. While presenting some of the most common locks and a number of ways into them, not every lock (or every possible entry method) is represented. Keep this in mind while reading, and especially when working. Whenever facing a locked door, approach it with the goal of figuring out for yourself how to open it. Consider all applicable bypass options, then choose the simplest, safest, easiest one. You may want to modify a method or combine a couple of them to suit the situation. Once you have a creative base of opening ideas, you can extrapolate effective solutions to mechanisms you are unfamiliar with. Bypass techniques require flexibility to be effective. A good deal of the process is mental and involves accurately perceiving reality. Experiment, engage in some mental playfulness, and be innovative. You will fail if all you can do is follow directions. Your greatest advantage when facing a locked door is your ability to think.

The wrong method of entry doesn't work. Everyone who has tried to push on a door that must be pulled open can understand this. Trying to bypass a lock when you're in the wrong frame of mind doesn't work, either, but it is much harder to realize when you're doing this. There is a professional approach that allows experts to accomplish what other people with the same tools and techniques can't do. This state of mind is what you need to maintain in order to learn and apply bypass techniques.

Act intelligently. This doesn't require academic brilliance, but thoroughness of thought. Figure out whether the placement of your tools is correct, whether your tools are working as intended, and what the cause of any hindrance is. If you know what is wrong, you can come up with a solution to overcome it. Don't be mentally inert. Many people have a tendency to avoid thinking because it can be difficult. Instead of thinking many people simply *feel* a certain way about a subject. If the subject is a locked door, people usually feel frustrated. That feeling guides what few thoughts they have down channels related to frustration. Instead, consider the lock a challenge and make a point to present solutions to yourself.

Once you tentatively decide upon a solution, work on implementing it by making the tool and using it. If it doesn't work, determine why.

Try to get more information each time you fail, so that you don't get stuck in a mental rut. If you get discouraged and quit working, it is easy to make a poor judgment and add reasons to support it that seem valid. The danger in reinforcing a faulty opinion is that it is too easy to defend from a possible solution – and your mind closes. If your efforts are being thwarted, question the decisions you come to and think over whether other interpretations of the information you've collected could be made. Any conclusion can stand revision.

It is important to note everything pertinent – where the gaps at the edges of a door are the greatest, whether the weather stripping is going to be a hindrance, whether unlocking a knobset will also unlock the deadbolt if they are assembled in a unit, etc. If you've made a few failed efforts, make note of where you got held up and exactly what it felt like you were hitting. Note improvements that could make the tool better fit the job. Don't throw out observations. If you miss a fact about a problem, that can prevent you from achieving the best solution.

Appropriate expectations form the basis of a proper mindset. In reality, this is not a "Golly! Gee! Wow!" kind of field. Sometimes a lock may be picked or bypassed within a few seconds, and when this is the case, it sure is convenient. However, it can easily take longer than this. When it does, accept that. Experienced locksmiths can open up a vehicle or a building within 5 minutes about 80 or 90 percent of the time. But that experience includes a thorough knowledge of the locks and linkages they work on and a bunch of practice doing that kind of thing every day. When faced with difficult doors, they aren't embarrassed about taking their time to defeat them. Once you have assembled your tools, it may take twenty minutes to get into something, maybe even an hour if the lock or door is well made and the degree of difficulty is high. That isn't something to concern yourself with. Never try to race through something. Although lock picking is often more effective when performed quickly, it shouldn't be done recklessly. Other bypass techniques should not be performed with speed because it is too likely something will be broken, and there is no advantage to working fast. Remember that your goal is to get in without damaging anything, and rushing will compromise this goal.

Few methods always work, and no method works in every situation. It may be possible to get into your vehicle every time with a bread knife, but it won't be possible for every vehicle. You may be able to pick your back door lock sometimes, but sometimes not. Nobody can pick

every lock. *Nobody* can. You need to develop a sense of when to quit trying one method and start an alternative. Most methods are for special situations. It may be that no method will work for a particular door. Usually, one will, but it might take good tools, finesse, and perseverance.

Some doors close very tightly and do not have gaps along the edges of the sill, while others hang in a sloppy fashion. Some locks are well made, and others are of poor quality. There is an ideal of the best possible lock and fitting that could exist, and then there is reality, which doesn't measure up to that ideal. The gap between how good the lock is and how good it could be is the margin that you exploit to bypass it. You need to practice enough to be able to work within the margin.

There are times when it is wise to make repeated attempts, particularly if you can see your tool and know that you are close to achieving your goal. It may take a couple of dozen tries to hook the inside handle of a door, but it is worth the effort if you eventually succeed and can get in.

Skill is a commitment. So much of this is tied up in finesse that it is impossible to work effectively without it. The way you feed a tool into a narrow gap, the degree of control required to loop an inside doorknob with a bit of tape, the determination to try another method and succeed with it after exhausting other alternatives all require the careful application of knowledge and effort. So long as you are willing to do the work, you will be able to open doors that other people find impossible to bypass.

Trying to demonstrate bypass techniques is likely to get you into trouble. If you are by yourself you only have to consider the locked door before you and can choose whatever method will work (perhaps something as simple as ringing the doorbell and waking up another member of the household to open the door). If you're alone, it doesn't matter if four different methods fail you if the fifth method succeeds. However, your intentions become compromised once you have an uneducated audience. Someone watching isn't going to know what is going on or what difficulties are involved, but the person is still going to have expectations. After a few seconds, or a couple of minutes at most, if the door doesn't magically open, the person is going to think that you are not very good or that you just don't know what you're doing. This will affect you more than you might expect. Don't try to show the person that a method really will work, or that you really can succeed with it, if you are finding out that it isn't optimum for the situation. People who are ignorant of the conditions of lock bypass will look at your efforts dismissively. That is their mistake. They are holding you to standards that are independent of reality or experience or informed judgment. Nonetheless, the urge will hit you to fight

that unfair judgment and prove to them your ability or the reliability of a method. This is one of the worst things you can do. Instead of having a locked door as your adversary, you have the approval of an unfit judge to win. Your chances of success will plummet.

If you are picking or bypassing a lock in the presence of others, mention before you start that lock picking is successful a little more than half the time, and that you can't rely on it unless you know the particular lock in front of you is easy. Tell them that other bypass methods are far more reliable and function very effectively, but only if you are able to get the tool into place. A bit of weather stripping or a flimsy tool may render the technique impossible or extraordinarily difficult to employ. In a typical situation, you are liable to encounter very small openings into which it is difficult to insert a tool, and must work by feel while compromised by friction at the entrance point, or with other clutter in the way of the target. You often operate under a poor mechanical advantage and must use pressure to move rods or latches without breaking the weak connectors designed to give way under stress. If you *can* see your target, it usually can't be seen very well. If you are not intimately familiar with the design of the lock, you may have to work a bypass by trial and error, interpreting what you can from the success or failure of your efforts. When conditions are not ideal, there are additional obstacles to overcome that will take time to deal with. If the lock may be defeated by a simple bypass, it may be performed quickly, but complicating factors will compound the time it takes to perform an opening. You should explain this to a person who becomes impatient or irritated after you first begin, and explain clearly and thoroughly. Let the person know that expectations need to have a well grounded basis in order to be valid and that in order to think or contribute usefully, the person needs to have a fluid point of view.

Most people's minds are not fluid at all. They may be quite lucid, able to say what they're thinking and express a point of view, but not too many folks can process new information in an apt or efficient fashion. The majority of people are more likely to assimilate new information *into* their bank of old information, which is only natural. Unfortunately, this often alters and degrades the new stuff. If you try to measure the content of a new idea by the limits of an established one, you will get a very warped and truncated view of it. For example, if somebody watched a program about prisms and refracted light on a black and white television, the person's view of the subject would lack color, making the program meaningless. A framework of ideas can be like a black and white television set - fine for many purposes, but inadequate for the transmission or under-

standing of others. Ideas serve the purpose of allowing you to cope with or create the environment. If people can't grow into new ones, they tend to trim them to fit in with the ones they have. Don't do this, or you will doom yourself to live in a very limited world.

If you find you cannot get a bystander to respect the conditions you are working under, the person should be avoided. Say that you work best by yourself (when nobody is watching), and that you take your time because you know the value of being careful and not breaking anything. There is no benefit involved by enduring an ignorant, belligerent heckler. If the person knows somebody who can open a door in three seconds, fine. So can you, if it is the right door, but the door in front of you is the one that is your concern. Someone else's supposed prowess is only interesting if the technique can be learned and employed. If not, it's just an annoying story.

You can get over your head in another fashion by demonstrating these methods to other people and trying to show too much. For instance, there can be as many as a dozen different ways to bypass a domestic full-size pickup truck. Usually, one works best. The rest, though likely probabilities, are more difficult and less suited to the situation. It is tempting to show other ways in, after the first one works, but you are headed toward problems. By working too fast or employing a method not particularly suitable, you can fail in your attempt or get the tool stuck. Then you look bad, or the idea does, and it isn't very convincing.

There are more ominous reasons to keep these methods to yourself. Some people are fearful and paranoid and can create enormous hassles for you by imagining the things you might do. The police might be called and told a story and wind up on your doorstep accusing you of crimes you've never even thought of. People do talk. They also embellish a tale if it isn't interesting enough to suit their tastes. If you show somebody an interesting technique, the person will get excited and tell other people about it. Some of these people may be horrified, and it won't be good if they get a nasty impression of you. It is bad to attract the wrong kind of attention.

Another thing you will immediately notice if you talk about this stuff with people is their propensity to bring up the subject of crime. Get away from anybody who does. It is illegal to plan the commission of a crime. You don't want to be put in jail on a conspiracy charge for listening to somebody's half-cooked schemes. You don't want to be "trusted" if it means that you can face penalties for actions not your own.

Do not carry finished tools around unless you are sure it is legal in your area. Lots of places make it a crime to be caught carrying "thieves' tools." This book will show you how to make tools from what you can easily find around you. This way, you can make them when you need them. The raw materials are not liable to cause an uproar - who can get upset about a plastic bottle and your shoelaces?

Remember that it is far easier to make tools by using other tools. Scissors or a pocketknife, one or two pairs of pliers, a file, and rubber cement are all you need to make excellent tools. These items can usually be borrowed from a nearby business or other people if you do not have them. You may be able to walk into a hardware store and make what you need right there, so long as no visible wear to their tools results. People are surprisingly helpful in this kind of emergency. Files you will have to buy, but a used file is fine. If you carry a file, folding scissors or knife, and a pair of locking pliers with wire cutters, you are well prepared. Multi-tools that combine these things are okay, but then you can't use the file and the pliers at the same time, which is a bummer.

Control stress correctly by depending on experience to pull you through. Learn techniques step by step. Make tools, taking time to do it well. Be sure you understand what you are reading. This can be difficult if you read quickly, or if you do not check each sentence with a real door or lock to identify for sure what is being covered. When you try something for the first time, be attentive, but try to keep yourself feeling casual inside. Be persistent but flexible. Take a break and come back if you make no progress for several minutes. See that every situation is as easy and hassle free as you can make it. Practice with doors ajar or entirely open. Find simple locks to pick. Have a friend on the other side of a door coach you and give you directions to your target. If you are competent enough to put it back together, take apart the door or the body of the lock you want to understand. It is okay to cheat when you are learning, if it helps you overcome an obstacle that is preventing you from accomplishing the rest of the task. It is best to have practice sessions entirely without pressure. When you are competent with the simplest, basic steps, you can add complications in increments. Isolate difficulties if you can and practice them specifically. For instance, try turning a knob that is difficult to twist from several feet away, experimenting and modifying to learn what works best. Find a door without weather stripping that has a wide gap to insert tools into before moving on to a better fitting door that will have more friction. Work with visual aid whenever possible. Working blind is not as efficient as being able to see what you are doing, so do not hold yourself to unrea-

sonably high proficiency standards when you can't see. Never consider lock picking or bypass to be a performance. It is a challenge, but being unable to open a door isn't a defeat. It merely means that the lock is doing its job.

Remember each success you have and feel good about it. In a real life situation, you want to make it as much like practice as you can. You do not want to make practice like real life – learning to cope with stress isn't as effective as bringing an earned level of competence onto the scene and creating a model solution. Make it as easy on yourself as you can. Look for the best ways in, make tools that help you the most, and involve as few complications as possible.

Always have your keys in your pocket when you practice. Otherwise, you are likely to lock yourself out and feel like a fool. It is important to dismiss the "must succeed" mentality from the process, because it is liable to lead you to ignore facts that *need* to be correctly interpreted for your success. Sometimes, getting past a locked door is an amazing feat, a victory over severe difficulties. It doesn't happen because a person was driven by necessity, but because the person was able to determine a viable way in and correctly implement the plan, coping with setbacks in a manner that worked. There are situations where a bypass is not possible for one reason or another. Experience, working with different materials to use as tools, and correct judgment are what you have to rely on to decide whether to quit, persist, make new tools, rethink the problem, or try a different approach. It is wise to know when not to try at all.

Not much time is required to attain competency with the methods in this book. Basic lock picking can be picked up in a few hours if you have several easy practice locks to play with. A couple of weeks picking everything you can will give you a respectable degree of practical competence. Bypass methods are going to depend on what you have that you need to get into. You have to figure out how to get into your vehicle, and what kind of linkage it has, but you don't need to get into every vehicle, so you only need to invest time in learning the relevant tools. Your home and auto may be so well made that you can't get into them at all without keys. This wouldn't be a poor reflection on your skills, but an assurance of security. It *will* mean that you must be extra careful about locking yourself out and need to make working copies of your keys to give to trusted friends, or plan another reliable contingency.

If you are uncomfortable performing a bypass yourself or if your efforts have failed, call a professional to do it for you. Make sure you can afford to pay the service fee before you call, because they usually expect

immediate payment. If you have monkeyed around with the lock, be sure to tell the person before he or she begins working and explain what you did. If you have messed anything up, time won't be wasted attempting to make an opening that relies on its function.

If you discover you're locked out and plan to perform a bypass, find a restroom first. Extra pressure can ruin your ability to concentrate and hold still. This might sound silly, but you will discover it is true.

Spare keys need to be treated specially if you want them to be handy when you need them. Sometimes there are three sets of keys in the car when people lock themselves out. If you have a spare key, put a label that says "reset" on it. When you read that word, use it as a cue to put the key back where it belongs immediately.

Grab your keys as soon as the bypass works. If it takes you an hour to open your door, you don't want to do it again. Get inside as soon as the door opens and make sure it is unlocked. If it closes before you expect it to (this is more common than you think), you will be really frustrated. Once you have your keys, check the function of the door to make sure everything is still working. Do it in a way so that you cannot lock yourself out if it *is* broken. This usually means unlocking another exterior door first or checking the lock function with the door wide open.

Personal ethics are crucial. When locks serve their purpose, dubious intentions are kept in check, because the lock will physically prevent someone's security from being violated. Once these measures become ineffective, locks cannot enforce boundaries mechanically and serve only as a symbol to be respected. When you become capable of bypassing locks, people must trust you by default. Be worthy of trust by acting responsibly with the freedom you have. Civilization is a farce unless it comes from within us. Reality gets ugly when people mistreat each other. Don't make police or jails necessary.

LOCK PICKING

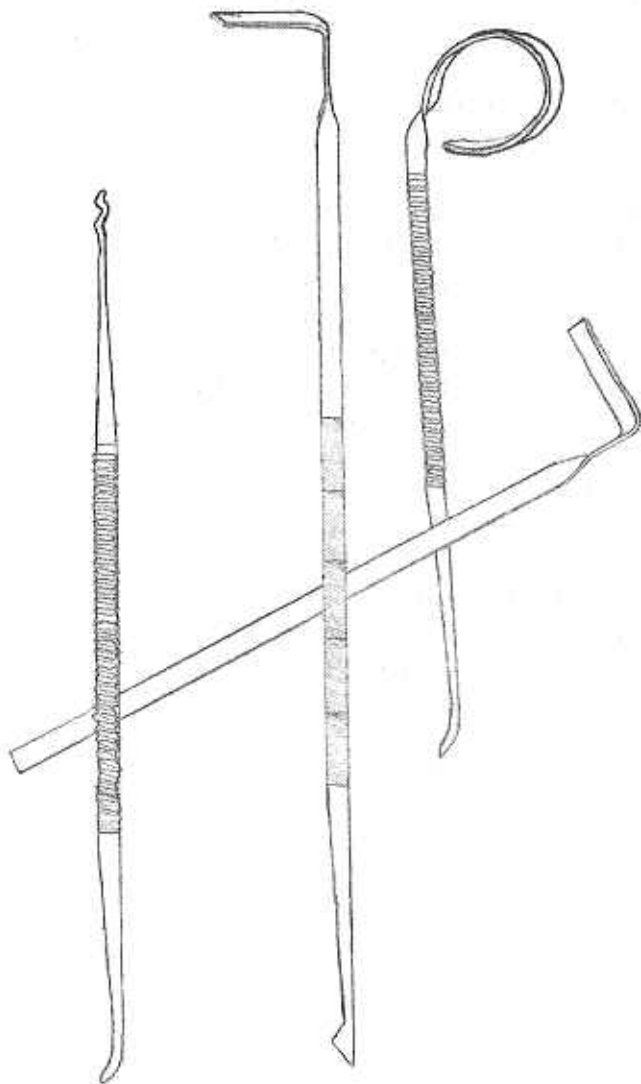
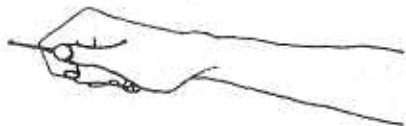

PICKING LOCKS IS SIMPLE TO EXPLAIN AND EASY TO UNDERSTAND

(A Quick Overview)

1. Look into the keyway and visually identify the top and the bottom of the lock. Sometimes locks are installed upside down. The straighter end of the keyway is the top, where the tumblers are, and by peering inside you should be able to spot the first one. Stick a tension wrench in the bottom of the keyway. Hold some pressure on it to turn the lock the direction you want it to go. Beginners use too much tension. Don't. Use the same amount of pressure on the far end of the tension wrench as it takes to hold the cuff of a long sleeved shirt taut, using one finger.
2. Work a pick into the lock all the way into the back. Make sure the working tip is facing the tumblers and that the pick is in the top part of the lock where the tumblers are.
3. Tap on the tumblers with the tip of the pick. Push them up, feel their tiny springs push them back down. Play with each tumbler this way, bonk it a little, and rake the whole group or a few at a time. Do this while keeping tension on the wrench, but vibrate it a little; push a bit harder and then ease up some. After several seconds of fiddling, pull the pick out completely, vary the torque of the tension wrench a little bit each way, and start picking again.
4. The cylinder will turn when the lock is picked. Turn it the full distance it will travel. If the lock doesn't turn, release the tension wrench to reset the lock and try again. Once picked, the lock will turn just as easily (or just as stubbornly) as if you had used the key.
5. After the lock is open and you have retrieved your keys, **reset the lock** by turning it with the tension wrench back to the vertical position. You will feel and hear the tumblers snap back into place. If you do not do this, you will not be able to stick a key into the lock because the pins will block the keyway.

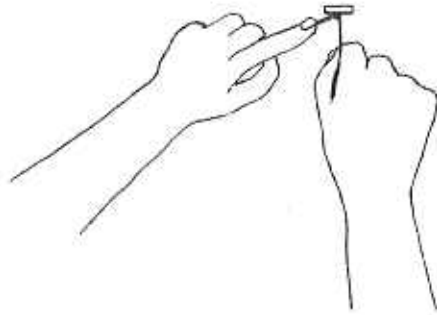

To pick a lock for the first time, you want to have the best tools available and a controlled situation. This means that it is stupid to try to pick a lock if you've never done it before, you are locked out, and you are using paperclips. Make good picks. It will take less than an hour.

Then try picking several locks, choosing easy targets like desk drawers or cheap padlocks. Get to the point where you know you can pick a particular lock if given enough time to do so. In the process of trying several locks, you will also find that there are locks that you cannot open. This will give you a more reasonable point of view when you try to pick your way into something you are actually locked out of. Even if you throw them away afterward, it is recommended that you make some picks and successfully use them so that you have skill to validate the knowledge.

The rest of this chapter explains the details. They are important, but if the writing bogs you down, go back to the front where the essentials are.

Lock picking is the first method to try when you are locked out, if tools are available or you can find easily modified materials. It is a low hassle way to open something up, if it happens to work. If you practice and find out that your backdoor lock, perhaps, is reasonably easy for you to pick, you might hide a pick and a tension wrench in your mailbox or a crack at the edge of the sidewalk. They are far less conspicuous than a key and can be hidden separately, if you wish, to prevent them from being found and misused. If you keep picks in your backpack, wallet, or favorite pen, take care that you do so in accordance to local law. You want to be able to get out of a jam with them, not into one.

Lock picking is part skill, part luck; the rest is mostly the mechanical condition of the lock. You have influence over the skill portion of this mix. **Aim for proficiency (60-70% success rate) instead of mastery.** *Nobody* can pick every lock he or she tries, and it is an immense waste of time to keep trying after fifteen minutes of frustrated effort. By-

pass the lock if it won't pick. Lock picking is great when it works. It doesn't always work. Accept this and don't fret about it.

Once you get the techniques down and can control the pick easily, lock picking is automatic. You do not need to think about what you are doing or consciously decipher the lock – your hands will do the work. Usually, you start with several 5 to 30 second attempts, resetting the tension wrench in between, and only slow down and feel the pins if these first efforts don't turn the lock.

You only need one pick and one tension wrench to pick a lock. There is never a need to stick more than one pick into a lock at a time. The most useful picks are the rake pick and the diamond pick. The diamond pick is easier to move around in the keyway, and the rake is best for manipulating individual pins and feeling what is going on. Incidentally, the amount of sensitivity needed to pick a lock is not so much as is commonly believed. So long as you have enough responsiveness and control not to snap your pick off inside a lock, you will be fine. If you can eat with a fork without chipping your teeth or stabbing yourself in the mouth, you have enough precision to pick locks. Though heightened sensitivity will improve your results and may enable you to pick locks with mushroom and spool pins, it is overrated. Some folks would lead you to believe there is a superhuman sense of touch you need to develop, and this is not true. So long as you pay attention to the sense of touch you already have, you should be fine.

HOW LOCKS WORK

A lock has two main parts: A **housing** and a **cylinder** that fits inside it and turns. There are holes that go through both the housing and the cylinder, and bits of metal are stuck through these holes. **Springs** extend the bits of metal (called **tumblers**) from the housing into the cylinder so that the cylinder can't turn. The junction between housing and cylinder is called the **shear line**, and it has to be clear in order for everything to line up and work. Sticking the right key in lines things up. Sticking the wrong key in leaves tumblers stuck in the shear line, so the cylinder can't turn.

When picking a lock, what you are attempting to do is push individual tumblers into position so that they do not cross the shear line. If you push them up too far, they will not be in their proper position, just as if you stuck the wrong key into the lock. The object in picking a lock is to move individual tumblers into place and hold them there with the tension

wrench while working to move the rest into place. Once they are all in position, the lock will turn.

There are two basic kinds of keyed locks: pin tumbler locks and wafer tumbler locks. Many other types exist, but over 90% of what's out there are the simple wafer or pin tumbler varieties. Basic lock picking skills will open a lot of doors for you, and you will gradually improve with experience. Don't spend more than about 15 minutes failing to pick a lock before moving on to a bypass. Since picking is no sure thing anyway, it's important not to invest too much effort into it or you'll waste a lot of time getting frustrated.

PIN TUMBLER LOCKS

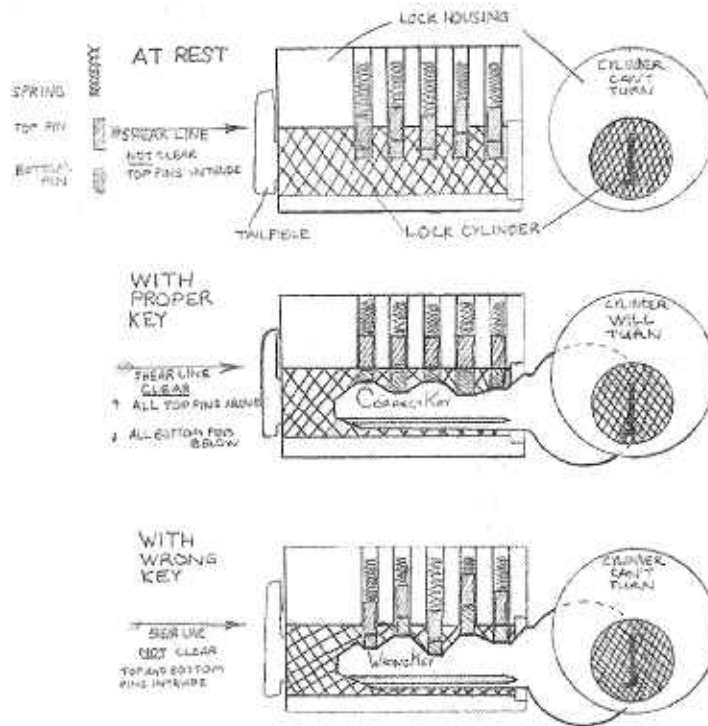

The keyway is the slot in the cylinder where you slide the key in. Pin tumbler locks have a ridge in the middle of the keyway, and the **bottom pins** rest on that ridge. The bottom pins are different lengths, and they support **top pins**, which rest on them. The top pins occupy the lock housing and the lock cylinder, so they are what block the shear line and prevent the lock from turning when there is no key in the lock. Normally, the bottom pins stay in the cylinder, but when you put a key in or work the lock with a pick, they will go partway into the lock housing, so they can block the shear line as well as the top pins can. The shear line is only clear when the top and bottom pins meet there, with the top pins in the lock housing and the bottom pins in the cylinder. This happens when you put the correct key into the lock or when you successfully pick it. The pins must be pushed up varying distances to open the lock. Pin tumbler locks are found on many padlocks and domestic vehicles and most residential and commercial buildings.

WAFER TUMBLER LOCKS

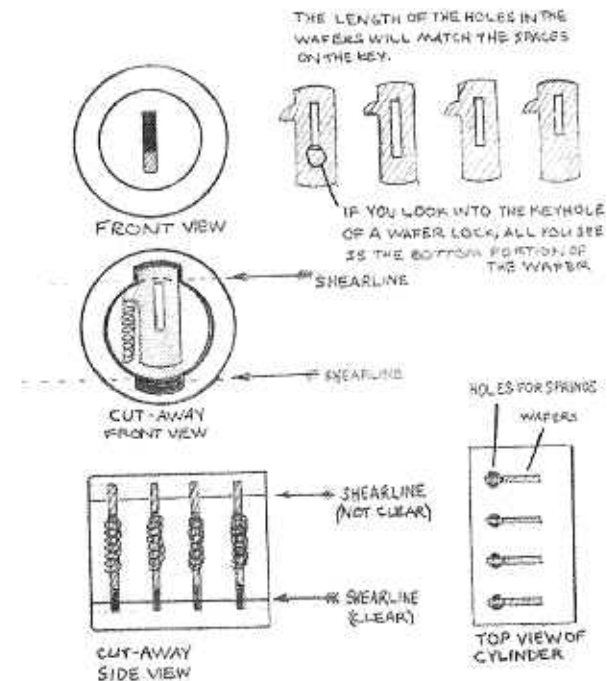

Wafer locks have flat sections of metal instead of pins. Wafers are rectangular and have a cut out in the middle for the key to fit through. The springs rest in the lock cylinder instead of the lock shell, pushing on small protrusions on the sides of the wafers. The holes in the middle of the wafers are different sizes: some of the holes are pretty short and others are longer. If you peer into the lock, you will only see the bottom portion of the wafer, and it will stick up a little if the hole is long, or quite a bit if the hole is smaller. The tops of the wafers protrude into the lock shell at the same height. The wafers need to be pulled down the same amount each to open the lock. (This does *not* mean that you want all the parts inside the keyway you can see to be level, but pushed down the same amount equally.) If pushed down too far, the bottoms of the wafers will protrude from the underside of the cylinder into the lock housing. Wafer locks are found in padlocks and many foreign and domestic automobiles. A sizable portion of wafer locks are double sided, meaning they use keys cut on both sides and have wafers on the top and the bottom. They are not appreciably more secure than single sided wafer locks, and they really aren't any more difficult to pick. It means that you will have to flip the pick over and work the other side after fiddling with the first side for a bit. Generally speaking, it is easier to pick wafer locks than it is to pick pin locks, although locks with pick resistant features make either type a target for bypass instead of lock picking.

THE TENSION WRENCH

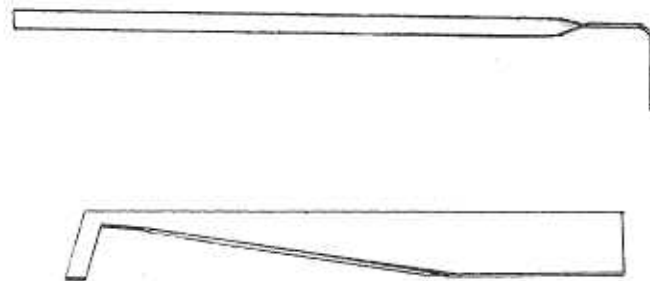

The tension wrench is as important as the pick and requires as much finesse. Its purpose is to hold picked tumblers in place until all the others are picked, then to turn the lock. You cannot pick a tumbler lock

without a tension wrench. Fortunately, they are easy to make and easy to use.

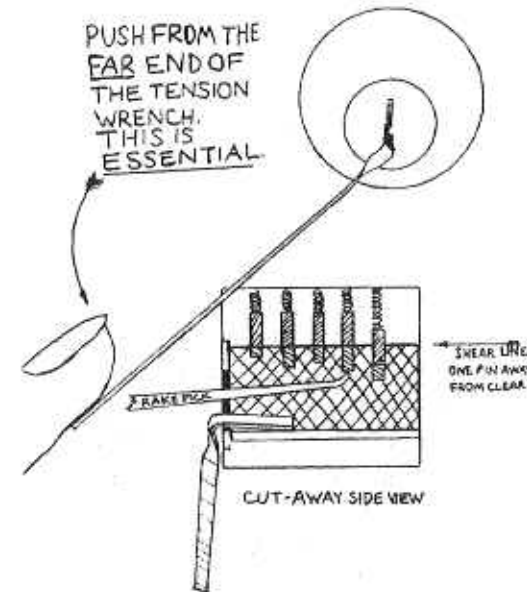

The action of the tension wrench is like twisting the key. Usually the bent end of the tension wrench is placed in the keyway opposite the tumblers. A simple tension wrench looks like the capital letter L. The foot of the L is put into the lock. The leg of the L is pushed clockwise or counter-clockwise – whichever direction you want the lock to turn. **Push on the wrench as far away from the lock as the length of the wrench will allow.** With increased leverage

you get better sensitivity for movements inside the lock. It is also easier to push lightly on the end of the wrench than at the base. If the handle bends too much, you know to use less pressure.

You have to hold pressure on the wrench to create pressure at the shear line. If you don't put pressure on the lock, the springs on the tumblers won't meet any resistance. That means they will fall back into the resting position whenever the pick isn't holding them up. Picks don't hold up all the tumblers at once. (The proper key does, giving the bottom tumblers a platform to rest on so their tops are even with the shear line.) Picks are used to push individual tumblers up and down, sometimes a pair, or to rake the group of them. The tumblers are going to be sometimes too high, sometimes too low, and sometimes just right. Correct use of the tension wrench will help the tumblers stay in position when they are clear of the shear line.

The wrench is used to create sideways binding pressure. If there were a hole in the ground and you placed a post in it that fit there snugly,

then pushed on the post from the side, that would be another example of sideways binding pressure. It would be harder for someone else to raise or lower the post while you were pushing on it.

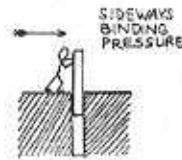

This is the same kind of torque that a tension wrench puts on the tumblers at the shear line. The harder you push the wrench, the more binding force exists. Too much will not allow the pins to move at all. You don't want that. If you use just enough, there will be friction on the tumblers that impedes the force of the spring. Remember that it also impedes your own ability to manipulate the tumblers with a pick, making them harder to push.

When a tumbler is clear of the shear line, it is free of the binding pressure (like a post being in the hole so far you can't push sideways on it). This is likely to cause the cylinder to turn just a fraction, and the force the tumbler was relieved from is shifted to the unpicked tumblers, the ones that still intrude into the shear line. The tumbler isn't likely to move back into the shear line since it is in a position that is free of binding sideways pressure. Things don't like to move from low-pressure states into high pressure ones. Although the tumbler's spring will exert force to move it back, it is a tiny spring without much push. Tension from your wrench is usually sufficient to prevent picked tumblers from crossing the shear line.

Once one tumbler is picked, holding tension on the wrench will keep the tumbler there while you work to pick others. It is often quite surprising when the lock turns – suddenly there is no pressure and the lock is no longer vertical. This is a good feeling: a little sense of elation. The tricky part is over. However, the work is not. The door is not open yet. The lock is just picked. This is like sticking the real key in and turning it only a little way. You need to turn it all the way as far as it will go in the direction you were working. If it is a padlock or most knobsets, this might only mean a quarter turn or so. If it is a deadbolt, you will have to turn it quite a bit, and this might mean taking the tension wrench out and sticking it back in from a different place, just like a regular wrench on a nut, if a

part gets in the way. Often, the doorjamb will get in the way of your tension wrench. A curled tension wrench can often solve this problem.

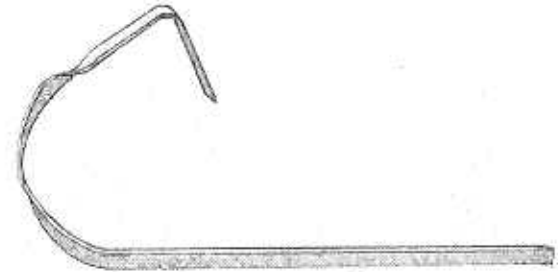

Obviously, how much pressure you use is critical. It varies according to what kind of lock you are working on, how much spring pressure you have, how many tumblers are picked, what kind of picking method you are using, etc. This really is not all that difficult. It is a little like driving a car with a clutch. Conditions vary in different cars, on hills, and in cold weather, but it is still pretty easy once you get the hang of it. Learning how can be bothersome, but certainly not impossible.

If you use too much pressure, you will not be able to move the tumblers, for they will get frozen in place. For instance, if you rake them all a few times, and peer into the keyway and see them all stuck up in the lock shell nearly out of sight, you are using too much pressure. Overkill will make the pins trapped wherever they were caught – up in the shell too far, or down in the cylinder too low. One or two picked tumblers won't help you if the others have been pushed too far and won't come down to be manipulated. You'll have to ease up on the tension.

Or if the tumblers won't go up at all, you are also using too much tension. Take the tension wrench out and play with the tumblers with the pick to find out how much spring pressure there is. Then place the tension wrench and very gradually increase force while playing with the tumblers so you have a better idea of the range of tension to use.

Sometimes you will be able to feel a tumbler fall into place through the wrench. When you let off pressure completely, if there were picked tumblers or ones pushed up too far, you will be able to feel them snap back to their resting position. One finger is all you should use to apply tension – just a fingertip, on the far end of the wrench from the lock, or your thumb. Remember that it is important to concentrate on feeling through the wrench and not using too much pressure. You can try

to vary the tension on the wrench while you are picking. Use moderate pressure, then ease up a hair, then a little more, back and forth. This allows pins caught in the bind of the shear line to be pushed by your pick and the springs, and are more likely to line up where they should.

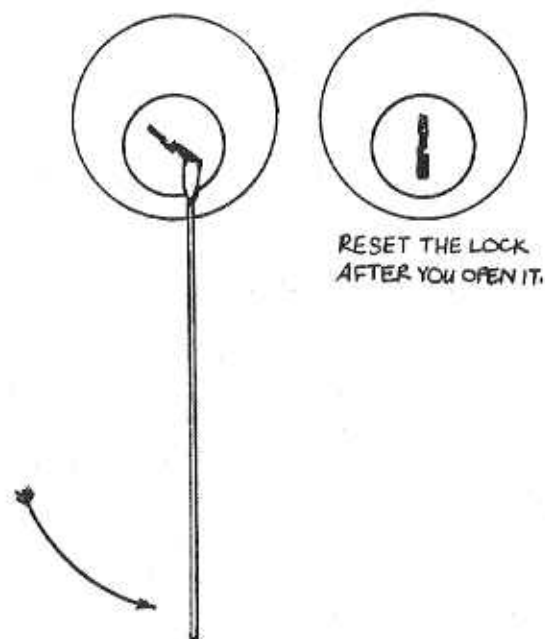

Obviously, there isn't much room to move around in a keyhole. Once the tension wrench is placed, there is even less. You want as much room to work on the pins as possible, so position your wrench to maximize the pick's working space. You want to easily be able to fool with the tumblers. The pick enters the keyway in the blade section where the tumblers are, the side where the serrations of the key go. The bottom of the keyway, where the back edge of the blade goes, is where you put the wrench.

Sometimes this is not the best spot for the wrench. If you have a tiny padlock with a small cylinder, you may have to put the tension wrench on the same side as the pick and reach over it to work the tumblers. If so, don't stick the tension wrench in very far.

Some people prefer to put their tension wrench in the middle of the lock, to center the axis of tension and improve their chances of suc-

cess. This can be very helpful, provided you can work your pick around the wrench without cramping the entrance too much.

When picking double sided locks, you will also have to reach around the tension wrench. Whether you put the tension wrench at one end or the middle of the keyway is largely a matter of preference, depending whether you value even torque or the maneuverability of your lock pick more. It is usually more practical to have as much freedom to move your pick as possible.

If you feel and hear a tumbler or two snap out of the picked position and into the resting one while playing with the tension, don't get too upset about it. Often, the best way to proceed picking a lock is to try a method for ten or fifteen seconds, take all the pressure off the tension wrench to reset the lock, then try another method for a short span of time, then another. If it doesn't yield to these first feints, then spend a longer amount of time working with it, feeling the lock out, experimenting. Remember to keep *some* pressure on the lock when you're picking it, or you'll have to start over. If a tumbler falls out of place when there is only very little pressure, it is usually easy to pick again. The first tumblers that get picked in a lock are usually the easiest. You have to get them all picked for the lock to turn. Five picked and one frozen isn't a success. Because of this, it is difficult to say whether a lock is "almost" picked or if you're "close" to opening it. So long as one pin is holding you back, the lock is doing its job just as well as if you didn't know how to pick locks.

Some devices make locks harder to pick. Night latches (sometimes found on house doors) that automatically lock when you swing the door shut can be difficult, since the large reset spring holding the lock in a vertical position will fight your efforts to turn the lock. Many lever handled doors are the same way and this may foil your picking efforts. Bypass them if picking fails.

Be alert to complicating factors. If your house door is difficult to lock or unlock with the key, it will be difficult to pick as well. This may be because the lock isn't set correctly in line with the door, or maybe because the door must be pulled or pushed for the latch or bolt to line up with the strike in the doorsill. If the latter is the case, relieving the pressure on the bolt will facilitate turning the lock once it has been picked.

There are some specific difficulties related to tension. Most padlocks have a spring which returns the cylinder to the vertical position. This means that if you have the key in the padlock and turn it to open it, the shackle pops open and the key returns back to the resting position. When you pick these locks, you have to work against that spring force,

which is like a tension wrench in the other direction. Usually you do not encounter opposing pressure until you are past the shear line. It is important to turn the cylinder until the shackle pops before letting go. If you do not have room to turn the tension wrench far enough, get another tension wrench and insert it at an angle that will give you room to turn it while holding on to the first one. You can use the hand that held the lock pick

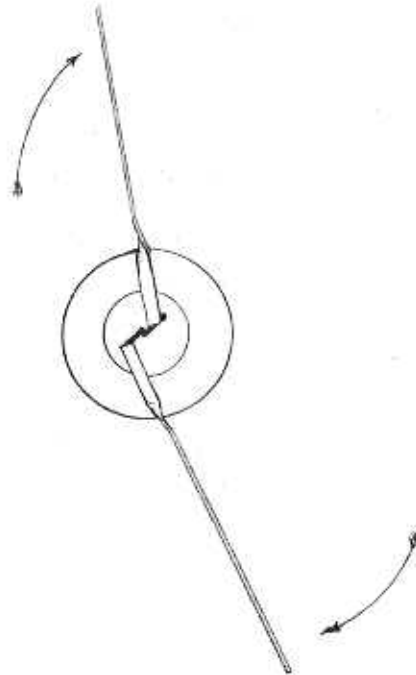

since the pick isn't needed any more. Having a tension wrench on the other end of your lock pick is convenient for this.

With automobiles, the problem is compounded. In addition to having a spring to return the door locks to the vertical position, auto locks require that a turn of the key move the tailpiece, linkage rod, and the indicator button, too. Oftentimes, a regular tension wrench is fine to pick the lock past the shear line, but you need a stiffer tool to turn the lock, something without flex to it. Once the lock is picked, anything you can fit into the keyway a little bit to turn it will work – the head of a nail, the tip of another key, some other stiff bit of metal. A second tension

wrench will often suffice. You may want to make a special automotive tension wrench out of a filed-down hex wrench or *carefully* use a screwdriver. Make sure the lock is picked before you try to turn the lock with a stiff tool, to prevent damaging the shutters.

Automobiles' outside locks have shutters on them to keep out the dust and rain. By first inserting the tension wrench, you can hold the shutter open to leave your pick free to work on the tumblers.

LOCK PICKS

It is important to learn using the best pick you can buy or make. Paperclips and other emergency picks often can be made to work in a jam, but if they bend or deform easily it is difficult to feel what is going on, push down the tumblers, or even enter the lock all the way. If you already know what you're doing, you will know what to expect to feel, be able to accommodate for the inferior materials, and succeed. But if you don't know yet, things will be too mushy and hampered for you to develop the knack of it.

With a bit of flat spring steel and a file, you can easily make a pick as good or better than a manufactured one. See the TOOL MAKING chapter. You really don't need many picks. Although they come in a great variety of shapes, locksmiths generally only use two or three of these, and the rest just sit in the pick set. A rake pick, a diamond pick, a tension wrench, a curled tension wrench, a heavy duty tension wrench for automobile door locks, and a raffle pick compose a complete pick set. If you want more picks, you can make duplicates of the types you have. So long as you can find good steel, you may as well make your picks. The only thing you'll miss about the manufactured variety is the little zippered carrying case.

Picking techniques for pin and wafer tumbler locks are the same, since in both cases you are trying to push tumblers out of the way of the shear line. Techniques vary from lock to lock, not from type to type. Getting a feel for particular locks is inevitable when practicing with the same locks over and over. Cheap, sloppy locks won't require much effort or precision – good locks will, whether pin or wafer, whether on house doors, your car, or on cupboards.

To learn how to use the pick, put it all the way into the back of the lock. Push and hold the tip up against the top of the cylinder, and slowly pull it out so you feel it run across the pins. Practice moving the pick in and out of the lock. Be careful. When you're comfortable with it, place a tension wrench in the bottom of the cylinder and continue to practice getting the pick into the keyway far enough to play with the rear tumbler.

Next, try counting the number of tumblers in the lock with the pick. Look at the key to make sure you are counting the right number. The seats for the pins are low spots on the key's toothed edge, not the points. The points are just spaces between the pins.

Push on the individual pins with the pick. Learn how to push one up just a fraction, then halfway, then all the way up. Feel the spring pressure working against you as you do this. Get to where you can find a particular wafer or pin and push it up any increment of its range of motion you want it to go.

Now try playing hopscotch on the tumblers. Jump from one to another to another, in sequential or varied order. Get reasonably comfortable at doing this, then combine it with pushing to varied degrees on the tumblers.

Now try raking (or scrubbing) the tumblers. To do this, work your way to the back, then drag the pick out so that it bumps across all the tumblers. If it is a double sided lock, rake all the top tumblers, then turn the pick over and rake those on the bottom. This is a wonderful method of opening locks up quickly, but beginners invariably botch the job. Don't use too much pressure against the pins when you do this. You are not trying to saw through them or punish them. Push hard enough so that the pins go down. If some are already picked, you don't want to overcome their resistance and push them further, or they will become unpicked. Work on developing the right pressure and technique for raking.

Think of how a seesaw works. It is a first degree lever. That is how you want to work your pick. The forward part of your hand, where your thumb and finger hold the pick, is where you want the pivot to be.

When you rake, as well as letting the pick seesaw, you want to move the pivot in little, shallow curves at the same time. Don't force anything. Let it work easily.

Once you have the techniques down, you want to let your hands feel what is going on and do the work for you. Too much mental concentration on this task often spoils your chances for success.

Be sure never to bend the pick side to side, and check to see you aren't deforming the tip. If you use it too hard, it can break. People who merely wiggle their hands a little instead of purposefully striking pins usually just push on the edge of the keyhole with the arm of the pick. This is not usually of much use, though occasionally a lock will yield through pure chance. Remember to look at your pick periodically. Metal fatigue (being bent back and forth, weakening the steel and causing a break) is a real danger if the pick must be bent back into shape often. If it looks iffy, replace it.

Working fast is a good idea. It opens locks faster by increasing the odds that tumblers will line up at the shear line. If a tumbler is being pushed up while others are falling down, there is a greater chance they'll

all line up and the lock will turn over. Working painstakingly slowly is often a painstaking way not to succeed. Get comfortable enough working on particular pins or wafers so that you can bounce around among them. Increasing your odds by working quickly is usually more effective than slowly working over each pin.

It's best to learn how on easy locks. You really don't learn much when you don't succeed, so start with the simple kind, like those found on desk drawers or cupboards, or with cheap padlocks. The locks on your front door may be easy or difficult – you'll find out. You might even decide to change them if they're too easy. Your car door or trunk might present a challenge. Don't try to pick a lock if you would feel uncomfortable if someone saw you doing it. If it would make somebody upset, stay away from it. Otherwise, there may be awful consequences.

Don't spend more than 15 minutes at a time trying to pick a lock. You'll be wasting time. Find another method or take a break and come back fresh. Remember that some locks just don't pick, and that you will have to realize this and decide to stop before it drives you nuts. Pick-resistant and pick-proof locks are becoming more common, and it is more efficient to spend time bypassing a lock than it is to try picking one designed to foil your efforts. Split wafers make locks more difficult to pick, as do serrations along the edges of wafers.

Pin tumblers may have pins that are not shaped like cylinders, but like mushrooms or dumbbells. These kinds of devices can be overcome, but it requires finesse which experience, not a book, must impart.

When picking wafer locks, it isn't necessary to push the tall wafers any further down than you push the short wafers, since they protrude into the lock shell the same amount. This can be deceiving unless you understand that the parts of the wafers you see are of differing heights. The pins need to stay the same height relative to each other, but the whole group must be pushed down a little.

Pin tumbler locks are different. Look at your keys when practicing with pin tumbler locks. The depth of the cuts shows you how far to push the pins. If there is a shallow cut, you have to push the pin up a lot. If it is a deep cut, you only have to push that pin up a little bit.

Sometimes a lock you normally can pick in a few seconds takes several minutes to pick, or won't open. Don't worry about it. This just happens sometimes.

If you pick deadbolts, you may get the lock stuck upside down once in a while. What is happening is that the first pin will fall down a little way into the wrong end of the keyway when you are turning the cyl-

inder. Once you realize what is going on, it isn't too hard to correct by pushing the pin up with a pick and turning the lock past that point with the tension wrench.

If you don't pay attention, you can easily pick a lock the wrong way. A lock may be picked clockwise or counterclockwise. The position it is in when you begin is usually neutral, one that allows a key to enter to turn the lock to the locked or the unlocked position. *Beginners get frustrated when picking locks because they pick the lock toward the locked position.* It won't unlock the door. It is exactly like sticking the key in and turning it the wrong way. Start paying attention to which way you have to turn particular locks to open them with your keys. Your house and car doors should be automatic – you unlock them often enough to make the movement a habit. That is the direction you have to apply pressure toward with the tension wrench. Many padlocks will unlock when picked in either direction, but most locks are particular. You will save much time and effort if you are observant and conscientious.

BUMP KEYS

A well made bump key is about as close as you can come to a skeleton key that opens any lock.

Keyways are shaped differently. One reason for this is to prevent someone from sticking any old key into the lock to see whether it works. However, it is possible to make a key that, when used correctly, will open those locks it was designed to fit into, even if it doesn't line the tumblers up. This is called a bump key, and one properly made can be used to open pin tumbler locks.

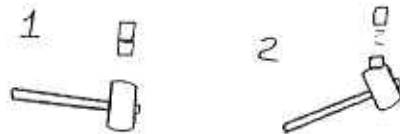
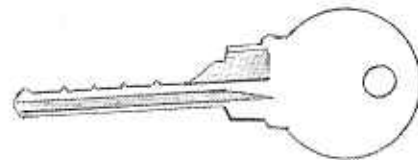

Balance a coin on the top of your hand. Now whack the underside of your hand hard with the other hand. The coin should go flying into the air. That is how a bump key works. The coin represents the top pin, the hand it is resting on is the bottom pin, and the hand that whacks is the bump key. You try to hit the bottom pin hard enough with the bump key to make the top pin bounce clear of it for a split second. If it bounces high enough to pass the shear line, and you

turn the key before the spring pushes the top pin back down, you've unlocked the door.

Proper timing is essential. Of course, the bottom pin might bounce up too and cross the shear line, or not all of the pin columns may bounce high enough. Knocking the key in and twisting it have to happen at almost the same instant. But when it works, it is amazing and fast.

To do it you need a key whose cuts are lower than the cuts on a regular key. Each space should be cut to the greatest depth.

A bump key should look thin and flat with little bumps between the cuts. The bumps are what do the work. If you have two keys of the same kind but the cuts on one are deeper than the corresponding cuts on the other, it may work as a bump key.

There are a few methods of using bump keys:

- Place the key almost all the way in – three spaces for a four pin, four spaces for a five, etc. Then sharply tap the key all the way into the lock and turn it at pretty much the same instant. Use a mallet, the spine of a paperback book, a stick, perhaps a rock, whatever you can swing to make the key travel very rapidly into place.
- Put the tip of the key into the lock and suddenly shoot it all the way in and turn it in one fluid motion. Like using the regular key, only much, much faster.
- Put the key all the way into the lock. Put a strong rubber band through the key ring hole and wrap it around the head of the key and the doorknob, to act as a kind of tension wrench. Then find something (ideally a small mallet, but you can substitute whatever else will fit the bill) to lightly and rapidly tap tap tap tap on the back of the key.

Be very careful not to get too excited and break the key off in the lock. When you use a bump key, don't turn it until it is all the way in, and don't crank it too hard.

Bump keys, on certain locks, are very reliable, but you're not guaranteed success. How well the bump key is made and how well lubricated and smoothly functioning the lock is are factors that determine this. The best way to make one is to have someone with a duplicating machine cut several keys in succession onto one blank, so that the lowest cuts on each of them are transferred onto the new key. If your choice of original keys is good, you will end up with a key whose cuts are all deep. Although bump keys can be made with a file, it is difficult to get the spacing and depth of the cuts right.

THE PICK GUN

A useful tool for keyless entry is a lock pick gun. It can be used to open most pin tumbler locks, even those whose arrangement of pins render the lock impervious to regular picking techniques. With some finesse in the application of the tension wrench, many locks with pick resistant pins will yield to a pick gun attempt.

A pick gun is simple to make without tools from a coat hanger, a bobby pin, and masking tape. A tension wrench is still needed, and practice is just as important as with lock picks. It is no substitute for learning picking skills, as there are times when space confinements, keyways, or other factors may render a pick gun unsuitable. It is not a sure-fire, foolproof solution, but properly used it is very, very handy with pin tumbler locks.

Bump keys and pick guns work on the same principle: whacking the bottom pins of the lock to send the top pins bouncing into the lock housing, leaving a gap at the shear line. Pick guns work better because the strike is more direct, tension can be more carefully applied, and many strikes can be made within a short period of time.

Insert a tension wrench to turn the lock the direction you want it to go and hold some *light* tension on it. Hold the pick gun as you would a knife or a screwdriver, with your thumb on the top of the striker. Put the pick into the

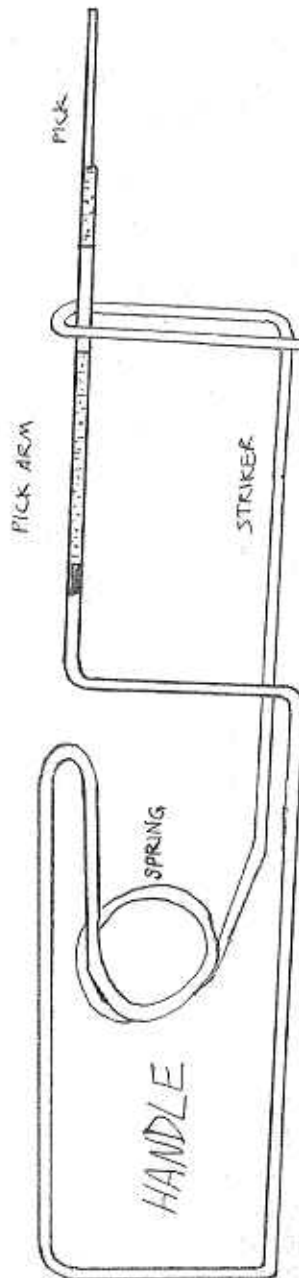

lock and check to make sure the pick has a clear path of travel to hit the pins. Care must be taken so the pick is not inserted too far. If it runs into the back of the lock, it will get caught and will not be able to snap the pins. Correct placement requires the pick to be even under all the pins, as low in the keyway as is feasible, and held so that the pick can snap up and hit the pins solidly. You do not want the pick to rest against the pins, but have a bit of space to snap up before hitting them. If you think of the lock-face as the face of a clock, with the keyhole in the 12 o' clock position, you might end up putting the pick gun in at the 11 o' clock position or the 1 o' clock position to allow the maximum amount of snap, adjusting for the squiggly shape of the keyhole.

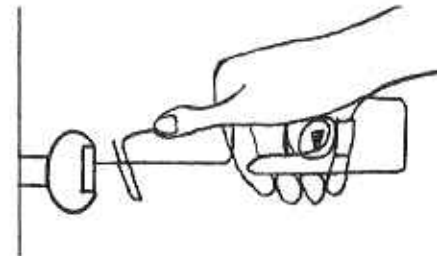

pick gun 6 to 12 times. If the lock hasn't turned, release the tension and carefully check to see what the pick gun is doing. Sometimes it has pushed top and bottom pins too far up, or it may be encumbered by the ridges of the keyway and is not striking the pins properly. See that the pins are reset and try again. You may want to adjust tension with the wrench, or adjust the striking force by releasing the striker from various pitches of its range of travel.



STRIKER SWINGS WHEN RELEASED TO HAMMER THE PICK ARM, WHICH MOVES SLIGHTLY, BUT VERY SHARPLY, AGAINST THE PINS.

Push the striker down an inch or so. Let your thumb slip off so it whips back up, sharply hitting the pick arm. The pick will whack the pins. Since it is unlikely the pick will turn the lock over on the first snap, you are probably going to snap the

The easiest way to get results using the pick gun, unlike using regular picks, is to pay as much attention to what you are doing as possible. Squat down so that you are eye level with the lock, carefully hold the pick gun exactly in place while cocking and releasing the striking arm, and carefully apply the proper tension and striking force. Using the right amount of tension while striking the pins with enough (but not too much) force requires experimentation and practice.

THE PLUG SPINNER

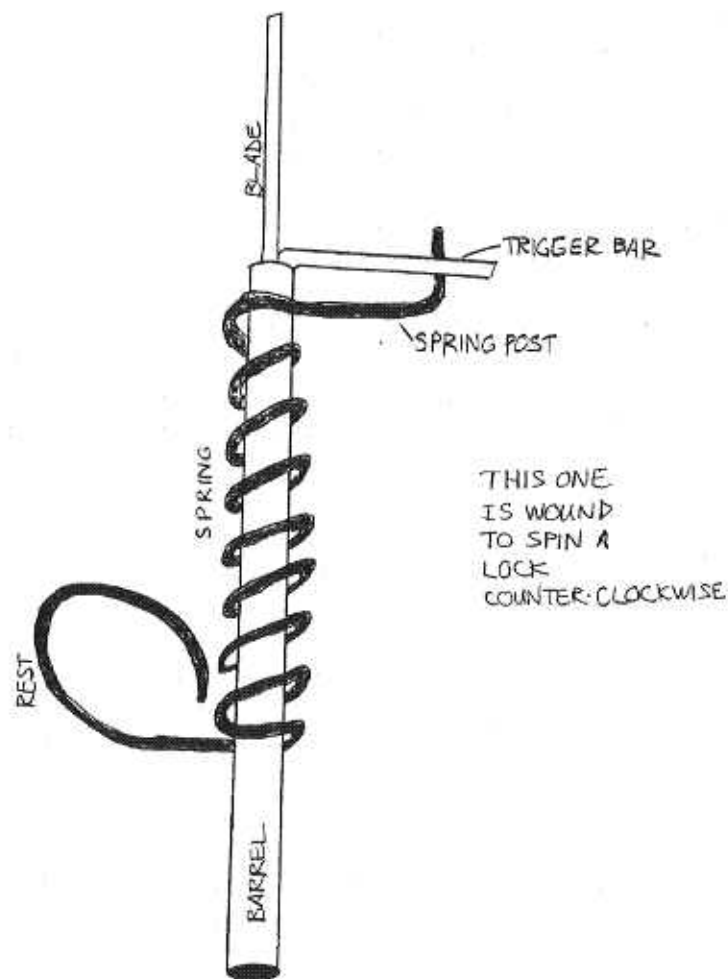

This tool is used to flip a lock that has already been picked from the locked to the unlocked position. Remember, under normal conditions when there is not a key in the lock, it is in the neutral position: vertical. When you pick a lock, you pick it clockwise or counterclockwise. With the exception of some padlocks, turning the lock one direction locks it and the other direction unlocks it. If you have a key, it is not a big deal to turn the lock the wrong way trying to unlock it, since you can just turn it the other way. But a picked lock will come unpicked when it hits the vertical

position, as the pins fall back into place. Then the lock must be picked again. This can be a real hassle, especially since many locks are much easier to pick to the locked position than to the unlocked position. There are times when a knobset may be taken apart from the outside once the cylinder is turned to the locked position, but this can only be done with certain knobsets, and no deadbolts. In addition, taking a doorknob apart may not be convenient in the dark or the rain, and might be disastrous for someone whose mechanical skills aren't particularly acute. An elegant solution to such a dilemma is to spin the cylinder (also called the *plug*) so fast that the pins don't have time to fall into place, allowing the cylinder to cross the vertical position and continue past to the unlocked position. Trying to do this with a flick of the wrist is futile, but a tool can be made with very little difficulty to accomplish the task. All that is needed is a coat hanger, a cheap ballpoint pen, and a street sweeper bristle or suitable substitutes.

The wire must be wound the opposite direction the lock needs to be turned, so careful attention must be paid when crafting the tool.

To use the tool, the lock must already be picked to the left or the right. Nothing will happen if the lock is in the up-and-down position. As an example, we'll use a lock that locks when turned clockwise and unlocks when turned counterclockwise. Say that after a long and frustrating attempt, you have managed to pick the lock, but the door won't open because you picked the lock the wrong way, clockwise. Since the lock is already picked, you decide to use a plug spinner to turn the lock counterclockwise (to the left) to unlock the door.

The cylinder is going to need some momentum, so it is best to start with the keyhole in the 2:00 or 2:30 position. Position the tool carefully just in front of the keyhole and cock the plug spinner before inserting the trigger and releasing it. Hold the blade of the plug spinner at the 10:00 or 10:30 position, with the spring arm *below* the plug spinner's trigger. Hold the plug spinner firmly by the spring coils in one hand, gripped mainly by the thumb and forefinger. The brace at the back of the tool should be resting against the base of your little finger. Cock the tool by turning the trigger clockwise against the spring tension, until the blade can be slipped into the keyway. Because the keyhole is wider than the blade of the plug spinner, the blade can fit diagonally into the keyway, usually at the 1:00 or 1:30 position. Insert the blade into the middle of the cylinder (usually toward the top of the keyway) and let your thumb slip off the trigger, releasing the spring tension and spinning the cylinder.

Do not let your fingers touch the pen barrel, and be careful not to let the brace wire bend and come into contact with it, either. It is important that the pen barrel is not obstructed in any way, because it needs to spin freely if snap is to be imparted to the cylinder. Keep this in mind.

Since it is so easy and takes so little time to construct the tool, you should make one and give it a few practice runs so you can use it correctly. Proficiency can be achieved within a matter of minutes.

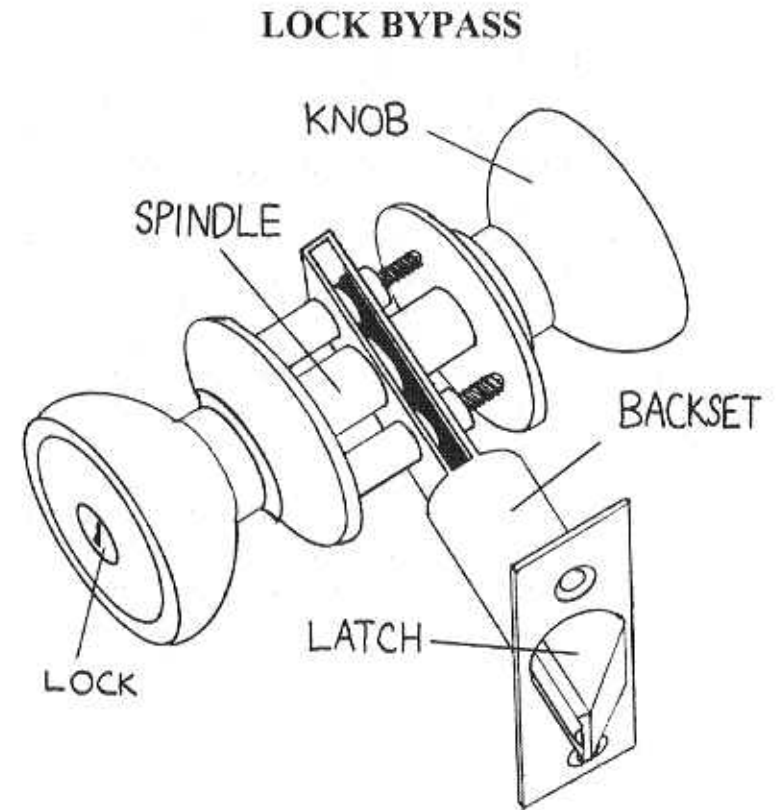

If a lock is stubborn and doesn't yield to your picking efforts, disregard it and bypass the lock. Your primary target is not the lock. It is the latch.

You can have a knobset (the name for the entire unit: inside and outside knobs, backset, the whole thing) without a lock – perhaps on bedroom or closet doors. The latch keeps the door closed when you shut it.

Without a latch, nothing holds the door shut. The lock would be meaningless unless it was guarding a latch. Your goal in opening a knobset is to retract the latch. Whether you do so by turning the knob, turning the key, picking the lock, pushing the latch, or opening the door from the inside, you want the latch to retract so you can open the door. While you might involve the lock in doing so, you may choose to bypass it instead. The lock only represents one path to the latch. Other paths exist.

Doors aren't smart. They don't know if they are open or shut. The latches on doorknobs are made to retract as the door is closed, then pop into the hole (called the strike) in the doorframe to hold the door shut.

If the door is locked, that means the outside knob won't retract the latch. However, when the door is open, but locked, you can still close it. That means the latch can be moved independently of the lock.

Credit carding a lock is the simplest bypass for a knobset. It involves pushing the latch out of the strike, applying the same type of pressure that the strikeplate does when you push the door shut. The strikeplate is the metal plate screwed onto the doorframe over the hole for the latch.

Like any other bypass method, credit carding only works under certain conditions and can be difficult even when these conditions are met. However, you can often get this technique to work, either with a few seconds of effort or a couple minutes of determination.

Whether it can be done at all depends on the orientation of the latch. Whether it can be done easily depends on the gap between the door and the frame, whether the door swings outward or inward, the tools you use, whether pressure must be applied to the door, the strength of the latch's spring, and whether the strike is sloppy.

The latch on most knobsets has two pieces – a big one and a little one. The big one is meant to go into the strike. The small one is meant to be squashed up against the strikeplate, retracted into the door. In this position, it locks up the big latch so that it can't be pushed back. Try it – open a door, push in the small, half round latch, then try to push the big one back. It won't go. The little one is the deadlatch.

However, if they're both sticking out, you can push them both back just by pushing the big one.

When knobsets are installed, the strikeplate is supposed to be adjusted very carefully so that only the large latch can pop into the hole. If the small one is retracted (hitting the strikeplate) you cannot credit card the door.

If both latches fall into the strike, you can credit card the door. Or, if there is no deadlatch (some older or interior knobs are like this), it is also vulnerable.

If the door opens inward (as the bulk of exterior doors do), there is a piece of the doorframe in front of the gap at the edge of the door. This piece is what the door closes against – without it, the door would keep going and rip out the hinges.

You can't see the latch with the piece (often called the tack strip) there, but you know where it is. You can't reach it easily because you

have to go around the 90 degree corner from the edge of the door to do it. A piece of plastic, however, can bend around the edge of the door and be used to push against the beveled edge of the latch.

Try it first on an unlocked door inside your home – perhaps your bathroom door, from the inside. Make sure the hinges are on the other side and the bevel (the slanted face of the latch) is facing you. Close the door. Work the card into the gap and around the corner of the door where the gap is the widest, then slide it to the side of the knob. Once in place, push the card against the latch until it retracts into the door. You may or may not have to push the door open with the other hand once the latch is out of the strike.

You should find an easy door and successfully open it, just so that you've done it. Don't worry about your front door, just the easiest one you can find. That way you know how. Here are some complications:

- **WEATHER STRIPPING** Sometimes you can push right through it or worm around it. Or, it may defeat the efforts of the most persistent person, depending on its condition.
- **CRAFTSMANSHIP** Tight fitting joints may not allow you much room to play.
- **UNEVEN SURFACES** Catch and stop the card. Burrs, screws, splinters, and bent or poorly installed hardware.
- **FRICTION** Often overlooked. Is the door hard to close? Sometimes, by pulling hard on the door, you can pop the deadlatch into the strike, making it possible to credit card. Unfortunately, this lets friction develop between the strikeplate and the side of the latch. This friction can be too much for a little piece of plastic to overcome. Relieve the pressure by pulling on the knob while doing the procedure. You may have to pull hard.
- **CRUMPLED CARD** Using a card this way will chew it up at the edges. Some people prefer laminated cards. You can mess up by getting a corner of the card stuck in the hole or jamming the card against the protruding head of a screw. Watch out for these things.

What if you can see the hinges and the door opens outward? Well, that's good news. It is easier to tell whether the deadlatch is retracted or in the hole with the big latch because it is visible. The tack strip is on the other side of the door and won't block your vision or your access. The door swings out toward you.

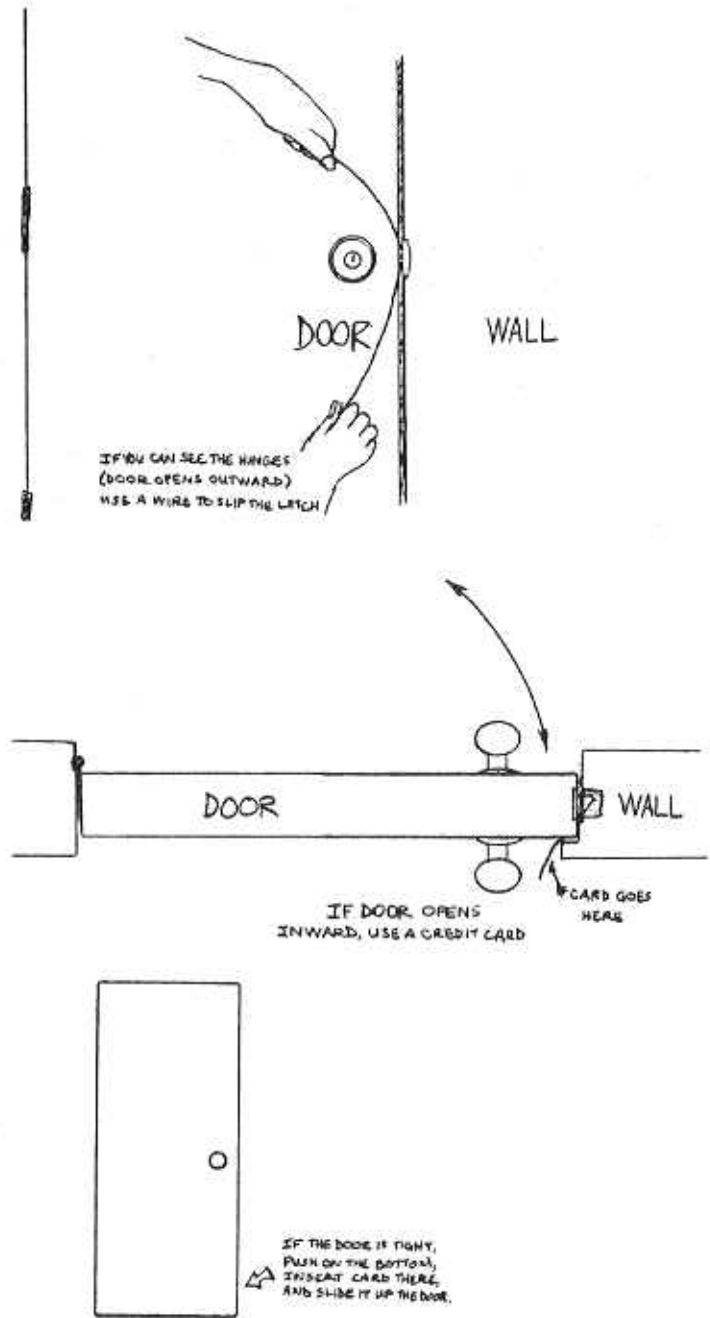
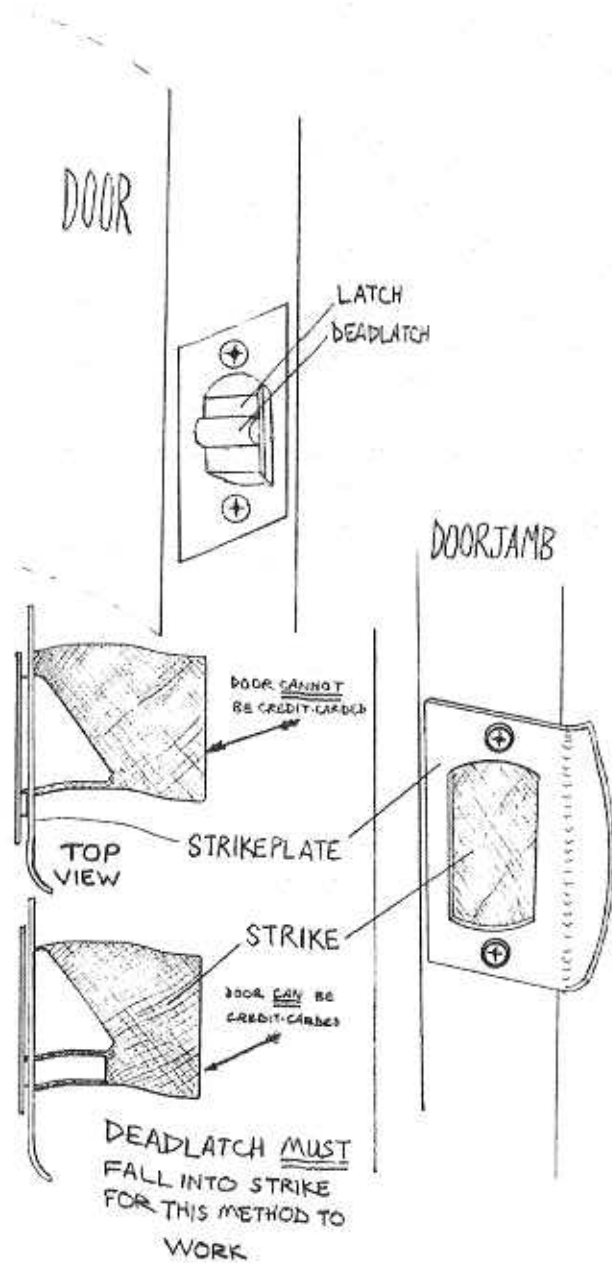

Credit cards don't work in this instance because the beveled side of the latch is not facing you. There are two methods of retracting the latch when you can see it and the bevel is not facing you. The first one is best done with a thin wire, perhaps from a spiral notebook, or a small bucket handle. Picture-hanging wire, tying or baling wire, a guitar string, or survey flags would work, too. Coat-hanger wire is likely to be too thick, but it might work. Bend the wire into a long curve, then feed it into the gap above the latch. You want the wire to go behind the latch and come back out beneath it. Grab both ends and pull. The force should retract the latch and free the wire. If you are unlucky, the latch will just fall back into the hole, and you will have to try again and pull the door open at just the right instant. Usually the door opens enough just from pulling the wire to prevent the latch from falling back in.

The other method uses the point of a knife blade. Stab it into the flat face of the big latch and push the latch back. Usually, one movement is not enough. To hold it where you pushed it to without losing your progress, pull the door handle hard and hold it. Then move your point to the starting position, ease off the door handle, and lever it again. An awl will work, too.

Although not very flashy, directly attacking the latch can be quick and successful, requires little skill and little in the way of tools, and depends more on how the lock fits into the door than the quality of the lock.

Remember not to push the small latch back, because its purpose is to freeze up the big one when retracted. If the little one is pushed against the strike, you might be able to make it fall into the hole by pushing or pulling on the door. You can't credit card a lock whose deadlatch is retracted.

Sometimes the tack strip may be a little loose. If so, it can be pried away from the sill a bit more, and a straight tool (spatula, steel ruler, knife, etc.) may have a clean, direct shot at the latch without having to go around the corner of the door. Obviously, this can't be done cleanly with painted-on tack strips or nicely finished sills, but it could be helpful in an emergency.

These methods work on other retracting latches besides those on knobsets, like those found on some file drawers, night latches, doors with inside push-bar handles, etc. Due to the unlikelihood of any damage resulting from such attempts, slipping the latch is a good method to try if feasible.

The latch holds the door shut. The latch mechanism as an entire unit is called a backset, most of which is inside the door. The spindle is a

rod that runs through the middle of the backset and attaches it to the knobs. The spindle has a locked position and an unlocked position. Often-times, one end of the spindle is the thumbturn or button on the inside doorknob. The other end of the spindle butts up against the back of the lock in the outside knob.

The spindle is a good target to attack when bypassing knobsets. During normal operation, the lock is merely a gateway to the spindle. On many varieties of knobsets, you can remove that gate and hit the spindle directly if you do not have your key. It is important that you use the appropriate technique when attempting to do this, because even a good technique will not get you into a knobset it was not designed for. Check out the knobset on your door. See whether one of these methods will work for it. If none of them will work for your particular knobset, find a different type of bypass that you can succeed with. If you don't do this when you have time to tinker around, you'll be upset when you need in but can't do it. An idea you do not test is not one you can rely on.

Trademarked brand names of locks have not been used in this book. Read between the lines and carefully examine locks to determine which ones are susceptible to these methods of knob and lock removal.

QUICK PROCEDURE TO BYPASS A VERY COMMON KNOBSET

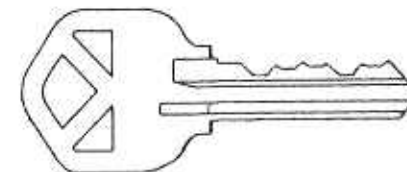

Set your eyes on one of these keys before? The knobset they were originally designed for is simple to bypass because the locking face of the doorknob can be made to pop out into your hand. Once it is out, it is a simple matter to reach in and twist the thumbturn, unlocking the door. Then turn the knob, and you're in! The really nice thing about this bypass is that the lock can easily be popped into place afterward, with everything working and the knobset back together again.

Quick list of materials: You will need a blank key. This should be easy to acquire - they can be found at most hardware stores, key

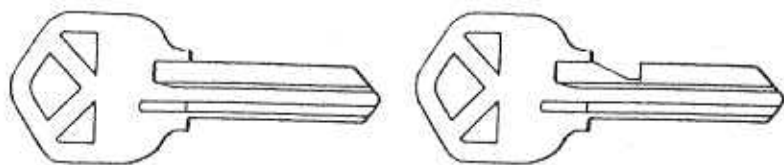

duplicating stands, locksmith shops, even some drugstores. If you can't get a blank key, a key that has already been cut can be modified the same way so long as the second cut is shallow. You will also need a very strong piece of string like a shoelace or parachute cord, a sturdy stick to use as a lever, and a brick or block of wood to act as a fulcrum. This is one of the few cases where it is OK to use force to accomplish the bypass. The reason for this is that the face of the lock is only held in place by two spring steel clips, which have shallow burrs that grip the inside of the knob. If you pull hard on the face of the lock, the clips give a little and the lock comes out.

Set this down in your memory: it is really important to understand that this only works with one brand of knobset, even though the key will fit into a bunch of manufacturers' locks. Companies build locks in different ways. This method will not work with locks whose innards are different. In fact, because you use considerable force, you could break a lock not susceptible to this kind of attack. Oftentimes, there will be a deadbolt and doorknob on the same door that use the same keys. Even if it is the right brand and the doorknob's face will pop out if you use this trick, you can't use the trick on the deadbolt. The deadbolts aren't made with this design weakness, even though they look like they might when viewed from the front. These locks are sold at almost every hardware store and building supply outlet in America, and there are many millions of them installed throughout the country. One modified key will open *any* one of them, making this a valuable technique once you can identify which doorknobs you can use it on. The company makes them in several different styles and finishes, but the keys in the package all look the same. You might want to go down to a hardware store and familiarize yourself with exactly which locks these are.

Quick modification of the key can be accomplished with a file or a rotary grinding device. You need a notch for the first pin of the lock to fall into and become trapped. This will make the key stick in the lock, giving you a handle to pull on the lockface with. File the notch about

three-tenths of one inch from the shoulders of the key. That's nine cents (one nickel and four pennies or a hair more) stacked from the square base of the blade of the key. Cut the front of the notch straight down, exactly square. If it is slanted too much one way, the pin can ride up the slant and will not be trapped. If it is undercut, only the top corner of the notch will contact the pin, stressing it needlessly. You are going to be pulling very, very hard on this key, so do it right. Cut down about four-fifths of the way into the top, flat part of the blade. You do not want to file any deeper than the deepest cut that these keys normally have. Leave as much brass as you can to keep the key strong. In order to get the key out, you will have to push the pin up out of the notch. You need to stick something in there that is slanted and lever it up. There is a problem here. The key pretty much fills up the keyhole, and it is hard to fit anything in next to it. However, a piece of aluminum pop can is thin enough, and you can cut a piece out of one with a short knife or scissors. Slide the pointed end in so it wedges underneath the bottom pin in the notch. Most likely, just sliding it in won't push up the pin enough for you to retract the key. Try to push the slanted end under the pin up by pushing down on the end sticking out of the lock, like a seesaw lever. Wiggle the key too, trying to work it out. It *will* come out very easily once the pin is pushed up, and there is only a tiny, tiny coil spring pushing it down.

Set a little time aside if you plan to make a really good bypass key, because it will take some careful handiwork. If you opt to cut a channel into the key for a release tool to fit into, which is wise, do craftsmanship. It is groove without proper rotary grinding device, be careful not to grind safety glasses. If you you can buy a (such as carbide cut-spindle that holds small rotary tool and Don't erase the ridge part of the blade and Simply elongate and the top bit of the key.

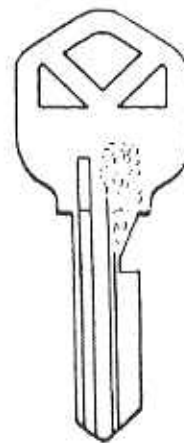

release tool to fit it with some pride of hard to make this equipment. With a it is really easy, but too much out. Wear have an electric drill, grinding attachment off wheels and the them) made for a put it into the drill. between the notched the first groove. deepen the milling on Don't grind all the way through the key, just make the blade thinner on one side and, far enough back into the head of the key for a tool to pass into the keyway.

You could use a pick, paperclip, metal pocket clip from a pen, piece of barrette, or anything similar as the release tool. Another thing that is prudent to do is to drill a very small hole into the end of the key, into which you can loop a bit of fishing line or strong nylon thread. It would be used only if your key broke while you were trying to pull the lockface. This sometimes happens if you use the tool too many times, if it has been filed too thin, or if the key gets bent when used carelessly. It can be really difficult to remove a broken key from a lock unless you have a handle to grab. The bit of thread will provide a handle. Remember, if this happens and you use the line to pull the key out, *be sure to push up and hold the fallen pin so that the key is no longer trapped before pulling on the thread.* Otherwise, you will snap the thread the same way you snapped the key off. Nickel-silver blanks have a higher tensile strength than brass blanks do, and resultingly make better bypass tools.

When you are done, your key should look like this:

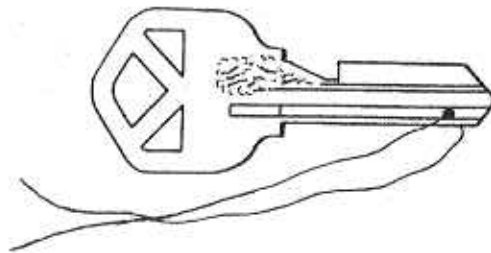

Quick to accomplish once you have modified the key blank, this method relies on a simple lever to increase pulling power. Tie the key to one end of the stick with cord. Loop it through several times if you can, and make only one knot, tying the ends of the cord together. You want the distance between the stick and the key to be as short as possible. Put the fulcrum below the doorknob against the door. Insert the key, make sure it engages the first pin and is held in place, and brace the stick against the fulcrum. Then, pull on the other end of the stick, watching to make sure the key is pulling evenly. Don't do it violently. The clips are on the sides. You might focus your pressure back and forth a little bit on them. Pull in a pulsing manner. Remember that it doesn't come out very easily, but it does come out. Try not to torque the key. It takes hundreds of pounds of pull to remove the face the first time. The length of your stick will determine the mechanical advantage you have. With a thirty-inch stick and a short distance from the key to the fulcrum, it isn't too hard to pop out the lock face.

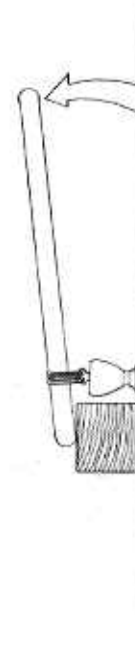

Set aside your anxiety that you won't easily be able to find a stick, fulcrum, and string that will withstand that kind of strain. The "stick" might be a dowel, broomstick, shovel, piece of pipe, crowbar, baseball bat, two-by-four, whatever. Even the straight piece that forms the rear leg of a folding chair can be used, without taking the chair apart. Just so long as it gives you a mechanical advantage. Framing hammers work well if you can attach the string to the end that pulls nails. The doorframe can even be used as the fulcrum. Pull out the face of the lock as you would a nail. You really do need to find a solid fulcrum. A full can of soup can easily be crushed doing this, so a can, empty or full, isn't strong enough. Get a brick, or a rock, or a piece of wood, a heavy cooking pot, or something else you can't crush. The fulcrum must be longer than the doorknob. If you snap the string you're using, find something heavier, like wire or the brake cable from a bicycle. Makeshift parts will work well since there are no tolerances that must be observed. If you are in a hurry, the key only

needs the capture notch cut or filed in. It will take longer to remove the key afterward, but getting the door open may be more immediately convenient.

Quick tips and information

- When the lock pops out and you look at it, you will see that what you were fighting against are two tiny little burrs. It seems ridiculous that they could put up that much of a fight.
- The spring steel clips occasionally break. If they do, that is a bummer, but don't fret much over it. These are very inexpensive locks. One clip will still hold the face in the doorknob until you get another lock.
- When the lock is out, look into the hollow knob and find the spindle. Usually, a thumb and forefinger together are too big to fit in and grab the spindle, but both forefingers at the same time (two hands together) work well. A flat screwdriver or pliers will work too, if you have them. Turn it counterclockwise to unlock the door.

- While the lock is out in your hand, take a look at it. You will see a shiny metal piece above the pin column. That little cap, which is crimped into place, is what holds the pins and springs in the lock. If the cap pops off, tiny springs fly everywhere; and beneath these are the top pins, and beneath those are the bottom pins. If you take the lock apart, be careful, do it slowly, and keep everything in order. There will be five holes in a row. If the pins get out of order, remember that bottom pins

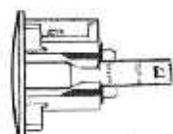
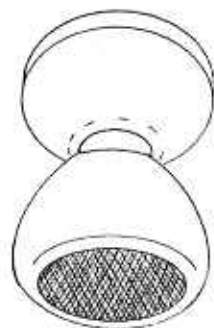

SIDE VIEW OF LOCK



TOP VIEW OF LOCK

- go in first, then top pins, then springs. If you put the bottom pins back in the wrong order, your key won't fit it.
- When you pop the lock back into the knob, you can do so upside down or right side up. Right side up is when the springs and top pins are on top, so the shiny, tinny piece crimped on to keep them in faces up, too. The lock, when pushed in, will snap into place.

Set down in condensed form, you can see how simple it is: pop in a notched key, pop out the face, turn the spindle, and you're in. If you bend the clips in just a little, or if you pull the face out two or three times, you'll find that the face will come out much easier and you won't need the string, fulcrum, or stick to do it.

KNOB REMOVAL

Look at the outside door. Behind the knob, hole in the outside skin of the shaft. If you have your ticket in if you have

It is an access port will release the knob when put there to allow the lock. You can't just push the would be ridiculous. It is in conjunction with the a little effort, you can often

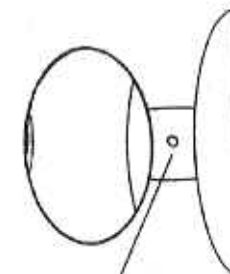

RELEASE ACCESS HOLE

knob of your there may be a metal on the side one, it can be lost your keys.

to a button that depressed. It was to be rekeyed. button in - that meant to be used proper key. With get around the

- key requirement, but you should first learn how it is supposed to be used.
- Insert the proper key and turn it as far as it will go. With more expensive locks, it has to be turned to the unlocked position, but these high quality locks usually wind up on businesses. A company's cheapest is what you'll usually find on your door. Cheaper locks can be turned either direction to put the button in the active position. Really cheap locks will allow the knob to be removed when the door is unlocked, without a key at all. Some externally located buttons can be forced in.
- Look for the bar or button inside the hole in the shaft. There may be two holes; if so, find the right one. You may have to turn the knob and peer at the hole until the button appears.
- Push the button in with something small enough to fit in the hole - an unbent key ring or other bit of wire, paperclip, ballpoint pen, or lock pick. Hold it in.
- Try pulling the knob off. Oftentimes, it has to be lined up to do so. This might involve twisting the knob while pulling until it pops off. Remember that the button must be depressed to release the knob.
- Once the knob is off, treat it gingerly and study it visually so that you know how it goes together. It might fall apart, and if it does, you will have to put it back together before it can go back onto the door. Carefully put it aside.
- The door is still latched, but no longer has a lock. All that remains to open the door is to turn the spindle. This can be done with a screwdriver or pliers, a key, a metal clip from a pen cap, etc. A pick or tension wrench will often work, and the tailpiece of the lock you just re-

moved will serve admirably, also, though it may be awkward. The whole shaft, in some cases, must be turned to open the door.

- When putting the knob back on, the parts must line up with each other and the lock itself must be in the right position. It can be unnerving if it doesn't go on easily right away. Parts may get loose and roll around inside the hollow knob. Don't panic. They line up in a logical order, the back of the lock fits with the spindle, and you will see a slot that the button has to go through. You may have to depress the button again to get the edge of the knob's base over it. If you don't lose your head, and if you keep trying likely options, you'll get it. It helps to put the key into the lock when reattaching the knob, to hold things in place.

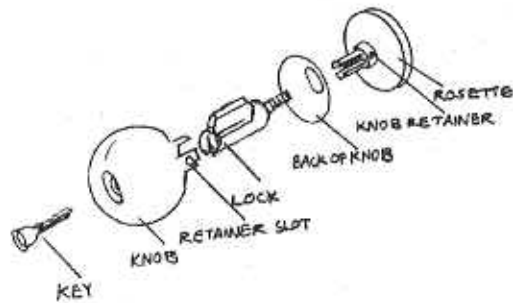

Once you accomplish removing and replacing the knob with the key, you should try it without the key. You'll need lock picks. At first glance it seems pointless to remove the knob if you are going to pick the lock, anyway, but knob removal is a useful skill for when you can't unlock the door with picks. Oftentimes, it is an easy matter to pick the lock one direction (clockwise, for instance) but very difficult or impossible to pick it in the other direction. To open a door with lock picks, the lock must be turned to the unlocked position. If you were to find that it is impossible to pick in the direction you need it to go, but can turn it to the other position, you can often remove the knob instead of hitting a dead end.

Depress the button in the hole and pull the knob off once you have picked it into the position that allows you to see the release button. Once you have the door open, it is a good idea to retrieve your keys and insert the right one (remember that you will have to turn the lock to the vertical position first, so that the pins snap back into place, before the key will fit into the lock) before trying to put the knob back on the door.

If your lock has a small, rectangular button protruding slightly from the side of the shaft, although removal of the knob with a key or by picking is preferred, it is not essential. Try picking it unlocked first! If you

repeatedly fail and can't pick the cylinder to the locked position, either, you can still take the knob off. With a screwdriver and a hammer, you can pound in the retainer and pull off the knob. So long as you're careful and accurate, you shouldn't damage the lock, but don't count on that. Using force is not a preferred method of bypass. Only do this if you can afford to have the lock repaired or replaced if something goes wrong.

There is a very common kind of knobset that locks only from the inside and is unlocked from the outside by turning the key clockwise. The key cannot be turned counterclockwise from the vertical position. A bypass may be implemented to remove the face of the knob, *but it is not pulled out by force*. To remove the lockface, a special tension wrench is employed to *pick* the lock counterclockwise. When it rotates into the release position, it will fall into your hand.

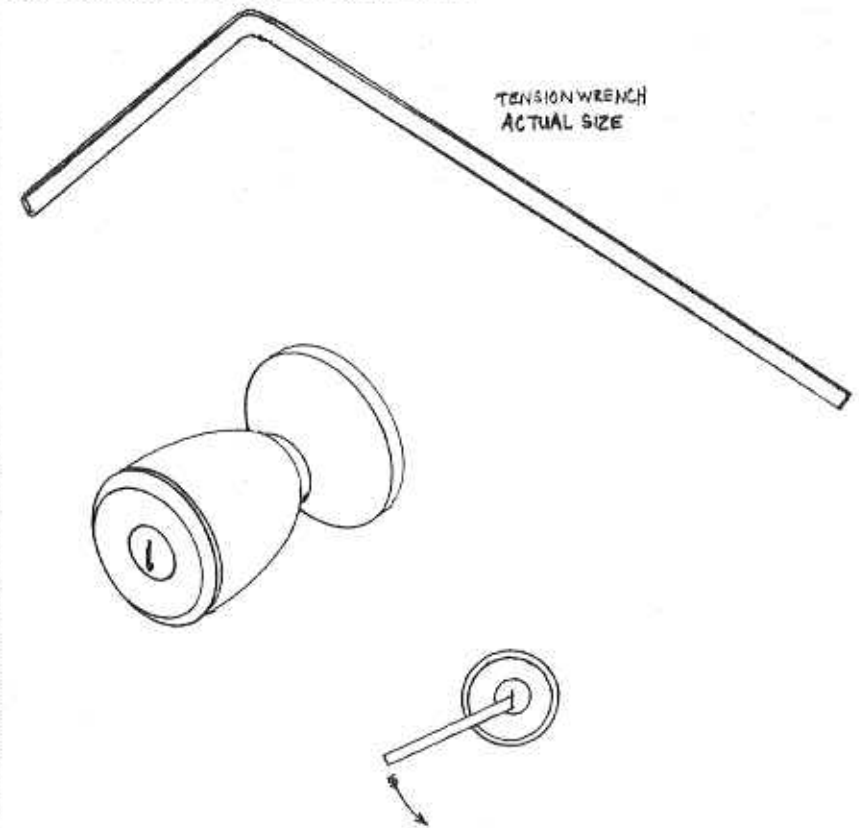

Take a lock pick and stick it into the middle of the keyway, all the way into the back. Try pushing it further. If it will travel in another quarter inch or so but return under spring pressure, you are working with the

right kind of lock for this trick. To make a tension wrench, stick a straight

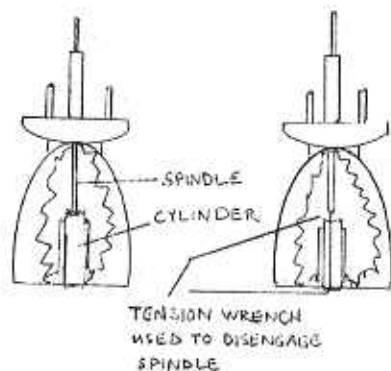

piece of spring steel (such as a street sweeper bristle or curling roller pin) into the lock, push the spring-loaded tailpiece back as far as it goes, and mark the spot on the steel strip. Remove the piece and bend it there. Then, reinsert your newly made tension wrench, push the tailpiece back with it, and apply tension counterclockwise. The side-

ways torque should hold it in place, but if it doesn't you can hold it in place with a thumb. Then pick the lock. Once it is picked, ease off the tension and slowly turn it. It should hit a release point between nine and eleven o'clock. The face will come out or will bulge out a little, allowing you to remove it with the tension wrench. One thing you should look out for while picking the lock: the spindle is small and square and sits in the middle of the keyway. It is possible to slip above or below the spindle with the tension wrench and fail to push it back. Also, the tension wrench takes up a lot of space in the keyway, so using a small diamond pick works best.

The lock shell is plastic, with a metal cylinder in the middle of it. If you peer into the hollow knob, you will see a square rod, the spindle. It can be pulled out some more if you have difficulty grabbing it from where it sits. If you pull it out too far, it will no longer engage the lock, but it is a simple matter to push it back in. Turning the spindle clockwise will unlock the door. If you are having a hard time getting enough pressure on the spindle with your fingertips and do not have pliers, you might try pinching the spindle between two coins with your thumb and forefinger.

Unfortunately, this lock can be difficult to reassemble. Remember to get your keys first, and determine to be patient. Because the spindle is square, it will fit into the lock in four different positions, but only one will result in a functional lock that works the way it originally did. You may end up picking the lock counterclockwise again and again until you get it right, unless you are thoughtful and mechanically oriented.

There are knobsets that may be opened with little difficulty due to their design. The keyhole on these locks goes all the way through both sides of the cylinder, and the cylinder butts up to the spindle. So, if you

can reach back there with a pick, it is possible to turn the spindle with several twists to manipulate it. With the door open, it should be pretty easy to tell if this is going to work with your lock. Place the pick first, then watch the inside thumbturn while applying a little downward pressure and turning the pick repeatedly. If the thumbturn is obviously moving, you should be able to master the skill shortly. If you can only get the thumbturn to wiggle a bit, it isn't the kind of knobset you can do this with.

GRABBING THE INSIDE KNOB

Opening a locked knobset with masking tape will bring you a mischievous sense of triumph. There is something silly and clever about defeating a device designed by experts using something as mundane as masking tape.

Doors that lock by pushing in the inside knob and twisting it can be unlocked by twisting that knob the opposite direction. Some brands of knobset will open even when locked, just by turning the inside knob. Oftentimes, a tool can slip through a narrow gap, wrap around the inside knob, stick to it, and twist the handle to unlock the door.

Visual inspection of your progress is helpful. If the door has glass panels or if the inside knob may be seen from another window, take advantage of the opportunity. Having a friend peer in and give verbal directions while you're working will greatly improve your chances if you can't see the knob from where you are.

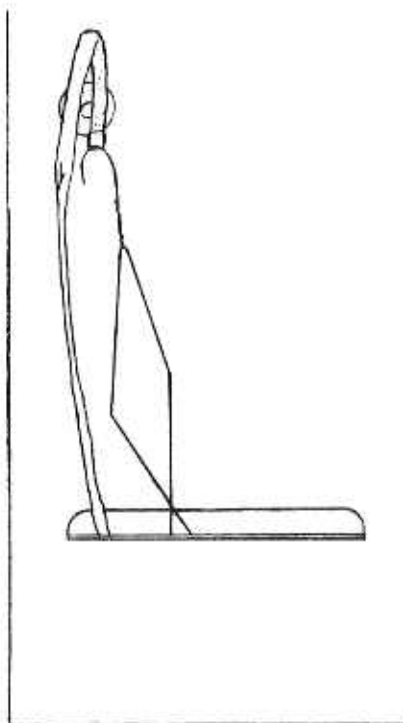

Weather stripping is the enemy. Look for the widest gap you can find. Ideally, this would be a mail slot, pet door, ventilation grate, or open window. Obviously, if the window opens widely enough, you can climb through it, but windows often are made to open just a few inches to prevent that sort of thing. A quarter or half-inch gap several feet away may be much easier to use than jamming a strip of tape, plastic, or wire between the insulation in the doorjamb. One reason why is that you are likely to be using flimsy, improvised tools, and the resistance that friction provides often makes it hard or impossible to guide the tool to your target.



The trick to opening a knobset in this way is to lay a strip of tape on the inside knob and tug to turn it. As a simple example, think of the cagelike metal fences that separate the stairs leading up to apartment units from the parking area beneath them. The knobsets on the fence doors can always be opened from the inside, but you need a key or combination to enter from the parking lot. Usually there is a grate of mesh surrounding the knob to prevent people from reaching through the fence and grasping it. That is an effective measure for keeping intruding hands away, but a grate won't stop a narrow tool. Long strips of tape may be layered on top of each other to increase the strength of the tool, and the resulting strip must be folded lengthwise for most of its length. This is done to add stability to the tool and to prevent the sides from sticking to each other. Leave only the middle five inches unfolded and still sticky, to contact the doorknob. Carefully push the middle part of the tape through the hole and guide it with the

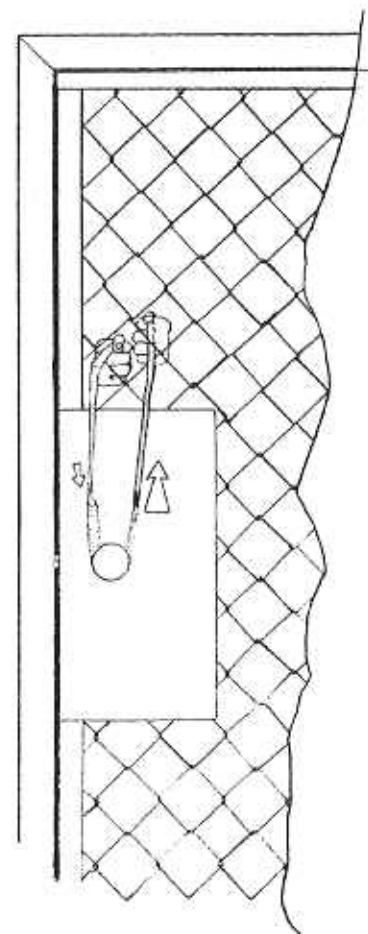

folded over handle ends, one on each side. You have to point the handles down after pushing them in several inches, so the tape goes toward the target. You maneuver the tape so that the sticky side is up and is underneath the knob, with a handle coming up on either side. Then you carefully pull up until the tape is cupping the bottom of the knob. Keeping light, even pressure on one handle, just enough to keep the tape from pulling off, you raise the other handle, turning the knob, and push open the door before letting it go.

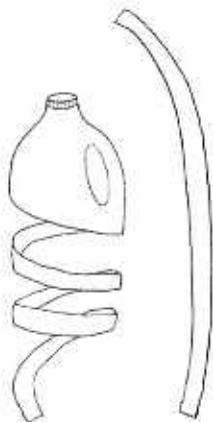

When access ports aren't so convenient, masking tape needs a little assistance from milk jugs, draw cords, coat hangers, antennas, or whatever other odds and ends you can use. If you are working with a wide enough gap so that you are free of friction, a coat hanger wire or a piece of string to support the end will suffice to guide the sticky tape to the target. Most situations aren't quite so inviting, however, and may require stiffer, thinner materials that can be fitted through small cracks, around corners, and still be guided to their destination.

Plastic is an excellent material for worming through cracks. By slicing an empty plastic jar in a spiral or cutting apart a plastic three-ring binder, you can make a long, thin plastic strip. The kind of plastic you use and the way that you cut it is going to affect the tool's performance. You do not want it to curl too easily or you won't be able to control it. Plastic milk jugs work reasonably well, and so do the plastic slats of cheap mini blinds. Wherever you can find thin plastic that can be cut into shape, you have a potential tool. You may be able to buy a plastic sheet at an art supply store. It doesn't really matter where you get it, so long as you can make it perform. The plastic cannot be too stiff or too thick. Experiment and find out what works best for you.

You want the strip to curve when laid out flat, in order to get the best performance. If it is straight, it will be extremely difficult to use it to grab a doorknob, although it is fine if you want to open lever doors. Don't make the curve too sharp or you won't be able to push it through the gap at the edge of the door.

Play around with the plastic strip closed in an interior door to get the a feel for what you will be doing, and get a grasp of the difficulties.

Once you have a plastic strip, close it in the door, half inside and half outside. You usually can push it further in, pull it out, and tilt it upward and downward. Weather stripping will make it difficult, but the effort and control you put into it determines how much friction you can still operate under. Some people give up easily or fold the plastic in their attempts and fail. Use finesse and be persistent.

Pull the strip all the way out, then work it back into the space between the door and the sill until it is sticking through on the other side. This isn't very easy, but it can be done with most doors. A couple of tips: Most of the time it is easier to insert the tool a couple of feet above or below the latch, where the gap is looser. Also, if you bend the very tip of the tool so that it fits around the corner of the door, it will slip around the sill with less likelihood of getting stuck.

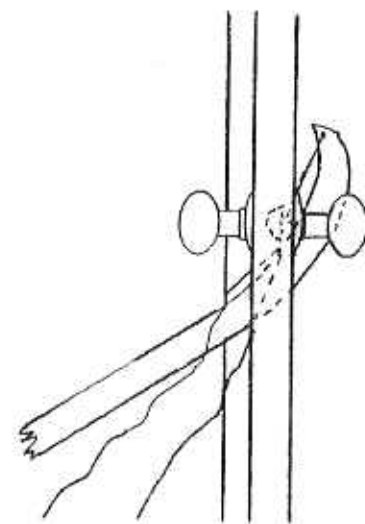
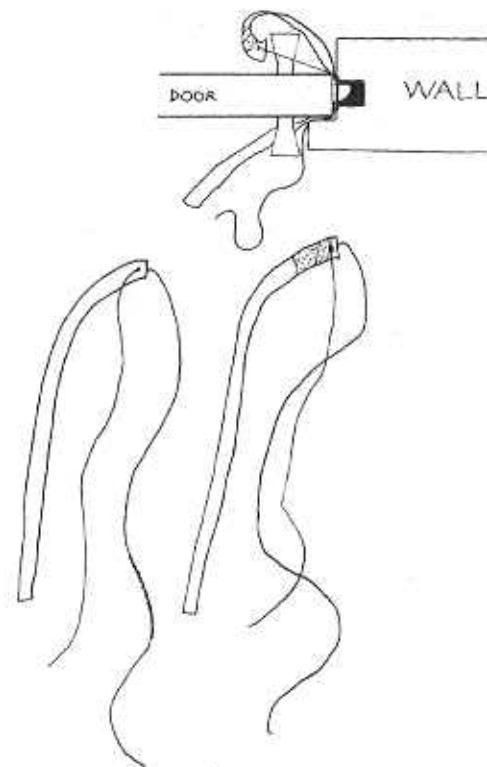

A useful alternative exists if this isn't working for you. It can be hard to get the tip of the tool through the edge of the door with the string in place. Another option is to slip the first few inches under the door, over to the edge, and slide it up the doorsill from the bottom.

Of course, having a strip of plastic poking through the sill next to the doorknob doesn't open the door, but it's a step. To control it, you need a string. If your strip of plastic is a long, thin rectangle with one droopy end, poke a hole into that end and put a string through it. Do your best to make a round hole, as they are less likely to tear. Thin, strong stuff like packaging string or the kind on mini blinds works well. If it is too fat, it won't make it around the sill, and if it is too weak, it will snap when you need it to hold. The flat laces for men's dress shoes, thin rawhide strips, and high-test fishing line can be made to perform well with modification.

When you push the plastic strip with the string into the jamb, give the string as much slack as you can. Pulling on the string bends the plastic in toward the door. Once it is bent around the knob, pulling the string and strip out at different angles should wrap the strip against part of the knob.

Where's the masking tape? That depends upon how big of a gap you have to cope with and how you decide to work it. A good spot is about two inches behind the hole for the string, on one side of the plastic strip. By carefully wrapping and folding the tape, you can get a flat profile with an inch or so sticky side out. Make it as unobtrusive as possible and in a lot of cases you can slip it right in on the side that touches the door. If the door is too tight or you are too sloppy to do this, tightly spiral some tape, well attached but with a sticky surface, around the string. The trick then is to loop the doorknob with the string instead of the plastic and string together. This is a little tougher, but feasible. Then pull one end of the string until the sticky part is in place against the hole in the plastic strip. Maneuver it around so that the sticky part has a good bite on the wide part of the knob, and pull both ends of the string with one hand and the strip with the other to turn the knob.

Tape will work with a lot of interior doors, but oftentimes will get torn off when doors have weather stripping. A light coating of something sticky (tree pitch, road tar, rubber cement, chewing gum, spray adhesive, etc.) on a several inch patch of the string will make it grab pretty well. Don't try to put this part of the string through the gap until you've looped

After positioning the tool over the lever handle and sliding the bottom over so the tool connects with the lever, pull down on the string to open the door.

When vertical the tool should be a couple of inches higher than the lever handle.

the knob with the string and can *pull* one end until the sticky part is in position on the other side of the door. The reason to keep the string long is twofold – it allows you to feed the sticky section when you need it, and it lies flatter than a knot does. It is tough to push a knotted string on the end of the strip through the door.

Practice the plastic strip method on a door where there is a window to see the inside knob. If you can't do it with the door closed, try it with the door *almost* all the way closed. It is important to get the technique down before making a judgment on the method. There are doors where this is a great way to bypass the lock and others where it won't work. A lot of doors fall in between. Materials and skill are important with this one.

LEVER DOORS

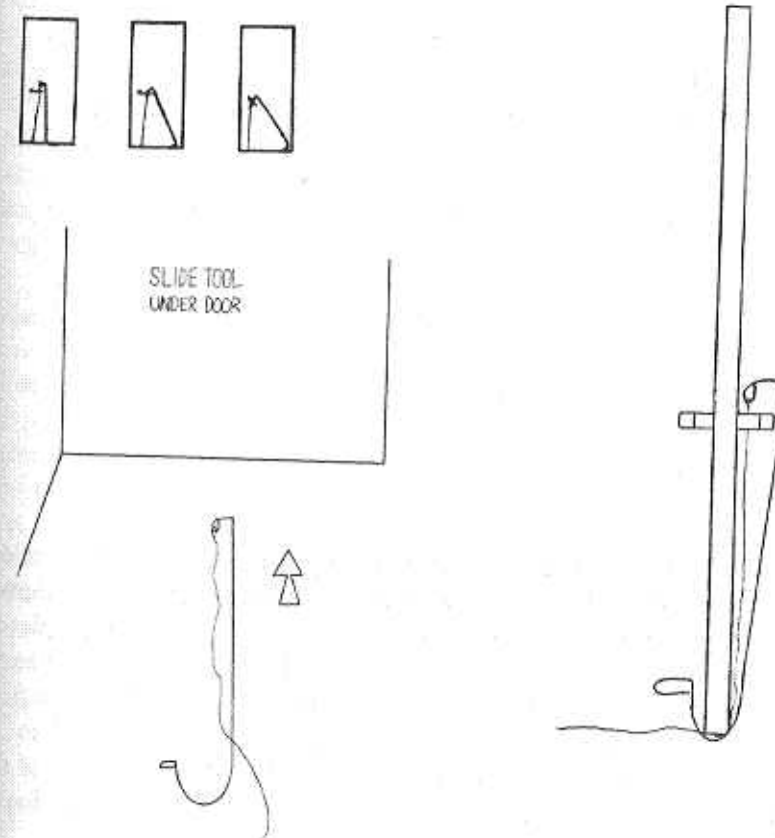

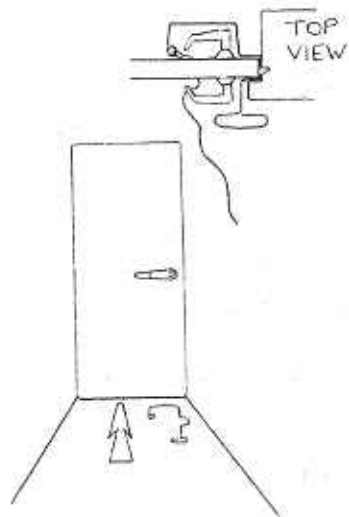

String not shown in some of these pictures since it would interfere with picture clarity.

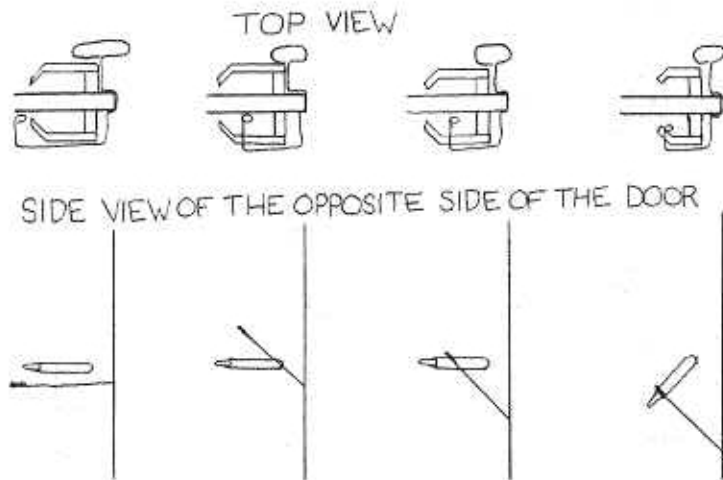

Although some lever doors freeze up both handles when locked, most of them are made to be opened from the inside regardless of whether the lock is engaged. Due to their large, easy to grab design, it is simpler to open these by reaching around the door and grabbing the inside handle than it is to open a knobset or deadbolt in a similar fashion. It is even possible to construct a tool that will reach under the door and up 36 to 38 inches to grab the lever. Tool design is going to depend on the shape of the handle and the door, so you may want to modify some of the basic shapes shown to suit your needs best.

Because you only need to hook the lever instead of twisting a round handle, you don't need sticky tape or mucilage on any strings your tool might have. You might want to put a sticky coating on the part of your tool that contacts the lever, to keep it from sliding off. You can get by without doing that if you have to, though. Another simplification that might help you is taking the string off your plastic strip tool. This will give your tool a thinner profile and will make it easier to slip in next to the doorjamb. By splitting the strip down most of its length, you end up with a tool that can be looped around the lever. Once you've done this, a tug will open the door.

Wire and string tools are effective, and what you make will probably be determined by the gaps around the door and the length of the wire you have. It takes a heavy gauge wire or narrow rod about four and a half feet long to make a tool to slide under the door. Some antennas are this long, and you might find spring steel wire of this length at the right hardware store, but often a suitable piece just can't be found. If made well out of one stiff piece, the tool can be pushed under doors that have threshold gaskets or door shoes. If it is an interior door over a tile or linoleum floor, you can get by with a tool made from a straightened coat hanger and a pair of locking pliers for a handle. All you have to do is hook the handle and pull down. If the gap is narrow or you have to fight weather stripping, tying a string to the end to pull on and guide the tool is necessary.

If the wire you are working with is short, or you have flat wire (like fish tape) that is unsuitable to use in making such a long tool, you can carefully bend wire into a shape that will hug the edge of the door and slide up along the edge of the jamb. Remember to set it up so that it can be worked at an upward slant, so the latch doesn't get in your way, and remember that how much you tilt your tool is going to affect how close the end of the tool gets to the door. You have to plan the tool so that it lies flat, or you can't slide it into position. Experience is going to have to guide you in learning how to manipulate these tools. Remember to attach a string to any spot that you have to tug on that the strength of the wire won't support well.

PUSH BARS

These doors have a long bar across them that retracts a wide, beveled latch. This kind of door release is often found on double doors. Because they may be exited when the door is locked, you can lock yourself out pretty easily. From the outside there is a pull handle with a thumb paddle above it. If it is locked (the thumb paddle will not move and retract the latch), you may be able to get in anyway. If it is an interior door, there may not be a deadlatch, and the lock may be slipped (p.42). If the latch is secure, the trick is to pull the push bar down from the outside of the door. If there is a visible gap between the door and the sill or between double doors, a simple wire hook can be slid through, rotated so it catches the bar, and then tugged to depress the bar. This is quick and uncomplicated. Oftentimes, however, the doorsill presents a 90 degree corner to negotiate, and that demands some finesse and stubborn determination to overcome. A plastic strip with some tape just behind the hole for the string may work to snag the corner of the bar if it is the round kind that sticks out a few inches from the door. The more streamlined rectangular kind that lies close to the door may be overcome with a very stiff wire and some rubber cement or masking tape. Attaching a string to the working end will give you a more direct pull on the handle. Slide the tool partway under the door, then up the sill, until it is in place over the bar, then tilt it so the axis slides down and the wire contacting the bar pushes the bar toward you.

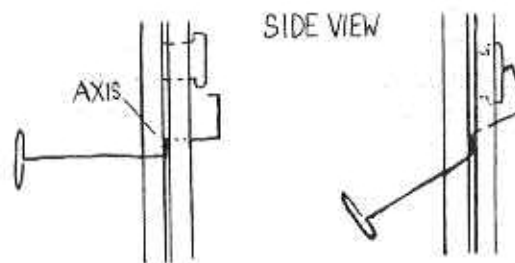
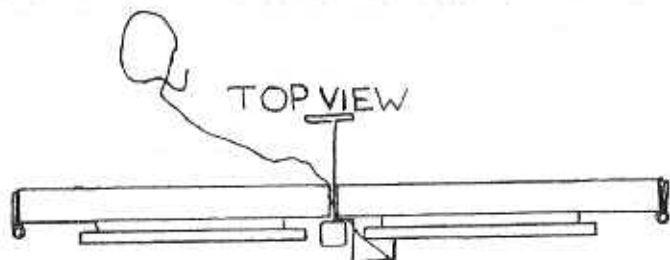
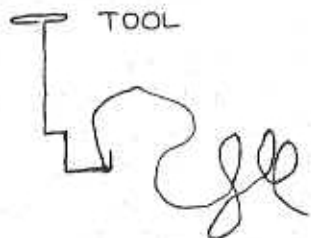

DOORS FROM THE INSIDE

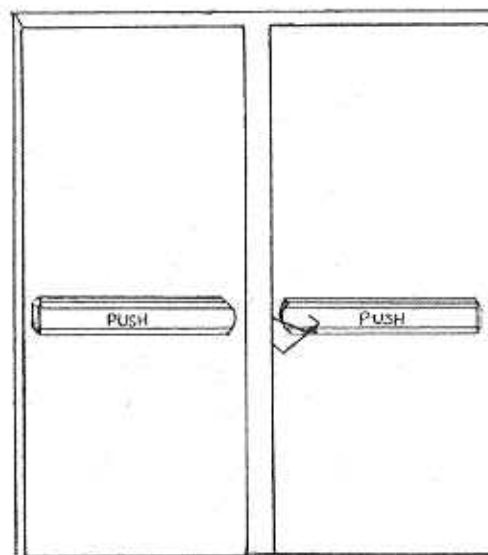

Whenever you make a wire tool, tolerances are important. If you think you can make a tool to open your door in a pinch, make one before that time happens and get it to work. Model it using the open door, and custom fit it so that it hits *exactly* where you need it to. Make it work by holding the door halfway open and watching both sides, using the tool only from the outside. If you can't make it work this way, you're not going to be able to make it work. You want all corners to conform closely to the edges of the door, because it will be a tight fit, and you are going to want to use the highest quality wire you can find or it will bend out of shape when worked into the gaps. Electrician's fish tape will work to hook

a handle, but probably won't tilt and retract a flat push bar without a helper string. Spring steel wire of the thickest diameter that may still be worked through the gaps would be best if you do not have string.

If you have brazing rod or some long antennas and a means of connecting them (string, wire, tape, epoxy, etc.), then you can make a big tool to slide under the door, reach up, and butt up against the push bar.

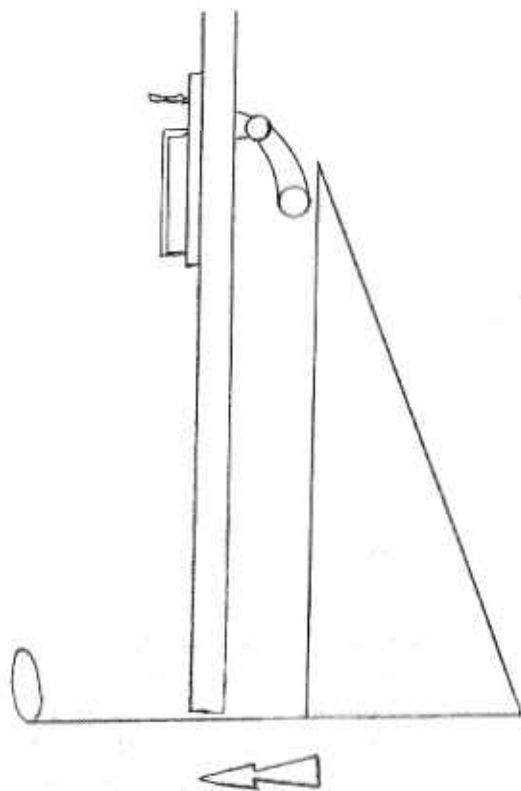

DEADBOLTS

Don't let one of these locks daunt you. They are not scary, and they are not much more secure than knobsets. The difference is not in the type of lock, but the type of latch. A deadbolt is no harder to pick than a knobset of the same brand. If they open using the same key, it is actually easier to pick the deadbolt, since it is more firmly attached to the door and won't rattle around, distracting you from the work the way knobs often do. Once it has been picked, you have to turn the tension wrench further than with a knob, just like using the key, and it is just as important to turn it all the way back after it is unlocked so you can put the key inside it next time.

Sometimes a lock just won't pick. If you aren't having luck picking it open, consider alternatives. You cannot open a deadbolt with a credit card because the end of the latch is square and is built not to be pushed in from the outside. There aren't any tricks to remove the lock assembly without damage, like you can do with so many knob locks, pulling the middle out. So the best way to open the door is to reach around and open it from the inside. Go around and physically check all other entrances of your home to be sure that one of them isn't open or couldn't be opened more easily. You may have a deadbolt on a different door that you can pick open, or you may find a window you can crawl through. If you have exposed hinges on a door, you might try removing the hinge pins and taking the door out of the frame. But if these aren't practical options, go for the gaps.

Look for the widest gap you can find. It may be at the bottom of the door, after you remove the storm strip, or a window open a half inch nearby. If you've been blessed by fortune, there might be a mail slot or a ventilation grate set into the door or placed next to it. Often these have exposed screws, which may be unfastened if you need a bigger gap. Check the condition of the weather stripping, if any exists. If the door does not shut tightly, you may be able to work a thin tool up the side of the door or slip a plastic strip through the gap. An accomplished person can work a tool through the gaps of nearly any door that isn't well weatherized. Someone making halfhearted attempts will not be able to get a single method in this chapter to work. Doors are not often so well maintained that there is not an exploitable gap near enough to operate a tool through. However, a deadbolt that isn't set properly in the door and doesn't function easily with the key can be difficult to open even after the tool is in place.

These methods, to be useful, must be practiced first in controlled conditions. The easiest way to practice is to tape a table knife (NO SHARP EDGE) from a set of flatware to the edge of the door to act as the gap between the door and the sill. With the door open, you can try unlocking the deadbolt, watching both sides of the door so you have a perfect visual path and can make sure the tool is fitted exactly. If you are unable to unlock the deadbolt when the door is open, you are not going to be able to do so when the door is closed. Learning how to control the tool without the impediment of friction is necessary to be able to overcome the friction a tool encounters when worked through a gap in a real situation. After becoming proficient in the use of the tool with the door open, see whether you can get the tool into position with the door closed. Be absolutely sure you have your keys with you. Opening the door two or three times is all you really need in the way of practice. If you're not positive you can succeed with this method on the particular door you're working with, your chances are slim if you ever choose to employ these methods on unfamiliar doors. Once you're competent, it will still be a challenge, but you will be able to meet it.

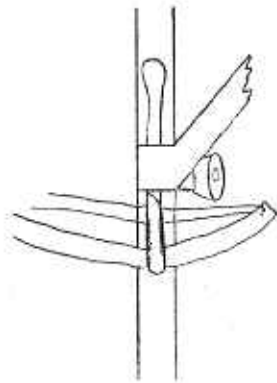

Check to see what kind of handle you have. There are two common styles of thumbturns, and there are deadbolts that have locks on both sides.

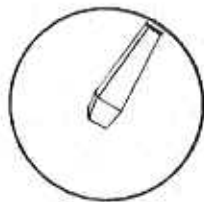

These methods won't

work for the latter kind of lock unless there is a key in the inside lock.

One kind of thumbturn has a post between the handle and the plate, a stem for the thumbturn. The other kind has a thumbturn that sits next to the plate with very little space between and a handle that is more like a paddle. The methods to employ when opening these thumbturn styles differ.

If you have a stem on your thumbturn, hang a string around it. This should be a strong string, made sticky with rubber cement or tape or something. Pull strongly on both ends of the string, but pull harder on one

end so the string moves in that direction. You should be able to make the deadbolt latch and unlatch by operating the string this way. If the string just slides over the stem, you need to make it more tacky so it has a better grip. If the door does not line up with the frame too well and the latch doesn't sink cleanly into the strike, push or pull the door into the correct position to facilitate ease of operation. Remember, you are doing this from the inside of the door, to check and test things out.

To get the string around the stem from the other side of a locked door requires persistence and finesse, two qualities that don't come naturally together for most people. Being able to see what you're doing is immensely helpful, and so is following directions given by a friend who can see the inside of the door through another window if you can't see it from your working position. Working by feel only succeeds for the most talented and is never preferred.

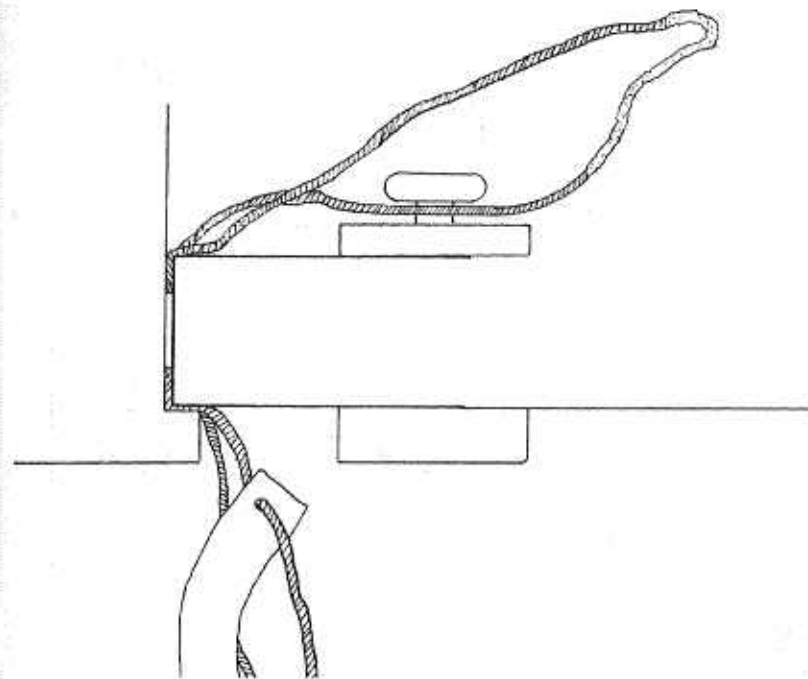

If you have a gap under the door wide enough to allow the passage of a tool, and enough space at the edge of the door to slide it up to the deadbolt, a wire-and-string device can be constructed that will efficiently get the string around the stem of the thumbturn. If you can see what you are doing, you can hook the end of the tool over the thumbturn and tug the string to pull the wire against the thumbturn's handle. Once you have moved it a little and the wire has slipped off, you can reposition the wire against the other end of the thumbturn and move it the rest of the way. This is too complicated to do without visual guidance. If you are doing it blind, so long as you have shaped the tool properly and you can get it into position, it is not difficult to loop the stem of the thumbturn. Once the string is in place, lower the tool back down and out of the door so you have both ends of the string to tug on. A sawing motion should retract the deadbolt. Choose a place at the edge of the door where the gap is widest to allow the most room for the string.

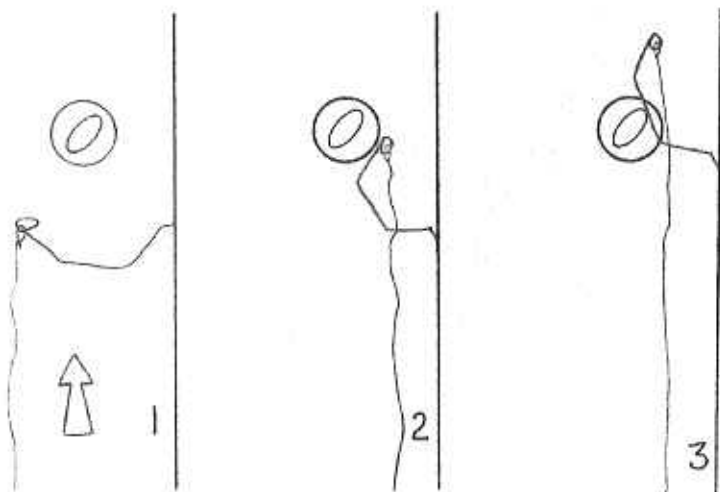
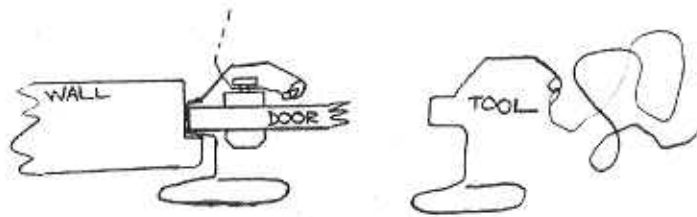

The best materials to use for these tools are electrician's fish tape and mini blind string coated in a six inch section somewhere along its length with rubber cement. If you are looping the inside handle, use an uncoated section of the string to get it there (it is easier to move into place) and slide the sticky section into place after everything is set up.

The paddle-style latch can be opened with a simple wire tool that is slid under the door and into position up the side of the sill, tilted to pass on the near side of the deadbolt so it rests in position leaning against the paddle. The string is pulled from the far edge of the bottom of the door, which flips the paddle and retracts the latch.

You may find that variations on the shapes work best for your particular door. Shape the tools you use to learn these methods around the specific doors you are working on. The widths of doors differ, and the distance from the edge of the door to a lock's center is variable, too, although it is usually two and three-eighths or two and three-quarters inches. Fit the tool very carefully so that it conforms closely to the edge of the door, otherwise you will never be able to slide it up the sill. If the knobset below the deadbolt gets in the way of your tool, you might open it first to allow the tool to pass above it or construct the tool so that it can operate from below the knobset.

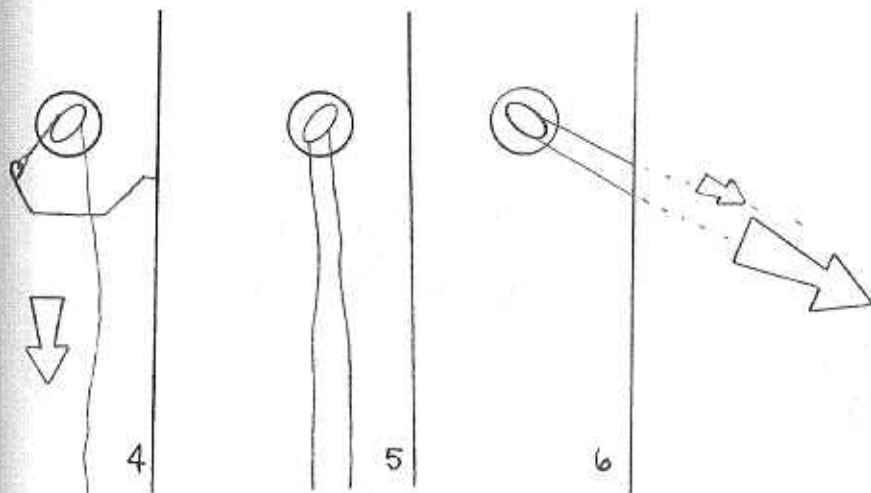

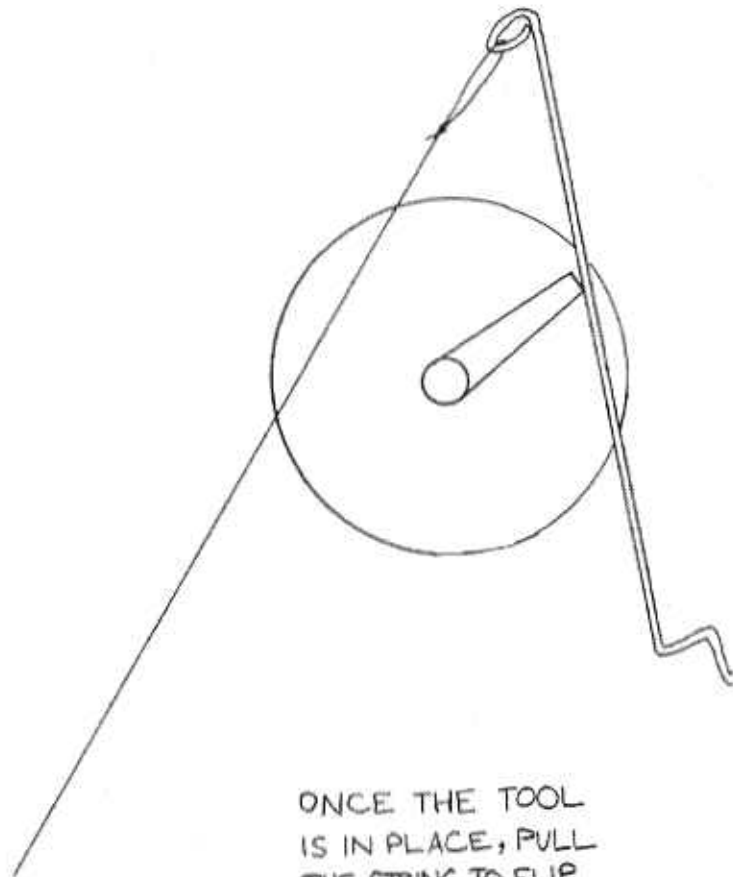
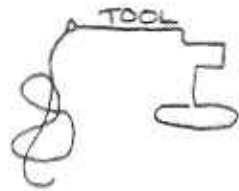

ONCE THE TOOL IS IN PLACE, PULL THE STRING TO FLIP THE THUMBTURN

If you do not have space under the door to insert a wire tool, you may be able to open the door with a curved plastic strip and a string. The method will vary according to what type of thumbturn you have and how well you can see your target. After wrapping the string around the post, you may want to push it over with the plastic strip or remove the strip entirely and pull the looped string. Remember that if you pull too hard on the string against the plastic strip, the strip will snap at the hole. Work with this caution in mind.

Manipulating the actuator is another bypass option that will work with most deadbolts, unless they have a metal housing around the hole in the door the lock sits in. The object of this technique is to slip a screwdriver behind the lock and push back the lever that throws and retracts the bolt.

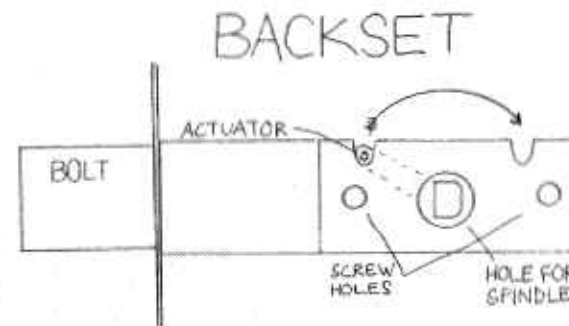

Screw holes will have screws through them holding the lock in place. They will get in your way and must be worked around.

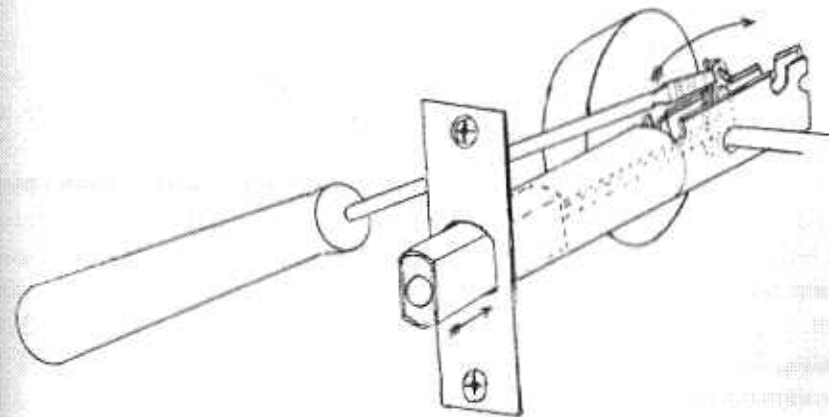

The latch mechanism, called the backset, has a hole for the spindle of the lock to go through. When the spindle is turned, it moves a lever, which has two resting positions and an arc in between. If you reach a tool under the lever and push it up through its arc to the retracted position, you're in.

Older doors and doors on rented property are often in poor repair and have not been maintained carefully. When people complain about the locks, sometimes they are changed out, and the new locks may not fit into the holes as well as the old ones did; there may be small drill holes left over or generally shoddy fittings. Check your doors and look for this. If there is any kind

of gap or jagged hole (large enough to fit a round toothpick into) at or near the edge of the deadbolt, it can be used as the entrance point for a tiny flathead screwdriver.

You may want to go to a hardware store and look at a deadbolt in its box so that you can see what this lever looks like; put the spindle into the backset and turn it to observe the motion of the lever. If you are competent enough to put a deadbolt back together, you could take the one off your door, but without precise instructions a lot of people have trouble placing the spindles and getting everything lined up straight, so this isn't recommended.

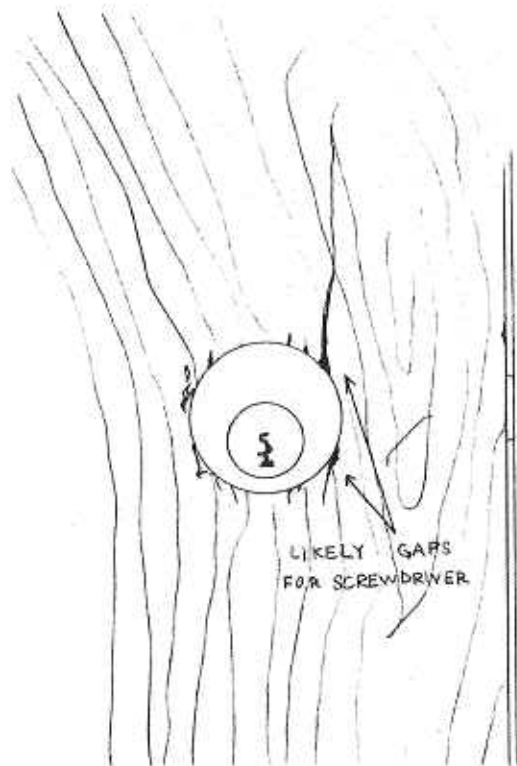

You may be able to shine a light into the hole behind the lock and see the actuator on the backset. What you have to do is push it up, out of the notch it rests in, and then push it over to the unlocked position. That's it.

Even if your door is in good shape and there are no holes or gaps to take advantage of, this may be the best route in if picking and other bypass options have failed and you need to get the door opened. If you drill a small hole at the edge of the deadbolt housing, angled toward the hole behind the bolt, you can use this method to get yourself in without doing any damage to the deadbolt. Afterward, you can putty the hole in the door or buy a rosette to fit behind the deadbolt housing and cover the hole that you made. A rosette will only cost a couple of dollars, which is considerably cheaper than the price of a deadbolt or a professional's fee to get you in.

PADLOCKS, CABINETS, AND MISCELLANEOUS

Padlocks are great to learn how to pick locks on, because they come in such a wide array of quality and difficulty. They are easy to carry around to be worked on in a convenient location, and wafer or pin varieties can be found.

When you're first learning to pick locks, you set the tension wrench, hold some pressure on it, stick the pick into the keyhole and wiggle it around a little. Usually it is a complete surprise when the cylinder first turns, and a common exclamation is, "I don't even know what I was doing!" Chances are that you didn't. You never have to be consciously aware of what's going on - you want your hands to do the work. With a padlock, when the shackle snaps open, you can congratulate yourself, close the lock, and work to pick it open again. After picking it open maybe 30 times, your hands will have developed a technique for dealing with that particular lock. At this point, when you attempt to pick the lock, you unconsciously employ a strategy to do so.

Once you have done this to five or six different locks, you will have a greater number of strategies you are proficient with. When tackling a new lock, you can apply them or combinations of them to attempt to open it. At this point, you know how to pick locks.

The unfortunate thing about padlocks is that there aren't reliable methods of bypassing them that don't entail destruction. Most of them can be picked, but that isn't a true bypass, since it makes the lock work as though it had a key. Bypassing it would mean maneuvering around or behind the lock, or perhaps removing it, in any case, avoiding it to open what it holds shut.

Pick keyed padlocks if you've lost your keys to them. Bump keys are also very effective in opening pin tumbler padlocks, if you go to the trouble of making a good one.

Some locks just won't pick, either because they are specially designed not to or because of the length, type, or arrangement of the pins. If you can't pick your padlock, there are a couple of options you may want to try before destroying it.

In theory one could shim the shackle. The shackle is the part of the lock that pops up when you turn the key, as opposed to the lock body. Open a padlock and look at the shackle. It will have a hook in it for a lever or ball bearing to slip in and hold it shut. That is the latch. Some padlocks have notches at each end of the shackle. In very rare cases, a shim can be inserted between the shackle and the housing to separate the

latch from the hook. After pushing the shim in as far as it will go, jerk sharply to pop the shackle out. Some supply outfits even sell shims made for this. You could make a shim from a strip of aluminum can, a feeler gauge, or a piece of plastic, but it is doubtful this will work for you. Although it's an interesting idea, it very rarely pans out in the real world.

In special cases, shims can be of use. On some of the cheapest imported locks, the cylinder plug does not have a face cap larger than the diameter of the cylinder. Perhaps your luggage padlocks look like this. If they are built this way, you can look at the shear line simply by looking at the bottom of the lock. If you look closely under a good light, you should be able to see where the first pin sticks through. These locks are easy to open. Stick a bit of soda can just above the keyway at the shear line. When it butts up against the first pin, push the first pin slowly upward with a pick. When the junction between the top and bottom pins hits the shear line, if you are pushing the shim it will slide further in, separating the top pin from the bottom pin. Do this to the second, third, etc. until the shear line is clear of pins. Then you may turn the cylinder without difficulty.

DECIPHERING COMBINATION LOCKS

This is more helpful to remember combinations than it is to determine them. The common, locker style combination lock may be deciphered by someone patient and methodical.

There are three wheels inside the average combo padlock, and each wheel has a deep notch cut into it. If these three notches line up under the release so it has a place to fall, the lock may be pulled open. The wheel closest to the number dial is the last number in the combination. Instead of having only one notch cut into its face, it has twelve. Eleven of them are shallow and one of them is deep, the real one. All of these notches are regularly spaced. For instance, $1\frac{1}{2}$, 5, 8, $11\frac{1}{2}$, 15, 18, $21\frac{1}{2}$, 25, 28, $31\frac{1}{2}$, 35, and 38 might be the placement of the notches. To check this, pull the shackle away from the body and hold it there, then turn the number wheel. It will get stuck when the release latch falls into any of those notches. Once it is stuck, check for play and write down the range that the dial could move when stuck in the notch. Once the latch is stuck in the notch behind number five, say you can still wiggle the dial between 5 and 6. If one goes from $7\frac{1}{2}$ to 9, write that down. Once all twelve ranges for those notches are written down, examine them for inconsistencies. If all the numbers ending in five have a range of 5-6 (5-6, 15-16, 25-26, 35-

36), then you can throw out those numbers, for they all fall in shallow notches. If the next series is $8\text{-}8\frac{1}{2}$, $17\frac{1}{2}\text{-}18\frac{1}{2}$, $27\frac{1}{2}\text{-}28\frac{1}{2}$, and $37\frac{1}{2}\text{-}38\frac{1}{2}$, you have found your culprit, the number 8. This is the last number, since its range of play differs due to the depth of the notch.

Once you have the last number, the possibilities may be narrowed considerably. The other numbers are mathematically related to it. Take the last number and divide it by four. Only the remainder is important. For instance, if the last number was 8, $8/4=2$, exactly, with no remainder, so the remainder is zero. If the last number was 23, $23/4=5$, with a remainder of three. **The first and last numbers share the same remainder.**

So, if the last number is 8, the first number is another number that, when divided by four, has no remainder, like 4, 8, 12, 16, 20, 24, 28, 32, 36, or 40.

The remainder of the middle number is two numbers over from the remainder of the last number. So, if the last number was 8 (eight is only being used as an example, the last number, obviously, is different in different locks), the middle number's remainder is going to be two numbers over from the last number's remainder, which is zero. So the middle number could be 2, 6, 10, 14, 18, 22, 26, 30, 34, or 38.

Oh, great! That leaves one hundred possibilities. At this point, the next step is to run through all of them or something equally absurd, right?

Well, yes. It isn't a very big deal. Running all 100 combos will only take several minutes. So long as the last number was correctly designated, it won't take long to open the lock.

THREE OR FOUR DIAL COMBINATION LOCKS

Locks with wheels lined up side by side that you dial a several digit number into will divulge their combinations to the careful observer. Each of those numbered wheels has a hub (like a car's hubcap) that is round with one flat face. These hubs are inside the body of the lock. The flat spots have to all be lined up under the latch for the lock to open.

You must look closely under bright light to observe the flat spot alongside each numbered wheel by peering into the crack along the edge of the numbers. Turn one of the wheels a complete revolution, and note if there is any irregularity to the side of one of the numbers. When you have found it, move to the next wheel and do the same thing, then the next. Once these points are lined up so they are even, you need to move them into place so that the latch can drop in. The numbers you have just

found are not the combination. They are the numbers that belong to the latch, not the numbers that must be in the viewing position for the lock to open. For instance, if you can see the irregularities when the combination reads 111, you have to rotate that combination so that it lines up with the latch. Move them all up a space (in this case, so that it reads 222) and try the lock. If it does not open, move them up another space and try again. Do this until the numbers you first determined reach the drop-in point. The lock will pop open when you do, and the combination will be in place for you to read.

Although you can see the hub alongside the wheels of some locks, others may have to be probed. A small, rectangular probe cut from an aluminum soda can is thin enough to slip beside the wheel and rest on the hub. You will feel when you hit the irregularity.

The cheaper locks of this type may be opened by feel. Usually, the last wheel you turn is closest to the shackle. By trying to pull open the lock, holding it in that position, and then turning the wheel, you may feel the irregularity as you pass the correct number. A frequent mistake is to identify one number over from the real one, as the wheel falls into the groove easily but will not come out as easily. With this method, you do not need to rotate the group once the combo has been reached – it will just pull open.

The conventional ways of cutting and forcing padlocks, due to the nature of the procedures, are not within the intended scope of this work.

It may be easier to disassemble whatever the padlock is holding shut than to destroy the lock if you cannot open it. If you're likely to run across your keys again in the near future, or if they are locked into the box or cupboard the padlock is holding shut, it may be easier (and cheaper to replace) if you cut the link of chain or the hasp the lock is held to.

CABINETS

Cabinet keys are lost frequently since they are not often on your primary key ring. Usually, a cabinet is held shut with a cam lock, and most of these are very inexpensive and easy to pick. It is important to remember that they only pick one direction to open – you can spend pointless, wasted minutes trying to pick it in the other direction. Another feature of most cam locks is that they will lock in the open position, so if you turn the lock 90 degrees, you will have to pick the lock to reverse it

and close it up again. Usually, turning it 60 or 70 degrees is enough to open the cupboard.

If the lock is on one cupboard where two cupboard doors come together, you may be able to open them both without picking the lock. Often, one cupboard has a hook and latch mechanism to connect it to the cabinet frame or shelf, and the cam lock drops the tailpiece behind this secured cupboard. By tripping the latch with a butter knife or a bit of wire, you can pull open both cupboards at once.

Well made cabinets have hinges on the inside of the cupboard, but not so many are well made these days. Unscrewing the hinges can be a fast way in.

Sometimes a drawer above does not lock, and by removing it you can reach inside and gain access to the cupboard. If what you need is on a lower shelf inside, you may be able to reach the back of the lock instead. If so, with pliers or a wrench you can unscrew the nut from the very back of the lock, and the tailpiece should fall off. It would be less trouble to release the hook and latch mechanism of a second cupboard, if there were one. They are often found at the top edge of the cupboard.

DRAWERS

Locking drawers may have a cam lock or a spring-return latch like the kind on a door's knobset. If you encounter the latter, slipping the latch with a wire should open the lock. Drawer locks are often cheap and, if so, may be picked open fairly easily. If you can't pick it, there may be some alternatives.

The people who build desks enjoy installing clever devices. Sometimes a top drawer must be pulled out for the others to open, so it will be the only one with a lock. There may be a release lever inside one drawer that, when pressed and held, will allow you to pull open another drawer. Old desks often have secret drawers. Just looking at the desk as a kind of puzzle may help reveal subtle facts about its design and operation.

Drawers below kitchen countertops may sometimes be accessed by lifting the countertop off. Obviously, this is only for special situations where the countertop isn't attached to the wall, is small enough to move, and is not nailed on well or is held by only a few staples. Sometimes the manufacturers use glue that does not hold up well to moisture, and years of sitting next to the dishwasher or sink may have turned the countertop into a mere lid.

HINGES

Sometimes a box may have a simple lock that is not a pin tumbler or wafer lock but of a sort that takes a flat key or handcuff style key. If you have lost the key and cannot find something of a similar shape to try in the lock, you might pull the hinge pins. A piano style hinge looks like this:

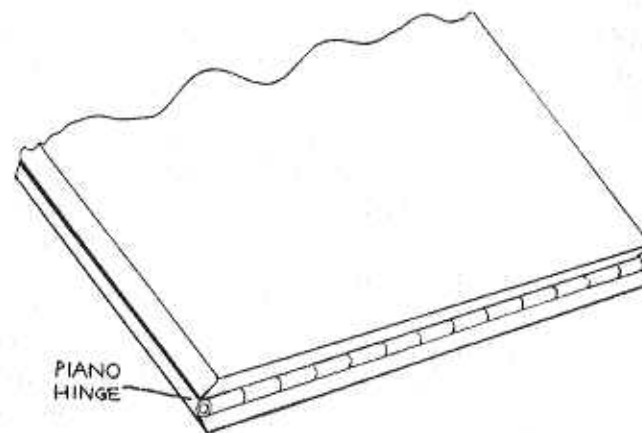

With a hammer and a punch the pin can be started out the other side, then pulled with a pair of pliers. Be careful with it, and it will go back in easily when you put the box back together.

Hinges on doors can be a bit trickier. If you can't open the lock, removing the hinge pins allows you to take the door out of the frame to get inside. You must be careful to hold the door in place until all the hinge pins are out so the hinges don't warp and the door doesn't crack. Once they are out, the door must be taken out by swinging it as if the hinges were the latch until the hinged edge is past the sill. Then the door must be slid out sideways so the latch won't be damaged in the strike. This isn't too easy because the door wasn't designed for it there isn't a handle on the hinged side of the door. Putting the door back together can be difficult, too. This is the kind of thing that can be dangerous and is best done with two or more people. If there is a screen door in front of it, the screen door must be removed to make room to remove the door.

Tapping out the hinge pins can be accomplished with a screwdriver or chisel and a hammer. Armored hinge pins should be left alone. It

should be pretty obvious if you have these hinges. They're big. **IF YOU HAVE A HINGE WITH A SPRING IN IT TO SWING THE DOOR CLOSED, LEAVE IT ENTIRELY ALONE.** You can be blinded, maimed, or killed if you release the coiled spring. Self-closing doors without a visible door closer at the top may have this kind of hinge. If in doubt at all, don't touch it. Disassembling these hinges is extremely dangerous.

FILE CABINETS

File cabinets often use locks that can be picked clockwise. The cabinets themselves vary in price and quality from thirty dollars to several thousand for fire-safe, pick-proof models. Some of them may be gotten into by credit carding the latches, reaching the release lever from the inside space of a removed drawer, or separating the latch from the catch by prying slightly. Older and cheaper locks can be opened by reaching through the keyhole with a tiny screwdriver or a pick to the back of the lock, behind the pins, and pushing with downward, diagonal pressure.

Sometimes file cabinets don't open when they should. If the key won't unlock them, try tapping down on the keyed side of the cabinet with a block of wood or a mallet. It may spring a bound-up release rod. Once one of these rods binds up, it is likely to happen again, so you should consider replacing it.

SLIDING DOOR CABINETS

Some cabinets have sliding wooden or glass panels held closed with a small lock. If you can't pick the lock, there are possible means of bypassing it. One trick is to lift a panel completely out. Grab the edges of both sides of a panel, and lift straight up so the panel goes all the way into the upper sliding channel. Tilt the bottom of the panel outward just enough to clear the sill and gently lower the panel out and to the floor. When working with a glass panel, if you do it at all, there are a number of safety precautions you should take. Wear safety glasses. If a panel breaks, you do not want your eyes damaged by a splinter of glass. Check the edges of the panel to make sure they are smooth and rounded. If not, you will not be able to use this method, because you have to grab those edges. Do not remove a glass panel that is at or above the level of your head. Glass is dense, so it is very heavy. You aren't likely to feel how heavy it is just by lifting it up in the channel, but you will when you tilt the bottom

edge slightly to remove it. It will want to keep tilting, and you may not have a good grip on the edge. You do not want it to break against your head. Working with glass is dangerous, and you do so at your own risk. Take as many precautions as possible to insure your safety. Do not try to lift a tall or wide piece of glass. You may not be able to control it.

Another method may work if there is a large sliding panel held in place with a small sliding lock. If the lock may be moved up the edge of the panel, move it to the middle. Then bow the door out, so it bends around the lock, and slide it open. Again, this is risky and dangerous if the door is a glass panel, and should only be considered if it is a tall panel of framed and tempered glass. Even then, it is possible to break it. If you attempt this method, use extreme caution. If you can't find your keys, it is usually a better idea to wait for someone who does if you can't pick the lock.

U BOLT BICYCLE LOCKS

If you own one of these, it is likely the best lock you have. People lock up their bicycles much better than their homes. The average U bolt lock has a tubular lock, which uses a key that is round and has grooves cut to different lengths around the outside edge of it.

A tubular lock is like a bicycle wheel with sticks through the spokes. This kind of lock can't turn until the pins are pushed out, and they're different lengths. These cannot be opened with regular lock picks. It is difficult to open one using a tubular pick designed for them. A makeshift pick cannot easily be made from scrounged materials.

There is no way to bypass one of these locks that does not involve destroying it. This book is not intended to explain irreversibly destructive methods. It is important not to lose your keys to your bicycle lock.

One thing you can do is write the code down. On the original keys there should be stamped a series of numbers and letters. Get the keys. It is probably best to do this right now while you're thinking of it. Write the series down here or some other place you know you can find it, along with the name of the manufacturer and the model of the lock. If you lose your keys and you have this code number, a locksmith can use it to make a new key for you cheaply and easily.

HANDCUFFS

If you own these, put one key on your primary key ring. Cuffs come with two keys, and there is no reason to keep them together. Check to see if you have the police style or some other. Handcuffs can be very bothersome to get out of given the situations people awkwardly put themselves into, and being locked up is inevitably the result of someone's stupidity and irresponsibility.

A good pair of handcuffs are double locking. That means that, in addition to the latch that clamps the bracelet to your wrist, there is a pin which can be set to prevent that latch from moving. The first latch engages automatically as you close the cuffs. The locking pin that freezes the first latch must be moved into the place with the key, and people usually do not go to the trouble to set it. You cannot slip the latch before resetting the pin. Opening standard handcuffs when they are merely latched is child's play, and resetting the pin isn't too difficult.

The latch automatically engages the teeth on the outside edge of the bracelet. It does so because the latch is basically a series of teeth on a lever that is held against the bracelet with a spring. When the key is turned in the lock, it retracts the latch so that it is no longer in contact with the teeth on the bracelet.

To open the bracelet all you must do is disengage the latch from the teeth on the bracelet cuff. You don't need to do it the way the key does. All you have to do is slip a thin bit of metal in where the teeth of the latch and the bracelet meet. Push it in the same way that the bracelet goes in, and the latch will retract to accept it but will have nothing to grab. Keep the strip of metal in front of the latch, and the bracelet will open right up.

To avoid difficulties, keep the bit of metal right in line with the outer points of the teeth, so that the tip of it doesn't get caught in a notch and fail to reach the target. Be sure to push it far enough in that it gets between the latch and the bracelet, not just partway. Also, hold it in while opening the cuff, because as soon as the strip comes out, the latch will

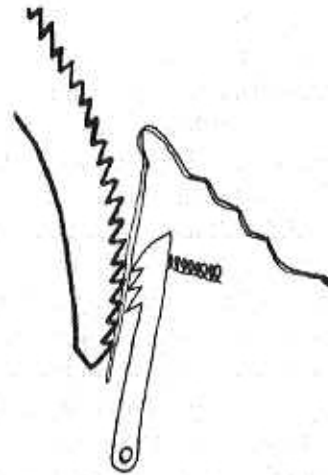

pop back into position behind the next tooth in line, and you will only have opened it a couple of notches.

A bobby pin is an excellent tool to do this with. Pull or scrape the plastic tip off of the straight end and open the bend somewhat. Shove the straight end down into the gap, sliding down the bracelet. You have to overcome some resistance from the spring of the latch, just as the cuff must as it is being closed. When the tool is in far enough, the cuff will open right up.

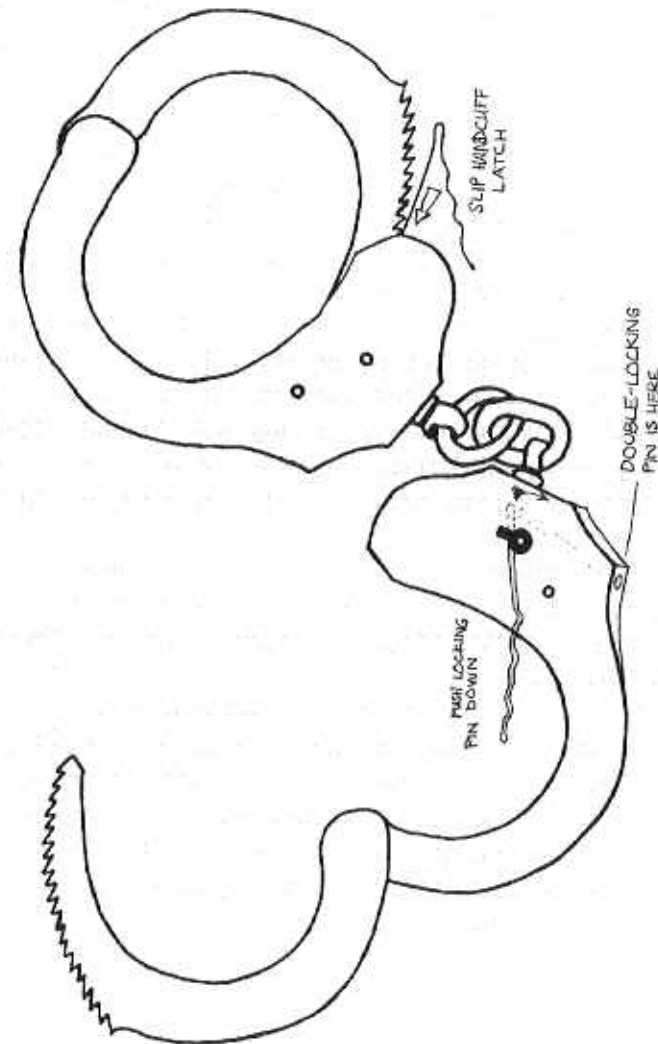

AUTOMOBILES

If the handcuff locking pin is in position, you won't be able to jam anything into the gap because the latch will not move out of the way to allow it. You must first push the locking pin out of the way through the keyhole.

At the bottom of the body of the cuff is a hole. If you peer into it, you will see some metal recessed a bit from the opening. That is the pin. A police handcuff key is shaped the way it is so that the point on the back end can be used to push this lock into position. It doesn't move very far when it is pushed. Under normal circumstances, when handcuffs are opened with a key, the key is inserted into the keyhole, turned one way to push the locking pin back into place, then turned the other way to retract the latch. It is easy to push the pin back, but it takes some torque to work the latch from the keyway.

The pin can be pushed back with a bobby pin, street sweeper bristle, curling roller pin, safety pin - whatever you can slip in there. The object is to put the tip up high under the edge of the keyway and lever it to push down the pin. It is really easy to do. Put the tip of the tool into the keyway at the far end from the hole for the locking pin. Tilt it so it reaches under the opening, so that you can't see the tip. Then lever it toward the hole for the locking pin. If you catch it, you should be able to feel it go. If you've tried the wrong side, just try the other side. Use a bobby pin like a knife blade, not like an oar, so that it will push instead of bend. You want it to move like the hand of a clock, sweeping down to push the pin out of the way. A visual check of the pin should tell you if you've succeeded, or you could find out by trying to open the latch by jamming your tool into the catch.

Cheaper handcuffs, the kind you are likely to find at novelty stores, can be opened up with a bobby pin sweeping in the direction the key must go to release the cuffs, or by shimmying the latch, if they are built in such a fashion.

If the cuffs are behind your back, the easiest way to fiddle with them is to sit down and work your hands down behind your knees. If you have short arms or wide hips this may not be possible. Trying to get cuffs around in front can be a laborious process and certainly isn't necessary if you're only trying to open them. You can see just fine between your legs, and if you know how and have had a bit of practice you can take off a pair of cuffs without keys in moments.

If you own an automobile, you should have a spare set of keys in a safe place. That way, if you lose your keys or lock them into your car, you have an easy way to open the vehicle up. If you've failed to do this, you may be able to call your car company's roadside assistance program or have the vehicle opened up for free if you are a member of a car club or have towing insurance. There are excellent conventional alternatives to bypassing the lock that are free of cost and risk.

Do not break your car window. It is cheaper to have the car professionally opened. If you absolutely must break a window, break the passenger's window that rolls up and down. It is the easiest one to replace, and the least costly.

If you're locked out of your vehicle, you might try picking the lock. More and more cars are being built these days with pick-resistant or high-security locks, but the majority of cars still have normal locks and may yield to your efforts. Outside locks have dust shutters on them to keep the grit out. Inserting a tension wrench and turning it in a normal fashion will hold open a dust shutter and allow you to move your pick freely inside the lock. If you can't get one lock or another to open in a fifteen minute period, abandon your picking efforts and consider a bypass. This way you will waste a minimum of time. Picking is a great method of entry (when it works!) because it does not imperil the mechanical functioning of the car more than an infinitesimal degree. The difficulties you might have could include a broken pick inside the lock or a bent shutter from forcing the tension wrench. Avoiding gross negligence should eliminate these possibilities.

When picking an automobile lock, it is usually a good idea to work the driver's door, because you know which way to turn the key to unlock it. Often, the passenger door is reversed, and it can be frustrating to pick the lock the wrong direction. You may have trouble turning the lock when it is past the shear line due to the added burden of moving the linkage rods and indicator button, so a second tension wrench or other stiff turning device may be helpful in turning the lock once it has been picked. If you are picking into your trunk or hatch, almost all of them open by turning clockwise. Locks may not share all the same tumblers. For instance, the trunk lock may only use the first half of the key and the door lock the second half if the key is long. This will make certain locks easier to pick than others on the same vehicle.

If your vehicle has a wing window, this is an easy entrance point for an opening tool. A wire tool can be pushed corner first between the rubber seal and the glass at the bottom of the window, and can be used to hold the locking button in and turn the latch. Once the wing window is unlocked, it can be pushed open, and you can reach inside to work the door release lever, lock button, or electric lock switch. If you cannot hold the button and turn the latch with a single tool, two tools aren't much tougher to handle. If you cannot reach the unlocking button through the open wing window, you can usually reach it using the tool. A bucket handle can easily be modified to serve as a wing window bypass tool.

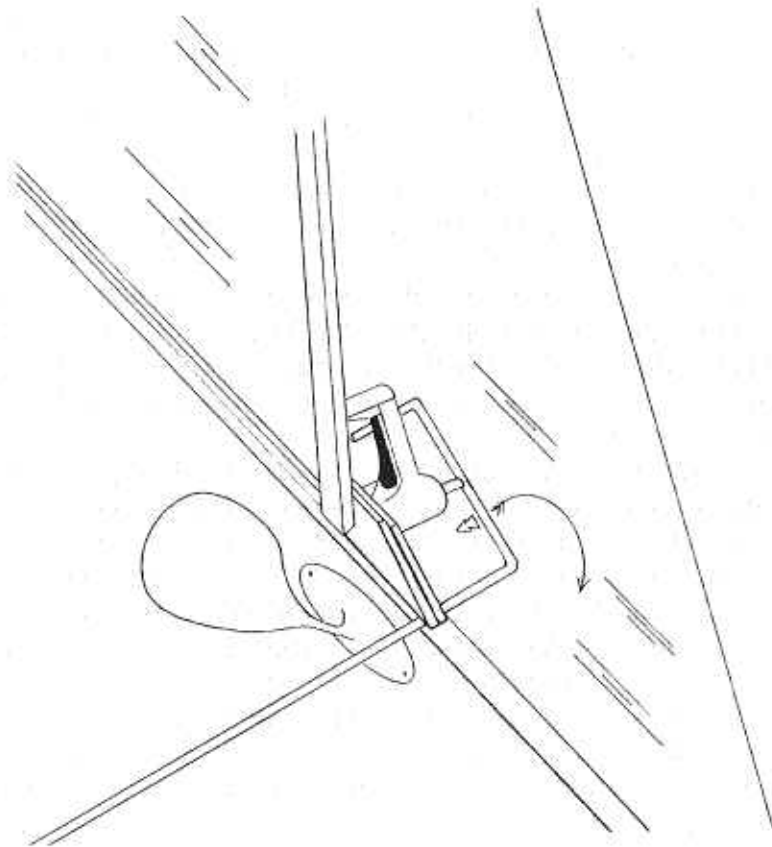

Many trucks have sliding rear windows. The old ones can be opened with a pocketknife, but most of the new ones have a tongue and groove fitting to prevent direct entry. However, the outside edges of the sliding windows have no similar protection. They will have some synthetic felt to keep the weather out, but a thin tool may slide through the gap and run next to the window toward the sides of the cab.

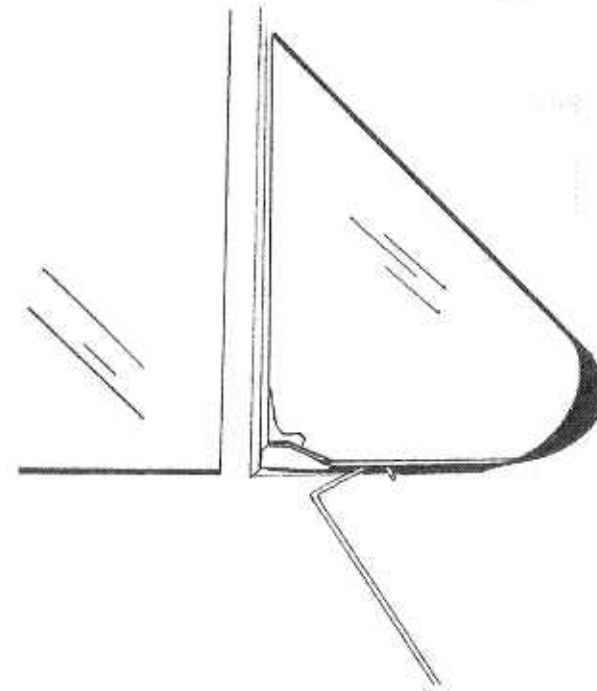

A thin piece of wire may be doubled over and a short hook bent into one end. This may be slid through the window gap. It must be pushed in with a stiff, flat tool like steel lumber banding or a flimsy second hand kitchen knife. Be careful not to scratch any tinting on the inside of your window. Once the hook has been passed through, the tool is rotated 90 degrees (so the hook is facing you instead of being vertical) and pulled back toward the center of the window, this time with the hook inside the cab. With some adjustment both at the point where the wire enters the cab and at the handle of the tool, the hook can be made to catch the latch. Pushing with the flat, stiff tool again, you can use the wire to depress the latch button and slide the window open.



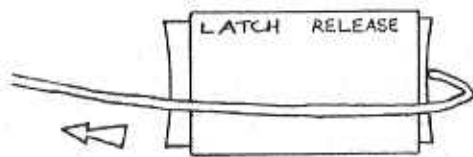
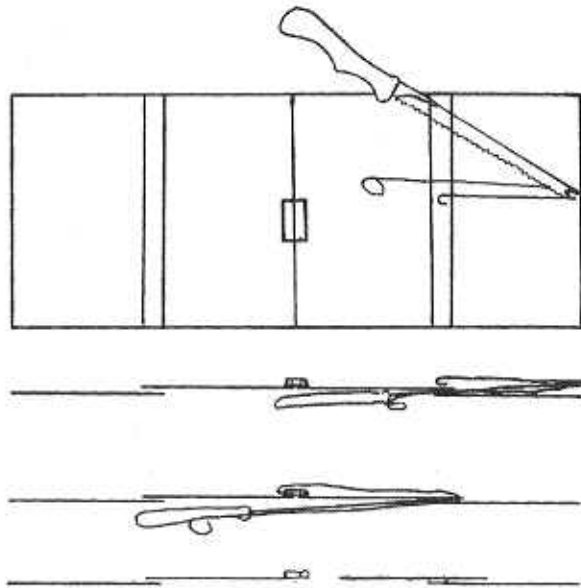

A plastic strip and a string can be used to open up automobiles, especially those with vertical button locks. Cars with frameless windows are the easiest kind to get the tool into, but perseverance and a reasonably stiff piece of plastic will allow a tool to be guided between the car's door frame and the cab body. If you are clumsy and unlucky and cannot worm the strip through, and you have no other available options, you may wedge the top of the door frame. This presents a possible danger of bending the door frame, if it is wedged too far, or shattering the window; be alert and work gently. A clean shim of hard wood or plastic works best, fitted into the gap between door and cab body at the upper back, pried just enough to slip the tool in, and then released when the tool is in position. If the car has a vertical lock with a button on the top, the tool can be fed into the

cab of the vehicle, the string pulled to bow the tool against the side-window glass, the tool tilted and guided around the button, and the piece of plastic carefully retracted. This should leave the string looped around the button and both ends of the string outside the vehicle. Pulling diagonally upward will lift the button, unless the string slips off. Tying a slip knot in a wide loop of string can overcome this problem.

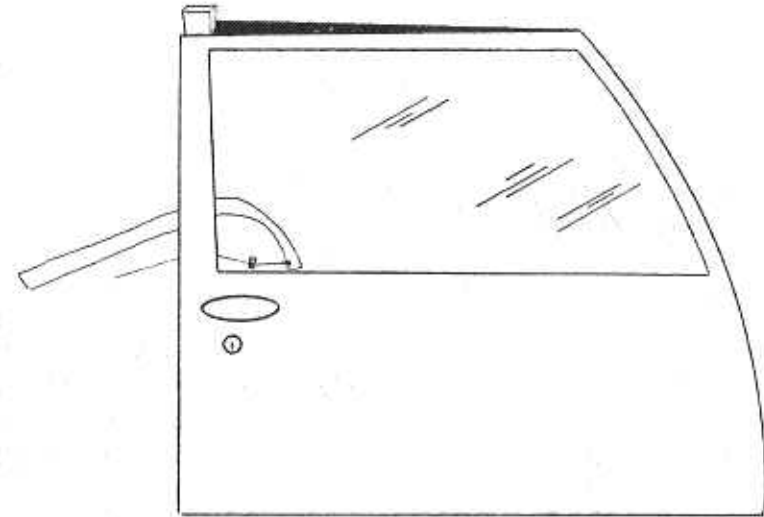

There are other possible targets for this tool. If the lever that opens the door can be activated when the door is locked, catching and pulling it may be worthwhile if your string is strong enough and you catch it far enough out on the lever to have a decent mechanical advantage. Another target would be the electric lock button. Bumping it with the plastic strip can easily unlock the car. The wing window and door frame are good entrance points for this. The last target for the plastic strip and string tool is the window crank. This won't get you in by itself, but it may open the window enough for you to lower a tool in to catch the lock lever and move it.

The use of brake tubing is a sketchy and last resort type of entry, but if done carefully shouldn't result in much damage – perhaps only a chewed up bit of weather stripping. Brake tubing is a hollow metal rod that you can buy in straight lengths at automotive supply places. You can bend it easily into different shapes without kinking it, and it can be fed into the cab at the edge of the door frame. This requires you to wedge the

door to an uncomfortable degree to allow the tubing to pass. The flanged end should be cut off to lessen the gap you need to pry the door, but that will leave a sharp edge. Inserting a cardboard toilet paper tube into the gap first and feeding the brake line through it will reduce the risk of chipping paint and tearing the rubber seal. Before bending the rod, slide a string through and tie a loop or slip knot at the end. The rod can be bent into a shape that reaches the door unlocking device, which is then looped with the string and pulled to open.

Electrician's fish tape is a better alternative and may be bought at electrical supply stores. It is not sticky and is not used to hold things together. It is flat spring



steel wire used to fish around in walls for wires or to push wires through conduit. A hook bent into one end will allow a piece to serve the same purpose as brake line, but fish tape is also capable of unlocking an indicator lever for a horizontal linkage. It is slimmer and does not require the door to be wedged as far.

Door locks have tailpieces, which are levers that stick off the back end of the lock and turn when the key turns. These tailpieces may either go right to the latch at the edge of the door or be connected to the latch by a heavy wire, called a linkage rod. Another linkage rod connects the button or indicator lever inside the cab. Yet another linkage rod connects the door handle to open the vehicle door up when the door is unlocked. The target is usually the latch or the linkage rod connected to the inside lock and unlock button or lever. Some vehicles have a bell crank, a little teeter-totter kind of lever used when linkage rods change direction or connect to the latch. On many automobiles, some or all of these mechanisms are shielded to prevent them from being tampered with to open the vehicle. Only some of these shieldings are successful.

A lot of vehicles have electric locks. It isn't any harder to open these than it is to open manual locks. You can go about it exactly the same way. Electric locks still have mechanical components, and those are not hindered or held into place by the electric switch.

The other methods mentioned here involve reaching into the car's hidden mechanical recesses and monkeying around. Though very success-

ful when properly executed, linkage damage can result from careless attempts. It is also easy to tangle a tool in the window roller assembly or stereo wires, so work cautiously. You always work at your own risk, so stay away from these methods if you do not feel comfortable with them.

GUIDELINES FOR ENTERING DOOR CAVITIES

- Only work on one side of the vehicle. If you screw up enough, you can knock all the linkages loose from their plastic connectors and there will be no way to manipulate them to get in. If you work on both sides of the car and fail to gain entry, you may leave no route for the professional you call to open it, meaning that you will have to break a window. If you call a locksmith to open your vehicle after you've tried, immediately let the person know which side of the vehicle you worked on. That can prevent wasted effort, and he or she can repair what you've messed up.
- Know what the particular linkage of your car looks like and where it is located. Usually this involves taking off the inside door panel of the car and looking. You have to detach the window crank, door-opening assembly, stereo speakers, armrests, screws, snap fasteners, and plastic film to do this. It can be involved or tricky, but having an exact idea of what kind of linkage you have, where it can be accessed, and what else is in the way (for example, the window crank assembly or structural steel) will greatly increase your odds of opening the vehicle easily and without damage. It is hard to see very much between the window and the door, where you place tools. Often, with a light you can recognize a linkage from that position, but it is much easier to recognize something you're familiar with than it is to identify a strange setup in poor light. If removing the door panel is something you're uncomfortable doing yourself (there are things you can break when doing so), you might want to have it done by the people who do it all the time – car stereo installers, mechanics, and locksmiths.
- If you are going to stick a tool between the window and the door, use a wedge, even if the tool is flat. This will prevent the metal tool from pressing hard against the window and lessen the chance of the window breaking. It also reduces or eliminates friction on the tool at the entrance point, allowing it to move more freely and let you feel what is going on in there and guide the tool.
- The easiest way to insert a wedge between a car door and the window is to start by slipping a flat piece of plastic between the window and

the rubber weather strip. A piece of plastic bottle is an excellent choice for this. You may want to slip two pieces of plastic into the same place if you are worried about the material of the wedge scratching the glass.

- Next, insert the wedge (a rubber doorstop makes an excellent wedge, as would a paint-stirring stick, the corner of your wallet, a folded magazine – anything that won't scratch the glass and isn't likely to fall into the door cavity) between the plastic strip and the window. The plastic acts as a guide and prevents the weather strip from getting munched. Push the wedge in until you have a gap big enough to insert your tool. Under no circumstances do you want a gap bigger than a quarter inch between the door and the window. You want to flex the metal of the door a little bit, not permanently bend it. If the weather is freezing cold, you may not want to use this method at all, because glass is more brittle then and could break when pressure is put on it.
- Clean the bottom edge of the window beneath the top of the door. You can use a napkin or a handkerchief folded around a pocket comb or a linkage tool. The reason you do this is so that you can see through the glass inside the door cavity and better locate the linkage rods. Because this portion of the window is always below the door and never gets washed, it is usually filthy. Once it is clean, you can use a flashlight to shine through it and illuminate the door cavity. You may be able to spot the linkage with the light, or at least identify things to avoid, like electrical wires or window rollers. Watching the tool will help you guide it to its destination.
- Generally, the best place to insert and work the tool is directly above the midpoint of the outside door handle. You are less likely to run into interference from non lock-related components, and you're close to the latch if you decide to trip the mechanism there.
- Sometimes vehicles have guards to prevent tools from entering. Often, they don't extend to the rear corner of the window, so this is a good place to work the tool down into the door cavity. Once it is lowered down, it can be slid over into position if necessary.
- Trucks may have guards to prevent flat tools from entering. These can be circumvented by bending a plastic strip in a J and slipping it into the gap between the window and the door, with the curve of the J pointed toward you. Then the opening tool, bent in a J toward the cab, can be slid in behind it without catching on the guard.
- Never ever ever ever force anything inside the door cavity. Don't force things in there. That is what breaks things. It does not require

force to move a linkage rod, only as much as twisting the key or working the inside button would take, often less. If things won't move for you, you need to get in a better position, further up or down on the linkage or at a different angle. If you get your tool caught, handle it gingerly. Pay close attention to how it feels and where it might be caught, and remove it carefully. Pulling hard could break things and is the best way to jam the tool even further. Loosely work it around and experiment to set it free. Be patient.

- Do not let go of a tool once you've stuck it in the door, even for a moment, even if it seems caught or stuck in place. If it falls into the door, it could get tangled up with everything else down there and cause many problems.
- If you land on a linkage, check to see if it is the right one. Often you will grab the latch release linkage, which won't open if the door is locked. If your tool is on the lock linkage and you wiggle the tool a little, you should see the lock button or lever move a little bit. You may not be in quite the right place to bind the rod and unlock the vehicle, but you're right on track and very close. If the inside handle that opens the door moves instead, you are on the wrong rod and should try beneath or above it for the lock rod.
- Once you unlock the vehicle, remove the tool, open the door, and get your keys. Remove the wedge and the strip. Once you have your keys, check to make sure everything still works – that you can lock, unlock, and open the door from the inside and outside, that the window still works, the speaker still plays, etc. If not, you should have it repaired.

TOOLS

VERTICAL LINKAGE GRABBERS

Flat car-opening tools are for unshielded vertical linkages – locks with posts that go up and down. Some foreign manufacturers put effective shields around their vertical linkages, but many auto companies still make vehicles susceptible to this kind of attack. These are very simple tools. It is a flat strip of metal anywhere from a half-inch to an inch and three-eighths wide, with notches cut into the sides to catch the rod.

The tool needs to be bent before it can perform usefully. It needs to intersect with the rod. If it is straight it will just run parallel to it instead. Bend the bottom of the tool into a J, and bend it hard enough that the J stays in place when you let go. Slip a bit of plastic between the

weather strip and the window and slide a wedge behind it to create a gap between the window and the door. It needn't be a wide gap – an eighth of an inch is fine. Then slide the tool down into the door, with the bottom of the J pointed in toward the cab of the vehicle. When it slides against the window it is going to unbend a little bit, but it will spring back once it gets inside the door cavity. Lower it down to about the level of the keyhole on the outside of the vehicle. Slant the tool so that it runs into the linkage rod. Hold some pressure against it and pull up the tool. When the notch grabs the rod, the button should pop up. Slide the tool away from the rod and pull it upward to get it out. Remove the wedge and plastic strip.

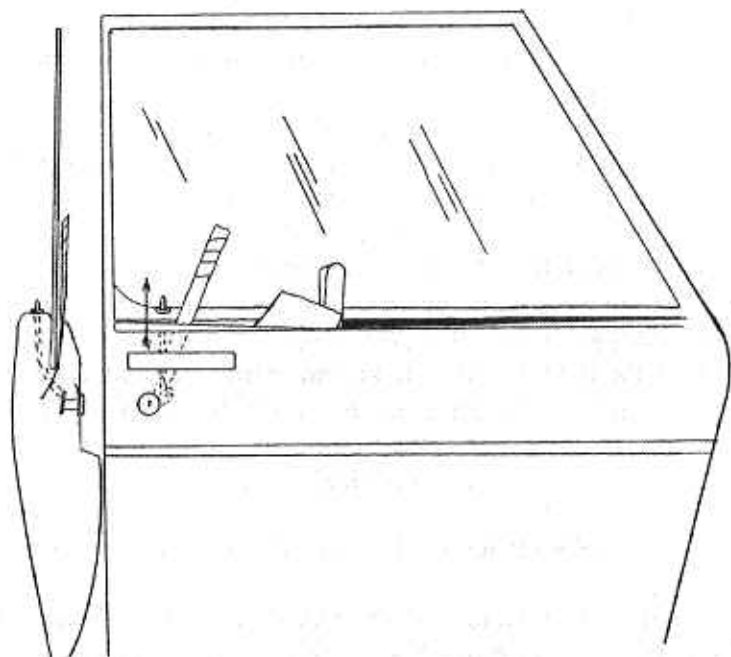

Bread knives with fine serrations make fabulous tools for opening vertical linkages. They already have a handle built in, and the teeth can bite against the linkage rod anywhere along the blade's length. These can easily be found at garage sales and junk shops (you want a cheap one with a thin blade) for less than a dollar.

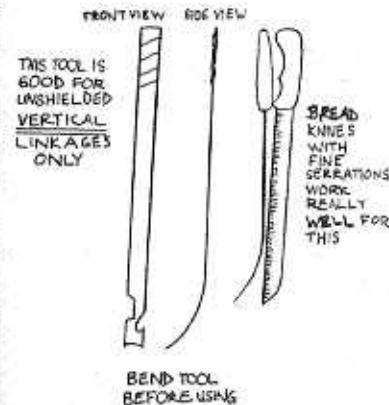

Steel strapping ribbon is another material suited for this application. See the **TOOL MAKING** chapter for information on modifying this and other scrounged materials.

BUTTON LIFTING TOOL

Sometimes the easiest way to lift the button of cars with vertical linkages is to reach underneath and push it up from inside the door cavity, pretty much the

same way you push the button down from inside the cab. All you need is a stiff wire with a U bent into it. The legs should only be a couple inches apart, and the working end should be about four to six inches long. Wedge the door, slip the tool down, and turn it so the end is under the button. It will probably take some probing to find a spot where you can access the underside of the button. Watch the button through the window of the car to see when it moves. Once you are under it, push it up. It's an easy way in if your vehicle is susceptible to this kind of attack.

A similar kind of attack may be made at the tailpiece where the bottom of the linkage rod connects. Bumping it from underneath with a longer handled tool is a very effective way to open many imported vehicles with vertical linkages. Shapes for this tool vary to reach where they need to, but the handle must be long enough to allow the tool to get below the tailpiece.

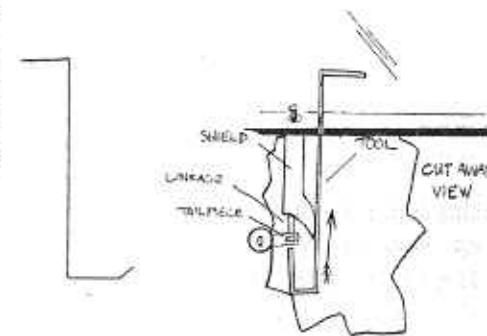

TO UNLOCK A VEHICLE WITH A VERTICAL LINKAGE

If your vehicle has a vertical locking rod that you can lift with your fingers, whether it is a mushroom-shaped button or the rectangular kind, this will open it. You need a long, flat strip of steel which can be taken from behind the rubber strip of a windshield wiper. Electrician's fish tape is another excellent choice. Bend a sharp check mark into one end of it, and place a long bend into the body of the tool, bending inward.



Wedge the top corner of the door. Pull the top of the door with your fingers, and wedge a pen, spine of a magazine, comb, wallet, or what have you into the gap. If you use two wedges, it is easy to wedge it wider without losing progress. Pry the corner open just enough to work the tool into the cab. Work the tool down toward the button, seesawing the tool into place. Be careful not to tear the weatherstripping. Capture the button in the crook at the tip of the tool and pull the tool out of the vehicle. It will bind the button and unlock the vehicle as it is pulled.

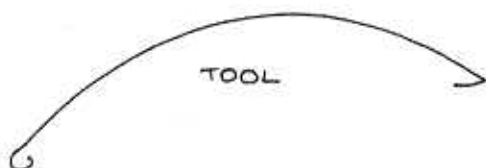
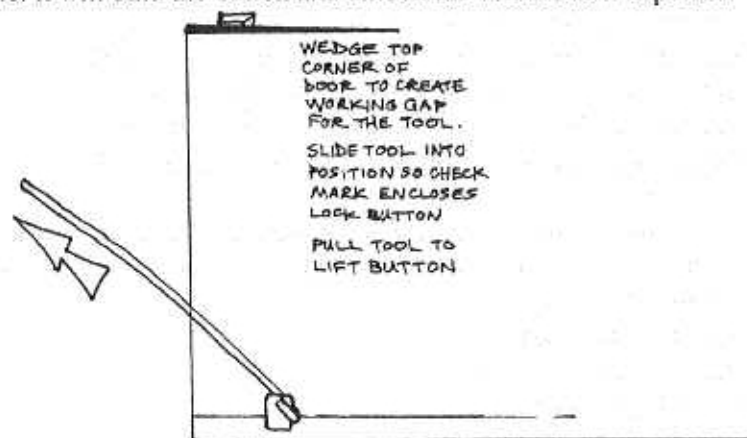

REACHING THE ELECTRIC UNLOCKING BUTTON

This is an effective way into most of the vehicles on the road. After wedging the top corner of the door, slide a long rod in to bump the rocker switch that unlocks the door from the inside of the vehicle. What generally holds people back from succeeding in this is their inability to find a long enough tool to reach the switch. A car antenna is too short to do this by itself, and that is the longest thing that can easily be found for the job.

To succeed with this bypass method, you need two antennas, a bucket handle, some cellophane tape (clear tape, the wide kind is best, but many kinds will do), and a couple of wedges that won't scratch or dent your car. You also need something to cut the ends off of the antennas. A file and pliers (score the wire deeply, then bend the wire at the notch to break the tip off) will do the trick if you don't have wire cutters that are beefy enough. Tape the two antennas together, overlapping the ends by about six inches. Do this very tightly and carefully, and it will easily be stiff enough to do the job. Don't use too much tape. Shape the bucket handle into a helper tool that can guide the tip of the long tool toward the button. The helper tool is primarily used to bend the long rod toward the button and stabilize the tool.



You should practice this method with the door open a half-inch or so, using the tools to click the button. You will have to bend the antennas into the right shape to easily reach the target. The handle ends of your tools must be at right angles to their length, or you will not be able to effectively control them. Make sure the taped joint is on the inside of the car, or it will get pulled apart from binding. Practicality

and watching while you experiment may be necessary to determine what shape of tool you need and how far to put it down for your particular vehicle. Once you know for sure, you will better be able to craft an effective tool if you've locked yourself out.

HORIZONTAL LINKAGES

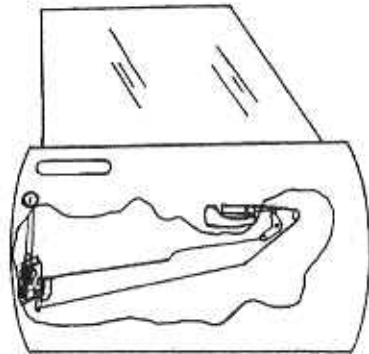

CUT AWAY VIEW OF CAR DOOR SHOWING LATCH AND LINKAGE RODS

These became popular around the mid-eighties and have become ever more prevalent since. The inside lock release is usually a lever that moves back and forth; it's often found in the same compartment as the door opening lever. The linkage runs horizontally back to the latch, hence the name. The type of tool used to open this kind of linkage is generally the same for many types of vehicles, and the technique is straightforward.

TO USE A LINKAGE TOOL

You must bind the rod you are targeting with the tool. After lowering the tool into the door cavity, rotate it so the tip points toward the cab of the car. When you land on a linkage, get the hooked portion of the tool around the linkage and twist the tool. This will bind the linkage rod and give you a grip on it. Then push the tool to slide the linkage backward or forward to unlock the door.

It can be tough to open a car with this type of linkage. The rods might be behind structural steel, making them difficult to reach. Often there will only be one opening, a few inches around, into which your tool must go. The shielded variety can present quite a challenge, offering only short gaps where the rod is vulnerable. Even the unshielded variety may be tough if it is high up in the door frame on the other side of the window.

Often, the latch release rod and the lock/unlock rod will be parallel, one above the other. It is important to identify which is which. Pressing lightly a few times on a linkage rod while watching the inside handle and lock lever closely will indicate this to you.

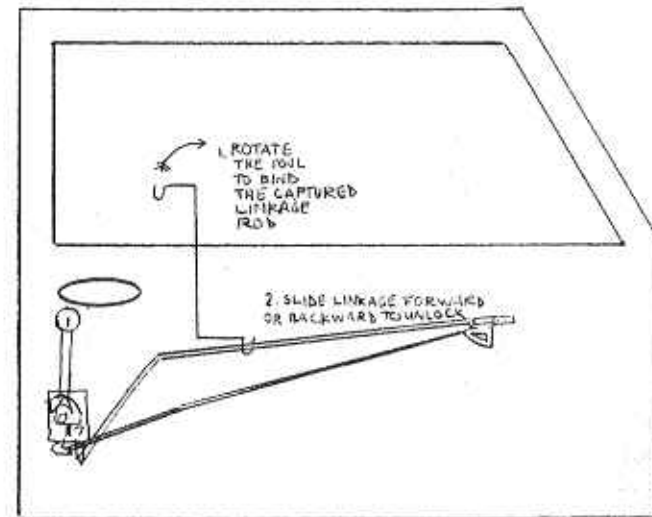
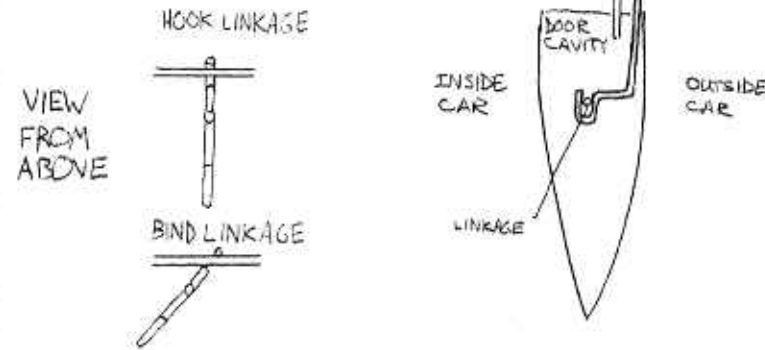

Rods can move forward or backward to unlock the door, and if there is a bell crank, sections of the rod may move different directions.

Try moving the rod lightly one way, then the other way if it doesn't flip the lock. Moving the tool up or down along the rod a little way may give you a better opening position. If you have the rod but can't move the lock, you may be on the wrong rod or on the rod's shielding. Usually, shielding only protects the most vulnerable areas along the rod and at times the rod may just be reached at one end or the other of a piece of shielding.

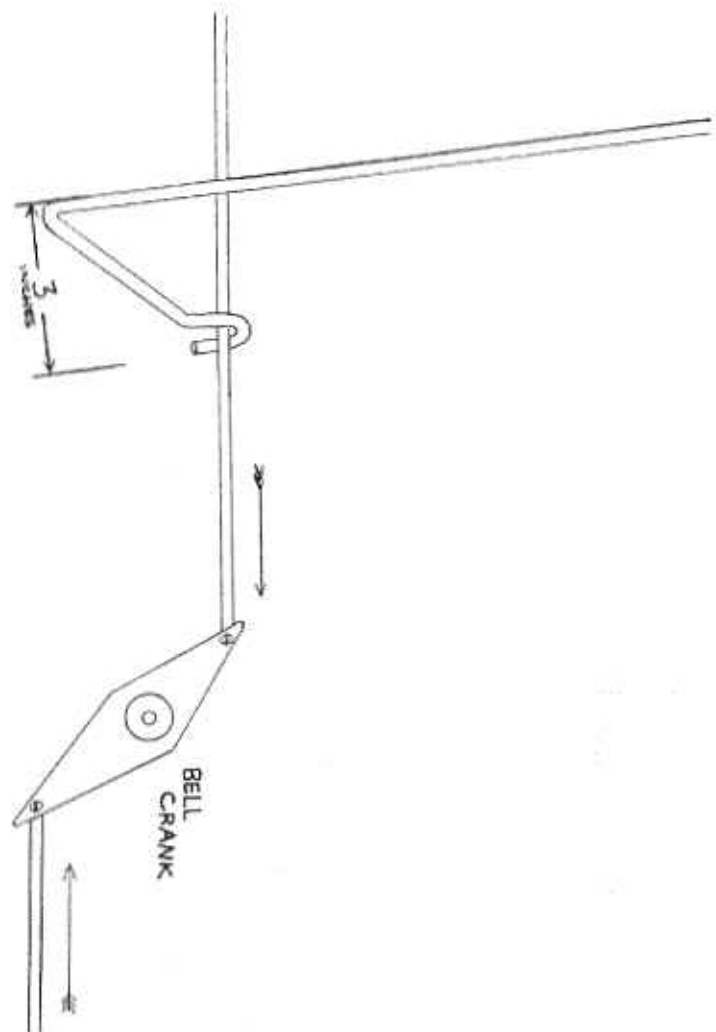

Accessing a bell crank and levering it is another way to open a vehicle. Horizontal linkages may have vertical sections next to the latch or the button.

Occasionally, a linkage will be well shielded but will have electric locks, and the solenoid is not shielded. A slight push on the solenoid will unlock the vehicle.

There are a few vehicles that can be opened by sticking a narrow tool into the gap at the hinge portion underneath the outside door handle. The linkage may be exposed and within reach.

UNDER THE WINDOW TOOL

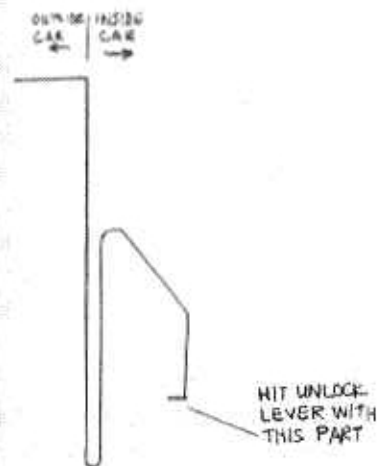

If you have a long enough piece of heavy steel wire to work with, you may be able to make a tool to go down into the door cavity, go under the window, and come up on the inside of the cab. This tool can be used to flip horizontal locking levers or hit the electric lock buttons of the car. To use it, you slide the tool between the door and the window, lower the tool opposite the inside lock button, so the inverted U shape is below the bottom edge of the window, rotate the tool

in slightly, and raise it so it comes up on the other side of the window between the window and the weather stripping. It is often a tight fit, and the tool may need to be wiggled up bit by bit. After getting the wide part of the tool inside the door cavity, unwedge the door to give yourself more room to work with on the other side of the window. A helper tool to open a gap in the inner window seal may ease it through. Be careful not to scratch the inside tinting on the glass. Once the tool is inside, maneuver it around to flip the lock button or electric lock switch. Then open the door.

This tool can be difficult to remove. Cutting the inside U shaped piece off will make it easy, but if you want to save the tool, wedge the inside of the window. Pull back the weather strip with your hand on the finger end of the tool and lower it down into the door cavity. Do not lower it any further than you have to for it to clear the bottom edge of the window. Rotate it back toward the outside, wedge the outside again, and lift

the tool out. If it gets stuck, carefully disentangle it from the window crank by feel. Don't try to force or pull it free.

TRUNKS

Occasionally, you may lock your keys in the trunk. This is a thoughtless thing to do and is easy to avoid, but if you find yourself in this situation, there may be a way out.

Try the trunk release. If the vehicle is unlocked, you may just have to pull the release bar in the cab and you're in. If the vehicle is locked, open the cab with a bypass and pull the release.

Try picking into the trunk. Almost all trunk locks pick clockwise. Bump keys will also work if the trunk has a pin tumbler lock.

If the seats fold down, that is another way into many trunks. Occasionally you can remove a head rest, center brake light, or first aid kit, and have a hole large enough to shine a light through and stick a hooked wire in to retrieve your keys. If the seats have a lock which prevents them from being folded down, examine how the lock is set. Often it is held in with screws driven into heavy paper pressboard beneath the carpeting and can be removed without damage. After the lock is out you may have to manually trip the release lever that the lock normally does when the key turns it.

If you have an electric trunk release button in the glove box or center console, it won't work unless you have a key in the ignition. However, this arrangement can be bypassed. You need some wire (ideally, 18 gauge solid core coated copper wire), enough to run from the car's battery to the trunk release button. You can get by with less if you can't get that much, but you risk blowing a fuse or frying some electrical components. Carefully pry the button out of its place and make sure you don't break off any of the wires from it. See if the tips of the wires are exposed at the connection. If not, you will have to strip away a little of the plastic so the wire from the button is exposed.

When you connect the bypass wire to the positive battery terminal, make sure the other end doesn't come in contact with the car body or anything else. You want it to touch to the correct wire coming out of the back of the button. If it isn't the correct wire, nothing at all will happen. If it is the correct wire, the trunk will pop open. Don't hold the wire in there any longer than it takes to open the trunk. Go back to the battery, being careful again not to touch the hot wire to anything, and disconnect the

wire. Grab your keys out of the trunk. As soon as possible, repair the exposed wires; the button can be carefully pushed back into place.

If you have a shorter piece of wire, you can run it from a live 20 amp fuse in the vehicle instead, but remember to be careful.

One foot of wire will also bypass the key in the ignition requirement, but it might blow a fuse. You need a friend to hold the button in. If you have no friend, a piece of tape and a small, hard object like a rock will serve instead. Push the button in with the object and hold it down with a strip of tape. Find the fuse box. Bridge the trunk fuse to another of the same color (same amperage) with the wire for just enough time for the trunk to open. Remove the wire and release the button. You do not need to pull the button out of its housing for this method.

If your vehicle has no inside trunk release, you may be able to remove a license plate light and fish the keys out with a wire through the hole. If you can't do this, it may be time to wait for your spouse or friend to arrive with another set of keys, or for a professional to open the trunk.

TOOL MAKING

Get in the habit of looking for and identifying materials that can be used to make bypass tools. If you look all the time and get to the stage where you constantly spot potential tools, you won't be at a loss for long in the event of a lockout situation. Being able to spot a workable item that another's eyes would just pass over is a developed power of perception. Looking frantically for an item you once read about isn't nearly as effective as spotting or remembering an item in a place or type of place where you've noticed it before. This will also enable you to better find your keys when you've misplaced them.

LOCK PICKS

If you live in a city, street sweeper bristles are a thing to look out for. Street sweepers are immense trucks with bristled wire rollers that sweep the trash off the streets. Bristles break off when they turn corners, go over grates or curbs, and brush large cracks or uneven areas. Some trucks have round bristles, some have flat ones. The flat kind is ideal for making lock picks out of. The spring steel is flexible and not very brittle, has good memory (returns to its original shape after being bent), is strong, and is rigid in a vertical plane. The bristles are just the right thickness and width for making lock picks out of, and usually break off in long enough lengths. They can often be found at the edge of the street next to the sidewalk, by storm drains, in the entrances to parking lots, and in or near the asphalt patch lines at intersections. Provided you are walking in an area which is cleaned by street sweeper trucks, a walk of six or eight blocks should turn a few up for you, if you are alert. So long as you can safely do so, walk on the edge of the road next to the sidewalk and scan the ground around you as you walk. They are thin, flat, and gray or rusty, which makes them invisible to most people. They go unnoticed until you have an eye for them, yet once you do, you will encounter them frequently and can even spot them at night.

A bristle's cross section is about .125 by .0265 of an inch, and you'll usually find pieces 5 to 11 inches long. Placed side by side, it takes

eight bristles to come to an inch. If stacked flat, two of these bristles are about the thickness of one dime. The length varies because they don't all break evenly, but common lengths are between six and seven inches, and longer ones are sometimes found. You only need a few bristles to make a set of picks. If you see one on occasion, pick it up. They take up almost no space and you can put them nearly anywhere - in a book as a bookmark, in the body of a pen, in a backpack, or taped to any flat surface. They will need some modification, but with a file or grinding tool they can be turned into better lock picks than are manufactured commercially.

If it is not handy to gather these, there are a few other common, excellent alternatives. Hairpins for curling rollers can be bought at any supermarket or drug store, and for most applications they make suitable lock picks. Typically, they are .035 of an inch thick, .10 of an inch wide, and a bit under three inches long. Unbent, of course, they are twice that length. They are not as wide as a pick ideally should be, but once shaped, the pick may be bent carefully to give the tip proper clearance from the arm. In most cases such modification is unnecessary. Due to their softer steel, curling roller pins are easier to file to shape than street sweeper bristles or rake tines. Also, it is possible to make a working rake pick without using tools from a curling roller pin. This involves bending the tip down (insert it sideways into a part of the keyway where it fits tightly, and bend) to give it the configuration of a rake pick, then scraping the working end in long, sweeping strokes across a sidewalk to grind the arm of the pick to a taper. In about twenty minutes, you'll have an emergency lock pick. Its shorter cousin, the bobby pin, makes the best passable lock pick in an emergency situation, without needing to be narrowed down. Although bending the tip of either of these is difficult to do in the right direction, it can be accomplished if you're not sloppy about it. For a more permanent set of picks, shape them with a file or grinder. This takes little time; but makes reliable and useful tools.

Flat tines from metal leaf rakes make superb lock picks, although a significant amount of steel must be taken away to produce them. A file and a vise will accomplish this if you're diligent, but it is much quicker to grind them into shape. Wearing eye protection is mandatory when using any kind of power tool to shape metal. The picks are small and can be torn from your grasp if caught the wrong way, and bits splinter off and could be flung at a high velocity at your eyes. Don't use a power tool unless you've read its manual, and take precautions to work safely. Injury is too serious a consequence to pay for an avoidable accident. If you aren't used to working with tools to shape metal, don't try to make picks with

power tools. Use a file. Though you can still cut your hands, snap metal, break the skin of your knuckles, or have other mishaps, the movement of a file is much easier to control.

Steel banding can be made into lock picks. The straps used to hold bundles of lumber or bricks together is high tensile steel ribbon, which can be cut, filed, or ground into shape. If you're strong and have a good pair of tin snips and pliers to hold the ribbon, you can cut picks into shape. You have to be cautious when working with steel ribbon because it can be sharp and is usually rusty.

Whenever working with these things, the possibility of tetanus should be considered. This is a severe, often fatal infection that contracts and locks your muscles, and you can get it through wounds from old, rusty metal. You have probably had a tetanus booster shot sometime in your life, but be sure that you have and that it is current – the protection runs out! If you have not had one in the last five years or can't remember having one, get it done. It will protect you from tetanus in case of accidents like stepping on nails, or being bitten by a cat (tetanus is a bacteria), as well as cuts you might get while working with scrounged scraps of garbage like lumber-strapping ribbon or street sweeper bristles.

A lot of materials work well for lock picks. Remember to keep the thickness of the pick under the thickness of the serrated portion of the blade of a key. This is usually under .05 of an inch. A jigsaw or hacksaw blade is easily thin enough to fit into a keyway. Some materials, such as tweezers or round spring steel music wire, must be ground or filed until they will fit into the narrow keyway.

Fondue forks make a passable diamond picks when one of the prongs is cut off. Although they are on the thick side, made of wire or stainless steel, and could use some file work to improve their performance, they are found in most junk stores. They also make decent linkage tools, without modification.

The metal pocket clips of some pen caps are the right thickness and are excellent steel to make lock picks of, but most of them aren't held on very well. Keep this in mind and be gentle when shaping them, so the connection doesn't come loose. They are difficult to shape without a vise or pliers to hold the base of the metal clip. The plastic cap must serve as a handle. If it breaks loose, you will need to hold the pick using pliers, because it is too short to be useful otherwise. Making picks from pens that you are likely to carry around may save you considerable trouble if you do the work ahead of time. Having a spare key made ahead of time is even more effective. Sometimes the end of the metal clip bends down around

the sides. With needlenose pliers and careful work, these can be bent back so they are in line with the rest of the clip. Snipping one of them off leaves you with a working pick.

MATERIALS FOR LOCK PICKS

- Flat street sweeper bristles
- Hairpins
- Metal temple pieces from eyeglasses
- Bicycle spokes
- Flat dipsticks
- Rake tines
- Steel lumber banding
- Flat spring steel wire from hobby shops or steel supply stores
- Various hair clips
- Hacksaw blades made of flexible high speed steel

SECOND RATE MATERIALS FOR LOCK PICKS

(Some of these fall here because they are too short to be used very effectively or are not well attached to a handle. Being able to manipulate the pick is very important. Using a pick without a handle is like using a screwdriver without a handle.)

- Feeler gauges
- Nail files on fingernail clippers
- Pen caps with spring steel pocket clips
- Guitar wire
- Tweezers
- Fondue forks
- 4 inch needle files

LAST DITCH SUBSTITUTES FOR LOCK PICKS

- Copper staples holding large cardboard boxes together
- Needles
- Paperclips

TOOLS NEEDED TO MAKE LOCK PICKS

You can get by with just a file. However, pliers are helpful. With a vise and a grinder picks can be made very quickly. Pliers with wire cutters, or just a good pair of wire cutters, can save you some work. Safety glasses are highly recommended.

Get a file. It doesn't have to be new, but it has to be one made for cutting metal, not wood or fingernails. A file with a six inch working surface is preferable, but a smaller or larger file will work well, also. The files found on some multi-tools that have pocketknife blades, pliers, and screwdrivers are OK. You can find files in most goodwill or junk shops, pawn shops, garage sales, hardware stores, etc. It is OK if they are rusty. They will still cut. It doesn't really matter what shape of file you use, because it is a simple enough tool to be versatile. Pay attention to how you place your strokes and where you apply pressure. Files cut on the push, like saws, not when you pull them. Without well exerted control, files tend to fall into the lowest spot and cut it deeper. Four or five strokes in the wrong direction can ruin a potential tool, so don't go on automatic pilot. Be sure to use long strokes that engage the length of the file.

With a vise and a file, a lock pick can be made in ten minutes from a street sweeper bristle, curling roller pin, narrow rake tine, or other appropriately sized piece of steel. The vise allows more pressure to be focused than if the steel strip is braced against a table or held in the hand. A key to using the vise is to have as much of the strip in the vise as possible to allow maximum support for the bit being filed. If you do not have a vise, a large pair of pliers may be substituted, or a piece of steel with a flat edge and a C clamp. These are not necessary, but used appropriately will speed things up. Another useful substitute is a hinge. Trapping a bit of metal in the hinges of a door or large box will often hold it very securely. Have the door or lid open, slide in the strip of metal, then carefully close it. Experiment in positioning until you find a secure spot (you will probably will have to hold the other end with your hand) that grips, yet allows you to file.

If you own a flex shaft, other rotary grinding device, or a drill, you can make picks very quickly by grinding them to shape. At a hardware store you can purchase fiberglass reinforced carbide cut-off wheels about an inch in diameter and a mandrel (a post and screw attachment) to hold them. This can be put in the chuck of a drill motor and be used to cut the metal into the right shape. These are especially useful if the piece of steel you are using is too big to fit into the keyway to start with. WEAR

SAFETY GLASSES. They were invented for exactly this sort of thing. Remember to start with a narrow strip of steel that requires as little modification as possible.

You really don't have to worry about tempering your picks. So long as you start with spring steel, it is ready for use. Most home tempering projects leave materials brittle and overhardened. Merely quenching hot steel only hardens it - tempering the steel requires reheating it to a specific temperature and re-quenching it. Without drawing it back this way, the steel has no toughness and hence is unsuitable for use. Fortunately, the industrial age has provided us with plenty of suitably tempered steel. You have a list above that gives a number of good options and should give you an idea of what other materials may perform well also. Coat hangers and cans will not, since they are not made from steel suitable for that purpose. Use steel intended to withstand some stress and abuse. You can make picks from unsuitable metal, but no amount of fiddling with heat will transform them from undesirable to excellent.

HOW BIG IS A LOCK PICK?

Make the working end of the pick (the arm) about as long as the blade of the key of the lock you are trying to pick. One inch to an inch and three-eighths is typical. If it is too long you may be more likely to get the pick stuck in the back of the lock, and the pick is going to have less strength. If it is too short, the arm of the pick will interfere with how the tip works by pushing on pins at the front of the lock while you are working on the pins in the back.

Generally, an eighth of an inch is as wide as you want the base of the arm to be. It should taper down in width (to about the thickness of a penny or dime lying flat) on toward the tip. The tip should remain within an eighth of an inch from the tip to where the back edge of the arm is, so there is some room to maneuver within the keyway. Although clearance (the amount of room between the working tip and the supporting arm) is important, it is also important to make the arm wide enough to be strong. You do not want to break the tip of a pick off in a keyway.

Thickness is dictated by the keyway. The pick should be no thicker than the portion of the blade of the key that contacts the pins. Some locks have keyways that are curved, rather than straight, through this section of the keyway. Thinner, smaller picks would be more effective in this type of keyway, as well as in smaller locks such as would be found on luggage.

Different styles and sizes of picks can open the same locks. Although a number of styles are made, veteran locksmiths usually use two or three for everything. The trick is to feel and correctly interpret what is going on in the lock, and be able to use your tool to defeat it. The most useful and common styles are the rake pick and the diamond pick. The rake pick looks like a bent finger, and a diamond pick looks like a pyramid at the base of a gradual slope. A raffle pick, which a few people prefer for scrubbing locks, looks like a squiggle. They are all quite simple to make.

The handle of a pick is an important factor of your success. It must be adequate to move and control the pick inside the lock. It should not be big or padded, because it is important to feel what is going on inside the lock, and a thin handle does not encourage excessive force the way a more substantial one does. Provided it can still effectively be used to control the pick, a two inch handle makes a convenient wallet sized tool, if you can carry it legally in your area. A more standard handle is about three and a half to four inches long. Much more than that is unnecessary.

It is better to guide the pick by the movement of your hand alone than it is to use the confines of the keyway as pivot points and aids to sloppy attempts. Inexperienced or inattentive people tend to hold picks in such a way that makes operating a pick properly impossible. Remember that the goal of the action is to unlock the door, cupboard or drawer by manipulating the lock's pins. Picks are small so that the working tip of the pick can manipulate the particular pin targeted. If other parts of the lock are bumping against the pick, **YOU CAN'T FEEL WHAT IS GOING ON.** Craft the handle and use the handle so that you can control the working tip without levering the arm of the pick against the keyhole.

To make a good handle, you need to consider what the pick has to do to work effectively. It has to remain vertical while pushing up or down on the pins, the same way a knife blade must have the edge, not the side of the blade, facing a carrot if it is to cut it. It must provide leverage allowing you to push tumblers at the back of a lock. It must transfer the feeling of the tip back to your hand, like a fishing rod, so you can respond to it. It must remain solidly attached to the pick. A straight piece of wire would make a lousy handle because nothing would keep it from turning in your hand, but a wire with a bend or two in it would give you control over that. Using the same piece of steel that the pick is made from is recommended. For a stiffer handle, an additional strip of metal can be placed alongside the handle and held on with a piece of tape. Bending a ninety degree twist into the back end of the handle and bending a ring into the end to go over

the end of your finger allows great control, leverage, and sensitivity. However, you must be very careful while bending this ring not to bend it too much in any one spot, or the steel will snap. The most common commercial handle is about three eighths of an inch wide, three and a half to four inches long, and may or may not have steel or aluminum handle slabs riveted or glued to either side. Double ended picks, or combination pick-at-one-end, tension-wrench-at-the-other tools are useful and not difficult to make.

Dimensions for lock picks are not exact. So long as they work, be happy with them. The pictures given are full scale drawings to give you a model to work from, and so long as what you make is close to that, if the quality of the material is adequate, you will have a working lock pick. You might make elegant, more refined lock picks, or clunky, toddler style lock picks, depending on the situation or what you have time for. Beefier lock picks are harder to break than the slender kind that give a bit more clearance between the arm and the tip, so it is a good idea to make picks suited to your skill level. A broken pick stuck inside a lock is a real hassle to deal with, and more often than not can only be removed by taking the lock apart. Don't make a tool too delicate for you to use. Using the pick with the awareness that sloppy or overly forceful techniques will break it usually results in improved skill.

Sometimes a pick isn't necessary to pick a lock. A needle file small enough to fit the keyway might suffice without needing any modification. Because files are brittle, extreme caution should be taken.

TENSION WRENCHES

The most common material for tension wrenches is the same that you would use for a lock pick. Although anything that will fit into the keyway that gives you leverage and still allows you to manipulate the pins will work, a good tension wrench allows for greater control. Two styles work particularly well. One requires the piece to be cut or filed to shape, the other requires bending and twisting a steel strip. Which style you choose to make depends upon available materials, tools, and preference. They both work very well.

To make the flat kind, find a strip of spring steel about three-eighths or a half-inch wide and three to four inches long. It should be thick enough that it is reasonably difficult to bend with your thumb. Bicycle toe clips, newspaper and mail clips outside some apartment doors, and belt clips are a few options, and there are dozens of others. Cut out a

wedge section to leave you with an angled L shaped piece. Make sure it is big enough to make an adequate tension wrench. If the part that slips into the lock is too small, it will slip out of place too easily and be useless.

The other kind is easier to make. First, make a ninety degree bend in the strip near the end with your fingers. If you use pliers to do this, you will be likely to snap the steel. Spring steel has limits. If it were not resilient (able to spring back into shape) it would be more malleable (easy to bend), which would limit its use as a lock pick. If you cannot use your fingers to bend the tip of a bristle, tine, or hairpin (you probably can) because it bites too much into your fingers, you can put the tip into a paper-back book, hold it tightly shut over that point, and bend it that way. What you are trying to do with all this is make a more gradual bend than a sharp, ninety-degree corner.

Once it is bent you will have an L shaped strip, and this will function as a tension wrench. However, if you want to improve it, adding a twist of a quarter turn into the handle near the foot of the L will allow you a much greater degree of control. The springiness of the steel will work for you, allowing you to fine tune the amount of tension you apply. This is recommended. Just grasp the strip with two sets of pliers with a gap between them, and twist until the head of the tension wrench is perpendicular to the body. This also makes the tension wrench lie flatter in a case or wallet. The handle of your tension wrench should be at least three inches long, up to perhaps six.

If the frame of the door you are trying to get into makes it awkward to insert a tension wrench into the optimum location, bending the arm of the tension wrench can get you out of that jam. Do not bend it back and forth often, because metal fatigue will set in and the tension wrench will break. A simple curl will suffice.

EMERGENCY LOCK PICKS

Unless you carry picks in something you have with you all the time, like a pen or your wallet, they won't be available when you need them. Without a tool to shape the steel, crafting a simple pick can be a difficult chore. A makeshift and temporary tool, while not as effective, may still be enough to get you in.

A bobby pin with a bent tip is the best instant pick. Pull off the plastic tip from the straight side. Stick the very tip of the pin sideways into part of the keyhole where it is a very snug fit, and bend it into a rake pick. It is going to want to twist and bend the way that it was meant to

instead, but you can straighten most of those kinks out. A little bit of a twist may be unavoidable. If the keyhole isn't suitable, find a joint between two pieces of metal or some other crack where you can wedge the tip in and bend it into the shape you want. Once this is done, bend the other end back in a loop to give you something to grip and control the pick with. This will still perform fairly well. If you cannot bend the tip correctly, a straight tip *might* suffice to open the lock.

If you are close to an area where there are a lot of cardboard boxes accessible, you may try looking for staples. Most boxes are held shut with tape, but some of the heavy duty ones are stapled shut. It is easier to bend the end of a staple than a bobby pin, but because they are shorter you really don't have much of a handle to work with. A bit of string and some tape might help, or you could try hooking the rearward end of the pick with another staple. It is difficult to pick open a lock with a staple, but it can sometimes be done.

Pen caps with metal pocket clips sometimes work without being shaped into lock picks if the keyway is wide enough. You need to break the folded part off, and be careful while using it so it doesn't break from the cap and get stuck in the keyhole. Automotive locks generally have bigger keyways than the kind you have at home.

Incidentally, metal pocket clips make great emergency tension wrenches. Unbend the lower section into an L, or use the upper section that breaks off that way.

Paperclips are the most common substitute people try to use for lock picks, and anyone who can open a lock with them deserves some deference. It is a difficult, frustrating mess to try to work with these things. They bend too easily. When you push on a tumbler in the back of the lock, the paperclip is likely to bend instead of moving the tumbler. Although using a paperclip as a pick and a pen cap clip as a tension wrench is a method that has enabled many people to get into all kinds of things in an emergency, that it can be done at all is an amazing thing.

Usually, the tip is bent downward to resemble a rake, and you go from there. If you are miraculously lucky, the lock will open right up. If you are like everyone else, the paperclip will bend out of shape and you will have to rebend it and start again. After perhaps twenty five straightenings of the bent "pick," you likely will have to look for a way to bypass the lock or come up with a bobby pin. There is a better way to make a pick from a paperclip, but you will need more leverage and pressure than fingers alone can supply. If you do not have pliers, you can use cupboard doors, drawers, staplers, staple removers, or whatever other hard, hinged

surface is handy to act like pliers. First, unbend the paperclip. Next, fold it in half and crimp the fold so that it is a tight, 180 degree turn. Then, bend the end down into a rake pick. Finally, twist the ends together so that they can't separate from one another. It is a bothersome process and leaves you with a pick without a handle, but it is now strong enough to manipulate the pins without bending. If you can hold it with pliers or loop another paperclip through the back end and wrap a bit of tape around that, you have a working lock pick. With pliers, you can construct a diamond pick instead of a rake, if that is your preference.

Obviously, the bigger the paperclip, the more strength it is going to have and the less likely it is to bend. Unfortunately, big paperclips don't fit into the section of keyway where you need them. If the clip is too fat, after it is constructed you can remedy this by standing on the pick and skidding your foot back and forth on a sidewalk. After a bit, flip it over and scrape the other side. Stand with the ball of your foot (behind your big toe) on the pick. After enough of this rubbing the pick should be slim enough to fit into the keyway.

Thin steel wire, if you can find any around, is better to use than paperclips, but they are better than nothing if you can actually get in using them.

Barrettes and other types of clasping hair clips can be used to open locks, as can needles or other objects which are small enough to enter into a keyway and fiddle around with. Because lock picking is no sure thing with even the best tools, it isn't wise to spend too much time and effort crafting or using makeshift, second rate tools if other entry possibilities exist. If you know the lock is easy to pick, it may well be the best route, but it is important to avoid getting frustrated over it. Think of it as a challenge with chance involved, and let it go if you start getting angry.

HOW TO MAKE A PICK GUN

All you really need is a piece of masking tape, a coat hanger or some other kind of wire, and a bobby pin. Scissors, a felt tip marker or a bottle, and some wire cutters are helpful in constructing a pick gun, but aren't necessary. Masking tape is preferred over other kinds of tape because it is easily handled and applied to metal surfaces, doesn't stretch much, and can easily be torn or cut into shape.

Take the plastic tip off the bobby pin's straight end and unbend the pin. Clip the coat hanger or bend it back and forth until metal fatigue causes a break, leaving a workable piece of wire. At one end of the wire,

lay a short piece of masking tape so it meets the wire like a flag on a pole. Place the bobby pin alongside the wire so that the straight end extends past the end of the wire an inch to an inch and one-eighth. Making sure there is no slop in the fit, tightly wrap the bobby pin to the wire with the tape.

Check which way the bobby pin is oriented. You will bend the wire so it is in line with the bobby pin. When the tool is lying flat, the bobby pin will lie flat, too, and when the tool is being used, everything lines up with the keyhole. The bobby pin is supposed to strike the pins as a knife edge would, not a paddle.

Try to keep the tool as flat (two-dimensional) as possible, so that it is efficient and easy to control. The bends can all be made easily with the hands, except the coil in the middle of the handle, which is necessary to provide spring tension for the striking arm. The easiest way to make it is to wrap the wire 1½ times around a marking pen, small bottle, or bottle top, then slide it off when you are done. If you have nothing round to use as a form for the coil, you can use your thumb, although it will hurt a little. The coil does not have to be perfectly round.

When the pick gun is completed there should be no pressure, or very little, being exerted on the pick arm from the striker in the resting position. The pressure should come only at the instant the striker hits the pick arm, jolting the pins in the keyway.

You may want to tape the bobby pin to the wire in two places, leaving a small bit of exposed metal so the striker will hit the pick arm without being dampened by the cushioning tape.

HOW TO MAKE A PLUG SPINNER

Find a cheap ball point pen, the kind that has a cap, not the retractable kind. Pull the pen part out of the middle so that you have the writing part in one hand and the empty body of the pen in the other. If you can't get a good enough grip on the pen tip with your fingers, grip it with your teeth instead and yank the body of the pen free of it. Throw the pen away and keep the empty body of the pen (henceforth called the barrel) to use as the shaft the blade of the pick gun sits in.

Get a piece of wire from a coat hanger or other source. Wrap the wire around the barrel about ten times. The wire will be tight around the plastic barrel - too tight for the pen to move. You need to increase the size of the coils so that the barrel can roll freely and easily within the spring you have created. To increase the circumference of the spring, grab each

end of the wire and steadily twist the opposite direction you wrapped, a half turn or maybe a full turn. When the spring is big enough to allow the pen barrel to slide in and out, bend the end of the wire at each end so that the spring arm and brace are formed. Be sure that the wire goes away from the spring at a right angle instead of slanting away from it, otherwise it is likely to bend into the barrel during use and prevent the tool from working properly. Clip or bend off excess wire from the ends. It is a good idea to file off the sharp ends of the wire or cover them with tape.

Remove the barrel from the spring. Take a street sweeper bristle and bend it in half. Shove the bent part into the barrel until about an inch and a half of the ends stick out. Bend one end sideways to serve as the trigger. Bend the other one just a little so that it sticks out from the middle of the barrel, instead of from one side. Put the barrel back into the spring and the tool is complete. If you do not have street sweeper bristles available, use rake tines or a metal piece from a hairpin. Curling roller pins are not wide enough and might turn sideways in the keyway without turning it.

WIRE TOOLS

The best use for a coat hanger is to hang clothes on in a closet. Using a coat hanger as a bypass tool is the equivalent of using a plastic spoon as a screwdriver. Think about that. Imagine assembling a piece of machinery held together with lots of screws using a white plastic spoon from a convenience store. Would you be able to do a really good job?

Inadequate tools = inadequate results. Except for making pick guns and plug spinners, stay away from coat hangers. Coat hanger wire is very easy to bend, so it is only useful in applications where it does not have to be rigid. It is totally unsuitable for any situation where friction must be overcome, like sliding up the sill at the edge of a door. It also doesn't work when a tool has to be twisted to bind a linkage. The coat hanger wire will get twisted itself instead of applying force to the linkage rod you are trying to grab. People looking for an easy way in usually think of a coat hanger first because it is easy to think of and easy to shape. Paradoxically, people do not take time to find strong wire and shape it correctly because it takes too much effort, but it takes even more effort to try to make a coat hanger do something it wasn't meant for. If you are trying to save yourself from bother, do so by making good tools so the job may be performed smoothly.

Very few of the procedures outlined in this book can be accomplished with a coat hanger – it is too easily deformed by friction. However, there are cases where coat hangers serve adequately. They can be handy for grabbing keys that would otherwise be out of your reach. Completely unbent, save for the hook at the end, a coat hanger can be used in conjunction with locking pliers to open interior lever handled doors if there is a smooth floor and a decent gap at the bottom.

Blanket hangers are made of a heavier gauge wire and produce better-quality tools, but they are harder to find.

PREFERRED MATERIALS FOR LINKAGE TOOLS

- **Car antennas** are excellent material to make linkage tools out of, but need to be replaced afterward. There is no way to unbend one of them back into its original form. Many vehicles have antennas that are too short to be made into much of anything, but at a junkyard or auto parts store you should be able to find a suitable one very cheaply.
- The other material used to craft high grade bypass tools is **spring steel music wire**, which you can find in hobby shops in three foot lengths. It is inexpensive and is ideal for this application. Choose a gauge about an eighth of an inch or a little less in diameter.
- **Brazing rod** (hardware store or welding supply shop)
- **Plant hangers** (garden store, department store, ceiling plants) These usually have a brass finish with hooks bent into each end.
- **Wire bookends** (library, bookstore, furnishings dept.) come in various shapes that often make crafting a tool easier than starting with a straight piece of wire. The aluminum wire bookends are a little thicker, but also serve adequately if you can fit them into the door.
- **Grills and racks** (refrigerator racks, oven racks, barbecue grills, kennel doors, etc.) These are usually made from heavy gauge chrome coated wire which is suitable for tool making if you can break or cut it free of the rest. Diagonal supports are often the most vulnerable to separation, usually attached only at the ends and perhaps the middle. If you can grab a piece and wiggle it briskly, it can come free of its spot welds. Take care when using these not to let the rough spots mess up the paint, seals, or window of your vehicle.
- **Electrician's Fish Tape** You should be able to get some at an electrical supply store or from a truck if you ask nicely and explain your situation. Due to its flat cross section, it is used to slip between narrow gaps, particularly when reaching into the cab of a vehicle. It is

tough steel and is hard to drill through. Grinding a slot into it with a cut-off wheel is easier. Primarily, it is used to make under the window button lifting tools, or to reach the manual or electric lock release by wedging the door. Because it is flat, it doesn't make exceptional car opening tools meant to grab a linkage inside the door cavity (it bends too easily), but it makes excellent tools for working with house doors for opening knobsets, deadbolts, lever handles, and push bars. It is the right width and can be cut to the right length for making lock picks, but must be ground thinner if it is to fit into the keyway of most locks. Properly shaped, a piece of fish tape makes an ideal automotive tension wrench.

- **Barbecue skewers** for shishkabobs make passable linkage tools, if you can find one long enough that you can bend a handle into it and still have it reach your target.
- **Bucket handles** are the most common wire that is fairly well suited for making bypass tools with. A five gallon bucket can be found in nearly every city block and every rural area. If you can't find one, you're not looking. Try the garbage area behind restaurants, look in the garage or barn, look in alleys, look anywhere you see a bunch of junk lying around. If you don't see one immediately, ask the first person you see who works or lives in the area. Although you may end up running across a couple of buckets whose handles are missing before you get one whose handle you can remove, you can find one outside much easier than you can find a coat hanger, and it will perform better as a bypass tool for automobiles. A bucket handle is not spring steel, but it has a large diameter and is reasonably stiff. You might have trouble removing the wire handle from the bucket, because the ends twist under the rim of the plastic. The easiest way to remove them is to

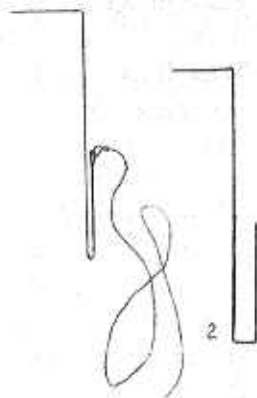

TOOLS ARE: 1 BUTTON GRABBING TOOL 2 BUTTON LIFTING TOOL 3 WING WINDOW TOOL 4 HORIZONTAL LINKAGE TOOL 5 DOUBLE ENDED HORIZONTAL LINKAGE TOOL 6 BELL CRANK OR LATCH ACCESSING TOOL 7 UNDER THE WINDOW TOOL

melt through the plastic in that area with a lighter. You don't have to set the thing on fire, but heat the plastic enough so that the wire can be pulled free. This will heat the end of the wire, too, and you can burn yourself if you aren't careful. Be sure the plastic is not burning before you go. It is easy to smother out by blowing sharply or rolling it on the ground. Spit on it or otherwise check to be sure the plastic is cool afterwards. A fire is a bigger emergency than being locked out.

You are looking for stiff steel wire, of an appropriate diameter for being slid between a door and the window of a car's passenger side door. If you are bypassing a house door, narrow spring steel wire the size of a heavy bicycle spoke or bigger will be necessary. If you are going to practice, go down to a hobby shop and buy piano wire in varying gauges to craft your tools. It won't cost much more than a couple of dollars, and will give you superior material to work with.

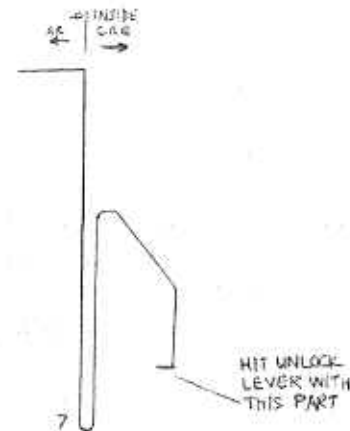

RULER SHOWS APPROXIMATE SCALE. SIZE WILL VARY ACCORDING TO APPLICATION.

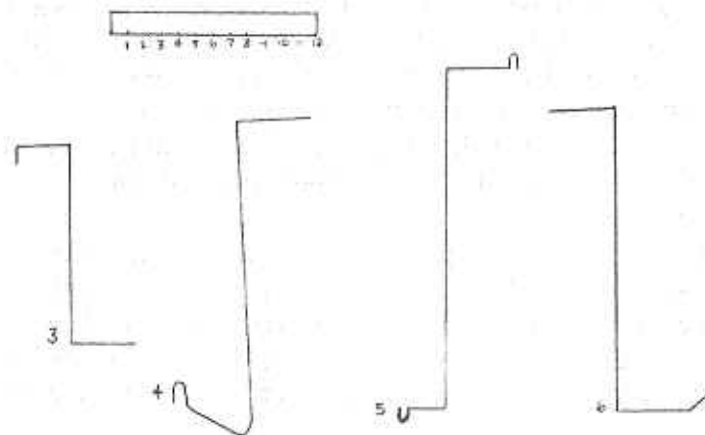

BENDING WIRE

Fingers by themselves aren't strong enough to bend heavy gauge wire into the shapes you need. To make sharp bends, you will need a corner to bend the wire around, and you might want to hammer the corner sharper if you have an unacceptably long curve. With a vise you can get an exceptionally good grip on the wire you are working with, but a vise isn't always handy in an emergency. There are a few rules to remember when crafting tools in the field:

- If the wire is already bent, see if you can use those bends to your advantage. Wire bookends serve as a good example. Instead of straightening the whole thing out, you may only need to open one bend, letting the others serve as the handle and working ends of the tool.
- It is easier to twist a wire than it is to unbend a short piece. Bucket handles usually have wire ends that do not lie flat with the rest of the loop. To get them in line, grab the end of the wire with pliers and rotate it a half turn so it forms a small U opposite the larger U. The larger part of the bucket handle can be unbent and reshaped to form the tool of your choice.
- Be sure that you plan things out so that the tool lies flat, or at least that the part that you slip into the gap is flat. If you don't plan the tool so it can slide under the door or along a window, it will not be useful to you.
- It is very difficult to make a sharp bend at the very end of a wire, but that is often where it is needed. To get around this difficulty, bend a loop into the wire several inches short of the end, and cut it off there, making *that* the new end of the tool. The tip can be wedged into a crack and the rest of the wire rotated so that it comes in line and lies flat. Figure out beforehand how much wire you have to play with and bend the loop in first, so you don't miscalculate.
- Don't bend the wire too many times, or it will lose strength. Try to keep the tool as close to the ideal shape as the wire and tools you possess will allow.
- If you do not have pliers, you will have to make substitutions. Look for doors to close the wire in and hold it, or cracks in large pieces of wood like telephone poles. If you can jam one end of the wire into a crack, you can bend it sharply where it protrudes. You can also place short bends into cracks and rotate the rest of the wire around to bring them into line.

- File through a wire if it is too thick or strong to get with wire cutters. If you score the metal deeply with a file or wire cutters, it will break there if you bend it repeatedly back and forth. If possible, plan the tool so that you don't have to shorten the wire, to save yourself the bother. There can always be some extra wire on the handle end.
- If you are trying to make a loop into the end of a wire, bend a P into it, or something close. With pliers you can squash the wire together in such a way that the end will form a closed loop, that string won't fall out of.
- If you are making a hook at the end of a linkage tool for a car, make it deep enough that the linkage will catch in the trough and not slip out when you twist. You may even want to file the inside curve of the U square so that it has a more positive bite.
- The longer the tool is, the more force you lose along its length when you apply pressure to it. You want to have your handles as close as practical to the main source of friction, so that you have the maximum amount of control. Remember, if you cannot use a wire alone to exert enough pressure on your target, an attached string may help.

IF YOUR VEHICLE HAS AN UNSHIELDED VERTICAL LINKAGE

This means that you have a post that goes up and down and a button in the car that you can push down to lock the car door. Unshielded means that there is no guard inside the door cavity protecting it from being manipulated.

What you are looking for to open one of these is a flat strip that can be bent so it contacts the linkage rod. There are a great number of options.

All you need is a flat strip of steel with a couple of cut outs in it to grab linkage rods when slid into the door and tilted against them. These tools are easy to make, and if you cannot find the tools or material to make them, you can approximate their shape with a great number of devices and still succeed. They are meant to grab the linkage rod and hoist it upward. That is a simple task.

A bread knife with finely serrated teeth is probably the best tool you can use. The teeth can bite into the rod anywhere along the length of the blade, instead of just at the notch as with the conventional tool. Knives also have comfortable handles built into them. All you need to do is put a bend into the end of the blade so that it forms a J.

If you are going to make a vertical linkage tool from steel strapping ribbon, look for the wide stuff. The three most common widths are five-eighths, three-quarters, and one-and-a-quarter inches. Cut a notch into the side of the strip near one end with tinsnips, a hacksaw, or a grinder. The piece to be removed can be snapped off by bending it back and forth after the initial slots have been cut in. If you have narrow strips that are too flimsy to be very useful, tape two together.

Steel rulers can be made into fantastic tools, but it isn't worth the effort. A cheaper, more easily worked material is preferable unless this is all you have.

If you don't have tools to cut a notch into a flat strip of metal and cannot find a bread knife at a junk store, but could get in if you could only make a tool, you can use a length of stiff wire and some masking tape. Bend the wire into a curve, bend in a handle, and wrap tape, sticky side out, on the outside of the lower end. If you use a bucket handle to do this, bend off or cut off the hook end of wire so that it is easier to lower into the door. You may want to lower the tool into the door cavity on one side of the post and curve the tool so it angles around and touches the post from the other side; this will increase the gripping friction when you lift up.

SECURITY

Your key codes are important. A series of numbers and letters imprinted on the key or the lock corresponds to the sequence of cuts that a working key must have. When you get a new car, your keys might have metal tags with the codes on them. A conscientious car dealer will write the code in the owner's manual. Keys for tubular locks (U-bolt bike locks and stuff) usually have the codes printed on them.

Most cars have a key code, and knowing what yours happens to be can save you a lot of money in an emergency. Locksmiths have lists that show the proper sequence of cuts on a key for a particular code. If you provide the code, they can make a new key for you quickly and cheaply. Without the code, they will have to impression the lock, sight read it, remove a lock and dismantle it, or find the code themselves. This will cost a lot of money and take longer. Prepare for this emergency by finding your codes and writing them down. Calling the dealer you bought the car from may get you this information.

Sometimes the cuts themselves will be stamped right on the head of the key. They would be the manufacturer's standard depths, in se-

quence from bow to tip. This is more likely to be done on house keys than other kinds.

If you have a code, write it somewhere where you can find it again, like the owner's manual or a label under the dash. If you are worried somebody might have a code book and could take advantage of your forethought, put the code into your own code. For instance, if the code was A326 you could assign letters to the numbers in your code. Using a memorable phrase like "filthy sock," you could translate it this way:

1	f
2	i
3	l
4	t
5	h
6	y
7	s
8	o
9	c
0	k

This changes the code from A326 to Aliy. By keeping the numbers in lowercase and leaving the original letters capitals, you should be able to tell them apart. If L's look like ones and O's look like zeros, that is OK. A locksmith will know which ones are supposed to be letters and which ones will be numbers, and should be able to figure it out once you provide the code word and explain what you did.

Don't keep a code in your wallet. Keep them in an inconspicuous place near the actual lock. Remember that many locks do not have codes, especially doorknobs and deadbolts. Padlocks and locks on files and desk drawers will often have codes printed right on the lock in plain view.

AROUND THE HOUSE

Knowing the means to get around a lock is necessary to be able to take preventive measures. If you figure out all the ways you can get into your house and then foil your own efforts by making minor improvements in the carpentry or hardware, you're halfway there.

Weather stripping is an obvious and effective solution. If the gaps are filled, there is no room for a tool, and the house is more energy efficient than without it. Keeping everything in good repair will ease your day to day life as well as your peace of mind.

Criminals look for the easiest opportunity available. To keep a secure home, you should take measures to make it more secure against forced entry – you don't want locks or doors that can be easily destroyed.

If you decide to change your locks, remember that you will get what you pay for. You might spend five dollars or two hundred on a knobset – keep in mind the worth of what it's protecting. Don't buy locks at hardware stores. The salespersons will only be familiar with what they carry, through the promotional literature the company sends. At this point you may know more about locks than they do. Go to a locksmith's shop. Since these people work on different models all the time, they have a good idea of what works best and what is a good value. They can also find what you want if you have something special in mind. If you like the style of lock you have, you may be able to get the same style in a better grade of lock. All the major manufacturers produce good products, but people usually aren't willing to pay for the quality. It's your decision.

If your locks can be picked easily, you may not have to replace them to correct the problem. Often, you can bring the locks in and have them rekeyed. A knowledgeable locksmith can pin up a lock so that it is very difficult to pick by placing long pins next to short pins. It is usually cheaper to rekey a lock than it is to replace one. Oftentimes, a good quality lock may be easy to pick while a junky one is impossible, just through a matter of the pinning.

If you buy a lock, look at the key. You want one that is particularly jagged. When all the cuts are relatively even, it is easier to pick.

A well built lock can withstand much more abuse than an economy model. Look for locks that have metal housings to fit inside the hole drilled in the door. If screws alone hold the lock in place, it could more easily be battered out of the way.

Remember that how well a lock is fitted determines how effectively it will perform. How well it lines up with the strike, how smoothly it operates, and whether it can be bypassed will be greatly affected by proper installation.

Make sure your exterior doors are solid core wooden or metal doors. Sometimes flimsy interior doors are found on garage or side doors, but these aren't built for much more than privacy. If you have a lousy door on your apartment, let the managers know, because it is their responsibility to ensure the building is reasonably safe.

A dowel behind a sliding glass window or door is usually adequate to keep it shut. The locks on sliding glass doors are not sturdy enough to stand up to abuse.

If a door swings inward, the part that usually gives way when someone tries to bash his way in is the doorjamb. The lock usually holds, but the door frame splinters right around where the strike (the hole for the latch) is. To reinforce this, sink three-and-a-half-inch screws into the strike plate so that they bite into the stud behind the door frame. If this is not feasible, you may be able to buy a metal reinforcement.

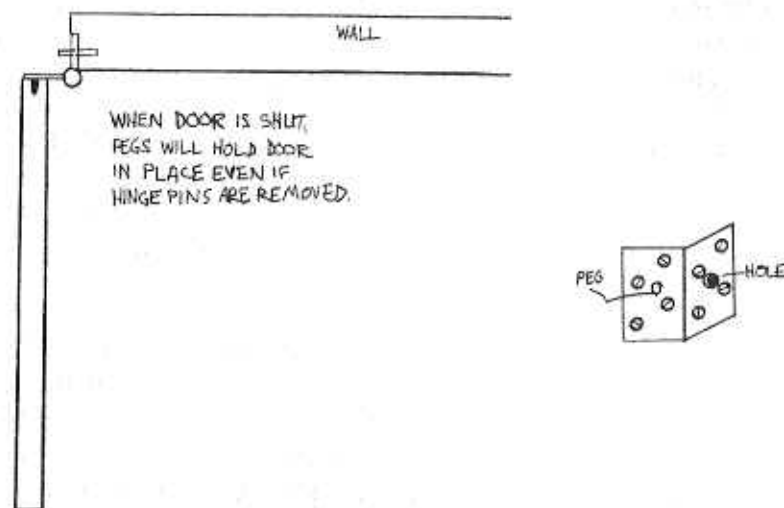

If the door swings outward and the hinges are on the outside, you need to prevent somebody from taking the door off after removing the hinge pins. An easy solution is to drill holes through the hinges and install some nails or bolts. If you are careful about installation, they will not interfere with how the door opens and closes. Doing this will hold the closed door in place even if the hinge pins are removed. The nail or bolt you insert should stick out about a half an inch from the doorsill, and the head should be cut off so it can fit snugly into the hole drilled for it.

To keep windows closed, you may install a pin if the regular window lock is not adequate. Be very careful, when drilling the frame, to stay as far away from the glass as possible. If your drill bit hits glass as you make your hole, you can shatter the entire window.

Adequate lighting and visible entrances which are not hidden from the neighbors' view are deterrents to crime. If within your budget, a dog is an excellent investment in security, as is an electronic burglar alarm. Bur-

glar alarm signs and stickers that tell a would-be intruder you have one can send him looking for an easier opportunity, whether you really have one or not.

CARS

If you are worried about your car being broken into, electronic security devices are an excellent preventive measure. They have become very affordable and offer numerous options. Features that are desirable are an engine disabler that will not allow the vehicle to start or will make it quit running after a couple of minutes and a pager that will let you know if your alarm has been activated. Thieves with cool nerves can operate while an alarm is sounding, knowing that most people have learned to ignore the incessant false alarms they've been annoyed with. You probably care more about your car than a stranger does, so it is wise to make sure the alarm notifies you in the event of a break-in. Without providing a physical impediment in addition to noise, an alarm does little more than ask loudly to be left alone.

If you are reasonably handy, you may want to build a shield for the linkage of your car. It is important that the shield attaches to the door body in such a way that it does not impede the operation of the window. You may want to run a strip of metal or plastic along three sides of the linkage (that is usually sufficient), or you might want to put a tube or narrow box around the linkage. Remember that the ends of such a contraption are still susceptible to manipulation. You may have to build a box over the latch assembly or close the bottom of an open shield.

The common-sense rules of not leaving valuables in the vehicle where they might be seen and being sure to park in well lighted areas are, of course, always good to follow.

Some people put keys into little magnetic cases to stick under the bumper of their car. Speed bumps and potholes claim a great number of these little boxes every year. If you want one to stay put, hold it on with a self-tapping sheet metal screw. A cheaper and equally effective solution is to tape a key onto an inconspicuous place under your car. A large piece of duct tape with a smaller piece laid against it to protect the key can be put along any clean, flat surface of the vehicle. Place it where it is not likely to be hit with too much road spray, and check occasionally to make sure it is secure in its place.

Remember to obey the law and make sure only to use the skills outlined in this book to open your own things. Practice and experiment so that you know you can make a particular method work for you before you have to rely on it. That way you will avoid disappointment and develop skills that you will find useful in the future. Keep alert to new possibilities so you may improve your range. Cultivate patience, because it allows you to try again after a failure with greater concentration and resolve. When no doors remain closed before you, where you decide to go is limited and determined only by your character. Choose wisely.

LOCKED LUGGAGE ZIPPER PULL TRICK

Detach the zipper pull tab from the zipper slide to bypass the padlock holding two zippers together.

Carefully pry the keeper ring up slightly with a pen, screwdriver, or knife edge. Put the pull tab into the keeper ring and tap or crimp the ring back into place once you've retrieved your keys.

Security zippers have padlock holes on the zipper slides themselves, but regular zippers are far more common, so this is often a useful trick.

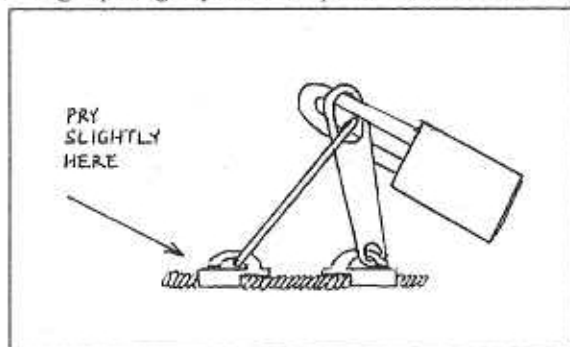

WARDER PADLOCKS

Warded padlocks have sharply declined in use in this era, but they are still in common use as luggage locks. For the small variety found on suitcases, a small paper clip or bobby pin is sufficient to open them.

The lock works like a mousetrap. The big spring is held in place by a trigger that just needs a good nudge to set the device into action.

In the padlock, the big spring is doing its best to push the shackle out of the lock into the open position. A catch prevents it from doing so. That catch is the trigger.

When shut, the padlock is fairly secure. It doesn't open unless the catch is displaced. Push the catch with anything - paper clip, bobby pin, bit of wire from a spiral notebook - and it pops right open.

You can identify a warded padlock by peering into the keyhole. It is almost empty inside, for it has no pins or wafers, no lock cylinder, and no shear line to worry about. There are no moving parts to line up in a warded padlock. When you press the catch, the lock will open.

There are some obstructions in the keyway between you and the catch. They are non-moving parts and are called *wards*. A ward is a narrow gate. You have to rotate whatever you stick in the keyhole to hit the catch. If the thing you stick in there isn't narrow where the ward is, you won't be able to twist it, as it will hit the ward.

Most warded padlocks have one catch, a few have two. They are always near the top of the lock by the shackle. To open the lock without a key, bend the tip of a paper clip, bobby pin, or similar wire over like the foot of the letter L. Work the tool into the lock, past the wards and twist it back and forth, moving it around a bit to find the latch. It is not a delicate or tricky matter - just wiggle the tip around near the top portion of the keyway, and visually check about every ten seconds or so to see if the lock opened. You may not feel it pick.

Small locks (about the size of a quarter) of this type open easily with an L shaped tool. Larger warded padlocks, however, are much easier to open with a tool that more nearly approximates the shape of the key. Keep the blade of the tool narrow so that it doesn't hang up on the wards. Make the tip of the tool about as wide as the keyhole entrance.

wards. Make the tip of the tool about as wide as the keyhole entrance. The shape of your tool may vary slightly. Usually, a cross-shaped piece of steel is optimum; however, even a bobby pin inserted round-end first, or a safety pin with the pointed side clipped off can work. You may have to thrash the tip of your tool around to spring the latch - don't be reckless, but remember that it is not a delicate mechanism, and you do have to fish around for it.

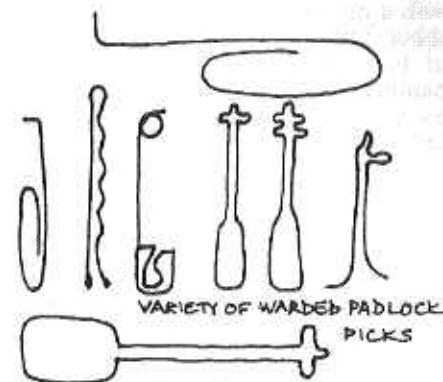

SIDE VIEW

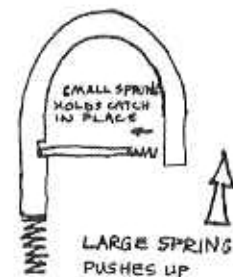

TOP VIEW

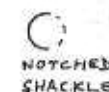
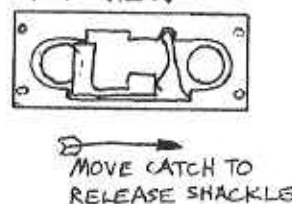

SAFETY CHAIN OPENING

You may leave through one door but find another door easier to open when you are locked out. If there is a safety chain holding it shut, you can open it with a piece of tape and a rubber band. Close one end of the tape over the rubber band. Open the door as far as you can and hook the rubber band over the slide bolt. Stick the tape to the door, stretching the rubber band. When you shut the door, wiggle it until the chain falls free of the door plate.

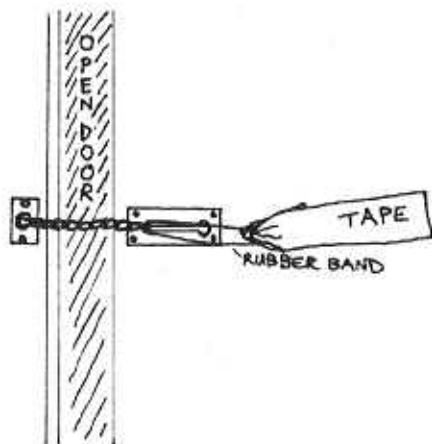

EMERGENCY CAR OPENING TOOL

A bucket handle is one of the easiest pieces of wire to find and it can be shaped into a car opening tool with little difficulty.



ENLARGED VIEW OF
BUCKET HANDLE TIP

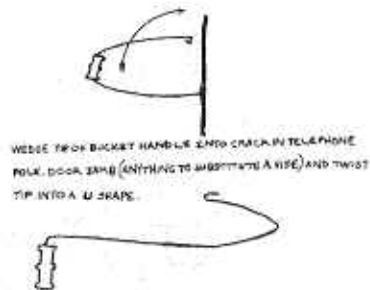
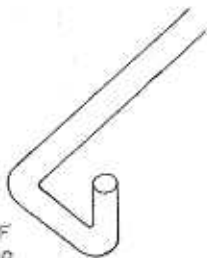

WEDGE TIP OF BUCKET HANDLE INTO CRACK IN TELEPHONE
POLE DOOR FRAME (ANYTHING TO ASSIST WITH A RISE) AND TWIST
TIP INTO A U SHAPE.

BEND WIRE AND SHAPE INTO APPROPRIATE TOOL.
SEE ACCORDING TO INSTRUCTIONS ON PAGES 11-93 & 99-03.