

U.S. MARINE CORPS
U.S. ARMY

This copy is a reprint which includes current
pages from Changes 1 through 3.

TM 05538C-10/1A
TM9-1005-319-10

**OPERATOR'S MANUAL
W/COMPONENTS LIST**

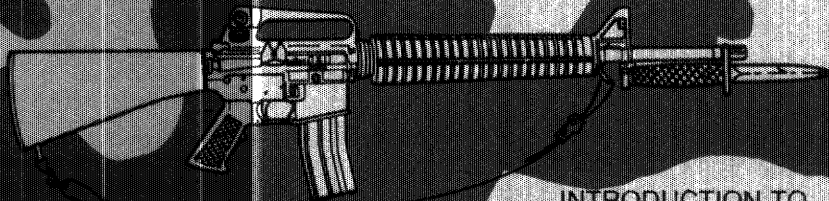

**RIFLE, 5.56-MM,
M16A2 W/E
(1005-01-128-9936)**

AUGUST 1986

INTRODUCTION TO YOUR WEAPON	PAGES 2-6
DISASSEMBLY	9-15
LUBRICATION	28-34
REASSEMBLY	35-40
MAGAZINE	41-42
PMCS	44-45
OPERATION	62-71
AMMUNITION	98-102

“MY RIFLE”

The creed of a United States Marine

by

Maj. Gen. W. H. Rupertus, USMC

This is my rifle. There are many like it, but this one is mine.

My rifle is my best friend. It is my life. I must master it as I must master my life.

My rifle, without me is useless. Without my rifle, I am useless. I must fire my rifle true. I must shoot straighter than my enemy who is trying to kill me. I must shoot him before he shoots me. I will...

My rifle and myself know that what counts in this war is not the rounds we fire, the noise of our burst, nor the smoke we make. We know that it is the hits that count. We will hit . . .

My rifle is human, even as I, because it is my life. Thus, I will learn it as a brother. I will learn its weaknesses, its strength, its parts, its accessories, its sights, and its barrel. I will ever guard it against the ravages of weather and damage. I will keep my rifle clean and ready, even as I am clean and ready. We will become part of each other. We will ...

Before God I swear this creed. My rifle and myself are the defenders of my country. We are the masters of our enemy. We are the saviors of my life.

So be it, until victory is America's and there is no enemy, but Peace!

U.S. ARMY

TM 9-1005-319-10
C3

CHANGE

HEADQUARTERS
DEPARTMENT OF THE ARMY

No. 3

Washington D. C. , 1 May 1994

Operator's Manual
W/COMPONENTS LIST
RIFLE, 5.56-MM,
M16A2 W/E (1005-01-128-9936)
AND
CARBINE, 5.56-MM,
M4 W/E, (1005-01-231-0973)

TM 9-1005-319-10, August 1986, is changed to add M4A1 Carbine to this TM. Changes are as follows:

Page Cover. Add "**CARBINE, 5.56-MM, M4A1, (1005-01-382-0953)**" to cover.

Page 1. **ALL WARNINGS** in this technical manual pertain to all weapons unless otherwise specified. Change the word rifle to "**weapons**", in all the warnings unless otherwise specified.

Page 2. Add the following before the first paragraph:
"When a procedure is common to the rifle and both carbines, **ONLY** the M16A2 rifle configuration will be depicted. If a procedure is not common to all weapons, the procedure will be incorporated identifying the weapon(s)."

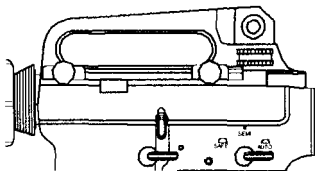

M4A1

- The M4 and M4A1 carbine buttstock has four positions; closed, 1/2 open, 3/4 open, and full open."
- M4A1 is fully automatic.

Page 3. Add M4A1 information as follows:

Weight: 6.36 lbs

Length: Buttstock closed 29.75 inches

Buttstock open 33.0 inches

Firing characteristics:

Muzzle velocity 2970 fps

Cyclic rate of fire 700-970 rounds per min

Max effective range:

500 meters (individual/point targets)

600 meters (area targets)

Page 3 (cont). Change M4 carbine weight to "3.32 Kg (7lb 5oz)".

Page 5. Add illustration of M4A1 upper receiver.

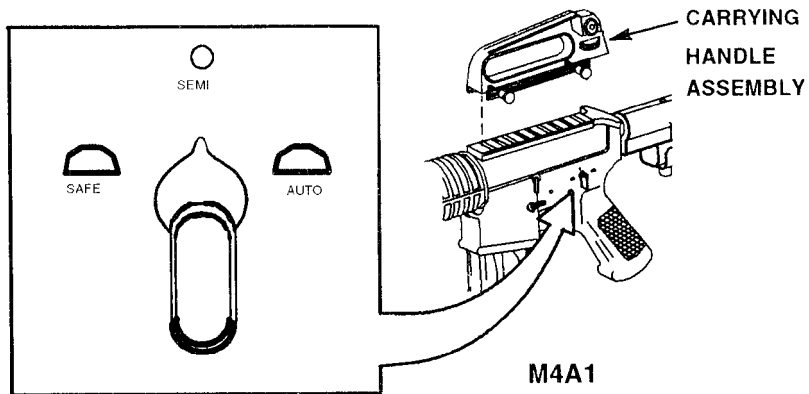

Page 6. Add the following note:

NOTE

M23 BFA is stamped "M4 Carbine Only", painted yellow and may be used on the M4 and M4A1 carbines. M15A2 BFA is painted red and used on the rifle.

Page 7. Add the following warning:

WARNING

To be considered SAFE before disassembly, cleaning, inspecting, transporting, or storing, the weapon must be cleared.

Page 11. Add the following caution:

CAUTION

Only use hand pressure to disengage the pivot and takedown pins. Force other than hand pressure may cause damage to the weapon and replacement of the weapon would be required. Only push the pivot and takedown pins far enough to disengage the upper receiver from the lower receiver.

Page 12. Add the following caution and procedure after step 11.

CAUTION

Do not fully remove the round nuts from the threaded studs. The threaded studs are flared on the end to prohibit removal. However, if the nuts are inadvertently removed, they may be reinstalled.

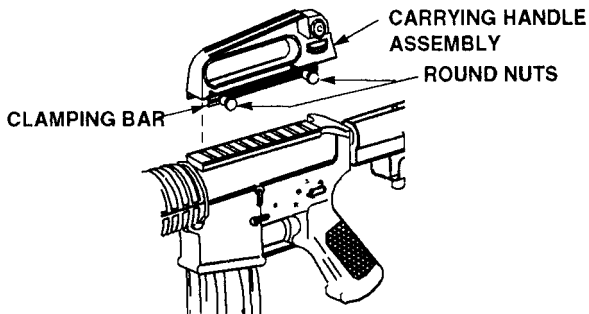

11.1. Loosen the round nuts on the left side of the carrying handle, approximately 4 turns. Loosen the clamping bar from the left side of the upper receiver and lift off the carrying handle assembly.

Page 15. Add NOTE after step 21:

NOTE

The M4/M4A1 carbine has a four position buttstock; closed, 1/2 open, 3/4 open, and full open.

Page 16. Add the following:

"Wherever the term CLP or the words lube or lubricant are cited in this TM, it is to be interpreted to mean that CLP, LSA, or LAW can be utilized as applicable. DO NOT mix lubricants on the same weapon. The weapon must be thoroughly cleaned during change from one lubricant to another. Dry cleaning solvent (SD) is recommended for cleaning during change from one lubricant to another."

Page 26. Add to the NOTE:

"If CLP is not used, RBC maybe used to remove carbon within the bore. Dry cleaning solvent may be used to completely remove lubricants."

Page 28. Add "LSA - Lubricating oil, semifluid, 2 oz plastic bottle, NSN 9150-00-935-6597"

Page 29. Add lubricating procedures for M4A1 upper receiver and carrying handle as follows:

1. Apply a drop or two of lubricant to both threaded studs.
2. Lightly lube the clamping bar and both round nuts.
3. Lightly lube the mating surfaces of the carrying handle assembly and upper receiver.

Page 38. Add caution, note, reassemble procedure, and illustration after step 8:

CAUTION

Should the round nuts and the clamping bar be inadvertently removed, the clamping bar must be reinstalled on the threaded studs in a manner not to protrude past the front of the carrying handle. The round nuts should be reinstalled on the threaded studs.

NOTE

DO NOT ATTEMPT to reflare the end of the threaded stud if the nuts have been removed.

“8.1. The carrying handle assembly should be reinstalled with the front stud positioned into the first notch in the front of the upper receiver mounting surface, Holding the carrying handle assembly flat against the top of the upper receiver, slide the clamping bar against the receiver with the lower edge underneath the slotted portion. Using finger pressure only, firmly tighten both round nuts.”

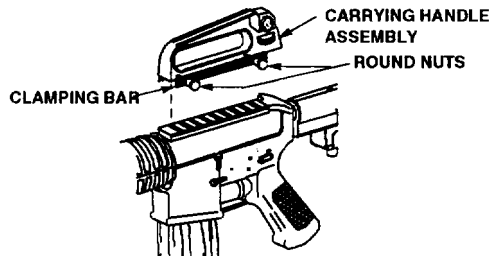

Page 41, Add the following step before the NOTE:

“inspect feeder lips for damage. If damaged, replace magazine.”

Page 45, Add to the BURST paragraph “**(M16A2 and M4 ONLY)**”.

Add “AUTO” to the functional check as follows:

“AUTO (M4A1 ONLY) - Pull the charging handle to the rear, cocking the weapon. Squeeze the trigger; hammer should fall. Hold the trigger to the rear and cock the weapon. Fully release the trigger then squeeze it to the rear again. The hammer should not fall because it should have fallen when the bolt was allowed to move forward during the cocking sequence. ”

Add the following to the PMCS table:

- 2.1 UPPER RECEIVER - Carrying Handle Assembly
Check for missing or damaged parts and insure the handle assembly will mount to the upper receiver.
Handle assembly is missing or has damaged parts,
or will not mount to upper receiver.

Page 47. Add Note under normal range paragraph:

NOTE

NORMAL RANGE M4A1 (300-600 METERS).

Page 50. Add "M16A2 ONLY" to the impact and distance columns in basic TM. Add the following information to the impact and distance columns:

1.2 cm (1/2 in)	25 meters (M4/M4A1 ONLY)
4.8 cm (1 7/8 in)	100 meters (M4/M4A1 ONLY)
9.6 cm (3 3/4 in)	200 meters (M4/M4A1 ONLY)

Page 51. Add "M16A2 ONLY" to the impact and distance columns in basic TM. Add the following information to the impact and distance columns:

0.5 cm (3/16 in)	25 meters (M4/M4A1 ONLY)
1.9 cm (3/4 in)	100 meters (M4/M4A1 ONLY)
4.8 cm (1 1/2 in)	200 meters (M4/M4A1 ONLY)
5.7 cm (2 1/4 in)	300 meters (M4/M4A1 ONLY)
7.6 cm (3 in)	400 meters (M4/M4A1 ONLY)

9.5 cm (3 3/4 in)	500 meters (M4/M4A1 ONLY)
11.4 cm (4 1/2 in)	600 meters (M4/M4A1 ONLY)
13.3 cm (5 1/4)	700 meters (M4 ONLY)
15.3 cm (6 in)	800 meters (M4 ONLY)

Page 56. Add to para 2., "600 meters maximum for M4A1."

Page 59. Add to first paragraph, second sentence, after 800 meters:,
"(M16A2 and M4) 500 or 600 meters (M4A1):

Para c, change the reference pages to "132-133"

Page 61. Add AUTO after burst paragraph:

"AUTO (M4A1 ONLY) - Carbine will continue to fire as long as the trigger is pulled."

Page 83. Replace FM 3-87, FM 21-40 AND TM 3-220 with FM 3-3, FM 3-4, FM 3-5, AND FM 3-100.

Page 86. Add after the first sentence in the Check For and What To Do columns:

Light indentation on the primer.	Notify unit armor.
-------------------------------------	--------------------

Page 103. Replace FM's 3-87, FM 21-40, and TM 3-220 with the following:

FM 3-3	NBC Contamination Avoidance
FM 3-4	NBC Protection
FM 3-5	NBC Decontamination
FM 3-100	NBC Defense, Chemical Warfare, Smoke, and Flame Operations
TM 3-4230-216-10	Operator's Manual for Decontaminating Kit, Skin: M258A1 and Training Aid, Skin De- contaminating: M58A1

Page 122. Add the word “Red” after (M16A2 only) for the blank firing attachment, M15A2.

Add “(M4A1) and the word Yellow” after (M4 Carbine) for the blank firing attachment, M23.

Page 123. Add the following item to the AAL:

8465-00-781-9564 CASE, MAINTENANCE EQUIPMENT: for
weapons wit bout buttstock stowage
(81349) MIL-C-43737
(CARBINE ONLY)

Page 129. Add the following items to the expendable list:

2.1 C 6850-00-224-6656 CLEANING COMPOUND, RIFLE BORE: OZ
small arms bore cleaning solution
(RBC) (81349) MIL-C-372
2 oz (59.15 ml) bottle

3.1 O 6850-00-281-1985 DRY CLEANING SOLVENT: GL
(58536) A-A-711
1 gal. (3.79 l) can

Page 130/(1 31 blank). Add the following item to the expendable list:

4.1 LUBRICATING OIL, WEAPONS: (LSA),
semifluid (81 349) MIL-L-46000

C 9150-00-935-6597	2 oz (59.1 5 ml) plastic btl	OZ
C 9150-00-889-3522	4oz(118.30 ml) plastic btl	OZ

Page 132 and 133. Chart

By Order of the Secretary of the Army:

GORDON R. SULLIVAN

General, United States Army

Chief of Staff

Official:

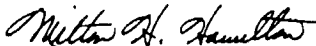

MILTON H. HAMILTON

*Administrative Assistant to the
Secretary of the Army*

06646

DISTRIBUTION: To be distributed in accordance with
DA Form 12-40-E, Block 0016 requirements for TM
9-1005-319-10.

U.S. ARMY

TM 9-1005-319-10
C2

CHANGE

HEADQUARTERS
DEPARTMENT OF THE ARMY

NO. 2

Washington, DC 23 June 1993

Operator's Manual
W/COMPONENTS LIST
RIFLE, 5.56-MM,
M16A2 W/E
(1005-01-128-9936)

TM 9-1005-319-10, August 1986, is changed to add the **M4 Carbine** to this TM. Changes are as follows:

Page Cover. Add "**CARBINE, 5.56-MM, M4 W/E, (1005-01-231-0973)**" to cover.

Page 1. Add the following WARNING:

WARNING

Be sure to clear weapon before disassembly, cleaning, inspecting, transporting, or storing.

Page 2. Add to the header after **RIFLE, "/CARBINE"**.

Add before the first paragraph:

When a procedure is common to M16A2 rifle and M4 carbine, **ONLY** the M16A2 configuration will be depicted. If a procedure is not common to both weapons, the procedure will be incorporated.

Add illustration of Carbine to this page.

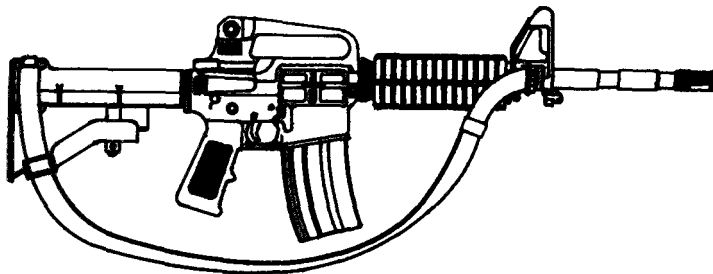

Page 3. Add the word "loaded" to the rifle information on line four before the word rounds.

Add carbine information as follows:

Weight: W/30 (loaded) rounds mag 3.31 Kg (7.5 lb)

Length: Buttstock closed 29.75 inches

ButtStock open 33.0 inches

Firing characteristics:

Muzzle velocity 2970 fps

Cyclic rate of fire 700-900 rounds per min

Max effective range:

500 meters (individual/point targets)

800 meters (area targets)

Change Max range 3534 meters to 3600 (for rifle and carbine)

Page 4. Add illustration of carbine buttstock to show lock release lever of buttstock:

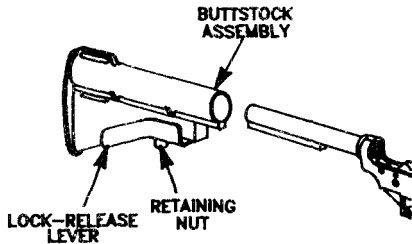

Page 6. Add "/M23" to the header after M15A2.

Page 9. Replace buttstock w/sling illustration with the following and add illustration of M4 Carbine sling:

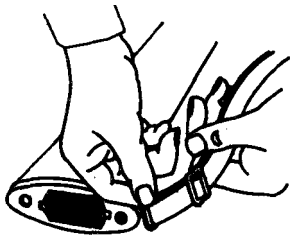
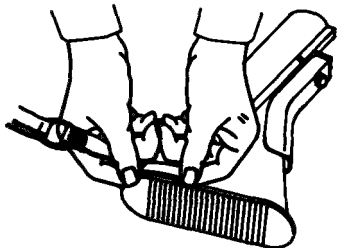

Page 10. Add caution before the NOTE.

CAUTION

Do not use a screwdriver or any other tool when removing the handguards. Doing so may damage the handguard and/or Sliping.

Page 15. Add the following steps as follows:

"CARBINE ONLY

21 Extend buttstock assembly.

22 Grasp the lock release lever in the area of the retaining nut, pull downward, and slide buttstock to the rear to separate the buttstock assembly from the lower receiver extension. "

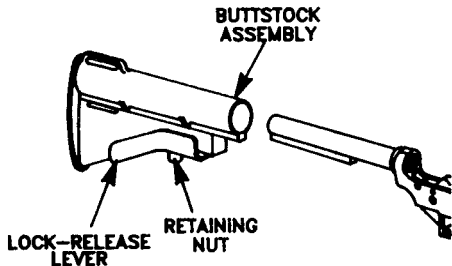

Page 22. Add "Clean carbine lower receiver extension and buttstock."

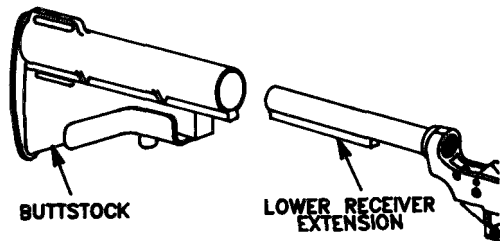

Page 28. Lube guide change "0 F AND -35 F" to "+10 F AND - 10 F".

Change the thermometer to correspond with the text.

Page 35. Add to reassembly before step 1:

"Grasp the lock release lever in the area of the retaining nut and pull to reinstall the buttstock assembly onto the lower receiver extension."

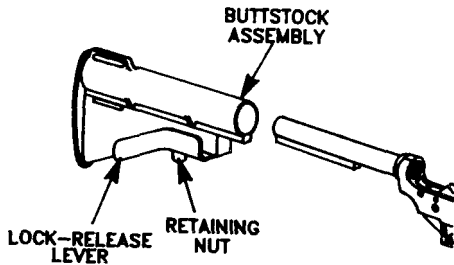

Page 40. Replace buttstock illustration with the following and add illustration of sling being put on carbine.

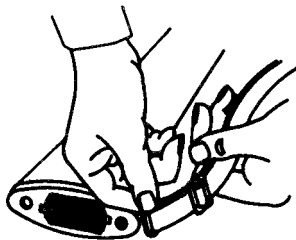
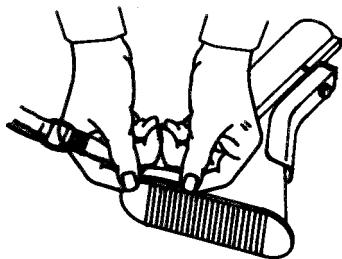

Page 45. Add the Operator Preventive Maintenance Checks and Service (PMCS):

WARNING

Before starting an inspection, be sure to clear the rifle (p. 7). Do not squeeze the trigger until the rifle has been cleared. Inspect the chamber to ensure that it is empty and no ammunition is in position to be chambered. Do not keep live ammunition near work area.

	B - Before Operation	D - During Operation	A - After Operation	
Item No.	Interval	ITEM TO BE INSPECTED	Equipment is NOT	READY/AVAILABLE IF:
1	B D A	Procedure		
		MAGAZINE.		
		<ul style="list-style-type: none">a. Magazine slips easily into the magazine well and locks in place. Magazine is distorted or is hard to seat in magazine well.		

B - Before Operation D - During Operation A - After Operation
 Item Interval ITEM TO BE INSPECTED Equipment is NOT
 No. B D A Procedure READY/AVAILABLE IF:

- b. Magazine follower has spring tension and moves easily inside of magazine.
 Magazine follower is stuck or has weak spring tension.

2

UPPER RECEIVER - Barrel

- Check for barrel looseness (using hand pressure only).
 Barrel is loose enough to be moved by hand.

3

LOWER RECEIVER - Magazine Catch. Check maga-

- zine catch for spring tension and retention of magazine.
 (NOTE: Perform this check with the rifle assembled).
 Magazine catch has no spring tension or does not retain magazine.

B - Before Operation D - During Operation A - After Operation
Item Interval ITEM TO BE INSPECTED Equipment is NOT
No. B D A Procedure READY/AVAILABLE IF:

- 4 • **RIFLE SIGHTS (ZERO ADJUSTMENT).** Move front and rear sight to make sure they can be adjusted. Return sights to zero setting of your rifle.
If the sights are damaged, missing, or can't be adjusted.
- 5 • **MAGAZINE CATCH (FUNCTION).** Insert magazine into the well. The magazine catch should hold the magazine in place. Pressing the magazine catch button should release the magazine. To adjust the magazine catch, use cleaning rod to press in on the magazine catch button until the left side of the magazine catch sticks out beyond the receiver.

B - Before Operation D - During Operation A - After Operation
Item Interval ITEM TO BE INSPECTED Equipment is NOT
No. B D A Procedure READY/AVAILABLE IF:

5 • MAGAZINE CATCH (FUNCTION)--cont.

To tighten, turn the magazine catch clockwise; to loosen, turn it counterclockwise.

If the magazine catch will not retain or release the magazine.

B - Before Operation D - During Operation A - After Operation
Item Interval ITEM TO BE INSPECTED Equipment is NOT
No. B D A Procedure READY/AVAILABLE IF:

6 • **VISUAL INSPECTION OF RIFLE.**

WARNING

Be sure rifle is clear. Refer to pages 7 and 8.

Look the rifle over for missing or damaged parts. Report missing or damaged parts to unit armorer.

Parts are missing or damaged to a point of being unserviceable.

- 7 • **PERIODIC INSPECTION OF RIFLE.** Periodically check rifle to make sure it's clean and there is no foreign material in bore. If foreign material is in bore, clean bore (page 76).
If foreign material is in bore.

B - Before Operation D - During Operation A - After Operation
Item Interval ITEM TO BE INSPECTED Equipment is NOT
No. B D A Procedure READY/AVAILABLE IF:

8 • MAINTENANCE PERFORMED DURING FIRING OPERATIONS

WARNING

Be sure rifle is clear. Refer to pages 7 and 8.

Clean and lubricate rifle after firing approximately 200 rounds of ammunition (page 29) or at the end of the day.

- 9 • MAINTENANCE OF RIFLE AND EQUIPMENT.** Disassemble rifle (page 9). Clean and lubricate according to pages 16 thru 34. Disassemble magazine. Clean and lubricate according to page 41. Clean and lubricate bayonet and scabbard. Report all damaged or missing parts to unit armorer.

Page 45. Add the word "slowly" after the fourth sentence, "Pull charging.release slowly. "

Change the next sentence to read "Slowly release the trigger without stops or hesitations. Pull the trigger."

Add **NOTE** after SEMI paragraph:

NOTE

Slow is defined as 1/4 to 1/2 the normal rate of trigger release.

Change the wording in BURST paragraph, fifth sentence, to read, "Pull charging handle to rear and release three times.

Page 52-55. Delete "U.S. MARINE CORPS" from each page because Army will use this information.

Page 53. Add to step 4, after the second sentence, "ARMY rifles will have the 300 meter mark set on the last whole click before it bottoms out.

Page 71. Add after header, "Your weapon is now combat ready; e.g., ammunition loaded, bolt forward, and safety on."

Page 119. Add two slings as follows:

3	1005-01-216-4510	SLING, SMALL ARMS (M16A2)	EA	1
		(19204) 12624561		

4	1005-01-368-9852	SLING, SMALL ARMS (M4 Carbine)	EA	1
		(19200) 12011996		

Page 122. Add after BFA, M15A2: "(M16A2 Only)".

Page 124. Change the quantity "1" for the magazine, cartridge to "6".

By Order of the Secretary of the Army:

GORDON R. SULLIVAN
General, United States Army
Chief of Staff

Official:

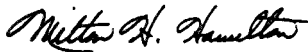

MILTON H. HAMILTON

Administrative Assistant to the
Secretary of the Army

04298

DISTRIBUTION: To be distributed in accordance with
DA Form 12-40-E, Block 0016, requirements for
TM 9-1005-319-10.

U.S. MARINE CORPS
U.S. ARMY

TM 05538C-10/1A
TM 9-1005-319-10
C1

CHANGE
NO. 1

HEADQUARTERS
DEPARTMENT OF THE ARMY
Washington, DC, *11 May 1990*

Operator's Manual
W/COMPONENTS LIST
RIFLE, 5.56-MM,
M16A2 W/E
(1005-01-128-9936)

TM 9-1005-319-10, August 1986, is changed as follows:

Page 62. Add the following **WARNING** under the heading **OPERATION**.

WARNING

With the bolt carrier assembly locked to the rear or in its forward position, if the weapon is dropped or jarred with a loaded magazine in place, it could chamber a round.

By Order of the Marine Corps:

H. E. REESE
Deputy for Support
Marine Corps Research, Development
and Acquisition Command

By Order of the Secretary of the Army:

OFFICIAL:

CARL E. VUONO
General, United States Army
Chief of Staff

WILLIAM J. MEEHAN II
Brigadier General, United States Army
The Adjutant General

DISTRIBUTION:

**To be distributed in accordance with DA Form 12-40E (Block 16), Operator
Maintenance Requirements for TM 9-1005-319-10.**

WARNING

For information on First aid,
see FM 21-11.

BEWARE OF DANGEROUS PROCEDURES

- Be sure the cam pin is installed in the bolt **group**. If it isn't, your rifle can still fire and will explode,
- If you're using the blank firing attachment, don't use any other ammo except the blank round M200 (marked on each box of 20 rounds).
- DO NOT exchange or switch bolt assemblies from one M16A2 to another. Doing so may result in injury to, or death of, personnel.
- If your rifle stops firing with a live round in the chamber of a hot barrel (misfire), remove the round fast. However, if you cannot remove it within 10 seconds, remove magazine and wait 15 minutes with the rifle pointing in a safe direction. This way you won't get hurt by a possible round cooking-off. Regardless, keep your face away from the ejection port while clearing a hot chamber.
- Use only authorized ammo that is manufactured to U.S. or NATO specifications.
- If your bolt fails to unlock and you try to free it by banging the buttstock on the ground keep yourself clear of the muzzle,
- If there's water in the barrel, don't fire the rifle. It could explode.
- If a noticeable difference in sound or recoil is experienced, STOP FIRING. Either condition could indicate an incomplete powder burn and/or a bullet stuck in the bore

FACTS ABOUT YOUR RIFLE

The M16A2 rifle system consists of a rifle, a magazine, and a sling. It is a lightweight, gas-operated, air-cooled, magazine-fed, shoulder-fired weapon that can be fired either in automatic three-round bursts or semiautomatic single shots. Other features:

- Upper receiver and barrel assembly has a fully adjustable rear sight and a compensator that helps keep the muzzle down during firing.
- Upper and lower receivers are easily opened for cleaning and inspection.
- Bolt group and barrel extension are designed with locking lugs that lock bolt group to barrel extension.
- An aluminum receiver reduces the weight of the rifle.
- The bore and chamber are chrome plated.

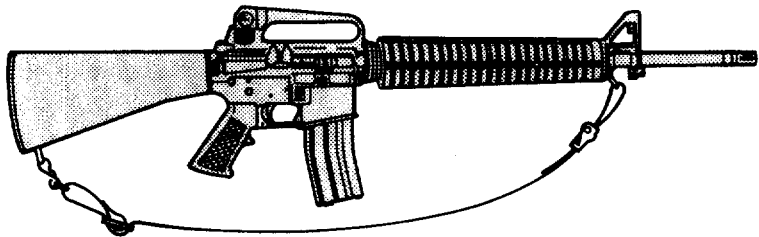

Caliber:

5.56 mm

Weight:

W/30 rounds mag 3.99 Kg (8.79 lb) approx

Length:

Rifle w/compensator 39 5/8 inches

Mechanical features:

Rifling (RH 1/7 twist)

Firing characteristics:

Muzzle velocity (approx) 3,100 fps

Chamber pressure 52,000 psi

Cyclic rate of fire (approx) 800 rounds per min

Max effective rates of fire:

Semi : 45 rounds per min

Burst: 90 rounds per min

Sustained rate of fire:

12/15 rounds per min

Max effective range:

550 meters (individual/point targets)

800 meters (area targets)

Max range:

3534 meters

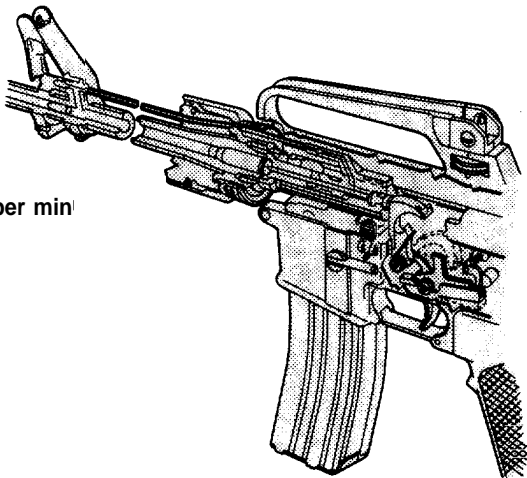

RIFLE PARTS AND . . .

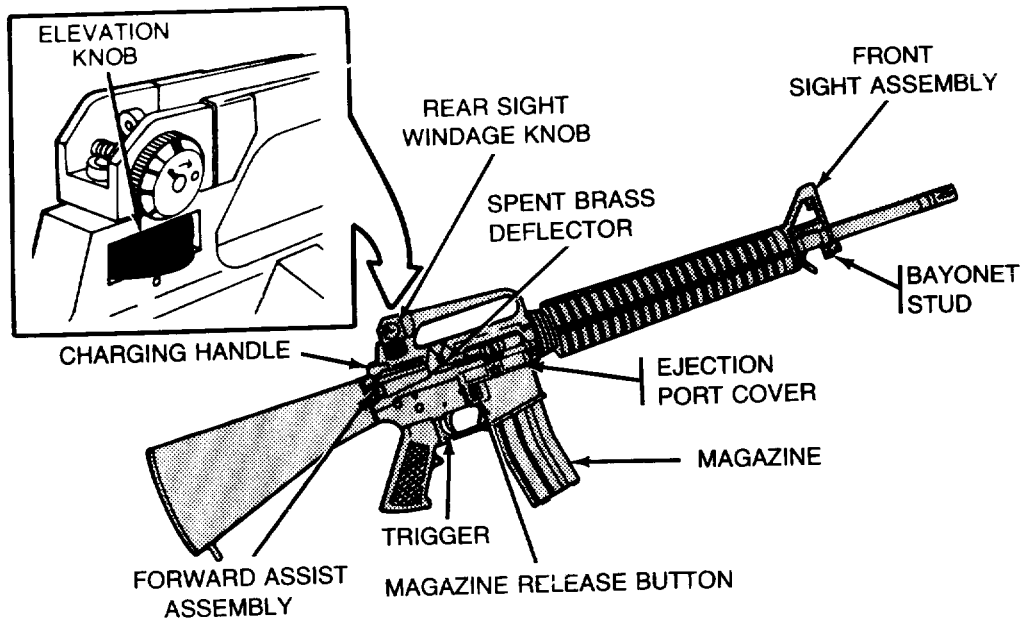

... WHERE THEY ARE

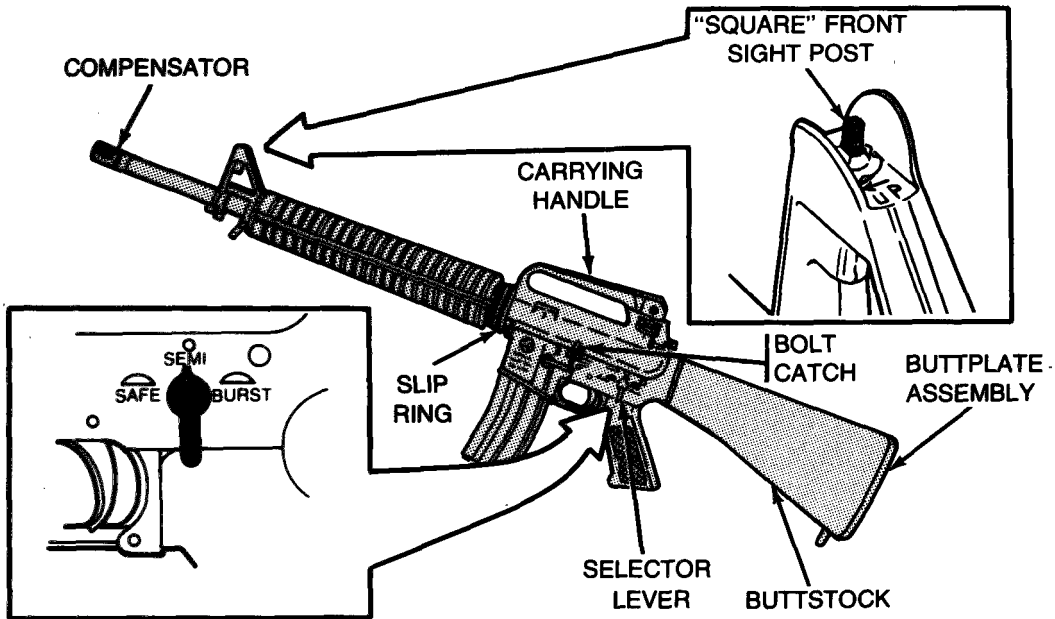

M15A2 BLANK FIRING ATTACHMENT (BFA)

WARNING

Use **ONLY** blank M200 with the BFA.

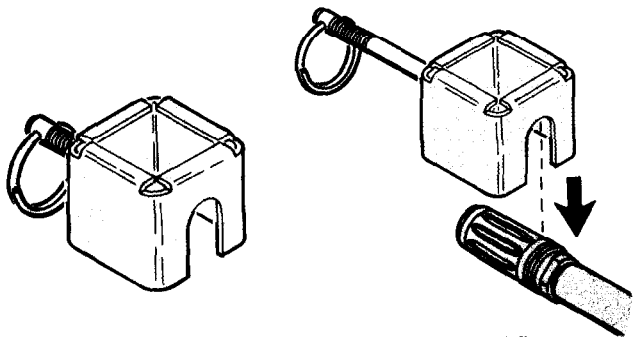

1 Unscrew and slide all the way back.

2 Hook behind first groove of compensator.

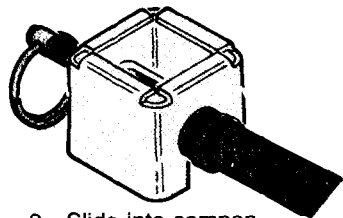

3 Slide into compensator and **HAND TIGHTEN**.

CAUTION: Do not use tools to adjust attachment: **HANDS ONLY.**

NOTE: After 50 rounds, check to see if it is still tight. Make sure to clean carbon buildup after each use.

CLEAR YOUR RIFLE

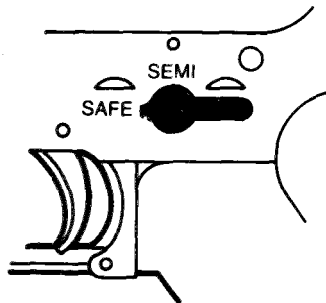

- 1 Point in a SAFE DIRECTION!
Place selector lever on SAFE.
If weapon is not cocked, lever cannot be pointed toward SAFE.

PRESS
CATCH BUTTON

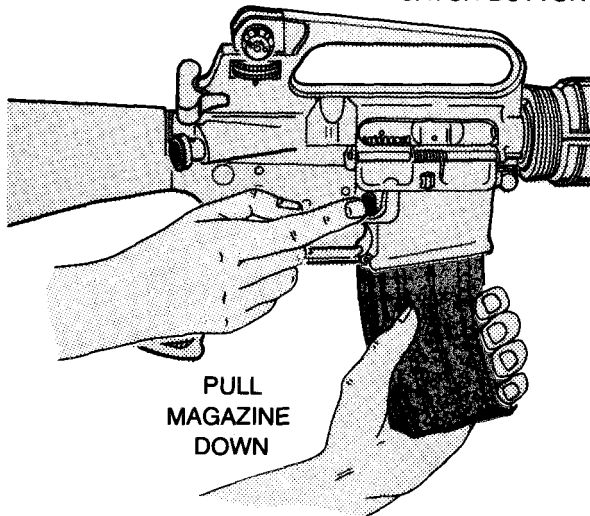

- 2 Remove magazine.

CLEAR YOUR RIFLE (CONT)

- 3 To lock bolt open, pull charging handle rearward. Press bottom of bolt catch and allow bolt to move forward until it engages bolt catch. Return charging handle to forward. If you haven't before, place selector lever on SAFE.
- 4 Check receiver and chamber to ensure these areas contain no ammo.
- 5 With selector lever pointing toward SAFE, allow bolt to go forward by pressing upper portion of bolt catch.

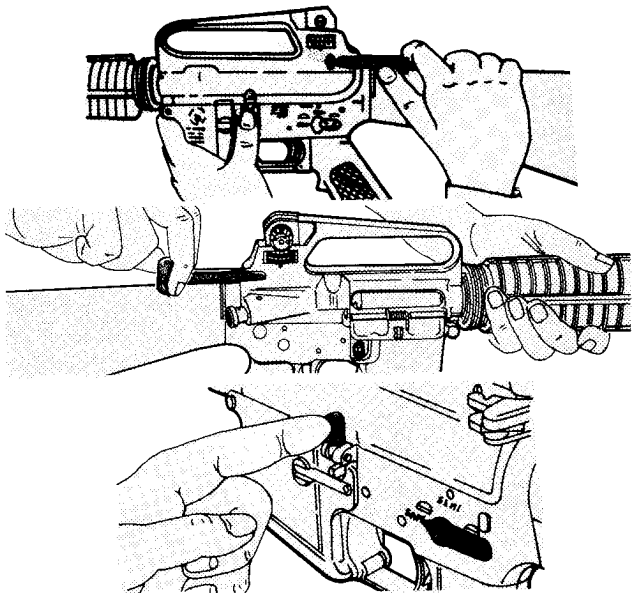

DISASSEMBLY

CLEAR YOUR RIFLE.

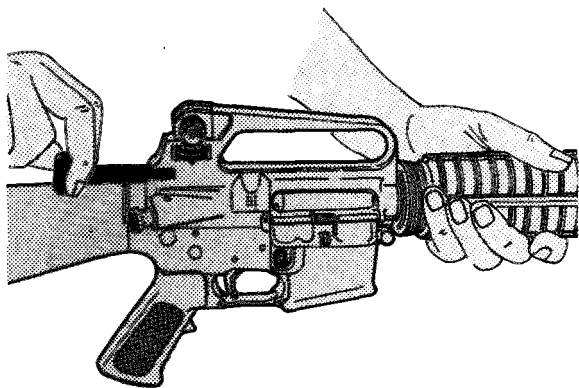

1 Clear your rifle (see page 7).

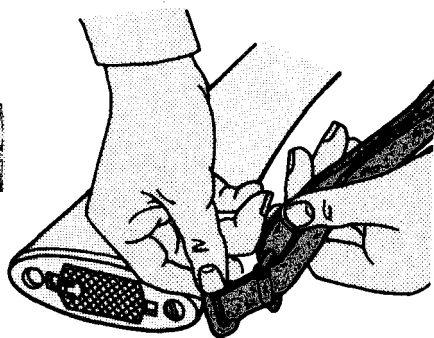

2 Unsnap sling.

DISASSEMBLY

The "BUDDY SYSTEM"

- 3 Place the rifle on the buttstock and press down on the slip ring with both hands.
- 4 Have your buddy pull the handguards free.

NOTE:

The new wood handguards are identical and can be interchanged (top or bottom).

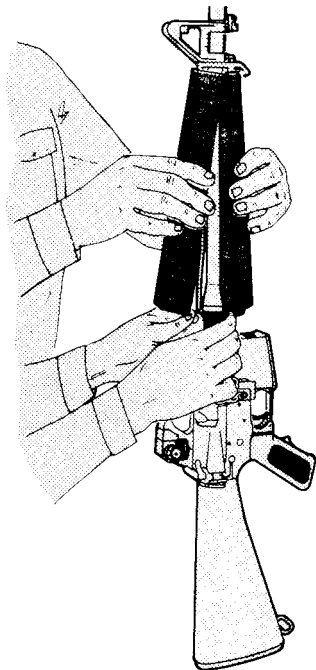

- 5 Install the handguards using the same system.

DISASSEMBLY (CONT)

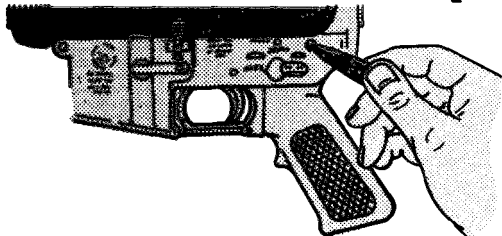

6 Push takedown pin as far as it will go. Pivot upper receiver from lower receiver.

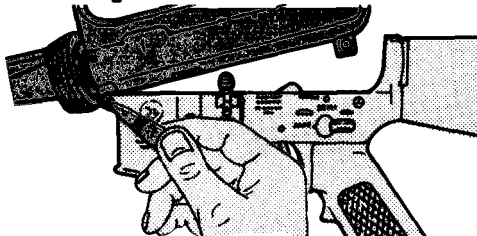

7 Push receiver pivot pin.

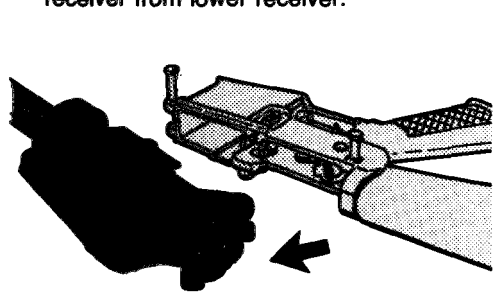

8 Separate upper and lower receivers.

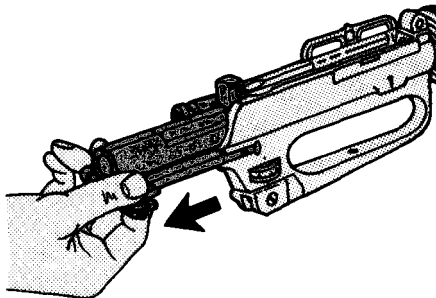

9 Pull back charging handle and bolt carrier.

DISASSEMBLY (CONT)

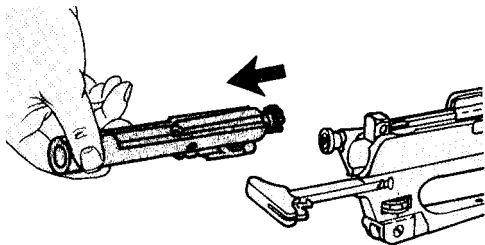

10 Remove bolt carrier and bolt.

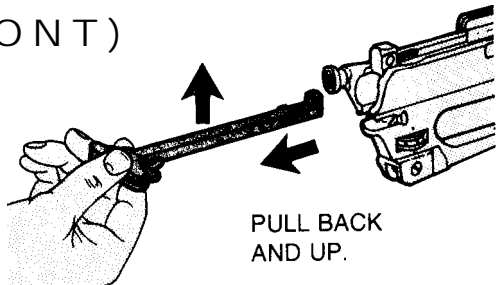

11 Remove charging handle.

12 Remove firing pin retaining pin.

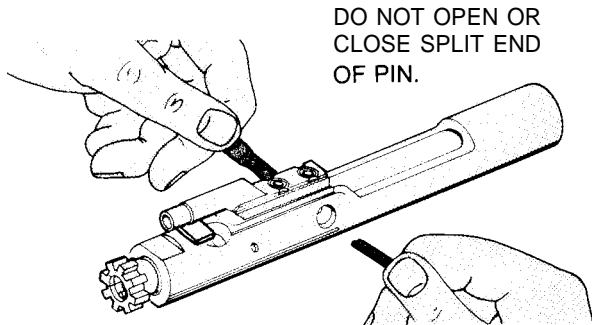

DISASSEMBLY (CONT)

PUSH IN.

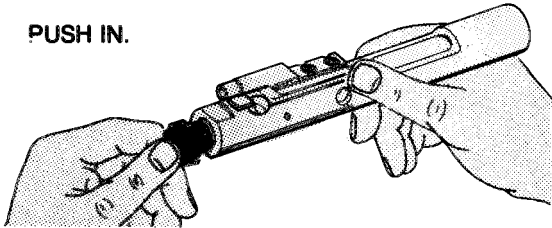

13 Put bolt assembly in locked position.

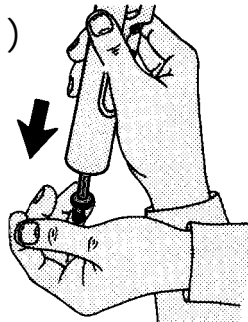

14 Drop firing pin out rear of bolt carrier.

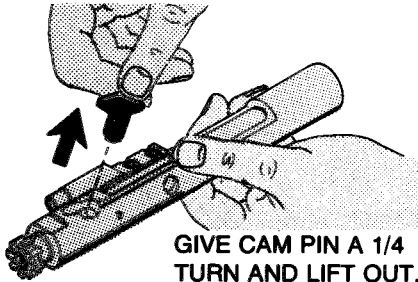

15 Remove bolt cam pin.

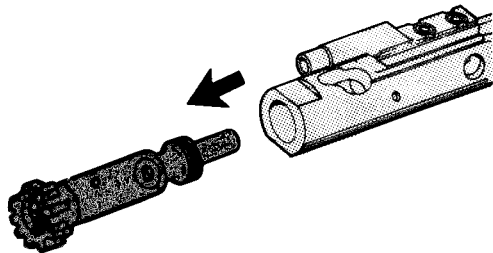

16 Remove bolt assembly from carrier.

DISASSEMBLY (CONT)

DISASSEMBLE USING STEPS 17 THRU 20 ONLY WHEN DIRTY OR DAMAGED.

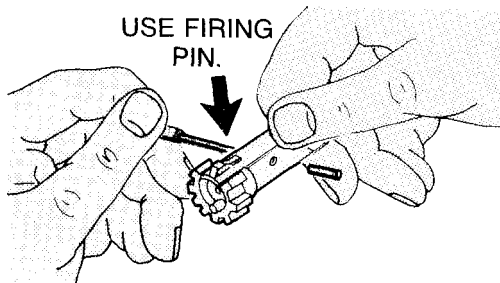

NOTE

Push rear of extractor to check spring function.

See your ARMORER if spring is weak.

Do not damage tip of firing pin.

17 Remove extractor pin.

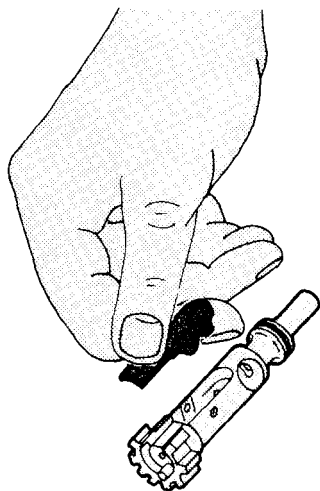

18 Remove extractor and spring.

DISASSEMBLY (CONT)

- 19 Press in buffer, depress retainer, and release buffer.

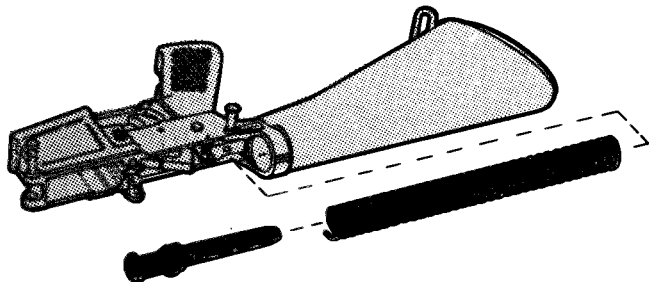
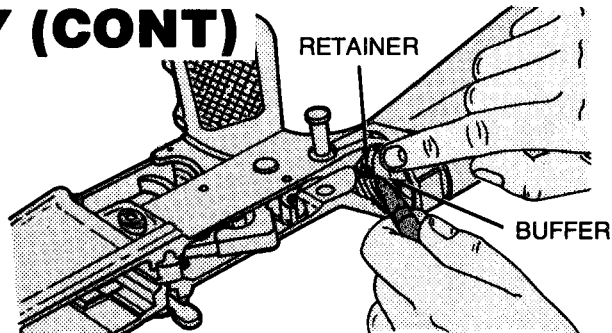

- 20 Remove buffer and action spring.



**NO FURTHER
DISASSEMBLY
ALLOWED.**

CLEAN . . . INSPECT . . . LUBE

With the rifle disassembled, thoroughly clean, inspect, and lube.

Always shake CLP before use.

After firing, clean your weapon with CLP according to instructions on page 26. Wipe dry and lube according to lubrication instructions.

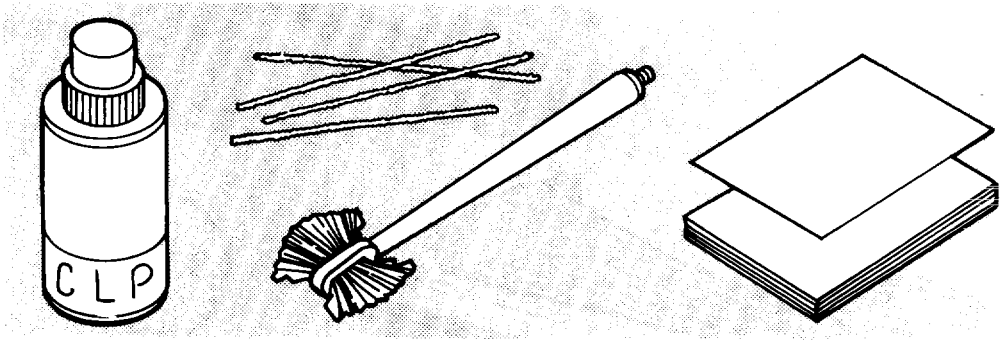

Cleaning materials: swabs, pipe cleaners, and CLP are expendable items that are available from Company Supply.

If any parts are missing or defective, see your ARMORER.

DETAILED CLEANING TECHNIQUES

Don't mix up the parts of your rifle with those of your buddy.

BORE. The bore of your M16A2 has lands and grooves called rifling. Rifling makes the bullet spin very fast as it moves down the bore and down range. Because it twists so quickly, it is difficult to push a new, stiff bore brush through the bore. You will find it much easier to pull your bore brush through the bore. Also, because the brush will clean better if the bristles follow the grooves (called tracking), you want the bore brush to be allowed to turn as you pull it through. This is how you do it:

- 1 Swab out the bore with a patch moistened with CLP.
- 2 Attach three rod sections together but leave each one about two turns short of being tight.
- 3 Attach the bore brush but leave it two turns short also.

NOTE

This whole process will go quicker if you use the "buddy system" on the cleaning rods. Set one rod up with a patch holder and the other with a bore brush.

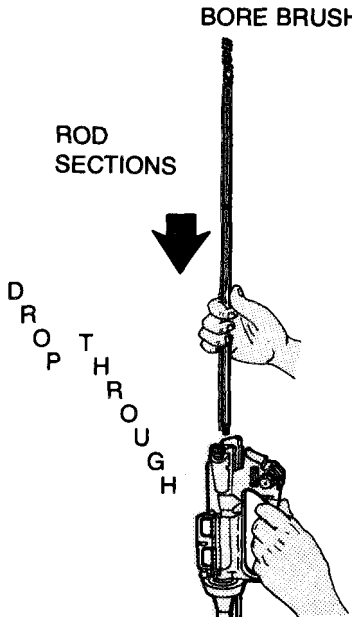

DETAILED CLEANING TECHNIQUES (CONT)

- 4 Point muzzle down. Hold the upper receiver in one hand while inserting the end of the rod **without the brush** into the chamber. Let the rod fall straight through the bore. About 2-3 inches will be sticking out of the muzzle at this point.
- 5 Attach the handle section of the cleaning rod to the end of the rod sticking out of the muzzle.
- 6 Pull the brush through the bore and out the muzzle. If you watch closely, you can see the rod twisting as you pull it.
- 7 After one pull, take off the handle section and repeat the process. After three or four pulls, you will see that the three rod sections and the bore brush are screwing together. Loosen them up and repeat the process.

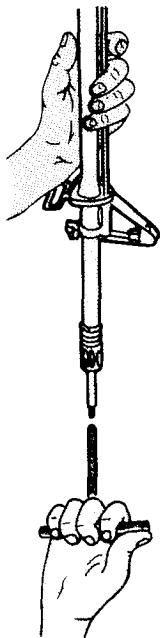

ATTACH
HANDLE

DETAILED CLEANING TECHNIQUES (CONT)

- 8 Send a patch through the bore once in a while to help clean out the crud that the brush is getting loose. You can use the same technique as described above to save time. Just replace the bore brush with the rod tip (patch holder) and a wet patch. Drop it through. You won't need to attach the handler to pull only a patch through. If you leave the rods loose again, the patch will "track" in the rifling as before. But remember, always have the bore **wet with cleaner** before trying to pull a brush through.

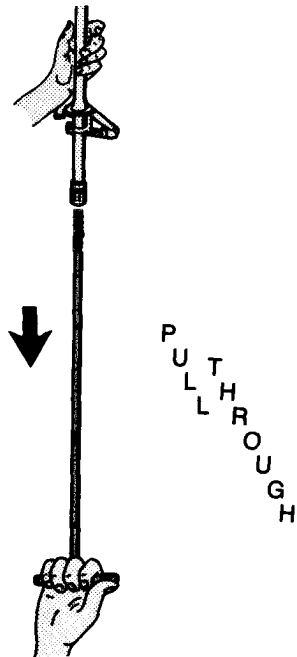

THOROUGH CLEANING

upper receiver

CLEAN WITH CLP

- All Areas of Powder Fouling, Corrosion, Dirt, and RUST
- Bore and Chamber
- Locking Lugs
- Gas Tube

START AT RECEIVER AND DROP ROD AND BRUSH THROUGH.

ATTACH HANDLE AND PULL THROUGH THE COMPENSATOR.

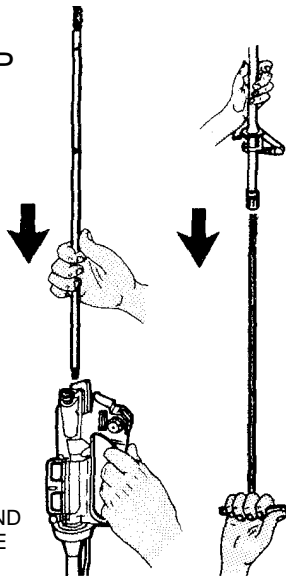

WHEN USING BORE BRUSH, DON'T REVERSE DIRECTION WHILE IN BORE.

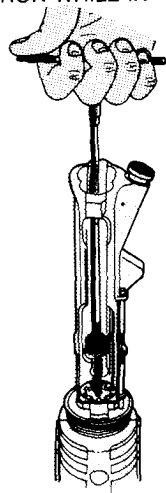

CLEAN BOLT LUGS

THOROUGH CLEANING (CONT)

bolt carrier group

- Outer and Inner Surfaces of Bolt Carrier
- Carrier Key
- Firing Pin Recess and Firing Pin
- Firing Pin Hole (Use Pipe Cleaner.)
- Carbon Deposits and Dirt from Locking Lugs
- Areas Behind Bolt Ring and Under Lip of Extractor

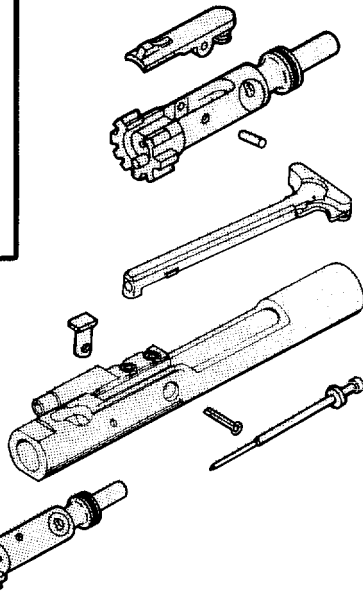
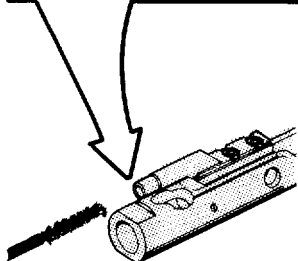
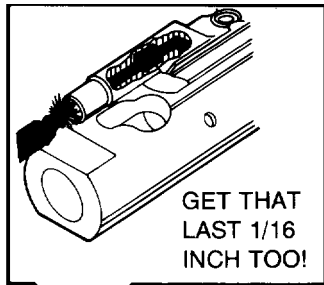

THOROUGH CLEANING (CONT)

lower receiver group

- All Areas of Powder Fouling, Corrosion, and Dirt.
- Wipe Dirt from Trigger Mechanism.
- Clean Buffer, Action Spring, and Inside Lower Receiver Extension.

CAUTION

Do not use wire brush or any type of abrasive material to clean aluminum surfaces.

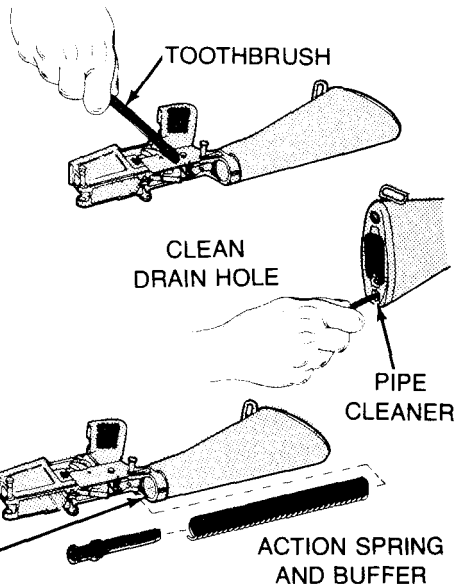
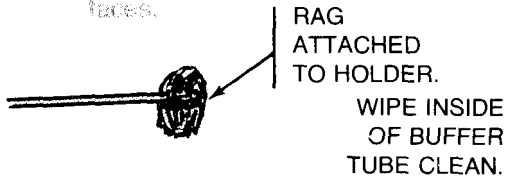

THOROUGH CLEANING (CONT)

ejector

The design of the ejector makes its disassembly for cleaning by you, the operator, impractical. Make sure your M16A2 ejects those empty cases clear of you and your rifle by following these steps on a monthly or as required (weekly if firing blanks) basis.

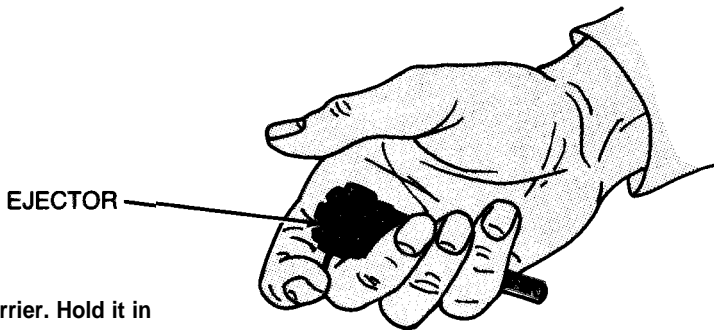

- 1 Remove bolt from carrier. Hold it in your hands as shown with ejector down and extractor up.

THOROUGH CLEANING (CONT)

ejector (cont)

- 2 Place a few drops of CLP around the ejector to form a puddle.

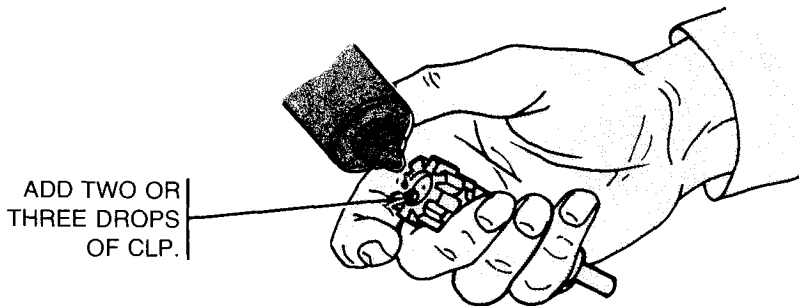

THOROUGH CLEANING (CONT)

ejector (cont)

- 3 Take a fired or dummy case and place it under the lip of the extractor. With a rocking motion, press the case down against the ejector. Since the ejector is spring loaded, some resistance will be felt. Press on the case until it stops against the bolt face. Ease off with your thumb slightly and press down again. Repeat several times. Replace the CLP frequently. Once the spring action of the ejector is smooth and strong, dry off any excess.

**HOOK CASE UNDER
EXTRACTOR AND ROCK
BACK AND FORTH
AGAINST EJECTOR.**

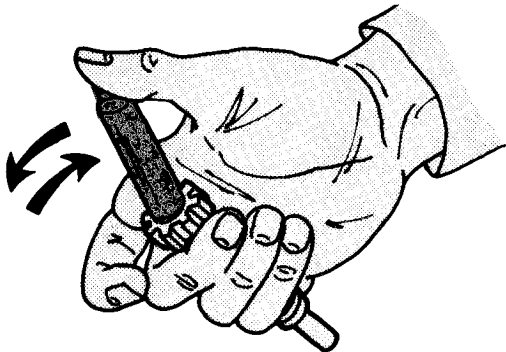

ADVICE ON THE USE OF CLP

CLP - Cleaner, Lubricant and Preservative - does three things at once:

ONE - It contains solvents to dissolve firing residue and carbon.

TWO - It lays down a layer of Teflon as it dries to provide lubrication.

THREE - It prevents rust from forming.

Use CLP as follows:

- a. Always shake bottle well before use.
- b. Place a few drops on a patch or rag.
- c. Clean your rifle with these patches and rags until they come out clean.
- d. Take a clean patch or rag and apply a fresh, light coat.

NOTE

Don't "dry clean" your rifle. DO NOT use hot water or other solvents or you will wash away the Teflon lubricant that has been building up as a result of your using CLP.

INSPECT = before lubricating

DO NOT interchange bolts between rifles.

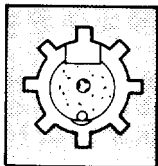
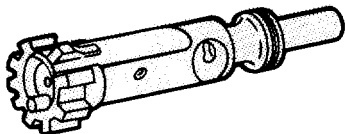

BOLT - Cracks or fractures, especially in the cam pin hole area; bolts that contain pits extending into the firing pin hole need replacing.



FIRING PIN - Bent, cracked, blunted, or sharp end

IF PARTS ARE MISSING OR DEFECTIVE, SEE YOUR ARMORER.



FIRING PIN RETAINING PIN - Bent or badly worn

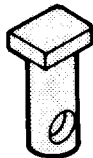

CAM PIN - Cracked, chipped, or missing

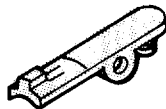

EXTRACTOR AND EXTRACTOR SPRING

Check extractor for chipped or broken edges in the area of the lip that engages the cartridge rim. Check that the rubber insert is inside the extractor spring.

LUBE GUIDE

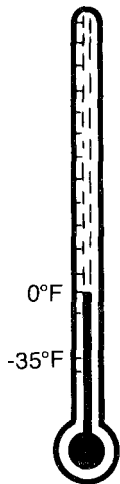

Under all but the coldest Arctic conditions, CLP is the lubricant to use on your rifle. Remember to remove excessive CLP from the bore and chamber before firing.

CLP - Cleaner, lubricant and preservative
Refillable 1/2 oz bottle
NSN 9150-01-102-1473

BETWEEN 0°F AND -35°F EITHER CLP OR LAW

LAW - Lubricating oil, Arctic weapons
1 qt can
NSN 9150-00-292-9689

Lightly Lubed - A film of CLP barely visible to the eye

Generously Lubed - Heavy enough so that it can be spread with the finger

LUBRICATING upper receiver

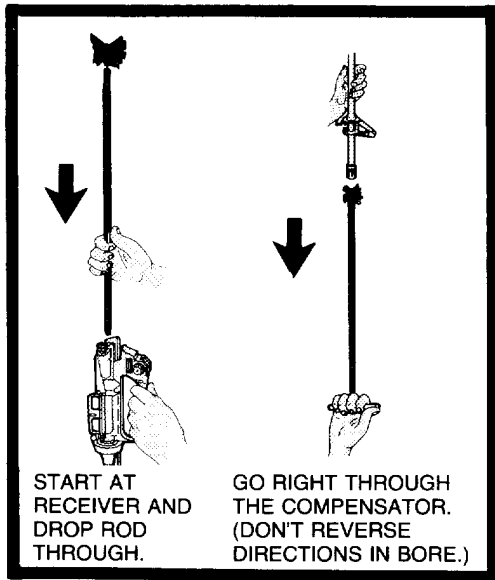

Lightly lube inside of upper receiver, bore and chamber, outer surfaces of barrel and front sight, and surfaces under hand-guard. Depress front sight detent and apply two or three drops CLP to front sight detent. Depress several times to work lube into the spring.

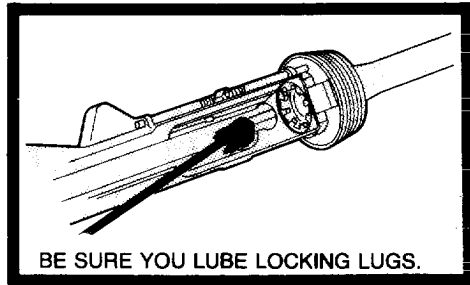
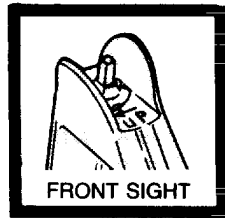

LUBRICATING (Cont)

bolt carrier group

CAUTION

Use only a light coat of CLP on firing pin and firing pin recess in bolt.

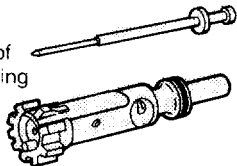

DRY WITH PIPE CLEANER; THEN PLACE ONE DROP CLP.

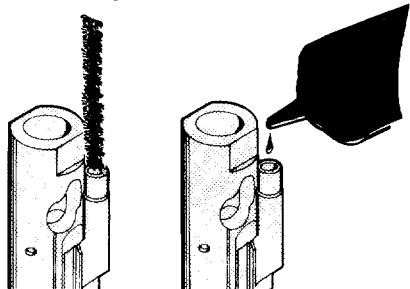

CARRIER KEY

GENEROUSLY LUBE OUTSIDE OF THESE PARTS.

MAKE CERTAIN TO GET CAM PIN AREA, BOLT RINGS, AND OUTSIDE OF THE BOLT BODY. PUT A LIGHT COAT ON EXTRACTOR AND PIN.

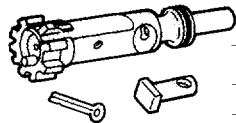

LIGHTLY LUBE CHARGING HANDLE AND INNER- AND OUTER SURFACES OF BOLT CARRIER. GENEROUSLY LUBE SLIDE AND CAM PIN AREA OF BOLT CARRIER.

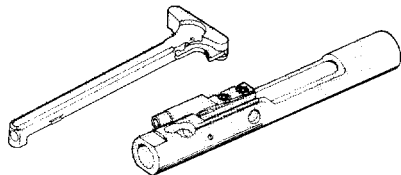

LUBRICATING (Cont)

lower receiver group

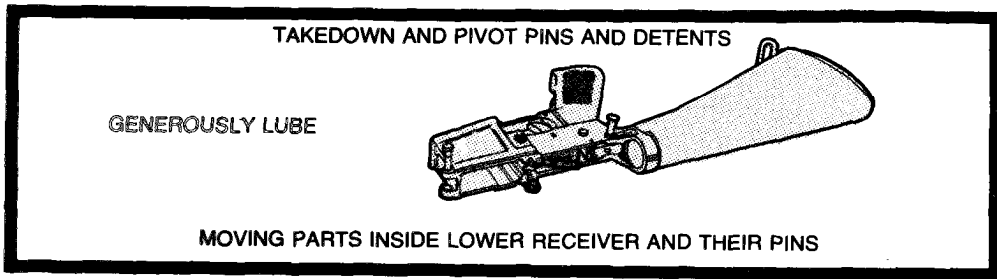
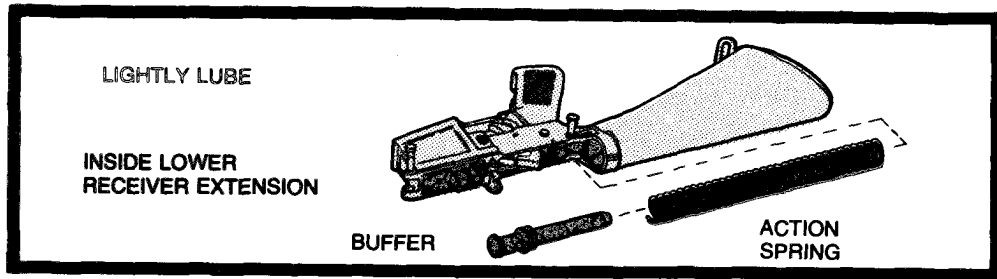

LUBRICATING (Cont)

adjustable rear sight

NOTE

Make a note of how far you move the sights so they can be returned to their original position at completion of this task.

MOVING PARTS. Use one or two drops of CLP. Rotate these parts (see page 33) to ensure lubricant is spread evenly above and below:

- a. Elevation knob
- b. Elevation screw shaft
- c. Windage knob (maximum five clicks left or right)
- d. Windage screw
- e. Detent holes

ELEVATION SCREW SHAFT. Also lube from inside the upper receiver as follows:

- a. Turn upper receiver upside down.
- b. Remove charging handle.
- c. Put two or three drops on bottom of elevation screw shaft and in elevation detent spring hole.
- d. Rotate the elevation dial back and forth a few times while keeping upper receiver upside down.

LUBRICATING (Cont)

adjustable rear sight (cont)

LUBRICATE AND KEEP EXTRA CLEAN*

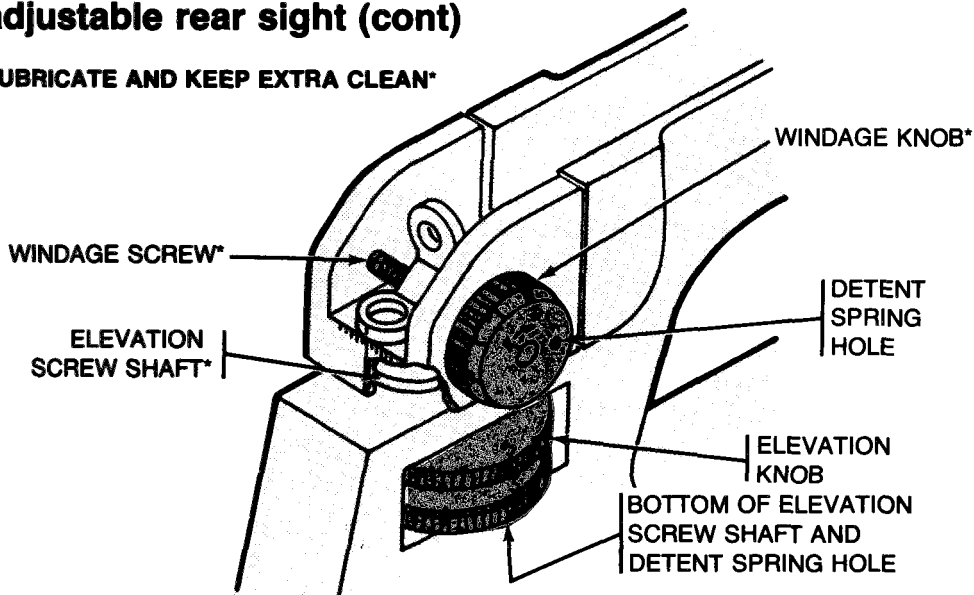

LUBRICATING (Cont)

adjustable rear sight (cont)

AFTER LUBING REAR SIGHT:

- a. Reset your correct zero windage and your battlesight zero. Refer to pages 48-51.
- b. Notice the rear sight comes down when the “3” is aligned with the mark on the left side of the receiver.
- c. You will feel a “click” when the “3” first lines up with the mark.
- d. Carry your rifle with the “3” aligned with the mark.
- e. Keep the sight on 300 meters to keep dirt and water out of sight mechanism and protect the sight from damage.

AFTER AMPHIBIOUS OPERATIONS:

- a. Clean your rear sight as soon as possible if it has salt water on it.
- b. Wash your rear sight with fresh water from your canteen or some other source if you don't have time to clean it with CLP right away.

REASSEMBLY

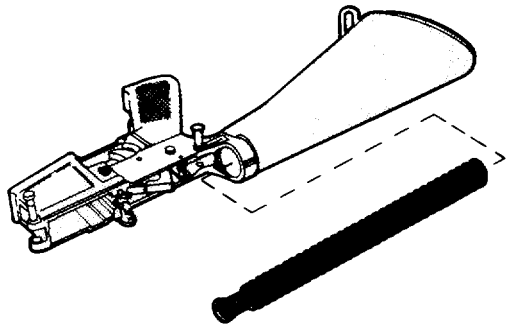

1 Insert action spring and buffer.

NOTE

Extractor assembly has a rubber insert within the spring. Be sure not to lose it. If the spring comes loose, put the large end of spring in the extractor and seat it.

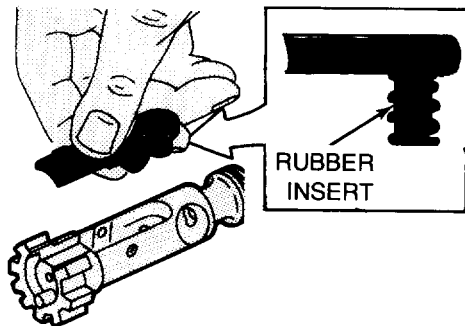

2 Insert extractor and spring.

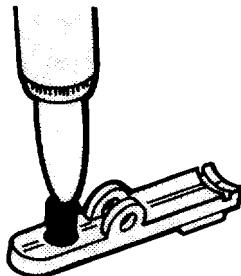

REASSEMBLY (CONT)

WARNING

Don't switch bolts between rifles.

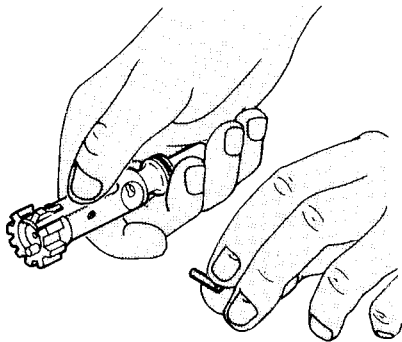

3 Push in extractor pin.

STAGGER RING GAPS
TO STOP GAS LOSS.

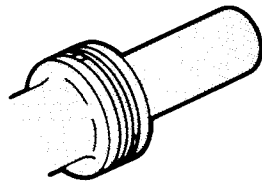

4 Slide bolt into carrier.

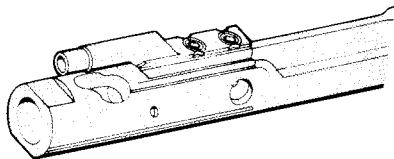
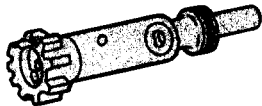

REASSEMBLY (Cont)

WARNING

Be sure the cam pin is installed in the bolt group. If it isn't, your rifle cart still fire and will explode.

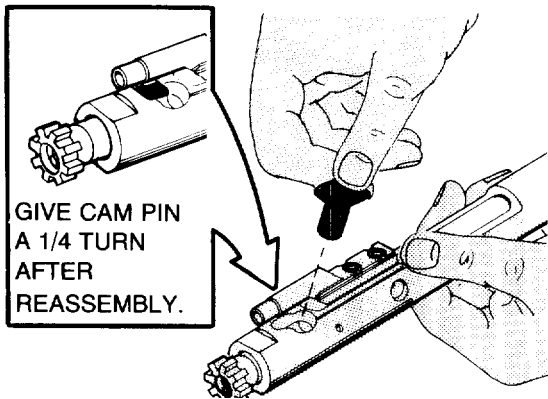

5 Replace bolt cam pin.

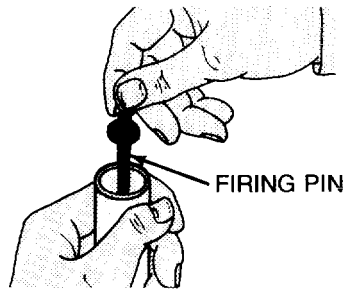

6 Drop in and seat.

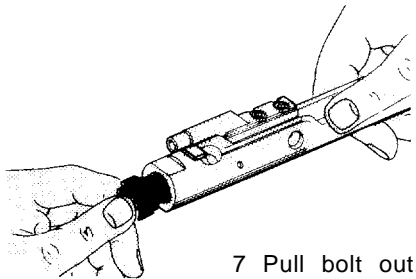

7 Pull bolt out.

REASSEMBLY (Cont)

NOTE

Firing pin should not fall out when bolt carrier group is turned upside down.

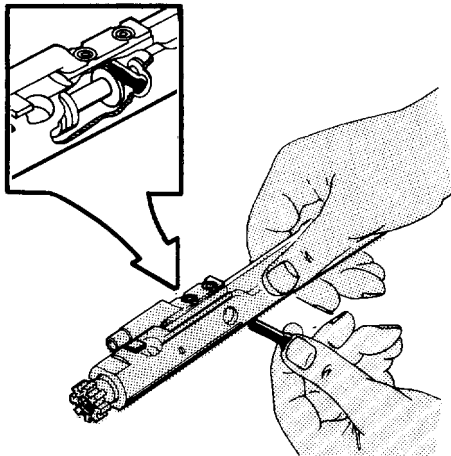

8 Replace firing pin retaining pin.

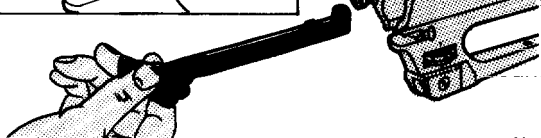
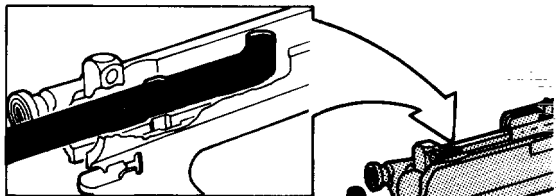

9 Engage, then push charging handle part way.

BE SURE BOLT IS STILL UNLOCKED.

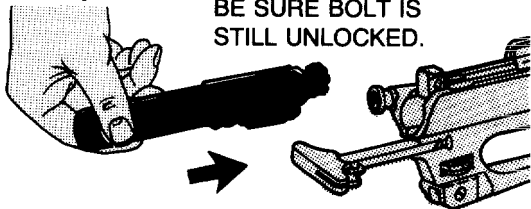

10 Slide in bolt carrier group.

REASSEMBLY (Cont)

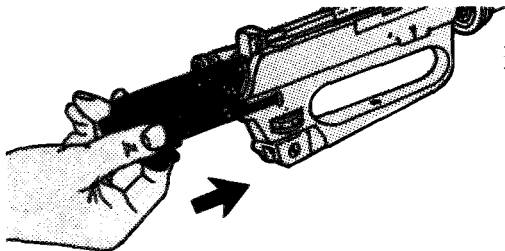

- 11 Push charging handle and bolt carrier group together.

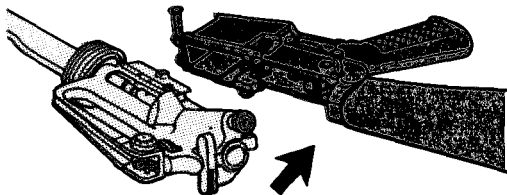

- 12 Join upper and lower receivers.

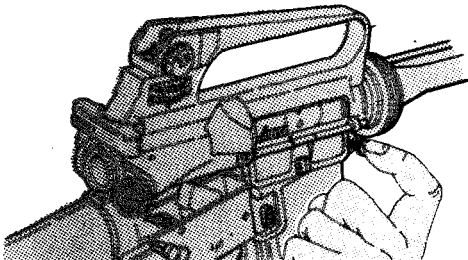

- 13 Engage receiver pivot pin.

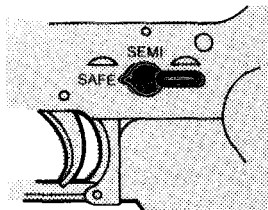

CAUTION

Selector lever must be on SAFE or SEMI before closing upper receiver.

REASSEMBLY (Cont)

- 14 Close upper and lower receiver groups.
Push in takedown pin.

THE "BUDDY SYSTEM"

- 15 Place the rifle on the buttstock and press down on the slip ring with both hands.

NOTE

The round handguards are identical (top or bottom).

- 16 Have your buddy install one handguard on top and the other on the bottom.

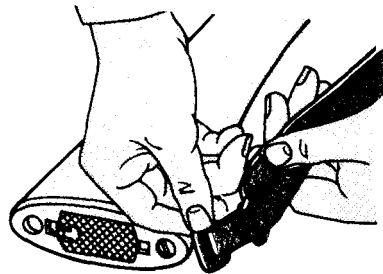
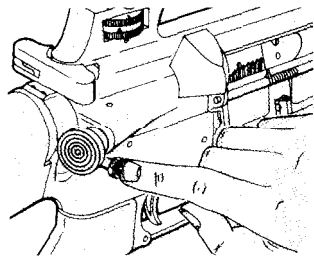
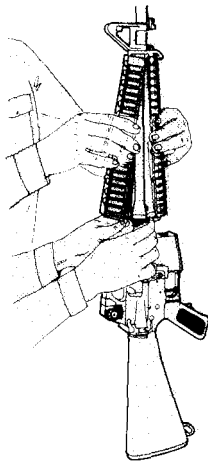

- 17 Snap on sling.

MAGAZINE DISASSEMBLY

30 ROUND MAG

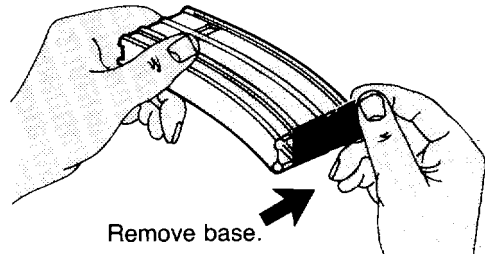
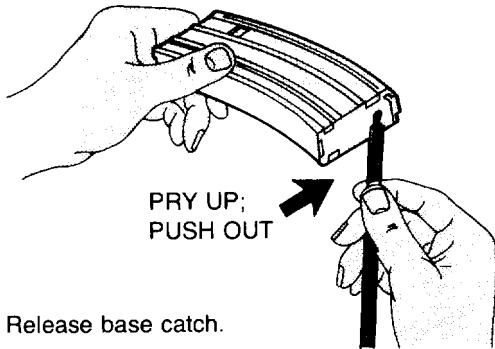

Jiggle spring and follower to remove.

NOTE: Do not remove follower from spring.

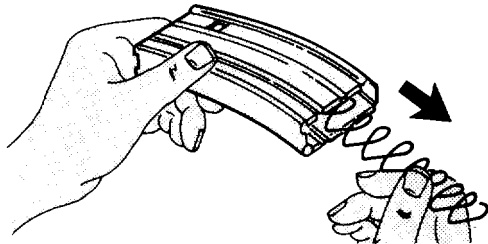

MAGAZINE REASSEMBLY

IF THE SPRING COMES LOOSE FROM THE FOLLOWER, TURN IN THE PIECES. DON'T TRY TO FIX IT YOURSELF.

CLEAN AND LUBE

Wipe dirt from tube, spring, and follower; then lightly lube spring.

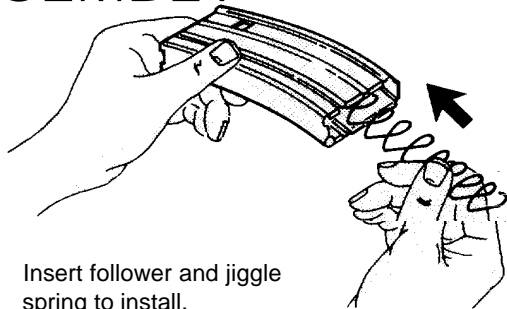

Insert follower and jiggle spring to install.

Slide the base under all four tabs until base catches.

MAKE SURE PRINTING IS ON THE OUTSIDE.

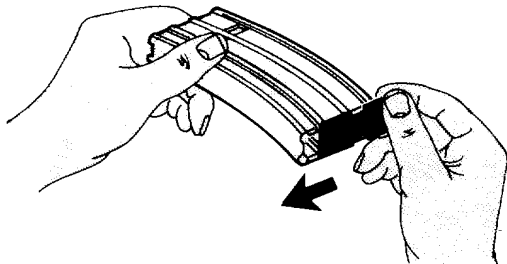

THIS PAGE INTENTIONALLY LEFT BLANK

PMCS* before operation and . . .

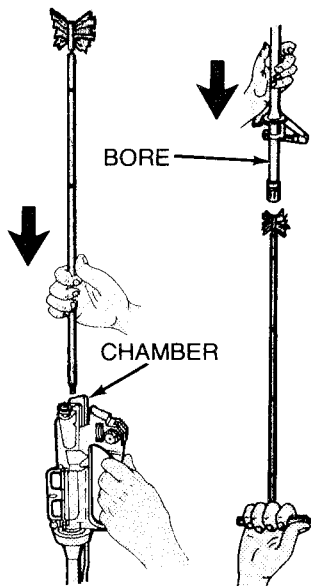

1 Remove excessive oil.

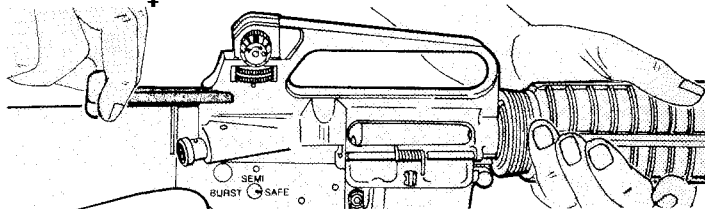

- 2 Retract bolt to ensure free movement between bolt carrier and gas tube.
- 3 Perform functional check to ensure selector lever works properly.
- 4 Mag secure? See page 88.

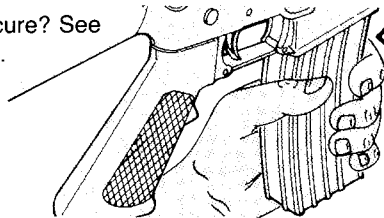

Next page.

Then back to step 4.

* Preventive Maintenance Checks and Services

... FUNCTIONAL CHECK

(REMOVE MAG...CHECK CHAMBER)

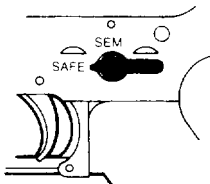

SELECTOR LEVER ON: **SAFE**

Pull charging handle to rear and release. Place on SAFE. Pull trigger. Hammer should not fall.

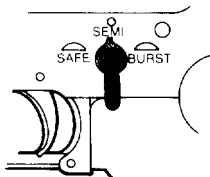

SEMI

Place selector lever in SEMI. Pull trigger and hold to rear. Hammer should fall. Pull charging handle to rear and release. Release trigger and pull again. Hammer should fall.

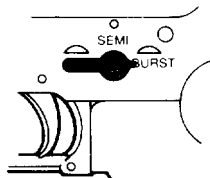

BURST

Place selector lever on BURST. Pull charging handle to rear and release. Pull trigger and hold to rear. Hammer should fall. Pull charging handle to rear three times and release. Release trigger and pull again. Hammer should fall.

ADJUSTABLE FRONT SIGHT POST

The front sight post is moved up or down when zeroing the rear sight. Once the rear sight is zeroed, the front sight post should not be moved.

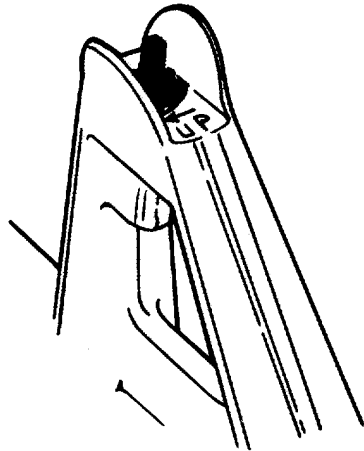

ADJUSTABLE REAR SIGHT HAS TWO APERTURES FOR RANGE

SHORT RANGE (0-200 METERS)

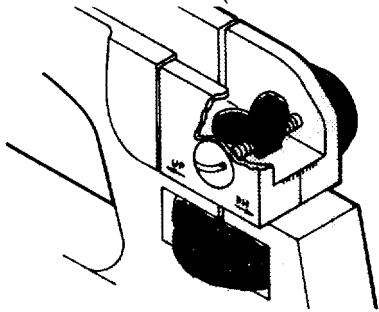

SHORT RANGE - This "larger" aperture is used for 0 - 200 meters range. As shown above, the sight is set for 0 - 200 meters. This larger aperture is only used when the rear sight is all the way down. In other words, the 300-meter mark is aligned with the mark on the left side of the receiver.

NORMAL RANGE
(300-800 METERS)

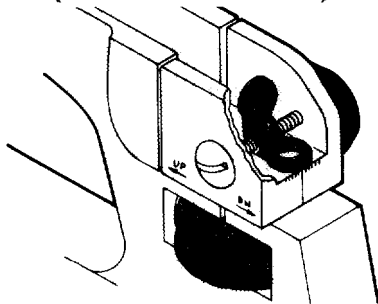

NORMAL RANGE - The aperture is unmarked and used for most firing situations. It is used in conjunction with the elevation knob for 300, 400, 500, 600, 700, and 800 meter targets.

BATTLESIGHT ZERO

When battlesights are on your rifle:

- a. The front sight post and rear sight windage knob are adjusted so you can hit your point of aim at 300 meters.
- b. The unmarked aperture must be in the up position.
- c. The 300-meter mark is aligned with the mark on the left side of the receiver.

BATTLESIGHT ZERO (CONT)

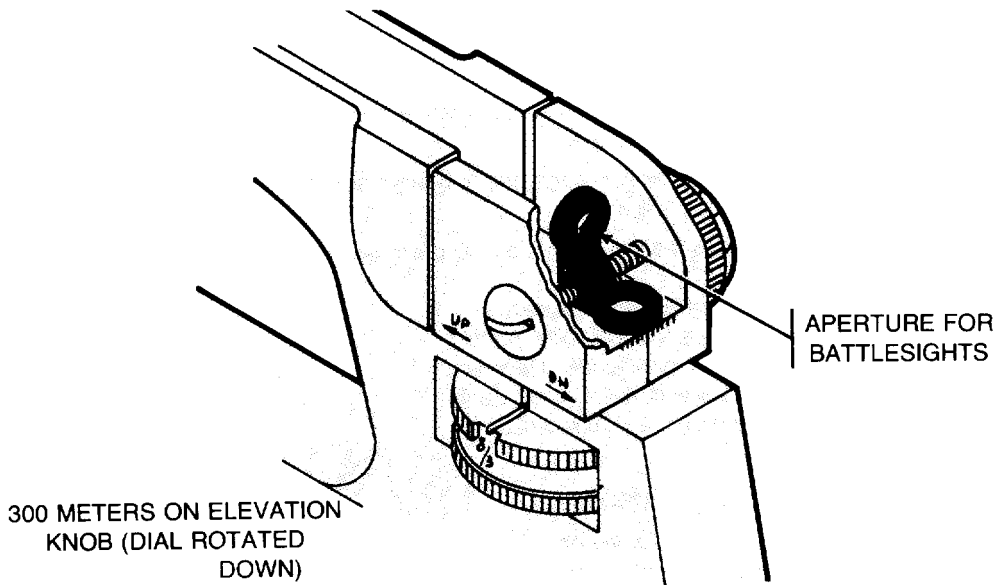

BATTLESIGHT ZEROING ADJUSTMENTS

- During zeroing procedures, only the front sight post and windage knob are adjusted to move the strike of the bullet on the target.
- If you are zeroing on a 25-meter range, the rear sight elevation knob is adjusted to the 300-meter mark plus one "click" up.
- Detailed zeroing procedures are on the following pages 52-55.

FRONT SIGHT. To adjust elevation, depress detent and rotate post. To raise strike of bullet, rotate post in the direction of arrow marked UP. Reverse the direction of rotation to lower strike of bullet. Each graduation (notch) moves the point of impact of bullet as indicated.

IMPACT	DISTANCE
0.9 cm (3/8 in.)	25 meters
3.5 cm (1 3/8 in.)	100 meters
7.0 cm (2 3/4 in.)	200 meters

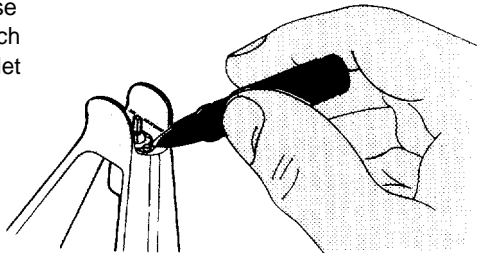

BATTLESIGHT ZEROING ADJUSTMENTS (CONT)

FOR WINDAGE KNOB (per click)*

IMPACT	DISTANCE
0.3 cm (1/8 in.)	25 meters
1.25 cm (1/2 in.)	100 meters
2.50 cm (1 in.)	200 meters
3.8 cm (1 1/2 in.)	300 meters
5.0 cm (2 in.)	400 meters
6.3 cm (2 1/2 in.)	500 meters
7.6 cm (3 in.)	600 meters
8.8 cm (3 1/2 in.)	700 meters
10.0 cm (4 in.)	800 meters

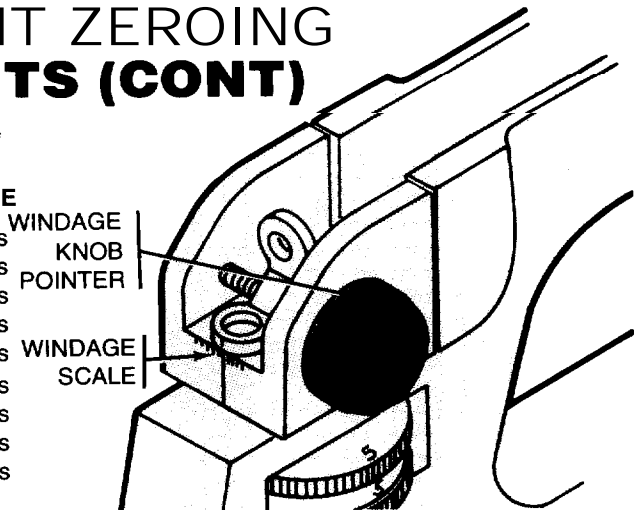

*All the above values have been rounded off.

To remember your correct battlesight zero windage, note location of windage scale and windage knob pointer (heavy mark on outside of knob).

Do not center rear sight aperture for inspections. Keep your correct battlesight zero windage on the rifle at all times.

U.S. MARINE CORPS TARGET

USE THE POINT OF AIM - POINT OF IMPACT TECHNIQUE

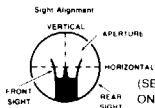
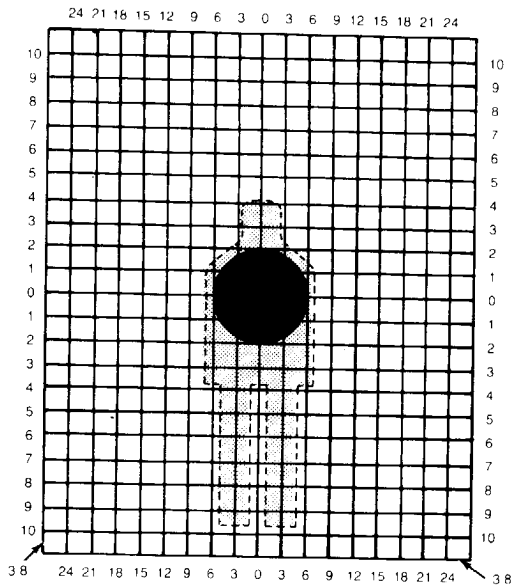

UNITED STATES MARINE CORPS
25 METER ZEROING TARGET

(SEE ZEROING PROCEDURES FOR THE M16A2 RIFLE
ON REVERSE SIDE)

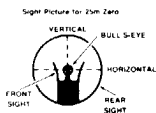

U.S. MARINE CORPS 25-METER ZEROING PROCEDURES

(BY FOLLOWING THE STEPS BELOW AND ESTABLISHING A ZERO AT 25 METERS, YOUR M16A2 RIFLE SIGHTS WILL BE SET WITH A 300-METER BATTLESIGHT.)

- 1 DO NOT MOVE FRONT SIGHT POST AT THIS TIME. IT WAS SET AT THE FACTORY OR BY A PREVIOUS SHOOTER AND SHOULD BE VERY CLOSE TO YOUR ZERO.
- 2 CENTER THE REAR SIGHT APERTURE BY TURNING THE WINDAGE KNOB LEFT OR RIGHT. (THIS IS CALLED **MECHANICAL ZERO WINDAGE.**)
- 3 THE UNMARKED APERTURE SHOULD BE UP.
- 4 ROTATE ELEVATION KNOB IN THE DOWN DIRECTION (COUNTER-CLOCKWISE). THE ELEVATION KNOB SHOULD STOP THREE CLICKS PAST THE 300-METER MARK. THE REAR SIGHT SHOULD BE ALL THE WAY DOWN ON THE LAST WHOLE "CLICK" BEFORE IT BOTTOMS OUT. THIS IS CALLED MECHANICAL ZERO ELEVATION FOR THE REAR SIGHT. IF YOUR RANGE SCALE WILL NOT LINE UP IN THE ABOVE MANNER, AN ARMORER WILL BE REQUIRED TO ADJUST THE RANGE SCALE FOR YOU.

US. MARINE CORPS 25-METER ZEROING PROCEDURES (CONT)

- 5 NOW ROTATE THE ELEVATION KNOB "UP" ONE CLICK PAST THE 300-METER MARK. FROM THIS POINT ON, THE REAR SIGHT ELEVATION KNOB SHOULD NOT BE MOVED. ANY CHANGES IN ELEVATION REQUIRED IN THE FOLLOWING ZEROING STEPS ARE MADE TO THE **FRONT SIGHT POST ONLY**.
- 6 CAREFULLY AIM AND FIRE AT THE CENTER OF THE TARGET BULL'S-EYE. TAKE YOUR TIME AND BE SURE TO USE THE SIGHT PICTURE ILLUSTRATED.
- 7 IF YOUR SHOT GROUP IS NOT IN THE **CENTER** OF THE BULLS-EYE, USE THE SQUARES ON THE TARGET SHEET TO CALCULATE THE REQUIRED "CLICKS" NECESSARY TO MOVE YOUR NEXT SHOT GROUP INTO THE BULLS-EYE. (REMEMBER THAT ANY CHANGES IN ELEVATION ARE MADE BY MOVING THE FRONT SIGHT POST.) THE SQUARES ARE NUMBERED AROUND THE EDGES OF THE TARGET TO EQUAL THE NUMBER OF CLICKS REQUIRED TO MOVE THE SHOT GROUP TO THE BULL'S-EYE.
- 8 IN ORDER TO **RAISE** YOUR NEXT SHOT GROUP, ROTATE THE FRONT SIGHT POST CLOCKWISE. (ONE CLICK WILL MOVE THE STRIKE OF THE BULLET ONE VERTICAL SQUARE ON THE TARGET SHEET.)

IN ORDER TO **LOWER** YOUR NEXT SHOT GROUP, ROTATE THE FRONT SIGHT POST COUNTERCLOCKWISE (ONE CLICK, AS ABOVE, EQUALS ONE SQUARE).

U.S. MARINE CORPS 25-METER ZEROING PROCEDURES (CONT)

CHANGES IN WINDAGE ARE MADE WITH THE WINDAGE KNOB. (THREE CLICKS WILL MOVE THE STRIKE OF THE BULLET ONE HORIZONTAL SQUARE ON THE TARGET SHEET.)

IN ORDER TO MOVE THE SHOT GROUP **TO THE LEFT**, TURN THE WINDAGE KNOB COUNTERCLOCKWISE.

IN ORDER TO MOVE THE SHOT GROUP **TO THE RIGHT**, TURN THE WINDAGE KNOB CLOCKWISE.

- 9 CAREFULLY AIM AND FIRE ANOTHER GROUP AT THE CENTER OF THE TARGET BULLS-EYE.
- 10 REPEAT STEPS 7 THROUGH 9, IF REQUIRED.
- 11 IF YOUR GROUP IS ON TARGET, YOUR SIGHT IS NOW "CALIBRATED." TO PLACE YOUR ACTUAL 300-METER ZERO ON THE RIFLE, YOU MUST ROTATE THE ELEVATION KNOB ONE CLICK "DOWN." (THE RANGE SCALE'S 300-METER MARK SHOULD NOW BE ALIGNED WITH THE MARK ON THE RECEIVER.)

FIELD FIRING TECHNIQUES

- 1 Establish your zero (see page 47). The elevation dial is now set starting at 300 meters and continuing in 100 meter increments up to 800 meters.

SIGHT SET FOR
500 METERS

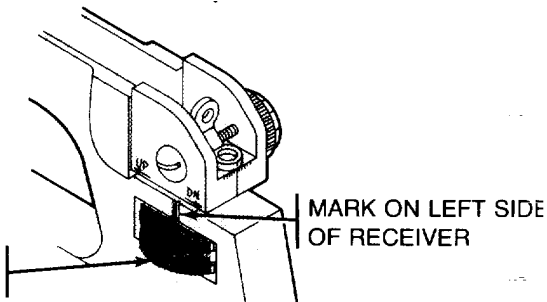

- 2 Rotate the dial until the number (4, 5, 6, 7, or 8) you want is aligned with the mark on the left side of the receiver.

SIGHT SET FOR
800 METERS

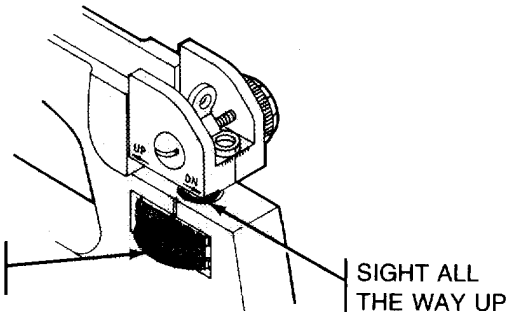

FIELD FIRING TECHNIQUES (CONT)

- 3 Obtain a good sight picture and good sight alignment with the unmarked aperture and the front sight post.
- 4 Squeeze the trigger and fire.

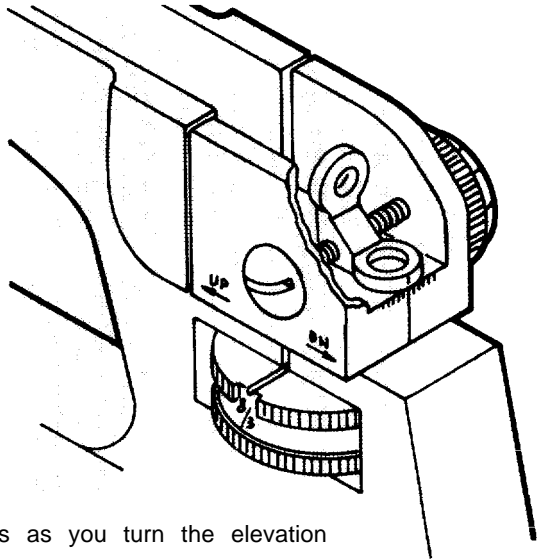

NOTE

There are clicks between the numbers as you turn the elevation knob. Use the clicks if you need more elevation past a certain number to hit your target.

FIELD FIRING TECHNIQUES (CONT)

NOTE

The normal rear sight aperture (unmarked) flips forward to expose a larger aperture marked "0-2." Use the 0-2 aperture only when the 3 is aligned with the mark on the left side of the receiver and the sight is rotated down. You will automatically get a zero of 200 meters. Use the 0-2 aperture when shooting at night or at close range, e.g., in a city or in dense jungle.

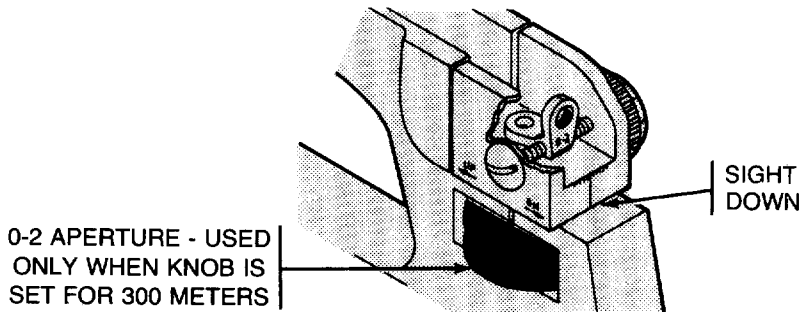

ADDITIONAL INFORMATION CONCERNING YOUR M16A2 SIGHTS

GENERAL. Your rifle sights should be set to a combat zero of 300 meters. If you are told to engage a target at longer range, e.g., 500 or 800 meters:

- a. Rotate the elevation knob so that the desired range mark is aligned with the mark on the left side of the receiver.
- b. Aim, squeeze the trigger, and fire.

NOTE

Return the dial to 300 meters when the mission is over.

- c. See conversion chart in back of manual. (pages 118-119).

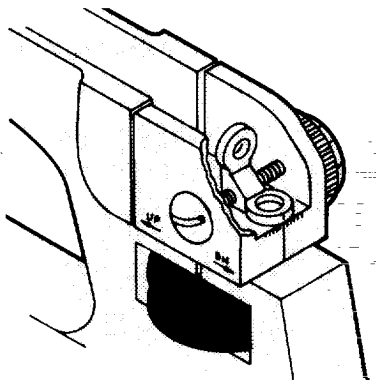

ADDITIONAL INFORMATION CONCERNING YOUR M16A2 SIGHTS (CONT)

SHOOTING AT NIGHT OR AT CLOSE RANGE

- a. Rotate the elevation knob down to the 300-meter mark.
- b. Flip the unmarked aperture down and use the larger aperture marked "0-2."

NOTE

The 0-2 aperture is preset for targets between 0 and 200 meters. Moving targets at close ranges are easier to hit if you use the larger aperture.

USE OF SELECTOR LEVER

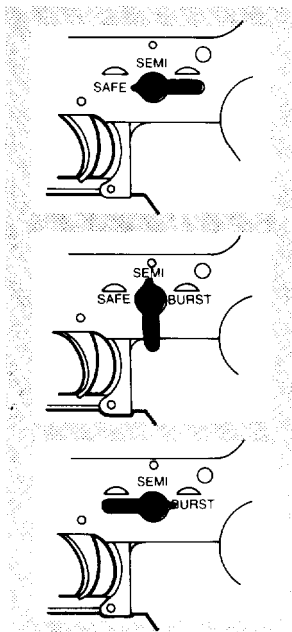

SAFE

Rifle will not fire. Selector lever cannot be on SAFE unless rifle is cocked. Always place on SAFE when loading and unloading.

SEMIAUTOMATIC

Rifle will fire one round each time the trigger is pulled.

BURST

Rifle will fire a three-round burst each time the trigger is pulled.*

● For information on operation of three-round burst, see page 63.

OPERATION

WARNING

If a noticeable difference in sound or recoil is experienced, STOP FIRING. Either condition could indicate an incomplete powder burn and/or a bullet stuck in the bore. Retract bolt slowly and remove fired cartridge case. Clear weapon and check for unburned powder grains in the receiver or bore and for a bullet stuck in the bore. Remove unburned powder or bullet from bore before resuming firing. If bullet is stuck in bore, return the rifle to the armorer.

OPERATION - three-round burst control

GENERAL.

- Provides you three rounds per trigger pull.
- Helps you save ammunition.
- Gets back on target quicker than if rifle were fired like a machine gun.

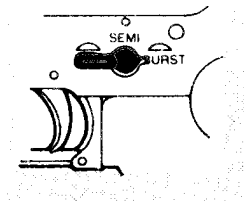

FIRING.

- First (or maybe last) trigger pull may not fire more than one or two rounds.

NOTE

This is **not** a malfunction.

- Quickly pull trigger again all the way to the rear and hold to get a full three-round burst. This is called “double squeezing” the trigger. This technique is often necessary if firing is continued after changing magazines or switching from semi to burst.

NOTE

If you release the trigger before all three rounds are fired, your next pull on the trigger will fire only the remaining rounds from the previous burst. Once you squeeze off a burst, keep the squeeze on until the three-round cycle is complete.

OPERATION - loading for semiauto fire and . .

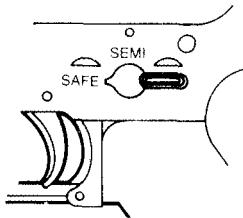
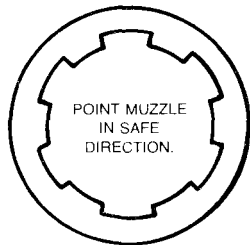

- 1 With hammer cocked, place selector lever on SAFE.

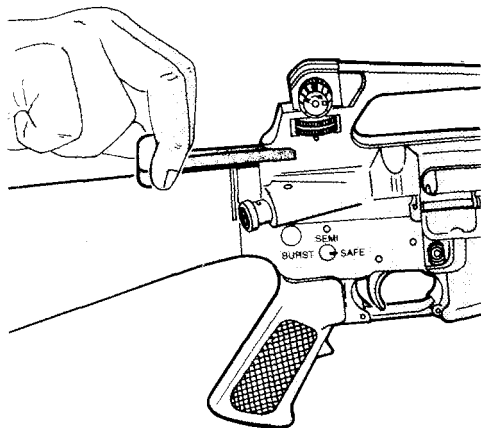

- 2 Open bolt and check chamber. Make sure it is clear.

■ ■ ■ **chambering a round**

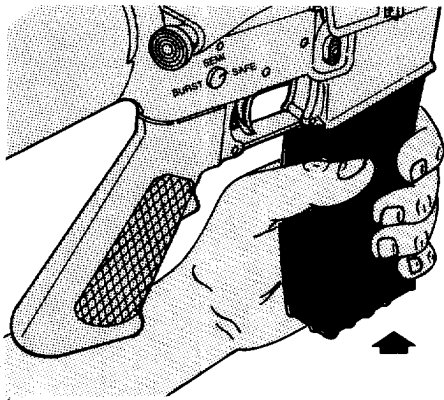

3 Push upward until magazine catch engages and holds magazine.

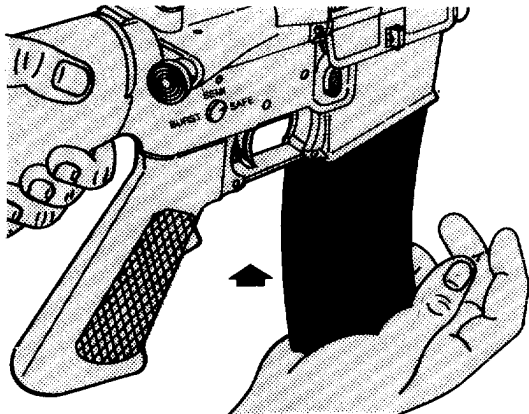

4 Tap upward to make sure it's seated right.

OPERATION - loading for semiauto fire and . . .

NOTE

Magazine may be loaded with bolt assembly open or closed.

BOLT ASSEMBLY OPEN

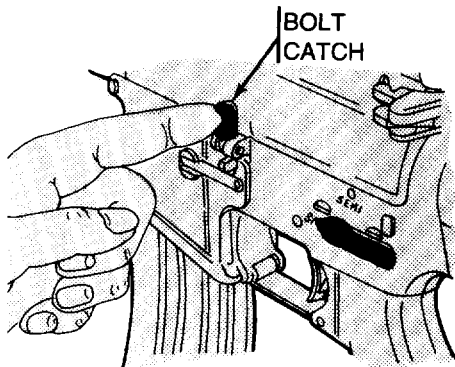

Depress upper portion of bolt catch. Bolt should go forward.

FORWARD ASSIST

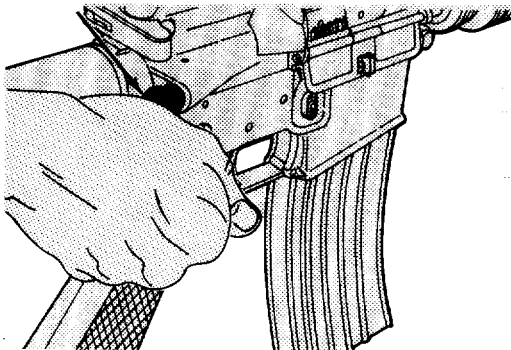

TAP forward assist to ensure bolt is fully forward and locked.

. . . chambering a round (cont)

BOLT ASSEMBLY CLOSED

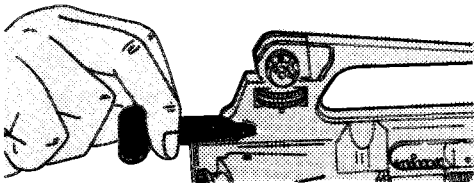

Pull charging handle fully rearward.

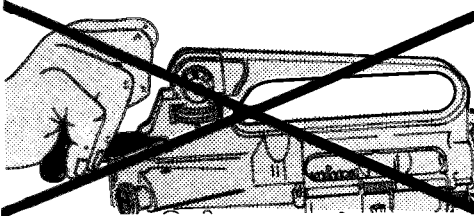

Never "ride" the charging handle. Let it go forward on its own.

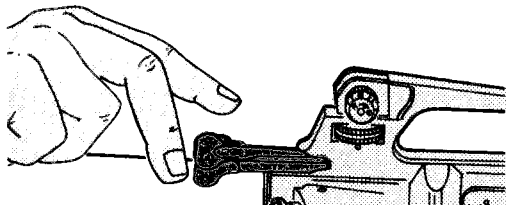

Release the charging handle.

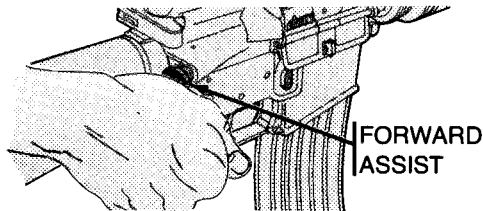

TAP forward assist to ensure bolt is fully forward and locked.

NOTE

If rifle is not to be fired immediately, close ejection port cover.

OPERATION - loading for a three-round burst and

THREE-ROUND BURST CONTROL. To guarantee a three-round burst the first time you pull the trigger, follow these steps:

WARNING

START WITH A CLEAR WEAPON.

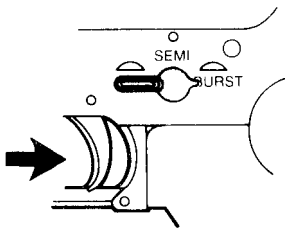

- 1 Place selector on BURST
- 2 Pull trigger and hold it to the rear.

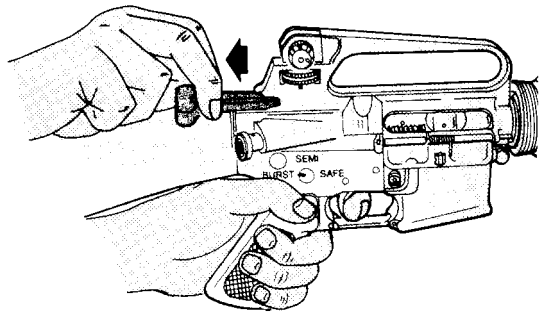

- 3 Pull charging handle to rear and let it go three times.

. . . cambering a round (cont)

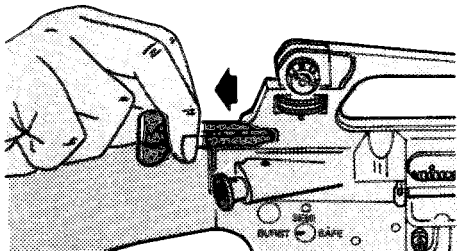

- 4 Pull charging handle to rear one more time; hold it to the rear.

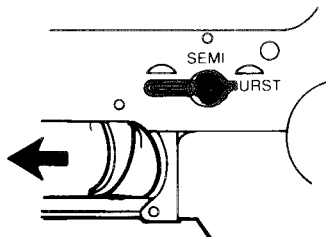

- 5 Let go of the trigger.

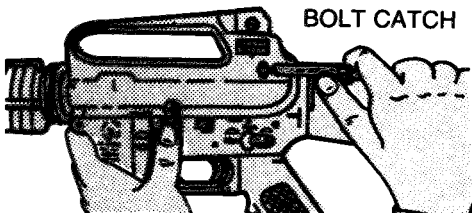

- 6 Push in on the bottom portion of bolt catch thereby locking the bolt to the rear.

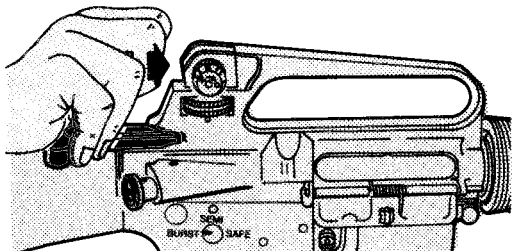

- 7 Slide the charging handle all the way forward.

OPERATION - loading for a three-round burst and

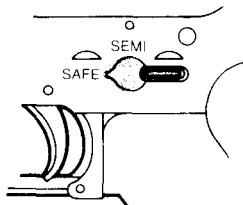

8 Place selector on SAFE.

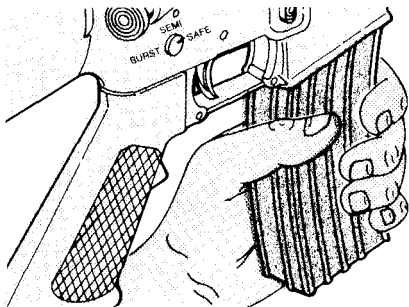

9 Insert a loaded magazine. Push on the upper portion of the bolt catch to allow the bolt to fly forward. (See page 66.)

WARNING

Your rifle is now loaded. Ensure it is pointed in a safe direction.

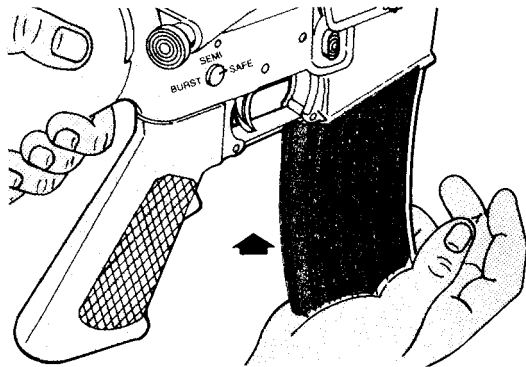

• • chambering a round (cont)

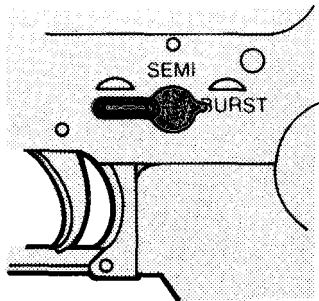
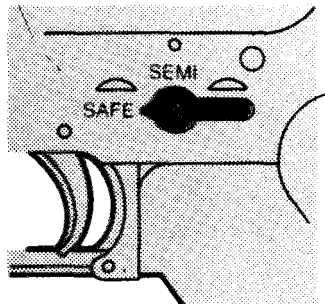

10 Placing the selector on BURST and pulling the trigger will give you a three-round burst.

NOTE

If rifle is not to be fired immediately, close ejection port cover.

IMMEDIATE ACTION

If your rifle stops firing, perform the following immediate actions:

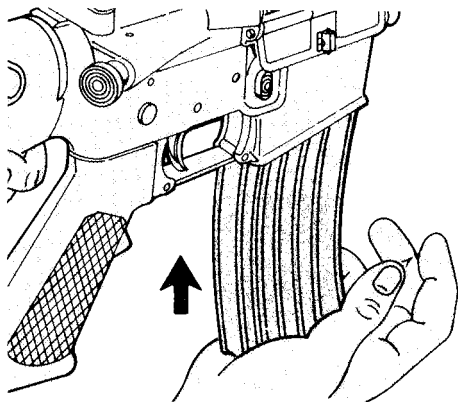

1 SLAP upward on magazine to make sure it's properly seated.

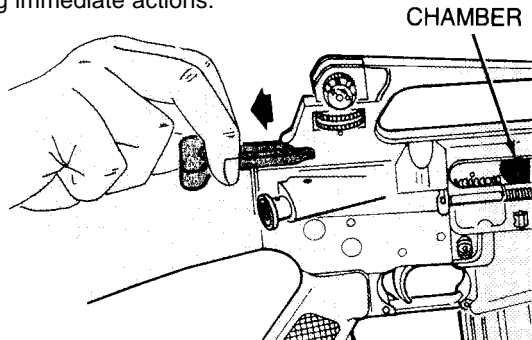

WARNING

Do not load with a hot chamber.

2 PULL charging handle all the way back. OBSERVE ejection of case or cartridge. Check chamber for obstruction.

IMMEDIATE ACTION (CONT)

- 3 If cartridge or case is ejected or chamber is clear, **RELEASE** charging handle to feed new round. Don't ride the charging handle forward.

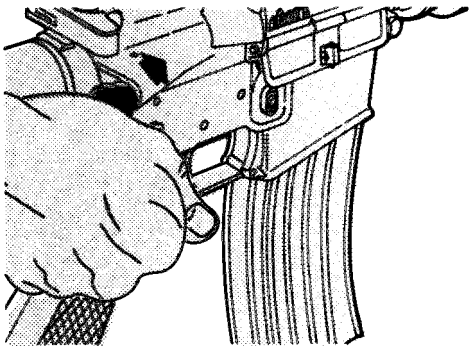

- 4 TAP forward assist.

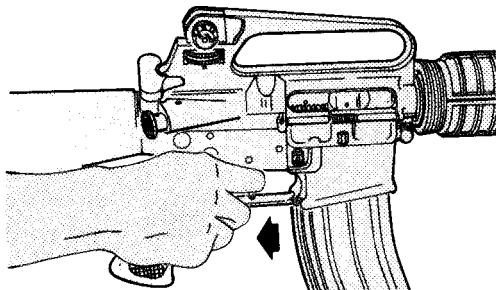
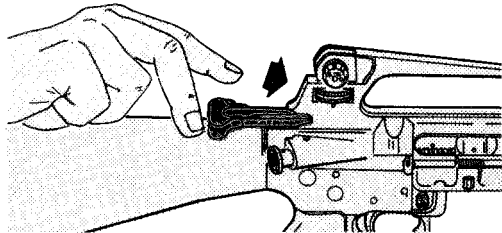

- 5 Now **FIRE**. If it won't fire, look for trouble and apply remedial action (next page).

REMEDIAL ACTION

WARNING

If your rifle stops firing with a live round in the chamber of a hot barrel, remove the round fast. However, if you cannot remove it within 10 seconds, remove magazine and wait 15 minutes with the rifle pointing in a safe direction. This way you won't get hurt by a possible round cooking off. Regardless, keep your face away from the ejection port while clearing a hot chamber.

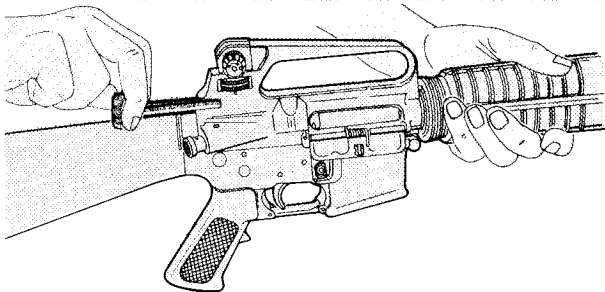

If your rifle still fails to fire after performing steps 1 through 5, check again for jammed cartridge case.

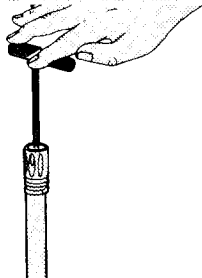

If a cartridge case is in the chamber, tap it out with a cleaning rod.

IF YOUR RIFLE STILL FAILS TO FIRE, CHECK TROUBLESHOOTING PAGE 86.

BULLET STUCK IN BORE

WARNING

If an audible "POP" or reduced RECOIL is experienced during firing, immediately **CEASE FIRE**: (1) remove the magazine, (2) lock the bolt to the rear, (3) place the selector lever on the "SAFE" position and (4) visually inspect and/or insert a cleaning rod into the bore to ensure there is not a bullet stuck in the bore.

DO NOT APPLY IMMEDIATE ACTION.

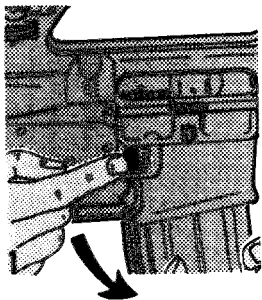

1

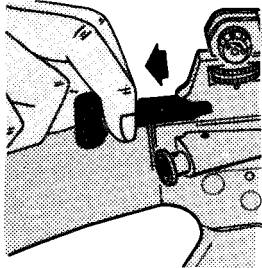

2

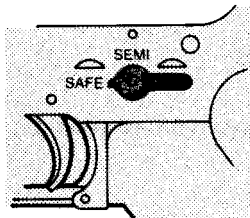

3



If a bullet is stuck in the barrel of the weapon, **DO NOT** attempt to remove it. Turn the weapon in to the armorer.

LIMITED PM CLEANING AS NEEDED

CLEAR YOUR RIFLE

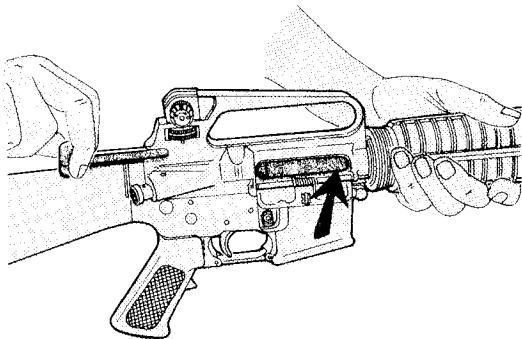

1 Look for fouling in bore and chamber.

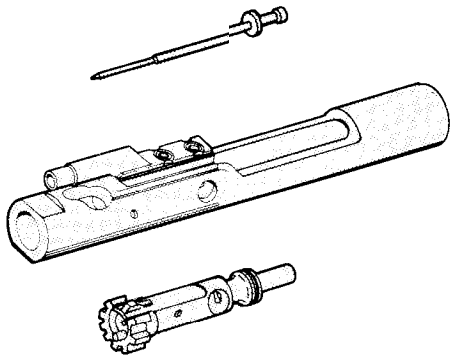

2 Remove bolt carrier group (see page 12) and clean carbon and oil from firing pin and all surfaces of bolt/bolt carrier with dry swabs. Clean firing pin hole and bolt carrier key with pipe cleaner. Apply light coating of CLP, paying special attention to slide and cam pin area.

LIMITED PM CLEANING AS NEEDED (CONT)

3 "Swab out" rifle from chamber to muzzle.

CAUTION: Don't bend or flex cleaning rod,
Make sure swab goes clear through compensator.
Do not reverse direction while swab is in bore or
compensator.

4 After cleaning and
before reassembly,
lightly lubricate lugs
in barrel extension
with CLP.

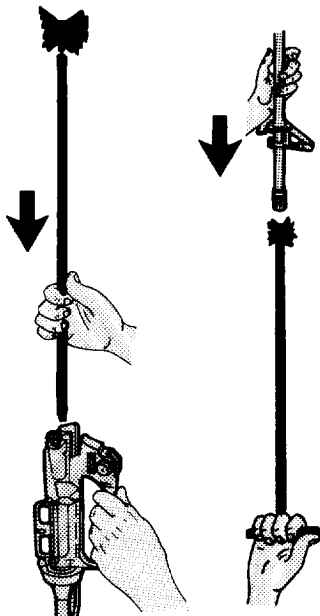
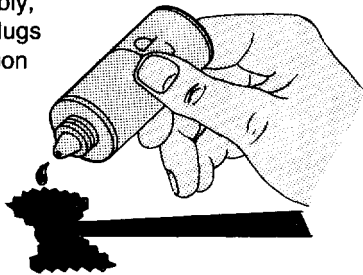

OPERATION UNDER UNUSUAL CONDITIONS

CAUTION

Be careful not to accidentally fire your rifle when inserting gloved fingers into trigger guard area.

EXTREME COLD CLIMATE - ARCTIC: Use LAW for lubrication and CLP for cleaning.*

1 To operate the rifle in extreme cold, depress the trigger guard plunger and open the trigger guard to obtain easy access to the trigger when wearing arctic mittens.

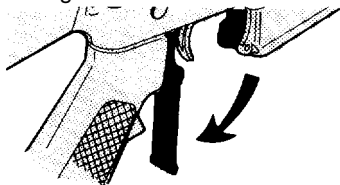
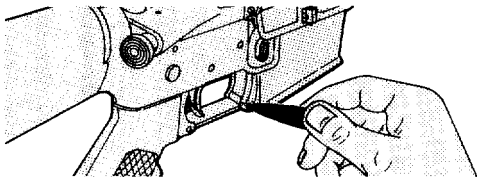

2 Cleaning and lubrication should be accomplished inside a warm room and the rifle should be at room temperature if possible.

a. Apply a light coat of LAW to all functional parts.

*CLP must be kept warm in extreme cold. Carry it in your shirt pocket to keep it fluid.

OPERATION UNDER UNUSUAL CONDITIONS (CONT)

- b. To Prevent the condensation of moisture and freezing, keep the weapon covered when moving from a warm to a cold area to allow gradual cooling.
- c. Always attempt to keep the weapon dry.
- d. Unload and hand function the weapon every 30 minutes to help prevent freezing of functional parts.
- e. Do not lay a warm weapon directly in snow or ice.
- f. When moving a cold rifle into a warm place, condensation (moisture) will form in and on your weapon. If possible, leave your weapon in a protected but cold area outside. When the weapon is brought inside a warm place, it should be disassembled and wiped dry several times as it reaches room temperature.
- g. Keep the insides of magazines and your ammo wiped dry. Moisture will freeze and cause malfunctions. Do not lube the ammo.
- h. The use of the muzzle cap, protective magazine bag, and an overall rifle cover will help protect your rifle. Use them whenever the tactical situation permits.
- i. For extended operations in extreme cold, have armorer remove trigger guard.

OPERATION UNDER UNUSUAL CONDITIONS (CONT)

HOT, WET CLIMATE - JUNGLE: Use CLP to clean and lube.

- 1 Perform normal maintenance as outlined in the PMCS table on page 44.
- 2 Clean and lube rifle more frequently. Inspect hidden surfaces of the bolt and carrier assembly, upper receiver and chamber/barrel extension (locking lugs), and the lower receiver and receiver extension assembly (buffer tube) for corrosion. Also pay close attention to the spring-loaded detents on the rifle.
- 3 To help prevent corrosion, remove handprints with a dry wiping rag. Then lubricate lightly with CLP.
- 4 Unload and check the inside of magazines frequently for corrosion and moisture. Wipe ammo dry before reloading.
- 5 Use magazine bag, muzzle cap, etc. for protection when the tactical situation permits.

OPERATION UNDER UNUSUAL CONDITIONS (CONT)

HOT, DRY CLIMATE - DESERT: Use CLP to clean and lube.

Hot, dry climates are usually areas containing blowing sand and fine dust. Deserts can be hot during daylight hours and freezing during hours of darkness. Consequently, this harsh environment will severely tax your rifle as well as all other types of equipment. Your rifle's continued operation will depend on your detailed cleaning and lubricating procedures.

- 1 Dust and sand will get into the rifle and magazines. This will cause malfunctions. Give the inside areas and functional parts of the rifle a thorough cleaning everyday and after every firing mission.
- 2 Corrosion is less likely to form on metal parts in a dry climate; therefore, lubrication should be applied to the internal working surfaces and functional parts only. Use normal amounts of CLP for lubrication (always shake CLP prior to use). Unload and dry ammo and inside of magazines daily. Do not lube magazines.

OPERATION UNDER UNUSUAL CONDITIONS (CONT)

HOT, DRY CLIMATE - DESERT (CONT):

- 3 The use of overall rifle protection cover, muzzle cap, and spare magazine protective bags will help protect the rifle/ammo from sand and dust. Use these items when the tactical situation permits.
- 4 At all times, however, as a minimum effort to help keep out sand and dust, keep the bolt and ejection port cover closed, a magazine installed in the rifle, and a muzzle cap on the muzzle.

NOTE: Removal of the muzzle cap prior to firing is recommended. Place it in your pocket for future use. However, it is not dangerous to fire the rifle with the muzzle cap installed.

OPERATION UNDER UNUSUAL CONDITIONS (CONT)

HEAVY RAIN AND FORDING OPERATIONS - ALL CLIMATES

- 1 Perform maintenance in accordance with the appropriate climate conditions.
- 2 Always attempt to keep rifle dry.
- 3 Use rifle cover, muzzle cap, and protective bags to protect rifle, ammo, and magazines.
- 4 Always drain any water from barrel prior to firing. Dry the bore with a swab and cleaning rod if it is wet.

NUCLEAR, BIOLOGICAL AND CHEMICAL (NBC). General procedures can be found in FM 3437, FM 21-40 and TM 3-220.

OPERATION UNDER UNUSUAL CONDITIONS (CONT)

AFTER FORDING

WARNING

DO NOT FIRE RIFLE IF WATER IS PRESENT IN BARREL.

AFTER YOU REMOVE THE CAP:

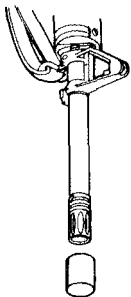

1 REMOVE MUZZLE CAP.

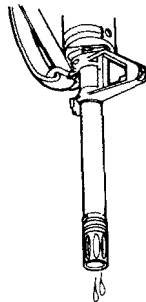

2 POINT THE MUZZLE DOWN AND SHAKE
VIGOROUSLY.

OPERATION UNDER UNUSUAL CONDITIONS (CONT)

AFTER FORDING (CONT)

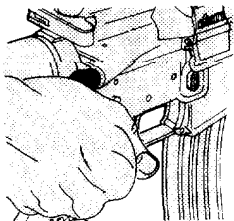

- 4 RELEASE CHARGING HANDLE AND STRIKE FORWARD ASSIST TO SEAT ROUND AND LOCK BOLT.

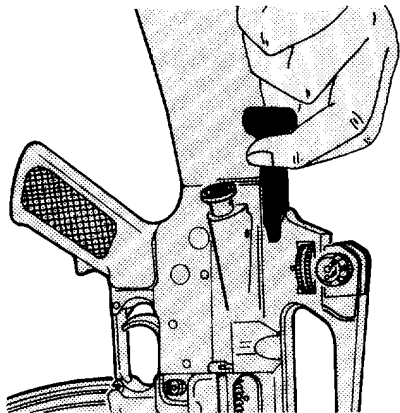

- 3 PULL CHARGING HANDLE 2 TO 3 INCHES REARWARD AND ALLOW WATER TO DRAIN.

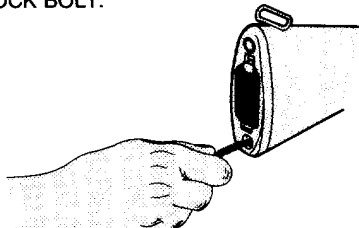

- 5 CLEAR THE DRAIN HOLE IN THE STOCK WITH A PIPE CLEANER AND DRAIN.

NOTE: For additional information. see FM 23-9

TROUBLESHOOTING

PROBLEM

CHECK FOR

WHAT TO DO

WON'T FIRE

Selector lever on SAFE.
Improper assembly of firing pin.

Put it on SEMI or BURST.
Assemble correctly.
RETAINING PIN GOES IN BACK OF LARGE SHOULDER OF FIRING PIN.

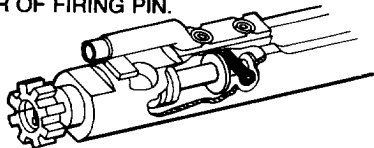

Too much oil in firing pin recess.

Wipe out with pipe cleaner.

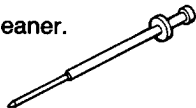

Defective ammo.
Too much carbon on firing pin or in firing pin recess.

Remove and discard.
Clean.

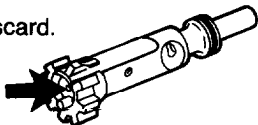

TROUBLESHOOTIN (CONT)

PROBLEM	CHECK FOR	WHAT TO DO
BOLT WON'T UNLOCK	Dirty or burred bolt.	See your NCO or your unit ARMORER.
WONT EXTRACT	Broken extractor spring. Dirty or corroded ammo.	See your ARMORER. Remove. Push out stuck round with cleaning rod.

Carbon in chamber.
Fouling or carbon in
extractor recess or lip.

Clean chamber.
Clean.

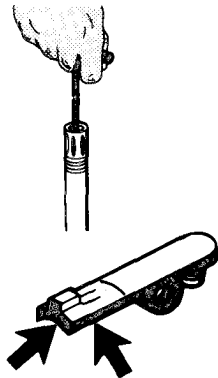

TROUBLESHOOTING (CONT)

PROBLEM	CHECK FOR	WHAT TO DO
WON'T FEED	Dirty or corroded ammo.	Clean.
	Dirty magazine.	Clean.
	Defective magazine.	Replace.
	Too many rounds in magazine.	Take out excess.
	Action of buffer assembly is restricted,	Take out buffer and spring and clean.
Magazine not fully seated.	Adjust magazine catch.	

PRESS BUTTON
ON RIGHT SIDE

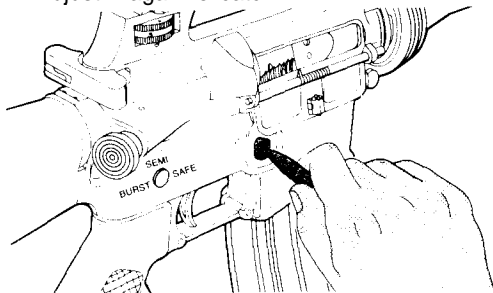

TROUBLESHOOTING (CONT)

PROBLEM

CHECK FOR

WHAT TO DO

WON'T FEED
(CONT)

Turn catch clockwise to tighten and counterclockwise to loosen.

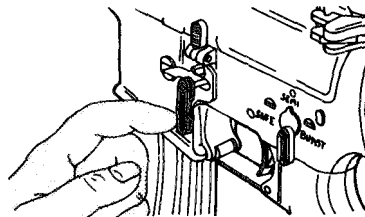

TURN CATCH ON
LEFT SIDE

DOUBLE FEED

Defective magazine.

Replace.

TROUBLESHOOTING (CONT)

PROBLEM

CHECK FOR

WHAT TO DO

WON'T CHAMBER

Dirty or corroded ammo.

Clean.

Damaged ammo.

Replace.

Carbon in chamber or on
gas tube.

Clean.

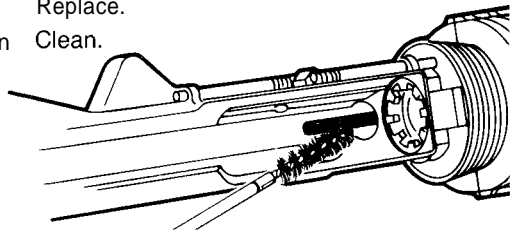

Dirt, corrosion, or carbon
buildup in barrel locking
lugs.

Clean lugs

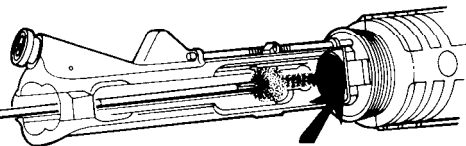

CLEAN

TROUBLESHOOTING (CONT)

PROBLEM	CHECK FOR	WHAT TO DO
WON'T EXTRACT	Frozen extractor.	Remove and clean.
	Restricted buffer assembly.	Remove and clean.
	Restricted movement of bolt carrier group.	Remove, clean, and lube. (Before putting bolt back in, make sure gas tube fits into carrier key and that the carrier moves freely.)

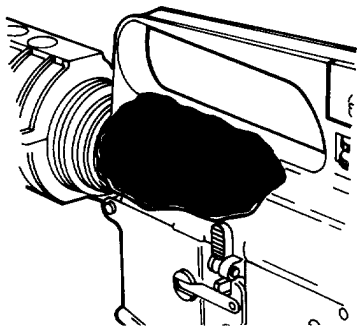

TROUBLESHOOTING (CONT)

PROBLEM	CHECK FOR	WHAT TO DO
SHORT RECOIL	Gaps in bolt rings (not staggered).	Stagger ring gaps.

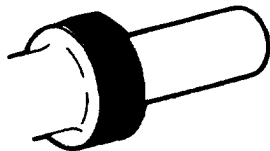

Carbon or dirt in carrier key or on outside of gas tube. Clean.

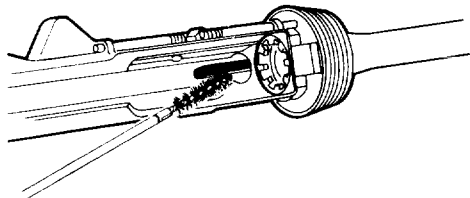

TROUBLESHOOTING (CONT)

PROBLEM

CHECK FOR
Q-Tip/pipe cleaner
stuck inside carrier
key.

WHAT TO DO

Return rifle to armorer.

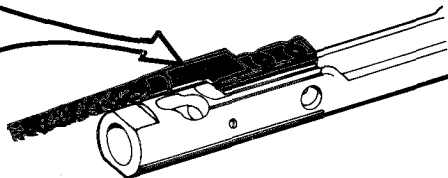
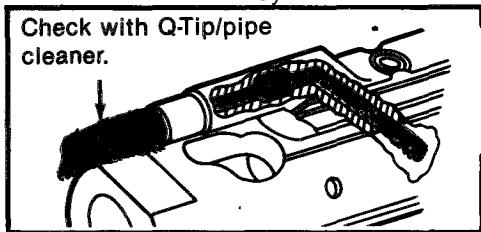

BOLT FAILS TO
LOCK AFTER LAST
ROUND

Dirty or corroded bolt
latch.

Clean.

SELECTOR LEVER
BINDS

Faulty magazine.
Needs oil.

Replace.

Lubricate with CLP.

Dirt or sand under trigger. Clean.

TROUBLESHOOTING (CONT)

PROBLEM

CHECK FOR

WHAT TO DO

BOLT CARRIER
"HANG UP"

Round jammed between bolt and charging handle
1 Remove magazine.
2 push in on the bottom of the bolt latch,
and/or double feed.

WARNING

KEEP CLEAR OF MUZZLE.

3 Bang rifle butt on the ground. Bolt should
lock to rear.

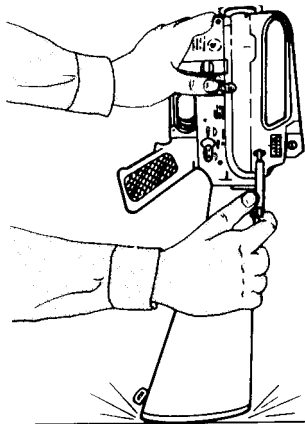

TROUBLESHOOTING (CONT)

PROBLEM

CHECK FOR

WHAT TO DO

CAUTION

After round is removed, bolt is under tension.

- 4 While bolt is held to rear, round should fall through magazine well.

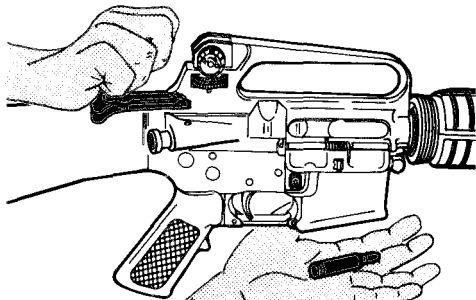

NOTE

If this procedure fails, use a section of cleaning rod to push bolt fully to rear through ejection port.

COMPENSATOR

CAUTION

DO NOT remove the compensator for any reason. Armorers are not authorized to remove it for cleaning purposes. The compensator is torqued to about 20 pounds with a special wrench at the factory.

The compensator was set at the factory. It keeps the muzzle down during automatic fire. The setting is precise so that the slots are indexed, as shown below.

The compensator has five slots. The third or middle slot must be straight up.

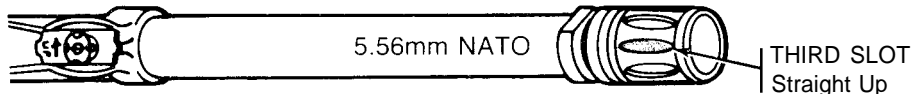

It should line up with the front sight post.

BUTTSTOCK AND PISTOL GRIP

CAUTION

DO NOT remove the stock or the pistol grip for any reason. You are not authorized to remove these parts because you may lose the small detents or damage the springs upon reassembly. If, for example, your rifle is submerged during a river crossing, ask your armorer to remove the stock or pistol grip for cleaning and lubricating.

NOTE

Buttstock mat be used for storage.

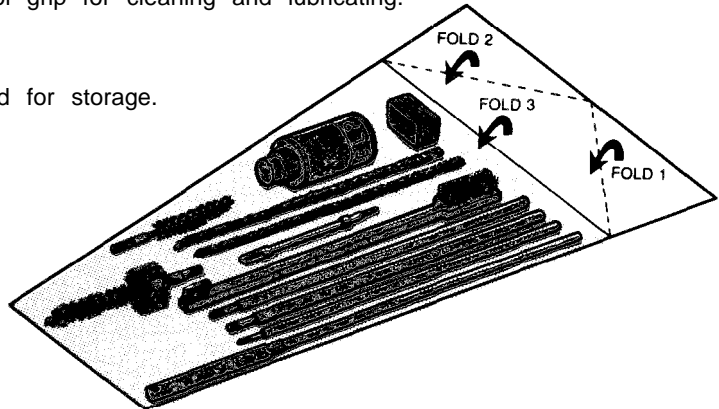

LOADING MAGAZINE

The magazine may be loaded quickly using ten-round stripper clips and the magazine filler found in each bandoleer.

TEN-ROUND
STRIPPER CLIP

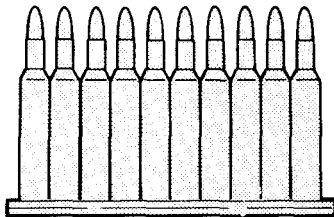

- 1 With the magazine filler in place, place a ten-round stripper clip in position. Using thumb pressure on the rear of the top cartridge, press down firmly until all ten rounds are below the feed lips of the magazine.

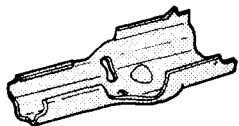

MAGAZINE FILLER
(FOUND IN END
POCKET OF BANDOLEER)

LOADING MAGAZINE (CONT)

- 2 Remove the empty stripper clip while holding the magazine filler in place.
- 3 Repeat until three ten-round clips are loaded.
- 4 Remove magazine filler and retain it for future use.

LOADING PROCEDURE

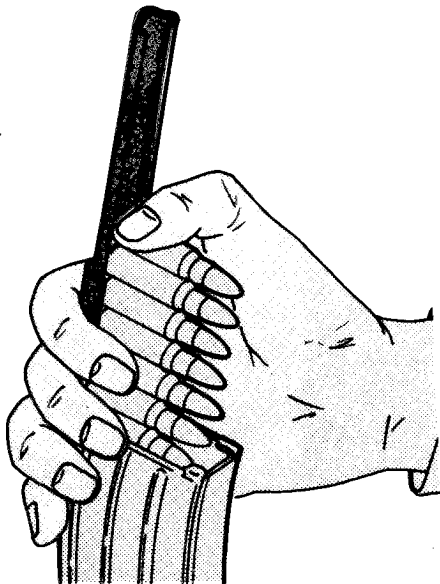

USING TRACER AMMUNITION

Use tracer ammunition to help hit the target during hours of darkness or low light levels. Tracer ammunition is not as effective as regular ball ammunition against most targets.

When tracer ammunition is available, mix it in with the ball ammunition in your magazine. One way to mix ammunition is shown below.

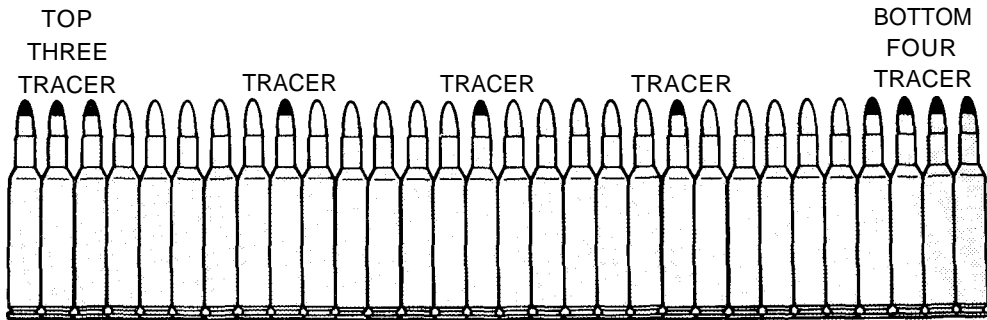

USING TRACER AMMUNITION (CONT)

NOTE

Tracer ammunition is tipped

- The top three help you get on target.
- The traces in between help you stay on target.
- The bottom four let you know when to change magazines.

CHANGING MAGAZINES

- 1 In combat, insert a fully loaded magazine before the one you are using is completely empty.
- 2 If you know there are only a few rounds remaining in your rifle, change magazines if the tactical situation permits.

AMMUNITION

5.56mm

WARNING

DO NOT FIRE...

- Seriously corroded ammunition.
- Dented cartridges.
- Cartridges with loose bullets.
- Cartridges exposed to extreme heat (135 F°) until they have cooled.
- Cartridges with the bullet pushed in (short rounds).

...TURN IN TO RANGE NCO.

Use only authorized ammunition that is manufactured to U.S. or NATO specifications.



BALL,
M193

GREEN
TIP



BALL,
M855



DUMMY,
M199

RED
TIP



TRACER
M196
& M856

VIOLET
TIP



BLANK,
M200

**KEEP DRY, CLEAN, AND FREE OF
CRUD; YOUR LIFE DEPENDS ON IT!**

REFERENCE PUBLICATIONS

FMFM 1-3A	Field Firing Techniques
FMFM 6-5	Marine Rifle Squad
SI-1300-15/1	Ammo Data Cards, Marine Corps Ammo
SI-1300-15/2B	Procedure for Requesting Disposition for Class V(W) Materiel
TM 4700-15/1	Record Reporting Procedures
TM 05538C/23/2	Organizational and Intermediate Maintenance, M16A2 Rifle
FM 23-9	M16A1 Rifle and Rifle Marksmanship
FM 3437	Nuclear, Biological and Chemical Reconnaissance and Decontamination Operations
FM 21-11	First Aid for Soldiers
FM 21-40	NBC (Nuclear, Biological and Chemical Defense)
TM 3-220	Chemical, Biological and Radiological (CBR) Decontamination
	Army Use Only
DA PAM 738-750	The Army Maintenance Management System (TAMMS)

MARINE CORPS USE ONLY

COMPONENTS LIST FOR RIFLE, 5.56MM, M16A2

PREFACE

SCOPE

1. This publication lists all components and accessories for collection-type supply items, such as major combinations, systems, groups, outfits, kits, sets or assortments. The components to be issued with the end item are identified under the heading of "SUPPLY SYSTEM RESPONSIBILITY" and when required, under the heading "COLLATERAL MATERIEL." End items requiring collateral materiel are governed by whether the end item is initial or replacement issue. The Marine Corps Logistics Support Base, Atlantic will direct whether the initial issue of the end item is with a collateral materiel set or replacement issue without collateral materiel. The components to be issued will consist of the quantity of items annotated in the "Quantity Used in Unit" column. The "USING UNIT RESPONSIBILITY" heading will reflect those items that are to be requisitioned separately through the supply system when applicable.

MARINE CORPS USE ONLY

COMPONENTS LIST FOR RIFLE, 5.56MM, M16A2 (CONT)

LIST OF COMPONENTS

2. This listing comprises the major portion of this publication. The data, arranged in columnar form, presents the information needed to identify the item and determine its type of issue.

3. *Item Number (Column 1)*. This column specifies a number assignment for each item as it appears in the list. Numbers are assigned in sequence and are for reference purposes only.

4. *Stock Number (Column 2)*. This column furnishes the National Stock Number (NSN) and to the item.

5. *Reference Designation/Figure-Key (Column 3)*. This column indicates circuit-symbol number designators or figure and index numbers to refer an item to a circuit diagram or illustration.

6. *Model (Column 4)*. This column indicates in alphabetical code the specific application of components, or assemblies when more than one model of the end item is contained in this publication.

7. *Item Identification (Column 5)*. This column provides the item name and description listed under the heading of either "SUPPLY SYSTEM RESPONSIBILITY," "COLLATERAL MATERIEL" or "USING UNIT RESPONSIBILITY." (See paragraphs 10, 11, and 12.)

MARINE CORPS USE ONLY

COMPONENTS LIST FOR RIFLE, 5.56MM, M16A2 (CONT)

8. *Unit of Measure (Column 6)*. This column gives the measurement standard of each item. It may or may not be the same as the unit of issue. For example, the unit of issue of a certain wire is coil but only 4 feet are required for the end item. Therefore, the unit of measure shown will not be used for requisitioning purposes. For the proper unit of issue and other required management data, refer to the applicable Management Data List (ML) when requisitioning.

9. *Quantity Used in Unit (Column 7)*. This column lists the total quantity of an item according to the unit of measure, required for full functional operation of the end item.

SUPPLY SUPPORT CATEGORIES

10. *Supply System Responsibility*. All or a portion of the items in this category, as appropriate for the type of issue, will be furnished by the supply system. Any item requiring replacement, while the end item is outside the stores distribution system, is the responsibility of the holding organization or using unit.

11. *Collateral Materiel*. All of the items in this category will be furnished with the end item when the end item is being shipped as initial issue. The 9999-00-000-0000 NSN shown under the heading of "COLLATERAL MATERIEL" is for control within the distribution system only, and is not *authorized* for requisitioning purposes.

MARINE CORPS USE ONLY

COMPONENTS LIST FOR RIFLE, 5.56MM, M16A2 (CONT)

12. *Using Unit Responsibility.* Items in this category will not be issued with the end item. They must be requisitioned through the supply system. The end item will be complete only when the total quantity of items shown in the "Quantity Used in Unit" column as well as those items listed under the heading "SUPPLY SYSTEM RESPONSIBILITY" and "COLLATERAL MATERIEL" are on hand.

5TH ECHELON REHABILITATION PROGRAM

13. Major items returned under this program will be evacuated under the provision(s) of the applicable Marine Corps Order(s) with the items listed under Supply System Responsibility. Repair, rebuild end replacement under a 5th Echelon rehabilitation program will be limited to these items only. Those items under the heading "COLLATERAL MATERIEL" shall be held by using organizations for application to the replacement end items.

CHANGES

14. Changes to this publication will be issued as required.

FOR MARINE CORPS USE ONLY

COMPONENTS LIST FOR RIFLE, 5.56MM, M16A2 (CONT)

REQUEST FOR ADDITIONAL COPIES

15. Additional copies of this publication may be requisitioned from the Commanding General, Marine Corps Logistics Base, (Code 876), Albany, Georgia 31704-5000.

ERRORS AND RECOMMENDATIONS

16. Errors in this publication or recommendations for its improvement should be submitted by using NAVMC 10772 "Report of Discrepancy in Supply Publications" form provided each Command for this purpose. If this form is not adequate to cover a particular situation or recommendation, a letter should be directed to Commandant of the Marine Corps, Code LMA-1, Headquarters U.S. Marine Corps, Washington, D.C., 20380. Army users submit DA Form 2028 (Recommend Changes to Publications and Blank Forms) direct to Commander, US Army Armament, Munitions and Chemical Command, ATTN: AMSMC-MAS, Rock Island, IL 61299-6000.

FOR MARINE CORPS USE ONLY

COMPONENTS LIST FOR RIFLE, 5.56MM, M1 6A2 (CONT)

MISCELLANEOUS

17. For full information concerning the Marine Corps Stocklist publications system, including its purpose and use and the principles employed in its compilation, see Marine Corps Stocklist, SL-1-1, Introduction to Marine Corps Stocklist Publications; for indexes thereof, see Marine Corps Stocklist micropublications SL-1-2, Index of Authorized Publications for Equipment Support, and SL-1-3, Index of Publications Authorized and Stocked by the Marine Corps (PASMIC).

SPECIAL NOTES

18. The Rifle, 5.56mm, M16A2, will be reported on Unit Property Control Records under NSN 1005-01-128-9936. Rifle, 5.56mm, M16A2, NSN 1005-01-128-9936 includes 1 ea magazine, NSN 1005-00-921-5004.

19. Maintenance Forms and Records. Marine Corps users maintain forms and records as prescribed by TM 4700-15/1. Department of the Army forms and records will be those prescribed by DA PAM 738-750.

LIST OF COMPONENTS

(FOR MARINE CORPS
USE ONLY)

COLLATERAL MATERIEL

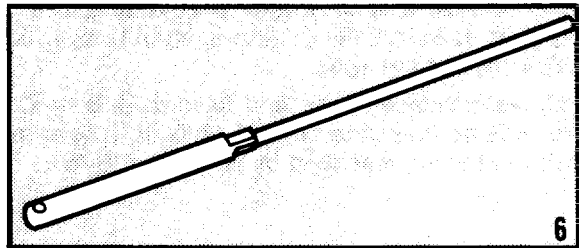
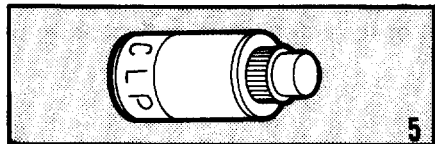
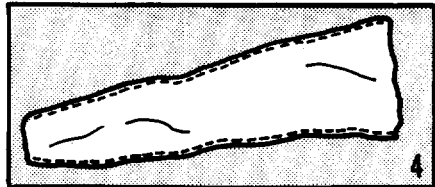
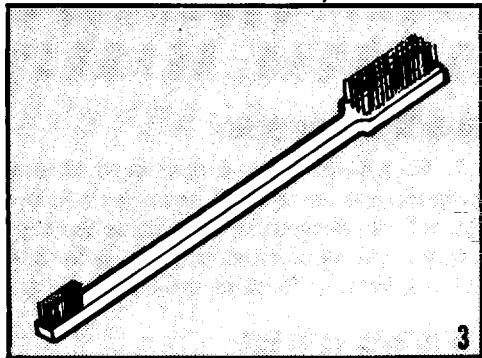
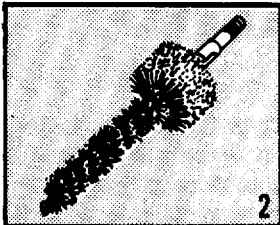
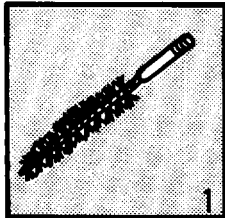

MARINE CORPS USE ONLY

COLLATERAL MATERIEL (CONT)

NSN 9999-01-189-3261

1 ITEM No.	2 STOCK NUMBER	3 REF DESIG FIG KEY	4 M O D E L	5 ITEM IDENTIFICATION	6 UNIT OF MEAS	7 QTY USED IN UNIT
1	1005-00-903-1296	1		BRUSH, CLEANING, SMALL ARMS: Bore; Rock Island Arsenal, 11686340	EA	1
2	1005-00-999-1435	2		BRUSH, CLEANING, SMALL ARMS: Chamber; Rock Island Arsenal, 8432358	EA	1
3	1005-00-494-6602	3		BRUSH, CLEANING: Tooth; Rock island Arsenal, S448462	EA	1
4	1005-00-403-5804	4		CASE, SMALL ARMS ACCESSORY: Rock Island Arsenal, 8448751	EA	1
6	005-01-113-0321	6		HANDLE ASSEMBLY: Rock Island Arsenal, 8436776	EA	1

MARINE CORPS USE ONLY COLLATERAL MATERIEL (CONT)

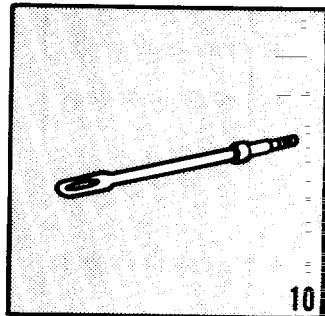
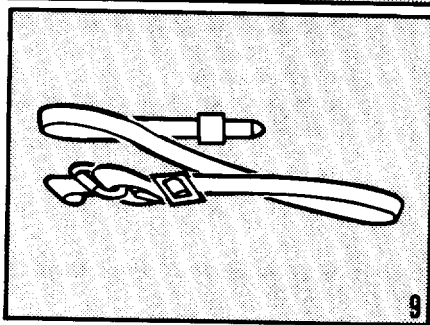
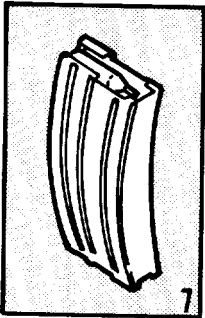
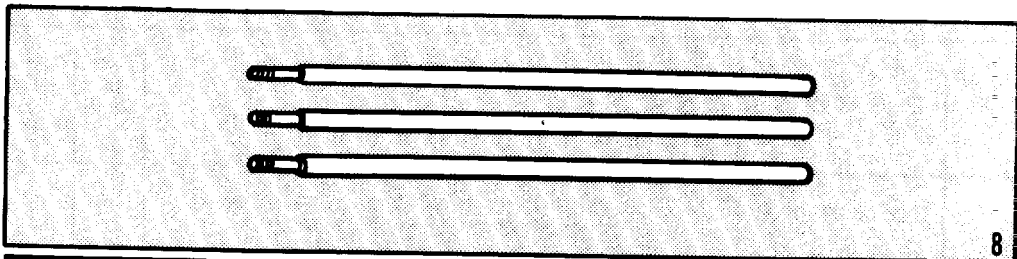

MARINE CORPS USE ONLY

COLLATERAL MATERIEL (CONT)

1 ITEM Nō.	2 STOCK NUMBER	3 REF DESIG FIG KEY	4 M O D E L	5 ITEM IDENTIFICATION	6 UNIT OF MEAS	7 QTY USED IN UNIT
7	1005-00-921-5004	7		MAGAZINE CARTRIDGE: 30 round; Rock Island Arsenal, 8448670	EA	6
8	1005-00-050-6357	8		ROD SECTION: Rock Island Arsenal, 8436775	EA	3
9	1005-01-083-8113	9		SMALL ARMS SLING: Rock Island Arsenal,	EA	1
10	1005-00-937-2250	10/		SWAB HOLDER SECTION: Rock Island Arsenal, 11686327	EA	1

USING UNIT RESPONSIBILITY

NOTE

Using units should refer to the SL-1-2 and requisition the required Duplication to support the item identified by the ID number shown on the cover manual.

1 ITEM NO.	STOCK NUMBER	3 REF DESIG FIG KEY	5 ITEM IDENTIFICATION	6 UNIT OF MEAS	7 QTY USED IN UNIT
11	1005-00-193-8306		BAG, PROTECTIVE MAGAZINE: Rock Island Arsenal 8448464	EA	A/R
12	1005-00-073-9238		BAYONET-KNIFE: Rock Island Arsenal, 11010077	EA	1
13	1005-00-118-6192		BLANK FIRING ATTACHMENT: Rock Island Arsenal, 12002900	EA	A/R
14	1005-00-242-5687		BOTTLE ASSEMBLY: Rock Island Arsenal, 8448444 (1 oz bottle for LAW)	EA	A/R
15	5340-00-880-7666		CAR PROTECTIVE, DUST: Rock Island Arsenal, 8445067	EA	A/R
A15	9150-01-102.1473		CLEANER, LUBRICANT AND PRESERVATIVE: Military Specifications Promulgated by Standard ization Division Directorate of Logistic Services DSA, MIL-L-63460 (1/2 oz bottle)		A/R

USING UNIT RESPONSIBILITY (CONT)

1 ITEM NO.	STOCK NUMBER	3 REF DESIG FIG KEY	4 M O D E L	5 ITEM IDENTIFICATION	6 UNIT OF MEAS	7 QTY USED IN UNIT
16	9920-00-292-9946			CLEANER, TOBACCO PIPE: American Tobacco Company American Brands Inc DILLSPIPECLEANER (36 per pkg)	EA	A / R
17	1005-00-609-2190			COVER, PROTECTIVE, RIFLE: Rock Island Arsenal, 8448213	EA	A / R
16	1005-00-406-1570			KIT, ADAPTER, TOP SLING: Rock Island Arsenal, 8448471	EA	A / R
19	9150-00-292-9689			LUBRICATING OIL, ARTIC WEAPONS (LAW): Military Specifications Promulgated by Standardization Division Directorate of Logistic Services DSA, MIL-L-14107 (1 quart can)	EA	A / R
20	1005-00-233-9031			PLATE, LOCKING: (for fire control use) Rock Island Arsenal, 8448876	EA	A / R
21	7920-00-205-1711			RAG, WIPING: Federal Commercial Item Description executed by General Services Administration, A-A-531 (50 lb ball)	LB	A / R
22	1095-00-223-7164			SCABBARD, BAYONET KNIFE M8A1 or M10: Rock Island Arsenal, 8448476	EA	1

MARINE CORPS USE ONLY

USING UNIT RESPONSIBILITY (CONT)

1 TEM NO.	2 STOCK NUMBER	3 REF DESIG FIG KEY	4 M O D E	5 ITEM IDENTIFICATION	6 UNIT OF MEAS	7 QTY USED IN UNIT
23	1005-00-912-4248			SWAB, SMALL ARMS: Rock Island Arsenal, 11686408 (1000 per pkg)	MX	A/R
24	6920-01-152-2891			TARGET, ZEROING: Rock Island Arsenal, 9357935 (500 sheet ream)	EA	A/R

(ARMY USE ONLY)
COMPONENTS OF END ITRM AND BASIC ISSUE
ITEMS LISTS

Section I. INTRODUCTION

1. SCOPE . This section lists components of end item and basic issue items for the rifle to help you inventory items required for safe and efficient operation.

2. GENERAL. The Components of End Item and Basic Issue Items Lists are divided into the following sections:

a. Section II. Components of End Item. This listing is for informational purposes only, and is not authority to requisition replacements. These items are part of the end item, but are removed and separately packaged for transportation or shipment. As part of the end item, these items must be with the end item whenever it is issued or transferred between property accounts. Illustrations are furnished to assist you in identifying the items.

b. Section III. Basic Issue Items. These are the minimum essential items required to place the rifle in operation, to operate it, and to perform emergency repairs. Although shipped separately packaged, BII must be with the rifle during operation and whenever it is transferred between property accounts. The illustrations will assist you with hard-to-identify items. This manual is your authority to request/requisition replacement BII, based on TOE/MTOE authorization of the end item.

(ARMY USE ONLY)

3. EXPLANATION OF COLUMNS. The following provides an explanation of columns found in the tabular listings :

a. Column (1) - Illustration Number (Illus Number). This column indicates the number of the illustration in which the item is shown.

b. Column (2) - National Stock Number. Indicates the National Stock Number assigned to the item and will be used for requisitioning purposes.

c . Column (3) - Description. Indicates the Federal item name and, if required, a minimum description to identify and locate the item. The last line for each item indicates the FSCM (in parentheses) followed by the part number.

d. Column (4) - Unit of Measure (U/M) Indicates the measure used in performing the actual Operation/maintenance function. This measure is expressed by a two-character alphabetical abbreviation (e.g., ea, in.,pr).

e. Column (5) - Quantity required (Qty rqr). Indicates the quantity of the item authorized to be used with/on the equipment.

(ARMY USE ONLY)

Section II. COMPONENTS OF END ITEM (See illustration on page 112).

(1) Illus Number	(2) National Stock Number	(3) Description FSCM and Part Number	Usable On Code	(4) U/M	(5) Qty rqr
1	1005-00-921-5004	MAGAZINE, CARTRIDGE: 30 round (19204) 8448670		EA	1
2	1005-01-083-8113	SLING, SMALL ARMS (19204) 11833432		EA	1

(ARMY USE ONLY)

Section III. **BASIC ISSUE ITEMS**

(1) Illus Number	(2) National Stock Number	(3) Description FSCM and Part Number	Usable On Code	(4) U/M	(5) Qty rqr
1		TM 05538C-10/1A/ TM 9-1005-319-10		EA	1

ADDITIONAL AUTHORIZATION LIST (AAL)

Section I . INTRODUCTION

1. SCOPE. This section lists additional items you are authorized for the support of the rifle.

2. GENERAL. This list identifies items that do not have to accompany the rifle and that do not have to be turned in with it. These items are all authorized to you by CTA, MTOE , TDA, or JTA.

3. EXPLANATION OF LISTING. National stock numbers , descriptions , and quantities are provided to help you identify and request the additional items you require to support this equipment. The items are listed in alphabetical sequence by item name under the type document (i.e. , CTA, MTOE, TDA, or JTA) which authorizes the item(s) to you.

(ARMY USE ONLY)

Section II . ADDITIONAL AUTHORIZATION LIST (AAL)

(1)	(2)	(3)	(4)
NATIONAL STOCK NUMBER	DESCRIPTION	USABLE ON CODE	QTY AUTH
	CTA AUTHORIZED ITEMS		
1005-00-193-8306	BAG, PROTECTIVE: for 30 round magazine (500 per box) required 1 per magazine (19204) 8448464	EA	1
1005-00-118-6192	BLANK FIRING ATTACHMENT, M15A2 , (For Training Only) (19204) 12002900	EA	1
1005-00-242-5687	BOTTLE ASSEMBLY CYLINDRICAL (19204) 8448444	EA	1

(ARMY USE ONLY)

Section II. ADDITIONAL AUTHORIZATION LIST (AAL) (CONT)

(1) NATIONAL STOCK NUMBER	(2) DESCRIPTION FSCM AND PART NUMBER	USABLE ON CODE	(3) U/M	(4) QTY AUTH
1005-00-903-1296	BRUSH, CLEANING, SMALL ARMS : bore {19204} 11686340		EA	1
1005-00-999-1435	BRUSH , CLEANING, SMALL ARMS : chamber (19204) 8432353		EA	1
1005-00-494-6602	BRUSH , CLEANING , SMALL ARMS : tooth (19204) 8448462		E A	1
5340-00-880-7666	CAP , PROTECTIVE, DUST (19204) 8445067		EA	1
1005-00-403-5804	CASE , SMALL ARMS : for rifles with buttstock stowage (19204) 8448751		EA	1

(ARMY USE ONLY)

Section II. ADDITIONAL AUTHORIZATION LIST (AAL) (CONT)

(1) NATIONAL STOCK NUMBER	(2) DESCRIPTION FSCM AND PART NUNEER	USABLE ON CODE	(3) U/M	(4) QTY AUTH
1005-01-113-0321	HANDLE SECTION, CLEANING ROD , SNALL ARNS (19204) 8436776		EA	1
1005-00-921-5004	NAGAZINE, CARTRIDGE : 30 round (19204) 8448670		EA	1
1005-00-233-9031	PLATE, LOCKING : for riot control use, prevents selector from automatic fire (refer to organization maintenance for installation and instructions on use (19204) 8448676		EA	1
1005-00-050-6357	ROD SECTION, CLEANING ROD , SMALL ARNS (19204) 8436775		EA	3

(ARMY USE ONLY)

Section II. ADDITIONAL AUTHORIZATION LIST (AAL) (CONT)

(1) NATIONAL STOCK NUMBER	(2) DESCRIPTION FSCM AND PART NUMBER	(3) USABLE ON CODE	(4) U/M	(5) QTY AUTH
1005-00-937-2250	SWAB HOLDER SECTION , CLEANING ROD , SMALL ARMS (19204) 11686327		EA	1

(ARMY USE ONLY)

Section II. ADDITIONAL AUTHORIZATION LIST (AAL) (CONT)

(1) NATIONAL STOCK NUMBER	(2) DESCRIPTION FSCM AND PART NUMBER	(3) USABLE ON CODE	(4) QTY AUTH
MTOE AUTHORIZED ITEMS			
1005-00-017-9701	BAYONET - KNIFE M7 W/SCABBARD (19204) 8427025	EA	1
1005-00-406-1570	TOP SLING ADAPTER KIT (19204) 8448471	EA	1

(ARMY USE ONLY)

EXPENDABLE/DURABLE SUPPLIES AND
MATERIALS LIST (EDSML)

Section I . INTRODUCTION

1. SCOPE. This section lists expendable supplies and materials you will need to operate and maintain the M16A2 rifle. This listing is for informational purposes only and is not authority to requisition the listed items. These items are authorized to you by CTA 50-970, Expendable/Durable Items (Except Medical, Class V, Repair Parts , and Heraldic Items) , or CTA 8-100, Army Medical Department Expendable/Durable Items.

2. EXPLANATION OF COLUMNS.

a. Column (1) - Item Number. This number is assigned to the entry in the listing and is referenced in the narrative instructions to identify the material (e.g., "Use protective cover (item 3)")

(ARMY USE ONLY)

2. EXPLANATION OF COLUMNS (CONT)

b. Column (2) - Level. This column identifies the lowest level of maintenance that requires the listed item.

C - Operator/Crew

c. Column (3) - National Stock Number. This is the National stock number assigned to the item; use it to request or requisition the item.

d. Column (4) - Description. Indicates the Federal item name and, if required, a description to identify the item. The last line for each item indicates the Federal Supply Code for Manufacturer (FSCM) in parentheses followed by the part number.

e. Column (5) - Unit of Measure (U/M) . Indicates the measure used in performing the actual maintenance function. This measure is expressed by a two-character alphabetical abbreviation (e.g. , ea, in. , pr) . If the unit of measure differs from the unit of issue , requisition the lowest unit of issue that will satisfy your requirements.

(ARMY USE ONLY)

Section II . EXPENDABLE SUPPLIES AND MATERIALS LIST (ESML)

(1)	(2)	(3)	(4)	(5)
ITEM NO.	LEVEL	NATIONAL STOCK NUMBER	DESCRIPTION	U/M
1	c	9150-01-102-1473	CLEANER, LUBRICANT AND PRESERVATIVE: 3-oz bottle (81349) MIL-L-63460	Oz
2	c	9920-00-292-9946	CLEANER, TOBACCO PIPE : cotton tuft, wire core (32 per pk) (89855) DILLSPIPECLEANER	EA
3	c	1005-00-809-2190	COVER, PROTECTIVE (19204) 8448213	EA

(ARMY USE ONLY)

Section II . EXPENDABLE SUPPLIES AND MATERIALS LIST (ESML) (CONT)

(1) ITEM NO.	(2) LEVEL	(3) NATIONAL STOCK NUMBER	(4) DESCRIPTION	(5) U/M
4	c	9150-00-292-9689	LUBRICATING OIL, ARTIC WEAPONS (LAW) MIL-L-14107 (1 quart can)	EA
5	c	7920-00-205-1711	RAG, WIPING : 50 lb bdl (58536) A-A-531	LB
6	c	1005-00-912-4248	SWAB , SMALL ARMS CLEANING: cotton, 1 pkg (1000 per package) (19204) 11686408	EA

TRAJECTORIES OF AIMED RIFLE FIRE WITH CORRECT ELEVATION SET ON REAR SIGHT ELEVATION KNOB

METRIC CO

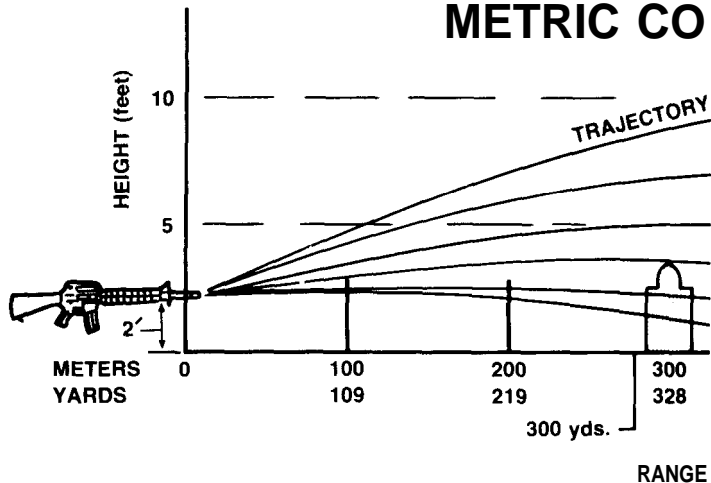

Point of aim at each target, at all ranges, is "center of mass" or in center of chest. Point of impact is also center of mass. Note that fire on target at 300 meters is also effective on 400 meter target. At 600 meters, fire does not exceed the height of a man at any point along its trajectory.

INVERSION CHART

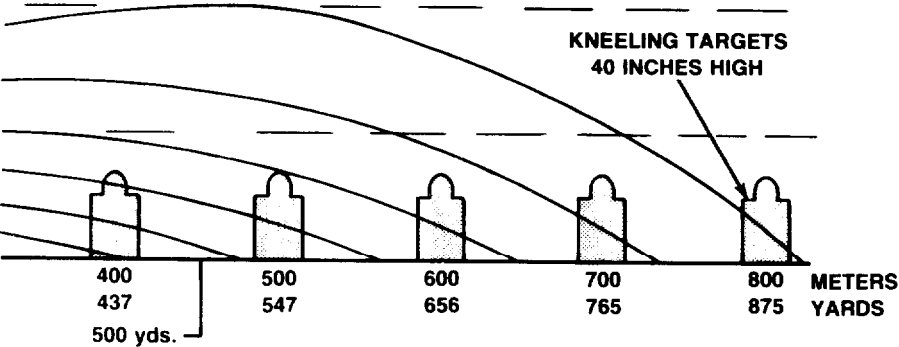

(meters & yards)

TM 05538C-10/1A
TM-9-1005-319-10
W/Changes 1-4

DEPARTMENT OF THE NAVY
Headquarters, U.S. Marine Corps
Washington, D.C. 20380-0001

29 August 1986

1. This Manual contains operating instructions and a components list for the M16A2 Rifle.
2. This is a revised edition which includes Changes 1 through 4. All previous editions are hereby superseded.
3. Notice of discrepancies or suggested changes should be forwarded on NAVMC 10772 to the Commanding General, Marine Corps Logistics Base (Code 850), Albany, Georgia 31704-5000.

BY DIRECTION OF THE COMMANDANT OF THE MARINE CORPS

OFFICIAL:



J. G. O'NEILL
Head, Materiel Acquisition Support Branch
Materiel Division
Installations and Logistics Department

By Order of the Secretary of the Army:

OFFICIAL:

R.L. DILWORTH
Brigadier General, U.S. Army
The Adjutant General

JOHN A. WICKHAM, JR.
General, United States Army
Chief of Staff

DISTRIBUTION: BN

Copy to: 7000161(4)

THIS PUBLICATION IS REQUIRED FOR OFFICIAL USE OR FOR ADMINISTRATIVE OR OPERATIONAL PURPOSES. DISTRIBUTION IS LIMITED TO U.S. GOVERNMENT AGENCIES ONLY. OTHER REQUESTS FOR THIS DOCUMENT MUST BE REFERRED TO: COMMANDANT OF THE MARINE CORPS (HQSP-2), WASHINGTON, C.C. 20380-0001.

05538C-10/1
-1005-319-10