

ARMY, MARINE CORPS, NAVY, AIR FORCE

**MULTISERVICE
TACTICS,
TECHNIQUES, AND
PROCEDURES FOR
NUCLEAR,
BIOLOGICAL, AND
CHEMICAL (NBC)
PROTECTION**

**FM 3-11.4 (FM 3-4)
MCWP 3-37.2
NTTP 3-11.27
AFTTP (I) 3-2.46**

**June
2003**

DISTRIBUTION RESTRICTION:
Approved for public release;
distribution is unlimited.



MULTISERVICE TACTICS, TECHNIQUES, AND PROCEDURES

FOREWORD

This publication has been prepared under our direction for use by our respective commands and other commands as appropriate.



PATRICIA L. NILO
Brigadier General, USA
Commandant
US Army Chemical School

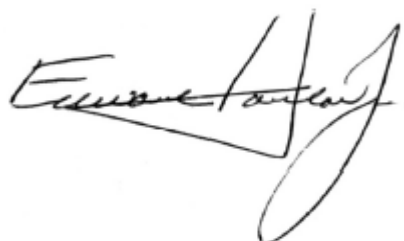

EDWARD HANLON, JR.
Lieutenant General, USMC
Commanding General
Marine Corps Combat
Development Command



R.A. ROUTE
Rear Admiral, USN
Commander
Navy Warfare Development Command



DAVID F. MACGHEE, JR.
Major General, USAF
Commander
Headquarters Air Force Doctrine Center

This publication is available at Army Knowledge Online (www.us.army.mil) and the General Dennis J. Reimer Training and Doctrine Digital Library at (www.adtdl.army.mil)

PREFACE

1. Scope

This publication is designed for use at the tactical and operational level. It defines the roles of military units and staffs involved in the planning and execution of military operations in a possible nuclear, biological, and chemical (NBC) environment. This manual provides multiservice tactics, techniques, and procedures (MTTP) for NBC protection. It addresses individual and collective protection (COLPRO) considerations for protection of the force and civilian personnel protection considerations. This manual focuses on the need for all United States (US) forces to be prepared to fight in an NBC environment. It addresses the risk management that occurs when determining what NBC protection measures could be considered to mitigate the risk of operations in an NBC environment. The planning and coordination for NBC protection takes place with the realization that the potential NBC environment could be one in which there is deliberate or accidental employment of NBC weapons, deliberate or accidental attacks or contamination with toxic industrial material (TIM), or deliberate or accidental attacks or contamination with radiological materials (see Joint Publication [JP] 3-11, *Joint Doctrine for Operations in Nuclear, Biological, and Chemical (NBC) Environments*).

2. Purpose

This publication provides a reference for NBC protection; bridges the gap between service and joint doctrine; and contains tactics, techniques, and procedures (TTP) for planning and executing operations in an NBC environment. This manual addresses concepts, principles, and TTP—to include planning, operational considerations, and

training and support functions. It serves as the foundation for development of multiservice manuals and refinement of existing training support packages (TSPs), mission training plans (MTPs), training center and unit exercises, and service school curricula. It drives the examination of organizations and materiel developments applicable to NBC protection.

3. Application

The audience for this publication is combatant commands, joint task forces (JTFs), functional and service component units, and staffs in foreign and domestic locations that could be challenged by operations in an NBC environment.

4. Implementation Plan

Participating service command offices of primary responsibility (OPRs) will review this publication; validate the information; reference and incorporate it in service and command manuals, regulations, and curricula as follows:

Army. The United States Army (USA) will incorporate this publication in USA training and doctrinal publications as directed by the Commander, USA Training and Doctrine Command (TRADOC). Distribution is according to the USA publication distribution system.

Marine Corps. The United States Marine Corps (USMC) will incorporate the procedures in this publication in USMC training and doctrinal publications as directed by the Commanding General, US Marine Corps Combat Development Command (MCCDC). Distribution is according to the USMC publication distribution system.

Navy. The United States Navy (USN) will incorporate the procedures in this publication in training and doctrinal publications as directed by the Commander, Navy Warfare Development Command (NWDC). Distribution is according to the *Military Standard Requisitioning and Issue Procedures (MILSTRIP) Desk Guide*.

Air Force. The United States Air Force (USAF) will validate and incorporate appropriate procedures according to applicable governing directives. It will develop and implement this and other NBC MTTPs through a series of USAF manuals providing service-specific TTPs. Distribution is according to the USAF publication distribution system.

Coast Guard. The United States Coast Guard (USCG) will validate and refer to appropriate procedures when applicable. No material contained herein should conflict with USCG regulations or other directives from higher authority or supersede or replace any order or directive issued by higher authority.

5. User Information

a. The US Army Chemical School developed this publication with the participation of the approving service commands.

b. This publication reflects current service and joint doctrine, command and control (C²) organizations, facilities, personnel, responsibilities, and procedures.

c. Recommended changes are encouraged for improving this publication. Key any comments to the specific page and paragraph, and provide a rationale for each recommendation. Send comments and recommendations directly to—

Army

**Commandant
US Army Chemical School
ATTN: ATSN-CM-DD
401 MANSCEN Loop, Suite 1029
Fort Leonard Wood MO 65473-8926
COMM (573) 596-0131 extension 3-7364**

Marine Corps

**Commanding General
US Marine Corps Combat Development Command
ATTN: C42 (Director)
3300 Russell Road
Quantico VA 22134-5001
DSN 278-6234 COMM (703) 784-6234**

Navy

**Commander
Navy Warfare Development Command
ATTN: N5
686 Cushing Road
Newport, RI 02841-1207
DSN 948-4201 COMM (401) 841-4201**

Air Force

**HQ Air Force Doctrine Center
ATTN: DJ
204 Dodd Boulevard, Suite 301
Langley AFB VA 23665-2788
DSN 574-8091 COMM (757) 764-8091
E-mail Address: afdc.dj@langley.af.mil**

Unless this publication states otherwise, masculine nouns and pronouns do not refer exclusively to men.

*FM 3-11.4 (FM 3-4)
 MCWP 3-37.2
 NTTP 3-11.27
 AFTTP (I) 3-2.46
 2 June 2003

FM 3-11.4

US Army Training and Doctrine Command
 Fort Monroe, Virginia

MCWP 3-37.2

Marine Corps Combat Development Command
 Quantico, Virginia

NTTP 3-11.27

Navy Warfare Development Command
 Newport, Rhode Island

AFTTP (I) 3-2.46

Headquarters Air Force Doctrine Center
 Maxwell Air Force Base, Alabama

Multiservice Tactics, Techniques, and Procedures for Nuclear, Biological, and Chemical (NBC) Protection

TABLE OF CONTENTS

	Page
EXECUTIVE SUMMARY	xi
PROGRAM PARTICIPANTS	xiii
CHAPTER I	
NUCLEAR, BIOLOGICAL, AND CHEMICAL PROTECTION	
Background... ..	I-1
Basic Fundamentals	I-1
Planning	I-6
Protecting the Force	I-7
Preparedness	1-8
Protection Components	I-11
CHAPTER II	
PREATTACK, DURING-ATTACK, AND POSTATTACK PROTECTIVE ACTIONS	
Background.....	II-1

*This publication supersedes FM 3-4, 29 May 1992

	Common Preattack Actions	II-1
	Nuclear Protection	II-7
	Biological Protection	II-15
	Chemical Protection	II-19
	Collective Protection Operations	II-26
	Toxic Industrial Material Protection	II-28
CHAPTER III	OPERATIONS IN UNIQUE ENVIRONMENTS	
	Background.....	III-1
	Cold Weather.....	III-1
	Desert	III-7
	Jungle	III-8
	Mountains.....	III-8
	Urban Areas	III-9
	Littoral Environments	III-10
CHAPTER IV	MISSION-ORIENTED PROTECTIVE POSTURE ANALYSIS	
	Background.....	IV-1
	Analysis	IV-1
	Guidance.....	IV-3
	Levels	IV-4
CHAPTER V	SUSTAINED OPERATIONS IN A NUCLEAR, BIOLOGICAL, AND CHEMICAL ENVIRONMENT	
	Background.....	V-1
	Impact of a Nuclear, Biological, and Chemical Environment	V-1
	Impact of a Nuclear, Biological, and Chemical Environment on Operations	V-3
	Impact of a Nuclear, Biological, and Chemical Environment on Sustainment	V-5
	Executing Countermeasures	V-6
CHAPTER VI	INDIVIDUAL PROTECTION	
	Background.....	VI-1
	Mission-Oriented Protective Posture.....	VI-1
	Individual Protection Logistics Considerations.....	VI-5
	Toxic Industrial Material Individual Protection	VI-6
CHAPTER VII	COLLECTIVE PROTECTION	
	Background.....	VII-1
	Planning for Collective Protection.....	VII-1
	Fixed-Site Collective Protection	VII-5
	Transportable Collective Protection.....	VII-10

	Mobile Collective Protection	VII-12
	Navy Collective Protection Systems (Surface Ship).....	VII-16
APPENDIX A	NUCLEAR, BIOLOGICAL, AND CHEMICAL PROTECTIVE EQUIPMENT	
	Background.....	A-1
	Protective Clothing	A-1
	Protective Masks	A-5
	Toxic Industrial Material Protection	A-9
	Decontamination Equipment	A-10
	Chemical Detector Paper/Kits	A-12
	First Aid Equipment	A-12
	Related Equipment (Chemical Monitors, Radiation Detection Instruments and Biological Detectors)	A-14
APPENDIX B	GUIDELINES FOR THE NUCLEAR, BIOLOGICAL, AND CHEMICAL PORTION OF A COLLECTIVE PROTECTION STANDING OPERATING PROCEDURE	
	Background.....	B-1
	Suggested Guidelines for Preparation of a Collective Protection System Standing Operating Procedure.....	B-1
	Entry and Exit Procedure	B-6
	Wartime Shelter Preparation and Operation	B-28
	Classes of Site Collective Protection and Associated Protective Equipment	B-31
APPENDIX C	HUMAN FACTORS EFFECTS OF MISSION-ORIENTED PROTECTIVE POSTURE	
	Background.....	C-1
	Physiological Factors	C-1
	Psychological Factors	C-4
	Chemical Protective Overgarment Work/Rest Cycles and Water Replacement Guidelines	C-5
APPENDIX D	RADIOLOGICAL PROTECTION	
	Background.....	D-1
	Operational Exposure Guidance	D-1
	Low-Level Radiation	D-5
	Depleted Uranium.....	D-12
APPENDIX E	TOXIC INDUSTRIAL CHEMICALS-AN ASSESSMENT OF NUCLEAR, BIOLOGICAL, AND CHEMICAL FILTER PERFORMANCE	
	Background.....	E-1
	Filter System Operations	E-1
	Filter Assessment	E-2

APPENDIX F	NONCOMBATANT EVACUATION OPERATIONS	
	Background.....	F-1
	Planning.....	F-1
	Stages of Noncombatant Evacuation Operations.....	F-1
	Noncombatant Evacuation Operations in a Nuclear, Biological, and Chemical Environment.....	F-2
APPENDIX G	NUCLEAR, BIOLOGICAL, AND CHEMICAL DEFENSE EQUIPMENT DATA	
APPENDIX H	WEAPONS OF MASS DESTRUCTION THREATS USING POSTAL MAIL/PACKAGES	
	Background.....	H-1
	Possible Indicators and Characteristics of Suspect Mail/Packages.....	H-1
	Handling Instructions.....	H-2
	Reach-Back Capability.....	H-5
APPENDIX I	PROTECTIVE MASK PRESCRIPTION OPTICAL INSERTS	
	Background.....	I-1
	M40/M42 Series.....	I-1
	M43 Series.....	I-2
	M45 Series.....	I-2
	M48 Series.....	I-2
	MCU2/P Series.....	I-2
	M17 Series.....	I-3
	M17 A1/A2.....	I-3
	Joint Service General-Purpose Mask.....	I-3
APPENDIX J	ELECTROMAGNETIC PULSE PROTECTION CONSIDERATIONS	
	Background.....	J-1
	Electromagnetic Pulse.....	J-1
	Electromagnetic Pulse Mitigation Techniques.....	J-1
REFERENCES		References-1
GLOSSARY		Glossary-1
INDEX		Index-1
FIGURES		
	I-1 NBC Information Management.....	I-10
	VII-1 General Layout for an NBC Shelter.....	VII-5
	VII-2 Tent used as a CCA.....	VII-8
	A-1 Wet-Weather Gear.....	A-3

A-2	Nuclear, Biological, and Chemical Equipment Bag.....	A-3
A-3	Chemical Protective Helmet Cover.....	A-5
A-4	Aircrew Eye/Respiratory Protection	A-7
A-5	MCU-2A/P Protective Mask.....	A-8
A-6	M41 Protection Assessment Test System.....	A-9
A-7	ABC-M11 Portable Decontaminating Apparatus.....	A-11
A-8	M13 Decontaminating Apparatus, Portable	A-12
B-1	M12 Protective Entrance.....	B-33
B-2	Collective-Protection Entrance Configurations.....	B-34

TABLES

II-1	Standardized Alarm Signals for the US and its Territories and Possessions (Recommended)	II-4
II-2	Standardized Alarm Signals for OCONUS Bases and Stations Subject to Nuclear, Biological, and Chemical Attacks (Recommended).....	II-6
II-3	Shielding Values of Each Cover for a 2,400-Centigray Free-In-Air Dose	II-10
II-4	Shielding Values of Each Cover for a 2,400-Centigray, Sand or Clay-Filled Sandbags, Free-In-Air Dose	II-10
II-5	Wartime Climatic Filter Exchange Intervals, Blood Agent Threat is High (Given in Weeks)	II-25
IV-1	MOPP Analysis	IV-1
IV-2	MOPP Level 0	IV-5
IV-3	MOPP Level 1	IV-6
IV-4	MOPP Level 2	IV-7
IV-5	MOPP Level 3	IV-8
IV-6	MOPP Level 4	IV-9
IV-7	MOPP Differences (Afloat versus Ashore).....	IV-10
V-1	Factors That Influence Decreased Tolerance	V-2
V-2	Common Signs of Physiological and Psychological Degradation.....	V-2
V-3	Depression/Hyperactivity Behaviors	V-3
V-4	Impact of an NBC Environment on Leaders	V-3
V-5	Impact of an NBC Environment on Individuals	V-3
V-6	Potential Risks From Operations in an NBC Environment....	V-5
VI-1	Protective Clothing Capabilities	VI-2
VII-1	Sample Sheltering Instructions	VII-10
VII-2	Types of COLPRO Systems	VII-13

VII-3	COLPRO MOPP Levels	VII-14
VII-4	Advantages and Disadvantages of COLPRO Systems	VII-15
B-1	CCA Processing Steps to Enter an Open-Air TFA.....	B-17
C-1	Work Intensities of Military Tasks	C-1
C-2	Work/Rest Cycles and Water Replacement Guidelines	C-6
D-1	Operational Radiation Exposure Status and Risk Criteria.....	D-2
D-2	Low-Level Radiation Guidance For MOOTW	D-4
D-3	Contamination Control Guidance (For up to a 7-day mission or within a 90-day mission)	D-6
D-4	Recommended Maximum-Permissible Contamination Levels	D-13
E-1	Protection Afforded By NBC Filters For Selected TIC	E-3
G-1	NBC Defense Equipment	G-2
H-1	Reach-Back Points of Contact	H-5

EXECUTIVE SUMMARY

Multiservice Tactics, Techniques, and Procedures for Nuclear, Biological, and Chemical Protection

Nuclear, Biological, and Chemical Protection

Chapter I discusses NBC protection challenges.

Preattack, During-Attack, and Postattack Protective Actions

Chapter II addresses actions that can be taken before, during, and after an NBC attack. Because operations in an NBC environment can include TIM incidents, this chapter also addresses suggested protective actions that can be taken in response to a TIM event.

Operations In Unique Environments

Chapter III addresses how weather and terrain affect the need for NBC protection. Certain weather conditions will greatly influence the use of NBC weapons. Likewise, different types of terrain will alter the effects of NBC weapons.

Mission-Oriented Protective Posture Analysis

Chapter IV addresses the guidance for determining the appropriate levels of protection in an NBC environment.

Sustained Operations in a Nuclear, Biological, and Chemical Environment

Chapter V provides insights into the degradation to be expected from enemy employment of NBC weapons. The basic goals remain to avoid or minimize the impact of the contamination and to enhance endurance and task performance. When individuals are encapsulated in individual protective equipment (IPE), they are subjected to both physiological and psychological stresses; however, given an understanding of the NBC environment, its impact, and proper training, individuals can perform assigned tasks successfully for a considerable period of time.

Individual Protection

Chapter VI provides an overview of the individual protection capabilities that are available and/or issued to the armed forces of the US.

Collective Protection

Chapter VII addresses COLPRO planning considerations. It also discusses COLPRO capabilities such as fixed-site, transportable, mobile, and Navy COLPRO systems.

PROGRAM PARTICIPANTS

The following commands and agencies participated in the development of this publication.

Joint

Joint Chiefs of Staff, J5, Nuclear, and Counterproliferation Division, The Pentagon, Room 2S938, Washington, DC 20318.

Defense Threat Reduction Agency, 8725 John J. Kingman Road, Fort Belvoir, VA 22060.

Army

United States Army Chemical School, 401 MANSCEN Loop, Suite 1029, Fort Leonard Wood, MO 65473.

United States Army Medical Department Center and School, 1400 E. Grayson Street, Fort Sam Houston, TX 78234.

United States Army Soldier Biological Chemical Command, Aberdeen Proving Ground, MD 21040.

Marine Corps

United States Marine Corps NBC Defense School, 1273 Iowa Avenue, Fort Leonard Wood, MO 65473.

United States Marine Corps Combat Development Command, 3300 Russell Road, Suite 318A, Quantico, VA 22134-5021

Navy

United States Navy Warfare Development Command, 686 Cushing Road, Sims Hall, Newport, RI 02841.

United States Navy Surface Warfare Officer School Command, 446 Cushing Road, Newport, RI, 02841

United States Navy, Chief of Navy Operations N70 CP, 2812 Summerfield Road, Falls Church, VA 22032.

United States Navy Facilities Command, 1322 Patterson Avenue, Washington, DC 20374.

United States Navy Surface Warfare Development Group, 2200 Amphibious Drive, Norfolk, VA 23521.

Air Force

Air Combat Command, 129 Andrews Street, Suite 102, Langley AFB, VA 23655.

United States Air Force Civil Engineer Support Activity, 14a Barnes Drive, Suite 1, Tyndall AFB, FL 32403.

United States Air Force Special Operations Command, 100 Bartley Street, Suite 153W, Hurlburt Field, FL 32544.

United States Air Force Doctrine Center, Detachment 1, 216 Sweeney Boulevard, Suite 109, Langley AFB, VA 23665.

United States Air Force Counterproliferation Center, 325 Chennault Circle, Maxwell AFB, AL 36112.

Chapter I

NUCLEAR, BIOLOGICAL, AND CHEMICAL PROTECTION

1. Background

This chapter discusses NBC protection fundamentals, protection planning, basic considerations for protection of the force, NBC preparedness, and the components of NBC protection.

2. Basic Fundamentals

There are several basic fundamentals that impact NBC protective actions. These actions can include conducting intelligence preparation of the battlespace (IPB), providing exposure guidance, conducting risk assessment, establishing protection requirements, conducting protective actions, sustaining protective actions, providing supervision and evaluation, ensuring warning and dewatering of personnel, and conducting medical surveillance.

a. Conducting IPB. The IPB process must account for both confirmed as well as plausible but unconfirmed adversary capabilities, plans, and actions. The commander uses the IPB process to identify and answer priority intelligence requirements (PIRs). The IPB allows the commander to visualize the area of operation (AO) and discern the adversary's probable intent. The commander must take into account the potential adversary's NBC capabilities in assessments, estimates, and plans. The NBC staff uses the IPB process (in coordination with the medical and intelligence sections) and addresses the capabilities and limitations of the adversary's NBC weapons and delivery systems; the procedures for command, control, and release; the indicators of intent to employ NBC weapons; and the identification of possible TIM in AOs. The NBC staff must understand the adversary's intent, weapons capabilities, and weapons effects. The adversary may use weapons systems that range from artillery or rockets to theater ballistic missiles (TBMs). Delivery tactics could include overt or covert means (e.g., special operations forces [SOF]), state sponsored terrorism, or other asymmetric methods.

b. Providing Exposure Guidance. Exposure to NBC warfare agents or TIM may occur through inhalation, ingestion, skin contact, or other percutaneous exposure. Such exposure may have significant, immediate, or prolonged health effects. Therefore, the goal is to keep the exposure as low as reasonably achievable. The commander will ensure that military personnel, Department of Defense (DOD) essential civilians, contractors, and other essential personnel who support US military operations use appropriate protective equipment when operating near any detectable NBC agents or TIM, operating where agents are suspected, or participating in decontamination operations. Exposure to NBC agents or accidental release of TIM may adversely impact mission performance and result in disease or nonbattle injuries. As such, risk exposure must be assessed and integrated into overall military operational risk management. Typical scenarios for potential exposure to agents could include—

- Downwind hazard from the enemy’s attack.
- Collateral damage from the enemy’s NBC or TIM storage facilities or transportation systems.
- Vapor off-gassing from material or surfaces in previously contaminated areas.
- Contamination at unit locations from an enemy NBC attack.
- Contact hazard from an enemy NBC attack.

(1) The medical preventive medicine (PVNTMED) and NBC planners provide essential staff support to the commander on the hazard from TIM and NBC warfare agents. The PVNTMED planners carefully analyze the medical threat and evaluate the environmental and occupational health risks in the AO. The NBC planners assess the NBC threat. Both planners then coordinate with the unit’s intelligence section. After coordination, the NBC planners recommend protective actions to the commander.

(2) The exposure guidance furnished will depend on factors that include sensitivity of exposed individuals, the potential exposure durations, potential agent concentrations, and the potential combinations of agents to which individuals may be exposed.

(3) The sensitivity of individuals and the exposure duration affect the severity and characteristics of toxic effects that may be experienced by exposed individuals. A short exposure to an NBC agent or TIM may produce only minimal adverse effects, such as mild irritation, whereas longer exposure may produce more severe effects, which could interfere with mission function or result in death. The first indication of exposure to NBC agents or TIM will likely be noticeable symptoms.

(4) Exposure frequency and concentration are often critical factors in estimating the severity and onset of casualty-producing effects from exposure. Exposure frequency describes how often individual exposures have occurred during a specific time period. This is important because the human body does not detoxify agents in a timely manner.

(5) Additionally, increased physical workload in a deployed military population may actually increase the probability of occurrence and the severity of casualty-producing effects. Some factors, such as the breathing rate, increase as workload increases—leading to an increased intake of NBC agents or TIM.

c. Conducting Risk Assessments.

(1) Vulnerabilities should be examined through comprehensive risk assessments. Commanders have multiple means to contain, mitigate, and manage the consequences of identified risks. In order to preserve combat power and minimize casualties, commanders should—

- Identify potential health hazards.

- Assess the probability of adverse health effects to determine risks.
- Develop controls and make risk decisions.
- Implement controls.
- Supervise operations and evaluate the situation.

(2) When US, host nation (HN), or other civilian populations or infrastructures are at risk to an NBC attack, the commander assists the appropriate military and civil authorities to protect against, mitigate, and manage the consequences of these risks.

(3) Risk assessment also addresses the hazards posed by TIM, as well as negligible exposure to NBC agents, including radiological and other environmental contamination. Negligible levels are defined as below detectable levels of currently fielded chemical agent point detectors. Because standard military NBC individual protective equipment (IPE) does not always provide necessary protection, the assessment of the possible presence of TIM within the AO must be part of the IPB information collection process. Particular care must be taken in identifying the nature of such hazards. In some instances, avoiding the hazard may be the most effective or only course of action (COA). In all circumstances, the unit should act to minimize the immediate and long-term effects of toxic hazards to health by exposing the smallest number of personnel for the shortest period of time.

(4) Control measures can be taken to eliminate or minimize exposure over a wide range of actions. Example control measures could include representative measures such as—

- Ensuring predeployment vaccination and prophylaxis.
- Moving operations (e.g., relocating a base camp).
- Managing work schedules and limiting shift duration.
- Managing personnel rotation on high-risk missions.
- Monitoring and conducting surveillance of potential threat risks.
- Ensuring understanding and exercising of unmasking procedures.
- Briefing commanders and service personnel on potential threats and safe and appropriate responses.
- Enforcing the correct wear of uniforms.
- Enforcing health and hygiene standards.
- Isolating an operation by means of barriers or enclosures.

- Using pretreatments, prophylaxis, immunizations, and collective protective shelters (CPSs).
- Shielding a radiation source and/or using time and distance considerations.
- Conducting continuous medical surveillance and occupational and environmental health surveillance.
- Using mission-oriented protective posture (MOPP) gear.
- Monitoring weather conditions and considering the increase of protective levels for forces during periods of high threat and weather conditions that are favorable for the use of chemical and biological (CB) weapons.

d. Establishing Protection Requirements. Commanders direct the establishment of coordinated NBC protection requirements through the preparation of NBC defense plans. This kind of action is common across the various components and includes, but is not limited to, dispersing and networking available detectors, designating NBC warning and reporting requirements, implementing periodic sampling and analysis, and designating shelters for applicable personnel. Other NBC defense protection requirements may include—

(1) Ensuring interoperability among components exercising important mission tasks (e.g., warning and reporting).

(2) Implementing the NBC defense plan as part of an integrated exercise and adjusting plans as a result.

(3) Using input from the theater missile defense (TMD) warning system to ensure connectivity and the rapid dissemination of information.

(4) Validating existing reach-back capability with regard to key elements, such as sustaining the force's capability to operate in an NBC environment (e.g., resupply of NBC defense equipment and contracted logistics support [CLS] for critical, commercial, off-the-shelf [COTS] NBC defense equipment).

(5) Evacuating suspect NBC samples for laboratory analysis, as required.

(6) Testing the warning and reporting system to warn or dewarn selected units.

(7) Conducting waste-handling operations.

e. Conducting Protective Actions.

(1) Leaders and staffs implement protective actions by ensuring that such actions (e.g., directed MOPP level and dewatering) are integrated into standing operating procedures (SOPs), written and verbal orders, mission briefings, and staff estimates. The critical check for this step, with oversight, is to ensure that required actions (controls) are

converted into clear, simple execution orders. Implementing actions includes coordination and communication with agencies such as higher, adjacent, and subordinate units and those executing the mission.

(2) Leaders also understand the impact of implementing protective actions. Examples of implementation include—

- Conducting rehearsals and war-gaming possible COAs.
- Conducting local threat briefings.
- Conducting installation-specific NBC defense training for replacement personnel.
- Installing and maintaining communications links for military and key civilian organizations.
- Assessing personnel, operational, and logistics readiness.
- Carrying and maintaining IPE, prophylaxis, water, etc.

f. **Sustaining Protective Actions.** Leaders ensure that actions are taken to equip and train US military and emergency-essential civilian personnel. Leaders may have to plan for the protection of dependents and noncombatants, depending on the situation. Deployable personnel are fitted with appropriate IPE, to include the protective mask. Sustainment also ensures that adequate supplies (e.g., detection and decontamination kits, mask filters, and medical provisions) are available and that required maintenance is conducted.

g. **Providing Supervision and Evaluation.** During mission preparation and execution, leaders conduct risk assessments to continuously evaluate and assess risk levels that may yield lessons learned and/or identify new hazards. Leaders supervise mission rehearsal and execution to ensure that standards and controls are maintained. Techniques may include spot checks, inspections, situation reports (SITREPs) and brief backs, periodic monitoring to minimize any exposure to NBC agents or TIM, buddy checks for heat stress, and close supervision.

h. **Ensuring Warning and Dewarning of Personnel.** The NBC Warning and Reporting System (NBCWRS) provides the data and information to inform leaders of important information requirements. Key information requirements that can be derived from NBCWRS include—

- (1) Time and place of the attack.
- (2) Who and what was affected.
- (3) Impact of the attack.
- (4) Specific type and extent of the hazard.

(5) Type of weapons and/or munitions employed.

i. **Conducting Medical Surveillance.** Before and during deployment, service members are informed of significant health threats and corresponding medical prophylaxis, immunization, and other unit and individual countermeasures for the AO. Additionally, commanders ensure that deployment health surveillance and readiness documentation are conducted according to applicable medical directives. For example, the documentation may include data such as the names of personnel who were exposed, their location and time in the hazard area and the monitoring results. Further, commanders provide personnel with appropriate medical support and training, equipment, and supplies to implement unit and individual countermeasures. For example, predeployment anthrax vaccinations can provide increased force protection (FP). Once deployed, personnel are provided updates to health threats and countermeasures based on need and the situations encountered.

3. Planning

The armed forces of the US must be prepared to conduct prompt, sustained, and decisive operations, in NBC environments. An adversary's NBC capabilities can have an impact on a commander's objectives, plans, and supporting actions and, therefore, must be taken into account at the strategic, operational, and tactical levels. The planning process basically remains the same across the range of military operations, regardless of the level of war. Nevertheless, specific NBC defense protection considerations may vary considerably between strategic-, operational-, and tactical-level operations due to differences in the mission, available resources, and the size of the operational areas.

a. **Strategic-Level NBC Defense Protection Planning.** The strategic-level planning will address potential adversaries who might have NBC capabilities—such as global adversaries, regional adversaries, or nonstate actors. A number of these potential adversaries have, or could rapidly acquire, NBC weapons and other TIM. Other planning considerations include providing FP (e.g., minimum MOPP level) and exposure level guidance.

b. **Operational-Level NBC Protection Planning.** At the operational level, planning could concentrate on characteristics such as the capability of road, rail, air, and sea transportation networks to support the movement of adversary NBC weapons; zones of entry into and through the operational area and area of interest (AOI); the impact of large geographic features such as mountains, large forests, deserts, and archipelagos on NBC defense operations; and seasonal climatic effects on NBC weapons. Operational-level planning also further refines protection guidance and integrates the theater-wide warning and reporting system.

c. **Tactical-Level NBC Defense Protection Planning.** Tactical-level planning focuses on ensuring that commanders can accomplish their mission-essential tasks in NBC environments. At the tactical level, the size and location of the battlespace are influenced by the physical location of the adversary's land, air, naval, space, and other forces that could pose a direct threat to the security of friendly forces or the success of their mission. The extent to which the battlespace environment is analyzed at the tactical level is largely dependent on the mission and planning time. Tactical-level planning continues to address

risk management, protective actions, changing conditions, warning and dewatering of personnel, and medical surveillance.

4. Protecting the Force

Protecting the force consists of those actions taken to prevent or mitigate hostile actions against personnel, resources, facilities, and critical information. These actions conserve the force's fighting potential so that it can be decisively applied. In NBC environments, the commander must take into account a number of unique considerations that have a significant effect on FP. These include, but are not limited to, the commander's intent, training and leader development, psychological operations (PSYOP), force health protection, protective equipment, and operations security (OPSEC).

a. **Commander's Intent.** The commander conducts risk assessments and outlines what his unit must do to succeed with respect to the enemy, the terrain, and the desired end state. The intent outlines the key tasks that must be performed. Risk is stated in the commander's guidance and is addressed in all COAs. Overall, the risk assessment balances FP and mission accomplishment.

b. **Training and Leader Development.** Rigorous and realistic individual and joint unit training across the force ensures readiness to fight and win should an adversary employ NBC weapons. Training, exercises, professional military education, and leadership development programs should incorporate the principles for operations in NBC environments and include the realistic consideration of NBC weapons effects on sustained combat operations.

c. **Psychological Operations.** As a means to minimize the potential for, and mitigate the effects of, adversary NBC use, PSYOP can decrease an adversary's perception of the utility of NBC weapons, contribute to deterring their employment, and enhance efforts to reduce an adversary's domestic and international support.

d. **Force Health Protection.** Medical protection of the force against NBC threats involves integrated preventive, surveillance, and clinical programs. The commander's plans should include PVNTMED, joint medical surveillance, medical evacuation, and provisions for readily available treatments and supplies to counter the physical effects of NBC exposure.

e. **Protective Equipment.** Sufficient and appropriate equipment (e.g., protective masks) must be available to protect not only the uniformed force but also the essential supporting civilian workforces. Individual and unit training is required for proper sizing, use of, and care for individual and crew-served equipment. Mask fit validation is also conducted as part of this process.

f. **Operations Security.** In affecting an adversary's intelligence, information operations (IO) (including OPSEC) provide forces with a significant measure of protection by preventing an adversary from acquiring information necessary to successfully target forces and facilities. Deception, dispersion of forces, communications security (COMSEC), and effective use of terrain are examples of measures that complement OPSEC.

5. Preparedness

Varied and unpredictable challenges to US interests in the international security environment require adequate preparedness in peacetime to facilitate rapid transition to operations.

a. Preparedness in the US and Its Territories.

(1) Commanders of forces and facilities in the US assess threats and vulnerabilities that may compromise peacetime operations. A number of state and nonstate adversaries may choose early NBC employment against the US civilian population and infrastructures as well as military forces and facilities. Therefore, peacetime preparedness and planning for transition to operations account for the vulnerabilities that, if exploited by adversaries, could impede execution of mission-essential tasks.

(2) Peacetime planning, training, equipping, and supporting actions must include plans to understand threats, minimize vulnerability, and mitigate the effects of NBC attacks in order to maintain required force preparedness. Commanders coordinate with civilian authorities and agencies to prevent and, if necessary, mitigate and manage the consequences of deliberate or accidental NBC employment or similar toxic material events in the US. Detailed interagency processes guide the armed forces of the US in providing military support to civil agencies to cope with such events.

b. Preparedness in the Theater Operational Area. Peacetime preparedness for operations in NBC environments includes measures taken by commanders at intermediate staging bases or in theater operational areas abroad. Force requirements (including readiness and FP) in any particular combatant command area may require support not only from the US but also from other combatant commands.

c. Preparedness—Using all the Tools (NBC Information Management).

(1) Commanders require accurate and timely information (e.g., threat data) as they prepare for operations in an NBC environment. Decisions rely on SA and an understanding of the significance of the information (e.g., impact of degradation on the force). Units translate all source information into an understanding of the NBC threat and the operational environment. Commanders and staff conduct timely risk assessments and recommend specific COAs for reducing risk and countering specific threats. To maintain SA, units use information from sources such as the NBCWRS to report suspected and actual NBC attacks.

(2) Units obtain relevant data (see Figure I-1, [page I-10]) from multiple sources (e.g., sensors, detectors, and other reconnaissance and surveillance assets). The appropriate data (e.g., type of agent, time of detection, weather data, and location) is processed, extracted, formatted, and forwarded. Commanders and their staffs evaluate the information to assess its impact on operations. The risk assessment then may lead to directives/orders to help mitigate the impact of the assessed hazard. Commanders may direct an integrated series of protective measures (e.g., increased MOPP posture) to decrease the level of risk (e.g., decrease exposure opportunity), and the plan is revised as updated information is received.

(3) The command and staff conduct preplanning to determine critical data requirements. The relevant choices are prioritized as PIR and a data collection plan is prepared. The overall data collection effort shares common characteristics:

- Connectivity between lower, higher, and adjacent units.
- Ability to forward relevant data to multiple echelons of command simultaneously.
- Capability to conduct technical reach back to obtain access to strategic intelligence, operational, logistical, or technical information to provide information for operational assessments. Reach back provides the additional capability to enhance effective use of modeling and simulation to conduct region-specific, expert evaluation of potential NBC weapons effects as well as toxic industrial chemical, biological, and radiological releases.

(4) Units receive, process, and evaluate data received. The data may be incomplete; therefore, it is assessed and evaluated in light of information from other sources. The available data is synthesized to assess its operational significance. The evaluated information may result in no action being taken, or the information received may be translated into an input that affects the military decision-making process (MDMP).

(5) The evaluated information is used to support the MDMP. For example, the process could provide information to support hazard prediction and selected warnings to affected units.

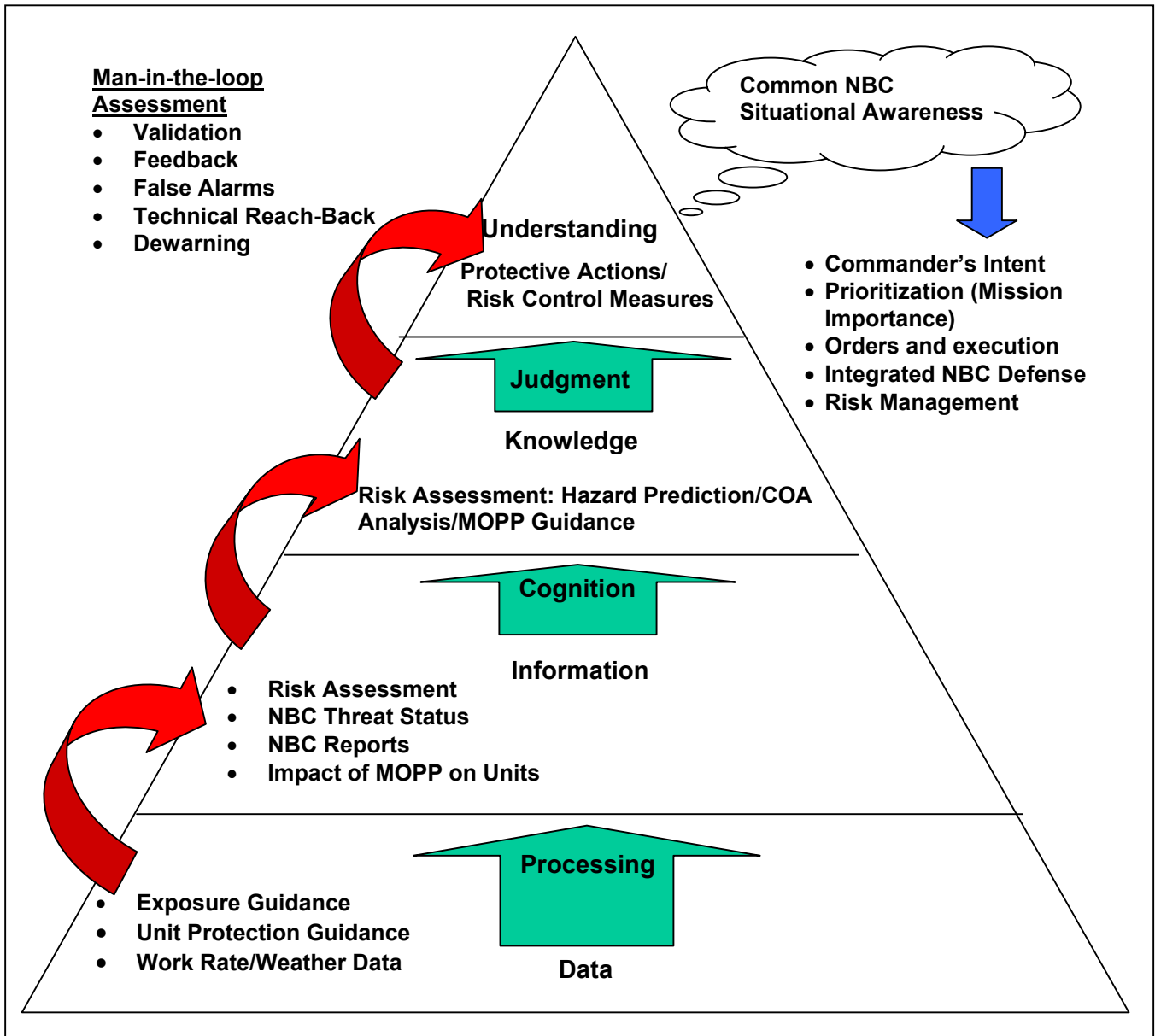

Figure I-1. NBC Information Management

d. Preparedness—Understanding the Environment. Commanders and staffs understand the impact of chemical, biological, radiological, and nuclear (CBRN) and/or the accidental or deliberate use of TIM on FP.

(1) Chemical weapons can be used to restrict the mobility of maneuver forces, contaminate air base (AB) or port operations, cause immediate and delayed casualties, and force an increase in protective measures. Persistent agents are typically used against deeper targets or those areas not expected to be immediately occupied.

(2) Biological weapons can be used to cause large numbers of casualties, and the area coverage for a biological warfare (BW) weapon can be far greater than for a chemical attack.

(3) Nuclear weapons can cause tremendous adverse blast, thermal energy, radioactive, and electromagnetic pulse (EMP) effects. The initial and residual effects of a nuclear weapon can cause large numbers of casualties, material damage, and contamination.

(4) Potential terrorist use of CBRN weapons also creates tremendous challenges for commanders. Potentially, a covert incident could occur at any time.

(5) TIM (through accidental or incidental release or terrorist actions) may also impact FP. A commander's situational awareness (SA) extends throughout the AO within which his forces will operate.

(6) The proliferation of TBM increases the range from which an adversary could strike.

(7) Secondary threats may also exist during and after some TBM attacks. TBMs may have warheads that do not separate from the missile body but remain together until the missile warhead functions or the missile impacts the ground. Even if the warhead functions or is hit with an antiballistic missile (ABM), the missile components continue on a ballistic trajectory and impact the ground. In addition to potential explosive or CB hazards, the missile may impact a building or create a crater. The impact site may contain hazards from the remaining missile fuel and oxidizer or from the facility or structure the missile hit (fuel, power lines, munitions, etc.). Personnel in MOPP4 are protected from potential CB hazards but may not be fully protected from the unused or unburned missile oxidizers and fuel hazards. Depending on the quantity remaining, the residual fuel and oxidizer (such as red, fuming nitric acid) present a potential toxic chemical hazard to personnel. These chemicals may also cause chemical detectors, such as M8 paper, to falsely indicate the presence of an agent or mask the presence of the actual agent.

6. Protection Components

NBC protection is a command responsibility and the commander must direct actions to ensure continued mission accomplishment. There are broad groups of activity that comprise protective measures, such as individual protection, reacting to an attack, COLPRO, and health service support (HSS).

a. Individual Protection. Individual protection includes actions taken by individuals to survive and sustain operations under NBC conditions.

(1) Background. The commander provides FP guidance in orders and/or directives. The establishment of protection guidance provides unit personnel and mission-essential civilian personnel with key information (e.g., individual protection guidance, training, equipment) to ensure that they are prepared (see Chapter VI and Appendix A for information and descriptions of individual protection and IPE capabilities, respectively).

(2) Preattack Protection Measures. These protection measures can include—

- Providing realistic, integrated training.
- Using camouflage, concealment, and deception (CCD). CCD measures cannot protect personnel from the effects of enemy attacks but can hide individuals and units from enemies threatening an NBC attack.
 - Being ready to prepare positions. Take actions to make positions more resistant to the blast effects of conventional or nuclear munitions; to the heat and radiation of nuclear weapons; and to the contamination from CBRN weapons.
- Conducting MOPP analysis (see Appendixes A, B, and C).
- Being ready to prepare personnel. Under the threat of enemy NBC attacks, leaders must ensure that individual and collective protection (see Appendix B) equipment is prepared and readily available.
- Remaining mobile.
- Being ready to take actions, such as placing equipment under overhead cover such as buildings or aircraft hangars.
- Covering supplies and equipment (e.g., use NBC protective covers).
- Monitoring unit radiation exposure (see Appendix D).

(3) MOPP. MOPP balances protection requirements and performance degradation with mission requirements. The commander has the responsibility for providing guidance for levels of protection. The higher the MOPP level, the more protection it provides, but the more it degrades performance. The leader's MOPP decisions are based on factors such as the threat, temperature, work rate, hydration requirements, and mission (see Chapter V).

(a) MOPP Analysis. Leaders—generally at shipboard, air operating base, and brigade/battalion level—establish protection levels based on a risk analysis (RA) of their unit's particular situation. The RA finds the balance between reducing the risk of casualties and accomplishing the mission.

(b) Specialized Protective Requirements. Individual protective requirements (see Appendix E) during TIM threat conditions—such as operations near damaged industrial resources or other military operations other than war (MOOTW) situations—may also require the use of other standard protection levels, such as those specified by the US Environmental Protection Agency Levels A through D (see applicable service references such as Field Manual [FM] 3-11.21 *Multiservice Tactics, Techniques, and Procedures for Nuclear, Biological, and Chemical Aspects of Consequence Management*).

b. Reacting to an Attack. Personnel take immediate action to reduce the impact of an NBC attack. Commanders determine the risk they are willing to take depending on the missions that must be accomplished. They take poststrike actions to restore fighting power

and prepare to continue the mission. Specific actions vary according to the type of attack (see Chapter II).

c. COLPRO. Collective NBC protection is that protection provided to a group of individuals in an NBC environment and complements the individual protection provided by MOPP gear. Under expected NBC contamination conditions, COLPRO is designed to provide a toxic-free work environment for personnel. Under TIM conditions, COLPRO may provide limited or uncertain protection for personnel. Alternatively, it may allow personnel to temporarily remove overgarments. When CPS are used to provide relief from wearing MOPP, commanders may establish a system for rotation of personnel (see Chapter VII and Appendix B for more information on COLPRO). When COLPRO is used in support of medical treatment facilities (MTF), commanders must ensure that contaminated patients are decontaminated before they are received in the COLPRO area.

d. HSS.

(1) NBC protection must include provisions for adequate HSS. Commanders are responsible for health maintenance of their personnel to ensure mission accomplishment in the event of NBC attacks. Planning and training actions must include health maintenance of the essential civilian workforce members supporting military operations as well as the integration of military capabilities with those of the local public health services, including those of the HN for operations abroad.

(2) Preparations for operations in potential NBC environments include preexposure immunizations, pretreatments, prophylaxis, and medical barrier materials (e.g., creams) applicable to the entire force—including multinational, interagency, and civilian participants. Postexposure measures require prior planning and include the continuation of preventive measures. In contaminated environments, commanders take action to ensure continued HSS capabilities, to include providing decontamination support and security from nonmedical resources.

Chapter II

PREATTACK, DURING-ATTACK, AND POSTATTACK PROTECTIVE ACTIONS

1. Background

This chapter addresses preattack, during-attack, and postattack actions that can be taken in the event of an NBC attack. Because operations in an NBC environment could also include TIM incidents, this chapter addresses suggested protective actions that could be taken in response to a TIM event.

2. Common Preattack Actions

Personnel take protective actions before an attack (preattack), during the attack, and following the attack (postattack). These actions are based on the type of attack and other factors.

a. There are many common preattack actions that can be taken to prepare for operations in an NBC environment. These actions could include—

(1) Designating Proposed Decontamination Sites. Commanders designate proposed decontamination sites utilizing mission, enemy, terrain and weather, troops and support available—time available (METT-T); water availability; trafficability; accessibility; and logistics supportability.

(2) Assessing NBC Threat, Potential Risk, Likelihood of Attack, and Vulnerability. Commanders must continuously monitor intelligence assessments, SITREPS, and other related information to prepare themselves to make an informed decision on whether or not to implement NBC defense measures upon notification of an attack. The vulnerability assessment (VA) also provides for identification of TIM storage, production, transit sites, and pipelines within an AO.

(3) Implementing Coordinated NBC Defense Plans. Commanders should direct implementation of the coordinated NBC defense plans developed for their unit. The kinds of actions to be implemented include, but are not limited to, dispersing available detectors, distributing IPE, and conducting training. The NBC defense plan may also include provision for processing of noncombatants in an NBC environment (see Appendix F).

(4) Preparing to Provide Primary Care for Unit Casualties. Unit commanders should have their personnel prepare contingency plans for first aid and transport of unit casualties.

(5) Determining and Implementing MOPP. Based on the situation, commanders should determine and implement the appropriate MOPP level and variation if appropriate.

Note: See Chapters V and VI and Appendixes A and C for more information that supports implementing appropriate MOPP levels.

(6) **Minimizing Skin Exposure.** Commanders should direct personnel to minimize skin exposure for protection against hazards (e.g., wearing shirt sleeves down and closing neck buttons). Although inhalation of an agent is a concern, many agents can enter the body by penetrating the skin or through skin cuts, cracks, or abrasions.

(7) **Continuing Good Hygiene Sanitation Methods.** Commanders should require their personnel to practice proper hygiene and sanitation methods at all times.

(8) **Deploying and Activating Detectors.** Each unit, as part of the NBC defense plan, should deploy available detectors.

(9) **Designating and Preparing Shelters.** The commander should direct and designate appropriate C² and rest and relief shelters. Protection from weapons effects, such as liquid and vapor contamination, blast, shrapnel, and heat, should determine the suitability of buildings as shelters.

Note: See Chapter VII and Appendix B for information on COLPRO and collective protective equipment (CPE), respectively.

(10) **Watching for Attack Indicators.** All personnel should be alert for signs of attack. Attack indicators support the IPB process through providing data from NBC reconnaissance measures. The NBC reconnaissance input can support confirmation or denial of possible adversary COAs.

(11) **Covering Unprotected, Mission-Essential Equipment.** Commanders should direct units to cover mission-essential equipment to prevent contamination from being deposited on the equipment. This will reduce the need for decontamination and minimize the possibility of personnel contaminating themselves if they have to handle the equipment at a later time.

(12) **Conducting Meteorological Monitoring.** Meteorology is an important factor on the impact of a CB aerosol release (whether overt or covert). If conditions for CB agent release are possible (e.g., threat indicators are present), commanders may direct search or surveillance activities or other NBC defense actions.

(13) **Integrating Available Alarm and Warning Systems.**

(a) **Alarm and Detector Systems.**

- **CBRN Capability.** CBRN agent alarms/detectors represent another common critical element for effective defense. Without them, a unit cannot be alerted and cannot detect contamination. Once in a high-threat area, alarms and/or detectors must be in use. The alternative is to have the units take protective measures (e.g., donning protective gear). This equipment provides units with the capability to detect CBRN agents.

- **Biological Capability.** The first signal that a unit has been exposed to a biological agent may occur when large numbers of personnel become sick. However, there are specialized biological point detectors that are available (e.g., USN Interim Biological Agent Detection System [IBADS], DOD biological handheld sampling kits, and USA Biological Integrated Detection System [BIDS]) for support of the air, land, and maritime components.

(b) **Warning Signals (Land Force and AB).** The basic types of attack warning signals are sound and visual. Personnel should warn others, using one or more of these signals. Personnel give the alarm as soon as an attack or a hazard is detected and use an alarm method that cannot be confused easily with other combat signals or sounds. All who hear or see the alarm must repeat it swiftly throughout their areas and supplement the warning with all available communications capability.

- **Vocal.** The spoken word is the first way of informing personnel of an NBC hazard or attack. The vocal alarm for any CB hazard or attack is the word *gas*. The person giving the alarm masks first and then shouts, “Gas!” as loudly as possible. Everyone hearing this alarm immediately masks and then repeats the alarm. The vocal alarm for the arrival of radiological contamination in a unit area is the word *fallout*. The first individual to detect the arrival of fallout will usually be a radiological monitor operating a radiac meter at the unit command post (CP). When the radiac meter records an increase in dose rate to 1 centigray per hour (cGyph) or higher (or other service-determined threshold), the monitor should immediately alert unit personnel.

- **Sound.** Sound signals reinforce the vocal alarm to warn of the imminent arrival or the presence of NBC hazards. Sound signals consist of a succession of short signals—such as the rapid and continuous beating on a metal object or anything that produces a loud noise. The warning could be made by a succession of short blasts on a vehicle horn or an interrupted warbling siren sound in situations where vocal alarms or the sound of beating on metal would be lost because of battlefield noise.

- **Visual.** Standard hand-and-arm signals may be used for NBC hazards. They consist of putting on the protective mask, extending both arms to the side horizontally with doubled fists facing up, and moving the fists rapidly up to the head and back down to the horizontal position.

- **Visual/Audiovisual.** If the automatic chemical agent alarms (ACAAs) are in operation, detected agents will trigger a visual and auditory alarm unit. The person who sees or hears an alarm signal from the alarm unit immediately masks and augments this signal with a vocal signal. Communications personnel who hear the vocal signal immediately mask and relay the signal over the unit communications nets. Personnel reinforce this signal with other sounds or visual signals.

(c) **Shipboard Alarms.** The shipboard interior communications general announcing system is integrated with a system of alarm signals such as the general and chemical alarm. The signals override the microphone control stations and are intended to notify the crew of imminent danger.

- **General Alarm.** The general alarm signal is sounded by the officer of the deck (OOD) to notify the crew of a battle condition. Some ships sound battle stations (material condition ZEBRA) by the use of a bugle or a boatswain pipe. Others simply pass the word, “Man your battle stations.” All hands will report to preassigned stations and set material condition ZEBRA.

- **Chemical Alarm.** The chemical alarm signal is sounded by the OOD, the damage control officer (DCO), or automatically by the shipboard chemical agent point detection system when there has been an attack on or in the vicinity of the ship. All hands exercise protective measures to reduce exposure and injuries.

(14) Designating proposed decontamination sites using METT-T, current weather data, water availability, trafficability, accessibility, and logistics support ability.

(15) Using Warning Signals for AB/Fixed Sites.

(a) **Standardized Warning Signals.** Commanders use standardized warning signals to prepare ABs or fixed sites for attacks, warn of attacks in progress, initiate postattack recovery actions, and return the installation to a normal wartime state of readiness. Table II-1 covers suggested warning signals and required actions for installations within the continental United States (CONUS) and in US territories. Table II-2 (page II-6) provides recommended standardized warning signals and required actions for overseas bases subject to attack.

Table II-1. Standardized Alarm Signals for the US and its Territories and Possessions (Recommended)

Warning Or Condition	Signal	Meaning	Required Actions
Attack	3- to 5-minute wavering tone on sirens or other device.	Attack is imminent, or in progress, or the arrival of nuclear fallout is imminent.	Proceed immediately to designated shelters or take other appropriate actions.
Warning	3 to 5 minutes of short blasts from horns, whistles, or other devices.		Listen for additional instructions.
Peacetime Emergency Warning	3- to 5-minute steady tone on sirens or long steady blasts on horns, whistles, or similar devices.	Peacetime disaster threat exists. Potential or confirmed hazard to public health, safety, or property.	Tune into local radio, television, or cable stations for emergency information. Listen to public address systems for additional instructions. Be prepared to evacuate, take immediate shelter, or take other appropriate protective actions.
All Clear	Declared verbally by local official agencies.	Emergency terminated.	Resume normal operations or initiate recovery, if applicable.

(b) Quick Communication. Warning signals quickly communicate the commanders' intentions; direct personnel and units to take preplanned, time-phased defense actions; or simply notify everyone to take cover. Signals used to initiate preplanned actions may be specific to one or more functional areas. Other actions, such as assuming predesignated MOPP conditions or seeking protective cover or shelter, may apply to most of the base or the fixed-site population. Although warning signals are primarily designed to provide air, missile, artillery, and ground attack warning, they may be used to warn of covert attacks with CB weapons.

(c) Alarm Conditions.

- Commanders declare alarm conditions to initiate passive defense actions in wartime. Unless local or theater requirements dictate otherwise, bases or fixed sites generally use the warning signals and alarm conditions listed in Table II-2 (page II-6). Alarm conditions, combined with supplemental instructions through the chain of command, are the most effective way to establish a defensive posture. When NBC threats are present, the commander can further direct options that could range from MOPP levels 0 to 4 and also use variations (e.g., mask only) to provide the minimum level of protection for the current mission and situation.

- Warning signals are used that are compatible with HN, local, or theater systems. The base or fixed site warning system must provide effective coverage for all areas. Warning signals are displayed as visual aids in all work centers and common use areas (such as billeting tents, post offices, latrines, dining facilities, recreation areas, etc.). Transient and new personnel are briefed on warning signals and protective actions.

- Commanders are authorized wide latitude in determining warning signals. This information may include changes in alarm color codes or audible signals to accommodate theater or HN requirements and supplemental information to respond to specific weapons or threats. Standard warning signals should be used to the greatest extent possible. Regardless of the signals used, commanders are responsible for disseminating the warning signals information to all assigned, attached, and transient personnel to ensure that they take correct defensive actions in response to the base warning signals.

Table II-2 Standardized Alarm Signals for OCONUS Bases and Stations Subject to Nuclear, Biological, and Chemical Attacks (Recommended)

Alarm Condition	If You:	This Indicates	General Actions
Green	Hear: Alarm "green" See: Green flag	Attack is not probable.	<ul style="list-style-type: none"> • Don MOPP0 or as directed.^{1,3} • Perform normal wartime operations. • Resume operations. • Continue recovery operations.
Yellow	Hear: Alarm "yellow" See: Yellow flag	Attack is probable in less than 30 minutes.	<ul style="list-style-type: none"> • Don MOPP2 or as directed.¹ • Protect and cover assets. • Go to protective shelters or seek the best protection with overhead cover.²
Red	Hear: Alarm "red", or a siren (wavering tone) See: Red flag	Attack by air or missile is imminent or in progress.	<ul style="list-style-type: none"> • Seek immediate protection with overhead cover.² • Don MOPP4 or as directed.¹ • Report observed attacks.
	Hear: Ground attack, or a bugle (call-to-arms) See: Red flag	Attack by ground force is imminent or in progress.	<ul style="list-style-type: none"> ▪ Take immediate cover.^{2,3} ▪ Don MOPP4 or as directed.¹ ▪ Defend self and position. ▪ Report activities.
Black	Hear: Alarm "black" or a siren (steady tone) See: Black flag	Attack is over. and NBC contamination and/or UXO hazards are suspected or present.	<ul style="list-style-type: none"> ▪ Don MOPP4 or as directed.^{1,3} ▪ Perform self-aid/buddy care. ▪ Remain under overhead cover or within shelter until directed otherwise.
<p>¹ Wear field gear and personal body armor (if issued) when outdoors or when directed.</p> <p>² Commanders may direct continuation of mission-essential tasks or functions at increased risk.</p> <p>³ This alarm condition may be applied to an entire installation or assigned to one or more defense sectors or zones.</p>			

(16) Analyzing Warning Time Assessments. Commanders analyze the potential attack warning process to identify limitation and deficiencies. Warning times will vary by threat and the real-time ability of both theater and installation warning systems to disseminate warning information. Analyze the warning system performance for each primary threat (missile, aircraft, ground, etc.). Use the analysis to develop a chain of events timeline that identifies each primary and secondary warning event from initial event detection through notification to the lowest unit level. These time lines enable the chain-of-command to develop and practice preplanned scenarios and quickly adjust strategies to react to attack situations. For example, installations may receive little (several minutes) or

no warning of missile or artillery attacks. However, aircraft, cruise missile, and remotely piloted vehicle attack warning times (due to different flight profiles) may be long enough (tens of minutes) to allow extensive preplanned actions. Regardless of the warning times, commanders and their staffs must quickly analyze the available attack information, evaluate the effect on current operations, and decide on the most effective COAs within the time available.

(17) Monitoring status of NBC Equipment and Supplies. Units assess the logistics supportability of each COA and determine what equipment and supplies (see Appendix G) are needed.

(18) Preparing for Contingencies. Units prepare for unexpected situations. The preparation could include handling instructions for weapons of mass destruction (WMD) threats using postal mail or packages (see Appendix H).

b. Specific preattack, during-attack, and postattack actions (unique to NBC, COLPRO, and TIM) are discussed in the following paragraphs.

3. Nuclear Protection

This paragraph discusses preattack, during-attack, and postattack aspects of protection that can be accomplished in the event of a nuclear attack. Personnel must make defensive preparations to protect themselves; the effective use of terrain and shelter is also very important. Additionally, a nuclear attack can also create EMP effects.

- By knowing how terrain affects nuclear weapons, personnel can greatly reduce the risk of becoming casualties. With training and practice, they can learn to recognize defensive positions that will give them optimum protection against a nuclear blast.

- Hills and Mountains. Reverse slopes of hills and mountains give some nuclear protection. Heat and light from the fireball of a nuclear blast and the initial radiation tend to be absorbed by hills and mountains. What is not absorbed deflects above the personnel because of the slope.

- Depressions and Obstructions. The use of gullies, ravines, ditches, natural depressions, fallen trees, and caves can reduce nuclear casualties. However, predicting the actual point of a nuclear attack is almost impossible. The best protection remains an area below ground with some sort of overhead cover.

- Obscuration. When the threat of nuclear weapons use is high, smoke can be used to attenuate the thermal energy effects from nuclear detonations.

a. Preattack Actions. Preattack actions are critical because they will increase the unit's survivability to the greatest possible extent. These actions range from selecting the right shelters, fortifying those shelters, and protecting vital equipment to using equipment to increase survivability. Whenever the tactical situation permits, units prepare defensive positions. These will vary from individual fighting positions to improved defensive positions. These actions and good prior planning protect against nuclear effects. One primary concern should be protection from gamma and neutron radiation. Gamma

radiation protection requires thick layers of dense or heavy shielding material, such as lead, iron, or stone. On the other hand, light, hydrogen-based material gives good neutron radiation protection. Some examples are water, paraffin, and oil.

Note: The balance of the information in paragraphs 2 through 4 applies to land forces. See NWP 3-20.31 (Revision A), *Surface Ship Survivability*, for TTP on maritime CBR defense measures.

Note: See Appendix D for more detailed information on radiological protection—such as operational exposure guide (OEG), low-level radiation (LLR) exposure, and depleted uranium (DU).

(1) Fighting Positions.

(a) Digging in provides improved defense, because earth is a good shielding material. A well-constructed fighting position gives excellent protection against initial nuclear effects. It can also reduce residual radiation (fallout). Personnel must harden their fighting positions against the blast wave as time permits. Lining or revetting fighting positions can significantly increase survivability and decrease the size of the opening into the position. Smaller openings allow entry of less initial and residual radiation. However, many metal surfaces are good thermal reflectors. Cover these surfaces to prevent an increased danger of burns from the heat of nuclear blasts.

(b) The smaller the fighting position opening, the better. Most of the gamma radiation in the bottom of a fighting position enters through the opening. The smaller opening of a one-person fighting position reduces gamma radiation two to four times below the amount that a two-person foxhole allows to enter.

(c) A deep fighting position gives more radiation protection than a shallow one. It places a greater thickness of shielding material or earth between the occupant and the nuclear detonation. Therefore, it prevents less initial radiation from entering. In a two-person fighting position, radiation reduces by a factor of 2 for each 16 inches of fighting position depth.

(d) Thermal radiation can reach personnel in fighting positions by line-of-sight (LOS) exposure or by reflection off the sides. Use dark, rough materials to cover potential reflecting surfaces and as protective covers. Examples are wool (such as blankets) and canvas. Remember that thermal exposure may still burn or char these materials. Avoid direct contact with them. Do not use rubber or plastic materials alone. These items might melt and cause burns. Simply covering a position with ordinary metal screening material blocks the thermal radiation by about 50 percent. Use this screening for thermal protection without entirely blocking the view through the ports. Personnel must cover exposed portions, and they must keep low. Keeping low reduces thermal exposure just as it reduces nuclear radiation exposure.

(2) Field-Expedient Overhead Cover.

(a) An overhead covering of earth or other material reduces exposure to thermal and initial nuclear radiation and fallout. Overhead covering helps prevent collapse. It also provides protection against debris, such as falling rocks.

(b) Beware of poorly constructed overhead covers. A cover must be strong enough to withstand the blast wave. Use U-shaped metal pickets, timbers, or certain fabrics; and overlay them with sandbags or earth. Ammunition boxes filled with earth also make good cover. In constructing an effective overhead cover, remember the following:

- Choose dense covering materials.
- Cover in depth.
- Provide strong supports.
- Cover as much of the opening as possible.

(c) A vehicle provides expedient overhead cover. A simple and fast method is to drive a vehicle over the top of a fighting position. A heavy armored vehicle is better than a wheeled vehicle. As with any type of overhead cover, initial radiation can still enter the fighting position through the earth sides or the openings in the sides of the vehicle (between treads, road wheels, and tires). If time allows, use sandbags to cover these openings. Remember, the vehicle is not a good neutron shield. Also, the blast wave may violently displace the vehicle and collapse a fighting position.

(3) Earth-Shielded Positions.

(a) Well-constructed fighting positions and bunkers can provide excellent protection against all effects of a nuclear detonation. Radiation is still an important concern, though, because of its great penetrating power. Radiation scatters in all directions after a blast.

(b) It is important that as much earth cover as possible be placed between the individual and the blast. The more earth cover, the better the shielding. Table II-3 (page II-10) illustrates the value of increasing amounts of earth shielding from a hypothetical, free-in-air dose. An open fighting position gives a protection factor of 8. It blocks most of the LOS radiation and allows only a fraction of scattered radiation to enter. Each added 6-inch thickness of overhead earth cover reduces the scattered radiation by a factor of 2.

Table II-3. Shielding Values of Each Cover for a 2,400-Centigray, Free-In-Air Dose

Personnel In	Radiation Protection Factor	Resultant Dose cGy
Open	None	2,400
Open Fighting Position (4" Earth Cover)	8	300
Open Fighting Position (6" Earth Cover)	12	200
Open Fighting Position (12" Earth Cover)	24	100
Open Fighting Position (18" Earth Cover)	48	50
Open Fighting Position (24" Earth Cover)	96	25

(c) The flat earth cover of an underground shelter protects much better than an equivalent thickness of cover on a similar aboveground structure. This is because the underground LOS thickness is greater.

(d) A second layer of sandbags gives more protection to fighting positions. Each layer of sandbags, if filled with sand or compacted clay, reduces the transmitted radiation by a factor of 2. Table II-4 shows the advantage of adding layers of sandbags for a hypothetical, free-in-air dose of 2,400 centigray (cGy).

Table II-4. Shielding Values of Each Cover for a 2,400-Centigray, Sand or Clay-Filled Sandbags, Free-In-Air Dose

Personnel In	Radiation Protection Factor	Resultant Dose cGy
Open	None	2,400
Open Fighting Position, 4' Deep	8	300
Open Fighting Position, 4' Deep, 1 Layer (4 Inches)	16	150
Open Fighting Position, 4' Deep, 2 Layers (8 Inches)	32	75
Open Fighting Position, 18' Deep, 3 Layers (12 Inches)	64	38

(e) Sand or compacted clay gives better radiation shielding than earth because it is denser. Each layer of sand- or clay-filled sandbags can give up to 66 percent more radiation protection than the same thickness of soil or soil-filled sandbags. Table II-4 shows that three layers of sand or clay-filled sandbags give a protection factor of 64 (38 cGy). Generally, heavy sandbags protect better than light ones.

(f) Neutron radiation can be stopped. Water delays and absorbs neutrons, but since some gamma radiation is given off in the process, dense shielding is still required. Damp earth or concrete protects from both forms of radiation. For example, only 12 inches

of concrete or 24 inches of damp earth reduce neutron radiation exposure by a factor of 10. Wet sandbags achieve a reduction factor of 2 for every 4-inch layer. Other expedient neutron-shielding materials include containers of water, fuel, or oil. Remember that radiation scatters in all directions, and shielding must provide all-around protection.

(g) Protect sandbags from exposure to thermal radiation. Sandbags can burn and spill their contents, which can then be moved more easily by the blast wave. Cover sandbags with a small amount of earth and/or sod to eliminate this problem. Covering sandbags also enhances camouflage and provides valuable fragmentation protection.

(4) Buildings.

(a) Certain types of buildings offer excellent shelter from nuclear hazards and require minimum of time and effort to adapt for use. Choose buildings carefully. The stronger the structure, the better the protection against blast effects. The strongest are heavily framed buildings of steel and reinforced concrete. The worst choices are shed-type industrial buildings with light frames and long beam spans. Even well-constructed frame houses are stronger than the latter. Ammunition storage bunkers also give exceptional protection. These are usually large enough for most vehicles and equipment.

(b) Many European, rural and urban structures can provide good protection. Many types of pre-World War II European buildings provide good blast and radiation protection. Examples are farmhouses, churches, and municipal buildings. Characteristics to look for include the following:

- Pre-World War II buildings. These have thick, full-span floor and ceiling beams; heavy roofing tiles; dense, reinforced walls; and, in most cases, a full basement.
- Full basements constructed of concrete or stone. Make sure that there is an exit directly to the outside as well as through the upper floors in case of emergency.
- Thick-walled masonry structures.
- Buildings with very little glass. European windows are typically protected by roll-up or folding shutters. These coverings provide some additional blast and thermal protection.

(c) A shielded building is best. Exterior rows of buildings in closely arranged groups (towns) shield buildings in the interior. These shielded structures suffer less blast overpressure and structural damage than exposed structures. However, debris and rubble problems and fire hazards may increase toward the center of town. Commanders should consider using shelters located two or three building rows from the edge of town to avoid serious hindrance to postattack mobility.

(d) Personnel should move below ground level. The basement, because it is below ground, provides increased blast protection and much more LOS radiation

protection than aboveground floors. This additional protection results from the surrounding earth fill. Add additional radiation protection by placing a layer of earth or sandbags on the floor above. This additional deadweight will be significant and may require shoring up the floor. Alternately, more protection can be gained by sandbagging a smaller shelter in the basement (such as a sturdy table) without increasing the possibility of the entire floor collapsing. Block windows with sandbags and enhance the radiation protection and structural strength of any aboveground exterior walls by piling dirt and sandbags against the walls. Generally speaking, personnel can reduce radiation by a factor of 10 in basements as compared to levels in aboveground floors.

(e) Positions inside the building can make a difference if sufficient time is available to properly prepare them. On floors aboveground, the center of the building offers the greatest protection from both initial and residual radiation. Belowground, the corners of the building give the greatest protection. In either case, the dose to prone personnel would be about one-half the dose to a standing individual. The lesson here is to seek shelter in an underground structure and lie in a corner. If an underground shelter is not available, lie in the center of a shelter under a sturdy table. Other options include lying inside a fireplace, under a stairway, or in a bathroom where the plumbing and relatively close spacing of walls might provide increased structural strength.

(5) Tents. Tents are not a preferred shelter against the effects of nuclear weapons. A tent does provide some protection from residual nuclear effects (e.g., particulate fallout).

(6) Armored Vehicles. Armored vehicles provide good nuclear protection. In most situations, tanks offer the best vehicular protection available. Lightly armored vehicles also offer good protection. These vehicles include infantry fighting vehicles (IFVs), self-propelled artillery, and some heavy engineer equipment. If time is available, this protection can be improved with any of the following actions:

(a) Keep as low as possible inside an armored vehicle. Crew members normally elevated in a tank turret should get on the floor of the armored vehicle. This applies to the tank commander, gunner, and loader. Assuming such a low position reduces the radiation received by a factor of 4.

(b) Keep all hatches shut. Obviously, an open hatch will expose the crew unnecessarily to explosion effects. It could subsequently allow the entry of fallout particles and scattered gamma radiation. Close any other openings, such as the main gun breech.

(c) Prevent injury while inside an armored vehicle. The blast wave will throw personnel violently about inside an armored vehicle. Wear a helmet with the chinstrap secured to help prevent head injuries.

(d) Secure all loose equipment inside the vehicle. The force of the blast can throw about unsecured, loose equipment (such as tools, weapons, and helmets) inside the vehicle and cause injury or death to personnel.

(e) Dig-in armored vehicles (hull defilade) or place them in trenches or cuts in roadways. This provides some limited LOS radiation protection and considerable

blast protection. A hull defilade fighting position or a trench that allows half of the vehicle sides to be covered can reduce gamma radiation by as much as a factor of 2.

(f) Use sandbags as radiation shielding. A single layer of sandbags placed on top of a tank turret or an armored vehicle hull provides valuable overhead gamma shielding. Each layer of sandbags reduces the gamma radiation by a factor of 2. Wetting the sandbags enhances the neutron radiation shielding and protects the sandbags from thermal damage.

(7) Wheeled Vehicles.

(a) Avoid using wheeled vehicles as shelter. Generally, wheeled vehicles provide little or no protection from the effects of nuclear explosions. Worse still, they are particularly vulnerable to overturning. This exposes drivers and passengers to increased risks.

(b) Ensure that personnel protect themselves as much as possible inside the vehicles.

(c) Secure all loose equipment inside the vehicles.

(d) Plan for and prepare adequate field shelters immediately adjacent to facilities that require personnel to continue operations in wheeled vehicles. Parking the vehicle inside or under a shelter gives some protection to the personnel inside. Existing or natural structures—such as ammunition bunkers, underpasses, tunnels, and caves—are in this category.

(8) Aircraft Ground Operations.

(a) Revetments give little protection against blast overpressure. However, revetments and barricades protect aircraft from damage by dynamic wind. These also protect aircraft from other hazards—such as the impact of rocks, sand, and other aircraft or aircraft debris. The tactical situation may require revetting for protection from conventional weapons blast and fragmentation damage. Use overhead cover for aircraft if it is available. Close doors and windows against damaging overpressure.

(b) Tie-downs can reduce damage from tumbling of the aircraft. Generally, tie-downs do not produce excessive stress on tie-down points. Aircraft plexiglass windows shatter into fragments. This can happen at low-blast overpressure (1.5 pounds per square inch [psi]) when there is no other significant damage. Tape the edges and the centers of windows. This reduces the extent of fragmentation and the nuisance that fragments may cause to cockpit operations.

(9) Electromagnetic Equipment. When enough warning has been given, commanders must ensure that electronic equipment, such as radios and computers, are turned off and protected. EMP is the high-energy, short-duration pulse (similar in some respects to a bolt of lightning) generated by a nuclear detonation. It can induce a current in any electrical conductor and temporarily disrupt or overload and damage components of improperly protected or unprotected electronic equipment.

b. During-Attack Actions. Nuclear attack indicators are unmistakable. The bright flash, enormous explosion, high winds, and mushroom-shaped cloud clearly indicate a nuclear attack. An enemy attack would normally come without warning. Initial actions must, therefore, be automatic and instinctive.

(1) An attack occurring without warning is immediately noticeable. The first indication will be very intense light. Heat and initial radiation come with the light, and the blast follows within seconds. Time needed to take protective action will be minimal. If exposed when a detonation occurs, personnel should do the following:

- Drop facedown immediately with feet facing the blast. This will lessen the possibility of heat/blast injuries to the head, face, and neck. A log, a large rock, or any depression in the earth's surface provides some protection.

- Close eyes.

- Protect exposed skin from heat by putting hands and arms under or near the body and keeping the helmet on.

- Remain facedown until the blast wave passes and debris stops falling.

(2) Personnel should stay calm, check for injury, check weapons and equipment for damage, and prepare to continue the mission. Personnel in fighting positions can take additional precautions. The fighting position puts more earth between personnel and the potential source of radiation. They can curl up on one side, but the best position is on the back with knees drawn up to the chest. This position may seem vulnerable, but the arms and legs are more radiation-resistant and will protect the head and trunk. Personnel can also seek other forms of overhead protection (if available) within a fighting position/shelter in case the overhead cover/roof collapses. Store bulky equipment, such as packs or radios, in adjacent pits if they prevent personnel from keeping low in their positions, or place these items over the face and hands for additional radiation and blast protection.

(3) Personnel inside shelters should take protective actions. A blast wave can enter the shelter with great force, and the debris it carries can cause injuries. Lying facedown on the floor of the shelter offers protection. However, avoid the violent flow of air from doors or windows. Lying near a wall is safer than standing away from a wall. Constructing baffles or turns in shelter entrances can prevent overpressure buildups and the entry of dust and debris.

c. Postattack Actions. Protection must not stop when the attack ends. Immediately after an attack, postattack recovery begins.

(1) Personnel must check for radioactive contamination and, then, must reduce the hazard with basic decontamination. Decontamination techniques to reduce radioactive contamination are to brush, scrape, or flush radiological contamination from surfaces.

(2) As a minimum, unit personnel cover positions and shelters, and radiac meter operators begin continuous monitoring. IPE reduces the amount of contaminants that can enter the lungs and the potential for skin burns from beta and alpha particles.

(3) For the commander, poststrike actions include damage assessment and the restoration of combat power.

(4) Commanders and NBC personnel must also monitor schedules for pieces of NBC equipment having filters. Exchange is based on service equipment directives or when the following conditions are applicable:

- Physical damage occurs.
- Filters have become waterlogged or wet.
- High resistance to airflow is observed.
- Directed to exchange filters by higher HQ.
- Listed as unserviceable in applicable directives.

d. Nuclear Casualties. Blast, thermal radiation, and nuclear radiation all cause nuclear casualties. Except for radiation casualties, treat nuclear casualties the same as conventional casualties. Wounds caused by blast are similar to other combat wounds. Thermal burns are treated as any other type of burn. First aid cannot help radiation casualties. These casualties must be referred to medical facilities.

4. Biological Protection

This section discusses preattack, during-attack, and postattack aspects of protective actions that must be accomplished in the event of a biological attack. Protection against biological agents begins long before the actual attack happens. Biological agents can enter the body through the skin, respiratory tract, and digestive tract. Key preparations begin with personal health maintenance followed by NBC defensive training, which all personnel must master.

a. Biological Agents. Biological agents can be classified according to their biological type, operational effects, and physiological action. Operationally, biological agents are best thought of as either pathogens or toxins.

- Pathogens. Pathogens are living organisms. As such, they require certain conditions of temperature, humidity, protection from sunlight, and a susceptible host population. The biological agent must overcome a host's natural defenses (during a latent period) in order to cause illness. The duration period of this incubation could last from hours to days. Pathogens can be disseminated in wet or dry form or by vectors (e.g., mosquitoes). Additionally, some pathogens are contagious and can be spread from individual to individual; therefore, personnel not in the initial area of attack could become casualties. Following a large-scale dissemination of a biological agent, an initial disease outbreak of epidemic proportions might occur.

- Toxins. Toxins are poisons naturally produced through the activities of living organisms. Some toxins can now be artificially synthesized (e.g., powder form) and disseminated in liquid or dry form. Generally, toxins do not cause immediate casualty-

producing effects, and any casualties will arise hours to days after exposure. Unlike pathogens, toxins are not contagious (e.g., one person cannot infect another).

(1) Duration of effectiveness. The effectiveness duration of a biological agent depends on the characteristics of the agent, environmental factors, and any residual hazards. Solar (ultraviolet) radiation, relative humidity, wind speed, and temperature gradient are some of the most important weather factors in determining the effectiveness duration. As previously mentioned, biological agents can be disseminated as aerosols, liquid droplets, or dry powders.

(2) Cause of Casualty-Producing Effects. The primary cause of biological-agent, casualty-producing effects is through inhalation of an aerosol containing particles. Additionally, casualties can also be caused by the percutaneous effects of agents such as mycotoxins. Weather conditions have a tremendous impact on the employment of biological agents. Pathogenic agents will generally dissipate and decay in the presence of ultraviolet radiation. Some of the agent-containing particles (e.g., spores) disseminated as an aerosol, may settle out of suspension onto the ground; however, the impact of any residual hazard from reaerosolization of spores, such as anthrax, may present a hazard for personnel operating in a contaminated area for extended periods of time.

(3) Protective Measures. Protective measures include the use of IPE (e.g., a well-fitted mask), good hygiene, proper sanitation, and up-to-date immunizations. An individual's IPE provides protection against BW agents; however, based on the delayed casualty-producing effects of BW agents, personnel will not likely know an attack has occurred. See applicable service publications for information on the prevention and treatment of biological-agent casualties.

b. Preattack Actions. Preparations before an attack can be accomplished long before a biological attack happens. Personal health maintenance and realistic training are just two ways in which commanders can minimize their biological casualties. All personnel and leaders must adhere to the basic principles of good health; this applies especially under NBC conditions.

(1) Up-to-Date Immunizations. Immunizations reduce the chances of becoming biological casualties. Proper immunizations protect against many known disease-producing biological agents. All personnel should receive basic immunizations. Medical personnel will periodically screen these records and keep them up to date. If units deploy to areas in which specific diseases are prevalent, readiness preparation may include providing additional immunizations for needed protection. This prophylactic inoculation should be part of the IPB process and should be brought to the commander's attention.

(2) Good Hygiene. Protect against the spread of disease by practicing good health habits. The best defense against biological agents is good personal hygiene, keeping the body as clean as possible. This means not only washing the face and hands, but all parts of the body—particularly the feet and exposed skin. Hands need to be cleaned before meals or anytime bare hands are used to help ingest food and liquid or when smoking. Shaving may seem unimportant in the field, but it is required to achieve a proper seal of the mask. This is important because biological agents are usually most effective when received via the respiratory system or the skin. Small nicks, scratches, and cuts are

unavoidable in a field situation. Pathogens, either naturally occurring or intentionally employed as biological agents, enter these breaks in the skin and will cause infections if left untreated. Personnel should clean any breaks in skin with soap and water followed by first aid treatment.

(3) **Area Sanitation.** Another way to stop the spread of disease is to keep the area clean. Bury all empty ration packets and residue. Locate, construct, and use field sanitation facilities properly. Latrine facilities should include soap and water for hand washing. Latrines need to be cleaned daily. Avoid leaving such facilities open, and make sure that they are properly filled and marked before moving to help prevent accidental digging in the areas. Control of insects and rodents is also essential in preventing the spread of disease. Additional information on field sanitation can be found in service preventive-medicine (PVNTMED) publications.

(4) **Physical Conditioning.** Good physical condition requires maintaining the body in a well-rested, well-fed, and healthy state. Personnel should get as much exercise and rest as the situation permits, and they must remember to eat properly. If they stay healthy, their bodies will be better able to fight off germs. A high level of physical fitness also reduces the likelihood of heat stress when MOPP gear is worn for extended periods. Continuous operations will require that personnel learn to sleep in short naps and in MOPP4. This is also part of the conditioning process. It may also become necessary to eat smaller portions and at more frequent intervals.

(5) **DOD Insect Repellent System.** Proper implementation of the DOD Insect Repellent System will provide protection from those insects and ticks that may be used as biological agent vectors.

(6) **NBC Training.** Training in an NBC environment is integrated into all areas of unit training—individual and collective. Personnel learn, practice, and train to perform individual NBC survival tasks. Leaders are directly responsible for reinforcing these tasks through continuous training, thereby instilling individual confidence.

c. **During-Attack Actions.** If threat forces attack with biological agents, there may be little or no warning. This will depend on the IPB assessment. Units automatically assume MOPP4 to protect themselves against contamination when there are high-probability indicators of an attack.

(1) **Biological-Attack Indicators.** Biological agents may be disseminated as aerosols, liquid droplets, or dry powder. Attacks with biological agents can be very subtle or direct, if favorable weather conditions prevail. In nearly all circumstances, an individual will not know a biological attack has occurred. Symptoms can appear from minutes to days after an attack has occurred. Indicators may include—

- Mysterious illness (many individuals sick for unknown reasons).
- Large numbers of vectors, such as insects or unusual insects.
- Large numbers of dead or strange-acting (wild and domestic) animals.

- Mass casualties with flu-like symptoms—fever, sore throat, skin rash, mental abnormalities, pneumonia, diarrhea, dysentery, hemorrhaging, or jaundice.

- Artillery shells with less powerful explosions than high-explosive (HE) rounds.

- Aerial bombs that pop rather than explode.
- Mist or fog sprayed by aircraft or aerosol generators.
- Unexploded bomblets found in the area.

(2) Immediate Actions. Assuming MOPP provides protection against biological agents. However, an agent can gain entry through openings such as buttonholes; zipped areas; stitching; poor sealing at ankles, wrists, and neck; or through minute pores in the clothing fabric. Some toxins, however, require the same amount of protection as chemical agents. Since no wide-scale immediate-warning, biological-agent detection device is fielded, consider any unknown agent cloud as a sign of a biological attack and take the same actions prescribed for a chemical attack. For COLPRO, personnel must be housed inside a shelter with an efficient air filter system. Many buildings may be converted into temporary shelters if cracks are carefully sealed and a CB filter system with a ventilating mechanism is installed.

d. Postattack Actions. Actions after a biological attack include submitting NBC reports, beginning post attack recovery, and other actions—such as taking samples, identifying casualties by the symptoms they exhibit, and treating those symptoms. Early recognition of symptoms and treatment is essential in trying to limit the effects. Additionally, personnel should decontaminate immediately after an attack by using decontamination kits or washing with soap and water.

Note: Postexposure chemoprophylaxis is essential for preventing anthrax. See FM 8-284, *Treatment of Biological Warfare Agent Casualties*, for details.

(1) Agent Exposure. It is necessary to isolate individuals showing symptoms of contagious disease. This isolation helps prevent possible spread to others if the disease is communicable. Treatment of biological-agent casualties requires medical assistance as soon as possible. Further, symptoms associated with some toxins mimic other illness or chemical-casualty symptoms. Agent symptoms may include—

- Dizziness, mental confusion, or double or blurred vision.
- Skin tingling, numbness, paralysis, or convulsions.
- Formation of rashes or blisters.
- Coughing.
- Fever, aching muscles, fatigue, and difficulty in swallowing.
- Nausea, vomiting, and/or diarrhea.

- Bleeding from body openings or blood in urine, stool, or sputum (spit).
- Shock (symptoms appear in minutes or hours after the toxin attack).

(2) **Unmasking Procedures.** Unless prior warning is received from higher HQ to mask in advance of the arrival of a biological attack, units will likely not be aware that they have been exposed to a biological agent. However, if a unit has received prior warning of an advancing cloud, there are procedures that can be implemented. For example, a biological agent point detector can indicate (through its air-monitoring capability) when an aerosol cloud has passed the point detector. Once that occurs, units use devices, such as hand-held assays, to conduct testing to determine if positive test results are received. The report information is passed to the NBC center (NBCC). The commander, with the advice from the intelligence officer/noncommissioned officer (NCO), NBC officer/NCO, and the command surgeon considers this data as well as data from other sources (e.g., weather, time of day, threat, etc). Based on the multiple sources of data, the commander considers whether to reduce protective levels.

(3) **Filter Exchange.** When assessing filter exchange criteria several factors must be considered. Exchange criteria for filters is based on service equipment directives or when the following conditions are applicable:

- Physical damage occurs.
- Filters have become waterlogged or wet.
- High resistance to airflow is observed.
- Directed to exchange filters by higher HQ.

5. Chemical Protection

This paragraph discusses preattack, during-attack, and postattack aspects of protection that must be accomplished in the event of a chemical attack. Protection against chemical agents begins before an attack. Chemical agents can enter the body through the skin, eyes, ingestion, and respiratory tract. Leaders conduct defensive planning against possible chemical-agent attack. Units prepare SOPs that specify their chemical defense techniques and procedures.

a. Background.

(1) Chemical agents having military significance are categorized as nerve, blister, blood, incapacitating, or choking agents. These chemical agents kill, seriously injure, or incapacitate unprotected personnel. Chemical agents are classified according to their physical states, physiological actions, and uses. The terms “persistent” and “nonpersistent” describe the duration of chemical agents remaining in a targeted area.

(2) Agents may exist as vapors, solids, liquids, or gases (depending on the temperature); and they may cause casualties in multiple physical states. For example, an agent may be disseminated as a liquid casualty hazard from a delivery vehicle, yet remain a

vapor hazard if the agent has high volatility or off-gases from a porous surface during high temperatures. To a certain extent, the state in which an agent exists determines its use, fate, and effects.

(3) Personnel can be exposed to chemical warfare (CW) agents through breathing (inhalation), the skin, and the eyes. The casualty-producing effects of chemical agents can occur within seconds, minutes, or hours. For example, nerve agents are quick-acting and can cause casualty-producing effects within minutes. Alternatively, blister agents can take hours to cause their casualty-producing effects. Drink and food contaminated by CW agents are also harmful. Other means of exposure are breaching of the full-protective ensemble (e.g., from a tear caused by a munitions fragment) and/or transfer from a contaminated surface during processing through a contamination control area (CCA).

(4) Personnel could potentially come into contact with casualty-producing liquid agents prior to the agents absorbing into a nonporous surface. Alternatively, once a liquid agent absorbs into a porous surface, such as concrete (e.g., during cool evening temperatures), the agent may off-gas as a vapor during higher daytime temperatures and also cause chemical-agent symptoms among exposed personnel. Furthermore, there are other possible situations wherein casualty-producing effects of chemical agents can be impacted by temperature and type of surface (for example, during cold weather, chemical agent droplets are absorbed by an individual's protective clothing, the agent off-gases during the person's entry into a shelter for warming, causing the individual to exhibit chemical agent signs and symptoms).

(5) Solid and liquid agents may provide an operational hazard for hours, days, or months depending on the agent, weather conditions, and other factors.

b. Preattack Actions.

- (1) Assess chemical threat, potential risk, and likelihood of attack.
- (2) Implement coordinated chemical defense plan.
- (3) Prepare to provide first aid for unit personnel.
- (4) Determine and implement appropriate MOPP levels.
- (5) Minimize skin exposure.
- (6) Continue good hygiene and sanitation methods.
- (7) Deploy and activate detectors.
- (8) Designate and prepare shelters.
- (9) Watch for attack indicators (e.g., a chemical cloud, a distinctive odor, and release of an agent).
- (10) Cover unprotected mission-essential equipment.

c. During-Attack Actions.

(1) Give Attack Warnings. Detection and warning of the attack are critical to the implementation of protective measures. The warning signal for the attack directs personnel to take cover and use protective measures.

(2) Take Cover. Taking cover protects personnel against blast, shrapnel, heat, liquid, and particulate contamination. After taking cover, personnel don their masks and other protective gear, as appropriate.

(3) Use MOPP4. All personnel should assume MOPP4 (full IPE) in the absence of any other information and remain in MOPP4 until directed to reduce their MOPP level. The use of the MOPP ensemble could also be supplemented by the use of protective clothing—such as wet-weather clothing; an air crewman's cape; or the suit, contamination avoidance, and liquid protective (SCALP). (See Appendix A for more information on these items of IPE.)

d. Postattack Actions.

(1) Begin post attack recovery. If an adversary uses an air-bursting chemical munition, mission permitting, personnel will avoid outside activities to the maximum extent possible after an attack during the chemical droplet fall phase. Additionally, the chemical droplet fall phase could last up to approximately 60 minutes. The length of time depends on factors such as meteorological data and the weapon's height of burst. Outside activities could result in erroneous initial reconnaissance results and unnecessarily contaminated personnel and equipment.

(2) Avoid potentially contaminated surfaces/areas. All personnel should minimize contact with potentially contaminated surfaces until there are indications that surface contamination is no longer a hazard.

(3) Obtain and report observations or evidence of an attack. Personnel provide reconnaissance and assessment information for all types of damage, hazards, and chemical agents.

(4) Survey, control, and mitigate health hazards (treat and evaluate casualties). The HSS provides treatment for casualties according to established medical protocols.

(5) Adjust MOPP. Commanders should adjust MOPP to the lowest possible level consistent with identified hazards.

(6) Document exposure. Medical staffs should clearly document exposure in the medical records of those personnel who have been exposed.

(7) Sample, monitor, and analyze for residual hazard. Once the situation permits, the detection efforts determine the extent and duration of the residual hazards.

(8) Plan and implement decontamination and contamination containment actions. These actions are planned and implemented to minimize the operational impacts of contamination.

(9) Conduct unmasking procedures (all-clear). Commanders should revert to an appropriate MOPP level based on the current threat in conjunction with the all-clear signal. Personnel engaged in passive-defense functions should repair and resupply defense equipment in preparation for follow-on attacks. All personnel should return their IPE to a ready status in anticipation of the next attack warning.

(a) Selective Unmasking. Selective unmasking is an operational precautionary procedure used to support mask removal decisions. The unmasking process acknowledges detector limitations and requires one or more individuals to unmask for brief periods while others observe them for agent effects. Do not perform selective unmasking if agent detectors continue to detect an agent within the area or structure. Also recognize that the recommended unmasking methodology should meet personnel safety requirements and that accomplishing unmasking procedures does not guarantee the absence of low-level exposure.

(b) Unmasking Procedures Using the M256-Series Chemical Detector Kit. An M256-series chemical detector kit does not detect all agents. Therefore, consider also using unmasking procedures listed below in subparagraph (c), even if the detector is available. These procedures take approximately 15 minutes. After all tests with the kit, including a check for liquid contamination, have been performed and the results are negative, the senior person should select one or two individuals to start the unmasking procedures. If possible, move to a shady place. Bright, direct sunlight can cause pupils in the eyes to constrict, giving false signs of nerve agent exposure. The selected individuals unmask for 5 minutes and then reseal and clear their masks. Observe them for 10 minutes. If no symptoms appear, the commander/leader considers issuing the all-clear signal for unmasking. Continue to watch the personnel for possible delayed symptoms. Always have first aid treatment immediately available in case it is needed.

(c) Unmasking Procedures Without the M256-Series Chemical Detector Kits. If an M256-series kit is not available, the unmasking procedures take at least 35 minutes. Find a shady area. Use M8/M9 paper to check the area for possible liquid contamination. When a reasonable amount of time has passed after the attack, the senior person should select one or two individuals. They take a deep breath, hold it, and break the seal for 15 seconds, keeping their eyes wide open. They then clear and reseal their masks and are observed for 10 minutes. If no symptoms appear, the selected individuals break the seal of their mask, take two or three breaths (keeping their eyes wide open), and clear and reseal their masks. Observe them for 10 minutes. If no symptoms appear, the selected individuals unmask for 5 minutes and then remask. If no symptoms appear in 10 minutes after remasking, the commander considers issuing a directive for an all-clear. This process takes a minimum of 35 minutes. Leaders continue to observe the selected personnel in case delayed symptoms develop.

(d) Personnel Displaying Symptoms. In both cases, if personnel display symptoms of agent poisoning, ensure that first aid procedures are available and provided. If an agent is still present, the senior person present must select one of the following options:

- If possible, move to a new area and retest.
- If the mission dictates that movement cannot be conducted, conduct a retest after 1 hour.

Note: Leaders remain aware that selected chemical agents (e.g., blister agents) may not result in the onset of symptoms for several hours.

(e) Assessing Detector Information. Detector capabilities necessitate that leaders analyze the situation to determine if it is safe to unmask after the detection instruments or devices indicate negative results. This need for analysis exists because of the potential presence of low-level vapors that, through their cumulative effect on the body, may cause eye damage or more severe effects within minutes or hours. Analysis is required even if the above-mentioned unmasking procedures are used. NBC personnel should utilize service directives and materials to assist in this process. The key is the use of risk assessment to balance force survivability and the mission and to acknowledge that different agents dissipate at various rates from different surfaces. For example, the hazard time lines associated with contaminated equipment may exceed those associated with soil and/or concrete surfaces.

(10) Chemical Filter Exchange. Filter exchange is another action that is based on design, physical condition, climatic conditions, and the possible threat agent that could be employed. Information in the following paragraphs addresses peacetime, transition-to-war, and wartime exchange criteria.

Note: The information in this section is not meant to supersede other guidance contained in service-specific TTP or technical publications.

(a) Peacetime Filter Exchange. When assessing filter exchange criteria, several factors must be considered. Commanders and NBC personnel must monitor replacement schedules for pieces of NBC equipment having filters. Peacetime exchange criteria for all filters must occur when the following conditions are applicable:

- Physical damage occurs.
- Filters have become waterlogged/wet.
- High resistance to airflow is observed.
- Directed to exchange filters by higher HQ.
- Filters are listed as unserviceable in applicable supply bulletins (SBs), technical orders (TOs), etc. Selected service directives, may indicate specific filter lot numbers are unserviceable; however, if those filters are not clogged or damaged, they should still be considered serviceable for peacetime applications.

(b) Transition to War Filter Exchange. Commanders will determine when their units should remove their training filters and replace them with filters from unit contingency stocks. This guidance should be reflected in an SOP or an order. Factors for filter exchange consideration are unit location, unit readiness/deployability alert status,

last filter exchange, threat, time availability, and stocks available. For example, a forward deployed unit commander, based on an enemy chemical capability in the AO, directs (by SOP) that his unit install its contingency filter set. Alternatively, a CONUS-based unit commander determines that the basis for installing contingency filters would occur upon an increase in unit alert status for deployment to an area with an NBC threat. Before initiating filter exchange, leaders consider the implications for their units. Some considerations are—

- Mission. What is the unit mission?
- Enemy. What is the current NBC threat assessment? Is the unit likely to be attacked on arrival in the operational area?
- Terrain and weather. Where should filters be exchanged—at the home station, en route, or in the operational area?
- Time available. When should filters be exchanged? When will there be adequate time to exchange filters?
- Troops and support available. Are the right people available to conduct the exchange?

(c) Wartime Filter Exchange. The decision to change filters is driven by two considerations: the amount of chemical agent the filter has been exposed to and the time the filter has been exposed to the atmosphere. These separate considerations are based on the two mechanisms by which the filter provides protection from chemical agents. For all agents, the filter uses mechanical filtration and absorption as the protection mechanism. For blood agent cyanogen chloride (CK), the filter uses a chemical reaction. The chemical reaction mechanism is degraded by prolonged exposure to CK. The absorption capacity is degraded by exposure over time to air, particularly hot, humid air. Based on these factors, the following filter change criteria apply:

Note: In an AO with no chemical attacks confirmed and no CK threat, filters should be changed annually. In an AO with no chemical attacks confirmed but where a CK threat exists, the filters should be changed according to guidance provided in Table II-5.

Note: Information in this table is applicable to USA units; other services follow directives as prescribed in applicable TOs and TMs.

- Physical damage occurs.
- Filters have become waterlogged/wet.
- High resistance to airflow observed.
- When directed by higher authority.
- For units that have received chemical attacks, change all filters every 30 days.

**Table II-5. Wartime Climatic Filter Exchange Intervals,
Blood Agent Threat Is High (Given In Weeks)**

Climate Category					
Filter	Cold Humid	Warm Moderate	Hot Dry	Hot Humid	System
C-2/M13A2	52	52	39	10	M40/M42/M43/MC-2AP-series protective mask.
M10A1	52	52	52	13	M24/M25 protective mask.
M18 Gas	52	39	26	4	Filter composition of M13 tank GPFU.
M12A1 Gas	52	39	26	4	Fixed site filter used in structures and buildings.
M48 Gas/Particulate	52	52	39	10	M1A1 tank overpressure system.
MCPE Gas/Particulate	52	39	26	4	MCPE.
M10 Gas	52	39	26	4	Fixed-site shelter.
C-22 R1 Gas	52	52	52	13	GPFU M46 fixed-site filter.
Climatic Definitions					
Category	Mean Temp (F)		Mean Relative Humidity (%)		
Cold Humid	Less than 15 degrees		Less than 90 percent		
Warm Moderate	Less than 80 degrees		Less than 70 percent		
Hot Dry	Less than 98 degrees		Less than 27 percent		
Hot Humid	Less than 96 degrees		Less than 76 percent		
<p>Note: The climactic intervals listed are applicable to USA units; other services follow directives as prescribed in applicable technical publications.</p>					

6. Collective Protection Operations

COLPRO replaces neither MOPP gear nor the MOPP TTP. For example, the ventilated-facepiece system enhances MOPP gear protection. Overpressure systems create an overpressure environment. This changes the impact of the NBC threat and allows the commander to order lower MOPP levels inside these facilities or systems. Commanders and personnel should be familiar with several preattack, during-attack, and postattack actions in the event of an NBC attack to make the use of available COLPRO systems more efficient and effective.

a. Preattack. Before an NBC attack occurs, several actions should make the use of COLPRO easier.

(1) Commanders should—

- Determine the appropriate MOPP levels inside the facilities/systems.
- Accomplish COLPRO planning.
- Ensure that personnel are accounted for and briefed on the threat

situation.

(2) Individuals should—

- Assume the appropriate MOPP level.
- Check the protection system for proper operation.
- Know the entry and exit procedures.
- Accomplish the individual protective actions.

(3) The shelter attendants should—

- Inspect and maintain the shelter filter system.
- Inspect and maintain the communication system.
- Know the entry and exit procedures.

b. During-Attack.

(1) Actions that should be taken include suspending or minimizing entry into the shelter.

(2) The shelter attendants should—

- Don masks and alert shelter occupants.
- Aid in securing air lock doors.

- Prevent unauthorized personnel from entering the shelter.
- Conduct periodic tests for contamination. If entry from a contaminated environment is mission-essential, internal monitoring becomes critical and MOPP4 would be required if suitable CCA (personnel decontamination) activities cannot be conducted.
- Ensure adherence to prescribed entry and exit procedures.
- Monitor the shelter interior periodically using detector/monitoring equipment.
- Suspend “no mask” operations if a hazardous level of agent is detected inside. Personnel should assume the appropriate MOPP level and consider whether to continue to shelter in place or evacuate the shelter.
- Proceed with unmasking risk assessment when detector/monitoring equipment no longer indicates the presence of agents.
- Know that further actions during an attack will depend on the type of COLPRO.

c. Postattack Actions.

(1) Vapor and liquid contamination hazard may remain for some time after an attack. Personnel also take the following additional actions:

- Ensure that contaminated items are not stowed in CPE.
- Acquire decontamination support if required.
- Resupply expendables, such as IPE, mask and shelter filters, and individual decontamination kits.
- Continue entry and exit procedures until 1 hour after detectors indicate the absence of agent vapors outside the shelter.
- Establish personnel decontamination sites.
- Resume preattack actions, but continue periodic monitoring of shelter interior with detector/monitoring equipment.

(2) After an attack, the shelter attendants will—

- Pass the all-clear signal to the shelter occupants when safe to do so.
- Service the filter system, if needed.
- Assist during entry and exit procedures.

- Continue attendant duties.

7. Toxic Industrial Material Protection

US forces frequently operate in environments in which there are TIM, particularly toxic industrial chemical (TIC) and toxic industrial biological (TIB) material, and/or toxic industrial radiological (TIR) material. A number of these chemicals could interfere significantly across the range of military operations. Release of TIC is most dangerous at night because typical nighttime weather conditions produce high concentrations that remain close to the ground for extended distances. TIM can have other significant hazards. TIC are often corrosive and can damage eyes, skin, respiratory tract, and equipment. Many TIM are flammable, explosive, or react violently with air or water. TIM can have both short- and long-term health effects, ranging from short-term transient effects to long-term disability to rapid death. Military protection, detection, and medical countermeasures are not specifically designed for the hazards from TIM. Often there are no specific antidotes for TIM. See Appendix E for information on the assessment of protective mask filter performance against selected TIC.

Self-protection is the key to successful response efforts. When personnel ensure their self-protection, they can save lives, minimize the spread of contamination, and protect property. Subsequently, units would likely isolate the area and deny entry except to authorized and protected personnel. Personnel must remember that a TIM incident could be a crime scene. As a potential crime scene, it is very important to preserve the evidence to aid prosecuting the individual or individuals responsible for the act.

a. Preattack Actions.

(1) General Planning. Before any operation, the response element should develop an understanding of the potential hazards from TIM in the area of concern. Further, information collection requirements that can support vulnerability analysis and assessment during the planning process (deliberate or crisis action) include some of the following key factors:

- Identifying all possible industrial plants, storage sites, and shipment depots and pipelines.
- Identifying TIM routinely produced, used, or processed in the area.
- Assessing the effects of the TIM release as a result of collateral damage or an accident.
- Assessing whether deliberate TIM release is realistic in this particular situation.
- Identifying local hazard management procedures and civilian agencies responsible for handling incidents.
- Identifying local hazard identification labeling and placarding systems.

- Assessing the need for special detectors and modifications of detectors.
- Assessing the need for specialized protection equipment, such as self-contained breathing apparatus (SCBA) or special, impermeable chemical suits.

(2) **TIM Evacuation Planning.** When time and mission allow, evacuation is the best protective response to a TIM hazard. Plan for in-place protection when evacuation may cause greater risk than remaining in place. In-place protection may not be an option if the TIM vapors are flammable, the hazard is persistent, or buildings cannot be closed tightly.

(3) **Risk Assessment.** Selected measures that support risk assessment include securing key information, assessing risk, and conducting NBC defense actions.

(a) Each situation has special problems and considerations. During planning, attempt to secure pertinent information involving production, storage facilities, distribution, and transportation of TIM. As a minimum, obtain the type, quantity, and specific risk from fire, explosion, toxicity, corrosive effects, and/or persistency of gas. Sources for this information include unit intelligence personnel; appropriate scientific, civilian industrial and CW treaty experts; safety reports; and materiel safety data sheets (MSDSs) on the facility; international code markings on storage tanks; and local civilian authorities who have emergency response procedures and resources.

(b) A thorough vulnerability analysis provides an initial estimate of the threat and is the first step toward mitigating the operational effects of damage or destruction of a TIM facility. Determining the TIM hazard/threat and possible countermeasures in an AO is a primary responsibility of the medical and supporting PVNTMED staff. They are supported by the NBC and civil affairs (CA) staffs.

(c) Military protection and decontamination equipment was not designed for handling TIC. For proper handling, protection, and hazard management information, units seek guidance from their C² element. Commanders also identify the local civilian authorities that may have additional emergency response procedures and resources that can be used.

(d) Some plants, facilities, storage containers, or transport containers may be identified by markers. These could take the form of international markers that are diamond-shaped and contain information that can be used to identify the exact TIM.

(e) For firefighting or entering any enclosed space where there has been a TIM or spill cleanup a SCBA must be used. The individual protective mask (NBC mask) does not supply sufficient air or protection within the immediate hazard zone. TIM, such as ammonia, may be present and the lack of oxygen will require the use of SCBA. The military respirator should be used only for emergency protection against the immediate effects of a TIM release and while evacuating the immediate hazard zone. Further, military CP suits are not specifically designed for providing protection against TIC.

(f) The most important action in case of massive TIC release is immediate evacuation. The greatest risk from a large-scale TIC release occurs when

personnel are unable to escape the immediate area and are overcome. For detailed information on these hazards, see the National Institute of Occupational Safety and Health (NIOSH), *Pocket Guide to Chemical Hazards*; and/or *Guide to Chemical Hazards*; US Department of Transportation, *Emergency Response Guidebook*; and FM 8-500, *Hazardous Materials Injuries: A Handbook for Prehospital Care*.

(g) When planning for operations in areas where TIM may be present, the combatant and subordinate commanders include consideration of these potential hazards as part of the IPB process. These hazards could occur from massive deliberate releases, accidental release from industrial sites, or leaks from storage and transport containers. Particular emphasis should be placed on those TIM that produces acute effects when inhaled.

b. During-Attack Actions.

(1) TIC or TIB.

- Alert higher, adjacent, and subordinate units.
- Start monitoring with available detection devices, and ensure that results are reported.
- Assume MOPP4, and move to a safe distance as quickly as possible.
- Establish a security zone around the area.
- Evacuate casualties. Casualties should be considered as contaminated and should be contained in one central location. Initiate emergency decontamination of personnel.
- Identify witnesses for questioning.
- Establish a downwind hazard zone.

(2) TIR.

- Take protective action.
- Assess casualties and damage.
- Identify potential locations of TIR materials.
- Begin continuous monitoring and report the arrival of fallout.
- Protect personnel and equipment from the effects of fallout and fires that may be started.
- Report increase, decrease, or peak dose rates. Report the completion of fallout.

- Receive an NBC 2 nuclear report from higher HQ. Prepare a simplified fallout prediction and inform the commander.

c. Postattack Actions.

- Control the situation.
- Protect yourself.
- Prevent the situation from claiming more casualties.
- Rescue, protect, and treat victims.
- Decontaminate exposed victims, and minimize the spread of contamination.
- Conduct early hazard identification.
- Preserve evidence per the SOP.
- Follow emergency response SOPs and operation plans (OPLANs).
- Coordinate with local, state, federal, and HN agencies as required.

Chapter III

OPERATIONS IN UNIQUE ENVIRONMENTS

1. Background

Weather and terrain and how they affect the need for NBC protection must receive special consideration. Certain weather conditions will greatly influence the use of NBC weapons. Likewise, different types of terrain will alter the effects of NBC weapons. Also, the type of operation can directly bear on the need for NBC protection. This chapter addresses cold weather, desert, jungle, mountain, urban, and littoral operations.

2. Cold Weather

Cold weather environments create unique and diverse conditions that must be overcome to accomplish an assigned mission in an NBC environment.

a. Nuclear Defense Considerations.

(1) Weapons Effects. The winter environment influences the effects of a nuclear detonation regarding blast, thermal, and radiation effects.

(a) Blast Effects. At subzero temperatures, the radius of damage to material targets can increase as much as 20 percent. Tundra, irregular terrain features, and broken ice caps will break up the pressure wave and, thereby, reduce the effects of this powerful wave. Blast waves can drastically interfere with movement by breaking up ice covers and causing thaws, triggering possible avalanches in mountainous areas. Avoid avalanche-prone areas after the blast. Avalanches can be triggered up to 30 kilometers away, and may cause massive flooding in valleys due to the instability caused by the blast effects.

(b) Thermal Effects. Ice and snow have a high reflectivity. This may increase the minimum safe distance (MSD) as much as 50 percent for unwarned personnel. This reflectivity may increase the number of personnel whose vision is affected by the brilliant flash or light dazzle, especially at night. Cold temperatures reduce thermal effects on materials by reducing the possible heat signature. Snow, ice, and even frost coverings on combustible materials greatly reduce the tendency of materials to catch fire. However, this thermal effect will dry out exposed tundra areas and grass fires may result. Avoid avalanche-prone areas after the blast. Avalanches can be triggered up to 30 kilometers away due to the rapid warming and instability caused by the thermal effects.

(c) Radiation Effects. The number of passable roadways is limited by cold-weather conditions, and radiological contamination on roadways may further restrict resupply and mobility. Seasonal, high winds in the arctic may present problems when predicting radiological contamination and crossing contaminated areas.

(2) Individual Protective Measures.

(a) At low temperatures, land forces operating in a field environment are particularly vulnerable to the effects produced by a nuclear detonation because of the difficulty in preparing fighting positions and underground fortifications for protection. Shelters and fortifications constructed from snow and ice provide some protection and, wherever possible, should be constructed to take maximum advantage of the additional protection provided by natural terrain features.

(b) Snow and ice, although not as effective as earth in reducing radiation hazards, are readily available and can be used to provide shielding against radiation effects. Loose snow falling on a contaminated area will have a half-thickness of about 60 centimeters (24 inches), and 30 centimeters (12 inches) of hard-packed snow will reduce the original value by half.

Note: Half-thickness is the thickness of material required to reduce the original radiation level (reading) to half its value.

(c) Cold weather clothing (white outer shell) provides an advantage of low absorption properties, thereby reducing the thermal effects.

(3) Monitor and Survey Operations.

(a) High winds will extend contamination zones, creating a problem for monitor and survey operations. Aerial survey is a practical method in extreme cold weather areas, depending on the operating altitude and environmental conditions.

(b) Hot spots or areas of concentrated accumulation of radiological contamination may occur in areas of heavy snow and snowdrifts. These areas need special attention during survey operations.

(c) Radiac instruments (used to detect, survey, and monitor radiological hazards) should be kept warm until used to ensure maximum efficiency. (Refer to the appropriate technical publication for operating radiac systems in cold weather environments.)

(4) Decontamination Operations. Due to the freezing point of water (32 degrees Fahrenheit [F]), decontaminate radioactive fallout on vehicles by brushing with brooms or tree branches. Since radioactive effects (fallout) are removed from the items and not neutralized, transfer of contamination occurs.

b. Biological Defense Considerations.

(1) Field Behavior of Agents. BW in the arctic is a possibility, and biological agents are effective in cold weather environments (with few exceptions). Most vectors (infected insects) will not survive the extreme environmental conditions, and it is more difficult to aerosolize live biological agents in freezing temperatures. Toxins, on the other hand, are less susceptible to the cold. At these temperatures spore-forming bacteria and certain viruses survive and remain dormant. Upon warming, they become an active hazard to personnel. Temperature inversions that exist over snowfields tend to prolong the

integrity of an aerosolized biological cloud. Thus, it disperses more slowly and, therefore, remains a threat for a longer period.

(2) Individual Protective Measures. Personnel are more susceptible to biological agents in arctic environments, mainly due to the rapid rate that diseases can spread in the crowded warming areas and the difficulty in maintaining an adequate intake of food and water (calorie intake increases due to extreme physical demands), getting adequate rest, and practicing good hygiene. Enemy forces will be more likely to target food and water sources due to the difficulty in resupply and the reliance on these assets in cold weather.

c. Chemical Defense Considerations.

(1) Chemical Agents. In arctic conditions, chemical agents act differently because of their different physical properties but they are primarily more persistent.

(a) Blister Agents. Some forms of blister agents are ineffective as casualty producers because the ambient temperature could be well below their normal freezing points. This is not true for all blister agents, some of which can be effective as harassing or casualty-producing agents.

(b) Nerve Agents. Low levels of contamination may remain at low temperatures for hours or days. In severely cold conditions, nerve agents will remain liquid and can be absorbed through normal, cold-weather clothing. However, it should be noted that agent data indicates that liquid absorption into soil and concrete was not significantly affected by temperature and that snow absorbed agents within minutes, to the point that less than 2 percent of the agent remained as a pickup/transfer hazard.

(c) Blood and Choking Agents. Blood and choking agents remain extremely hazardous and nonpersistent throughout the low-temperature ranges.

(2) Individual Protective Measures. With the addition of chemical protective clothing, the cold-weather clothing ensemble increases the risk of heat casualties and degrades unit performance. Leaders will need to capitalize on MOPP analysis, risk assessment, and METT-T in order to determine the recommended protection requirements. Grass is more effective as a transfer hazard than snow. As agents transition from a solid to a vapor state in heated shelters, tents, or vehicles, a hazard can be created. Spring melt-off may also spread contamination beyond its original boundaries.

(a) Protective masks. Always refer to the appropriate technical publications for the IPE to obtain the proper procedures for wearing the IPE during operations in cold-weather environments. When donning the protective mask in arctic conditions, personnel should stop breathing, remove the mask from under the parka, remove the gloves or mittens (lower the parka hood, and don and clear the mask according to the direction of the leader). The following additional guidance provides quick tips for leaders to use as a guide when assisting their personnel before, during, and after operations in cold-weather environments during NBC events:

- Use neutral or gray eyelens to prevent snow blindness and the fogging of field protective eyelenses.
- Use tape on outserts so that only slits are left, if neutral or gray outserts are not available.
- Fill canteens to three-fourths full to prevent the canteen from bursting should the water freeze.
- Blow remaining water out of the drinking tube to prevent ice from forming.
- Exhale steadily and slowly to try to prevent frosting of the eyelenses.
- Wear the mask carrier in a position that permits maximum mobility (see approved service and technical bulletins).
- Use a small towel or cloth to wipe the inside of the mask after removal to prevent ice formation.

(b) Chemical Protective (CP) Clothing. The current CP clothing issued to the armed forces will not be adversely affected by cold temperatures. Based on METT-T and risk assessment, leaders will need to establish whether protective clothing is worn as an outer layer (over extreme cold-weather clothing system [ECWCS]) or as an undergarment (under ECWCS). The ECWCS will provide only marginal protection in a chemical environment. Further, CP clothing is neither waterproof nor water-resistant, which will affect the leader's assessment during his METT-T evaluation. This consideration will also impact on how the ensemble is worn (e.g., under the ECWCS with the white parka worn as an exterior layer). The ECWCS includes a parka, trousers, mittens with inserts, gloves with inserts, vapor barrier (VB) boots, baliklavas (a hood), a watch cap, and gaiters. The wearing of the ECWCS also impacts the work/rest cycles assigned by the unit.

(c) Chemical Protective Overboots. The CP overboots do not fit over the cold-weather VB boots. The CP overboots can fit over the ski march boots, but they interfere with the ski bindings. The North Atlantic Treaty Organization (NATO) 120 ski binding can cut through an overboot at the toe plate, contaminating the leather boot inside. During cold weather operations, the VB boots provide adequate protection when worn in conjunction with CP clothing. The VB boots are double-layered, with an air pocket between layers and natural rubber.

(d) Chemical Protective Gloves. Normal procedures when donning the CP gloves, are to first put on the cotton liners and then the rubber gloves. During winter operations in a chemical environment, use the wool glove liners (part of the black leather glove set) under the butyl rubber gloves to absorb and wipe away perspiration from hand surfaces. A proper glove fit is required to preclude restricting blood circulation and cold weather injury. In extreme cold environments, the arctic mittens should be worn over the rubber gloves to provide warmth. Decontamination of cold-weather mittens (if contaminated) may be impractical and, hence, considered as a combat loss.

(e) Nerve Agent Antidote Kit (NAAK). Care must be taken when using the NAAK to ensure that it penetrates through winter clothing to the muscle. NAAKs are subject to freezing at about the same temperature as water. Therefore, when the temperature is below freezing, the NAAK should be protected against freezing. Autoinjectors are normally carried in the protective mask carrier. When the temperature is below freezing, the injectors should be carried in an inside pocket close to the body. Should the NAAK become frozen, it can be thawed out and used. Personnel should also ensure that there is no transfer of contamination when the NAAK is placed into or withdrawn from an inside pocket.

(f) Antidote Treatment, Nerve Agent Autoinjector (ATNAA) System. Arctic weather affects the ATNAA. When the temperature dips below freezing, the ATNAA should be protected by removing it from the protective mask carrier and placing it in an inside pocket close to the body. Keep it as close to body temperature as possible. This precludes the danger of severe muscle spasms and/or shock from injecting an extremely cold liquid into a muscle. If the ATNAA is allowed to freeze, it cannot be used until it is thawed. In addition, protect the ATNAA from freezing during transit, storage, and resupply operations. Care must be taken when using the ATNAA to ensure that it penetrates through winter clothing to the muscle.

(3) Monitor and Survey Operations. Toxic chemicals react differently at extremely low temperatures. Even during cold temperatures, chemical-agent vapors can still be present, and the concentration would be below the detector threshold level. Refer to the appropriate technical publication for equipment operation during cold weather, and monitor and survey operations.

(a) M256A1 Chemical-Agent Detector Kit. Arctic weather affects the kit. When temperature is -15 degrees F (-21 degrees Celsius [C]) or below, the kit can give inaccurate indications. Solutions in the capsules freeze; and the solutions will not work, even if they are reheated. In addition, it is difficult (or sometimes impossible) for the heat tabs to heat the enzyme window to a reaction temperature. Take care to keep the kit at a temperature above freezing. However, do not place the kit directly on a source of heat, such as a vehicle heater. If possible, warm it with body heat by placing it inside the parka. A system of identifying a sample of suspected agent is to collect the suspected agent and place it on M8 or M9 paper. Once collected, the M8 or M9 paper is warmed and covered in a box or can with the M256A1 kit. This will heat both the suspected agent and the kit sufficiently to enable identification with the kit. Personnel can place samples into empty ammunition cans and apply external heat to cause agent off-gassing. The external heat source may be a small fire or a heat tab.

(b) Chemical-Agent Monitor (CAM) and Improved CAM (ICAM). At lower temperatures, chemical agents such as blister agents, become more persistent or even freeze, and reduce the amount of vapor present for the CAM or ICAM to detect. Cold weather also shortens battery life. Refer to the appropriate technical publication for operating the ICAM/CAM in cold-weather environments.

(c) M8 and M9 Detector Paper. M8 and M9 papers are not specifically limited in the cold, but they can detect only liquid agents. If the specific substance is thickened or frozen, a sample can be collected with a stick or a scraper and wiped onto a

sheet of M8 or M9 paper. Place the sample on a heated surface, such as the hood of an operating vehicle, the top of a power generator, or a burning heat tab under a canteen cup, to stimulate thawing of the suspected agent so that identification is expedited. Because of the possibility of off-gassing, this procedure must not be performed inside a heated vehicle or tent.

(4) Decontamination Operations. Refer to the appropriate technical and service publications for decontamination considerations and guidance regarding cold-weather environments.

(a) Equipment Decontamination. The use of water or 5 percent hypochlorite solution for decontamination will be limited during cold-weather operations due in part to the freezing point of water (32 degrees F). Alternatively, a dry mix of super tropical bleach (STB) or high-test hypochlorite (HTH) (two parts STB/HTH to three parts earth or snow) can be used. This method may require several applications at low temperatures. Shovel the dry mix onto the contaminated surfaces or place it in sandbags and dust it onto surfaces. After decontaminating, remove any residual elements of the dry mix by brushing, scraping, or removing it with uncontaminated earth or snow. These decontaminants are corrosive to metals and personnel must wear MOPP gear. Additionally, sorbent decontamination is also limited during cold weather. Sorbent decontamination systems are based on liquid absorption, and frozen agents cannot be absorbed.

(b) Personnel Decontamination. Time factors regarding MOPP exchange or detailed troop decontamination (DTD) should be expanded with regard to cold-weather conditions and the addition of the ECWCS. For example, the time required to doff the ECWCS, the white parka, and the trousers will add more time to the MOPP exchange process. Additionally, more time will be needed if the VB boots require decontamination.

(5) COLPRO. For COLPRO, chemical hazards present additional challenges. Cold-weather operations use heated shelters, and shelters may or may not have COLPRO. However, fluctuations in pressure may occur when the system is exposed to high winds. In cold environments, indirect chemical-vapor absorption presents the greatest problem during shelter entry and exit operations. For this reason, it is important to have a detection capability in the shelter itself. If an agent is detected, personnel in the shelter will immediately mask. The personnel inside the shelter will be monitored to identify who brought in the contamination. Once identification has been made, the personnel exit and the shelter is then immediately purged. If follow-on detection proves negative, personnel may resume entry and exit procedures. Additionally, CP systems used as an MTF cannot be easily evacuated. Therefore, contaminated personnel must not be allowed entry.

3. Desert

Desert operations present many varying problems. Desert daytime temperatures can vary from 90 to 125 degrees F (32 to 52 degrees C). An unstable temperature gradient results, and this is not particularly favorable to NBC attacks. However, with nightfall, the desert cools rapidly, and a stable temperature gradient results. A possibility of night or early morning attacks must be considered in all planning of desert operations. Additionally, planners understand that hot temperatures can adversely impact NBC defense equipment/supplies during transit or storage. For information on specific items, check the appropriate TOs and TMs.

a. Nuclear. Nuclear defense planning is generally much the same in a desert as in other areas, with exceptions. The lack of vegetation and permanent fixtures, such as forests and buildings, make it necessary to consider construction of fortifications. Construction may be difficult because of sand inconsistencies; but sand, in combination with sandbags, will give additional protection from radiation exposure. Blowing winds and sands can also produce widespread areas of radiological contamination.

b. Biological. Most aerosolized, live biological agents, except for a few, are ineffective weapons in the high temperatures of desert areas. An exception is spore-forming biological agents. This is a result of low humidity and the ultraviolet radiation of direct sunlight. Personnel crossing or occupying desert terrain face little danger from long-term, live biological contamination except for spore-forming agents; however, because of favorable night conditions, a covert aerosolized attack could occur. Toxins are resistant to this harsh environment and could be employed in the same way as chemical agents.

c. Chemical.

(1) Chemical agents can be used in point or on-target attacks. This type of attack can be used at high temperatures because of rapid agent evaporation. For example, with a neutral temperature gradient, 90 degrees F (32 degrees C) temperature, and light wind, sarin (GB) evaporates rapidly.

(2) Desert soil may be very porous. For example, an attack with an unthickened liquid agent may occur in support of a predawn attack. Soil soaks up the agent. When the sun rises, it begins to heat the surface. The agent evaporates and can create a vapor hazard.

(3) A nonpersistent agent attack is unlikely during daylight hours. Weather conditions may rapidly dissipate any agent. Night brings about a reversal of weather conditions and creates ideal conditions for an attack. At night, agents linger and settle into low areas, such as fighting positions.

(4) In planning for defense, plan any strenuous activity for the nighttime hours. This will reduce the heat stress caused by wearing MOPP gear. Take care to ensure that sleeping personnel are masked (if appropriate). Also, see that they are checked periodically to ensure that mask seals are not broken. An attack is more likely to occur at

night than during the day. Use the buddy system or have the guards check personnel during their rounds. The unit SOP must address this subject.

4. Jungle

Tropical climates require the highest degree of individual discipline and conditioning to maintain effective NBC defense readiness. Dominating climatic features of jungle areas are, constant high temperatures, heavy rainfall, and very high humidity. In thick jungle, there is usually little or no wind, and the canopy blocks much of the sunlight from the ground. Commanders must expect and plan for a rapid decrease in unit efficiency. They must also expect heat casualties. In addition, they must ensure that special precautions are taken to maintain unit NBC defensive equipment in usable condition. The rapid mildew, dry rot, and rust inherent in jungle areas make this requirement necessary.

a. Nuclear. Dense vegetation has little influence on the initial effects of nuclear detonations, except that the heavy canopy provides some protection against thermal radiation. The blast wave creates extensive tree blowdown and missile effects. Some falling particles are retained by the jungle canopy, and reduced radiation hazards may result. Subsequent rains, however, will wash these particles to the ground. Particles will concentrate in water collection areas and produce radiation hot spots.

b. Biological. Jungles provide excellent conditions for threat use of live biological agents. Warm temperatures, high humidity, and protection from sunlight all aid the survivability of disease-causing microorganisms. Low wind speeds and jungle growth limit downwind hazards. Strict adherence to field sanitation procedures (especially vector and rodent control), the use of skin and clothing repellents, and the use of permethrin-treated bed nets are essential in jungles. These procedures will help control the naturally occurring diseases that abound. Personnel should mask and roll down sleeves to cover exposed skin and prevent possible contact with live biological agents.

c. Chemical. Chemical agents used in jungle areas can cause extreme problems for friendly forces. Persistent agents delivered by artillery shells and aircraft bombs may penetrate the canopy before dissemination. These agents can remain effective on jungle floors for extremely long periods. High temperatures can increase vapor hazards from liquid agents. Nonpersistent agent vapors hang suspended in the air for extended periods because of low wind speeds. However, these wind speeds minimize downwind vapor hazards. Chemical agents employed in jungle areas make MOPP gear necessary for ground operations. However, high temperatures and humidity combined with the heat-loading characteristics of MOPP gear increases performance degradation.

5. Mountains

Terrain and weather in mountainous areas dictate a requirement for a high degree of NBC defense preparedness. Rugged terrain limits the employment of large forces. Adjacent units may not be able to provide mutual support. Also, there may be reduced logistical support and difficulty in achieving rapid maneuver. In these circumstances, small US units can impede, harass, or canalize numerically superior threat forces. The intention is to dissipate threat strength and compel threat forces to fight a decisive battle under

unfavorable circumstances. Mountain warfare requires friendly units to be almost completely self-sufficient in NBC protection.

a. Nuclear. Nuclear targeting in mountainous areas is easier than in flat terrain. The reasons are the lack of roads and trails and the slow speed at which personnel must move. Preparing fighting positions and building other protective shelters are difficult in rocky or frozen ground. Improvised shelters built of snow, ice, or rocks may be the only possible protection. Because of rapidly changing wind patterns, radiological contamination deposit may be very erratic. Hot spots may occur far from the point of detonation, and low intensity areas may occur very near it. Limited mobility makes radiological surveys on the ground difficult, and the difficulty of maintaining a constant flight altitude makes air surveys highly inaccurate. Natural shelters provide some protection from nuclear effects and radiological contamination. These natural shelters include caves, ravines, and cliffs. Clear mountain air extends the range of casualty-producing thermal effects. Added clothing required by cool mountain temperatures, however, reduces casualties from these effects. Units operating under nuclear warfare conditions should also carefully select positions where they will not be hit or trapped by avalanches or rock/mud slides.

b. Biological. Defense against biological agents does not differ in principle in mountains from that in flat terrain.

c. Chemical. Aerial delivery could be a likely means of chemical munitions employment in mountain warfare. Personnel should be constantly alert for aerial strikes, and they should take protective actions immediately. Defense against chemical attacks in mountains is similar to that in flat terrain; however, the compartmentalization and micrometeorological effects in mountainous terrain will affect the clouds' downwind travel. For example, the wind could be blowing in different directions in adjacent valleys. Consequently, a chemical strike in one valley may not affect units in an adjoining valley.

6. Urban Areas

To plan NBC defense, commanders must be familiar with how urban terrain will affect their mission in an NBC environment. For example, the TIM density will likely increase in an urban area, the downwind transport of aerosols will be influenced by the unique micrometeorological considerations in urban terrain (e.g., increased thermal buildup and thermal islands), and there will be a larger number of noncombatants.

a. Nuclear. Without additional preparation, unreinforced buildings give inadequate shelter from a nuclear blast. If used correctly, ground floors and basements of steel or reinforced concrete offer excellent protection from most effects except overpressure. Personnel should avoid windows because of possible injuries from flying debris and glass. Personnel also may receive severe burns through openings facing ground zero (GZ). Storm drains and subway tunnels are readily available in most urban areas. These provide better protection than ground level buildings. Personnel should not use structures of wood or other flammable materials because they could burst into flames. Buildings do provide a measure of protection against radiological contamination; and personnel may travel through buildings, sewers, and tunnels. However, they should consider the dangers of collapse because of blast.

b. **Biological.** Buildings and other urban structures can provide some immediate protection from direct spray. However, the stable environment of these structures may increase persistency of biological agents. Toxins are very effective in an urban environment, and personnel should take the same precautions prescribed for chemical agents. Pound for pound, biological agents are more toxic than chemical agents, and agent effects are especially magnified in an enclosed area. Covert operations are particularly well-suited for urban terrain. Existing water and food supplies are prime targets. Personal hygiene becomes increasingly important. The urban terrain increases the potential for person-to-person transmission of contagious biological agents. Commanders must establish and consistently enforce sanitary and personal hygiene measures, including immunizations. They must also ensure that personnel drink safe water and must never assume that hydrant water is safe.

c. **Chemical.** Urban structures can protect against spray attacks, but this exchange for overhead cover creates other problems. Generally, chemical agents tend to find and stay in low areas, such as those found in urban locations such as basements, sewers, and subway tunnels. Personnel should avoid these low areas. Stay times of agents, such as GB, greatly increase when agents settle in these areas. Once an attack occurs, detection of chemical contamination becomes very important. Personnel must thoroughly check areas before attempting to occupy or traverse them. Additionally, chemical-agent concentrations will generally decrease with an increase in structure height, and personnel on the higher stories of a tall building should experience lower agent concentrations.

7. Littoral Environments

During operations at the sea-land interface, multiple considerations impact NBC defense operations. For example, land and sea breezes occur almost daily in tropical and midlatitude regions on the coasts of all islands and continents. This occurs because the land cools and heats more rapidly than the adjacent water. Therefore, the commander must be concerned about potential offshore CB agent threat.

a. **Nuclear.** The blast effects from a nuclear detonation can cause significant damage to military operations ashore and afloat. Additionally, ships could be damaged by tidal surges caused by such an attack. Reflective surfaces, such as water, can also enhance weapon thermal effects. Residual contamination can contaminate and hinder critical logistics over-the-shore (LOTS) operations.

b. **Biological.** During littoral operations, meteorological conditions can be especially favorable for use of biological agents. Offshore line release of a biological agent can cover larger areas. Biological-agent surveillance assets monitor for the presence of biological agents in the littoral environment. Whether the littoral environment is in an extreme temperate (cold or hot) climatic zone, a biological-agent aerosol can cause casualty-producing effects.

c. **Chemical.** Blister agents (especially mustards) may cause casualty-producing effects if personnel encounter them in salt or fresh water. Generally, water will cause some blister agents to hydrolyze; however, the temperature and relative acidity or basal content of the water will affect the rate of hydrolysis. Further, littoral operations in tropical areas

(i.e., high temperatures and humidity) can also enhance the casualty-producing effects of chemical agents.

Chapter IV

MISSION-ORIENTED PROTECTIVE POSTURE ANALYSIS

1. Background

This chapter addresses the guidance for determining appropriate levels of protection in an NBC environment (MOPP analysis) and MOPP levels.

2. Analysis

During the preattack phase, NBC personnel consider METT-T, and related information to provide recommendations on protection requirements. Medical personnel also provide recommendations to ensure safe and sustained operations under various climatic conditions. The commander and staff should develop standard responses and COA for each projected mission. After the attack, NBC personnel will use the information collected to identify the type of agent used, the likely duration of exposure, and minimum protection requirements. Leaders know they cannot expect the same work rates in MOPP4 as they achieved in MOPP0. They reevaluate their ability to meet mission requirements and communicate changes to their forces. Should they neglect to provide additional resources or adjust task completion times, first-line supervisors may assume the mission is critical and try to maintain the original time lines. Depending on the task and climate, the short- and long-range consequences to personnel may range from insignificant (cool or mild) to catastrophic (hot and dry). MOPP reduction decisions are also among the most difficult to make because of the many considerations that affect the final decision. Commanders must evaluate the situation from both the FP and the mission perspectives. Factors include the criticality of the current mission, potential effects of personnel exposure, and the impact on the casualty care system. The commander and staff can then determine what follow-on COAs to employ. Leaders determine the appropriate MOPP level by assessing METT-T factors and weighing the impact of increased levels of protection (reducing the risk of CB agent exposure and the increased risk of heat strain as protection levels increase) (see Table IV-1).

Table IV-1. MOPP Analysis

- **MOPP analysis considers:**
 - Mission.
 - Enemy.
 - Time available.
 - Troops and support available.
 - Terrain and weather.
- **MOPP analysis provides recommended MOPP levels.**

a. Mission. To support analyzing mission factors, the following questions can be asked:

- What is the mission?
- What additional protection (such as COLPRO) is available?
- How physically and mentally demanding is the mission that must be performed (i.e., work intensity)?
- How quickly must the mission be accomplished?
- What is the expected duration of the mission and likely follow-on missions?
- Are adequate food and water supplies available?

b. Enemy (Threat). The following questions can be asked to support threat considerations:

- Is an attack probable?
- Is an attack imminent or in progress?
- Is the immediate AO contaminated once the attack is over?
- What are the likely targets, threat agents, and warning times?

c. Terrain and Weather. To support analyzing terrain and weather factors, the following questions can be asked:

- What is the ambient air temperature? What is the humidity?
- What is the wet-bulb, globe temperature (WBGT) index reading for the unit's AO?
- Is it cloudy, sunny, or windy?
- Is the terrain sandy, mountainous, or marshy?

d. Troops and Support Available. The following considerations could impact this factor:

- How many personnel are available?
- What IPE do the personnel possess?
- What is the training status of available personnel?

e. Time Available. To support this factor, the following considerations can apply:

- What is the time of day (or night) for completion of the mission?
- How much time is available for completion of the task?
- Can completion of the task be delayed?

Note: Guidance for the prevention of heat injury and illness can be based on WBGT readings. The WBGT reading provides a single measure of the major determinants of environmental heat stress (e.g., air temperature, wind speed, solar load, and humidity). Although the WBGT provides an adequate representation of the heat stress under most conditions, it is not perfect and should be interpreted as approximate guidance. For instance, it is not optimized for conditions commonly seen in environmental extremes, such as the desert. Guidance based on the WBGT is appropriate only for personnel who are fully acclimatized, optimally conditioned, hydrated, and rested. Additionally, WBGT guidelines do not accurately forecast injury/illness rates under conditions of lower temperatures and high humidity, such as may be experienced in the early morning hours. Humidity levels over 75 percent substantially increase the risk of heat injury under all work conditions.

Note: See Appendix C and FM 21-10, *Field Hygiene and Sanitation*, for detailed information on human factors effects that can be caused by the wearing of MOPP gear. Appendix C also provides information on suggested work/rest cycles while wearing MOPP gear.

f. Preattack, During-Attack, Postattack. MOPP analysis points of emphasis will likely vary during preattack, during-attack, and postattack phases. For example—

- During preattack preparation, MOPP analysis may focus on enemy intent and the probability of attack.
- During an attack, MOPP analysis may focus on the mission and what the impact of increased protection measures will have on the mission.
- During postattack situations, MOPP analysis will likely focus on continuing assessment of the hazard and how long the protection level will need to be sustained.

3. Guidance

Leaders apply mission, environmental, and NBC threat information to help determine what MOPP level is appropriate for the unit's situation.

a. Higher HQ (i.e., wing/corps/group/JTF) provides directives to subordinate elements that will include a MOPP level. Within the constraints of service directives, subordinate units apply flexibility and initiative to this guidance to account for local conditions. Failure to do this exposes units to far greater hazards in the form of heat casualties, direct fire losses, and mission failures. The following paragraphs provide instructions for applying the guidance offered by higher HQ. Once MOPP levels are established by higher HQ, subordinate units may not downgrade from this level except for the following reasons:

- Units may temporarily reduce MOPP levels, consistent with the risk, to conduct decontamination operations (such as MOPP gear exchange).
- Personnel inside enclosures may reduce MOPP level at the discretion of the section/flight/platoon leader or higher commander. The enclosure need not be airtight but should be capable of protecting against the initial liquid hazard.

b. Land forces may make decisions on increasing or modifying MOPP posture at the tactical level (i.e., squad and platoon level). Small units (like platoons) frequently conduct independent operations; therefore, the unit leader's training and experience are essential to successful operations under NBC conditions. Directives received by small tactical units should also indicate a minimum MOPP level and, if needed, a percentage of personnel masked. In some cases the guidance received by battalion or equivalent will be passed without change down to team/section/squad level.

4. Levels

In confronting an NBC threat, the MOPP analysis process can be used to help develop protection levels (controls). The MOPP analysis process can be used as a tool to support determining the appropriate protective posture, estimating unit/personnel effectiveness (e.g., mission degradation), estimating additional logistics requirements (e.g., water resupply, and IPE replenishment), and assessing/weighing the tradeoffs between agent exposures versus degraded performance (e.g., wearing of MOPP4).

a. Standard MOPP.

(1) MOPP Levels. Leaders are familiar with standard MOPP levels; familiarity with these levels aids in making rapid and educated decisions. Standardized MOPP levels allow leaders to increase or decrease levels of protection through the use of techniques such as readily understood prowords. Leaders determine which protective posture their subordinate units will assume (see Tables IV-2 through IV-6 [pages IV-5 through IV-9]) and then direct their units to assume that MOPP level. Leaders are also aware that the shipboard application of MOPP level will vary from ground force MOPP (see Table IV-7 [page IV-10] for the differences). The commander or leader directive also can include, based on the threat, the percentage of personnel that will mask; for example, MOPP1, 50 percent masked. The system is flexible, and subordinate leaders can modify their unit MOPP level to meet mission needs. The following standardized protective postures assume that personnel are carrying their individual decontamination kit, M8/M9 detector paper, NAAK, and protective masks.

(2) MOPP Ready (applies to USA/USMC only). Personnel carry their protective masks with their load-carrying equipment (LCE). Individual MOPP gear is labeled and stored no farther back than a logistics site (e.g., brigade support area [BSA]) and is ready to be brought forward to the individual when needed. Pushing MOPP gear forward should not exceed 2 hours. Units in MOPP ready are highly vulnerable to persistent agent attacks and will automatically upgrade to MOPP0 when they determine or are notified that NBC weapons have been used or that the threat exists for NBC weapons use. When a unit is at MOPP ready, personnel will have field-expedient items, such as wet weather gear, identified for use in the event of an unanticipated NBC attack. Additionally, USAF

personnel stationed in or deployed to NBC medium- and high-threat areas are issued NBC protective equipment capable of bringing them to the MOPP4 level of protection. Therefore, when the theater commander declares MOPP ready, USAF personnel will automatically assume MOPP0 as opposed to MOPP ready.

(3) MOPP0 (see Table IV-2). IPE is issued to and inspected by the individual and prepared for use. Personnel carry their protective masks with their LCE. The standard issue overgarment and other IPE are carried or are readily available. To be considered readily available, equipment must be carried by each individual, stored within arm's reach, or be available within 5 minutes; for example, within the work area, vehicle, or fighting position. Units in MOPP0 are highly vulnerable to persistent agent attacks and will automatically upgrade to MOPP1 when they determine or are notified that persistent NBC weapons have been used or that the threat exists for NBC weapons use. The primary use for MOPP0 is during periods of increased alert when an enemy has a CB employment capability, but there is no indication of use in the immediate future. MOPP0 is not applicable to forces afloat.

Table IV-2. MOPP Level 0

Available For Immediate Donning
<ul style="list-style-type: none"> • IPE • Field Gear
Available
<ul style="list-style-type: none"> • IPE issued and serviceable • Protective mask filter/hood installed
Primary Use
<ul style="list-style-type: none"> • CB threat • Preattack
MOPP0 is used during periods of increased alert when the enemy has CB employment capability but there is no indication of use in the immediate future.

(4) MOPP1 (see Table IV-3). When directed to MOPP1, personnel immediately don the overgarment. In hot weather, the overgarment jacket can be left open and the overgarment can be worn directly over underwear and other IPE making up the individual MOPP gear (e.g., footwear covers, mask, and gloves are readily available or carried). M8 or M9 paper is attached to the overgarment, (carry the NAAK and decontamination kit or keep them at hand). MOPP1 provides a great deal of protection against persistent agents. The primary use for MOPP1 is when a CB attack in theater is possible. Personnel must remove contact lenses and wear protective mask optical inserts. Leaders also monitor hydration levels. For forces afloat, MOPP1 means IPE is available.

Table IV-3. MOPP Level 1

Worn
<ul style="list-style-type: none"> • Overgarment • Field gear
Carried
<ul style="list-style-type: none"> • Footwear covers • Mask • Gloves
Primary Use
<ul style="list-style-type: none"> • CB threat • Preattack
<p>MOPP1 is generally used when a chemical, and/or biological attack in theater is possible.</p>

(5) MOPP2 (see Table IV-4). Personnel wear and/or put on their footwear covers, overgarment, and the protective helmet cover. As with MOPP1, the overgarment jacket may be left open, but trousers remain closed. The mask with mask carrier and gloves are carried. The primary use for MOPP2 is when a CB attack in theater is possible. Personnel carry M8 and M9 paper, nerve agent antidotes, and decontamination kits or keep them at hand. Personnel wear the protective mask optical inserts and maintain hydration levels. For forces afloat, MOPP2 means that personnel begin carrying masks.

Table IV-4. MOPP Level 2

Worn
<ul style="list-style-type: none"> • Overgarment • Field gear • Footwear covers
Carried
<ul style="list-style-type: none"> • Mask • Gloves
Primary Use
<ul style="list-style-type: none"> • CB threat • Preattack
<p>MOPP2 is generally used when a chemical, and/or biological attack in theater is likely.</p>

(6) MOPP3 (see Table IV-5). Personnel wear the overgarment, footwear covers, protective mask, and protective helmet cover. Again, flexibility is built into the system to allow for personnel relief at MOPP3, particularly in hot weather. Personnel can open the overgarment jacket and roll the protective mask hood for ventilation, but the trousers remain closed. The protective gloves are carried. The primary use of MOPP3 is for personnel operating inside areas where a chemical-agent contact hazard does not exist. MOPP3 is not appropriate if a contact hazard is present. At MOPP3, forces afloat don protective suits and boots and activate intermittent countermeasure washdown.

Table IV-5. MOPP Level 3

Worn
<ul style="list-style-type: none"> • Overgarment • Mask and hood • Field gear • Overboots
Carried
<ul style="list-style-type: none"> • Gloves
Primary Use
<ul style="list-style-type: none"> • CB threat • Postattack
<p>MOPP3 is generally used in areas with no contact hazard or operationally significant percutaneous vapor hazard.</p>

(7) MOPP4 (See Table IV-6). Personnel completely encapsulate themselves by closing their overgarments, adjusting all drawstrings to minimize the likelihood of any openings, and putting on their protective gloves. MOPP4 is used when the highest degree of protection is required, or if CB agents are present but the actual hazard is not determined. As with every other MOPP level, flexibility is built into the system to provide relief to the individual. Once the hazard is identified and risk assessment measures are employed, the overgarment may be left open.

Note: During coalition operations, US forces familiarize themselves with the protection levels used by personnel from other nations.

Table IV-6. MOPP Level 4

Worn
<ul style="list-style-type: none"> • Overgarment • Mask and hood • Field Gear • Footwear covers • Gloves
Primary Use
<ul style="list-style-type: none"> • CB threat • During-attack • During and postattack
<p>MOPP4 is used when the highest degree of CB protection is required, or when CB agents are present; but the actual hazard has not been determined.</p>

b. MOPP Options. A MOPP option includes mask only. The mask is worn with the long-sleeve duty uniform (for limited skin protection). The mask-only command may be given under these situations:

- When riot control agents (RCAs) are being employed and no CB threat exists.
- In a downwind vapor hazard of a nonpersistent CB agent.

CAUTION

Mask only is not normally an appropriate command when blister or nerve agents are involved.

Table IV-7. MOPP Differences (Afloat Versus Ashore)

Afloat*		Ashore**	
MOPP	Description	MOPP	Description
		MOPP Ready ² (USA/USMC only)	Carry mask and ensure that IPE is nearby ² .
		MOPP0	Carry mask and ensure that IPE is available ³ .
MOPP 1	Ensure that IPE is available ³ .	MOPP1	Don overgarment.
MOPP 2	Activate installed detectors, Carry mask ¹ and post M8/M9 paper.	MOPP2	Don protective boots.
MOPP 3	Don protective suit, and boots; activate intermittent countermeasures washdown.	MOPP3	Don protective mask.
MOPP 4	Don protective gloves and mask	MOPP4	Don protective gloves.
*USN, USCG, and MSC vessels.		**USN, USMC, USA, and USAF personnel.	
¹ The term "mask" includes any form of respiratory protection against NBC hazards as issued by services. ² IPE must be available to soldiers and marines within 2 hours. A second set must be available in 6 hours. MOPP ready does not apply to the USAF. ³ IPE must be within arm's reach of personnel.			

c. **Automatic Masking.** Automatic masking is the act of immediately masking and assuming MOPP4 when encountering CB attack indicators. Before CB weapons usage is confirmed, personnel will don their masks when there is a high probability of a CB attack. When chemical agents have been employed, commanders at all levels may establish a modified policy of automatic-masking by designating additional events as automatic masking criteria. Once this information is disseminated, personnel will mask and assume MOPP4 automatically whenever one of these events occurs. Automatic-masking criteria should be used by the commander as a decision tool and is based on NBC IPB, risk assessment, and METT-T. Subordinate commanders may add automatic masking criteria at their discretion. High probability CB attack indicators can include—

- The sounding of a chemical-agent alarm.
- A positive reading on chemical-agent detector paper or a CAM.
- Personnel experiencing symptoms of chemical-agent poisoning.

d. **Identification of Personnel in MOPP.** Identifying personnel in MOPP can be accomplished through various means. Personnel follow the guidance prescribed in service TMs or TOs. However, one way is to use tape that indicates the individual's rank and first and last names. Blood type and religion are optional data entries. When personnel are not in MOPP, a strip of tape with all the information printed on it can be placed on the

individual's helmet (front and back), mask canister, overgarment bag, or mask carrier. When overgarments are put on, personnel can pull the tape off the overgarment bag and place it on their overgarments to further ease identification.

e. MOPP System Flexibility.

(1) MOPP is not a fixed or rigid system. Flexibility is the key to providing maximum protection with the lowest risk possible, while still allowing mission accomplishment. Flexibility allows designated commanders to adjust the amount of MOPP protection required in their particular situations and still maintain combat effectiveness. Additionally, commanders can place all or part of their units in different MOPP levels (i.e., split MOPP) or authorize variations within a given MOPP level. For example, a fixed-site (e.g., AB or port) or base cluster commander may divide his AO into sectors. Based on postattack NBC reconnaissance efforts, the commander could direct the use of different MOPP levels (e.g., split MOPP) in the different sectors. Split MOPP is the concept of maintaining heightened protective posture (MOPP4) only in those areas that are contaminated, allowing personnel in uncontaminated areas to continue to operate in a reduced posture (MOPP2). The reasons behind this idea are to reduce the impact on personnel and to enhance mission accomplishment.

(a) There are challenges in using split MOPP. One of these challenges is the fact that many individuals may routinely move from one area of an installation to another in performing their duties. Split MOPP should be done on a zone-by-zone basis. A base/fixed site could be divided into multiple NBC zones (not to be confused with on-base sectors).

(b) Zone borders tend to be natural geographic markers (such as roads and fences) to help differentiate the zones and ensure zone recognition.

(c) When split MOPP is in effect, travel requires personnel to know not only the zone status of their current area but also the status of the areas they will be traveling through and their destination. If personnel will be traveling from a clean to a dirty area, they must be prepared to don MOPP gear at the transition point to the contaminated zone.

(d) Zone transition points (e.g., road intersections where clean and dirty chemical zones meet) may be used, and the fixed-site/base personnel place stanchions/barricades at these locations when zone transitions are in effect.

(e) Personnel must plan their routes to minimize contact with contaminated areas, and they must know where to don MOPP gear if required.

(f) Units also establish various procedures for managing transzone movement. For example, personnel may coordinate routes through their unit operations center.

(2) When directed, personnel may leave the overgarment jacket open at MOPP 1, 2, 3, or 4, allowing greater ventilation. Personnel may leave the hood open or rolled when the mask is worn. Commanders will decide which of these variations to use based on the

threat, temperature, and unit work intensity. Personnel may also don (based on the situation) clothing such as the air crewman's cape, SCALP, or wet-weather gear.

(3) Personnel wear protective gloves at MOPP1 through 4 when handling equipment that has been decontaminated. This prevents contact with agents that may have been absorbed by equipment surfaces.

(4) Where the hazard is from residual nuclear effects (e.g., fallout), the commander modifies the MOPP level based on his assessment of the situation and the criticality of the mission. MOPP gear does not protect against gamma or neutron radiation; however, wearing MOPP gear can reduce radiological hazards from beta particle burns and alpha particle ingestion. Primary concerns are to reduce the amount of radioactive contamination that contacts the skin and to prevent ingestion of radioactive particles.

f. Impact of MOPP.

(1) Personnel wearing MOPP4 will take about one and one-half times longer to perform most tasks.

(2) Decision making and precision control (e.g., typing a message or aiming) are slowed even more than manual tasks. The normal expected completion time should be multiplied by two and one-half (or more, if personnel have been in MOPP4 for an extended period or are overheated).

(3) Well-prepared personnel suffer less stress when in MOPP than personnel who are less-prepared. Well-prepared personnel are those who are in good physical condition and have trained extensively in protective gear. Physically fit personnel are more resistant to physical and mental fatigue and acclimatize more quickly to climatic heat or the heat associated with MOPP wear than less fit personnel.

(4) Units that anticipate deployment to regions where the employment of CB agents is possible should augment physical training (PT) programs and increase their state of heat acclimatization. To optimize heat acclimatization, personnel should progressively increase the duration (reaching 2 to 4 hours) and intensity of exercise in the heat over 7 to 14 consecutive days. Finally, when personnel are required to routinely work in MOPP gear, it is important to practice good hygiene and keep the skin clean to avoid heat rash, which can dramatically reduce the body's ability to regulate temperature.

Chapter V

SUSTAINED OPERATIONS IN A NUCLEAR, BIOLOGICAL, AND CHEMICAL ENVIRONMENT

1. Background

The modern battlefield and the threat of NBC weapons pose significant challenges to leaders and their units. Based on those challenges, this chapter addresses the impact of the NBC environment as it affects the performance of individuals and units. This chapter provides insights into the degradation to be expected from enemy employment of NBC weapons and provides suggested guidance for maintaining operational tempo in the NBC environment. The basic goals remain to avoid or minimize the impact of the contamination and to enhance endurance and task performance. The NBC environment impacts leaders and subordinates from different aspects. Leaders provide the necessary command and control to ensure successful operations, and leaders must train themselves to know what to expect and to recognize common pitfalls. Subordinates, on the other hand, must focus on the accomplishment of individual and collective tasks.

2. Impact of a Nuclear, Biological, and Chemical Environment

When individuals are encapsulated in MOPP ensembles, they are subjected to both physiological and psychological stresses. However, given an understanding of the NBC environment, its impact, and proper training, individuals can perform assigned tasks successfully for a considerable period of time.

a. **Physiological and Psychological Impact.** There are physiological and psychological factors that are common to military operations and operations in the NBC environment. A number of these factors can contribute to decreased tolerance due to the effects of operations in an NBC environment (see Table V-1 [page V-2]). Because these factors are amplified in an NBC environment, leaders and their subordinates are alert for those factors that can impact mission operations (see Table V-2 [page V-2]). Leaders are also aware of psychological issues that can be magnified by an NBC environment (e.g., individuals may become depressed or hyperactive) (see Table V-3 [page V-3]). See Chapter IV for information on how physiological and psychological degradation impacts MOPP analysis and Appendix C for more detailed information on the stress incurred while wearing IPE.

Table V-1. Factors That Influence Decreased Tolerance

<ul style="list-style-type: none"> • Disease/medication • Dehydration • Heat/cold • MOPP gear • Exhaustion • Workload • Food deprivation • Isolation
--

b. **Impact on Leaders.** A major element of leadership is that the leaders must take care of themselves as well as their personnel. They are subject to the same degradation that can befall their personnel. Leader neglect can result in leaders becoming casualties. Leaders supervise countermeasures such as work/rest cycles, periodic fluid replacement, and scheduling heavy work rate activities at times other than high temperatures (see Table V-4). Leaders may also display actions and attitudes that affect their effectiveness (e.g., less leader adaptability and/or more leader casualties). To help mitigate this consideration, confidence is developed during stressful NBC training.

Table V-2. Common Signs of Physiological and Psychological Degradation

Physiological Degradation	Psychological Degradation
<ul style="list-style-type: none"> • Nervousness • Trembling • Sweating • Pounding heart • Dry mouth • Headache • Fatigue • Nausea 	<ul style="list-style-type: none"> • Forgetfulness • Inattentiveness • Decreased confidence • Frustration • Difficulty concentrating • Startled response to noise • Uncooperative behavior

c. **Impact on Individuals.** Just as leaders are impacted by operations in an NBC environment, there are many stressors (see Table V-5) that impact an individual's ability to function in an NBC environment. For example, even though personnel become dehydrated, they do not feel thirsty; thus, they do not practice forced drinking. MOPP4 can increase perceptions of respiratory distress and decrease clear thinking. Personnel also may begin to take dangerous shortcuts and make mistakes while performing tasks. Crews in closed vehicles in MOPP4 can experience motion sickness. Individuals operating in high elevations in MOPP4 can experience serious degradation and require up to 4 days to adjust.

Table V-3. Depression/Hyperactivity Behaviors

<ul style="list-style-type: none">• Lack of movement• Constant movement• Arguing• Jerky movements	<ul style="list-style-type: none">• Slow reaction• Rapid talking• Anxiousness• Lack of facial expression
--	---

Table V-4. Impact of an NBC Environment on Leaders

<ul style="list-style-type: none">• Less adaptability• Less delegation• Less sleep• Less effective communications• Less leadership effectiveness• Less initiative from subordinates	<ul style="list-style-type: none">• More exhaustion• More irritability and impatience• More leader casualties (after 6 hours)• More micromanagement• More omission of critical items in OPORD• More periods when no one is in charge (after leader becomes casualty)
--	---

Table V-5. Impact of an NBC Environment on Individuals

<ul style="list-style-type: none">• Dehydration• Degraded communications• Degraded vision• More mistakes• Carelessness	<ul style="list-style-type: none">• Less clear thinking• Restricted field of vision• Degraded manual dexterity• Less concentration• Perceived respiratory stress
--	--

3. Impact of a Nuclear, Biological, and Chemical Environment on Operations

Since NBC weapons can be delivered by multiple means, all phases of military operations could be severely impacted. C², maneuver, fires, and communications can be impacted by operations in an NBC environment.

a. C². Because of physical and mental fatigue, leaders performance may be degraded.

- Leadership judgment and response to changing situations are less effective.
- Tasks dealing with accuracy of reports, coordination of fire plans, and issuance of OPORDs are degraded.
- Intelligence-gathering assets, such as scouts, are degraded, resulting in less timely and less-detailed information to the commander.

- Clarity and conciseness of OPORDs can diminish rapidly with leaders omitting essential items of information.
- Commanders required more time to prepare orders.
- Commander's plans for and control of direct and indirect fires deteriorated with time.
- Tactical commanders had a tendency to focus inward and were less aware of adjacent units.

b. **Maneuver.** Synchronization of tactical maneuver is more difficult in the NBC environment. Control of units, timing of operations, and the ability to adhere to the scheme of maneuver can be degraded. Specifically, units can incur additional risks when operating in an NBC environment. The additional risks (see Table V-6) can manifest themselves in many ways. For example, units may miss objectives (e.g., get lost) or lose more combat vehicles to enemy fire, so the ability to control units is degraded. Overall, the vulnerability of forces can increase the longer a unit operates in MOPP4.

c. **Fires.** The effectiveness of direct and indirect fires can decrease in an NBC environment. Target detection and acquisition is much more difficult. For example, personnel conducting target acquisition acquire targets at considerably shorter distances; land force, combat-fighting vehicles fire fewer rounds; and infantry-fighting vehicles tend to fight at closer ranges. Further, fewer small-arms engagements occur and less antitank missile rounds are expended. Other considerations include—

- Battle losses increase as units spend longer periods in NBC protection.
- The engagement range for direct-fire weapons decreases.
- Fratricide engagements increase.
- The battle intensity in the attack is considerably lower.
- The ability of indirect fire to support the direct-fire battle is degraded.
- The time to prepare and transmit live-fire requests for voice/digital transmission increase, and the time to prepare indirect weapons for firing takes longer.

Table V-6. Potential Risks From Operations in an NBC Environment

Actions	Results
Unit selected easier routes.	Units advanced on expected avenue of approach.
Unit used tighter formations.	Less unit dispersal.
Unit was hesitant to be aggressive.	Less unit initiative.
Unit attacks took longer.	More unit casualties.
Unit conducted slower rates of travel.	Increased time to accomplish missions.
Unit fire effectiveness was decreased.	Unit loss exchange ratios decreased.
Unit demonstrated degraded ability to perform mission when buttoned-up.	Decreased combat team effectiveness.
Unit killed fewer threat targets during offensive operations.	Unit combat advantage degraded.
Unit intelligence collection assets (e.g., scouts) had difficulty seeing and hearing the enemy.	Unit target acquisition/intelligence collection degraded.
Individual/crew endurance was degraded (e.g., tank crews operating in hot weather in MOPP4 were not able to perform their mission longer than 3 to 6 hours).	Combat power decreased.

d. Communications. The effectiveness of communications, both face to face and via radio, can deteriorate in an NBC environment. Hearing and seeing are degraded. The specific impact of an NBC environment can include the following:

- Voice recognition diminishes, leading to repeated requests for call signs.
- Personnel use hand signals more often.
- Message length doubles.
- Number of radio messages increases.
- Longer transmission times increase vulnerability to enemy electronic warfare (EW).

4. Impact of a Nuclear, Biological, and Chemical Environment on Sustainment

Sustaining combat operations in NBC environments presents major challenges. Operations will be slowed and task performance, both complex and simple, can be encumbered by wearing IPE. Degradation can be found in all areas of sustainment, to include the establishment and operation of logistical sites, movement of supply vehicles, maintenance, and medical support.

a. Preparation. The impact of an NBC environment can result in less dispersal of forces and camouflage of vehicles. Setup of sites—such as Class III refuel points—takes

longer, key safety measures are not as closely followed, and units process fewer supply requests.

b. **Movement of Supply Vehicles.** Movement times for logistical packages increase. Drivers experience more fatigue and reduced dexterity, resulting in increased time to process supplies. Consumption of diesel fuel also increases due to greater distances traveled. More time is required to move to subsequent battle positions, resulting in overall slower rates of travel.

c. **Maintenance.** Operations are adversely impacted by poor communications and incorrect diagnosis while in MOPP4. For example, maintenance teams frequently do not carry appropriate tools to the work site, on-site repairs take longer, safety measures are not strictly adhered to, and maintenance is often deferred until MOPP levels are reduced.

d. **Medical Support.** Medical operations degrade due to fatigue and the reduced dexterity of medical personnel. The times required to conduct activities—such as setting up medical facilities, conducting triage, measuring patient vital signs, and administering medications—all increase. Also, surgical procedures cannot be performed in MOPP4. Therefore, COLPRO is required to continue medical support (surgical procedures) in a contaminated environment.

5. Executing Countermeasures

Military leaders know that all phases of military operations can be degraded by an NBC environment, but some areas are more degraded than others. If leaders know what to expect, they can moderate the expected degradation. Comprehending the effect of an NBC environment on the unit's mission accomplishment can be achieved through—

- Performing mission-essential tasks, such as C², regularly in MOPP4.
- Conducting target acquisition (TA) and identification for individual and crew-served weapons.
- Exercising communications functions to ensure effective and efficient results.
- Anticipating additional sustainment requirements—more water consumption, increased wear and tear on IPE, etc.
- Striving for simplicity in plans.
- Understanding the impact of MOPP4 on mobility.

a. **Unit Preparation.** Preparation for operation in an NBC environment is critical to successful operations. Preparation must emphasize individual/crew readiness. It is important that units focus on the performance of mission tasks under NBC conditions because it leads to improvements in performance and endurance of individuals and crews. Individuals learn which tasks can be performed in MOPP with little or no modification and which tasks require the development of work-arounds or deferment until MOPP can be reduced.

b. **Leader Preparation.** Leader preparedness for operations in the NBC environment is extremely important. For effective leader countermeasures, leaders should—

- Observe their personnel to learn and recognize the signs of serious physiological and psychological degradation.
- Use coping strategies to deal with physical and mental aspects of the NBC battlefield.
- Focus on the maintenance of high physical standards for all personnel to facilitate endurance.
- Assess unit status continually.
- Pace themselves and plan for rest and sleep periods, especially as the periods in MOPP4 extend.
- Rely on their staff more and allow subordinates more latitude, thus avoiding the tendency to micromanage.
- Focus on attention to detail when planning and developing OPODs and fragmentary orders (FRAGORDs).
- Plan for more efficient use of their time.

c. **Individual Preparation.** Readiness for the individual must focus on ways to effectively operate in an NBC environment. Individual preparation must include—

- Ensuring that NBC protective equipment is properly used and maintained.
- Understanding the need to drink adequate amounts of fluids and recognizing the symptoms of dehydration.
- Performing tasks in MOPP4 and doing so for extended periods of time.
- Recognizing the need to develop work-arounds for difficult tasks that must be accomplished. Individuals will share this information with their buddies and inform their leaders.
- Understanding the physiology and psychology of encapsulation in MOPP4.
- Understanding hyperventilation and developing breathing techniques while masked.
- Talking slowly and more clearly through the mask.
- Understanding and using work/rest cycles.
- Focusing on task completion versus time required.

d. Preparation for Crews, Teams, and Units. Because all tasks are degraded to some extent, the necessity for teams and units to maintain their unit cohesion and operational tempo (OPTEMPO) become critical. Key factors that should be considered include—

- Conducting tasks in MOPP4 for extended periods.
- Focusing on cross training of teams and crews.
- Using work/rest cycles and sleep periods for crew members.
- Emphasizing that basic survivability functions cannot be ignored, especially tasks such as cover and concealment.
- Developing buddy systems to keep a check on individuals within the unit to detect serious degradation.
- Using arm-and-hand signals to facilitate routine communications.
- Using a system of individual identification within the unit.
- Being aware that medical care capabilities are greatly reduced in a contaminated environment without COLPRO.

Chapter VI

INDIVIDUAL PROTECTION

1. Background

US military forces possess a wide array of the world's best, mission-oriented, individual NBC protective equipment. Using this equipment, armed forces of the US are equipped to conduct prompt, sustained, and decisive operations throughout the spectrum of conflict in any environment—NBC or otherwise. This chapter provides an overview of the individual protection capabilities that are available to US forces. See Appendix A for more detailed information on IPE.

Protecting the force consists of those actions taken to prevent or mitigate hostile actions against personnel, resources, facilities, and critical information. These actions conserve the force's fighting potential so that it can be decisively applied, and sufficient equipment must be available to protect not only the uniformed force, but also the essential supporting US and civilian workforce.

2. Mission-Oriented Protective Posture

Introduction. The MOPP ensemble protects against NBC contamination. It consists of the overgarment, mask, hood, overboots, and protective gloves. Before personnel can protect themselves against NBC hazards, they must first know the purpose of MOPP and the capabilities of the IPE that is available for their use during tactical operations. The types of IPE used depend on the protection required, but all fall within two major divisions: permeable and impermeable. Permeable clothing allows air and moisture to pass through the fabric. Impermeable clothing does not. An example of permeable protective clothing is the joint service lightweight integrated suit technology (JSLIST) protective overgarment. An example of the impermeable protective gear is the SCALP.

a. Protective Clothing.

(1) **JSLIST Chemical Protective Overgarment.** Over time, the JSLIST chemical protective overgarment (CPO) will replace its predecessor, the battle dress overgarment (BDO), as stocks become available. The JSLIST provides protection against liquid, solid, and/or vapor CB agents and radioactive alpha and beta particles. It is a lightweight garment and it can be laundered up to six times for personal hygiene. The JSLIST ensemble will be worn in all environments when under threat of an imminent NBC attack and after chemical operations have been initiated. See Table VI-1 (page VI-2), for information on the JSLIST CPO capabilities.

Table VI-1. Protective Clothing Capabilities

Protective Clothing	Service Life (Out of Bag)	Wear Time	Wear Time Once Contaminated	Launderable/ Decontaminate
JSLIST	120 days	45 days	24 hours	Yes (6 times)/No
BDO	22 days*	22 days	24 hours	No/No
CPU	15 days	15 days	12 hours	Yes (1 time)/No
Saratoga Suit	30 days	30 days	24 hours	Yes (6 times)/No
CP Suit (MK III)	30 days	30 days	6 hours	No/No
CP Glove Set	N/A	N/A	24 hours (14/25 mil) 6 hours (7 mil)	No/Yes
GVO/BVO/MULO/ CPFC	N/A	N/A	24 hours	No/Yes
STEPO	5 contamination/ decontamination processes	4 hours	4 hours	Yes/Yes
SCALP	N/A	N/A	1 hour	No/No
* The BDO service is 22 days; however, the commander can authorize increased wear time up to 30 days (at a slightly increased risk).				

(2) **Chemical Protective Undergarment.** The chemical protective undergarment (CPU) is worn under an approved uniform as part of an entire ensemble. The CPU provides protection against CB agents, agent vapor, liquid droplets, and radioactive alpha and beta particles. The CPU is not a stand-alone garment. It is worn under the standard duty uniform, such as the battle dress uniform (BDU). The CPU is not intended to be worn under the JSLIST or BDO. The CPU is donned when personnel are directed to go from MOPP0 to MOPP1. When the CPU is used, the protection afforded is equivalent to that provided by a MOPP3 or 4 ensemble. See Table VI-1 for information on CPU capabilities.

(3) **Battle Dress Overgarment.** The BDO provides protection against chemical-agent vapors, liquid droplets, biological agents, and radioactive alpha and beta particles. The BDO is normally worn over the duty uniform; however, during high temperatures, it may be worn over underwear. See Table VI-1 for information on BDO capabilities.

(4) **A/P22P-9A (V) Below-the-Neck Protective Assembly (USN/USMC).** The A/P22P-9A (V) below-the-neck protective assembly provides a protective ensemble that includes undergarments, footwear covers, gloves, and a cape to protect aircrew personnel from liquid CB contamination or radioactive particles. See Appendix A for more detailed information.

(5) **Wet-Weather Clothing.** Wet-weather clothing consists of a parka and overalls. The system is designed to protect against all liquid chemical warfare agents in a cold and/or wet climate both ashore and aboard ship. The system can be worn over the CP ensemble for additional protection and to prevent soaking the wearer. See Appendix A for more information on wet-weather clothing.

(6) **Chemical Protective Suit OG MK III (USN).** This overgarment protects the wearer against all known CB agents that present a percutaneous hazard. The suit consists of a smock and a separate pair of trousers. This garment will be replaced Navy-wide by the

JSLIST. This suit protects against chemical-agent vapors, aerosols, droplets of liquid, and biological agents. See Table VI-1 for information on its capabilities.

(7) Chemical Protective Suit, Saratoga (USMC). Like the BDO, the Saratoga CP suit is an air-permeable, camouflage-patterned overgarment. The Saratoga protects against chemical-agent vapors, aerosols, droplets, and unknown biological agents and can be laundered for personnel hygiene purpose. See Table VI-1 for further information on its capabilities.

(8) CWU-66/P Aircrew Ensemble (USAF). The CWU-66/P is a one-piece flightsuit configuration that provides 24-hour protection against CB agents in vapor or aerosol form. It is less bulky than prior ensembles, offers a reduced thermal load burden, and is compatible with aircrew life support equipment. This ensemble is permeable. If the clothing becomes contaminated, the garments are disposed of following doffing procedures. Contaminated garments cannot be reused or laundered to remove contamination. Tracking the days of wear for permeable protective clothing is important. Personnel can annotate the number days of wear by different methods. One way would be to annotate the number of days of wear on the white clothing tag on the inside of the jacket.

(9) Suit, Contamination Avoidance, Liquid Protective. The SCALP is an impermeable, lightweight, inexpensive, disposable ensemble that can provide supplemental liquid protection when worn over a standard CPO. Operationally, the SCALP is worn by personnel who may by necessity, be forced to leave COLPRO under chemical attack to perform some vital maintenance or reconnaissance function. If contaminated by chemicals, the SCALP can be discarded to reduce reentry time. A secondary use of the SCALP is to protect decontamination personnel from being soaked during decontamination operations. See Appendix A for more information on the SCALP.

(10) Chemical Protective Glove Set. A glove set consists of an outer glove for protection and an inner glove for perspiration absorption. The outer gloves are made of an impermeable, black, butyl rubber. The inner gloves are made of thin, white cotton. The inner gloves can be worn on either hand. When engaged in heavy work or during cold weather, personnel should wear standard work gloves or black shells over the butyl rubber gloves to protect them from damage. See Table VI-1 for information on their capabilities and Appendix A for more detailed information.

(11) Green Vinyl Overboot (GVO); Black Vinyl Overboot (BVO); and Multipurpose, Lightweight Overboot (MULO). The GVO, BVO, or MULO can be used to protect the wearer against NBC agents and environmental effects (rain, mud, or snow). See Table VI-1 for information on overboot capabilities and Appendix A for more detailed information.

(12) Chemical Protective Footwear Cover. The impermeable chemical protective footwear cover (CPFC) protects feet from CB agents and radioactive alpha and beta particles. See Table VI-1 for information on CPFC capabilities and Appendix A for more detailed information.

(13) Chemical Protective Helmet Cover. The CP helmet cover is intended to provide the personnel armor system ground troop (PASGT) helmet with protection from CB

contamination and radioactive alpha and beta particles. See Appendix A for more information on the helmet cover.

(14) Self-Contained, Toxic-Environment Protective Outfit (STEPO). The STEPO is a totally encapsulating system that provides protection for personnel working in highly toxic, unknown, or oxygen-deficient environments that are immediately dangerous to life and health. STEPO protects the wearer against a wide range of industrial chemicals; petroleum, oil, and lubricants (POL); and CW agents. The impermeable STEPO CP suit provides protection against hazardous liquids, solids, and vapors. STEPO provides a choice of breathing apparatuses to accommodate the user and mission requirements. The system also includes a personal cooling system to reduce heat stress and a communication system to enable communications between team members and support personnel.

b. Other Protective Ensembles. Protective masks keep wearers from breathing air contaminated with NBC warfare agents. Masks are available in these categories: field protective masks, M40 and MCU-2A/P; combat vehicle mask, M42; aircrew masks, M45, MBU 19/P, A/P 23P-14A(V) (helicopter only), and A/P 22P-14(V) 1-4 (Marines fixed wing only); and special-purpose masks. These protective masks are not authorized for use during industrial chemical spills. Chemicals of that nature normally require a SCBA. Protective masks are not effective against chemicals such as ammonia or carbon monoxide, and they are not effective in confined spaces when there is insufficient oxygen to support life. See Appendix A for descriptive information about protective masks.

(1) Protective Masks. The fielded masks provide users with respiratory, eye, and face protection against CB agents and radioactive fallout particles. A properly worn and fitted protective mask provides a gas-tight face seal, which prevents unfiltered air from reaching the wearer's respiratory system.

(2) Proper Fit. Determining the proper fit for an individual's protective mask is critical. A small percentage of service personnel cannot be adequately fitted with the authorized protective mask. Test systems are available to determine if service personnel have properly fitted masks. If not, the Army and Air Force will then use the M45 CB mask to try and properly fit the hard-to-fit service member. If the service member still cannot be properly fitted with a protective mask, the individual may not be deployable to an AO with a CB threat. See applicable service TMs, technical bulletins (TBs), and TOs for specific instructions on hard-to-fit personnel.

(3) Prescription Mask Inserts. Individuals requiring corrective eyewear must have prescription mask optical inserts for their protective masks. The optical inserts require proper placement in the mask to provide maximum clarity and field of vision. See Appendix I for description of prescription optical inserts for the protective mask.

c. Other IPE. Other critical IPE material includes medical items (i.e., skin exposure reduction paste against chemical warfare agents [SERPACWA], NAAK, etc.), individual decontamination kits, and chemical detector paper. See Appendix A for descriptions of these items.

d. Radiological Protection. See Appendix D for information on OEG, LLR exposure, DU, and Appendix J for information on EMP protection considerations.

3. Individual Protection Logistics Considerations

To meet sustainment requirements for operations under NBC conditions, commanders must ensure responsiveness to unit requirements. Units (or authorized storage locations) will stock specific authorized quantities of NBC defense equipment for service member use as specified in service-specific authorization documents. For example, a forward deployed unit, such as a carrier battle group or a USMC expeditionary unit, may require both sets of MOPP gear to be immediately available based on the threat. Conversely, land forces may require that one set of IPE be carried as part of an individual's field gear and a second set of IPE be maintained by the unit logistics base. This is, again, based on the threat. Other sustainment techniques or procedures are contained in service logistics publications.

a. Resupply of additional sets of MOPP gear into combat-configured loads can be accomplished by methods such as palletizing the needed IPE. The intent of palletizing IPE is to create a push package that can either be broken down at an arrival location (airfield or seaport) for immediate issue to units or for further movement forward. The method of palletizing and movement depends on the types of units and how each performs its mission.

b. Logistics planning and push package configurations will vary based on the unit general deployment plan or contingency mission and the likelihood of an NBC threat in an AO. All this is integrated and executed through service logistics channels. These items will be moved based on certain time lines dictated by the OPLAN and on events that may occur during the operation.

c. Other key logistics/sustainment considerations include—

- Anticipating resupply and replacement requirements for IPE.
- Monitoring serviceability for items, such as overgarments, that have specific shelf lives (i.e., expiration dates).
- Monitoring serviceability of IPE stockages. Some items, such as overgarments and/or mask filter canisters, are issued by lot number. Periodic surveillance by the material developer can result in certain lots being reclassified for training use only.
- Tracking days of wear of overgarments (once they are removed from their bags).

d. Operational planners and supporting logisticians coordinate to provide sufficient quantities of IPE. For example, additional sets of IPE may be issued to designated mission-essential HN personnel, foreign military, and/or other nongovernment personnel.

4. Toxic Industrial Material Individual Protection

Background. Military personal protective clothing and equipment and the protective mask are designed to protect personnel from NBC agents in a combat environment, but provide only limited protection from some of the TIC. Personnel equipped with standard military personal protective clothing must not remain in a TIC environment and should seek a clean area as soon as possible.

a. Respiratory Protection. Proper selection and wear of approved IPE can provide the required respiratory protection. This may be achieved by air purification devices or by atmosphere-supplying respiratory equipment, such as the SCBA. The air-purifying masks should never be worn in the presence of unidentified contaminants or in atmospheres containing less than 19.5 percent oxygen. This limits the use of these devices in some emergency response operations. The two types of respirators, the SCBA and the supplied-air respirators (SARs), provide personnel with a source of air that creates a positive pressure in the facepiece. These respirators permit the individual to operate in low-oxygen and volatile chemical atmospheres where an air-purifying respirator does not offer enough protection. The SCBA is most commonly used in emergency operations, and the SAR is used when extended work times are required. These devices will provide the responder with the greatest protection against exposures to gases and vapors.

b. Individual Protection Levels. There are four levels of protection established by the US Environmental Protection Agency (EPA) according to 29 Code of Federal Regulation (CFR) 1910.120. The Occupational Safety and Health Administration (OSHA) has also adopted these four levels. The level of skin and respiratory protection provided by the selected CP ensemble determines the protection that is furnished to the responder. The levels of protection are divided into four categories (Levels A, B, C, and D) and worn according to guidelines published by OSHA and the National Fire Protection Agency (NFPA). Personal protective equipment (PPE) places an increased level of mental and physiological stress on individuals (e.g., heat stress and respiratory resistance), which must be carefully monitored and evaluated through all phases of an operation. See Appendix A for descriptions of protection Levels A through D.

Chapter VII

COLLECTIVE PROTECTION

1. Background

Protection from NBC weapons is needed when there is a chance of NBC contamination to individuals or groups of personnel. There are two components of NBC Protection—individual protection and COLPRO. COLPRO is that protection provided for personnel to carry out functions without being restricted by protective clothing. Joint Publication (JP) 1-02, *Department of Defense Dictionary of Military and Associated Terms*, describes COLPRO as facilities or systems equipped with air filtration devices and air locks to provide personnel with a toxic-free environment for performing critical work and obtaining rest and relief in order to sustain combat operations. COLPRO is provided through a facility or the integral portion of equipment design whereby individuals or groups may be afforded protection. The term COLPRO applies to buildings, facilities, or ships modified to afford protection; pieces of equipment (in their entirety or in part); or vehicles designed to provide NBC protection. COLPRO usage is characterized by the requirement for an individual or group to execute specific actions, such as donning or doffing equipment, entering a facility, or closing openings in order to derive the benefits of COLPRO. COLPRO provides a safe environment for individuals to carry out tactical functions—such as weapons employment, medical care, C², and communications—without being restricted by wearing the full set of NBC protective clothing. This chapter addresses COLPRO planning considerations and the types of COLPRO; and it discusses fixed-site, transportable, mobile, and Navy COLPRO systems. See Appendix B for further information on preparing a COLPRO SOP, entry and exit procedures, and guidance on shelter preparation and operation. See FM 8-10-7, *Health Service Support in a Nuclear, Biological, and Chemical Environment*, for information on the employment of CP systems as MTFs.

2. Planning for Collective Protection

COLPRO is an important aspect of NBC defense. It does not replace MOPP gear, but it allows the commander to reduce MOPP levels while in a contaminated environment. COLPRO supports four primary areas that erode quickly in an NBC environment—task performance, medical care, personnel rest/relief, and sustained operations. Commanders understand that COLPRO requires training of personnel in doffing and donning procedures to enter and exit shelters. Commanders who understand the trade-offs associated with COLPRO can more accurately plan for the effective and beneficial use of CP systems. To properly utilize COLPRO, it must be fully integrated into the commander's overall plan. Avoiding contaminated areas or displacing from contaminated terrain is desirable, but neither is always possible. It may be necessary to cross, occupy, or remain in contaminated terrain. These situations require COLPRO.

a. General Planning Considerations.

(1) The commander must consider the threat, mission, tactical environment, and type of COLPRO available in his planning process. The following factors should be considered in the planning process:

target?

- Does the function occupy a location that is considered to be a high-risk target?
- How long is the facility or area likely to be subject to an NBC hazard?
- Do demands of operations require remaining in the hazard area?
- Can the mission be accomplished in the hazard area without

COLPRO?

(2) Regardless of the type of COLPRO, the commander's planning must address supply, maintenance, gas and particulate filters, and contaminated-filter disposal.

- **Supply.** Adequate supply planning is a key element in the effective use of CP systems. Most systems are not supply-intensive; however, the operation of such systems requires a continuous resupply of consumable and expendable items. Included are items that provide a means of vulnerability reduction such as rain gear, ponchos, and plastic bags. These will keep liquid contamination away from the overgarment. Survival under NBC conditions could depend on these items. Therefore, it is not a question of merely maintaining special-purpose COLPRO supplies, it is a matter of obtaining needed quantities of existing supplies. Arrange to have supplies to support extended operations of a fixed shelter kept inside the shelter, if possible. Plan for the needed supplies, and stockpile them before an attack. As a minimum, these supplies should include protective clothing, expedient contamination avoidance items, decontamination kits, detector kits, and filters. These items will allow shelter users to conduct a protective uniform exchange. Provide adequate food and water if the shelter will operate for long periods within the contaminated area. If the shelter requires fuel, ensure that it is requisitioned and stored. If the system has an external power supply, store fuel outside and away from the shelter. Plan for supplies to maintain operations inside the shelter.

- **Maintenance.** In most cases, the maintenance of CP systems is minimal at organizational levels. Most systems have little or no operator maintenance other than before-, during-, and after-operation checks and services. Operators may need to reset circuit breakers or perform system start-up procedures. At the unit level, maintenance is usually limited to troubleshooting and removing and/or replacing major components or subassemblies. Changing expended or contaminated filters is the most significant maintenance task. Both the gas and particulate filters require periodic replacement. (See applicable service technical publications for information on when to replace filters.)

- **Gas and Particulate Filters.** The useful life of a gas filter decreases as operating time and exposure increase. As the filter removes contaminants from the air, its residual capacity decreases. Long exposure to moisture also decreases filter capacity for removing chemical agents. Gas filter life expectancy varies. It depends on the size and design of the COLPRO hardware. To determine when to replace a gas filter, the shelter attendant or another responsible person must maintain a log of the filter unit operation. Then, personnel should change gas filters according to the TM. In general, new filters can withstand several chemical attacks. In most cases, missions of 48 to 72 hours can be accomplished in a contaminated environment without a filter change. Given this capacity,

filter change during periodic unit maintenance is often advisable. See applicable service TOs or TMs for information on defined intervals for changing filters. Within the filter, a particulate filter collects radiological contamination and other particles from the air. Such accumulation on the filter does not decrease its filtering efficiency. It does, however, decrease the airflow because of the increase in resistance. In most cases, this increase in resistance is very gradual. It is unusual for the airflow resistance to increase to a level that affects the flow rate appreciably. Personnel should replace this filter at the same time they replace the gas filter or when the system drops below the minimum overpressure level specified in the system TM.

- **Contaminated-Filter Disposal.** Filters do not decontaminate or neutralize contamination; they merely collect and contain it. Therefore, contaminated filters are hazardous. Replacing and disposing of these filters require care to prevent a hazard to personnel or a spread of contamination. Commanders should establish detailed procedures for filter disposal during peacetime and wartime situations according to applicable TMs/TOs. Some methods of contamination disposal, such as burning, create additional contamination (see warning below) and do not destroy radiological contamination. The disposal method selected (e.g., containerization) should minimize any spread of contamination.

WARNING

Burning filters contaminated with chemical agents or toxins may produce a downwind vapor hazard. Warn units downwind. After burning, cover the ashes with the excavated dirt and mark the site with contamination markers. Disposal of any filters after normal maintenance in peacetime also requires special handling and disposal of these as hazardous waste. This includes all masks filters and canisters and CPE filters. Material must be transported, stored, treated, and disposed of as such.

b. **Manpower.**

(1) **Manpower planning for CP systems** encompasses several factors. Commanders estimate these requirements based on multiple factors that may include—

- **Setup and teardown times.** Consider the setup and teardown times. Actual times will vary with the situation, system, and degree of training. For example, it takes two persons in MOPP4 approximately 30 minutes to set up the simplified collective protective equipment (SCPE) and 10 minutes to tear it down.
- **Entry times.** Commanders should estimate entry-processing times for units based on the estimated time for MOPP gear doffing and patient decontamination.
- **Shelter security.** Commanders must ensure that security is maintained around any protective shelter. Security requirements depend on the tactical situation. The type and strength of a security element depends on the type of operation being conducted, the location on the battlefield, and the personnel available to protect the

shelter. Shelters with high entry/exit traffic require attendants. Post attendants at the shelter entrance to control entry. They should also assist in the external operations of the shelter. Exact duties during and after an NBC attack should be outlined in the unit SOP.

(2) Other requirements, such as communications, are also a routine part of the commander's planning. Some of these requirements may be system-specific, while others may apply to all systems. They may include—

- Communications. Personnel should use the communication systems to communicate with others in adjacent fixed or transportable shelters or immediately outside the shelter.

- Latrines. CPSs may include sanitary facilities. If the shelter is in a permanent structure, use the existing facilities. Consider the location of existing sanitary facilities when selecting a portion of the building for an individual relief facility. Where water and sewage facilities are not available, provide covered containers or chemical toilets.

- Illumination. Have lights installed if power is available, and provide battery-operated lights for emergency use. Keep the electric light usage to a minimum to prevent excessive heat buildup in the shelter. An alternative would be to use cold light sources such as chemical safety lights. Take blackout precautions where required.

- Camouflage. Construct or emplace shelter sites in areas that provide cover and/or concealment.

- Water. Have filled canteens or other water containers placed inside the shelter. Provide each occupant at least three quarts of drinking water for each day of anticipated occupancy. Even if piped water is available, maintain an emergency reserve of drinking water. Additional water may be needed for hygiene.

- Warning and Detection. Plan for warning and NBC detection devices in each protective shelter. These devices serve several purposes. They can detect an NBC attack and/or determine if the shelter interior is contaminated. These devices also monitor personnel going through decontamination. In addition, they can warn of shelter system failure.

c. Types of COLPRO. To support COLPRO planning, there are different types of COLPRO. They are categorized according to their tactical application, interface with tactical equipment, and mobility. The categories are fixed-site, transportable, and mobile. Fixed-site COLPRO includes those facilities not intended to be moved; and they are hardened, semihardened, or unhardened. Transportable shelters can be sited where needed, can be moved as required, and are generally unhardened. Mobile COLPRO includes those facilities, either armored or soft-skinned, that may or may not be capable of being used on the move and may not have integrated air locks or CCAs.

3. Fixed-Site Collective Protection

Fixed-site COLPRO is generally found at those locations where permanent base operations exist. At those fixed sites, such as air operations bases, critical functions, such as C² must be maintained. Thus, fixed-site COLPRO occupies a critical role in the planning process and in responding to an NBC attack. (See references such as FM 3-11.34/Marine Corps Warfighting Publication [MCWP] 3-37.5/Naval Warfare Publication [NWP] 3-11.23/ and Air Force Tactics, Techniques, and Procedures Interservice [AFTTP (I)] 3-2.33, *Multiservice Tactics, Techniques, and Procedures for NBC Defense of Theater Fixed Sites, Ports, and Airfield*, for further details on COLPRO for fixed sites.)

a. Background. Fixed-site COLPRO is categorized as active or passive, according to the type of facility and the equipment available. Active protection requires a high-efficiency air filtration unit and a tightly constructed building or shelter. This system provides the highest levels of NBC protection for long periods. Figure VII-1 depicts a typical basic CPS design using overpressure and air locks. With passive applications, the building or shelter acts as a protective barrier by limiting the exchange of air between indoors and outdoors. The lesser amount of air that passes (the exchange rate), the greater the protection afforded.

b. Planning Considerations.

(1) Commanders should consider a number of factors in planning for the installation or upgrade of fixed site COLPRO facilities. For example, COLPRO systems employ a filter unit capable of removing agents from the air being circulated through the filter and, as a general rule, also employ some type of temperature management system for the comfort of the personnel in the shelter.

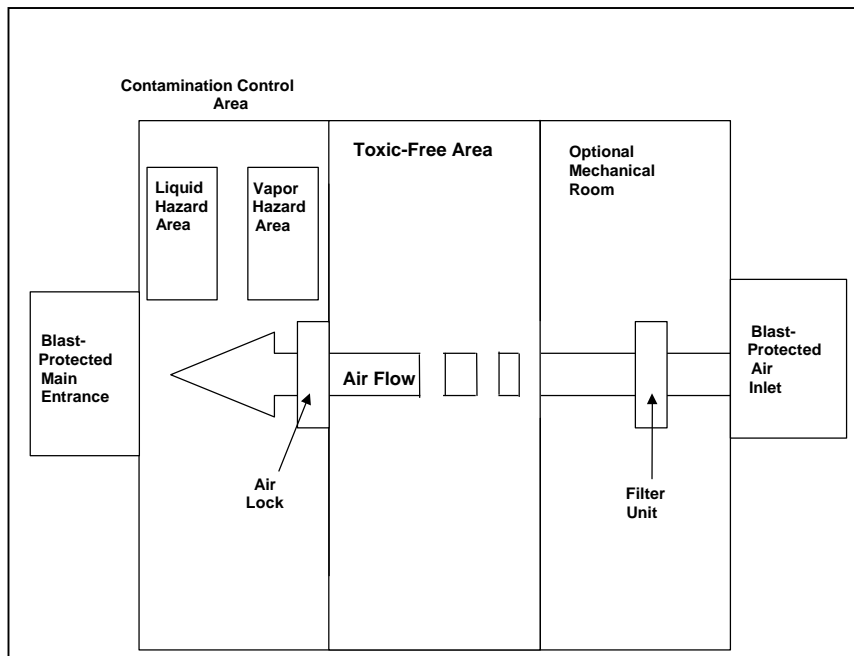

Figure VII-1. General Layout for an NBC Shelter

(2) A building or other facility employed as a CB shelter can be likened to a leaky boat. The safety afforded depends on the rate of leaks—in this case, leaks of air. The rate of leaking in relation to its volume is the air exchange rate, which is the rate of uncontrolled exchange of air between the inside and the outside. This air exchange rate determines how rapidly airborne contaminants infiltrate the structure from the outside and how rapidly they are purged from the building once the outside air is no longer contaminated.

(3) Air exchange rates vary, not only from structure to structure but also for a given structure over time. Some of the variables which influence air exchange rates are—

- Wind Velocity and Direction. The air exchange rate increases as wind speeds increase. Wind produces a pressure difference between the outside and inside, causing air to infiltrate through the windward side and exfiltrate on the opposite walls.
- Inside-Outside Temperature Differences. As the inside-outside temperature difference increases, the air exchange rate increases. This difference is manifested in pressure differences on the walls and doors according to height, which increases the stack effect of agent infiltration.
- Ductwork Systems. Openings and crevices around heating, ventilation, and air-conditioning (HVAC) ductwork provide a major pathway for infiltration, along with increases in air exchange rates when the system is operating.
- Combustion. The combustion process of heating a structure increases the air exchange from the outside into the structure.
- Seasonal Variations. Air exchange rates are highest in the winter and lowest in the summer. Building materials contract and expand due to moisture and temperature changes.
- Upstairs/Downstairs. Air exchange rates can be higher downstairs than upstairs, and higher agent concentrations will likely occur on lower floors.
- Room Variations. Air exchange rates vary among rooms due to structure design, construction materials, orientation to the wind, and the location of outside walls.

(4) CW experiments demonstrated that over time, the dosage inside a building approaches the dosage outside if there is no substantial loss of agent to materials absorption. A closed building dampens the rapid fluctuations in concentration caused by the random variability inherent in atmospheric diffusion, protecting occupants from exposure to high peak concentrations. If the shelter exchange rate remains constant, it will take longer to purge the contaminant after a cloud has passed than it took for the contaminant to enter the building. At some point during the cloud or after it passes, the concentration inside may exceed the contamination level outside. Therefore, the building ventilation should be turned off prior to the arrival of a cloud (to minimize the intake of the agent) and activated after the cloud passes (to help rid the structure of any vapor).

c. Facility Suitability for COLPRO. In general, most facilities can be used for COLPRO. In some cases, extensive modifications will be required. Prior to the installation of systems, consideration must be given to the following:

(1) Tightness of facilities. The suitability of a building or shelter for positive-pressure COLPRO is determined by the leakage rate of the building. Ideally, the flow rate of filtered outside air to achieve a required overpressure should be no more than that needed for the health and comfort of the occupants (e.g., 20 cubic feet per minute [CFM] per person). Building tightness can vary greatly with the condition of the building and its design defects, such as unsealed construction openings, drop ceilings, and false walls. Focus should be on reducing the air leakage from a building.

(2) Methods of tightening the building. When a collectively protected building is pressurized, its protection envelope must be tightened by closing all intentional openings (e.g., outside air vents, exhaust vents, windows, and doors). Other openings (e.g., cracks, crevices, joints, and penetrations for pipes and cables) must be closed to the maximum extent feasible. Caulking and weather stripping provide other means to tighten the structure.

d. Protective Entrances. A protective-shelter entrance provides an interface between the contaminated environment and the protected enclosure. It enables shelter users to remove contaminated clothing and perform decontamination procedures, providing them a relatively clean environment before entry into the shelter. See Appendix B for information on specific types of protective-shelter entrances.

e. Shelter Equipment. Generally, significant efforts are required to integrate filter units with HVAC systems. Often, the least costly approach for hazard reduction is to turn off the HVAC system and block the supply and return vents to the protected area when the system is pressurized. Such measures would likely require alternate heating or cooling methods. See Appendix B for information on shelter equipment that can be used to establish protective shelters.

f. Shelter Equipment Characteristics.

(1) Overpressure levels. The minimum overpressure recommended for stationary COLPRO shelters is 0.1-inches water gauge (iwg) or 25 pascals in entry areas and 0.2 iwg in the main shelter areas. This standard is based on preventing air infiltration at ambient wind speeds greater than 15 miles per hour (mph). At 15 mph, the wind reduces the concentration and dosage of mustard evaporating from the ground by about 98 percent, compared with calm conditions. When preparing buildings and conducting test measurements, it is advisable to provide for a higher pressurization (0.2 iwg) to ensure 0.1 iwg is still achieved over time, as sealing measures and building structures may deteriorate.

(2) CCA. The CCA and air lock allow people to transition from individual protection to COLPRO without introducing contaminants into the TFA. Personnel remove their contaminated outer garments in the CCA before entering the air lock. Permanent or interior CCAs have a filtered airflow rate sufficient to suppress vapor concentrations from contaminated garments worn into the CCA. Open-air CCAs have high airflow rates, but

the air may not be clean, filtered air. (Figure VII-2 shows a tent used as a CCA and attached to the air lock.) Vapor sorption or the adherence of agent vapors to surrounding materials/objects is the primary problem in most CCAs. See Appendix B for procedures on how to transfer into a TFA.

(3) Integration of NBC detectors. The agent vapors in the open-air CCA can actually adhere to the individual after he doffs the overgarment and before he enters the air lock. There are four options for detecting and dealing with this problem:

- Halt entry processing if vapor hazards are detected.
- Use a chemical detector to screen/halt the entry of candidates with desorbing vapor.
- Require removal of all garments if interior or exterior monitors detect vapor, and issue new or temporary garments inside the TFA.
- Combine showers with the previous options.

Note: Using M8 paper to check for contamination prior to shelter entry is undesirable as a preentry screening tool unless driven by operational requirements.

g. Classes of Fixed-Site COLPRO. For fixed-site COLPRO facilities, classes of protection are defined according to the degree of protection provided and the extent of the expected hazard. In addition to criteria for classification standards, the expected threat determines whether a protective system should be designed to operate continuously or on a standby basis. These classes are—

- Class I, pressurized shelters.
- Class II, intermediate shelters.
- Class III, passive shelters.

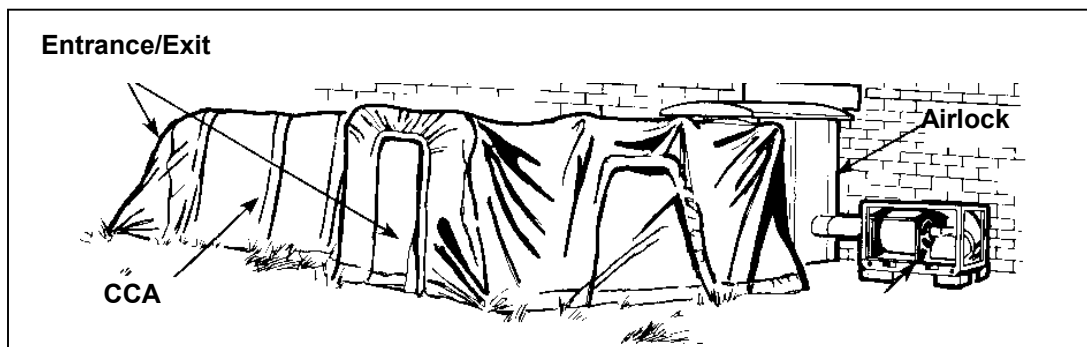

Figure VII-2. Tent Used as a CCA

h. Sheltering in Place.

(1) Background. Sheltering in place reduces but does not eliminate the risk of exposure to CB agents. Sheltering is an alternative to evacuation. Sheltering in place has a role in the commander's planning process because evacuation for some groups may not be feasible or possible. Adequate pressurized shelters may not be available. Likewise, the amount of forewarning of impending agent contamination may not be adequate for evacuation.

(2) Concept. The concept of sheltering in place is to go indoors (to higher floors, if possible), close all openings to the outside, and attempt to restrict the exchange of air from the outside to the inside. These preparations should be accomplished before the arrival of a contaminant cloud. Given adequate warning, additional measures should be taken, such as sealing openings with plastic sheeting and tape and use of IPE is still required to minimize the risk of exposure; however, not all personnel in the downwind hazard area (e.g., civilians) may have the required IPE. The amount of protection afforded by sheltering in place varies with the air exchange factors previously discussed. Based on the levels of sealing, there are four levels of sheltering in place:

- Normal sheltering. Close all windows and doors, and turn off all HVAC equipment.
- Expedient sheltering. Take rapid measures to enhance protection, such as taping doors, windows, and electrical outlets and placing rolled, wet towels at the bases of doors.
- Enhanced sheltering. Caulk joints, apply weather strips, install storm windows, and make other modifications to reduce air infiltration.
- Pressurized sheltering. Use gas-particulate filter blowers to increase the inside pressure so that it exceeds the outside pressure and provide filtered air.

(3) Expedient Sealing Measures. The procedures of expedient sheltering are based on an assumption that there are techniques that can be applied with little or no training and with commonly available materials to reduce the air exchange rate. Selecting and sealing one room can also provide a higher protection level by reducing the air exchange rate. Testing has indicated that a room sealed with plastic sheeting and tape provides 10 times the protection than sealing the entire house.

(4) Implementation. The implementation of sheltering in place requires planning to—

- Ensure that occupants know how to take protective measures.
- Determine that a CB release has occurred.
- Determine areas that may be affected by the release.
- Communicate a timely warning to all people in the affected areas.
- Communicate the appropriate time to vacate in-place shelters.

- Turn off the HVAC systems prior to the arrival of the cloud, and activate the HVAC systems after the cloud passes.

(5) Instructions. Basic guidance for sheltering in place includes three core steps: close windows and doors, turn off HVAC, and stay indoors and stand by for further instructions. Table VII-1 provides examples of instructions that can be used for sheltering in place.

Table VII-1. Sample Sheltering Instructions

<ul style="list-style-type: none"> • Measures Common to All. <ul style="list-style-type: none"> ⇒ Close doors and windows. ⇒ Turn off fans, heating, and air conditioning. ⇒ Stay in the room, and await instructions on when to evacuate. • Sealing Measures. <ul style="list-style-type: none"> ⇒ Place rolled, wet towels at bases of doors. ⇒ Close fireplace/heating register dampers. ⇒ Tape plastic over windows, doors, outlets, cracks, and heat registers. ⇒ Seal bathrooms. • Room Selection. <ul style="list-style-type: none"> ⇒ Use an aboveground room, not basements. ⇒ Select an interior room with few or no windows, no plumbing fixtures, and no air conditioners. • Complementary Measures. <ul style="list-style-type: none"> ⇒ Cover your mouth and nose with a damp cloth. ⇒ Close the bathroom door, and turn on the shower to wash the air. ⇒ Don protective clothing to exit shelter. • Measures to Minimize Leakage. <ul style="list-style-type: none"> ⇒ Minimize the use of elevators. ⇒ Ensure that all ventilation systems are set to “recirculate.” • Measures After the Cloud Has Passed. Open doors and windows to ventilate the building after the all-clear signal has been given. • Other Measures. <ul style="list-style-type: none"> ⇒ Keep the phone lines open. ⇒ Have a kit of essentials. ⇒ Stay clear of windows if the danger of explosion exists.
--

4. Transportable Collective Protection

Transportable COLPRO provides the commander with another means of providing a clean air shelter for use against CBR particles. Transportable COLPRO systems employ the principle of pressurized, purified air to provide a contamination-free environment in which to work. The system does not protect against gamma radiation or neutrons. The air pressure precludes the leakage of contaminated air into the enclosure. Personnel enter and exit through a protective entrance. The protective entrance is an air lock, which prevents contamination from entering the enclosure. Transportable COLPRO can be used for rest and relief, C², light maintenance, and MTFs.

- a. Modular COLPRO Equipment.

(1) Modular (transportable) COLPRO provides commanders with the flexibility to move COLPRO to sites where it is needed. The system includes an array of equipment, consisting of gas particulate filter units (GPFUs), protective entrances, and various installation kits.

(2) Modules can be grouped to provide space as dictated by the tactical situation. Modular COLPRO systems could include wheel or tracked vehicles, expandable vans, or a series of vans that are linked.

b. Transportable Systems. The commander decides whether to use transportable COLPRO assets. The basis for the decision is the determination that tasks, such as C² relief from MOPP gear, is mission-essential. When a CP system is used for rest and relief, the commander must ensure coordination of MOPP gear resupply and security. Shelters used for personnel relief and medical treatment require a great number of entry and exits. In addition, personnel must continuously monitor shelter operations. This monitoring ensures that the system functions properly and that no contaminants have entered the system.

(1) M20A1 Simplified COLPRO Equipment. The M20A1 SCPE is an updated version of the M20. Both systems are still in the inventory. The SCPE provides a clean-air shelter for use against CW and BW agents and radioactive particles. It is lightweight, is mobile, and allows unit commanders to convert existing structures into protected command, control, and operations centers. The SCPE can be used as a temporary rest-and-relief shelter (e.g., a break area for personnel working in heavy maintenance and supply operations or medical minimum-care wards at the combat support hospital [CSH]) or as a C² center. It provides a contamination-free environment in which 10 persons can work, eat, and rest without the encumbrance of the IPE. The M20A1 consists of a large, cylindrical-shaped liner designed to be inflated inside a room or building. A support kit contains a motor blower for inflation and flexible air ducts to direct the air. The M20A1 can be erected without the liner using only the protective entrance and blower compartment. A bib section is available that fits between the protective entrance and the frame of any door; and when taped down, it seals the entrance from outside contamination.

(2) M28 Simplified COLPRO Equipment. The M28 SCPE is a highly transportable COLPRO system used in conjunction with the tent, extendable, modular, personnel (TEMPER). The modular system consists of agent-resistant liner sections, a protective entrance, a tunnel air lock for litter patients, a hermetically sealed NBC filter canister, a recirculation filter, and a support kit containing a motor blower and ancillary equipment.

(3) TEMPER. This system provides the commander with the flexibility of tailoring COLPRO to the tactical situation. This modular shelter is available in sections that can be assembled to provide space as required. The M28 SCPE can be used to provide the required NBC protection. (Note: The vinyl-coated polyester fabric used in the TEMPER and most other military tents can cause false positive readings with the ICAM, especially in newly issued tents.)

(4) Chemically Protected Deployable Medical Systems (CP DEPMEDS). The CP DEPMEDS provides COLPRO to the core components of DEPMEDS CSHs. CP DEPMEDS will provide a clean, toxic-free, environmentally controlled patient treatment

area necessary to sustain medical operations in toxic environments. CP DEPMEDS accommodates an NBC casualty surge and provides environmental control, while maintaining the ability to resupply during a 72-hour mission. In addition, CP DEPMEDS provides NBC-protected water and low-pressure alarms and contains lavatory/latrine facilities for patients and staff.

(5) The Chemical and Biological Protective Shelter (CBPS). The CBPS provides an environmentally controlled, toxic free work area. The shelter can serve as a battalion aid station, a clearing station, and a forward surgical team treatment facility in a contaminated environment. The shelter is transported on a high-mobility, multipurpose, wheeled vehicle (HMMWV). It has a 300-square-foot tent that are supported by air beams that are inflated with air to form a semicircular shape that can be rolled and transported. The vehicle provides power to support system operation.

5. Mobile Collective Protection

Mobile CPE provides protection to a group of individuals under NBC conditions. Table VII-2 depicts the types of mobile COLPRO systems found on vehicles and aircraft. Personnel in mobile CPE are protected and may operate at the reduced MOPP levels shown in Table VII-3 (page VII-14). When an attack occurs, those personnel who are not protected by COLPRO should activate the CP system and assume MOPP4. They must remain at that level until the shelter interior is purged. Required purge times vary with the interior shelter volume and the airflow. Check specific technical publications for each system. When the required purge time passes, personnel should follow unmasking procedures. When the all-clear signal is given, personnel may resume the modified MOPP levels shown in Table VII-3 (page VII-14).

a. Mobile COLPRO Systems (Air/Land). There are four basic types of air and land mobile COLPRO systems. The types are classified according to the degree of protection they provide and the manner in which they are integrated into the host system. They include ventilated-facepiece, overpressure, hybrid, and total systems.

(1) Ventilated-Facepiece Systems. Ventilated-facepiece systems supply filtered air to the protective-mask canisters. The systems are designed to connect to GPFU and are rated by their airflow capacity in CFM. The components of these systems are similar. The filtered, pressurized air supplied to individuals extends MOPP gear capabilities. It reduces breathing resistance through the masks, and it aids in sweat evaporation. In addition, it can provide warm air to facepieces in cold weather.

Table VII-2. Types of COLPRO Systems

System	Description	Conditions Justifying the Requirement	Sample Systems
Ventilated-Facepiece	A series of individual respiratory systems for masks serviced by a common filter.	<ul style="list-style-type: none"> • Clean working area subject to inadvertent entry of contamination. • High work rate and reduced breathing system. • Frequent entry/exit movements. • Brief inside occupation. 	<ul style="list-style-type: none"> • IPVs. • Self-propelled howitzers.
Overpressure	A collective NBC filter, overpressure, and ventilated-facepiece system.	<ul style="list-style-type: none"> • Critical manual dexterity skills. • Limited entry/exit movements. • Lengthy inside occupation. 	<ul style="list-style-type: none"> • Air defense. • Communications. • Medical. • Patient evacuation vehicles • Maintenance and supply sites. • Rest and relief.
Hybrid	A combination of the overpressure and ventilated-facepiece systems.	<ul style="list-style-type: none"> • Flexibility. • Lengthy inside occupation. • Emergency entry/exit movements. 	<ul style="list-style-type: none"> • Armored fighting vehicles (tanks). • Helicopters. • Air defense. • Multiple launcher rocket systems.
Total	A hybrid or an overpressure system plus an environmental control system. Other categories may also incorporate environmental control; for example, a ventilated facepiece and microclimatic cooling.	<ul style="list-style-type: none"> • Flexibility. • Lengthy inside occupation. • Emergency entry/exit movements. • Extreme climates. 	<ul style="list-style-type: none"> • Armored fighting vehicles (tanks). • Helicopters. • Air defense. • Multiple launcher rocket systems.

(2) **Overpressure System.** An overpressure system is an enclosure of pressurized purified air. Gas and particulate filters remove any NBC contamination from the air. The air pressure precludes leakage of contaminated air into the enclosure.

Table VII-3. COLPRO MOPP Levels

Ventilated Facepiece	Overpressure
Assume MOPP0.	Assume MOPP0. Turn overpressure off.
Assume MOPP1	Assume MOPP1. Turn overpressure on.
Assume MOPP2.	Assume MOPP0 or 1. Turn overpressure on. Conduct entry and exit procedures if an attack occurs.
Assume MOPP3 or 4. ¹ When mounted, connect the ventilated facepiece to the mask.	Maintain MOPP0 or 1 unless the interior is contaminated. Turn overpressure on. Conduct entry and exit procedures if an attack occurs.
Assume MOPP3 or 4. ² When mounted, connect the ventilated facepiece to the mask.	Maintain MOPP0 or 1 unless the interior is contaminated. Turn overpressure on. Conduct entry and exit procedures if an attack occurs.
<p>¹During an engagement, the commander may allow personnel protected for liquid agents to operate temporarily without protective gloves. This option could slightly increase the potential for casualties. Normally, personnel in COLPRO facilities will don their protective masks (at least) during an attack until it is verified that the integrity of the shelter or filtration system was not damaged.</p> <p>²MOPP gear could include the JSLIST. If the JSLIST is worn at the appropriate MOPP level, pull the hood over the head and secure the mask. Close the slide fastener completely, and secure the hook-and-pile fastener up to the top of the slide fastener. Place the edge of the hood around the edge of the mask, and secure the hook-and-pile fastener.</p>	

(3) Hybrid System. Hybrid systems combine positive pressure and the ventilated facemask inside the enclosure with the option of using positive pressure, the ventilated facemask, or both. The positive pressure reduces the amount of vapor contamination that enters. If contamination enters, the system helps purge the interior of toxic vapors.

(4) Total System. A total system combines overpressure and environmental control to provide a pressurized, cooled, NBC-protected environment not dependent on individual protection. Cooling reduces heat stress for personnel operating in extremely hot and/or humid conditions. MOPP gear significantly increases the potential for heat stress, making cooling systems desirable. Crew compartment cooling provides air-conditioning to the compartment, and individual cooling proves effective when used while MOPP gear is worn. The choice of cooling systems depends on the vehicle type and the primary mission. The overpressure and cooling systems reduce heat stress casualties; however, they increase the logistical burden, primarily because of maintenance. Vehicles such as the M1A1 Abrams main battle tank (MBT) have overpressure systems. In addition to the overpressure system, the crews are provided a ventilated facepiece. During closed-hatch operations, the system provides positive pressure and crew cooling. During open-hatch operations, the system provides cool, filtered air to the ventilated facepiece and the cooling vest. During open-hatch

operations, personnel must be masked before exiting the vehicle to prevent any possibility of chemical agent exposure. Additionally, during open-hatch operations, the system provides modest overpressure that significantly reduces the amount of contamination infiltrating the crew compartment. Consequently, the time required to purge contamination is reduced.

b. Risk Assessment. Commanders must carefully plan for both the benefits of COLPRO and for the additional restrictions and limitations placed on the individuals and crews by its use. Depending on the type of COLPRO, individuals and crews can work longer and more comfortably while in COLPRO, thus increasing the efficiency and combat capability of the individuals or crews. The commander must, however, understand the restrictions imposed by employing COLPRO and the loss of system efficiency and capability due to the time and procedures required to employ it. Additionally, the restrictions on personnel dexterity, vision, and task performance and the time and effort required to enter and exit from a system in a contaminated environment must be considered. Table VII-4 shows the advantages and disadvantages of various mobile COLPRO systems.

Table VII-4. Advantages and Disadvantages of COLPRO Systems

System	Advantages	Disadvantages
Ventilated-Facepiece	<ul style="list-style-type: none"> • Reduces stress from breathing resistance. • Reduces eyelens fogging. • Allows open-hatch operations. • Increases the protection level of the mask. 	<ul style="list-style-type: none"> • Requires the use of MOPP gear. • Does not protect vehicle interior from vapor contamination.
Overpressure	<ul style="list-style-type: none"> • Allows reduction of MOPP level. • Reduces vapor concentration inside the vehicle. • Can provide relief from continuously wearing MOPP gear. 	<ul style="list-style-type: none"> • Requires closed-mode operations for safe unmasking. • Requires entry and exit procedures. • Increases logistical support requirements.
Hybrid (Overpressure Mode)	<ul style="list-style-type: none"> • Allows reduction of MOPP level. • Reduces vapor concentration inside the vehicle. • Can provide relief from continuously wearing MOPP gear. 	<ul style="list-style-type: none"> • Requires closed-mode operations for safe unmasking. • Requires entry and exit procedures. • Increases logistical support requirements.
Hybrid (Ventilated-Facepiece Mode)	<ul style="list-style-type: none"> • Reduces stress from breathing resistance. • Reduces eyelens fogging. • Allows open-hatch operations. • Increases the protection level of the mask. 	<ul style="list-style-type: none"> • Requires the use of MOPP gear. • Does not protect vehicle interior from vapor contamination.
Total	<ul style="list-style-type: none"> • Reduces heat stress casualties. 	<ul style="list-style-type: none"> • Increases logistical burden, primarily maintenance.

6. Navy Collective Protection Systems (Surface Ship)

COLPRO is the use of shipboard equipment and operations to provide a toxic-free environment. COLPRO aboard surface vessels depends on the type of vessel. In general, those vessels in which some type of COLPRO is installed will have either portions of the vessel or the entire vessel adapted for COLPRO.

a. Ventilation Systems. All ships have ventilation systems that provide fresh air throughout the vessel. Ship ventilation systems are effective in stopping large particles but are ineffective in stopping aerosol and vapor contaminants. The entry of these contaminants can be minimized by shutting as many closures as possible. One countermeasure, Circle William, which is the closure of all outside openings, is taken to prevent contaminants from entering the compartments. Even when countermeasures have been taken, it is likely that some vapor contaminants will enter the interior of the ship. Ventilation systems are effective in removing vapor contaminants by exchanging the air within compartments. This process, called *purging*, is quite effective. For example, one change of air will remove one-half of the contaminants. Six changes of air will remove almost all of the contaminants. For those vessels that have COLPRO systems, all or part of the vessel will contain the components necessary to provide the COLPRO. The system will include the areas that have overpressure capability, fans, filters, air locks, and decontamination stations.

b. Shipboard Collective Protection System. The CP system aboard many ships is an installed ventilation system that sends filtered air to designated zones for protection against toxic agents. The zones are contiguous spaces, which share common boundaries—such as hull frames, bulkheads, decks, and accesses. Air locks, pressure locks, and decontamination stations maintain the integrity of the toxic-free environment and allow personnel to enter and exit the collective zones. CP systems can provide total or limited protection. Total protection provides an IPE-free environment. Ships with limited protection provide protection from liquid chemical agents; however, a mask must be worn since protection from vapors is not provided. Following a chemical attack, ships with limited protection must move to a contamination-free area for purging of the compartments. NWP 3-20.31, Revision A, *Surface Ship Survivability* provides details on ship COLPRO employment. The specifics of a particular ship COLPRO system and its operation are contained in the ship CBR defense bill.

Appendix A

NUCLEAR, BIOLOGICAL, AND CHEMICAL PROTECTIVE EQUIPMENT

1. Background

Appendix A provides additional information that supplements earlier descriptions of IPE and masks. It describes items such as protective clothing, masks, TIM protective equipment, decontamination, detection, medical, and other related items (e.g., chemical-agent monitors/alarms and radiac equipment/dosimeters). For detailed information on the employment and use of the NBC protective equipment (such as detectors), see the applicable TTP and service-specific technical publications.

2. Protective Clothing

a. Joint Service Lightweight Integrated Suit Technology Chemical Protective Overgarment. The JSLIST (hereafter referred to as the CPO) has a service life of 120 days, of which 45 days is the maximum wear time. The CPO service life begins when the garment is removed from the factory vacuum-sealed bag. It can be laundered up to six times for personal-hygiene purposes and provides 24 hours of protection against liquid, solid, and/or vapor CB attacks. It also provides protection against radioactive alpha and beta particles. Wear time for the CPO begins when it is removed from its factory vacuum-sealed bag and stops when the garment is sealed back into its zipper-locked bag. Donning of the CPO (regardless of the time) equates to a day of wear. To ensure serviceability, personnel conduct operator or shipboard preventive maintenance checks and services (PMCS). Damaged CPO CP ensemble items may be retained only for training purposes. CB protection provided by the CPO is dangerously degraded if an area of the ensemble is wet through the inner lining with petroleum products, perspiration, urine, feces, or many common insect repellents. If the overgarment becomes wet through the inner lining with any of these materials, replace it as soon as possible. All services use the CPO.

b. Chemical Protective Undergarment. The CPU is a two-piece undergarment consisting of a formfitting undershirt and drawers. The CPU is not removed from its bag until it is needed for use. When the CPU is removed from its VB bag, its protective qualities last for a minimum of 15 days. The wear time for the CPU begins when it is removed from the VB bag. If the original bag is not available, use a replacement bag that, as a minimum, is water-resistant or water-repellent. The CPU can be laundered once for personal-hygiene purposes during its 15-day use. It provides protection from CB agents (solid, liquid, and vapor) for up to a 12-hour period. The CPU also protects against radioactive alpha and beta particles. When worn under a duty uniform, the CPU has also shown enhanced flash fire protection capabilities. The CPU is generally used by SOF, explosive ordnance disposal (EOD), technical escort, and depot personnel.

c. Battle Dress Overgarment. The BDO is a camouflage-colored (woodland or desert), expendable, two-piece overgarment consisting of one coat and one pair of trousers. The BDO presently comes sealed in a VB bag that protects against rain, moisture, and

sunlight. The BDO is water-resistant but not waterproof, and it is normally worn as an outer garment. In extreme cold-weather environments, the BDO should be worn between layer two (bib overall, cold-weather shirt, and trouser liner) and layer three (coat liner and field trousers) of the ECWCS. In extreme cold-weather environments, the BDO is sized to wear over arctic/extreme cold-weather environmental clothing; however, mission requirements may dictate that the BDO be worn under arctic clothing. When the BDO is removed from its VB bag and worn, it may be worn up to 22 days. Wear time can be increased to 30 days, with slight increases in risk, at the discretion of the commander. Wear time for the BDO begins when it is removed from its sealed VB bag and stops when the BDO is sealed back in its VB bag. If the original VB bag is not available, return the BDO to a similar material bag and seal it with common duct tape. Donning the BDO (regardless of the time) equates to a day of wear. The BDO provides a minimum of 24 hours of protection against exposure to CB agents (solid, liquid, and vapor) and radioactive alpha and beta particles. While the BDO is not designed to be decontaminated or reimpregnated for reuse, the use of the M291 skin decontamination kit (SDK)/M295 decontamination kit, individual equipment (DKIE) on contaminated ensembles within 15 minutes of the time of exposure to liquid chemical agents will essentially maintain full protective capabilities of the BDO. The BDO becomes unserviceable if it is ripped or torn, a fastener is broken or missing, or POL are spilled or splashed on the garment. Users conduct PMCS for the BDO according to applicable service technical publications. The BDO is being replaced by the JSLIST overgarment. All services use the BDO.

Note: If the original VB bag for clothing such as the JSLIST overgarment, CPU, or BDO, is not available, use a replacement bag that is, as a minimum, is water-resistant or water repellent.

d. A/P22P-9A (V) Below-the-Neck Protective Assembly. The A/P22P-9A (V) below-the-neck protective assembly consists of the MK-1 flyer underall, cotton undershirt and cotton drawers, CP socks, disposable footwear covers, aircrewman's cape, and CP gloves and glove inserts. The MK-1 flyer underall is a one-piece chemical liner made from nylon viscose, nonwoven fabric treated with fluorochemical liquid repellent. The inner surface is coated with activated charcoal. The cotton undershirt and drawers are worn under the chemical liner to prevent skin irritation from the charcoal lining and to minimize perspiration contamination of the chemical liner. The CP socks, made of 4-mil polyethylene, are vapor-agent impermeable and protect feet from CB agents. The disposable footwear covers are clear plastic, disposable (one-time use only) and are designed to protect feet from contamination. The aircrewman's cape is a large, clear, disposable plastic bag, designed to be worn over the body to protect from liquid contamination. The standard CP gloves and inserts are made of butyl rubber, 7-mil thick; and the standard white inserts are 100 percent cotton knit. The primary users include the USN and the USMC.

e. Wet-Weather Gear (see Figure A-1). Wet-weather gear provides an ensemble for wear over IPE. Wet-weather gear provides initial protection against liquid CB agents and radioactive alpha and beta particles in a cold and/or wet climate, both ashore and shipboard. The wet weather gear is made of green, chloroprene-coated nylon. The jacket style parka has a slide fastener with moisture barrier flaps, patch pockets, and a permanently attached hood. All services use wet-weather gear.



Figure A-1. Wet-Weather Gear

f. Nuclear, Biological, and Chemical Bag (see Figure A-2). The NBC equipment protective bag is constructed of abrasion-resistant nylon and is designed to consolidate and transport NBC defense items such as IPE components and decontamination kits. The bag can no longer hold the entire IPE ensemble because of the change from CP footwear covers to GVOs/BVOs. The bag comes in one size and has a four-color, woodland camouflage pattern.



Figure A-2. Nuclear, Biological, and Chemical Equipment Bag

g. Suit, Contamination Avoidance and Liquid Protective. The SCALP is a four-piece ensemble and consists of a jacket, trousers, and two footwear covers. It is designed to be worn over the CPO (BDO or JSLIST) and CP overboots. The footwear covers have 12-mil embossed polyethylene soles. The components provide protection from gross liquid contamination for up to 1 hour. Users include land force elements such as EOD, technical escorts, or medical units.

h. Apron, Toxicological Agent Protective, M2. The apron, toxicological agent protective (TAP), M2 is intended for personnel whose duties may bring them into contact with liquid CB agents. For example, those who work with toxic munitions, perform decontamination in a field environment, handle contaminated clothing and equipment at a decontamination site, and handle and treat chemical agent casualties could use this item of clothing.

i. Self-Contained, Toxic-Environment Protective Outfit. The STEPO provides a totally encapsulating protective ensemble for a TIC environment. The system can be configured in three separate modes of operation, depending on the mission and user requirements. STEPO includes a CP suit, a choice of breathing apparatuses (4-hour

rebreather, tethered air supply with emergency SCBA, and standalone 60-minute SCBA), a battery-powered cooling system, and a hands-free communications system. The STEPO is worn with the TAP boot, which fits over the integral booties of the STEPO CP suit. The STEPO is used in extremely hazardous and/or oxygen-deficient environments where contact with CW agents, POL, missile fuels, and/or TIC can occur. The system provides the wearer with clean, closed-circuit breathing air and up to 4 hours of OSHA Level A protection. The CP suit can be used five times after exposure to vapor contamination and decontamination processes. If the suit is exposed to liquid contamination, it must be decontaminated and disposed of in accordance with local procedures. The primary users of STEPO are EOD specialists, technical escort personnel, and civilians engaged in chemical activity/depot hazardous materials (HAZMAT) operations.

j. Chemical Protective Glove Set. The glove sets come in three thicknesses (7, 14, and 25 mil). The 7-mil glove set is generally used by personnel whose tasks require extreme tactility and/or sensitivity and who will not expose the gloves to harsh treatment. The 14-mil glove set is used by personnel such as aviators, vehicle mechanics, and weapon crews whose tasks require tactility and sensitivity and who will not expose the gloves to harsh treatment. The more durable, 25-mil glove set is used by personnel who perform close combat tasks and other types of heavy labor. The glove protects against CB agents and alpha and beta radioactive particles as long as they remain serviceable. If the 14- and 25-mil glove sets become contaminated with liquid chemical agents, decontaminate or replace them within 24 hours after exposure. If the 7-mil glove set becomes contaminated, replace or decontaminate them within 6 hours after exposure. The contaminated gloves may be decontaminated with a 5 percent chlorine solution or a 5 percent HTH and water solution. Primary users include all the services.

k. Green Vinyl Overshoe, Black Vinyl Overshoe, and Multipurpose Lightweight Overboot. The GVO is a plain, olive drab (OD) green, vinyl overshoe with elastic fasteners. The BVO is very similar to the GVO, except for the color and enlarged tabs on each elastic fastener. Personnel can wear the GVO or BVO over their combat boots to protect their feet from contamination by all known agents, vectors, and radiological particles (alpha and beta) for a maximum of 60 days. Protection continues if the GVO/BVO remains serviceable. Wearing the GVO/BVO with combat boots provides 24 hours of protection against all known CB agents following contamination. Decontaminate the GVO/BVO with a 5 percent HTH and water solution or a 5 percent household bleach and water solution. If signs of deterioration occur following decontamination, replace the overshoe. The MULO is also designed to be worn over combat boots, jungle boots, and intermediate cold/wet boots. The MULO provides 60 days of durability and 24 hours of protection against CB agents. The primary users include all services.

l. Chemical Protective Footwear Cover. The CPFC is impermeable and protects feet from CB agents, vectors, and radiological dust particles for a minimum of 24 hours, as long as it remains serviceable. CPFCs can be decontaminated using a 5 percent chlorine solution. The USN continues to use the CPFC.

m. Chemical Protective Helmet Cover (see Figure A-3). The chemical protective helmet cover is a one-piece configuration made of butyl-coated nylon cloth and gathered at the opening by elastic webbing enclosed in the hem. The cover comes in one size and is OD

green color. The helmet cover protects the helmet from CB contamination and radioactive alpha and beta particles. The primary users include USA and USMC units.



Figure A-3. Chemical Protective Helmet Cover

n. Joint Firefighter Integrated Response Ensemble. The joint firefighter integrated response ensemble (J-FIRE) configuration consists of a chemical protective overgarment (JSLIST), a firefighter proximity suit, a hood, a modified structural helmet, CB butyl rubber gloves with liners, fire-protective gloves, fire-protective boots, a SCBA with a CW kit, and a carrying bag. The J-FIRE ensemble may contain a proximity glove with built-in CP features instead of the separate butyl rubber and fire-protective gloves. The primary users include special-purpose teams such as firefighters.

o. NBC Protective Cover. The NBC protective cover is a lightweight cover for use in preventing liquid contamination of supplies and equipment. The cover also provides a barrier between covered supplies and liquid agents and radioactive dust. Protection time against liquid agents is 48 hours. The cover can provide protection for up to 6 weeks without agent exposure before it begins to break down due to environmental conditions.

3. Protective Masks

The field protective masks described in this paragraph are not authorized for use in TIC environments, because many TIC, such as carbon monoxide, are oxygen-depleting. These masks are not effective in certain spaces when the oxygen content in the air is too low. Standard eyeglasses or contact lenses cannot be worn with these masks (except for the M43). Therefore, individuals must obtain optical inserts for their masks. Proper PMCS is essential to ensure serviceability.

a. Chemical-Biological Mask: Field M40-series. The M40-series CB mask consists of a silicone rubber facepiece with a binocular eyelens system and an elastic head harness. Other features include front and side voicemitters (allowing better contact, particularly when operating communications equipment), a drinking tube, clear and tinted inserts, and a filter canister with NATO standard threads. The M40A1 mask provides respiratory, eye, and face protection against CB agents, radioactive fallout particles, and battlefield contaminants. The canister filter cannot be changed in a contaminated environment; the mask was not designed for that contingency. Additionally, the M40A1 mask uses a second skin for additional protection, and also has a quick-doff hood. The primary users include USA and USMC units, and the mask is selectively used by USN personnel.

b. Chemical-Biological Mask: Combat Vehicle M42A2. The M42A2 CB mask has the same components as the M40. In addition, the M42A2 CVC mask has a detachable microphone for wire communications. The canister on the M42A2 mask is attached to the end of a hose and has an adapter for connection to a GPFU. The M40/M42-series masks also use the same filter canister with NATO standard threads, both use a second skin for additional protection, and both have a quick-doff hood. The primary users include USA and USMC units.

c. Chemical-Biological Mask: Aircrew Aviator M45. The M45 aircrew mask provides respiratory, eye, and face protection. The M45 aircrew mask protects the user against all known CB agents and radiological particles without the aid of forced-air ventilation, while maintaining compatibility with rotary-winged aircraft sighting systems and night vision devices (NVDs). The mask provides a microphone, a drinking tube, close-fitting eyelenses, front and side voicemitters for face-to-face and phone communications, and a low-profile canister interoperability hose assembly for both hose and face-mounted configurations. The mask also comes with a hood and a second skin. The M45 mask is used to support service personnel who cannot be fitted with the standard M40-series or MCU-2A/P series protective masks. The primary users include USA and USMC units.

d. Chemical-Biological Mask: Aircraft M43. The M43 mask provides the required CB agent protection and allows for compatibility with the AH-64 attack helicopter helmet, the display sighting system, and the optical relay tube. The mask comes with a portable blower/filter system that operates on battery or aircraft power to maintain positive pressure in the facepiece and an inhalation air distribution assembly for regulating the flow of air. Additionally, the mask provides for external voice or wire communications and a drink tube assembly. The primary users include USA AH-64 helicopter aviators.

e. Chemical-Biological Mask: M48. The M48 CB aircraft mask was developed for the AH-64 Apache helicopter aviators. It provides face, eye, and respiratory protection against CB agents and radioactive particles. The M48 mask has a lightweight motor blower that is mounted on the user during dismounted operations and is mounted to the airframe during flight operations. The motor blower provides filtered, breathable air that keeps the head cool and prevents the eyelens from fogging. While wearing the M48 mask, crewmembers can perform their missions in an NBC environment inside or outside the aircraft. The M48 will replace the M43 mask, which is worn by Apache helicopter aviators.

f. Aircrew Eye/Respiratory Protection (see Figure A-4). The aircrew eye/respiratory protection (AERP) is a protective mask that enables USAF aircrews to conduct mission operations in a CB environment. The AERP system includes a protective hood assembly with a standard MBU-13/P mask, an intercom for ground communications, and a blower assembly that provides demisting. The blower is stowed during flight operations on a bracket that is mounted inside the aircraft. It replaces the MBU-13/P system for aviators. The primary users include USAF units.



Figure A-4. Aircrew Eye/Respiratory Protection

g. CB Respiratory System (A/P 22P-14[V] Nondevelopmental Item [NDI]). The CB respiratory system is a self-contained, protective ensemble designed for all forward deployed rotary wing (Version 1 for USN) and fixed wing (Versions 2 through 4 for USN and USMC) aircrews. The design incorporates a CB filter, dual air/oxygen supply, a crossover manifold with a ground flight selector switch to filter air for hood ventilation, and filtered air for breathing. The A/P 22P-14(V) 1 is for helicopter use and is not compatible with aircraft with oxygen delivery systems. The A/P 22P-14(V) 2 is used on EA-6B and F-18A aircraft. The A/P 22 P-14 (V) 3 is used on AV-8B and F-18C/D aircraft, and the A/P 22P-14(V) 4 is used for C130 crews. The primary users include USN and USMC aircrews.

h. MCU-2A/P Protective Mask. The MCU-2A/P mask (see Figure A-5 [page A-8]) (with a serviceable canister filter installed) protects the face, eyes, and respiratory tract from CW and BW agents and radioactive dust particles. A properly worn mask provides USN and USAF personnel with a gas-tight face seal, which prevents unfiltered air from reaching the wearer's respiratory system. An internal microphone may be placed inside the mask and connected to an external communications system through a connector on the front voicemitter. The major components of the MCU-2A/P mask include an outlet valve assembly, an outlet valve cover, a drinking tube, a nose cup, an inlet valve, lens outserts, and a canister. The accessories for the MCU-2A/P mask include a mask carrier, a protective hood, mask outserts, and a special canteen drinking cap. The primary user includes USN and USAF personnel.



Figure A-5. MCU-2A/P Protective Mask

i. **MCU-2/P Protective Mask.** The MCU-2/P-series protective mask is the eye respiratory protection equipment used shipboard for CBR defense. It has a single filter and two voicemitters—one on the front of the mask for speaking directly into a telephone or radio handset and one at the side to allow personnel nearby to hear. The mask has a drinking tube that connects to a canteen with an M1 canteen cap. The MCU-2/P is being phased out and replaced by the MCU-2A/P-series protective mask. The primary users include the USN and USAF.

j. **M17A1/M17A2-Series Field Protective Mask.** The M17A1/M17A2-series CB mask, with the M6A2 hood, protects against field concentrations of all known CB agents in vapor or aerosol form. The mask is no longer standard issue for military personnel; however, it could still be used for issue to civilians during missions such as noncombatant evacuation operations (NEOs).

k. **Joint Service General Purpose Mask.** The joint service general-purpose mask (JSGPM) will eventually replace the M40/M42/MCU-2/P-series masks. The JSGPM will provide face, eye, and respiratory protection from battlefield concentrations of CB agents, TIC, and radioactive particulate matter. It will also provide improved protection for selected TIC.

l. **M41 Protection Assessment Test System (see Figure A-6).** The M41 protection assessment test system (PATS) is designed to check the readiness of protective masks and to verify that a protective mask, while worn by an individual, is capable of providing the required fit factor/protection factor (PF). The PATS verifies that the fit of the mask to the person's face is acceptable and that there are no critical leaks in the mask system. In addition to these features, the PATS can also be used to help screen for unserviceable masks, to assist in determining if PMCS have been conducted properly on critical components, and to assist in training personnel on the proper wear of the mask. The PATS is currently used by USA, USMC, and USAF units. Additionally, the PATS requires periodic calibration, and the calibration is scheduled and coordinated through service logistics channels.



Figure A-6. M41 Protection Assessment Test System

m. Mask Leakage Tester, TDA-99M. The TDA-99M is a one-man, portable, unit-level system that is capable of determining serviceability, checking PMCS adequacy, and identifying defective components of protective masks. Users include USA, USN, USAF, and USMC units.

n. Voice Communication Adapter. The voice communication adapter (VCA) is a low-risk program providing additional voice amplification capability to the M40/M42 mask. The VCA is a joint program between the USA and the USMC.

o. Universal Second Skin. The universal second skin is one of the components of a preplanned product improvement (P³I) in the M40/M42 series mask. The universal second skin provides liquid agent protection for the mask faceblank material. The primary users include USA and USMC units.

p. NBC Protection Items Stowed in the Carrier, Protective Mask. Each branch of service will specify what items are to be carried for the protection of their personnel based on associated missions. Generally, current mask carriers accommodate three NAAKs, M8 detector paper, a technical reference, a mask hood (mounted on the mask in most cases), mask outserts (mounted on the mask in most cases), a waterproof bag, a canteen cap, and personal and equipment decontaminating kit (M291 SDK and/or M295 DKIE).

4. Toxic Industrial Material Protection

a. Level A. The Level A protective suit provides the greatest level of skin and respiratory protection. It consists of a totally encapsulating suit with gloves and boots attached. A SCBA is worn inside the suit or a supplied-air system is used for respiratory protection. Two pairs of gloves, latex and chemical-resistant, are worn under the suit gloves. Chemical-resistant boots are worn over the suit boots. A radio may be worn under the suit. Optional items, such as hard hats, cooling vests, and kneepads, may be worn. This ensemble should be worn when the highest level of respiratory, skin, and eye protection is required.

b. Level B. Level B protection should be considered when the highest level of respiratory protection is needed, but with a lesser level of skin and eye protection. This level consists of nonencapsulating, chemical-resistant suits, often called splash suits or rain suits. Level B comes in several configurations, none of which are vapor-tight. A SCBA is worn inside or outside the suit, depending on the configuration. Chemical-resistant outer boots are worn, and three pairs of gloves may be used. Latex inner gloves are worn under the chemical-resistant gloves. A pair of chemical-resistant outer gloves may cover both of these for additional protection. Level B is the minimum level recommended for initial site entry until all hazards have been identified and are being monitored.

c. Level C. Level C protection can be selected when the airborne substance is known and is being monitored. All criteria must be met for the use of air-purifying respirators (APR), and the proper filters for the known hazard present. Air monitoring must continue throughout the operation to ensure that Level C protection remains effective for the environment. An escape mask should be worn in case of a change in conditions that make the air-purifying respirator ineffective. This escape mask will provide protection to the responder during movement to the decontamination line without risking exposure. The Level C ensemble consists of a full facepiece, an air-purifying respirator, and a chemical agent-resistant suit. A chemical agent-resistant hood, apron, boots, and gloves should also be worn. The gloves are layered the same as for Level B. Level C protection is similar to that of MOPP 4 in a chemical weapons environment.

d. Level D. The Level D protective ensemble is the work uniform. Level D does not provide any respiratory or skin protection and should not be used at an incident site that presents these hazards. The military BDU or coveralls meet the requirements for this level of protection.

5. Decontamination Equipment

a. M291 Skin Decontamination Kit. The M291 kit consists of a wallet-like carrying pouch containing six individual decontamination packets, enough to do three complete skin decontaminations. The kit allows personnel to decontaminate their skin through physical removal, absorption, or neutralization of toxic agents with no long-term harmful effects. The kit is used for external use only and may be slightly irritating to eyes or skin. Personnel must ensure that they keep the decontamination powder out of eyes, cuts, or wounds and avoid inhalation of the powder. The primary users include all services.

b. M295 Decontamination Kit, Individual Equipment. The M295 kit allows personnel to decontaminate their individual equipment through physical removal and sorption of chemical agents. (Note: The M295 kit can decontaminate approximately 1,200 square feet.) Decontamination is accomplished through sorption of contamination by both the kit nonwoven polyester pad and by the decontaminating powder. (Note: It is not approved for skin decontamination.) Decontaminating the CB protective mask/hood, gloves, footwear, weapon, helmet, and load-bearing equipment (LBE) preclude agent transfer during the overgarment exchange and entry or exit procedures. The primary users include all services.

c. Sorbent Decontamination System (SDS) M100. The M100 SDS is intended to replace the M11s and M13s currently employed in operator spray-down operations

associated with immediate decontamination. (Note: It is not approved for skin decontamination.) The system uses powdered sorbent to remove chemical agents from surfaces. The reactive sorbent is nontoxic and noncorrosive, and it requires no water to complete its mission. The SDS is designed to operate at temperatures between -25 and 120 degrees F.

d. ABC-M11 Portable Decontaminating Apparatus (see Figure A-7). The ABC-M11 portable decontaminating apparatus decontaminates small areas, such as steering wheels or other equipment-operating areas with which personnel may have contact. It is a steel container with an aluminum spray head assembly and a nitrogen gas cylinder that provides the pressure. It is filled with $1 \frac{1}{3}$ quarts of DS2 decontaminating solution, which is sufficient for decontaminating 135 square feet of surface area. The effective spray range is 6 to 8 feet. The primary users include USA and USMC units.

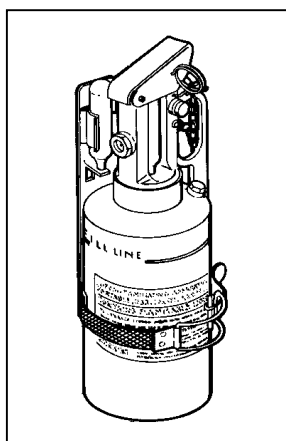

Figure A-7. ABC-M11 Portable Decontaminating Apparatus

e. M13 Decontaminating Apparatus, Portable (see Figure A-8 [page A-12]). The man-portable M13 decontaminating apparatus, portable (DAP) consists of a vehicle-mounting bracket, a container filled with 14 liters of DS2 decontaminating solution, and a brush-tipped pumping handle connected to the fluid container by a hose. The fluid container and the brush head are disposable. The M13 can decontaminate 1,200 square feet per fluid container. The combination of a spray pump and a brush allows personnel to decontaminate hard-to-reach surfaces and remove thickened agents, mud, grease, and other material. The primary users include USA and USMC units.

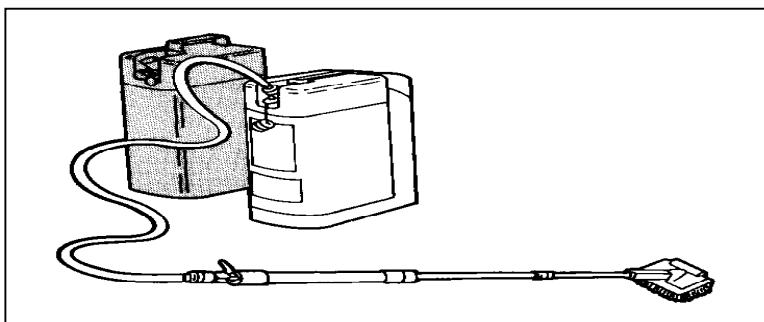

Figure A-8. M13 Decontaminating Apparatus, Portable

6. Chemical Detector Paper/Kits

a. M8 Chemical Agent Detector Paper. M8 paper is used to detect the presence of liquid V type nerve, G type nerve, and H type blister agents. When a sheet is brought in contact with liquid nerve or blister agents, it reacts with chemicals in the paper to produce agent-specific color changes. The paper is blotted on a suspected liquid agent and observed for a color change (liquid agent absorption). V type nerve agents turn the paper dark green; G type nerve agents turn it yellow, and blister agents (H) turn it red. The paper cannot be used to detect chemical agents in water, vapor, or aerosols. The primary users include all services.

b. M9 Chemical Agent Detector Paper. M9 paper is placed on personnel and equipment to identify the presence of liquid chemical agent aerosols. It will turn pink, red, reddish brown, or red-purple when exposed to liquid agents. It can detect (but not identify) the specific agent. As soon as it indicates the presence of chemical agents, protective action must be taken. The primary users include all services.

c. M256A1 Chemical Agent Detector Kits. The M256A1 is a portable, expendable item that is capable of detecting and identifying hazardous concentrations of chemical agents. It is used after a chemical attack to determine if it is safe to unmask or reduce the protective posture level. It also determines the type of agent present and helps confirm the presence or absence of hazardous concentrations of an agent. Each kit can be used to test for blister agents, blood agents, nerve agents, and lewisite. Each test spot or detecting tablet develops a distinctive color that indicates whether a chemical agent is or is not present in the air. The primary users include all services.

7. First Aid Equipment

a. Nerve Agent Antidote Kit, Mark I. Nerve agent poisoning requires immediate first aid treatment. Personnel receive three NAAKs, Mark I, for this purpose. Personnel may become subject to nerve agent poisoning on the battlefield. Immediate treatment with the NAAK is required if they are to survive. The NAAK consists of one small autoinjector containing atropine and a second autoinjector containing pralidoxime chloride. A plastic clip holds the two injectors together. Store the NAAK in the accessory storage pocket inside the mask carrier. Protect the NAAK from freezing. See FM 8-285/Navy Medical (NAVMED) P-5041/Air Force Joint Manual (AFJMAN) 44-149/MCRP 4-11.1A, *Treatment of Chemical*

Agent Casualties and Conventional Military Injuries, for more information on the NAAK. The NAAK can also be issued in a Mark II configuration. The two autoinjectors are issued without the plastic clip to hold them together.

b. Antidote Treatment, Nerve Agent Autoinjector. Nerve agent poisoning requires immediate first aid treatment. Personnel receive three antidote treatment, nerve agent autoinjectors (ATNAAs) for this purpose. Because personnel may become subjected to nerve agent poisoning on the battlefield, immediate treatment with the ATNAA is required if they are to survive. The ATNAA is a multichambered device that consists of four components: the autoinjector (with atropine and phosphotriesterase, pralidoxime-2 [2 PAM] chloride piggybacked in separate chambers), a spring-activated needle, a safety cap, and carrying case. Store the ATNAA in the accessory storage pocket inside your mask carrier. Protect the ATNAA from freezing. See FM 8-285/NAVMED P-5041/AFJMAN 44-149/ MCRP 4-11.1A for more information on the ATNAA. (Note: The ATNAA will replace the NAAK based on shelf life expiration dates for the NAAK.)

c. Nerve Agent Pretreatment Pyridostigmine. Nerve agent pretreatment pyridostigmine (NAPP) is an adjunct to the NAAK/ATNAA. NAPP is an investigational new drug (IND), which requires presidential approval for use by military personnel. NAAK pretreatment enhances individual survivability in a nerve agent chemical environment. Each individual is initially issued one NAPP package. If approval for NAPP use is obtained by the combatant commander, personnel will begin taking their NAPP tablets when ordered by their commander based on assessment of possible agent exposure within a few hours or days. One tablet is to be taken on a continuous basis once every 8 hours until all 21 tablets have been taken or the individual has been directed to discontinue taking the tablets. NAPPs should be stored/refrigerated in temperatures ranging from 35 to 46 degrees F. If the medication is removed from the refrigerator for a total of 6 months, it should be assumed that it has lost its potency and should not be used. See FM 8-285/NAVMED P-5041/AFJMAN 44-149/ MCRP 4-11.1A for more information on the NAPP.

d. Convulsant Antidote for Nerve Agents. The convulsant antidote for nerve agents (CANA) is similar to existing autoinjectors, but it is modified to hold a 2-milliliter volume of diazepam. The CANA is a disposable device for intramuscular delivery of diazepam to a buddy who is incapacitated by nerve agent poisoning. It is administered by buddy aid only and is an adjunct to the NAAK/ATNAA kit. The CANA is an individually issued item. See FM 8-285/NAVMED P-5041/AFJMAN 44-149/ MCRP 4-11.1A for more information.

e. Skin Exposure Reduction Paste Against Chemical Warfare Agents. The SERPACWA is a topical skin protectant that will protect personnel from penetration or absorption of vapor particulate and/or liquid CB agents. SERPACWA will be used on bare skin in conjunction with MOPP ensembles. SERPACWA does not interfere with sunscreens, skin or clothing, lip balm, hand lotions, or skin camouflage products. When applied at select locations on the body (e.g., wrist, neck, ankles, armpits, groin area, and waist), SERPACWA creates an inert physical barrier to CB agents without compromising normal skin function. Each service member will be issued three SERPACWA packets. An application from one packet is intended to last approximately 8 hours. SERPACWA will be applied at the discretion of the commander. (Note: Personnel do not open their IPE to apply SERPACWA in an NBC environment.)

8. Related Equipment (Chemical Monitors, Radiation Detection Instruments and Biological Detectors)

Commanders must ensure that the appropriate section/squad/department has personnel trained to operate and maintain the assigned NBC defense equipment. Operation and maintenance of individual and unit NBC equipment are both a leadership and individual responsibility. Not everyone in the unit will be provided these items of NBC equipment, but any individual may become responsible for them or need to use them. The items may include chemical agent monitors, radiac sets, and other related items.

a. Chemical Agent Monitor. The CAM is designed to be used to monitor for chemical agent vapor (nerve or blister) on personnel and equipment and provide a readout of the relative concentration of vapor present. It can be used to monitor personnel or vehicles prior to decontamination and/or inside CPSs. When an agent vapor is detected, the CAM will provide a bar graph indication of the relative concentration of the sample. The primary users include all services.

b. Improved Chemical Agent Monitor. The ICAM identifies nerve and mustard agent contamination on personnel and equipment. The ICAM provides the operator instantaneous feedback of chemical hazard levels and quickly determines the presence of contamination on personnel and equipment. The ICAM is a handheld, individual-operated, postattack device for monitoring chemical agent contamination on personnel and equipment. The monitor detects and discriminates between vapors of nerve and mustard agents. The primary users include all services.

c. Soil Sampling Kit, M34. The M34 is intended for use by authorized USA NBC personnel to perform sampling of soil, surface matter, and water. The primary use of the kit is to gather soil samples for processing at laboratories. The carrier is used as a shipping container for transmitting samples to the laboratories.

d. Sampling Kit, CBR Agent, M34A1. The M34A1 kit is configured to collect liquid, soil, surface, and small solid samples suspected of being contaminated with chemical agents for transport to a laboratory for analysis. The kit contains Teflon® containers and expendable materials for taking two or three samples of each type of material. The jars are capable of containing chemical agents at high (120 degrees F) and low temperatures. The primary users include USA personnel.

e. Chemical Agent Detector Kit, M18A2. The M18A2 chemical agent detector kit can detect and identify dangerous concentrations of nerve, blister, blood, and choking agents in about 1 to 4 minutes. The kit can be used to confirm results of the M256A1 kit. The kit also contains a booklet of M8 chemical agent detector paper to detect liquid agents. The M18A2 kit is used by special teams, such as surety teams or technical escort personnel.

f. Automatic Chemical Agent Alarm, M8A1. The M8A1 ACAA is a system that continuously samples the air to detect the presence of dangerous concentrations of G and V type nerve agent vapors. The M8A1 may be employed in a number of configurations, but all configurations differ primarily in their mountings and power supplies: ground-mounted and battery-operated or mounted on a vehicle and powered by the vehicle electrical system. The M43A1 detector unit will alarm within 1 or 2 minutes from exposure to the agent. The M42

alarm unit is a remote visual and audible alarm. The M42 alarm unit may be placed up to 400 meters from the M43A1 detector unit to give users warning of an approaching agent cloud. The primary users include land and aerospace forces (USA, USMC, and USAF).

g. Automatic Chemical Agent Detection Alarm, M22. The M22 automatic chemical agent detection alarm (ACADA) is a man-portable, point-sampling alarm system that detects and identifies all nerve agents, mustard, and lewisite by class. ACADA provides concurrent nerve and blister agent detection, improved sensitivity and response time, agent identification, improved interference rejection, an extensive built-in test, and a data communications interface. It can also be programmed for new threat agents. It replaces the M8A1 alarm as an automatic point detector and augments the CAM as a survey instrument. The primary users include land and aerospace forces (USA, USMC, and USAF).

h. Chemical Warfare Agent Detector, M90. The M90 is an automatic nerve and mustard agent detector that detects agents in vapor form. The system is currently in use by the USAF. It transmits an alarm by radio to a central alarm unit.

i. Chemical Agent Point Detector System, MK21. The Chemical Agent Point Detector System (CAPDS) is a fixed system capable of detecting nerve agents in vapor form, using a simple baffle tube ionization spectrometer. Alarm signals are generated and sent to damage control central and the bridge. The system has been installed in most surface ships.

j. Improved Point Detection System. The Improved Point Detector System (IPDS) is a shipboard point detector and alarm that replaces the existing shipboard CAPDS. IPDS can detect nerve and blister agent vapors at low levels and automatically provide an alarm to the ship. The unit is built to survive the harsh sea environment and the extreme electromagnetic effects found on Navy ships.

k. Water Testing Kit, Chemical Agent, M272. The M272 is a portable, lightweight kit that will detect and identify harmful amounts of CW agents when present in raw or treated water. The M272 detects dangerous amounts of cyanide, mustard, lewisite, and nerve agents in water. The primary users are the USA and the USAF.

l. Automatic Chemical Agent Alarm, M21. The M21 alarm is a standoff device that detects both nerve and blister agents at LOS distances up to 5 kilometers. The M21 alarm is mounted on the M93A1 NBC Reconnaissance System. The primary users are the USA and the USMC.

m. Radiac Set, AN/UDR-13. The AN/UDR-13 pocket radiac set is designed to detect and measure nuclear radiation from fallout, radiological contamination, and nuclear detonations. It is a combined-rate meter and tactical dosimeter, and it measures dose rates from 0.1 to 999 cGyph and total doses from 0.1 to 999 cGy. It is capable of measuring a prompt gamma/neutron dose from a nuclear event plus a gamma dose and dose rate from nuclear fallout. A push-button pad enables mode selection, functional control, and the setting of audio and visual alarm thresholds for the dose rate and the mission dose. The primary users are the USA and the USMC.

n. Radiac Meter, IM-93/UD. The IM-93/UD radiac meter detects and measures cumulative exposure to short-duration, high or low intensity, X-ray and gamma ray radiation. The IM-93/UD can be clipped to the user's pocket or can be attached to some object in the area that is to be measured for total dose radiation exposure. The radiac meter measures from 0 to 600 cGy, in increments of 20. The maximum acceptable leakage is 12 cGy per day (24 hours). The primary users are the USA, USN, and the USMC.

o. Radiac Meter, IM-147/PD. The IM-147/PD radiac meter detects and measures cumulative exposure to short-duration, high or low intensity, X-ray and gamma ray radiation. The IM-147/PD can be clipped to the user's pocket or can be attached to some object in the area that is to be measured for total dose radiation exposure. The radiac meter measures from 0 to 50 RADS in increments of 2. The maximum acceptable leakage is 1 cGy per day (24 hours). The primary users are the USA, USN, and USMC.

p. Charger, Radiac, PP-1578A/PD. The radiac charger is a frictional generator of static electricity required to charge the IM-93/UD and IM-147/PD radiac meters. The PP-1578A/PD and the dosimeters associated with it are being phased out of service within the USA. It is being replaced by the AN/UDR-13 pocket radiac set.

q. Radiac Set, AN/VDR-2. The AN/VDR-2 is designed to detect and measure nuclear radiation from fallout and radioisotopes. It is used to perform ground radiological surveys in vehicles or in a dismounted mode as a handheld instrument. The AN/VDR-2 measures dose rate from 0.1 to 230 cGy per hour, and measures total dose from 0.1 to 999 cGy. The primary users are the USA and the USMC.

r. Radiac Set, AN/PDR-75. The AN/PDR-75 radiac set detects and measures nuclear radiation from fallout and nuclear detonations. The system consists of a computer indicator, radiac, CP-696/PDR-75 and a detector radiac, DT-236/PDR-75. The system monitors and records the exposure of individual personnel to gamma and neutron radiation. The CP-696/PDR-75 is used to measure the accumulated neutron and gamma radiation dose recorded by the DT-236/PDR-75. The DT-236/PDR-75 is worn by personnel who may be exposed to radiation. It allows for radiation monitoring of individual personnel, provides accurate readings for extended periods of time after exposure, and measures from 0 to 999 cGy in any combination of neutron and gamma doses. The primary users are the USA and USMC.

s. Radiac Set, AN/PDR-77. The radiac set AN/PDR-77 detects and measures alpha, X-ray, beta, and gamma radiation. The system incorporates commercially available measurement electronics, an alpha probe, a beta gamma probe, and an X-ray probe. The AN/PDR-77 measures count rate from 1 to 999,000 counts per minute. The primary user is the USA.

t. Radiac Set, AN/PDR-27R. The AN/PDR-27R is designed to detect beta radiation and to measure and detect gamma radiation. The primary user is the USN.

u. Radiac Set, AN/PDR-43. The AN/PDR-43 is a pulsed (time-controlled) end-window Geiger-Muller type radiac set that serves as the USN's standard, high-range, beta-gamma survey instrument. The primary user is the USN.

- v. Radiac Set, AN/PDR-56. The AN/PDR-56 is a portable, scintillation type instrument used for detecting alpha contamination. The system includes large and small interchangeable probes with a probe extension. The primary users are the USN and the USMC.
- w. Radiac Set, AN/PDR-65. The AN/PDR-65 and AN/PDR-65A are the USN's standard fixed instrument for measuring gamma radiation intensity and providing dose information. The AN/PDR-65/65A system measures gamma intensities to 10,000 cGyph and records cumulative doses to 9,999 cGyph. The primary user is the USN.
- x. Detector, Radiac, Dosimeter DT-60C/PD. The DT-60C/PD personnel dosimeter is a high-range, non-self-reading dosimeter. A CP-95A/PD reader must be used to determine the total dose. The system measures gamma radiation exposure up to 600 cGy. The primary user is the USN.
- y. Dosimeter Reader, CP-95A/PD. The CP-95A/PD is designed to read the DT-60-series personnel dosimeter. The CP-95A/PD will operate over a range of 0 to 200 cGyph in 10-cGy steps and 0 to 1,000 cGyph in 20-cGy steps, with each 100 roentgens a major subdivision. The primary user is the USN.
- z. Dosimeter, IM-143B/PD. The IM-143B/PD is a pen-like, self-reading pocket dosimeter and is designed to read gamma radiation exposure in the 0 to 600 roentgens range. The primary users are the USN, USAF and USMC.
- aa. Radiac Charger, PP-4276C/PD. The PP-4276C/PD is a transistorized battery-operated charger. The system is designed to charge and zero the pocket dosimeter. The primary users are the USN and USMC.
- bb. Multifunctional Survey Meter, ADM-300A. The ADM-300A is a battery-operated, self-diagnostic, multiple-function instrument. It is used alone to locate and measure low- and high-intensity radioactivity in the form of gamma rays or beta particles. It is used with external probes to locate and measure alpha, beta, gamma, X-ray, and neutron radiation. The primary user is the USAF.
- cc. Handheld Assay. The handheld assay (HHA) is a specific biological-detection component used with the M31 and M31A1 BIDS. The HHA (in most cases) is used as a backup for the primary specific detection components in the M31 and M31A1 BIDS. The HHA is also a subcomponent of the DOD biological sampling kit that is used by all services.
- dd. Detector System, Biological Agent, Joint Portal Shield, M99. The portal shield is a system that can identify up to eight biological agents simultaneously. The Mark III sensor network measures the amount of particles in the air and determines if an increased concentration in the 1 to 10 micron range constitutes a biological attack. With an M21 or M22 chemical detector added, the system also detects chemical agents. It has meteorological and communications equipment and an auxiliary generator in case of commercial power failure.
- ee. DOD Biological Sampling Kit. This kit can be used to support the presumptive identification process for biological agents. It can be used one time and contains—

- One panel of up to 8 HHAs.
- One bottle of buffer solution.
- One packet of sterile, cotton swabs.
- One set of laminated instruction cards.
- One 10- by 10-centimeter cutout.

Appendix B

GUIDELINES FOR THE NUCLEAR, BIOLOGICAL, AND CHEMICAL PORTION OF A COLLECTIVE PROTECTION STANDING OPERATING PROCEDURE

1. Background

This appendix provides sample information that could be used to help prepare a CP system SOP, support shelter entry/exit procedures, prepare a shelter for operation, and discuss classes of COLPRO and associated equipment.

2. Suggested Guidelines for Preparation of a Collective Protection System Standing Operating Procedure

The information in this paragraph is intended as a guide for units. Each unit should modify and expand this guidance to develop its own SOP. Each SOP should consider peculiarities of unit organization, mission, equipment, and environmental situation. An SOP should delineate operational details of a shelter or a van equipped for CP. For example, details must include NBC-related duties of a guard (where applicable) and entry and exit procedures.

The SOP should consider the following:

- Responsibilities.
- Type and location of the shelter or van.
- Resource estimates (e.g., number of shelter management personnel).
- Frequency of and requirements for entries and exits.
- Maintenance of the area around the shelter.
- Personnel entry procedures.
- Emergency operation procedures, interior procedures, operating procedures for shelter attendants, and logistics considerations.
- Number of nonshelter personnel assigned to the same site as the shelter or van.
 - a. Outline Objective and Responsibilities.

(1) Background. The objective of the shelter plan is to provide the best available physical protection for personnel. Key elements to a successful personnel shelter plan include adequate shelters, personnel who are familiar with shelter procedures,

personnel trained in shelter management, the ability to activate and close shelters at the appropriate times, the ability to stock shelters with required supplies and equipment, and the ability to occupy shelters for extended periods.

(2) Fixed-Site Commander. To implement a successful shelter program, the commander develops a comprehensive protection program to provide sufficient shelter spaces for military and emergency-essential civilians (include added-forces projections for teams and supplies). He also determines the type and quantity of shelters based on the threat and considers the use of open-air CCAs and toxic-free areas (TFAs).

(3) Unit Commander. The commander's responsibilities include—

- Implementing instructions and publishing unit and facility implementing instructions and checklists for shelter operations as required.
- Planning supply and resupply actions. Logistics planning includes preparing shelter operations for several consecutive days after fallout peaks or after the onset of CB contamination. Logistics planning also considers medical requirements.
- Identifying shelter management team (SMT) requirements. Ensure that SMT members do not have conflicting duties. Identify and train selected unit personnel identified for mobilization in shelter management techniques.
- Training SMTs. Train personnel to operate, maintain, and perform inspections and minor troubleshooting of the equipment within the shelter. This should include filtration, air conditioning and heating, electrical, sanitation, and communications systems. Personnel should also maintain portable detection devices.
- Conducting operational planning. Stagger work shifts and rest cycles, as the mission permits to minimize bottlenecks during shelter processing. Leaders should also develop shelter floor plan diagrams and oversee the operation of the exposure control system.

(4) Fixed-Site NBC Personnel. Fixed-site NBC personnel should plan for expedient hardening to increase the protective capability of the shelter during contingency operations. Additionally, they should—

- Direct the performance of preventive and unit level maintenance on available CP systems.
- Provide potable water to sustain operations.
- Train SMTs in facility and equipment operation, shelter management, and shelter equipment use.

(5) Individuals. Each individual should know the location of their protective shelter and understand the processing procedures in the shelter.

b. Conduct Shelter Planning. For planning purposes, all military and emergency-essential civilians will occupy the shelter space during appropriate readiness stages. Planning factors for shelter operations should include—

- Providing the minimum shelter team size for emergency operations and rest-and-relief shelters for CB protection and nuclear fallout. There should be one shelter supervisor and one monitor per shift.
- Allowing one space per two persons assigned to a rest-and-relief shelter.
- Providing positive overpressure of filtered air in collective protection facilities to keep CB agents out of the TFA.
- Providing outward airflow through the air locks and CCA to minimize hazards.
- Considering the use and location of open air CCAs and TFAs.

c. Ensure Clean Areas Around the Protective Entrance. Provide procedures in an SOP to decontaminate the area surrounding the shelter or van entrance if liquid agent is present. Decontamination methods could include turning over or removing a top layer of soil, removing snow, or adding a clean layer of soil or sand. A clean surface can also be obtained by laying down a piece of plastic, cardboard, canvas, plywood, or other material. Use soap or detergent with water to decontaminate areas such as entrance steps.

d. Prepare Personnel Entry Procedures. SOPs should address entry procedures to ensure the least risk of contamination to personnel and equipment inside the shelter and the least interference with tactical operations.

(1) General SOP Guidance. Guidance could include the following:

- The shelter attendant uses a detector to check all individuals for contamination. Unless the absence of contamination can be verified, assume that all individuals are contaminated and ensure that they perform the specific entry procedures.
- Chemical detector paper only detects agents in liquid form, most likely thickened, liquid agents. Unthickened agents absorb into overgarment materials and cannot be detected by detector paper. However, agent vapor may desorb from clothing inside shelters or vans and present vapor hazards.
- One of the attendant's main NBC duties is assisting personnel who are entering the shelter. He must help them decontaminate and remove their contaminated overgarments. The attendant must check himself periodically for contamination, especially the gloves.

(2) Detailed SOP Guidance. Describe the steps required for entry into a shelter. Give sufficient detail to avoid confusion. Standardize the procedures, and try to ensure that they are consistent with procedures for larger shelters. Specific instructions for entry into shelters or vans will vary depending on the system. (See applicable TMs/TOs for specific information from which entry procedures can be developed.) Detailed guidance could include the following:

- Use a chemical agent detector/detector paper or a radiac meter to check for the presence of contamination on individuals.

- Store contaminated items outside the shelter. Use protective covers, such as plastic or canvas, near the entrance; and ensure that items are not in the path of the entrance door.

- Decide whether grossly contaminated individuals need to enter the shelter.

e. Prepare Personnel Exit Procedures. SOPs describe the exit procedures for shelter occupants. Emphasize the importance of contamination reduction measures. Include the following in the SOP:

- Occupants leaving the shelter must put on their MOPP gear if an attack is imminent, occurring, or has occurred.

- Occupants may need to leave the shelter temporarily or for brief periods during an attack. They should carefully avoid contaminating their MOPP gear.

- One person may be assigned outside duties if a shelter or a van has more than one occupant. That person should be rotated if possible.

WARNING

When entries are performed in a contaminated environment, conduct monitoring inside the shelter every 15 minutes. If the detector changes color or the CAM indicates more than one bar, all individuals should mask until the source of contamination is located and removed and/or further tests indicate contamination is no longer present.

f. Prepare Shelter or Van Emergency Operations SOP. Personnel should familiarize themselves with the procedures to follow if equipment failure occurs and the alarm sounds. If an alert is given and the shelter or van is prepared for NBC operations, the alarm system should alert the occupants to any of several types of equipment failure. Individuals should handle equipment-related emergencies according to the proper organizational maintenance manual and unit SOP. The following paragraphs illustrate examples of potential situations that could occur:

- Sudden loss of positive pressure in the shelter. Lights and horns on a component module may signal an alarm. Occupants must put on their masks. An assigned occupant confirms this signal by checking power, lights, and horn. If the alarms are confirmed and compartment positive pressure is lost, occupants must remain masked while the assigned operator pursues the problem. The operator uses the organizational maintenance manual to locate the problem and if possible, repair it. The operator may not find the problem readily, or perhaps it cannot be repaired. In either case, the occupants must dress at the appropriate MOPP level.

- Malfunctioning of the gas-particulate filter unit. If the change-filter light comes on, the occupants must put on their masks. An assigned occupant determines if the filter is operating. He follows procedures in the organizational maintenance manual. If the filters need to be replaced, occupants must work in the appropriate MOPP gear until the filters are replaced, the air is purged, and the detectors indicate that masks can be removed.

WARNING
Never change filters during an NBC attack.

- Interior contamination by entry of contaminated item or personnel. If the interior becomes contaminated, the occupants must work in appropriate MOPP gear until the shelter air flow purges the agent from the air and a detector indicates the agent is no longer present. Wipe off any unabsorbed liquid agent from the equipment. Use a wet rag if moisture will not harm the equipment.

g. Outline Interior Procedures for Occupants. SOPs describe the step-by-step monitoring procedures. If the detector indicates the presence of contamination, occupants must mask immediately and check shelter pressure, door, and power. Replace filters according to the SOP and the appropriate operational maintenance manual.

WARNING
Ensure that the undressing area is well-ventilated and remove contaminated overgarments from the hot-line area to avoid vapor buildup.

h. Provide SOP Guidance for Shelter Attendants (Guards). Describe operating procedures for shelter attendants and nonshelter personnel, including visitors. Shelters or vans may be collocated with another unit. If so, assign nonshelter personnel as shelter attendants, when possible. Nonshelter personnel are those not essential to the operation of shelter or van mission-essential equipment. Consider the following for inclusion in the SOP:

- The shelter attendant monitors for agent presence once an alert has been issued, but before the attack. After an attack ceases, the attendant periodically monitors the outside air.

- Shelter attendants and nonshelter personnel assist in shelter or van operations. They perform such tasks as refueling generators, realigning antennas, and assisting in entry and exist of shelter personnel and visitors.

i. Determine Contaminated Equipment/Expendable Supplies Requirements.

(1) Contaminated Equipment and Clothing. SOPs provide guidance for the disposal of contaminated equipment and clothing. Contaminated equipment and clothing is kept out of the way of entering personnel. This helps avoid confusion and the spread of contamination.

(2) Expendable Items. The SOP addresses the storage of supplies for certain expendable items in protective shelters or vans. These are for use by individuals entering and leaving the shelter or van and could include—

- Decontamination materials, such as soap or detergent, bleach, M291 skin decontamination kits, and water.
- Decontamination equipment, including buckets, rags for wiping, and brushes for scrubbing.
- M256-series detector kits.
- Disposable field-expedient items.
- MOPP gear.
- BDUs in various sizes.
- Batteries.
- Plastic bags, trash cans, and other containers to be used for protecting uncontaminated items.

3. Entry and Exit Procedures

Entry and exit procedures are slow and risky procedures; therefore, the commander must allow only those personnel who are mission-essential to enter and exit. Entry and exit procedures for ship COLPRO are covered in detail in the CBR defense bill specific to that ship. Entry and exit procedures for a vehicle, fixed-site, or mobile shelter are specified in unit SOPs. Step-by-step instructions for all systems allow for safe transition from individual to COLPRO and back. Entry and exit operations can become high risk, especially those involving allied forces with different languages, equipment, and training.

a. Background.

(1) To illustrate procedures, various MOPP gear ensemble combinations can be used to depict procedures for entry and exit from a shelter, entry and exit from an armored vehicle, or entry and exit from a contaminated area. The MOPP gear ensemble may include—

- Ground personnel IPE: field protective mask with or without hood (based on the type of overgarment worn), a mask carrier, a helmet with CP cover, an individual weapon, an armored vest (if worn), and MOPP gear. (See shelter entry/exit instructions for personnel wearing BDO or JSLIST.)
- Combat vehicle and aircrew IPE: tank or aircraft mask with or without hood (based on the type of overgarment worn), a combat vehicle or aircraft crewman helmet, an individual weapon, an armored vest (if worn), and MOPP gear. (See shelter entry/exit instructions for individuals in a combat vehicle, an aircraft, or a hatch vehicular system without an air lock.)

(2) Each ensemble and type of enclosure has certain characteristics that dictate different steps. Therefore, procedures for a particular option are a composite of general guidelines for individual and COLPRO. Entry and exit procedures in this appendix illustrate the necessity to modify procedures based on their application and system configuration. Procedures presented herein give steps common to all entry and exit procedures. Actual procedures for a particular system should be more specific. The procedures should be in the system TM, and they should appear in the unit SOP.

b. Collective Protective Shelter with an Air Lock.

(1) Site Selection. Select a site for shelter erection that is free of liquid contamination. If setting up a shelter where the external agent concentration produces a relative chemical hazard reading of less than one bar on the CAM (indication that no agent is present), entry into the shelter is unlimited. Information on setting up, striking, and operating the shelter is contained in applicable equipment publications.

(2) Presence of an Agent. Where the external concentration of an agent produces a CAM reading of one bar or more, entries should be discontinued unless they are mission-essential. Personnel entering the shelter follow entry instructions when an external concentration of an agent is detected or suspected or when liquid contamination is detected or suspected on their overgarments. Other guidance includes—

- Establishing a hot line at least 4 feet from the personnel entry air lock and 14 feet for a litter air lock. Check the floor area between the hot line and the entrance for evidence of liquid contamination. Use both visual check and detector/monitoring equipment.

- Decontaminating the area if contamination is present. Cover it with a plastic sheet or similar impermeable material or find another area, if possible.

- Removing overgarments in a room or a covered area (if possible) that is separate from the room in which the entrance is located and establishing a hot line at the doorway between the two rooms. Keep the room with the air lock as clean as possible.

(3) Equipment. Do not allow equipment to enter the shelter unless it is known to be free of contamination. Pre-position decontamination kits, alarms, detector kit samplers, and a CAM inside the air lock. These components require periodic replenishment, depending on the frequency of entries. The CAM will require fresh batteries based on TM guidance.

(4) Procedures Prior to Entry. If contaminated, all personnel must be decontaminated before they are permitted entry. Use chemical and radiological detection equipment to check for the presence of contamination on individuals and their equipment.

WARNING

If the outer door has been opened, always purge the air lock before opening the inner door. When operating in a toxic environment, never open the outer and inner doors of the air lock at the same time.

(5) Entry Procedures. Personnel—

- Remove MOPP gear (except masks), BDUs, and boots outside the air lock. This procedure reduces the amount of possible contamination entering the air lock.
- Ensure that the air lock is empty and the inner door is closed.
- Enter the air lock and close the outer door.
- Check for contamination after the air lock is purged. If contaminated, the individual must return to the outside and decontaminate his skin. He then returns to the air lock and repeats the purge cycle and contamination check. If no contamination is detected, the protective mask is removed and placed in a plastic bag. The plastic bag is sealed and labeled. The individual opens the inner air lock door and enters the shelter. The plastic bag is carried into the shelter with the individual.

(6) Exit Procedures. Personnel—

- Ensure that the ambulatory air lock is empty and the outer door is closed.
- Enter the air lock and close the inner door.
- Put on protective masks and exit through the outer door.
- Put on BDUs and boots and then assume the established MOPP level before departing the immediate area of the exit door.

WARNING

Do not open the outer door until the protective mask has been donned.

c. Shelter Entry Instructions for Ground Troop Ensemble (BDO). Personnel can perform entry steps with or without assistance from a buddy or shelter attendant. However, personnel can perform some steps more easily and safely with help; therefore, the buddy system is strongly recommended. Personnel in the ground troop ensemble (BDO) may use the following 13 steps:

- Step 1. Use detector paper to determine the areas of gross liquid contamination on equipment and garments. Give special emphasis to these areas, and use field-expedient absorbents, such as sand, dirt, or rags, to remove the gross liquid contamination. Take special care to avoid touching these areas during overgarment doffing.

Note: If a radiological or biological hazard is present, lightly wipe down the overgarment with hot, soapy water before entering the shelter. This will dampen the overgarment and

reduce any secondary aerosolization of radiological or biological contamination while conducting doffing procedures.

- Step 2. Remove the LCE, mask carrier, and helmet before crossing into the shelter. If the hood is worn over the LCE, loosen the hood straps. Remove the M291 decontamination kit and the waterproof bag and keep them.
- Step 3. Untie the ankle cords and open the hook-and-pile fasteners and zippers of both trouser legs.
- Step 4. Undo the rear snaps of the jacket. Leave the top snap closed and undo the remaining two front snaps. Untie the waist cords, but leave the zipper closed.
- Step 5. Undo the shoulder straps. Remove them from beneath the arms and reattach them over the shoulder. (Use assistance if necessary.) Loosen the neck cord. Decontaminate the mask hood with the M291 decontamination kit. The M291 decontamination kit is a single-packet, one-step application. Open the packet, slip the fingers into the pad strap, and decontaminate the mask and hood thoroughly. The M291 decontamination kit can also be used to decontaminate equipment that needs to be taken into the shelter.
- Step 6. Decontaminate the gloves before rolling the hood. (Use assistance if necessary.) Leave the hood zipper closed. Grasp the hood by the straps and lift the hood off the shoulders and partially off the head until most of the back of the head is exposed. Roll the hood. Start at the chin, making sure that the zipper and neck cord are tucked into the roll, and work around the entire mask until the rolled hood will stay up, off the shoulders. Roll the hood tightly against the mask without pulling the hood off the back of the head.

Note: If your assistant is also entering the shelter, he also performs steps 1 through 6 before proceeding to step 7.

- Step 7. Undo the top jacket snap and open the jacket zipper. With one hand, pull the sleeve band over the hand without loosening the glove (make a fist if necessary). Remove that arm from the sleeve. Repeat the procedure for the other arm. Place the jacket away from the entry path.

- Step 8. Stand against a wall or other support for balance, and unsnap and unzip the trousers. (Use assistance if necessary.) Pull or have the assistant pull the trousers over the heels of the chemical overboots/GVOs for removal, or walk the trousers off by alternately lifting one foot while holding the trouser material to the ground with the other foot. Leave the overboots or GVOs on, and place the trousers away from the entry path.

Note: If your assistant, if also entering the shelter, he also performs steps 7 and 8 now before proceeding to step 9.

- Step 9. For a van with an air lock, go up the steps and loosen the overboot laces or GVO clasps. Open the door, remove one overboot or GVO at a time, toss it away from the steps, and step into the air lock with the exposed field boot. Do not touch exposed field boots on the exterior platform surface or stairs after removing the overboots or GVOs.

Note: When operating an air lock system in a contaminated environment, the protective entrance (PE) and the shelter interior must be monitored with detection equipment.

- Step 10. Enter the air lock and ensure that the door is closed. When the low-pressure indicator light in the PE module goes out, rotate the purge time clockwise to its full extent. Do not set the purge time until after the low-pressure light goes out.

- Step 11. Decontaminate the gloves again, and then decontaminate the bottom (rolled portion) of the hood. Wait for completion of the purge cycle. When the timer bell sounds, loosen the gloves but do not remove them.

- Step 12. Clear the air lock. A trained operator will use the CAM, if available, to detect and indicate the relative level of chemical agent vapor hazard present on personnel, clothing, or equipment as well as the interior of the PE or shelter. When sampling results are negative, stop breathing (hold your breath), remove the mask and hood, and place them in the waterproof bag. Remove the gloves and drop them to the floor. Keep the waterproof bag.

WARNING

A suspected false-positive reading must be verified with other monitoring equipment, such as M8/M9 detector paper and the M256 detector kit before proceeding further.

- Step 13. Enter the shelter. Continue to hold your breath, enter the shelter, and then resume breathing.

WARNING

When entries are performed in a contaminated environment, monitor them every 30 minutes. If detector/monitoring shows positive, all personnel should mask until the source of the contamination is located and removed and/or further tests indicate the contamination is no longer a threat.

d. Shelter Entry Instructions for Ground Troop Ensemble (JSLIST). Personnel in the ground troop ensemble (JSLIST) may use the following 13 steps for doffing IPE.

- Step 1. Use detector paper to determine the areas of gross liquid contamination on equipment and garments. Give special emphasis to these areas and use field-expedient absorbents, such as sand, dirt, or rags, to remove the gross liquid contamination. Take special care to avoid touching these areas during overgarment doffing.

Note: If a radiological or biological hazard is present, lightly wipe down the overgarment with hot, soapy water before entering the shelter. This will dampen the overgarment and reduce any secondary aerosolization of radiological or biological contamination while conducting doffing.

- Step 2. Remove the LCE, mask carrier, and helmet before crossing into the shelter. Remove the DKIE and the waterproof bag, and keep them.

Note: If the JSLIST is worn, the mask will not have a hood attached.

- Step 3. Unfasten the hook-and-pile fasteners at the wrist and ankles. Untie the bow in the coat and retention cord (if tied), unfasten the webbing strip snap, and allow the waist coat retention cord loop to retract. Touching only the outside surfaces of the coat, loosen the bottom of the coat by pulling the material at the bottom of the coat away from the body. Locate the trouser suspender snap couplers by feeling the outside of the coat. After locating the snap couplers, squeeze them to release the suspenders.

Note: Avoid touching the throat area. If the JSLIST is worn, pull the overgarment hood over the protective mask and secure it.

- Step 4. (Use an assistant if possible.) Decontaminate the mask using the M291 decontamination kit. Take special care to decontaminate the eyelens, face blank, barrel locks, and the front edge of the hood. The individual or assistant, if used, will decontaminate his gloves. Unfasten the barrel locks and loosen the drawstrings.

Note: Use the M291 to decontaminate any equipment taken into the shelter.

- Step 5. Unfasten the front closure hook-and-pile tape at the chin down to the chest, and then pull the slide fastener down to the chest area.

- Step 6. (Use an assistant if possible.) Grasp the hood by the outside surface near each barrel lock, lift the hood up off the head, and reverse-roll the hood one time while pulling it toward the back of the head to remove. If assistance is available, use the procedures outlined in FM 3-5, *NBC Decontamination* (MOPP gear exchange) to remove the hood.

Note: If the assistant is entering the shelter, he perform steps 1 through 6 before proceeding to step 7.

- Step 7. Unfasten the front closure hook-and-pile tape and slide the fastener from the chest down to the bottom of the coat. Grasp the front of the coat and pull the coat back until it is off the shoulders. Extend the arms behind the back and work them out of the sleeves. Move the coat away from the entry path.

- Step 8. Unfasten the hook-and-pile fastener tapes on the waistband of the trousers. Unfasten the two front closure snaps, and open the fly slide fastener. Grasp the trousers at the hips and pull them down to the knees (use assistant if possible). Pull or have the assistant pull the trousers over the heels of the boots for removal, or walk the trousers off by alternately lifting one foot while holding the trouser material to the ground with the other foot. Leave boots on and move the trousers away from the entry path.

Note: If the assistant is entering the shelter, he performs steps 7 and 8 before proceeding to step 9.

- Step 9. A ground-based shelter with an air lock entry is not applicable to the Patriot Missile System. For a van with an air lock, go up the steps and unfasten the two strap buckles on the MULO or unfasten the clasps on the BVOs/GVOs. Open the door, remove one MULO or overboot at a time, toss it away from the steps, and step into the air lock with the exposed combat boot (without the MULO). Do not touch the exposed combat boots on the exterior platform surface or stairs after removing the MULO or BVOs/GVOs.

Note: When operating an air lock system in a contaminated environment, the PE and the shelter interior must be monitored with detection equipment.

- Step 10. Enter the air lock, and ensure that the door is closed. When the low-pressure light in the PE module goes out, rotate the purge time clockwise to its full extent. Do not set the purge time until after the low-pressure light goes out.
- Step 11. Decontaminate the gloves again and wait for completion of the purge cycle. When the timer bell sounds, loosen the gloves but do not remove them.
- Step 12. A trained operator will use the CAM, if available, to detect and indicate the relative level of agent vapor hazard present on personnel, clothing, or equipment as well as the interior of the PE/shelter. When sampling results are negative, stop breathing (hold your breath), remove the mask, and place it in the waterproof bag. Remove the gloves and drop them to the floor. Keep the waterproof bag.
- Step 13. Enter the shelter, and resume breathing.

WARNING

A suspected false-positive reading must be verified with other monitoring equipment, such as M8 and/or M9 detector paper and the M256 detector kit before proceeding further.

WARNING

When entries are performed in a contaminated environment, monitor them every 30 minutes. If detector/monitoring shows positive, all personnel should mask until the source of the contamination is located and removed and/or further tests indicate the contamination is no longer a threat.

e. Shelter Exit Instructions for Ground Troop Ensemble. Overgarment donning procedures for exiting the shelter are less time-consuming and risky than doffing procedures. Whenever possible, ensure that replacement or spare overgarments are pre-positioned inside the shelter. For systems with a high rate of entry and exit, commanders must provide periodic resupply of spare overgarments. Personnel should follow these four steps:

- Step 1: Put on clean overgarments, overboots or GVOs, and gloves inside the shelter.
- Step 2: Check the compartment control module (CCM)/system control module (SCM) to ensure that the air lock is unoccupied. Stop breathing and step into the entrance, bringing the waterproof bag.

Note: The “occupied” (or purge) indicator being off on the CCM or the SCM does not positively indicate the lack of someone in the entrance.

- Step 3: Open the waterproof bag, remove the mask by the straps with one hand, and make sure that the hood is inside out over the front of the mask. Place the mask to the chin and face, and pull the head harness over the head. Tighten the cheek straps,

clear and seal the mask, and resume breathing. Unroll the hood, pull it over the head, and tighten the neck cord.

- Step 4: Exit the air lock, and ensure that the PE door is fully closed after exiting.

f. Shelter Entry Instructions for Combat Vehicle or Aircrew Ensemble. Use of the combat vehicle crewman mask or the aircraft crewman helmet with a different mask configuration requires differences in removing and handling the hood. The microphone cord hangs down to the shoulders. It can transfer contamination if not secured to the helmet. The microphone boom must be tucked in well against the helmet; otherwise, it snags the hood. In addition, the main power cord extends beyond the hood. If contaminated, it will be very difficult to decontaminate. To avoid these problems, personnel should use the following four steps:

- Step 1. If the vehicle helmet is worn underneath the hood, remove the hood (from back to front) from the helmet, remove it from around the eye lenses, and then remove it from the filter hose. If the hood is worn underneath the helmet, remove the helmet first, and then remove the hood from the mask in the manner described.

WARNING

Do not touch the eyelens area or the canister hose. These are difficult to decontaminate and are potential transfer hazards.

- Step 2. With the mask and helmet (if applicable) still on, remove the overgarment jacket and trousers. Use the same basic procedures outlined for personnel in the ground troop ensemble, with one exception. When performing the doffing procedure, bend at the waist to prevent the filter canister and hose from touching the body when the overgarment is being removed.

- Step 3. Proceed to the air lock or the hot line. Remove the boots when stepping into the air lock.

- Step 4. Just before entering the protective enclosure, remove the mask, helmet, and gloves. Seal the mask inside the waterproof bag, and enter the enclosure.

Note: For systems without an air lock, remove the mask, helmet, and gloves only after tests indicate the absence of vapor. Place the mask inside the waterproof bag, and seal the bag.

g. Shelter Exit Instructions for Combat Vehicle or Aircrew Ensemble. Overgarment donning procedures for exiting the shelter are less time-consuming and risky than doffing procedures. Whenever possible, ensure that replacement or spare overgarments are pre-positioned inside the shelter. For systems with a high rate of entry and exit, commanders must provide periodic resupply of spare overgarments. Personnel should follow these three steps:

- Step 1. Put on clean overgarments, overboots or GVOs, and gloves inside the shelter.
- Step 2. Check to ensure that the air lock is unoccupied. Stop breathing, and step into the entrance, bringing the waterproof bag.
- Step 3. Open the waterproof bag, don the mask, and put on gloves.

Note: For systems without air lock, all personnel don MOPP gear before anyone exits the protective enclosure. After the exit, those remaining reseal and purge the enclosure. When vapor contamination drops below detection levels, the remaining personnel can follow unmasking procedures.

h. Shelter Hatch Vehicular System Without an Air Lock. They are for entering and exiting a combat fighting vehicle in an NBC environment. They can be modified for shelters without an air lock. Before exiting for mission-essential tasks, personnel should don their SCALP or expedient protective clothing if available, such as wet-weather gear over their MOPP gear. When they complete the tasks, they should remove any expedient protective clothing in a top-to-bottom sequence. They must avoid touching clean overgarments with the cover exterior. If heavy liquid contamination is present and/or additional overgarments are available, personnel must perform two doffing procedures—one for the cover and one for the overgarment. Entry and exit procedures detailed herein assume the following conditions:

- The vehicle exterior is contaminated.
- The crew is operating buttoned-up with the NBC overpressure system on.
- The crew is wearing all of their protective clothing (except mask and gloves).
- The exit is for a mission-essential task, such as corrective maintenance.
- The overpressure system remains on throughout the exit and entry cycle.
- The tactical situation is relatively safe, such as during rearming and/or refueling operations.
- The vehicle is not under fire.
- Contact with the enemy is unlikely.
- Immediate movement is not anticipated.

(1) Entry Instructions. The loader on an armored fighting vehicle performs steps 1 through 8. When the loader completes step 8, other personnel perform step 1 and then steps 4 through 8. The last individual in must close the hatch. With the hatch closed, the crew performs steps 9 through 12.

- Step 1. Mount the vehicle over the left, front road wheel.

- Step 2. Decontaminate the hatch and the area around the hatch (approximately 4 feet in diameter) using the M11 or M13 DAP. Get the water can from the left bustle rack.

- Step 3. Flush the decontaminant from the loader's hatch and surrounding area after the required stand time.

- Step 4. Stand next to the loader's hatch, and remove any field-expedient protective items or wet-weather gear. Take care not to touch the exterior of any field-expedient protective clothing items, wet-weather gear, or gloves. Discard the removed items over the side.

- Step 5. Loosen the rain trousers, if worn. Roll them with the clean side out, while pulling them down to the ankles. Do not allow the contaminated side of field-expedient protective clothing items, rain gear, or contaminated gloves to touch the overgarment. Discard the rain trousers over the side.

- Step 6. Lift one foot, and remove the boot cover. Discard it over the side of the vehicle, and place that foot, with exposed boot, inside the decontaminated area. Repeat this procedure for the other foot.

- Step 7. Decontaminate gloves with the personal decontamination kit.

- Step 8. Lower yourself into the vehicle.

- Step 9. Resume operations as if in a contaminated environment.

- Step 10. Monitor the interior after a purge cycle and as the tactical situation permits. A crew member should begin sampling with detector/monitoring equipment.

- Step 11. Proceed with unmasking procedures if detector results are negative. If no symptoms appear, remove masks and gloves at the vehicle commander's order. Operate in the normal overpressure, buttoned-up mode.

- Step 12. Remain in MOPP gear if the detector results continue to be positive. Remain protected until the mission is complete and further decontamination can be performed or until further tests are negative.

(2) Exit Instructions. Perform the following steps to safely exit the vehicle:

- Step 1. Traverse the turret until the main gun is centered over the front slope.

- Step 2. Put on the mask and protective gloves.

- Step 3. The loader exits before any other crew member exits. Put on the SCALP, a field-expedient protective clothing item, or rain gear and boot covers. Carry the personal decontamination kit, and exit through the loader's hatch.

- Step 4. Remaining personnel move to the loader's station. Put on the SCALP, a field-expedient protective clothing item, or rain gear and boot covers. Carry the personal decontamination kit, and exit through the loader's hatch. The last person to exit must carry the decontamination apparatus and close the hatch.

- Step 5. The loader determines if the vehicle and surrounding area are contaminated.

Note: Follow the procedures for detecting the presence of chemical agents. For immediate detection, the loader uses M8/M9 paper for suspected liquid agents. The vehicle commander can use detector/monitoring equipment to detect any vapor agents. If the need to exit the vehicle is urgent, skip this time-consuming step and assume that the area is contaminated.

- Step 6. The crew may reduce its MOPP level and perform step 7 if no contamination is present. If detector/monitoring equipment indicates contamination is present, decontaminate the loader's hatch and an area approximately 4 feet in diameter around it.

- Step 7. Perform the task(s) that dictated the exit.

- i. Open-Air, Toxic-Free Area. Personnel who transition from a contaminated area to an open-air TFA follow a deliberate process to ensure that there is no transfer of contamination. Table B-1 outlines the procedures for processing personnel into an open air TFA.

Table B-1. CCA Processing Steps to Enter an Open-Air TFA

Processing Steps	BDO	CPO	JFIRE	EOD Level A	Attendant
Station 1					
Arrival and Initial Decontamination Area					
<ol style="list-style-type: none"> Split into two-person buddy teams. (Note: Try to team with an individual wearing the same protective overgarment as yourself.) Check each other for visual evidence or signs of contact hazard (liquid, solid, or dusty). (Note: Special interest should be given to gloves, hood/mask, and M9 paper.) Disconnect hook and pile fasteners for hose/canister and allow to hang freely. 	*	*	*	*	
<ol style="list-style-type: none"> Check each other for visual evidence or signs of contact hazard (liquid, solid, or dusty). (Note: Special interest should be given to gloves, hood/mask, and M9 paper.) 	*	*	*	*	
<div style="border: 2px solid black; padding: 10px; text-align: center;"> <p>WARNING</p> <p>Using two fingers, apply pressure to the mask front voice mitter and to the beard of the JFIRE to hold the mask firmly in place and prevent loss of mask seal integrity.</p> </div>			*		
<ol style="list-style-type: none"> Thoroughly decontaminate yourself and all exterior equipment, including the weapon, using the M295 decontamination kit provided. Buddies should assist each other in decontaminating hard-to-reach areas. Special interest should be given to gloves, hood/mask, and filter canisters. Discard used M295 decontamination kits into the trash hamper. EOD buddy teams will spray the 5 percent chlorine solution, using the multipurpose sprayer (pump-presurized) to all exposed areas of the Level A suit. Proceed to the weapons clearing, washing and holding area. 	*	*	*		
	*	*	*		
				*	
Weapons Clearing, Washing, and Holding Area					
<ol style="list-style-type: none"> Complete weapons clearing/turn-in (if required) before decontaminating gloves and overboots. 	*	*	*		
<ol style="list-style-type: none"> Step into the boot wash tray. 	*	*	*	*	
<ol style="list-style-type: none"> Wash the gloves in the decontaminating tub. 	*	*	*	*	
<ol style="list-style-type: none"> Rinse the gloves in the rinse tub. 	*	*	*	*	
<ol style="list-style-type: none"> Proceed directly to the equipment removal area if a holding area is not established. 	*	*	*	*	

Table B-1. CCA Processing Steps to Enter an Open-Air TFA (Continued)

Processing Steps	BDO	CPO	JFIRE	EOD Level A	Attendant
Station 1 (Continued)					
Holding Area					
<p>Note: EOD personnel wearing Level A suits will proceed directly to Station 3 (overboot removal area). Decontaminate boots in foot trays provided along the way.</p> <p>The holding area is designed to allow shade for personnel waiting to process. Informational signs may be developed for personnel to read while waiting. This is a location to post installation-specific information. The following is general information that could be posted within the area:</p> <ol style="list-style-type: none"> 1. Carefully read the notices posted on the information boards prior to beginning your processing. 2. Remove your individual protective equipment in the order specified by the posted instructions. 3. Take cover and don protective mask and gloves immediately if the CCA or TFA complex comes under attack or is otherwise compromised. 4. Discard used M295 decontamination kits into the trash hamper. 				*	
External Equipment Removal Area					
<div style="border: 2px solid black; padding: 10px; width: fit-content; margin: 0 auto;"> <p style="text-align: center;">WARNING</p> <p>Take care when doffing items. Do not remove mask or any protective clothing. Contact hazard transfer to exposed skin and/or the respiratory tract can lead to sickness or death.</p> </div>					
1. Undo the hook and pile attachments on the hood underarm straps.	*				
2. Reattach the underarm straps over the shoulder.	*				
3. Remove all external items other than the protective mask and overgarment, and place them on racks. These items include the helmet, vest (aircrew), webgear, mask carrier, flak vest, cold-/wet-weather gear, and other nonessential items. (Important: Do not let previously decontaminated equipment touch the ground.)	*	*	*		
4. Empty all pockets and place items in storage hampers.	*	*	*		
5. Proceed to Station 2, mask wipe and hood removal area.	*	*	*		
6. Decontaminate boots in foot trays provided along the way.	*	*	*		

Table B-1. CCA Processing Steps to Enter an Open-Air TFA (Continued)

Processing Steps	BDO	CPO	JFIRE	EOD Level A	Attendant
Station 2					
Mask Wipe and Hood Removal Area					
<div style="border: 2px solid black; padding: 5px; margin-bottom: 10px;"> <p style="text-align: center;">WARNING</p> <p>Using two fingers, apply pressure to the mask front voice mitter and to the beard of the JFIRE to hold the mask firmly in place and prevent loss of mask seal integrity.</p> </div>					
<u>Individual</u>					
<ul style="list-style-type: none"> Firefighters will hold masks in place with two fingers on the beard/breathing valve. 	*	*	*	*	
<u>Attendant</u>					
<ul style="list-style-type: none"> Loosen the individual's hood drawstring. 	*				*
<ul style="list-style-type: none"> Reattach underarm straps over the shoulder (if not already completed). 	*				*
<ul style="list-style-type: none"> Wipe down eyelens outserts and around the filter element using the 5 percent chlorine solution. 	*				*
<ul style="list-style-type: none"> Wipe all exposed areas of the CW mask (lens and canister) with the 5 percent chlorine solution. 		*			*
<ul style="list-style-type: none"> Repeat wipe-down procedures with water. 	*	*	*		*
<ul style="list-style-type: none"> Pull the hood over individual's head and unsnap the hood straps with pliers. Cut the hood temple straps if necessary. 	*				*
<ul style="list-style-type: none"> Pull the hood off the mask, and drop the hood in the hamper. 	*				*
<u>Attendant and Individual</u>					
<ul style="list-style-type: none"> Decontaminate and rinse gloves in tubs provided. 	*	*	*		*
<u>Individual</u>					
<ul style="list-style-type: none"> Proceed to Station 3, overboot removal area. 	*	*	*		*
Important: JFIRE personnel proceed directly to Station 3, protective overgarment removal area.			*		

Table B-1. CCA Processing Steps to Enter an Open-Air TFA (Continued)

Processing Steps	BDO	CPO	JFIRE	EOD Level A	Attendant
Station 3 (Continued)					
Overboot Removal Area					
<div style="border: 2px solid black; padding: 5px;"> <p style="text-align: center;">WARNING</p> <p>While waiting in line, read all instructions for this station and watch other processing teams in front of you.</p> </div>					
1. Proceed to the first available bench as a buddy team, and sit on the bench with boots resting on the dirty side of the bench.	*	*		*	
2. Undo both of hook and pile fastener trouser leg fasteners and unzip leg zippers.	*	*		*	
3. Undo all overboot fasteners.	*	*		*	
4. Pull up the outer pant leg of the Level A suit to fully expose the bunker boots.	*	*		*	
5. One individual will lift his leg closest to the center of the bench and rest it on the bench as the buddy removes the overboot/bunker boot and drops it into the hamper. Once the overboot/bunker boot is removed, place the foot on the clean side of the bench (the bench is now straddled).	*	*		*	
6. The other individual will complete the same procedures until both individuals are straddling the bench.	*	*		*	
7. Process the remaining boot in the same manner utilizing the buddy system.	*	*		*	
8. Wipe down the bench with 5 percent chlorine solution.	*	*		*	
9. Decontaminate and rinse gloves in tubs provided, and proceed to the protective overgarment removal area.	*	*		*	
Protective Overgarment Removal Area					
Important: Working as a buddy team, remove the overgarment, bunker pants, or Level A suit. One individual will perform the procedure first, and then the buddy will perform it.	*				
1. BDO.	*				
a. Trouser Removal.					
<u>Buddy</u>	*				
• unfasten front fly closure.					
<u>Individual</u>					
•					

Table B-1. CCA Processing Steps to Enter an Open-Air TFA (Continued)

Processing Steps	BDO	CPO	JFIRE	EOD Level A	Attendant
Station 3 (Continued)					
Protective Overgarment Removal Area (Continued)					
Trousers Removal (continued).					
<u>Buddy</u>					
<ul style="list-style-type: none"> • Lower the individual's BDO trousers to his knees. (Note: Do not turn BDO trousers inside out when removing them.) 	*				
<u>Individual</u>					
<ul style="list-style-type: none"> • Steady self by holding on to the rack and extending feet back one at a time. 	*				
<u>Buddy</u>					
<ul style="list-style-type: none"> • containment hamper. 	*				
<u>Individual and Buddy</u>					
<ul style="list-style-type: none"> • Decontaminate and rinse gloves in tubs provided. • Repeat procedures for buddy. 	*				
b. Jacket Removal					
<u>Buddy</u>					
<ul style="list-style-type: none"> • Loosen zippers, undo hook-and-pile fasteners, and untie the drawstring on the front of the jacket. 	*				
<ul style="list-style-type: none"> • Undo hook and pile fastener attachment points on each sleeve cuff. 	*				
<u>Individual</u>					
<ul style="list-style-type: none"> • Turn and face away from the buddy, make a fist with both hands, and hold arms behind body. 	*				
<u>Buddy</u>					
<ul style="list-style-type: none"> • Pull the jacket down and away from the individual's shoulders, helping to remove his arms from the sleeves one at a time. For elastic sleeve cuffs, the jacket comes off inside out. For hook and pile fastener sleeve cuffs, the jacket comes off right side out. 	*				
<ul style="list-style-type: none"> • Place jacket in the containment hamper. 	*				

Table B-1. CCA Processing Steps to Enter an Open-Air TFA (Continued)

Processing Steps	BDO	CPO	JFIRE	EOD Level A	Attendant
Station 3 (Continued)					
<p>b. Jacket Removal (continued).</p> <p><u>Individual and Buddy</u></p> <ul style="list-style-type: none"> • Decontaminate and rinse gloves in tubs provided. • Repeat the jacket removal steps for the buddy and proceed to Station 4, glove removal area. <p>2. JFIRE (Bunker Trousers and CPO Trouser Removal).</p> <p><u>Firefighter 1</u></p> <ul style="list-style-type: none"> • Push bunker pants down to the top of bunker boots. • Reach through the CPO jacket, and pinch the hasp to release suspenders. <p><u>Firefighter 2</u></p> <ul style="list-style-type: none"> • Unsnap and untie the waist elastic coat retention cord. • Unfasten the waistband hook-and-pile fastener tapes and front fly closures. <p><u>Firefighter 1</u></p> <ul style="list-style-type: none"> • Turn and face away from firefighter 2. • Steady self by holding on to the rack. Extend feet back, one at a time. <p><u>Firefighter 2</u></p> <ul style="list-style-type: none"> • Remove bunker trousers, boots, and CPO trousers at the same time; and place them into the containment hamper. • Place an uncontaminated, disposable plastic boot or sock on the foot before touching the ground. • Repeat the process for the other leg. 	<p>*</p> <p>*</p>		<p>*</p> <p>*</p> <p>*</p> <p>*</p> <p>*</p> <p>*</p> <p>*</p>		

Table B-1. CCA Processing Steps to Enter an Open-Air TFA (Continued)

Processing Steps	BDO	CPO	JFIRE	EOD Level A	Attendant
Station 3 (continued)					
Protective Overgarment Removal Area (continued)					
<p>2. JFIRE (Bunker Trousers and CPO Trouser Removal) (continued).</p> <p><u>Firefighters 1 and 2</u></p> <ul style="list-style-type: none"> Reverse this process (e.g., Firefighter 1 now performs Firefighter 2 actions and vice versa). <p><u>Firefighters 1 and 2</u></p> <ul style="list-style-type: none"> Decontaminate and rinse gloves in tubs provided. Note: Firefighters will remove the CPO jacket according to the CPO removal procedures below. <p>3. CPO.</p> <p>a. Trouser Removal.</p> <p><u>Individual</u></p> <ul style="list-style-type: none"> Reach through the jacket and pinch the hasp to release the suspenders. <p><u>Buddy</u></p> <ul style="list-style-type: none"> Unsnap and untie the waist elastic retention cord. Unfasten the waistband hook-and-pile fastener tapes and front fly closures. <p><u>Individual</u></p> <ul style="list-style-type: none"> Turn and face away from the buddy. <p><u>Buddy</u></p> <ul style="list-style-type: none"> Lower the individual's trousers to his knees. (Note: Do not turn the trousers inside out as they are removed.) <p><u>Individual</u></p> <ul style="list-style-type: none"> Steady self by holding on to the rack. Extend feet back one at a time. <p><u>Buddy</u></p> <ul style="list-style-type: none"> Remove the individual's trousers, and place them into the containment hamper. 			<p>*</p> <p>*</p> <p>*</p> <p>*</p> <p>*</p> <p>*</p> <p>*</p>		

Table B-1. CCA Processing Steps to Enter an Open-Air TFA (Continued)

Processing Steps	BDO	CPO	JFIRE	EOD Level A	Attendant
Station 3 (Continued)					
Protective Overgarment Removal Area (Continued)					
Trousers Removal (continued).					
<u>Individual and Buddy</u>					
• Decontaminate and rinse gloves in tubs provided.		*			
• Repeat procedures for buddy.		*			
b. Jacket Removal.					
• Individual will disconnect the canister and hose assembly and secure it away from the CPO jacket.			*		
• The buddy will loosen zippers and hook-and-pile tape on the front of the jacket, jacket sleeves and hood.		*	*		
• Individual will turn and face the buddy. Lean slightly forward with chin out and head up.		*	*		
• The buddy will stretch the CPO hood out and pull it back away from the head.		*	*		
• Individual will turn and face away from the buddy, make a fist with both hands, and hold arms behind the back.		*	*		
• The buddy will pull the jacket down and away from the shoulders, helping remove the arms from the sleeves one at a time.		*	*		
Note: The arms should come out of the coat without turning the sleeves inside out.		*	*		
• The buddy will place jacket in the containment hamper.					
<u>Individual and Buddy</u>		*	*		
• Decontaminate and rinse gloves in tubs provided.		*	*		
• Reverse roles and repeat above jacket removal procedures.		*	*		
• Proceed to Station 4.		*	*		
4. EOD—HAZMAT Level A Suit.		*	*		
Important: Each of the following steps requires the assistance of a buddy.					
a. Unfasten the belt inside the suit, and don gloves. (The gloves are stored inside the Level A suit.)				*	

Table B-1. CCA Processing Steps to Enter an Open-Air TFA (Continued)

Processing Steps	BDO	CPO	JFIRE	EOD Level A	Attendant
Station 3 (Continued)					
Protective Overgarment Removal Area (Continued)					
<p>4. HAZMAT Level A Suit (continued).</p> <ul style="list-style-type: none"> b. Open the hook-and-pile closure and zipper. c. Pull the suit down to knee level, ensuring that the outside of the suit does not contact the uniform or skin in the process. d. Remove the suit, one leg at a time, by lifting the leg backward and pulling it free from the suit. e. Decontaminate and rinse gloves in tubs provided, and place an uncontaminated disposable plastic sock or boot on the exposed foot before it touches the ground. <p>(Note: Once the suit is unzipped, the CW mask can be switched from bottled air to ambient air.)</p> <ul style="list-style-type: none"> f. Place the suit in the contaminant hamper. g. Decontaminate and rinse gloves in tubs provided. h. Proceed to Station 4, glove removal area. 				* * * * * * *	
Station 4					
Glove Removal Area					
<p>WARNING</p> <p>Avoid contacting the outside of the rubber glove with unprotected hands.</p>					
<ul style="list-style-type: none"> 1. Work off both rubber gloves at the same time, and drop into the contaminant hamper. 2. Work off the fire/CW protective gloves at the same time until they are halfway off, and drop them into contaminant hamper. 3. Proceed to the mask-monitoring/removal area. 	*	*	*	*	

Table B-1. CCA Processing Steps to Enter an Open-Air TFA (Continued)

Processing Steps	BDO	CPO	JFIRE	EOD Level A	Attendant
Station 4 (Continued)					
Mask Monitoring Removal Area					
<div style="border: 2px solid black; padding: 5px; text-align: center; margin-bottom: 10px;"> <p>WARNING</p> <p>Avoid contact with the outside of the rubber glove with unprotected hands.</p> </div> <p><u>Individual</u></p> <ul style="list-style-type: none"> Face the attendant, spread legs apart, and hold arms out to the side with palms up. <p><u>Vapor Hazard Area Attendant</u></p> <ul style="list-style-type: none"> Monitor individual using the CAM. (See procedures below.) If the CAM bar readings are less than the CAM monitoring chart, the individual will remove the mask according to the mask removal procedures below. If the CAM bar readings are equal to or greater than what is listed in the CAM monitoring chart, the individual will don clean gloves and proceed to the uniform/undergarment removal area. 					
<ul style="list-style-type: none"> Have the individual face away and extend his feet back, one at a time. Monitor the bottom of each foot. Pay special attention to the palms, wrists, ankles, neck, and bottoms of feet. 	*	*	*	*	1 per monitoring line
	*	*	*	*	
	*	*	*	*	
<p>security number on a mask ID tag before the individual removes the mask.</p> <p><u>Attendant</u></p> <ul style="list-style-type: none"> Ask the individual for his name and social security number, and write it on the mask tag. Bring the hood over the individual's head. <p><u>Individual</u></p> <ul style="list-style-type: none"> Use both hands, grasp the lower head harness straps, and take three deep breaths, holding the last one. 					
	*	*	*	*	

Table B-1. CCA Processing Steps to Enter an Open-Air TFA (Continued)

Processing Steps	BDO	CPO	JFIRE	EOD Level A	Attendant
Station 4 (Continued)					
Mask Monitoring Removal Area					
<u>Individual</u>	*	*	*	*	
<ul style="list-style-type: none"> • Pull the mask out and away from the face, remove mask, and place it on the table. 					
<u>Attendant</u>	*	*	*	*	
<ul style="list-style-type: none"> • Attach the mask tag to the head harness buckle and place the mask in the container. 					
<u>Individual</u>	*	*	*	*	
<ul style="list-style-type: none"> • Continue holding breath and eyes open until reaching the TFA. 					
Uniform/Undergarment Removal Area					
<div style="border: 1px solid black; padding: 10px; margin: 0 auto; width: 80%;"> <p style="text-align: center;">CAUTION</p> <p>Bending too far forward in the mask may cause the seal of the mask to leak on some individuals. Use the boot step to elevate the foot when untying the combat boot laces.</p> </div>					
<ol style="list-style-type: none"> 1. Place foot on boot step, and untie combat boots. 	*	*	*	*	
<ol style="list-style-type: none"> 2. Hold onto the rack for balance, and remove combat boots or disposable booties. The boot remover may be used if desired. 	*	*	*	*	
<ol style="list-style-type: none"> 3. Remove BDU shirt and place it in the hamper. 	*	*	*	*	
<ol style="list-style-type: none"> 4. Remove BDU trousers, and place them in the hamper. 	*	*	*	*	
<ol style="list-style-type: none"> 5. Return to the mask-monitoring/removal area. 	*	*	*	*	
<u>following emergency steps:</u>	*	*	*	*	
<ol style="list-style-type: none"> 1. Stop CCA operations immediately. 	*	*	*	*	
<ol style="list-style-type: none"> 2. Monitor the surrounding area within the VHA to verify the levels, and look for any potential hot spots. 	*	*	*	*	

Table B-1. CCA Processing Steps to Enter an Open-Air TFA (Continued)

CCA Processing Steps	BDO	CPO	JFIRE	EOD Level A	Attendant
Station 4 (Continued)					
Uniform/Undergarment Removal Area					
3. Decontaminate hot spots with decontamination kits, washing with 5 percent chlorine solution, sealing, removing, covering, etc. 4. Continue CCA operations once levels are below the ones listed in the CAM monitoring risk matrix chart below. 5. If levels have not changed— <ul style="list-style-type: none"> • Check the serviceability of CAMs. Replace them as necessary, and remonitor area. • Verify the wind direction. Ensure that the CCA is still located downwind or crosswind. 					
<u>CAM Monitoring – Risk Matrix Chart</u>					
<u>CAM SCALE</u>	<u>CAM BAR READING</u>				
H	3 or more bars (Do not remove protective mask)				
G	1 or more bars (Do not remove protective mask)				

4. Wartime Shelter Preparation and Operation

a. Shelter Organization and Operation. The commander exercises normal C² over forces in shelters to ensure that personnel are available to continue the wartime mission. A shelter command structure should reflect the typical unit command structure. The same personnel who perform these functions during peacetime should continue their duties during wartime shelter operations. The shelter preparation and organization involves designating SMTs; preparing for collection and warning; understanding preattack, during-attack, and postattack recovery actions; understanding CCA operations; and making provisions for IPE disposition. For example—

- The owning organization commander is the commander for all organizational shelters.
- The owning organization first sergeant is the administrative first sergeant for all organizational shelters.

b. Shelter Management Teams. SMTs are preidentified by the unit commander for each shelter and perform the following functions:

- Operate the shelter.
- Select personnel to perform shelter operational tasks.
- Control entry, exit, and internal shelter occupant location.
- Monitor for NBC contamination.
- Brief personnel exiting the shelter into a contaminated environment on the effects of contamination and the exposure limits.
- Perform immediate decontamination.
- Establish a CCA and TFA for each shelter, if appropriate.
- Establish radiological exposure control procedures for each shelter if the threat warrants.
- Detect and measure gamma radiation and CW agents.
- Determine if contamination is present inside and immediately outside the shelter.

c. Preattack Actions. Units and SMTs should—

- Recall shelter teams and activate shelters.
- Improve shelter survivability inside and out.
- Recall personnel not performing mission-critical tasks to their assigned shelter at the proper readiness stage.

d. During-Attack Actions. SMTs should—

- Suspend shelter in and out processing and secure the doors.
- Instruct personnel to take whatever cover is available.
- Instruct personnel to don IPE items if required.
- Monitor overpressure and filtration systems for damage when applicable.
- Monitor for contamination.

e. Postattack Actions. SMTs should—

- Check for damage, unexploded ordnance (UXO), casualties, and contamination.
- Implement radiological exposure control procedures for a nuclear/radiological hazard.
- Initiate decontamination procedures for people, supplies, and equipment entering the shelter.
- Implement contamination control/avoidance procedures for all personnel performing outside, mission-essential tasks.
- Wear IPE as directed by the commander.

f. Shelter Equipment. Each shelter should have a shelter kit. Contents may vary; however, each kit should have—

- A first aid kit that is sufficient for the expected number of personnel and their likely medical needs.
- A floor plan identifying the preplanned areas and the emergency, utility shutoff locations.
- A base grid map with medical facilities, shelters, control centers, and key phone numbers indicated.
- SMT identification devices (e.g., badges or armbands).
- Operational manuals for the shelter system, support equipment, and specialized equipment.
- Shelter directives and operational checklists to cover all shelter operation aspects.

g. CCA Operations. CCAs can be part of a shelter or they can be in the open air. CCAs are essential to sustained operations in an NBC environment. They limit the spread of contamination into a TFA so that personnel can work or obtain rest and relief without wearing IPE. They also provide a controlled environment in which to safely remove contaminated IPE. CCA operations include—

- Developing procedures and checklists for assistants and signs for processing personnel.
- Obtaining supplies and equipment for stocking and resupply.
- Covering shelter and CCA supplies and equipment that are susceptible to contamination under covers.
- Processing personnel and material through a CCA before entering a designated TFA.

- Decontaminating IPE (except the overgarment) as soon as practical after contamination occurs.

- Considering all exposed IPE as contaminated when liquid contamination is present.

- Bagging and removing liquid-contaminated IPE and waste from the CCA as soon as possible to reduce vapor levels, and bagging and removing trash from shelters.

h. IPE Disposition. Process contaminated IPE according to the overgarment TO/TM instructions. CCA personnel should—

- Prepare serviceable protective masks for reuse.
- Discard contaminated, permeable IPE.
- Retain other equipment not addressed above for reuse.

i. Checklist Requirements. In most cases, checklists should be specific enough to allow an untrained person to accomplish all needed actions. Checklists may address the following areas—

- Casualty Care. Establish a first aid and buddy care capability for the shelter.
- Security. Secure all entry and exit points when the shelter is operational. Use only one point for entrance and exit.

- Fire Control. Inspect the shelter during each shift to identify potential fire sources.

- Supply. Coordinate consumable resupply with the control center responsible for the consumables.

- Subsistence. Provide subsistence.

- Administrative. Keep an events log of the shelter from activation until deactivation.

- Mortuary. (see Joint Pub 4-06, *Joint Tactics, Techniques, and Procedures for Mortuary Affairs in Joint Operations*).

- Sleeping. Plan for and operate a sleeping area for the shelter.

5. Classes of Site Collective Protection and Associated Protective Equipment

a. Classes of Fixed-Site Collective Protection. For fixed-site COLPRO facilities, classes of protection are defined according to the degree of protection provided.

(1) Class I, Pressurized Shelters. Class I structures are pressurized, fully integrated shelters that provide active protection. These systems have high-efficiency air

filtration and positive-pressure (overpressure) systems. Dampers control ventilation openings automatically. These facilities require a CCA and a purging air lock to accommodate mission-required entries and exits. The protection afforded by a pressurized shelter depends on the filter capacity to remove agents. Class I facilities are divided into four subclasses:

- Class I-A, Fully Integrated. Class I-A structures include buildings constructed tightly enough to integrate COLPRO with maximum efficiency. The CCA can be internal to the building or it can be located outside.
- Class I-B, Partially Integrated. Class I-B structures require permanent modifications, such as ductwork and sealing, to all or part of a facility to provide COLPRO for its occupants. Heating and cooling must be upgraded. The CCA may be permanently installed inside or located outside.
- Class I-C, Expedient. Class I-C structures require that selected portions of the building be sealed by temporary measures, such as plastic sheeting and tape. In turn, transportable filter units are temporarily mounted to the building to provide COLPRO. Heating/cooling may or may not be employed, and a temporary CCA would need to be established.
- Class I-D, Secondary Enclosure. Class 1-D enclosures can be used for temporary protection. The buildings are not suitable for sealing, but they are suitable for the use of portable internal enclosures or liner systems, such as the M28 or M20A1 CPE. Such application allows for the use of existing facilities and auxillary heating and cooling systems.

(2) Class II, Intermediate Shelters. This class of shelters provides continuous protection in buildings that have forced ventilation. It protects against CB and/or radiological agents entering through outside air intakes. Air filtration equipment is applied to the outside air intakes and the normal rates of introduction of outside air with little or no overpressure are maintained.

(3) Class III, Passive Shelters. This class of shelters are unventilated and may be used for an incident such as a transient release of a TIC. Limited protection is achieved by closing the building and turning off the HVAC before the cloud arrives.

b. Protective Entrances. PEs provide an interface between the contaminated environment and the protected enclosure. PEs include the following types—

(1) Protective Entrance Without an Air Lock. In a contaminated environment, overpressure systems not having a PE (air lock) must prevent contamination from entering the enclosure. Drills and procedures must be established for this purpose. A system without an air lock consists of a clean interior shelter area only. During a liquid or vapor chemical attack, the system must remain closed and personnel must not enter or exit. Opening the doors allows contamination inside, and personnel must assume a higher MOPP level until the interior is purged or decontaminated.

(2) **Protective Entrance With an Air Lock.** An air lock prevents contamination from entering the enclosure. The air lock is pressurized, and contamination is eliminated through the use of filtered air. Air pressure in the entrance is slightly less than that in the protective enclosure but slightly more than outside pressure. An air lock is a transition enclosure—a protected entryway in which personnel wait for a period of 3 to 5 minutes before entering or exiting the TFA. The main function of the air lock is to prevent direct vapor transport into the TFA. During the air lock-purging period, the flow of filtered air through the air lock flushes out airborne contaminants introduced with the opening of the outer door. The air lock also ensures that TFA overpressure is not compromised during the entry or exit. Air passing through the air lock purges contaminants that might enter during entry or exit of personnel or equipment. This air comes from the protective enclosure, the filter unit, or both. Different PE configurations create variations of the overpressure category. The variations are those with a single air lock and those with a two-stage air lock.

(a) **Protective Entrance With Single Air Lock.** Many shelters modified for COLPRO use a single-compartment protective entrance. An example is the M12 protective entrance (Figure B-1). Using a dedicated filter unit for the air lock helps maintain TFA integrity. Before entering the air lock from a contaminated area, personnel must remove their MOPP gear except gloves and masks. Minor exposure to a chemical agent vapor is possible between the overgarment removal and the entrance into the air lock. Clothing tends to absorb any chemical agent vapor in the atmosphere during this brief exposure. The amount of agent absorbed depends on the agent concentration in the atmosphere, the length of exposure, the type of agent, the type of clothing exposed, and the climatic conditions. The air purge in the air lock flushes out the contaminated air. It also reduces the amount of absorbed agent on clothing before the individual enters the protective shelter. After an individual and/or piece of equipment enters the protective shelter, monitoring ensures that hazardous levels of the agent are not carried inside.

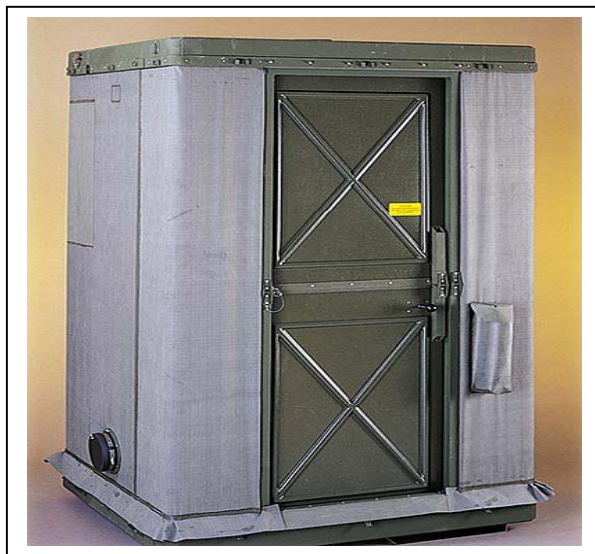

Figure B-1. M12 Protective Entrance

(b) **Protective Entrance with Two-Stage Air Lock.** Adding a CCA to a single air lock system creates a two-stage air lock (Figure B-2 [page B-34]). Entering

personnel remove MOPP gear in the CCA. This system affords better control of liquid and vapor hazards during entry and exit.

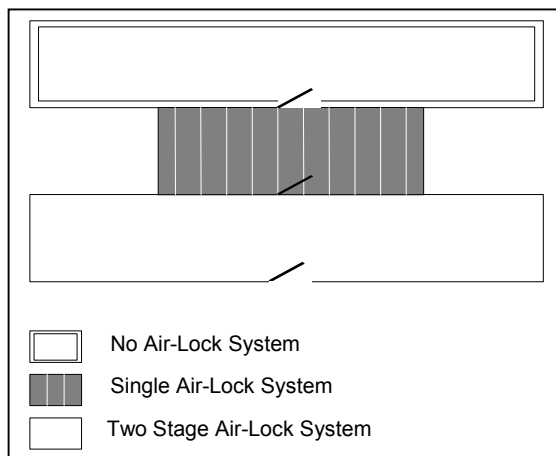

Figure B-2. Collective-Protection Entrance Configurations

(3) Integral Protective Entrances. Integral PEs are those that are included in the manufacturing process for the shelter. Integral PEs are designed to offer improved accessibility, more convenient storage and transport, and reduced setup time. For example, the contamination avoidance protective entrance (CAPE) is on every Standardized Integrated Command Post System (SICPS) shelter fielded. The CAPE helps to minimize liquid and vapor contamination during limited entry/exit. Occupants must be masked and the shelter purged following use. There are two types of integral PEs—internal and external. Integral PEs are smaller than the detachable PEs and require less airflow during the purge cycle.

- Internal Integral PE. Deployed internally, the integral PE can remain in its functional configuration and need not be stowed for transport. Since it is contained within the shelter, it is much less vulnerable on the battlefield.
- External Integral PE. The external integral PE is used for shelters that cannot sacrifice the internal space. The external integral PE must be stowed for transport.

c. Establishment of Protective Shelters. There is equipment in the US DOD inventory that can be used to establish protective shelters. Examples include the fan filter assembly (FFA) 580; the USAF A/E32C or Army C-100 air conditioner; the field depolyable environmental control unit (FDECU) with CB hardening kit and M28 CPE blower, a filter, and air ducts; the chemically/biologically hardened air management plant (CHAMP); and the M96 modular collective protective equipment (MCPE) filter unit.

(1) Fan Filter Assembly 580. The FFA 580-filter unit for is a 600 CFM filter. The FFA 580 employs the modular CPE filter set, which is the most widely used filter set among the USA, USN, and USAF. This unit provides an option for integrating filtration with air conditioning, and it has the lowest hardware and operating costs among transportable filter units employing standard military filters. Where the building would

require more than the capacity of the FFA 580 unit, the M49 filter unit or a large-capacity, commercial filter unit built to military specifications should be considered.

(2) Modification of Environmental Control Units. Short of major modifications to the HVAC systems, users could modify an existing environmental control unit by adding a GPFU.

Appendix C

HUMAN FACTOR EFFECTS OF MISSION-ORIENTED PROTECTIVE POSTURE

1. Background

This appendix provides information on the physiological and psychological stress incurred while wearing the BDU, BDO, or JSLIST. Once an accurate assessment of the NBC threat has been made, the key to selecting an appropriate MOPP level lies in understanding the physiological and psychological stresses placed upon the wearer. Multiple physiological and psychological factors can impact unit personnel, but there are countermeasures that can be taken to mitigate the effects.

2. Physiological Factors

a. Heat Stress. Body temperature must be maintained within narrow limits for optimum physical and mental performance. The body produces more heat during work than at rest. Normally, the body cools itself by the evaporation of sweat and the radiation of heat at the skin surface. MOPP gear restricts these heat loss mechanisms because of its high insulation and low permeability to water vapor. In addition, physical work tasks require more effort when personnel wear protective clothing because of its added weight and restricted movement. Work intensity is also a major contributing factor to heat stress that can be managed by leaders. Military work can be categorized as light, moderate, or heavy. Table C-1 provides examples of work activities that can be used as guides in estimating the work intensity for a particular mission or task.

Table C-1. Work Intensities of Military Tasks¹

Light (Easy) Work	Moderate Work	Heavy (Hard) Work
Weapons maintenance	Walking on loose sand at 2.5 mph with no load	Walking on hard surfaces at 3.5 mph with more than a 40-pound load
Walking on hard surfaces at 2.5 mph, with less than a 30-pound load	Walking on hard surfaces at 3.5 mph with less than a 40-pound load	Walking on loose sand at 2.5 mph, with any load
Guard Duty	Calisthenics	Armament crew functions
Marksmanship training	Patrolling	Rapid runway repair
Drills and ceremonies	Individual movement techniques such as low or high crawl	Heavy aircraft repair
Tower operations	Avionics shop activities	
Pilot ground activities	Aircraft maintenance activities	
CP activities		

¹ Representative tasks listed in this table were obtained from FM 21-10/MCRP 4-11.10, *Field Hygiene and Sanitation*.

(1) Military personnel wearing CP clothing often experience heat stress. To prevent such heat stress from resulting in heat stress-related injuries, they follow a prescribed cycle of work and rest periods. The work/rest cycles are based on the environment (temperature, humidity, and solar load), the workload of the individual, and the clothing ensemble being worn. These work/rest cycles are usually described in terms of minutes of work allowed per hour. The remainder of the hour (after completing the allowed work) is used for rest to allow heat to dissipate and to allow the individual to cool down.

(2) Under most conditions, when individuals are wearing heavier garments, the amount of work allowed per hour is less than the amount of work allowed when wearing a lighter garment. However, under some conditions, the work allowed per hour is actually greater when wearing a heavier garment than when wearing a lighter garment.

(3) When an individual is wearing CP clothing, the primary modes of heat exchange between the individual and the surroundings are by conduction, evaporation (of sweat), and solar radiation (if the sun is out). The nature of CP clothing is such that convective heat transfer (due to the movement of the air) is minimized by the garments and is not a significant factor. Evaporation will always result in a cooling effect for the individual if the water vapor can escape from the clothing ensemble. The amount of evaporative cooling depends on the humidity of the ambient air and upon the rate at which the water vapor can escape.

(4) Solar radiation (if present) will always result in adding heat to the individual. As the sun beats down on the surface of the clothing, the garments will heat up. Eventually, the heat will be transferred through the clothing layers to the individual. This heat from the solar radiation will increase the heat stress situation.

(5) Heat transfer by conduction depends on the skin temperature of the individual and the ambient air temperature. When the skin temperature is greater than the ambient temperature, the heat will transfer from the skin to the surrounding air. When the ambient air temperature is greater than the skin temperature, the heat will transfer from the surroundings to the skin, heating up the individual.

(6) In most situations, the total heat lost (by evaporation and conduction [if the skin is warmer than the ambient air]) is greater than the heat gained (by solar radiation, if present, and by conduction, if the air is warmer than the skin). Insulation, of course, reduces the rate at which this heat transfer occurs, but it cannot prevent it entirely. The greater the insulation, the lower the rate of heat transfer and the greater the heat stress induced upon the individual. This is the normal, expected situation in which the heavier garment (i.e., BDO) induces more heat stress than the lighter garment (i.e., JSLIST).

(7) In some cases, especially under conditions of high ambient temperature or a solar load, the heat gained from the environment is greater than the heat loss. Insulation reduces the rate at which this heat transfer occurs. In this case, the heavier garment protects the individual from the high external heat load better than the lighter garment. Hence, an individual can actually work longer in the heavier garment (i.e., BDO) than in the lighter garment (i.e., JSLIST) under such conditions. This is why desert nomads wear wool to protect themselves from the high external heat load caused by solar radiation and high ambient air temperatures.

b. Dehydration.

(1) Impact. Because of higher body temperatures, individuals in MOPP gear sweat considerably more than usual, often more than 1.5 quarts of water every hour during work. Water must be consumed to replace lost fluids, or dehydration will follow. Even a slight degree of dehydration impairs the body's ability to regulate its temperature and nullifies the benefits of heat acclimatization and physical fitness. It increases the susceptibility to heat injury and reduces work capacity, appetite, and alertness. Even in individuals who are not heat casualties, the combined effects of dehydration, restricted heat loss from the body, and increased work effort place a severe strain on the body's functions. Individuals, therefore, suffer from decrements in mental and physical performance. The difficulty of drinking in MOPP increases the likelihood of dehydration. Thirst is not an adequate indicator of dehydration, and individuals will not sense when they are dehydrated. Individuals will habitually fail to replace body water losses, even when drinking water is readily available.

(2) Mitigation Measures. Individuals should drink as much water as possible before donning the mask. Frequent drinking while working is more effective in maintaining hydration than waiting until rest periods to drink. The unit chain of command must take responsibility for enforcing regular and timely fluid replacement in their personnel.

c. Inadequate Nutrition.

(1) Impact. In addition to bodily requirements for electrolyte (salt) replacement caused by sustained and excessive sweating, the higher work intensities typical of operations in MOPP lead to an increased demand for calories. The lack of adequate energy supplies can lead to decrements in physical and mental performance.

(2) Mitigation Measures. The method selected to minimize feeding-related problems depends on the availability of safe, uncontaminated areas, and operational constraints. In a contaminated area where there is also a vapor hazard, personnel can be moved into a contamination-free facility or CPS. Since CPSs have limited capacity, small groups can be rotated through these facilities. In a contaminated area with no COLPRO available, relocate personnel to a safe area for feeding by rotating small portions of the unit or by replacing the entire unit. If personnel are in a contaminated area with no detectable vapor hazard or in a clean area where they are under a constant threat of NBC attack, use a rotating method to feed about 25 percent at any one time. Take care to prevent contaminating the food.

d. Miosis.

(1) Impact. Although MOPP gear may be the most common source of performance problems during NBC operations, some chemical agents, (primarily the nerve agents) can produce performance decrements at exposure levels below that which would cause casualties. The tissues of the eye react to levels of nerve agent vapor that will not affect other bodily systems. Minute amounts of nerve agent in direct contact with the eyes, can affect the eyes, causing constriction of the pupil (miosis). Miosis can be expected to negate or reduce the efficiency of task performance at night, tasks which depend on unaided night vision. Some examples are aircraft crews, operation of surveillance devices, etc. Identification of miosis-sensitive critical tasks and protection of critical specialist personnel should be considered in unit SOPs for operations in a chemical environment.

(2) Mitigation Measures. The following precautions can be adopted to minimize the incidence of miosis:

- Performing miosis-sensitive tasks before there is a risk of encountering miosis-producing hazards.
- Masking when in proximity to ground, equipment, or personnel known to have been recently contaminated with liquid nerve agent.
- Decontaminating and/or changing protective clothing as soon as possible for units or individuals known to have been contaminated by liquid nerve agent.
- Allowing contaminated personnel to remain masked as long as possible. If short unmasking periods are permitted, personnel should be widely dispersed in the open air, and those known to have been contaminated should be segregated.
- Avoiding bare-hands contact with contaminated surfaces. Protective gloves should be worn when there is suspicion of contamination and replaced when they become contaminated. *Do not rub eyes.*

3. Psychological Factors

a. Psychological Impact. NBC warfare threat adds to an already stressful situation, because it creates unique fears in personnel and isolates them from their environment. MOPP4 reduces the ability to see and hear clearly and makes it more difficult to recognize and communicate with others. This creates or increases feelings of isolation and confusion. The awkwardness of wearing bulky, impermeable garments, gloves, and boots over BDUs causes frustration and/or claustrophobia in many personnel. Long periods of reduced mobility and sensory awareness degrade attention and alertness and create or increase feelings of alienation. Chemical filters in the protective mask make breathing more difficult. This, too, may create feelings of claustrophobia or panic. Combat stress can cause significant numbers of psychiatric casualties. Estimates range from 10 to 30 percent, depending on the duration and intensity of battle. Psychological stress stems not only from the death and destruction that characterize combat but also from the challenging

operational conditions—noise, confusion, and loss of sleep. Challenging operational conditions that create fatigue and cause changes in diet and personal hygiene cause physiological stress as well.

b. **Mitigation Measures.** The adverse impact of psychological stress during MOPP operations can be minimized by the experience and confidence that realistic training in MOPP gear with protective mask provides. Use of short rest breaks to provide relief from MOPP, combined with adequate sleep, food, and drink can sustain performance at optimal levels (six or more hours of uninterrupted sleep per 24-hour period is optimum; 4 hours is the minimum for a few days of sustained operations). During the period of 0100 to 0700, leaders must be aware that the body experiences reduced mental concentration, confusion, nervousness, and lack of clear thinking. Leaders should plan activities to reduce boredom, fatigue, inattention, and discomfort. These are major contributors to ineffective performance.

c. **Other Mitigation Measures.** Leaders can minimize the effects of combat stress by attaining and maintaining a high level of unit cohesion and individual identity. Units must train together frequently under demanding conditions. If personnel know that they can overcome adversity together, unit cohesion will be high. Leaders must take a true interest in the welfare of their personnel and build the confidence necessary to withstand the effects of stress. Leaders must keep personnel informed about the tactical situation so that the adverse effects of ambiguity and uncertainty are minimized. Personnel who become ineffective as a result of combat stress should be given a period of rest and given reassurance and support by all members of their unit.

4. Chemical Protective Overgarment Work/Rest Cycles and Water Replacement Guidelines

Note: The term CPO is used inclusively to refer to all CPOs, such as the JSLIST, BDO, and saratoga.

a. The incidence of heat casualties can be reduced if personnel are allowed to lower their work intensity and/or take more frequent rest breaks. Table C-2 (page C-6) provides the information necessary to estimate recommended work/rest and water replacement cycles for various environmental conditions, clothing levels, and work intensities (Table C-1 [page C-1]) provides examples of work intensities for particular missions/tasks). The work/rest cycle estimates in Table C-2 (page C-6) are based on keeping the risk of heat casualties below 5 percent.

b. In minimizing heat stress, work/rest schedules may be supplemented by microclimate cooling (MCC) systems in which an air-or liquid-cooled vest could be worn under the overgarment to draw body heat away from the skin. MCC systems are available with STEPO and inside certain combat vehicles, but MCC options are not usually available for dismounted personnel. Even when work/rest schedules and MCC are used, an increased risk of performance degradation and heat casualties is inevitable when wearing MOPP in hot weather.

Table C-2. Work/Rest Cycles and Water Replacement Guidelines

Heat Category	WBGT ^{1,2} Index (°F)	Light (Easy) Work		Moderate Work		Hard (Heavy) Work	
		Work/Rest ^{4,5}	Water Intake (Qt/hr) ³	Work/Rest ^{4,5}	Water Intake (Qt/hr) ³	Work/Rest	Water Intake (Qt/hr)
1	78-81.9	No limit	½	No limit	¾	40/20 min	¾
2 (Green)	82-84.9	No limit	½	50/10 min	¾	30/30 min	1
3 (Yellow)	85-87.9	No limit	¾	40/20 min	¾	30/30 min	1
4 (Red)	88-89.9	No limit	¾	30/30 min	¾	20/40 min	1
5 (Black)	More than 90	50/10 min	1	20/40 min	1	10/50 min	1

¹ Wearing all MOPP overgarments (MOPP4) adds 10° F to WBGT index.
² If wearing body armor, add 5° F to WBGT in humid climates.
³ Hourly fluid intake should not exceed 1 ¼ quart, and daily fluid intake should not exceed 12 liters.
⁴ Rest means minimal physical activity (sitting or standing), accomplished in the shade if possible. The information pertains to acclimated service personnel.
⁵ The work/rest time and fluid replacement volumes will sustain performance and hydration for at least 4 hours of work in the specified heat category. Individual water needs will vary ±¼ qt/hr.

c. Because of higher body temperatures, personnel in MOPP gear sweat considerably more than usual. Personnel are aware that they need to remain hydrated, especially following deployment. Leaders ensure that subordinates maintain proper hydration, especially in areas of climatic extreme (e.g., desert environments) and they remain alert to any person showing potential heat stress, stroke, or exhaustion symptoms. Water must be consumed to replace lost fluids, or dehydration will follow.

d. The difficulty of drinking in MOPP increases the likelihood of dehydration. Thirst is not an adequate indicator of dehydration. Personnel will not sense when they are dehydrated and will fail to replace body water losses, even when drinking water is readily available. Furthermore, water can be consumed only through the mask drinking tube (no additives such as electrolyte replacement can be used). The unit chain of command must take responsibility for enforcing regular and timely fluid replacement in their personnel.

e. Individuals should go into MOPP at full hydration and drink frequently while working. That is more effective in maintaining hydration than waiting until rest periods to drink.

f. All water (and ice cubes) consumed must be from a medically approved source to prevent waterborne illnesses. Individuals should carry as much water as possible when separated from medically approved water sources. Plain water is the beverage of choice, and personnel will be more likely to drink sufficient water if it is palatable. Whenever possible, provide cool (60 to 70 degrees F) water. It is much better to drink small amounts of water frequently than to drink large amounts occasionally.

Appendix D

RADIOLOGICAL PROTECTION

1. Background

Radiological protection involves using OEG as a critical factor in protecting the force. Radiation exposure can create casualties and must be monitored as another critical element of the commander's force health protection program. Commanders must ensure that accurate records are kept for their personnel and that previous exposure is considered when selecting individuals and units for missions. Total dose exposure is critical from two different standpoints. Based on radiation exposure, commanders assess unit capabilities and the ability of that asset to perform its mission. Additionally, the individual cumulative dose of each individual service member represents, on a composite basis, the unit's radiation exposure status (RES) category. Additionally, paragraphs 3 and 4 of this appendix address LLR exposure and DU considerations.

2. Operational Exposure Guidance

a. Background.

(1) OEG gives the commander a flexible system of radiation exposure control. OEG procedures aid in the successful employment of a unit while keeping the exposure of personnel to a minimum. Radiation exposure must be controlled to the maximum extent possible consistent with the mission. If exposure control is ignored, unwarranted risks to units and personnel will occur. Establishing and using OEG helps the commander keep radiation exposures to a minimum and still accomplish the mission. OEG is the key for reducing casualties in a radiological environment.

(2) All radiation, even in small doses, may have some harmful effect on the body. Therefore, it is best to avoid all radiation exposures. Exposure should be as low as reasonably achievable (ALARA) to minimize exposures that would exceed established OEG levels.

(3) Establishing OEG must be based on a unit's prior exposure because of the cumulative effect of radiation exposure. The commander establishes an OEG for each tactical operation. Maintaining accurate historical OEG records is crucial in tracking previous exposure levels.

(4) An OEG must be established for each unit and each operation. It must be based upon the RES of the unit at that time and on the current and projected operational situation.

(5) The effective use of radiation exposure records permits rapid determination of a unit's potential to operate in a radiologically contaminated area. Dose criteria have been established in four categories: RES-0, RES-1, RES-2, and RES-3. Dose criteria are

shown in Table D-1, for each category. This information is based on the best available estimates on predicting the effects of radiation exposure based on the RES of the unit at that time and on the operational situation. The commander can decide which unit to select for a given mission based on the OEG. Each level of command can use the OEG system to select the best unit to conduct a mission. The commander is assured that personnel will receive the least exposure possible. Commanders include OEG guidance in OPORDs and units use OEG and RES guidance to accomplish the mission while minimizing radiation exposure. Based on the OEG, a unit can determine the turnback dose (Dtb) and turnback dose rate (Rtb) for a military operation (such as a radiological survey) by using the following formula

$$Dtb = \frac{(OEG) - \text{Previous Exposure}}{2}$$

$$Rtb = \frac{2 \times (OEG - \text{Previous Exposure}) \times \text{Speed}}{\text{Distance}}$$

Table D-1. Operational Radiation Exposure Status and Risk Criteria

Radiation Exposure Status	Total Past Cumulative Dose in Centigray	Exposure Criteria for a Single Operation Which Will Not Result in Exceeding the Dose Criteria for the Stated Risk
RES-0 Units	This unit has not had radiation exposure.	Negligible risk, less than 75 cGy Moderate risk, less than 100 cGy Emergency risk, greater than 125 cGy
RES-1 Units	The unit has been exposed to more than 0 and less than or equal to 75 cGy of radiation.	Negligible risk, less than 35 cGy Moderate risk, less than 60 cGy Emergency risk, less than 85 cGy
RES-2 Units	The unit has been exposed to more than 75 and less than or equal to 125 cGy of radiation.	Further exposure exceeds negligible or moderate risk.
RES-3 Units	The unit has been exposed to more than 125 cGy of radiation.	Further exposure exceeds emergency risk.
Note: Nuclear RES guidelines specify units in cGy; however, the US Navy is required by the CFR to conduct radiation monitoring in classic radiation units, such as R, rad, or rem. 1 cGy = 1 rad.		

(6) If the dosimeter reading indicates a Dtb and the dose rate is still increasing, the unit should leave the contaminated area immediately by the same route it used to enter the area. If the dose rate is decreasing, the commander must decide whether to continue through the contaminated area (then return to the unit by a clean route) or leave immediately by the same route used to enter the area.

b. Risk Criteria. The degree-of-risk concept helps the commander establish an OEG for a single operation and minimize the number of radiation casualties. By using the RES categories (Table D-1) of subordinate units and the acceptable degree of risk, the commander establishes an OEG based on the degree of risk. There are three degrees of risk: negligible, moderate, and emergency (See Table D-1). Each risk can be applied to radiation

hazards from enemy weapons, friendly weapons, or both. Degrees of risk are defined in percentages of casualties or performance degradation. A casualty is defined as an individual whose performance effectiveness has dropped by 25 percent from normal. Specific measures of performance depend on the task. Degradation (nuisance) effects can include vomiting, skin burns, eardrum rupture, and nausea. These symptoms, at low radiation levels, may take hours to develop. Individuals thus exposed should be able to function in the important hours after a nuclear attack and after the first set of symptoms abate. The casualty data presented in this section is based on a 50 percent confidence level that the unit is at a 75 percent performance decrement.

(1) Negligible Risk. Negligible risk is the lowest risk category. The dose is less than 75 cGy for personnel in RES-0 (with no previous exposure); this dose will not cause any casualties. Personnel receiving a negligible-risk dose should experience no more than 2.5 percent degradation (nuisance) effects. Negligible risk is acceptable when the mission requires units to operate in a contaminated area. Negligible risk should not be exceeded unless a significant advantage will be gained.

(2) Moderate Risk. Moderate risk is the second risk category. The dose is less than 100 cGy for personnel in RES-0 (with no previous exposure). This dose generally will not cause casualties. Troops receiving a moderate-risk dose should experience no more than 5 percent nuisance effects. Moderate risk may be acceptable in close support operations. Moderate risk must not be exceeded if personnel are expected to operate at full efficiency.

(3) Emergency Risk. Emergency risk is the final risk category. The dose is any exposure greater than 125 cGy for personnel in RES-0 with no previous exposure. In this category, not more than 5 percent casualties are expected. Nuisance effects may exceed the 5 percent level. The emergency-risk dose is only acceptable in rare situations, termed *disaster situations*. Only the commander can decide when the risk of the disaster situation outweighs the radiation emergency risk. The risk criteria for RES-1 and RES-2 categories are based on assumed average exposures for units in RES-1 and RES-2; this should be used only when the numerical value of the total past cumulative dose of a unit is unknown. When the cumulative dose within a category is known, subtract the known dose from the RES-0 criteria for the degree of use of concern. For example, if a unit in RES-1 received a dose of 30 cGy, it may receive an additional exposure of 30 cGy before exceeding the moderate risk.

c. Low-Level Radiation Guidance. In operational environments such as MOOTW situations, units are aware of possible LLR exposure (see Table D-2 [page D-4] for LLR guidance). Commander's actions follow the same previous guidance: eliminate or minimize exposure and monitor unit and personnel radiation exposure. (See Table D-3 [page D-6] for contamination control guidance for missions of 7 or 90 days.)

Table D-2. Low-Level Radiation Guidance for MOOTW

Total Cumulative Dose (See Notes ^{1,2})	RES Category	Recommended Actions
0 to 0.05 cGy	0	None
0.05 to 0.5 cGy	1A	Record individual dose readings. Initiate periodic monitoring.
0.5 to 5 cGy	1B	Record individual dose readings. Continue monitoring. Initiate rad survey. Prioritize tasks. Establish dose control measures as part of operations.
5 to 10 cGy	1C	Record individual dose readings. Continue monitoring. Update survey. Continue dose control measures.
10 to 25 cGy	1D	Record individual dose readings. Continue monitoring. Continue dose control measures. Update survey. Execute priority tasks only. ³
25 to 75 cGy	1E	Record individual dose readings. Continue monitoring. Continue dose control measures. Update survey. Execute critical tasks only. ⁴
<p>¹ The use of the measurement millisieverts (mSv) is preferred in all cases. However, military organizations normally only have the capability to measure cGy. If the ability to obtain measurements in mSv is not possible, US forces will use cGy. The USN is required by the code of Federal Regulations to conduct radiation monitoring in classic radiation units such as R, Rad, or REM. 1cGy = 1 rad.</p> <p>² All doses should be kept as low as reasonably achievable. This will reduce individual risk as well as retain maximum operational flexibility for future employment of exposed persons.</p> <p>³ Examples of priority tasks are those that avert danger to persons and prevent damage from spreading.</p> <p>⁴ Examples of critical tasks are those that save lives.</p>		

d. Radiation Exposure Records.

(1) The OEG concept requires that all units maintain radiation exposure records. Radiation exposure records are maintained at wing, shipboard, brigade, and regimental levels of command.

(2) The NBC staff maintains RES records for all assigned and attached units. The records are based on exposure data received daily or following a mission in a radiologically contaminated area. The unit SOP indicates specific reporting procedures. Monthly records are maintained according to the unit SOP.

e. Processing Data.

(1) The data from flight/section/platoon elements is passed to the applicable NBC control center (NBCCC). Readings from tactical dosimeters (AN/UDR-13, IM93, or DT236) are averaged on a daily basis, and an informal record is maintained at

flight/section/platoon level. The IM93, which works on the principle of electrical collection of ions, is recharged after each report is submitted or every three days, whichever occurs first. The AN/UDR-13 can record the total dose for a specific period of time. Prior to nuclear operations, each unit will read 10 percent of the total DT236s weekly to ensure that no leakage has occurred. After nuclear operations have commenced in the theater of operations, one third of the DT236s will be read daily. The DT236s have a response time of 24 hours and ± 30 percent accuracy. This is due to the process that the DT236 uses to record radiation levels (Note: The DT236 is part of the AN/PDR-75.)

(2) The preferred method of recording individual exposure is based on analysis of each person's dosimeter; however, situations may occur in which LLR individual dosimeters are not available for all potentially exposed personnel. In such situations and when dosimeters become lost or damaged, special advisors should be consulted for acceptable, alternative methods of assessing and recording individual exposures.

(3) Wing, ship, brigade, and battalion elements record and maintain the status on each assigned or attached element. An overall RES status is reported to the commander and his staff.

3. Low-Level Radiation

a. Background.

(1) Prior procedures for the management of radiation exposure basically assume that nuclear hazards will arise following a nuclear exchange; both procedures and equipment reflect this. There must be concern, however, for the immediate employment of personnel (survive to operate), their combat capability, and the health effects on individuals.

(2) Radiation hazards could emanate from sources other than a nuclear-weapon burst and in circumstances other than strategic attack (general war), including MOOTW situations. Although in some circumstances, the radiation exposures could be high (e.g., greater than 75cGy) and result in short-term medical effects among the exposed personnel, it is expected that much lower dose levels are more likely to be encountered in future operations.

(3) The purpose of this section is to provide guidelines to the commander for the protection of personnel during military operation in LLR environments, while maintaining the operational capability of the deployed force.

**Table D-3. Contamination Control Guidance
(For up to a 7-day mission or within a 90-day mission)**

Radiation Exposure Status	Contamination Level Below Which RES Will Not Be Exceeded Bq/cm ^{2, 5}		
	Equipment and Protective Clothing ¹ or Skin ³		
	High-Toxic Alpha Emitters ²	Beta And Low-toxic Alpha Emitters	Beta Only
Category 1A 0.05 to 0.5 cGy	5 (7 days) ⁵ 0.5 (90 days)	50 (7 days) 5 (90 days)	10 (up to one event ⁴)
Category 1B 0.5 to 5 cGy	50 (7 days) ⁵ 5 (90 days)	500 (7 days) 50 (90 days)	10 (10 events ⁴)
Category 1C 5 to 10 cGy	100 (7 days) ⁵ 10 (90 days)	1,000 (7 days) 100 (90 days)	10 (50 events ⁴)
Category 1D 10 to 25 cGy	250 (7 days) ⁵ 25 (90 days)	2,500 (7 days) 250 (90 days)	10 (50 events ⁴)
Category 1E 25 to 75 cGy	700 (7 days) ⁵ 70 (90 days)	7,000 (7 days) 700 (90 days)	10 (50 events ⁴)

¹ Calculations assume that contamination is removed by decontamination.
² All alpha-emitting isotopes, except uranium, are assumed to be highly toxic.
³ The handling of contaminated equipment without wearing protective clothing is allowed only when the contamination levels do not exceed those of Category 1A.
⁴ The parentheses refer to the maximum allowable number of contamination events that can occur, regardless of where each contamination appears on the body. Decontamination must be performed as soon as possible after each event. Each event may involve multiple sites.
⁵ A becquerel (Bq) is an international system unit of activity that is equal to one nuclear transformation (disintegration) per second. 1 Bq = 2.7x10⁻¹¹ Curies (Ci) =27.03 picocuries (pCi)

b. Definitions. LLR is radiation resulting from any cause other than the immediate nuclear radiation and subsequent direct radioactive fallout from the detonation of a nuclear weapon.

c. LLR Characteristics.

(1) LLR is always present as background radiation; LLR varies considerably throughout the world and can even vary considerably within a small locality. It complicates detection quantification and, hence, interpretation of an LLR hazard.

(2) LLR may be comprised of dispersed radioactive material (in solid, liquid, gaseous, or vapor form), or it may be in the form of discrete sources. Alpha, beta, gamma, and neutron radiation may present LLR hazards:

(a) Alpha radiation has a very limited range in air (centimeters) and is not able to penetrate clothing or intact skin. Alpha radiation-emitting material represents no hazard while outside the body; but in sufficient quantity, it can deliver large radiation doses to individual organs and may become a serious health hazard if ingested or inhaled.

(b) Beta radiation has a short range in air (meters), is attenuated by clothing, and can be stopped by relatively thin layers of most solid materials. Beta radiation-emitting material represents a hazard if inhaled or ingested and may result in

high skin doses from external exposures that can manifest into beta burns. Most radioactive materials emit both beta radiation and gamma radiation.

(c) Gamma radiation is easy to detect, but it may be absorbed and diminished in intensity by dense materials (shielding). Gamma radiation-emitting material is able to deliver radiation doses to the whole body while remaining outside the body.

(d) Neutron radiation is penetrating but may be diminished by interacting with low, atomic number materials. Such interactions may result in the production of gamma radiation, thus producing multiple types of radiation hazards. Neutron radiation-emitting material is able to deliver radiation doses to the whole body while remaining outside the body.

d. LLR Sources.

(1) Civil Nuclear Facilities. These facilities may include those for power generation; research; and for the processing, storage, and disposal of nuclear waste.

(2) Industrial and Medical Materials. Wide-scale use of radioactive sources includes the testing of industrial products, medical or diagnostic treatment, equipment sterilization, and food processing.

(3) Radiological Dispersal Devices. Radiological dispersal devices (RDDs) are designed to release radioactive materials into the environment. This can be achieved by combining nuclear materials with conventional explosives or combustion to produce radioactive particles or smoke.

(4) Radioisotopes. LLR exposure may be caused by radioisotopes in highly occupied positions, such as aerial ports of debarkation (APODs), seaports of debarkation (SPODs), or personnel staging areas.

(5) Nuclear-Weapon Release. A nuclear-weapon release is the spread of fallout or rainout resulting from the distant (outside the AO) or earlier use (within the AO) of nuclear weapons.

(6) Military Commodities. Some military munitions (e.g., DU) and equipment contain radioactive material, which may present a radiation hazard if disrupted.

e. Risk Management.

(1) Radiation exposure control measures will reflect the need to balance the duty of care for individuals (recognizing immediate potential hazards, and the risks of long-term health effects) against the achievement of a military task that might involve life-threatening activities. Consequently, when planning or implementing operations where LLR may be or become a factor for consideration, commanders must be capable of making informed and balanced judgments between their operational obligations at the time and their duty-of-care responsibilities. Furthermore, the over-riding principal governing all exposure to radiation is keeping such exposure as low as reasonably achievable (ALARA).

(2) Tables D-2 and D-3 (pages D-4 and D-6) provide LLR exposure guidance and contamination control guidance for commanders. They show radiation exposure categories and associated doses and recommends actions appropriate to mitigating the risk to individuals. Although the dose contributed by ingestion or inhalation of radioactive material (known as *internal dose*), by partial body irradiations from gamma rays, and by skin irradiations from beta particles cannot be accurately measured in the field, it can be estimated for operational purposes. Depending on the type of radioactive material and its dispersed form, the radiation dose to the tissues and organs can be much larger than the external dose recorded on a dosimeter. Consequently, respiratory and skin protection must be considered whenever the hazard analysis establishes that there is a potential risk for exceeding exposure guidance standards.

(3) Military operations may require that national peacetime regulations governing exposure be exceeded. This may be the case particularly in humanitarian, life-saving and/or emergency situations. All exposure to radiation must be justified by necessity and subject to controls that maintain ALARA doses. Some of the controls are as follows:

- Inform the local civil authorities.
- Call for a special monitoring team.
- Make an estimate and plan of the control measures necessary to contain the LLR hazard. This should include adherence to the commander's OEG limit, further evacuation of the hazard area (if required), and controlled access.
- Conduct a survey, and confirm the extent of the LLR hazard if LLR detection equipment and trained personnel are available.
- Monitor the exposure of personnel who must remain within the hazard area for operational reasons. These measures will be the responsibility of the commander.
- Ensure that dosimeters are issued if available. Forces should adopt respiratory and skin protection measures until analysis establishes that no potential risk for exceeding internal or skin exposure guidance standards exist.
- Prevent further access into the defined hazard area and consider OEG guidance and/or decontamination sites as necessary.
- Ensure that food and water from the area is uncontaminated if it is to be used.
- Review procedures for limiting the resuspension of ground contamination if appropriate.

f. Contamination Control Considerations. Planning for contamination control can include the following considerations:

- Confirmation of the authorized dose limits and the adequacy of exposure control measures for forces remaining within the hazard area for operational reasons.

Where dosimeters have not been issued, the level of dose and exposure time will have to be estimated and recorded.

- Decontamination in order to render the personnel and equipment leaving the hazard area safe (specialist advice and monitoring equipment may be required depending on the nature of the contamination).

- Reconnaissance and survey to confirm and mark the area, nature, and intensity of the hazard. Monitoring should continue until operations in that area are concluded.

g. LLR Planning. After assessment, LLR planning addresses the following considerations:

- The nature and potential extent of any identified risks including a description of the possible accident or incident scenarios.

- Identification of what RADIAC detection equipment is immediately available in the area of operation and, therefore, what LLR hazard can be detected.

- The immediate and control actions (including advisory dose limits and the circumstances and authority required to exceed each incremental dose limit) appropriate to current local conditions.

- The issue of available equipment (including dosimeters, spectrometer, decontamination, and medical measures).

- The means of assessing national technical advice and support to extend the detection/monitoring capabilities in the AO.

- Arrangements for obtaining specialist personnel and equipment, such as coordinating for teams that are prepared to sample and identify radiological agents.

- The informing and training of personnel.

h. LLR Hazard Avoidance Considerations. When in the AO, commanders should avoid exposing their personnel to LLR hazards by taking the following measures:

- Obtain information regarding potential hazard areas.

- Be aware of HN nuclear facilities and other possible radioactive sources and respect their installation control measures.

- Restrict and closely control entry to areas marked by radiological warning signs.

- Ensure troops do not tamper with containers marked with radiological warning signs.

- Treat all suspect waste dumps and potential hazard sites with care until proven clear.

i. LLR Protection Considerations (Initial Actions). When a hazard is identified, the following actions should be taken:

- Evacuate military personnel (if the situation permits) from the area of release if it is confined (e.g., inside a hospital). Otherwise, evacuate the area to a radius as determined by on-scene personnel, taking into account the current military situation. As an immediate guide, evacuation can be to distances where operationally significant radiation levels (10 times the natural background readings at 1 meter above the ground) no longer exist. In the absence of any specific guidance or when under unusual or unforeseen constraints, evacuation to a radial distance of 1 kilometer from the suspected radiation release point may be employed.

- Report the hazard verbally and by using NBC reports.
- Identify the need and the means to report the hazard, including the warning of other forces and the HN.
- Provide specialists to establish the exact nature of the LLR hazard, the extent of the contamination, and the long-term plan of action.

j. LLR Force Health Protection Considerations. Force health protection considerations include the following actions:

- Record LLR exposure on personal medical records for long-term health monitoring. This will involve the medical chain.
- Continue to accurately monitor LLR dose rates.
- Contain and secure the hazard. Obtain samples for detailed analysis and identification.
- Conduct long-term health monitoring for those personnel who have been exposed to radiation on completion of the operation. Postoperation assessment of internal doses may also be required.

k. LLR Psychological Casualties.

(1) Psychological casualties would seem to be insignificant compared to the casualties from physical trauma, but they can dramatically alter the outcome of an operation. The neuropsychiatric casualties of World War II were the largest single cause of lost military strength in that war. Complicating matters further, psychological stress can mimic the early symptoms and signs of acute radiation injury. Gastrointestinal symptoms (nausea, vomiting, and diarrhea), fatigue, and headaches were frequent symptoms during episodes of battle fatigue in World War II. In an RDD or a nuclear incident scenario, psychological stress is also a factor. Even if neuropsychiatric trauma does not produce a casualty, it can degrade the performance of normal duties. Slightly altered reaction times, inattention, or motivation have important consequences across the entire spectrum of

military operations. Regardless of the situation, it must be emphasized that the most extreme psychological damage occurs when physiological symptoms from an unknown toxic exposure become manifest.

(2) An RDD or a nuclear incident would likely produce acute anxiety effects, including psychosomatic effects such as nausea and vomiting. Symptoms of acute radiation sickness in just a few personnel might trigger an outbreak of similar symptoms in the unit and/or in the civilian populace.

(3) Exposure or perceived exposure to radiation can be expected to increase the number of psychological stress casualties. The number of casualties will also depend on the level of leadership, cohesiveness, and morale in the unit. Long-term chronic psychological stress patterns could be expected to arise from the uncertainty about the effects of exposure to radiation. Some of the potential effects include phobias, depression, and posttraumatic stress disorder.

(4) The most frequent psychological effect after disasters is a temporary emotional disruption where people are stunned or dazed; this transient response may last minutes or days. Typically, such individuals will be able to respond to strong leadership and direction. Another psychological response is to become more efficient in the face of danger; this is more likely in well-trained units with high morale. A third type of response is that of a psychological casualty, where the transient emotional disruption continues and is more severe. Reactions include stunned, mute behavior; tearful helplessness; apathy; inappropriate activity; and preoccupation with somatic symptoms (often of emotional origin).

(5) The most stressful effects of a fallout field or contaminated area are likely to be the uncertainties of the levels of radiation present, the lack of defined boundaries of the area, and the perceived acute and chronic effects of radiation.

(6) Even in the absence of actual exposure, thoughts that one has been exposed to radiation may cause fear and anxiety.

(7) The treatment of psychological stress resulting from actual or perceived exposure to radiation is the same as that for battle fatigue. The principles of proximity, immediacy, expectancy, and simplicity are the cornerstones of treatment.

(8) Prevention, when possible, is always preferred to treatment. Prior to deployment to an area where nuclear and radiological hazards are present, medical personnel can implement programs on behalf of line commanders that instruct their units about radiation and its effects. In general, personnel who are psychologically prepared for specific stresses are better able to endure them and will suffer fewer and less severe adverse reactions. This same principle is widely used in preparing troops to cope with MOPP gear, chemical agent exposure, and other adverse environments. Postexposure training will be much less effective.

4. Depleted Uranium

a. Background. DU is an extremely dense metal used in munitions to penetrate heavy armor or as protective shielding (armor packages).

b. Exposure. DU exposure and incidents may occur anytime there is damage to the DU armor package—a vehicle is hit with DU munitions, DU munitions are damaged, or equipment components containing DU are damaged. The DU armor can be damaged during vehicle maneuvers, on-board fires, maintenance activities, or ballistic impacts. DU munition problems may occur as an occupational exposure during storage, transportation, combat, testing, or manufacturing. DU contamination may be present on the ground in areas where equipment was destroyed or damaged.

c. Contamination. DU contamination may include DU oxides (dust), contaminated shrapnel, munitions components, or armor components. DU primarily emits alpha particles; however, beta, gamma, and X-ray ionizing radiation are also emitted. DU contamination can be inhaled, ingested, injected, or absorbed through open cuts or wounds. DU contamination does not pose an immediate health risk. Consequently, contamination should be removed from personnel or vehicle surfaces when directed by the unit commander based on METT-T. See Table D-4 for information on recommended maximum-permissible contamination levels.

d. Presence of DU. Visual signs that DU contamination is present immediately after a high-heat event (impact and/or fire) include heavy, dull black dust or small round holes. DU fragments or residues that have weathered in the environment may exhibit a green or yellow appearance. DU contamination can only be verified with a radiac meter. An AN/VDR-2 or AN/PDR-77 with an alpha probe or beta (flat pancake) probe is used to detect and measure DU contamination. Care should be taken when surveying with the alpha probe to prevent puncturing the probe window, which renders the probe useless.

e. Protection. When working on or within DU-contaminated equipment, personnel must wear gloves, use respiratory protection (e.g., painter mask, bandana, surgical mask), and wear coveralls or roll down their sleeves and blouse their trousers as directed by unit chemical or medical personnel.

f. Procedures. General procedures to follow when working around DU include the following:

- Use a radiac meter to determine if DU-contamination is present.
- Provide protection, including appropriate clothing, for workers as directed by unit NBC or medical personnel.
- Identify what is to be decontaminated.
- Obtain necessary equipment and materials.
- Brush, wash, or wipe off contamination with a damp cloth. Use a high-efficiency, particulate air (HEPA) vacuum cleaner if available.

- Work from the outside to the inside of the contaminated area.
- Cover fixed contamination with tape, paint, paper, plastic, or other disposable material.
- Use the standard, double-bag and-tag process for hazardous waste. The only contaminated waste generated by DU will be the vacuum cleaner bags after use on multiple vehicles.

Table D-4. Recommended Maximum-Permissible Contamination Levels

Contaminated Item	Corrective Action	Maximum Alpha Levels		Maximum Beta Levels	
		Fixed ¹ (dpm/100 cm ²)	Removable ² (dpm/100 cm ²)	Fixed ¹ (mrad/hr at 2.5 cm)	Removable ² (dpm/100 cm ²)
1. Personal clothing, including shoes	See note 1	200	None	0.05	None
2. Personal:					
a. General	See note 1	1,000	200	0.02	1,000
b. Respirators	See note 1	200	None	0.06	None
c. Laundry	See note 2	--	--	--	--
3. Work area and equipment (unrestricted use)	See note 1	5,000	500	0.05	500
4. Vehicles (unrestricted use)	See note 3	1,000	500	0.05	500
5. Skin					
a. Body	See note 4	200	None	0.06	None
b. Hands	See note 4	400	None	0.06	None
¹ Measured with a calibrated radiation measurement instrument. ² Determined using smears analyzed with a calibrated counting system. Notes: 1. Replace or dispose of radioactive waste if above limits. 2. Launder, wash or dispose of radioactively contaminated equipment with careful contamination control. 3. Decontaminate if above limits. 4. Continue decontamination if above limits. 5. DPM: Disintegrations per minute.					

Appendix E

**TOXIC INDUSTRIAL CHEMICALS-
AN ASSESSMENT OF NUCLEAR, BIOLOGICAL, AND CHEMICAL
FILTER PERFORMANCE**

1. Background

This appendix provides information and data on the assessment of NBC filter performance as they relate to protection against selected TICs. The filter performance data only provides supporting technical information for NBC planners. The TIC protection actions described in Chapter II remain as the primary basis for a response to an incident or accident. The most important action in case of massive TIM release is immediate evacuation outside the path of the hazard. The greatest risk from a large-scale, toxic-chemical release occurs when personnel receive little or no warning, are unable to escape the immediate area, and are overcome by vapors. Military respirators and protective clothing may provide only limited protection against TIC. Units use the US Department of Transportation, *Emergency Response Guidebook*, and FM 8-500, *Hazardous Materials Injuries; a Handbook for Prehospital Care*, to identify protection requirements for specific material. The protective mask and ensemble and military standard COLPRO filters will likely provide only limited protection.

Important considerations are required when assessing potential TIM releases and protection, detection, and documentation capabilities and limitations available to forces using military NBC defense equipment. During TIM releases, the local military response should be local area evacuation (directly out of the downwind hazard plume, perpendicularly to the downwind direction, and uphill if possible). Individual military protective equipment use in unknown TIM release areas is only appropriate as an emergency escape means. Fixed TIM sites allow for friendly force preplanning to avoid positioning resources in potential TIM release hazard areas. Mobile TIM transport means could cause TIM release events (with little notice) that could occur unexpectedly with dangerous, unknown combinations of substances that may be toxic, flammable, and/or water-reactive.

2. Filter System Operations

a. This assessment applies to multiple sets of NBC filters (e.g., C2A1 canister, M12A2 gas filter, M18 gas filter, M49 gas filter, M48 gas filter, M23 Filter, 200 CFM filter, and Advanced, Integrated Collective Protection System [AICPS] filter). The fact that US NBC filters are designed to process equivalent amounts of chemicals per quantity of activated carbon enables the performance of specific filters to be estimated from a single filter configuration.

b. NBC filtration systems consist of a particulate filter to remove liquid and solid phase toxic particulate materials followed by a vapor filter to remove vapor phase toxic chemicals. The vapor filter consists of activated carbon, which has been impregnated with

reactive materials. This impregnated and activated carbon filters vapors by two mechanisms—physical adsorption in the pores of the activated carbon and chemical reaction with the impregnants. Low-vapor pressure chemicals, such as nerve and mustard agents, are removed very effectively by physical adsorption alone in the microporous structure of the carbon. Relatively high-vapor pressure agents, such as the blood agents (cyanogen chloride and hydrogen cyanide), are not strongly, physically adsorbed and will quickly penetrate a nonreactive activated carbon. Thus, specific reactive chemicals have been identified which chemically decompose those high-vapor pressure agents. These reactive chemicals are impregnated on the activated carbon so as to provide effective filtration of all chemical warfare agents.

c. CW agent vapor filters contain the reactive adsorbent ASC carbon (ASC is not an acronym; but it is a specific designator for activated carbon that has been impregnated with type ASC solution, which is a mixture of copper, chromium and silver) or they contain ASZM-TEDA (copper-silver-zinc-molybdenum-triethylenediamine) carbon (a chromium-free carbon). The protection provided by these two sorbents against CW agents is nearly equivalent. Both ASC carbon and ASZM-TEDA carbon were developed specifically to filter CW agent vapors. However, the adsorbents are also effective in filtering a wide variety of industrial chemical vapors, particularly those that are strongly adsorbed.

3. Filter Assessment

a. Historically, CW agents have consisted primarily of analogs of nerve, mustard, cyanide, and arsine—as well as a number of industrial-type chemicals, such as chlorine, phosgene, and chloropicrin. Of the tens of thousands of TIC produced worldwide, there are many that present an aerosol hazard and are produced in large quantities. A trinational group (the US, Canada, and the United Kingdom) researched the broad issue of industrial-based chemicals, and the study effort resulted in the identification of selected TIC that are widely produced, stored, and transported; easily vaporized; and highly toxic (see Table E-1). The selected chemicals were prioritized into three hazard index rankings as provided by an international task force: 21 high, 41 medium, and 36 low-hazard vapors and gases.

Table E-1. Protection Afforded by NBC Filters for Selected TIC

High Hazard	Medium Hazard	Low Hazard
ammonia - P	acetone cyanohydrin - M	allyl isothiocyanate - E
arsine - E	acrolein - P	arsenic trichloride - M
boron trichloride - E	acrylonitrile - P	bromine - P
boron trifluoride - E	allyl alcohol - M	bromine chloride - M
carbon disulfide - P	allyl amine - P	bromine pentafluoride - M
chlorine - E	allyl chlorocarbonate - M	bromine trifluoride - M
diborane - E	boron tribromide - M	carbonyl fluoride - P
ethylene oxide - P	carbon monoxide - P	chlorine pentafluoride - M
fluorine - E	carbonyl sulfide - P	chlorine trifluoride - M
formaldehyde - P	chloroacetone - M	chloroacetaldehyde - M
hydrogen bromide - E	chloroacetonitrile - M	chloroacetyl chloride - M
hydrogen chloride - E	chlorosulfonic acid - E	cyanogen - E
hydrogen cyanide - E	crotonaldehyde - M	diphenylmethane-4 diisocyanate - E
hydrogen fluoride - E	diketene - M	ethyl chloroformate - M
hydrogen sulfide - E	1,2-dimethyl hydrazine - P	ethyl chlorothioformate - E
nitric acid, fuming - E	dimethyl sulfate - E	ethylene imine - P
phosgene - E	ethylene dibromide - M	ethylphosphonothioicdichloride - E
phosphorus trichloride - E	hydrogen selenide - P	ethyl phosphonous dichloride - M
sulfur dioxide - E	iron pentacarbonyl - M	hexachlorocyclopentadiene - E
sulfuric acid - E	methanesulfonyl chloride - E	hydrogen iodide - P
tungsten hexafluoride - E	methyl bromide - P	isobutyl chloroformate - M
	methyl chloroformate - P	isopropyl chloroformite - M
	methyl chlorosilane - P	n-butyl chloroformate - M
	methyl hydrazine - M	nitric oxide - P
	methyl isocyanate - P	n-propyl chloroformate - M
	methyl Mercaptan - P	isopropyl - P
	n-butyl isocyanate - M	parathion - E
	nitrogen dioxide - P	perchloromethyl mercaptan - E
	phosphine - M	sec-butyl chloroformate - M
	trichloroacetyl chloride - M	sulfuryl fluoride - P
	phosphorus oxychloride - M	tert-butyl isocyanate - M
	phosphorus pentafluoride - P	tetraethyl lead - E
	selenium hexafluoride - E	tetraethyl pyrophosphate - E
	silicon tetrafluoride - P	tetramethyl lead - M
	stibine - P	toluene 2,4-diisocyanate - E
	sulfur trioxide - M	toluene 2,6-diisocyanate - E
	sulfuryl chloride - P	
	tellurium hexafluoride - P	
	tert-octyl mercaptan - E	
	titanium tetrachloride - E	
	trifluoroacetyl chloride - P	

Legend: Filter Effective (E); Marginally (M); Poor (P).

b. The listing of the TIC (Table E-1) represents a broad range of physical and chemical properties. Chemical families consist of halides (fluoride, chloride, bromide, and iodide), cyanides, cyanates, amines, oxides of carbon and nitrogen, ketones, aldehydes, esters, phosphates, thiols, and heavy metals (lead and titanium). This information shows

that about 75 percent of the chemicals have a vapor pressure above 10 mm mercury, a state at which the strength of physical adsorption is reduced more rapidly on activated carbon and is a greater concern with respect to desorption.

c. Table E-1 provides, in summary form, assessment results of the protection afforded by NBC filters to the selected TICs. The filter assessment indicated that many of the TIC could be effectively removed by the filter (effective), minimally removed by the filter (poor), or partially removed by the filter (marginal). However, variables, such as being near the explosive and meteorological conditions, could affect the assessment. Several of the TICs were effectively removed by NBC filters; however, almost equal numbers were assessed as performing poorly (P) or marginally (M).

d. Table E-1 provides data to only support unit planning. For example, this data could be used to support risk assessments based on IPB evaluations (e.g., types of TIC found in an AOI) furnished by the intelligence officer or the staff surgeon. However, military units (except for special-purpose units like EOD or HAZMAT response teams) lack the capability to detect most TIC; the unit response to TIC incidents/accidents remains as described in Chapter II.

Note: This summary only addresses several of the TIC that represent an aerosol hazard and are produced in large quantities. There are many other TIC that present other hazards such as flammability and oxygen depletion, etc. Consult the technical references for specific information on TIC hazards, safety considerations, and other applicable emergency response guidelines.

Appendix F

NONCOMBATANT EVACUATION OPERATIONS

1. Background

This appendix provides an overview of NEOs and provides information that could be used to support military unit planning and noncombatant evacuees (NCEs). The primary focus of an NEO is to move NCEs safely and quickly away from danger.

(Note: The information provided in this appendix is very general. Specific details will vary depending on individual situations, and detailed prior planning by commanders will help support successful mission execution.)

2. Planning

Military planners recognize the importance of NEO and its direct link to successful mission accomplishment. Military planners involved in the NEO planning and execution consider several aspects affecting its potential implementation:

- All American citizens should be treated equally.
- US citizens have evacuation priority, but NEO execution may also involve support to NCE who are not US citizens. Other nations are expected to request evacuation support from the US Department of State (DOS). Upon DOS approval, third-country nationals (TCNs) from countries who have been authorized assistance will be included in the NEO processing.
- NEO support planning covers the response to any crisis that could lead to a decision to direct an ordered evacuation.

3. Stages of Noncombatant Evacuation Operations

There are five stages of an NEO—alert, assembly, relocation, evacuation, and repatriation.

a. Alert. NCEs will be notified of an impending crisis that may require relocation or evacuation and be provided appropriate instructions from commanders through their installation NEO representatives.

b. Assembly. Following instructions to assemble, NCEs will move to an evacuation control center (ECC). Some NCEs may be instructed to remain in their quarters or existing shelters to minimize the risk and ensure a manageable flow into the evacuation system.

c. Relocation. The movement of NCEs to another location is called *relocation*. Relocation will be conducted to move NCEs from ECCs to sites of greater relative safety called *relocation centers* (RCs) or APODs where they will board transportation.

d. Evacuation. The movement of NCEs from an area to a safe haven is called *evacuation*.

e. Repatriation. Upon arrival in CONUS, NCEs are repatriated.

4. Noncombatant Evacuation Operations in a Nuclear, Biological, and Chemical Environment

This paragraph outlines some of the hazards that could face NEO personnel in a contaminated environment and describes individual survivability methods (with and without specialized equipment).

a. Planning Considerations. The following planning considerations may apply; however, each NEO situation will be different:

(1) Most airlift NEO evacuations may take place during retrograde time-phased, force and deployment operations (e.g., military forces and equipment brought to the APOD will be downloaded from the aircraft, the NEO passengers and equipment will be loaded as necessary, and the aircraft will depart for a location outside of the immediate threat area).

(2) Some NEO personnel may be present at APODs during attack situations.

(3) Most NEO personnel will probably not have respiratory protection and/or protective overgarments.

b. Transforming Living Quarters or Other Facilities into NBC Collective Protective Shelters. Certain key things must be understood about the nature of NBC agents and their interaction with the environment when planning the transformation of facilities into protective shelters for NEO personnel. In most cases, hazardous CB agent vapors will remain relatively low to the ground. Consequently, shelters established on the second or third floors of buildings will typically be safer from CB agents than locations on the ground floor.

(1) When transforming areas into CPSs, consider the following factors and select the area based on—

- Size requirements (the number of people expected to use the shelter and the expected duration of stay).

- Access to a telephone.

- Access to running water, cooking facilities, etc.

- The distance above ground level (the higher the better).

- The distance from nearest vegetation (the farther the better).

- The realistic number of VBs that can be constructed between the shelter area and ground level.

- The number and location of agent access points to the inside of the facility (e.g., doors, windows, fireplaces, external air vents).

(2) Additionally, consider taking the following actions when preparing the CPS.

(a) Cover and seal with tape all direct access points to the inside of the facility (fireplaces, external air vents, etc.).

(b) Select one entry/exit point for the facility. If possible, use the entry/exit point that has the most concrete or asphalt (minimum soil or vegetation) immediately around it. Lock all other doors. Leave the keys in the doors in case an emergency escape is necessary.

(c) Create a decontamination station just inside the entry/exit door. This station may include bleach in containers (troughs) (for personnel to step into) and hand buckets (for glove and/or hand decontamination). The entry/exit door should also have a container for contaminated-item disposal and a sharp knife or pair of scissors for cutting off contaminated clothing.

(d) Minimize splintering by taping windows and boarding them with plywood, cardboard, or some other suitable material.

(e) Use a substance, such as duct tape, to seal all potential agent access areas (doors, windows, openings around window air conditioners, etc.).

(f) Create artificial VBs by taping large, plastic sheets to the walls inside hallways, the top and bottom of stairwells, etc.

(g) Construct a personnel safety zone in the center of the living area (location where personnel will remain during attack situations). Accomplish this by—

- Creating a physical barrier between the personnel safety zone and the outside building wall by moving furniture (dressers, chairs, bookcases, etc.) around the safety zone.

- Erecting a tent or similar structure in the safety zone. This structure will serve as the final protective layer during an attack situation. The object is to prevent physical contact with contamination if an explosion breaches the outer wall.

(h) Turn off the air conditioners/heating systems, or ensure that they can be turned off within seconds if an attack warning is received.

(i) Determine the suitability of air supply in the living area (amount and staleness). When the shelter is known to be in an uncontaminated area, unseal an access point, let fresh air in, and reseal the access point if necessary.

(j) Ensure that the following items are accessible:

- Decontamination buckets and materials (to include knife/scissors and containers for contaminated-waste disposal).

- Food and water supplies. Personnel should have enough food and water to last at least 72 hours without requiring electric or gas cooking facilities.

- Fire extinguisher.

- Light sources (preferably flashlights with a supply of batteries).

- Clothing.

c. Protection Afforded by Various Clothing Items. It is important to realize that clothing items other than specialized protective equipment will provide a degree of protection against agent contamination and exposure. The following are recommended clothing items to include levels and layers to aid in protection:

(1) During Attack. In order to maximize protection, NEO personnel should have at least two layers of clothing (in addition to underwear) on at the time of attack. This configuration would allow the removal of contaminated outer garments while still retaining a degree of protection from contact with the agent or its vapors. Specifically, NEO personnel should adhere to the following concepts:

- The acquisition of respiratory protection is the utmost priority.

- Military issue protective masks should be used. If they are not available, personnel should acquire commercially available carbon filter, vapor protection masks (e.g., paint or pesticide delivery masks). Dust or surgical masks are not appropriate. If commercial masks are not available, personnel should fashion a close-knit material around their noses and mouths. The material should be wetted with water.

- The inner clothing layer should cover as much of the body as possible (e.g., long pants and shirts versus shorts and T-shirts).

- The inner clothing layer should consist of dense, tightly-woven fabrics (e.g., denim versus cotton-knitted materials).

- The outer clothing layer should be water-resistant (e.g., poncho or raincoat).

- The outer clothing layer should have minimal seams, zippers, and buttons. Each of these areas represents a weak spot compared to the rest of the garment.

- A hood or hat should be worn to provide protection for the head area. The same concepts (dense, tightly-woven fabric) used for clothing also apply to the best choice of material for a hood or hat.

- Gloves should be worn.

- Heavy boots (covering the ankle) are the best choice. If available, outer, heavy rubber, rain boots should be worn over inner shoes. The inner shoes should have rubber or hard-leather soles.

- Garment openings (in between buttons or snaps, sleeve openings, etc.) should be taped shut. The garments should be taped over the top (cuff) of the gloves and the top of the boots.

(4) During Transport from Shelter to Passenger Waiting Area/Aircraft. The same concepts expressed in paragraph c (1) apply here. The exception is that personnel should wear three layers of clothing over their underwear versus two. Two layers should be water-resistant (poncho or rain suit count as a layer) and worn over an inner layer of dense fabric because personnel may be contaminated during the transportation process (either contact or vapor absorption) from their shelter to the passenger waiting area.

(5) Recommended Clothing Preparation Activities. During the preattack stage, NEO personnel should double-bag each set of clothing that offers protective capabilities but is not being worn and seal the closure with tape or a knot. This will prevent the inadvertent loss of clothing as a result of contamination breaching the shelter area.

d. Decontamination Operations.

(1) Given the possibility that NEO personnel may not have access to specialized decontamination kits or equipment, they must be able to use readily obtainable items to accomplish required decontamination operations. Further, it is important that NEO personnel understand the basic tenants associated with contamination control operations. Specifically—

- Know that contamination avoidance is the best defense. Protecting personnel or materials by providing cover (layers of clothing, double bagging, etc.) that prevents direct contact with the agent is the single most important factor.

- Recognize and understand the hazard. Personnel must be able to distinguish what chemical contamination looks like and where it is likely to be.

- Decontaminate exposed skin areas immediately (within seconds). Rapidly (within minutes) decontaminate clothing items, remembering that removal is an effective decontamination method.

- Keep as much distance between themselves and the contamination as possible. Use standoff decontamination systems, such as a mop, whenever possible. Never directly touch the contamination with exposed skin.

- Clean gloves routinely by dipping them in decontamination buckets containing a 5 percent solution of chlorine (undiluted household bleach) and rinsing them with clear water (just a couple of seconds in each).

- Use military detectors, if available, to assess the effectiveness of decontamination operations. Recognize that a vapor hazard, however small, may still exist even though M8 or M9 detection paper readings are negative.

- Remove the hazard, if possible. For example, if a chair was the only thing contaminated in a room (due to a breach through a broken window for instance), the best option might be to remove the chair.

(2) Decontamination Methods. NEO personnel may use the following items to achieve reasonable decontamination results:

(a) Chlorine Solutions. A 5 percent chlorine solution (bleach) is an exceptionally effective decontaminating agent for material. Directly apply the chlorine solutions (undiluted household bleach) to the surface and rinse it with clear water. Scrubbing the area is generally not necessary. Use a chlorine solution in buckets and troughs for glove/boot decontamination operations.

(b) Miscellaneous Items. Personnel can use rags, paper towels, dirt, sawdust, or any other absorbent material to remove chemical contamination.

e. Attack Response Actions for NEO Personnel.

(1) Preattack.

- Seek shelter by moving to the designated shelters.
- Protect unused food, clothing, and water supplies. Accomplish this by sealing the items in appropriate containers, double-bagging, etc.

- Remain prepared according to the guidelines contained in paragraph c (1).

(2) During Attack.

- Take cover in the central shelter area.
- Decontaminate clothing and/or skin immediately if contamination enters the shelter area.

(3) Postattack.

- Remain calm. Check individuals for contamination, and decontaminate, as necessary.

- Check the shelter area for contamination. Assess the situation and decontaminate or relocate as necessary.

- Seek medical attention as required.

- Verify the integrity and contamination status of the entire shelter system. Do not venture outside. Reseal and/or repair items as necessary.

Appendix G
NUCLEAR, BIOLOGICAL, AND CHEMICAL DEFENSE EQUIPMENT
DATA

The information in this appendix provides national stock numbers (NSNs) for selected items of NBC defense equipment (see Table G-1 [page G-2]). The information in the table is extracted from the Federal Logistics (FED LOG) data dated 1 October 2001. The basis of issue (BOI) will depend on service-specific authorization documents. FED LOG data changes periodically; therefore, NSNs and item descriptions must be checked according to applicable service logistics directives. Table G-1 (page G-2) serves only as a guide.

Table G-1. NBC Defense Equipment

Item Nomenclature	NSN
CP Clothing Items (continued)	
Cape, Air Crew Member	8415-01-040-9018
Apron, Toxicological Agents Protective	8415-00-281-7812 (XS) 8415-00-281-7813 (S) 8415-00-281-7814 (M) 8415-00-281-7815 (L) 8415-00-281-7816 (XL)
Bag, Chemical Protective Clothing	8465-01-216-6259
Boots, Toxicological Agents Protective	8430-00-820-6304 (Size 5) 8430-00-820-6303 (Size 6) 8430-00-820-6306 (Size 7) 8430-00-820-6302 (Size 8) 8430-00-820-6301 (Size 9) 8430-00-820-6300 (Size 10) 8430-00-820-6299 (Size 11) 8430-00-820-6298 (Size 12) 8430-00-820-6297 (Size 13) 8430-00-820-6296 (Size 14) 8430-00-820-6295 (Size 15) 8430-01-470-9526 (Size 16) 8430-01-470-9528 (Size 17)
Cover, Helmet, Chemical Protective	8415-01-111-9028
Coveralls, Toxicological Agents Protective	8415-00-099-6962 (S) 8415-00-099-6968 (M) 8415-00-099-6970 (L) 8415-01-105-2535 (XL)
Footwear Covers, Chemical Protective	8430-01-118-8172 (S) 8430-01-021-5978 (L)
Footwear Covers, Toxicological Agents Protective	8430-00-262-5295 (S) 8430-00-262-5297 (M) 8430-00-262-5296 (L)
Footwear Covers, Liquid Contamination	8415-01-333-0990 (S) 8415-01-333-0991 (M) 8415-01-333-0992 (L)
Gloves, Toxicological Agents Protective	8415-00-820-6294 (S) 8415-00-820-6305 (M) 8415-00-820-6293 (L) 8415-00-820-6292 (XL)
Gloves, Toxicological Agents Protective	8415-00-753-6550 (XS) 8415-00-753-6551 (S) 8415-00-753-6552 (M) 8415-00-753-6553 (L) 8415-00-753-6554 (XL)

Table G-1. NBC Defense Equipment (Continued)

Item Nomenclature	NSN
CP Clothing Items (continued)	
Glove Set, Chemical Protective (Material: Rubber Butyl) (0.014 inch thickness)	8415-01-144-1862 (XS) 8415-01-138-2497 (S) 8415-01-138-2498 (M) 8415-01-138-2499 (L) 8415-01-138-2500 (XL)
Gloves, Chemical Protective	8415-01-138-2501 (S) 8415-01-138-2502 (M) 8415-01-138-2503 (L) 8415-01-138-2504 (XL)
Gloves, Nuclear, Biological, and Chemical	8415-01-452-9642 (S) 8415-01-452-9647 (M) 8415-01-452-9646 (L)
Gloves, Men's	8415-00-268-8353 (M) 8415-00-268-8354 (S)
Gloves, Flyer's, Summer, Type GS/FRP-2	8415-01-029-0109 (7) 8415-01-029-0111 (8) 8415-01-029-0112 (9) 8415-01-029-0113 (10) 8415-01-029-0116 (11)
Glove Inserts, Chemical Protective	8415-01-138-2494 (S) 8415-01-138-2495 (M) 8415-01-138-2496 (L)
Coat, Chemical Protective (Woodland Camouflage Pattern)	8415-01-444-1163 (S/XSHT) 8415-01-444-1169 (S/SHT) 8415-01-444-1200 (M/SHT) 8415-01-444-1238 (M/REG) 8415-01-444-1249 (M/LNG) 8415-01-444-1265 (L/REG) 8415-01-444-1270 (L/LNG)

Table G-1. NBC Defense Equipment (Continued)

Item Nomenclature	NSN
CP Clothing Items (continued)	
Coat, Chemical Protective (Desert Camouflage Pattern)	8415-01-444-5902 (SXSHT) 8415-01-444-5905 (S/SHT) 8415-01-444-5913 (M/SHT) 8415-01-444-5926 (M/REG) 8415-01-444-6116 (M/LNG) 8415-01-444-6138 (L/REG) 8415-01-444-6131 (L/LNG)
Trousers, Chemical Protective (Woodland Camouflage Pattern)	8415-01-444-1435 (S/XSHT) 8415-01-444-1439 (S/SHT) 8415-01-444-1613 (M/SHT) 8415-01-444-2310 (M/REG) 8415-01-444-2308 (M/LNG) 8415-01-444-2325 (L/REG)
Trousers, Chemical Protective (Desert Camouflage Pattern)	8415-01-444-5417 (S/XSHT) 8415-01-444-5504 (S/SHT) 8415-01-444-5506 (M/SHT) 8415-01-444-5893 (M/REG) 8415-01-444-5892 (M/LNG) 8415-01-444-5898 (L/REG) 8415-01-444-5900 (L/LNG)
Overboot, Multipurpose (Black)	8430-01-464-9453 (3) 8430-01-464-9458 (4) 8430-01-464-9459 (5) 8430-01-464-9461 (6) 8430-01-464-9462 (7) 8430-01-464-9464 (8) 8430-01-464-9474 (9) 8430-01-464-9475 (10) 8430-01-464-9477 (11) 8430-01-464-9480 (12) 8430-01-464-9479 (13) 8430-01-464-9484 (14)

Table G-1. NBC Defense Equipment (Continued)

Item Nomenclature	NSN
CP Clothing Items (continued)	
Overshoes, Men's (Black Vinyl Upper)	8430-01-317-3374 (3) 8430-01-317-3375 (4) 8430-01-317-3376 (5) 8430-01-317-3377 (6) 8430-01-317-3378 (7) 8430-01-317-3379 (8) 8430-01-317-3380 (9) 8430-01-317-3381 (10) 8430-01-317-3382 (11) 8430-01-317-3383 (12) 8430-01-317-3384 (13) 8430-01-317-3385 (14)
Overshoes, Men's (Olive Green Vinyl Upper)	8430-01-048-6305 (3) 8430-01-048-6306 (4) 8430-01-049-0878 (5) 8430-01-049-0879 (6) 8430-01-049-0880 (7) 8430-01-049-0881 (8) 8430-01-049-0882 (9) 8430-01-049-0883 (10) 8430-01-049-0884 (11) 8430-01-049-0885 (12) 8430-01-049-0886 (13) 8430-01-049-0887 (14)

Table G-1. NBC Defense Equipment (Continued)

Item Nomenclature	NSN
CP Clothing Items (Continued)	
Coveralls, Chemical Protective (Sage Green) (Designed for Aircrew Member)	8475-01-328-3454 (32/SHT) 8475-01-328-3455 (32/REG) 8475-01-328-3456 (34/SHT) 8475-01-328-3457 (34/REG) 8475-01-328-3458 (36/SHT) 8475-01-328-3459 (36/REG) 8475-01-328-3460 (36/LNG) 8475-01-328-3461 (38/SHT) 8475-01-328-3462 (38/REG) 8475-01-283-3463 (38/LNG) 8475-01-283-3464 (40/SHT) 8475-01-283-3465 (40/REG) 8475-01-283-3466 (40/LNG) 8475-01-283-8249 (42/SHT) 8475-01-283-3467 (42/REG) 8475-01-283-3468 (42/LNG) 8475-01-283-3469 (44/SHT) 8475-01-283-3470 (44/REG) 8475-01-283-8250 (44/LNG) 8475-01-283-3471 (46/SHT) 8475-01-283-3472 (46/REG) 8475-01-283-3473 (46/LNG) 8475-01-283-3474 (48/REG) 8475-01-283-3475 (48/LNG)

Table G-1. NBC Defense Equipment (Continued)

Item Nomenclature	NSN
CP Clothing Items (Continued)	
Coveralls, Chemical Protective (Sand Brown) (Designed for Ground Crew Members)	8475-01-283-3434 (36/SHT) 8475-01-283-3435 (36/REG) 8475-01-283-3437 (38/SHT) 8475-01-283-3438 (38/REG) 8475-01-283-3439 (38/LNG) 8475-01-283-3440 (40/SHT) 8475-01-283-3441 (40/REG) 8475-01-283-3442 (40/LNG) 8475-01-283-3443 (42/SHT) 8475-01-283-3444 (42/REG) 8475-01-283-3445 (42/LNG) 8475-01-283-3446 (44/SHT) 8475-01-283-3447 (44/REG) 8475-01-283-3448 (44/LNG) 8475-01-283-3450 (46/REG) 8475-01-283-3451 (46/LNG) 8475-01-283-3452 (48/REG)
Footwear Covers, Liquid Contamination, (Green Latex, Slip-On)	8430-01-364-3458 (S) 8430-01-364-3459 (M/L) 8430-01-364-3460 (XL/XXL)
Clothing Outfit, Liquid Contamination (Green Poncho, Attached Hood)	8415-01-364-3320 (S) 8415-01-364-3321 (M/L) 8415-01-364-3322 (XL/XXL)
Suit, Chemical Protective	8415-01-452-6772 (S) 8415-01-452-8631 (M) 8415-01-452-8629 (L)
Suit, Chemical Protective (Woodland Camouflage Pattern)	8415-01-137-1700 (XXXS) 8415-01-137-1701 (XXS) 8415-01-137-1702 (XS) 8415-01-137-1703 (S) 8415-01-137-1704 (M) 8415-01-137-1705 (L) 8415-01-137-1706 (XL) 8415-01-137-1707 (XXL)

Table G-1. NBC Defense Equipment (Continued)

Item Nomenclature	NSN
CP Clothing Items (Continued)	
Suit, Chemical Protective (Coat and Trousers) (Three-Color, Desert Camouflage Pattern)	8415-01-327-5346 (XXXS) 8415-01-327-5347 (XXS) 8415-01-327-5348 (XS) 8415-01-327-5349 (S) 8415-01-327-5350 (M) 8415-01-327-5351 (L) 8415-01-327-5352 (XL) 8415-01-327-5353 (XXL)
Suit, Chemical Protective (Coat and Trousers) (Six-Color, Desert Camouflage Pattern)	8415-01-324-3084 (XXXS) 8415-01-324-3085 (XXS) 8415-01-324-3086 (XS) 8415-01-324-3087 (S) 8415-01-324-3088 (M) 8415-01-324-3089 (L) 8415-01-324-3090 (XL) 8415-01-324-3091 (XXL)
Suit, Chemical Protective (Coat and Trousers) (Desert Camouflage Pattern)	8415-01-333-7577 (S) 8415-01-333-7578 (M) 8415-01-333-7579 (L) 8415-01-333-7580 (XL)
Suit, Chemical Protective (Coat and Trousers) (Woodland Camouflage Pattern)	8415-01-333-7573 (S) 8415-01-333-7574 (M) 8415-01-333-7575 (L) 8415-01-333-7576 (XL)
Clothing Outfit, Liquid Contamination (Tan Trousers and Poncho With Hood)	8415-01-333-0987 (S) 8415-01-333-0988 (M/L) 8415-01-333-0989 (XL/XXL)
Suit, Chemical Protective (Coat and Trousers, Olive Drab Nylon) (Fire-and Oil-Resistant)	8415-01-214-8290 (M)

Table G-1. NBC Defense Equipment (Continued)

Item Nomenclature	NSN
CP Clothing Items (Continued)	
Drawers, Chemical Protective	8415-01-363-8683 (Size 26) 8415-01-363-8684 (Size 28) 8415-01-363-8685 (Size 30) 8415-01-363-8686 (Size 32) 8415-01-363-8687 (Size 34) 8415-01-363-8688 (Size 36) 8415-01-363-8689 (Size 38) 8415-01-363-8690 (Size 40) 8415-01-363-8691 (Size 42) 8415-01-488-5719 (Size 44) 8415-01-488-5722 (Size 46) 8415-01-488-5720 (Size 48)
Undershirt, Chemical Protective	8415-01-363-8692 (Size 32) 8415-01-363-8693 (Size 34) 8415-01-363-8694 (Size 36) 8415-01-363-8695 (Size 38) 8415-01-363-8696 (Size 40) 8415-01-363-8697 (Size 42) 8415-01-363-8698 (Size 44) 8415-01-363-8699 (Size 46) 8415-01-363-8700 (Size 48) 8415-01-488-5715 (Size 50) 8415-01-488-5717 (Size 52) 8415-01-488-5716 (Size 54)
Protective Masks	
Mask, Chemical-Biological	4240-01-143-2017 (1) 4240-01-143-2018 (S) 4240-01-143-2019 (M) 4240-01-143-2020 (L)
Mask, Chemical-Biological	4240-01-258-0061 (S) 4240-01-258-0062 4240-01-258-0063
Mask, Chemical-Biological	4240-01-370-3821 (S) 4240-01-370-3822 (M) 4240-01-370-3823 (L)
Mask, Chemical-Biological	4240-01-258-0064 4240-01-258-0065 4240-01-258-0066
Mask, Chemical-Biological (M42E1)	4240-01-369-7854 (S) 4240-01-370-2622 (M) 4240-01-369-7855 (L)
Mask, Chemical-Biological (M42A2)	4240-01-413-4100 (S) 4240-01-413-4101 (M) 4240-01-413-4102 (L)

Table G-1. NBC Defense Equipment (Continued)

Item Nomenclature	NSN
Protective Masks (Continued)	
Mask, Chemical-Biological	4240-01-208-6966 (S) 4240-01-208-6967 (M) 4240-01-208-6968 (L) 4240-01-208-6969 (XL)
Mask, Chemical-Biological	4240-01-265-2677 (S) 4240-01-265-2678 (L) 4240-01-265-2679 (M) 4240-01-265-2680 (XL)
Mask, Chemical-Biological	4240-01-319-5365 (S) 4240-01-320-8949 (M) 4240-01-319-5364 (L) 4240-01-319-5366 (XL)
Mask, Chemical-Biological	4240-01-319-5367 (S) 4240-01-319-5368 (M) 4240-01-319-5369 (L) 4240-01-319-5370 (XL)
Mask, Chemical-Biological (M45)	4240-01-414-4034 (XS) 4240-01-414-4035 (S) 4240-01-414-4051 (M) 4240-01-414-4052 (L)
Mask, Chemical-Biological (M48) (Apache Aviator)	4240-01-386-0198 (S) 4240-01-386-4686 (M) 4240-01-386-0201 (L) 4240-01-386-0207 (XL)
Mask, Chemical-Biological (M49) (General Aviator)	4240-01-413-4099 (S) 4240-01-413-4095 (L) 4240-01-413-4096 (M) 4240-01-413-4097 (XL)
Mask, Chemical-Biological (Includes Hood)	4240-01-175-3443 (S) 4240-01-175-3444 (M) 4240-01-175-3445 (L)
Mask, Chemical-Biological	4240-01-284-3615 (S) 4240-01-284-3616 (M) 4240-01-284-3617 (L)
Tester Kit, Protective Mask	

Table G-1. NBC Defense Equipment (Continued)

Item Nomenclature	NSN
Protective Mask Associated Parts & Items	
Carrier, Field, Chemical-Biological	4240-00-933-2533
Chemical Agent Detectors	
Alarm, Chemical Agent, Automatic (M43E1)	6665-01-105-5623
Alarm, Chemical Agent, Automatic (M22)	6665-01-438-6963
Monitor, Chemical Agent (AACZ 16) (216)	6665-01-199-4153
Monitor , Chemical Agent (AACZ 16) (247)	6665-01-357-8502
Detector Kit, Chemical Agent (M256A1)	6665-01-133-4964
Detector Kit, Chemical Agent (6665-94-CL-E14)	6665-00-903-4767
Detector Paper, Chemical Agent (M8)	6665-00-050-8529
Detector Paper, Chemical Agent (M9)	6665-01-226-5589
Water Testing Kit, Chemical Agent	6665-01-134-0885
Miscellaneous Items	
Sign Kit, Contamination (M274)	9905-01-346-4716
Sign Kit, Contamination	9905-12-124-5955
Decontamination Items	
Decontaminating Kit, DKIE, M280 (20Kit/Box) 3 packets/kit	
Decontaminating Kit, Skin (M291) (6 packets)	6850-01-276-1905
Decontaminating Kit, Individual Equipment (M295)	6850-01-357-8456
Decontaminating Apparatus (1-1/2 quart) (mounting bracket)	4230-00-720-1618
Decontaminating Agent (DS2) (1-1/3 quart)	6850-00-753-4827
Decontaminating Apparatus (M13)	4230-01-133-4124
Decontaminating Agent (DS2)	4230-01-136-8888
Decontaminating Agent (DS2) (5 gallon)	6850-00-753-4870
Decontaminating Agent (STB) (50-gallon drum)	6850-00-297-6653
Decontaminating Apparatus (M17) (1500-gallon collapsible water tank)	4230-01-251-8702
Decontaminating Apparatus (M17) (3000-gallon collapsible water tank kit)	4230-01-303-5225
Decontaminating Apparatus (M17) (collapsible water tank)	4230-01-346-1778
Decontaminating Apparatus (M17) (collapsible water tank)	4230-01-346-3122
Decontaminating Apparatus (Skid-Mounted) (M12A1)	4230-00-926-9488
Pump Unit, Centrifugal (65 gallons per minute)	4320-00-752-9466
Pump Unit, Centrifugal	4320-01-338-8010

Table G-1. NBC Defense Equipment (Continued)

Item Nomenclature	NSN
Collective Protection	
Collective Protective Equipment	4240-01-166-2254
Entrance, Protective, Pressurized	4240-01-202-0467
Room Liner, Package	4240-01-200-4326
Collective Protection Equipment (M20A1)	4240-01-330-7806
Collective Protective Equipment (M28)	4240-01-330-7807
Collective Protective Equipment (M28) (2 liners)	4240-01-330-7808
Collective Protective Equipment (M28) (Airlock)	4240-01-330-7809
Collective Protective Equipment (M28) (Hub Configuration)	4240-01-395-5179
Maintenance Kit, CBR Equipment (for M28 System)	5180-01-331-2921
Collective Protective Equipment: (M28)	4240-01-331-2922
Collective Protective Equipment (M28)	4240-01-331-2923
Entrance, Protective, Pressurized (for M28 System)	4240-01-331-2938
Entrance, Protective, Pressurized (M10)	4240-00-229-2610
Entrance, Protective, Pressurized	4240-01-048-2923
Entrance, Protective, Pressurized (M13)	4240-01-155-9971
Entrance, Protective, Pressurized (M14)	4240-01-105-5521
Entrance, Protective, Pressurized (M15)	4240-01-185-6786
Entrance, Protective, Pressurized	4240-01-240-4367
Entrance, Protective, Pressurized Exterior (M18)	4240-01-283-0193
Entrance, Protective, Pressurized Interior (M19)	4240-01-283-0192
Entrance, Protective, Pressurized Exterior(M20)	4240-01-283-0194
Filter, Particulate (Glass Fiber Filter)	4240-01-066-3266
Filter Set, Gas-Particulate (Chromium-Free, Carbon Filter)	4240-01-369-6533 (New)
Filter Set, Gas-Particulate	4240-01-067-5605 (Old)
Filter, Particulate (Glass Fiber Filter) (200 cfm)	4240-01-066-3266
Filter, Gas (Charcoal Filter) (150 cfm)	4240-00-256-9094
Filter, Gas (12 cfm)	4240-01-365-0981 (New)
Filter, Gas (12 cfm) (Charcoal Filter)	4240-00-289-7978 (Old)
Filter, Particulate (Asbestos Filter)	4240-00-368-6291
Filter, Gas (10 cfm)	4240-01-365-0982 (New)
Filter, Gas (Charcoal Filter) (10 cfm)	4240-00-828-3952 (Old)
Filter, Particulate (Asbestos Filter) (20 cfm)	4240-00-866-1825
Filter, Gas (Chromium-free Carbon Filter) (150 cfm)	4240-01-363-1310 (New)
Filter, Gas (Charcoal Filter) (150 cfm)	4240-00-802-5170 (Old)
Filter, Particulate (150 cfm)	4240-00-802-5169
Filter Unit, Gas Particulate (12 cfm) (Built-In transformer)	4240-00-203-3999
Filter Unit, Gas Particulate (12 cfm)	4240-00-853-3201
Filter Unit, Gas Particulate (12 cfm)	4240-00-788-5310
Filter Unit, Gas Particulate(12 cfm)	4240-00-010-5267
Filter Unit, Gas Particulate (200 cfm)	4240-00-237-0227

Table G-1. NBC Defense Equipment (Continued)

Item Nomenclature	NSN
Collective Protection	
Filter Unit, Gas Particulate (400 cfm)	4240-00-237-0223
Filter Unit, Gas Particulate	4240-01-149-1719
Filter Unit, Gas Particulate (400 cfm)	4240-01-192-7234
Filter Unit, Gas Particulate (100 cfm)	4240-01-231-6515
Filter Unit, Gas Particulate (200 cfm)	4240-01-274-6355
Filter Unit, Gas Particulate (400 cfm)	4240-01-274-6356
Radiac Equipment	
Charger, Radiac Detector (PP-1578/PD)	6665-00-542-1177
Container Adapter A	6665-01-077-2986
Radiac meter (IM-911/PD)	6665-00-243-8199
Radiac meter	6665-00-752-7759
Radiac meter	6665-01-330-7520
Radiac Set (AN/UDR-13)	6665-01-407-1237
Radiac meter	6665-00-999-5145
Radiac meter	6665-01-056-7422
Radiac Set (AN/PDR- 27A)	6665-00-526-5334
Radiac Set (AN/PDR-27J)	6665-00-543-1435
Radiac Set(AN/PDR-27G)	6665-00-543-1443
Radiac Set (AN/PDR-27L)	6665-00-856-3456
Radiac Set (AN/PDR-27Q)	6665-00-017-8903
Radiac Set (AN/PDR-27P)	6665-00-975-7222
Radiac Set	6665-01-080-4418
Radiac Set (AN/PDR-60)	6665-00-965-1516
Radiac Set	6665-01-113-9530
Radiac Set	6665-01-211-4217
Radiac Detector	6665-01-043-2191
Radiac Set (AN/VDR-2)	6665-01-222-1425
BOI: Prescribed by service logistics publications/directives.	

Appendix H

WEAPONS OF MASS DESTRUCTION THREATS USING POSTAL MAIL/PACKAGES

1. Background

This appendix provides guidance on steps to take when and if a suspect letter/package is received opened or unopened. Recent criminal and/or terrorist events/threats involving the mail system have prompted personnel to be alert for and recognize suspicious parcels and letters as a FP initiative. Becoming familiar with the characteristics of suspect parcels can help avert a tragedy.

2. Possible Indicators and Characteristics of Suspect Mail/Packages

Any suspicious looking package or letter should be considered a potential bomb/hazard and should be treated accordingly. Possible indicators may include—

- Inaccurate addressee name or title.
- Fictitious or unavailable return address.
- No return address.
- Handwritten or poorly-typed address.
- Distorted handwriting or name and address prepared with homemade labels or cut-and-paste lettering.
- Misspelled common words.
- Restrictive markings such as “personal” or “confidential.”
- Protruding wires, aluminum foil, or oil stains.
- Excessive weight or a feeling of powdery substance or liquid on the package.
- Peculiar smell emitting from the package.
- Cancelled postmark being from a different location than the return address.
- Excessive postage.
- Rigidity, unevenness, or lopsidedness.

- Unprofessional wrapping with several combinations of tape used to secure the package. May be endorsed “Fragile—Handle With Care” or “Rush—Do Not Delay.”
- Irregular shape, soft spots, or bulges.
- Sloshing sound.
- Pressure or resistance being felt when removing contents.

3. Handling Instructions

a. Suspicious, unopened letter/package.

- (1) Do not open the letter/package.
- (2) Isolate and contain the letter/package immediately. Do not touch, shake, or tear it open.
- (3) Leave the room, and close the door or section off the area to prevent others from entering.
- (4) Contact the supervisor, law enforcement officials, and the specialists for help and to report the location and description of the letter/package.
- (5) Wash your hands with soap and water if contact with the outside of the letter/package is made.
- (6) Start a list of names and telephone numbers of all persons who have handled the letter/package. Give the list to law enforcement officials for follow-up investigations and advice.
- (7) Wait for help to arrive.

b. Opened letter/package that contains a powdery substance.

- (1) If the letter has already been opened and powder spills out, do not clean it up or brush it off clothing. Do not disturb the package any further. Do not pass the package around. Keep others away from the area.
- (2) Cover the letter/package with cloth, plastic, paper, or a container, if conditions permit, to limit and/or contain aerosolization of the powder. (This must be performed with resources located in the immediate vicinity without leaving the room and in less than a minute, so improvise. If the letter/package cannot be covered, exit the area immediately.)
- (3) Leave the contaminated area, go to a clean isolated area, and close off the area to limit access to the package. Lock the room, and/or leave a guard outside. Place a sign explaining the emergency, and restrict access/entrance into the contaminated area.

(4) Keep your hands away from your face to avoid contaminating eyes, nose, or mouth.

(5) Wash hands with soap and water and flush eyes with water immediately (without leaving the area).

(6) Shut down the building ventilation system, and turn off fans and equipment that are circulating air around the workspace if possible. This will minimize aerosolization of the substance.

(7) Notify the supervisor, law enforcement officials, and other emergency response personnel.

(8) Notify local, county, and state health officials.

(9) Ensure that all persons who have handled the letter/package wash their hands.

(10) Start a list of names and telephone numbers of all personnel who have handled the letter/package.

(11) Give potentially exposed persons information about the signs and symptoms of illness associated with the biological agent and who to contact and where to go if illness develops.

(12) Place all clothing items worn when in contact with the letter/package into plastic bags. Keep the bags with you at all times to maintain the chain of custody and control of the contaminated clothing and to limit the spread of contamination. Turn the bags over to law enforcement officials for necessary disposition and medical analysis.

(13) Shower with soap and water as soon as possible (ensure that all exposed skin is washed and rinsed to remove contamination, and rinse your eyes with clear water). Do not use bleach or disinfectant on skin.

c. Suspected improvised explosive device (IED) that arrives in a letter or package.

(1) Do not touch, shake, or tear open the letter/package. Evacuate the area immediately. If the mail is opened, do not touch, shake, drop, or handle it any further.

(2) Restrict access to the area.

(3) Call law enforcement officials. Remain in the general area to await first responder, law enforcement, and supervisory personnel.

d. Individual and response team actions.

(1) Actions taken by mail personnel when handling opened and unopened suspicious letters/packages are similar to those described earlier; however, mail room personnel may don the following protective gear prior to handling packages to reduce/limit the exposure to CB hazards:

- Respirator of a specified type (dust masks).
- Gloves (latex or approved).
- Long-sleeved clothing.
- Disposable aprons.
- Eye goggles.

(2) Actions taken by responding teams when notified of an incident involving a suspected package containing hazardous materials may include the following:

(a) Arrive on the scene with appropriate protective gear, decontamination supplies, water, plastic bags, and coveralls (for affected personnel needing fresh clothing).

(b) Secure the area to minimize the spread of contamination, protect the crime scene (for later evidence collection), decontaminate those persons affected, and remove them for medical treatment.

(c) Assist affected persons. Decontamination procedures for affected persons will vary depending on the degree of exposure. All persons in the room are at risk. The person who opened the package and any others who came in contact with the package after it was opened are at greatest risk. Assist affected persons by ensuring that they—

- Wet down their clothing with water or diluted bleach to reduce the risk of secondary aerosols.

- Remove their clothing and personal items and place them in marked bags.

- Wash their hands.

- Change into fresh clothing.

- Wash thoroughly with soap and water, if a shower is available, shampoo hair, and change into fresh clothing.

(d) If a shower is not available, change into fresh clothing to mitigate the possibility of transfer of contamination; and then transport personnel to established decontamination and treatment facilities. Upon completion of showers and decontamination, personnel will change into fresh clothing.

(e) Give potentially exposed personnel information about the signs and symptoms of illness associated with the hazard and who to contact and where to go if illness develops.

4. Reach-Back Capability

In response to a report of a suspected letter/package, the technical reach-back capability is available if technical issues exceed on-site, local, subject matter experts (SME) capabilities (see Table H-1). Reach back should be conducted using established local protocols and SOPs. Local information management protocols and the chain of command must be followed prior to using any of the listed hot-line numbers.

Table H-1. Reach-Back Points of Contact

National Response Center, Chemical Terrorism/ Chemical Biological Hot Line	(800) 424-8802
Technical Chemical and Biological Assistance Hot Line at US Army Soldier Biological Chemical Command	(877) 269-4496
Defense Threat Reduction Agency (DTRA)	(877) 244-1187
US Army Medical Research Institute of Infectious Diseases (USAMRIID)	(888) 872-7443 (USA-RIID)
US Army Medical Research Institute of Chemical Defense (USAMRICD)	(800) 424-8802
Armed Forces Radiobiology Research Institute (AFRRI)	(301) 295-0316 or (301) 295-0530 Fax: (301) 295-0227

Appendix I

PROTECTIVE MASK PRESCRIPTION OPTICAL INSERTS

1. Background

Over 40 percent of military service members wear prescription eyewear. Those individuals who have a visual acuity of less than 20/40 (20/20 is required for some professions, such as pilots) with their eyewear removed are required to use prescription inserts when using their masks (Army Regulation [AR] 40-63/NAVMEDCOMINST 6810.1/Air Force Reserve [AFR] 163-7), *Ophthalmic Services*, 1 January 1986. This appendix describes the prescription optical inserts for protective masks currently in use, the insert installation instructions, and the insert procurement information.

2. M40/M42 Series

The M40 is the general-purpose mask for USA and USMC infantry and civilian workers replacing the M9, M17, and M25 mask series. Sizes for the mask are small, medium, and large.

a. Optical Inserts, Ground Use. The inserts are nickel silver metal with temple rings that insert into the eye ring of the mask. The front is a 44-mm eye size for the optical correction, a 74-mm frame size, and a spring-hinged bridge. The temples swivel forward of the frame front to spring-fit into the mask eye ring.

(1) Installation. Hold the insert temples by the plastic tabs, and swivel them in front of the frame front. Insert the lower section of one temple in the lower groove of the mask eye ring just behind the mask lens, and continue around the entire temple until it springs into place. Repeat for the other side.

(2) Procurement. The insert is ordered from the military optical laboratories through the military eye clinic.

Note: The ophthalmic laboratories are in the process of changing the ground use masks to the same insert system as the aviation version. See the following paragraphs for insert description, installation, and procurement instructions for the aviation type insert.

b. Optical Inserts, Aviation Use. The prescription lenses are mounted in the prescription lens carrier (PLC) frame. The PLC is attached to the black, plastic mount placed behind the lenses of the mask. The clear frame front is a 52-mm eye size for the optical correction and has a spring-hinged bridge. The black, plastic mount is a 73-mm frame size for mounting in the mask and has a groove to receive the clear frame front.

(1) Installation. Insert the black, plastic mount in the groove at the back edge of the mask eye ring with the PLC mounting keyway facing back. Snap the mounting ends (tooth grip molded in) together to allow the mounting frame to expand fully into the mask eye ring. Select the height to center the lenses over the pupils to provide the best field of

view. Remove the mask and fold the two lenses together to show two small, brass setscrews. Tighten the setscrews gently to hold the setting of the PLC.

(2) Procurement. Military supply personnel are responsible for ordering NSN 4240-01-389-7152, black, plastic mount for their unit. The individual requiring optical correction will order the PLC from military optical laboratories through military eye clinics.

3. M43 Series

USA aircrews use this mask series. The Type I mask is used by Apache helicopter pilots and has a notched right eyepiece to accommodate the Apache helicopter helmet sighting system. All other USA aircrews wear the Type II mask. Sizes for the mask are small, medium, large, and extra large. There are no optical inserts for this mask. Pilots requiring vision correction are provided contact lenses.

4. M45 Series

This mask is currently being fielded and replaces the M24/M42/M43/M49 aviation series. It will be used by all Army aircrew, except Apache helicopter pilots. Sizes for the mask are extra small, small, medium, and large. The optical insert is a plastic frame front with a flexible plastic or titanium alloy bridge wire.

a. Installation. Snap the insert into the eye ring grooves behind the mask lens.

b. Procurement. Order the inserts from military optical laboratories through military eye clinics.

5. M48 Series

The M48 mask is used by Apache helicopter pilots. This mask has a notched right eyepiece to accommodate the Apache helicopter sighting system. The M48 series masks have the same mask front as the M43 series, but they use a different blower system. Sizes for the mask are small, medium, large, and extra large. There are no optical inserts for this mask. Pilots requiring correction are provided contact lenses.

6. MCU2/P Series

a. The MCU2/P is a general-purpose mask used by the USN, USAF, USMC, USCG, Federal Bureau of Investigation (FBI), Drug Enforcement Agency (DEA), Department of Energy (DOE), and the Secret Service. Sizes for the mask are small, medium, and large.

b. The optical insert is a black, nylon frame front and bridle with a black, neoprene, adjustable, strap headband that is worn like regular spectacles. The front comes in three eye sizes (46, 48, and 50 mm) and the bridge comes in two sizes (22 and 25 mm).

(1) Installation. The user wears the mask over the combat spectacles that are worn as regular eyeglasses.

(2) Procurement. Order the inserts from military optical laboratories through military eye clinics.

7. M17 Series

a. This mask has been phased out of most inventories. Since there may still be some individuals using this mask while waiting for final phaseout.

b. All three versions of the mask can use the nickel silver metal insert mounting device with temple rings that insert into the eye ring of the mask. The M17 can only use this insert mount. The front has a 44-mm eye size for the optical correction, a 74-mm frame size, and a spring-hinged bridge.

(1) Installation. Hold the insert temples by the plastic tabs, and swivel them in front of the frame front. Insert the lower section of one temple into the lower groove of the mask eye ring, just behind the mask lens. Continue around the entire temple until it springs into place. Repeat for the other side. Make final adjustments to align the inserts as needed.

(2) Procurement. Order the inserts from military optical laboratories through military eye clinics.

8. M17A1/A2

The M17A1/A2 series may use the universal insert. The universal insert has a plastic frame front (gray or white) with metal temple prongs. The front has a 38-mm eye size for the optical correction and 66-mm frame size.

a. Installation. Spread the metal prongs in a fishtail fashion to secure them in the mask. Bend the inserts at the bridge to induce a 5 to 10-degree, face form angle, and insert the prongs in the holes molded into the mask along the edges. Select the holes that center the lenses over the eye pupils.

b. Procurement. Order the inserts from military optical laboratories through military eye clinics.

9. Joint Service General-Purpose Mask

The JSGPM is currently in development at the US Army SBCCOM. The projected design will be a frame mount that is compatible with the PLC now used by the ballistic-laser protective system.

Appendix J

ELECTROMAGNETIC PULSE PROTECTION CONSIDERATIONS

1. Background

The EMP resulting from a nuclear weapon detonation can adversely affect unhardened electrical devices. When the detonation is well above the earth, EMP can cover the entire battlespace. The same detonation on or near the earth causes more intense, but more localized EMP. For these reasons, equipment supporting critical missions must, as a minimum, survive high altitude EMP effects. Such equipment survivability can be achieved by hardening the equipment or by using other mitigation techniques.

2. Electromagnetic Pulse

Electromagnetic pulse is a nuclear weapons effect that can have an adverse impact on electrical and electronic equipment. Although it represents roughly 1 percent of the total energy produced by a nuclear burst, EMP can destroy or cause serious damage to electronic equipment through electrical-current surges. Digital electronics can also suffer upset conditions that are also serious. Unfortunately, standard devices that protect equipment against lightning do not necessarily provide protection against EMP. Units must ensure that OPLANs include mitigation techniques to reduce EMP effects on operations.

3. Electromagnetic Pulse Mitigation Techniques

a. EMP mitigation procedures use hardened equipment and/or unhardened equipment. Correct maintenance and operational procedures help ensure that the hardness of built-in equipment remains intact. Improper maintenance can readily reduce or eliminate EMP hardening. Unhardened equipment relies on operator mitigation to reduce EMP coupling to levels below upset or damage.

(1) Exercise caution when adding components to already hardened equipment, such as placing new systems in a hardened van or mobile shelter.

(2) As a general rule, making an addition to stand-alone equipment that does not have wires or connectors running outside the protected enclosure does not interfere with the EMP hardening of the shelter. However, any addition of new connectors (such as running a telephone wire or extra air-conditioning or ventilation hoses into a shelter) that does not go through an approved surge arrestor and penetration shield or connector can adversely affect the hardness of the protected area. The addition of more sensitive electronics inside the protected enclosure can also affect hardness.

b. Many EMP hardening designs create shields between the electronic equipment and external EMP environments. Any cable or other penetration in a hardened system that

creates a hole or gap in the shield can degrade system survivability. Gaps, seals, and closures should be intact and fully engaged. Necessary maintenance or modifications made to systems should attempt to reseal and restore any breaks in the shielding.

c. When possible, EMP effects can be mitigated by having approved nonelectronic or alternative electronic procedures, backup systems, and backup copies of critical electronic data available for use. Multiple electronic systems of similar function can provide alternate or backup systems to supplement the functionality of potentially vulnerable high- and ultra-high frequency radios. Full restoration of EMP-damaged or disrupted computer information systems requires that replacement or repaired systems have operationally critical data from backups for immediate installation. Stored, backup CISOs can provide replacement hardware. Frequent backups of critical operational data in durable media formats further provide the data needed to resume any disrupted operations.

d. Other mitigation measures can include—

- Making maximum use of the least vulnerable equipment when possible.
- Providing redundant, multiple-mode communication links between positions.
- Preplanning and training to use backup and alternate communications networks. When possible, establish two or more communications paths and have a contingency plan to reestablish communications.
- Maintaining a stock of critical spare parts. In some cases, EMP damage may affect only one part of a system, which if replaced, will allow the device to function as before. Fuses are particularly important; therefore, personnel need to know the location of all fuses in their equipment and maintain and keep spares on hand. Critical spares and parts should be sealed in their original, electrostatic discharge (ESD) containers or bags until needed for use.
- Integrating EMP concerns into safety plans and drills. For example, personnel need to practice the skills needed to extinguish sudden, multiple, EMP-induced electrical fires inside shelters and enclosures and have appropriate life-support and fire-fighting equipment at hand.

e. Components, such as antennas and other metallic surfaces can be EMP-concentrating items. Potential antennas include such objects as gun tubes, heating and ventilation ducts, water pipes, fuel pipelines, conduits, grounding rods and wires, commercial phone and power lines, missiles, guy wires, fences, railroad tracks, and power lines from generators.

(1) When possible, personnel should disconnect and collapse collectors or antennas. Simply turning off the equipment is not sufficient; damaging energy can still enter through antennas.

(2) Where possible, personnel should avoid use of the most vulnerable antennas, which include long wires or rods, wide-angle doublets, and omnidirectional antennas. Less vulnerable antennas include those with smaller radiating elements.

(3) Additionally, personnel should avoid the creating loops in wire and other antennas or collectors. Loops act as magnetic dipole antennas, allowing EMP energy to affect the systems connected to them. Operators and supervisors should also recognize the different types of systems that might be linked in loops that are not immediately obvious. For example, a phone line may run from a van to a switchboard; the switchboard may be linked by wire to a CP, the CP may have a power line connection to a generator, and the same generator may have a power line to the van, thus resulting in an effective loop antenna or collector.

(4) Laying cables on the ground or shallow burial of cables for physical protection is recommended when practical for EMP mitigation purposes. Cables strung in the air can pick up more EMP energy than cables on the earth's surface. Only very deeply buried cables (10 feet or more) have significant EMP protection, but they are often not worth the construction effort.

f. Dispersed operations, to include the use of remotes, increase survivability by reducing a unit's single-point signatures and increasing the number of targets an enemy must find and engage.

g. Mitigation measures also include procedures for damage assessment, repair, and testing of equipment. In a unit that has been subjected to EMP effects, electronic equipment may be functionally damaged, operationally upset, or unaffected, depending on the shielding and effectiveness of EMP mitigation postures.

(1) Even though electronic equipment has suffered functional damage from EMP, repairs may include operator maintenance procedures such as resetting circuit breakers or replacing fuses.

(2) Mission-critical computers can also be affected by EMP at levels that are far lower than the intensities required to inflict functional damage. The effects may only be revealed when it becomes evident that critical information is incorrect or unavailable. An effective practice would be to assume that the computer memory has been upset and have the operators automatically reload backup files.

(3) Consistent with command priorities, all electronic equipment should be tested and inspected for operational upset and/or functional damage. This includes items that have been shielded or hardened against EMP effects. In some cases, upset or functional damage may not be immediately evident.

REFERENCES

Joint

JP 1-02, *Department of Defense Dictionary of Military and Associated Terms*, 12 April 2001.

JP 3-11, *Joint Doctrine for Operations in Nuclear, Biological, and Chemical (NBC) Environment*, 11 July 2000.

JP 4-06, *Joint Tactics, Techniques, and Procedures for Mortuary Affairs in Joint Operations*, 28 August, 1996.

Multiservice

FM 3-5/MCWP 3-37.3, *NBC Decontamination*, 28 July 2000 (with Change 1, 31 January 2002).

FM 3-11.21/MCRP 3-27.2C/NTTP 3-11.24/AFTTP(I) 3-2.37, *Multiservice Tactics, Techniques, and Procedures for Nuclear, Biological, and Chemical Aspects of Consequence Management*, 12 December 2001.

FM 3-11.34/MCWP 3-37.5/NTTP 3-11.23/AFTTP (I) 3-2.33, *Multiservice Tactics, Techniques, and Procedures for NBC Defense of Theater Fixed Sites, Ports, and Airfields*, 29 September 2000.

FM 8-284/NAVMED P-5042/AFMAN(I) 44-156/MCRP 4-11.1C, *Treatment of Biological Warfare Casualties*, 17 July 2000.

FM 8-285/NAVMED P-5041/AFJMAN 44-149/FMFM 11-11, *Treatment of Chemical Agent Casualties and Conventional Military Chemical Injuries*, 22 December 1995.

AR 40-63/NAVMEDCOMINST 6810.1/AFR 167-3, *Ophthalmic Services*, 1 January 1986.

Army

FM 21-10, *Field Hygiene and Sanitation*, 21 June 2000.

FM 4-02.7, *Health Service Support in a Nuclear, Biological, and Chemical Environment*, 1 October 2002.

FM 8-500, *Hazardous Materials Injuries: A Handbook for Prehospital Care*, January 1997.

Navy

NWP 3-20.31 (Revision A), *Surface Ship Survivability*, January 2000.

Other Sources

Joint Chiefs of Staff Memorandum, MCM-0026-02, Subject: *Chemical Warfare (CW) Agent Exposure Planning Guidance*, April 29, 2002

Military Standard Requisitioning and Issue Procedures (MILSTRIP) Desk Guide/NAV Sup 409, 9 June 1998.

STANAG 4192, *Design Criteria and Construction Parameters for Collective Protection (COLPRO) Facilities on Land*, 25 October 1993.

The National Institute for Occupational Safety and Health *Pocket Guide to Chemical Hazards*.

US Department of Transportation, *Emergency Response Guidebook*.

29 Code of Federal Regulations 1910.120.

GLOSSARY

PART I—ABBREVIATIONS AND ACRONYMS

A

AB	air base
ABM	antiballistic missile
AC	hydrogen cyanide, a blood agent
ACAA	automatic chemical agent alarm
ACADA	automatic chemical agent detection alarm
AERP	aircrew eye & respiratory protection
AFB	Air Force base
AFJMAN	Air Force joint manual
AFMAN (I)	Air Force manual (interservice)
AFR	Air Force regulation
AFRRI	Armed Force Radiobiology Research Institute
AFTTP (I)	Air Force tactics, techniques, and procedures (interservice)
AICPS	Advanced Integrated Collective Protective System
ALARA	As low as reasonably achievable
AO	area of operation
AOI	area of interest
APC	armored personnel carrier
APR	air-purifying respirator
APOD	aerial port of debarkation
AR	Army regulation
ASZM-TEDA	activated, impregnated copper-silver-zinc-molybdenum-triethylenediamine
ATNAA	antidote treatment nerve agent autoinjector system
ATTN	attention

B

BDO	battle dress overgarment
BDU	battle dress uniform
BIDS	Biological Integrated Detection System
BOI	basis of issue plan
Bq	becquerel
BMU	beach master unit
BSA	brigade support area
BVO	black vinyl overboot
BW	biological warfare

C

C	Celsius
C²	command and control
CA	civil affairs
CAM	chemical agent monitor
CANA	convulsant antidote for nerve agent
CAPDS	Chemical Agent Point Detection System
CAPE	contamination avoidance protective entrance
CB	chemical and biological
CBR	chemical, biological, and radiological
CBRN	chemical, biological, radiological, and nuclear
CBPS	chemical biological protective shelter
CBRN	chemical, biological, radiological, and nuclear
CCA	contamination control area
CCD	camouflage, concealment and deception
CCM	compartment control module
cfm	cubic feet per minute
CFR	Code of Federal Regulation
CG	phosgene, (a choking agent)
cGy	centigray
cGyph	centigray per hour
CHAMP	chemically-biologically-hardened air management plant
C³I	command, control, communication, and intelligence
CK	cyanogen chloride (a blood agent)
CLS	contracted logistics support
cm	centimeter(s)
CMWD	countermeasures washdown
COA	course of action
COLPRO	collective protection
COMM	commercial
COMSEC	communications security
CONUS	continental United States
CP	chemical protective
CPDEPMEDS	chemically protective deployable medical system
CPE	collective protective equipment
CPFC	chemical protective footwear cover
CPO	chemical protective overgarment
CPS	collective protective shelter
CPU	chemical protective undergarment
CSH	combat support hospital
CW	chemical warfare
CZAA	cold-zone assembly area

D

DAP	decontaminating apparatus, portable
DC	District of Columbia
DCO	damage control officer
DEA	Drug Enforcement Agency
DKIE	decontamination kit, individual equipment
DOD	Department of Defense
DOE	Department of Energy
DOS	Department of State
dpm	disintegrations per minute
DSN	defense switched network
Dtb	turnback dose
DTD	detailed troop decontamination
DTRA	Defense Threat Reduction Agency
DU	depleted uranium

E

ECC	evacuation control center
ECWCS	extreme cold-weather clothing system
e.g.	exempli gratia (for example)
email	electronic mail
EMP	electromagnetic pulse
EOD	explosive ordnance disposal
EPA	Environmental Protection Agency
ERG	Emergency Response Guide
ESD	electrostatic discharge
etc.	et cetera (and so forth)
EW	electronic warfare
ext.	extension

F

F	Fahrenheit
FBI	Federal Bureau of Investigation
FDECU	Field-deployable, environmental control unit
FED LOG	Federal Logistics
FFA	fan filter assembly
FL	Florida
FM	field manual
FMMF	Fleet Marine force manual
FP	force protection
FRAGORD	fragmentary order

G

gal	gallon
GB	sarin (a nerve agent)
GPFU	gas-particulate filter unit
gpm	gallons per minute
GVO	green vinyl overboot
GZ	ground zero

H

HAZMAT	hazardous materials
HE	high explosive
HEPA	high-efficiency, particulate air
HF	high frequency
HHA	hand-held assay
HMMWV	high-mobility multipurpose wheeled vehicle
HN	host nation
hr	hour(s)
HQ	headquarters
HSS	health service support
HTH	high test hypochlorite
HUMINT	human intelligence
HVAC	heating, ventilation, and air conditioning

I

IBADS	Interim Biological Agent Detection System
ICAM	improved chemical-agent monitor
ID	identification
IED	improvised explosive device
IFV	infantry fighting vehicle
IND	investigational new drug
int	internal
IO	information operations
IPB	intelligence preparation of the battlespace
IPDS	Improved Point Detection System
IPE	individual protective equipment
iwg	inches water gage

J

J5	Plans and Policy Directorate
JCAD	joint chemical-agent detector
J-FIRE	joint firefighter integrated response ensemble
JP	joint publication
JPACE	joint protective aircrew ensemble
JSGPM	joint service, general purpose mask
JSLIST	joint service lightweight integrated suit technology
JTF	joint task force

K

kg	kilogram(s)
km	kilometer(s)

L

L	large
LBE	load-bearing equipment
LCE	load-carrying equipment
LHA	liquid hazard area
LLR	low-level radiation
LNG	long
LOS	line of sight
LOTS	logistics over-the-shore

M

M	medium
MANSCEN	Maneuver Support Center
MBT	main battle tank
MCC	microclimate cooling
MCCDC	Marine Corps Combat Development Command
MCPE	modular collective protective equipment
MCRP	Marine Corps reference publication
MCWP	Marine Corps warfighting publication
MD	Maryland
MDMP	military decision-making process
METT-T	mission, enemy, terrain and weather, troops and support available-time available
MILSTRIP	military standard requisitioning and issue procedures
min	minute
MK	mark
MLRS	Multiple Launch Rocket System

mm	millimeter
MO	Missouri
MOOTW	military operations other than war
MOPP	mission-oriented protective posture
mph	miles per hour
mrad	millirads
MSD	minimum safe distance
MSDS	materiel safety data sheet
mSv	millisievert
MTF	medical treatment facility
MTP	mission training plan
MTTP	multiservice tactics, techniques, and procedures
MULO	Multipurpose, lightweight overboot

N

N/A	not applicable
NAAK	nerve agent antidote kit
NAERG	North American Emergency Response Guidebook
NAPP	nerve agent pyridostigmine pretreatment
NATO	North Atlantic Treaty Organization
NAVMED	Navy medical
NAVMEDCOMINST	Navy medical command instruction
NBC	nuclear, biological, and chemical
NBCC	nuclear, biological, and chemical center
NBCCC	nuclear, biological, and chemical control center
NBCWRS	Nuclear, Biological, And Chemical Warning and Reporting System
NCE	noncombatant evacuees
NCO	noncommissioned officer
NDI	nondevelopmental item
NEO	noncombatant evacuation operation
NFPA	National Fire Protection Agency
NG	National Guard
NIOSH	National Institute for Occupational Safety and Health
NSN	national stock numbers
NTTP	Navy tactics, techniques, and procedures
NVD	night vision device
NWDC	Navy Warfare Development Command
NWP	Naval warfare publication

O

OD	olive drab
OEG	operational exposure guide
OOD	officer of the deck
OP	observation post
OPLAN	operational plan

OPORD	operation order
OPR	office of primary responsibility
OPSEC	operations security
OPTEMPO	operating tempo
OSHA	Occupational Safety and Health Administration

P

pam	phosphotriesterase, pralidoxime
PASGT	personnel armor system ground troop
PATS	protection assessment test system
pCi	picocuries
PCN	publication control number
PE	protective entrance
PF	protection factor
P³I	preplanned product improvement
PIR	priority intelligence requirements
PLC	prescription lens carrier
PMCS	preventive-maintenance checks and services
POL	petroleum, oils, and lubricants
PPE	personal protective equipment
psi	per square inch
PSYOP	psychological operations
PT	physical training
pub	publication
PVNTMED	preventive medicine

Q

qt	quart(s)
-----------	----------

R

R	rad
RA	risk analysis
RADIAC	radiation detection, identification, and computation
RC	relocation center
RCA	riot control agent
RDD	radiological dispersal device
REG	regular
RES	radiation exposure status
RI	Rhode Island
Rtb	turnback dose rate

S

S	small
SA	situational awareness
SAR	supplied-air respirator
SB	supply bulletin
SBCCOM	Soldier and Biological Chemical Command
SCALP	suit, contamination avoidance, liquid protective
SCBA	self-contained breathing apparatus
SCM	system control module
SCPE	simplified collective protective equipment
SDK	skin decontamination kit
SDS	Sorbent Decontamination System
SERPACWA	skin exposure reduction paste against chemical warfare agents
SHF	Super-high frequency
SHT	short
SICPS	Standardized Integrated Command Post System
SITREP	situation report
SME	subject matter expert
SMT	shelter management team
SOF	special operations forces
SOP	standing operating procedure
SPOD	seaport of debarkation
SSN	social security number
S/RTF	search and recovery task force
STB	super tropical bleach
STEPO	self-contained, toxic-environment protective outfit

T

TA	target acquisition
TAP	toxicological agent, protective
TB	technical bulletin
TBM	theater ballistic missile
TCN	third country national
TEMPER	tent, extendable, modular, personnel
TFA	toxic free area
TIB	toxic industrial biological
TIC	toxic industrial chemical
TIM	toxic industrial material
TIR	toxic industrial radiological
TM	technical manual
TMD	theater missile defense
TO	technical order
TRADOC	United States Army Training and Doctrine Command
TSP	training support package
TTP	tactics, techniques, and procedures
TX	Texas

U

UHF	ultra-high frequency
US	United States
USA	United States Army
USAF	United States Air Force
USAMRICD	United States Army Medical Research Institute of Chemical Defense
USAMRIID	United States Army Medical Research Institute of Infectious Diseases
USCG	United States Coast Guard
USMC	United States Marine Corps
USN	United States Navy
UXO	unexploded ordnance

V

VA	vulnerability assessment; Virginia
VB	vapor barrier
VCA	voice communication adapter
VHA	vapor hazard area

W

WBG	wet-bulb, globe temperature
WMD	weapons of mass destruction

X

XL	extra large
XS	extra small
XSHT	extra short
XXL	extra, extra large
XXS	extra, extra small
XXXS	extra, extra, extra small

PART II – TERMS AND DEFINITIONS

Aerosol. A liquid or solid composed of finely divided particles suspended in a gaseous medium. Examples of common aerosols are mist, fog, and smoke. (JP 1-02)

Avoidance. Individual and/or unit measures taken to avoid or minimize nuclear, biological, and chemical (NBC) attacks and reduce the effects of NBC hazards. (JP 1-02)

Biological agent. A microorganism that causes disease in personnel, plants, or animals or causes the deterioration of materiel. (JP 1-02)

Biological defense. The methods, plans, and procedures involved in establishing and executing defensive measures against attacks using biological agents. (JP 1-02)

Biological threat. A threat that consists of biological material planned to be deployed to produce casualties in personnel or animals or damage plants. (JP 1-02)

Biological weapon. An item of materiel which projects, disperses, or disseminates a biological agent including arthropod vectors. (JP 1-02)

Blister agent. A chemical agent which injures the eyes and lungs, and burns or blisters the skin. Also called vesicant agent. (JP 1-02)

Blood agent. A chemical compound, including the cyanide group, that affects bodily function by preventing the normal utilization of oxygen by body tissues. (JP 1-02)

Chemical agent. Any toxic chemical intended for use in military operations. (JP 1-02)

Chemical ammunition. A type of ammunition, the filler of which is primarily a chemical agent. (JP 1-02)

Chemical defense. The methods, plans, and procedures involved in establishing and executing defensive measures against attack utilizing chemical agents. (JP 1-02)

Chemical dose. The amount of chemical agent, expressed in milligrams, that is taken or absorbed by the body. (JP 1-02)

Chemical environment. Conditions found in an area resulting from direct or persisting effects of chemical weapons. (JP 1-02)

Collective nuclear, biological, and chemical protection. Protection provided to a group of individuals in a nuclear, biological, and chemical environment which permits relaxation of individual nuclear, biological, and chemical protection. (JP 1-02)

Combatant command. A unified or specified command with a broad continuing mission under a single commander established and so designated by the President, through the Secretary of Defense and with the advice and assistance of the Chairman of the Joint Chiefs of Staff. Combatant commands typically have geographic or functional responsibilities. (JP 1-02)

Contamination. 1. The deposit, absorption, or adsorption of radioactive material, or of biological or chemical agents on or by structures, areas, personnel, or objects. 2. Food and/or water made unfit for consumption by humans or animals because of the presence of environmental chemicals, radioactive elements, bacteria or organisms, the byproduct of the growth of bacteria or organisms, the decomposing material (to include food substance itself), or waste in the food or water. (JP 1-02)

Contamination control. Procedures to avoid, reduce, remove, or render harmless (temporarily or permanently) nuclear, biological, and chemical contamination for the purpose of maintaining or enhancing the efficient conduct of military operations. (JP 1-02)

Decontamination. The process of making any person, object, or area safe by absorbing, destroying, neutralizing, making harmless, or removing chemical or biological agents, or by removing radioactive material clinging to or around it. (JP 1-02)

Detection. 1. In tactical operations, the perception of an object of possible military interest but unconfirmed by recognition. 2. In surveillance, the determination and transmission by a surveillance system that has occurred. 3. In arms control, the first step in the process of ascertaining the occurrence of a violation of an arms control agreement. 4. In nuclear, biological, and chemical (NBC) environments, the act of locating NBC hazards by use of NBC detectors or monitoring and/or survey teams. (JP 1-02)

Host nation. A nation that receives the forces and/or supplies of allied nations, coalition partners, and/or NATO organizations to be located on, to operate in, or to transit through its territory. Also called HN. (JP 1-02)

Identification. 1. The process of determining the friendly or hostile character of an unknown detected contact. 2. In arms control, the process of determining which nation is responsible for the detected violations of any arms control measure. 3. In ground combat operations, discrimination between recognizable objects as being friendly or enemy, or the name that belongs to the object as a member of a class. Also called ID. (JP 1-02)

Individual protection. Actions taken by individuals to survive and continue the mission under nuclear, biological, and chemical conditions. (JP 1-02)

Individual protective equipment. In nuclear, biological, and chemical warfare, the personal clothing and equipment required to protect an individual from biological and chemical hazards and some nuclear effects. (JP 1-02)

Mission-oriented protective posture. A flexible system of protection against nuclear, biological, and chemical contamination. This posture requires personnel to wear only that protective clothing and equipment (mission-oriented protective posture gear) appropriate to the threat level, work rate imposed by the mission, temperature, and humidity. Also called MOPP. (JP 1-02)

Mission-oriented protective posture gear. Military term for individual protective equipment including suit, boots, gloves, mask with hood, first aid treatments, and decontamination kits issued to soldiers. Also called MOPP gear. (JP 1-02)

Nerve agent. A potentially lethal chemical agent which interferes with the transmission of nerve impulses. (JP 1-02)

Nonpersistent agent. A chemical agent that when released dissipates and/or loses its ability to cause casualties after 10 to 15 minutes. (JP 1-02)

Nuclear, biological, and chemical-capable nation. A nation that has the capability to produce and employ one or more types of nuclear, biological, and chemical weapons across the full range of military operations and at any level of war in order to achieve political and military objectives. (JP 1-02)

Nuclear, biological, and chemical defense. Defensive measures that enable friendly forces to survive, fight, and win against enemy use of nuclear, biological, or chemical (NBC) weapons and agents. US forces apply NBC defensive measures before and during integrated warfare. In integrated warfare, opposing forces employ nonconventional weapons along with conventional weapons (NBC weapons are nonconventional). (JP 1-02)

Nuclear, biological, and chemical environment. Environments in which there is deliberate or accidental employment, or threat of employment, of nuclear, biological, or chemical weapons; deliberate or accidental attacks or contamination with toxic industrial materials, including toxic industrial chemicals; or deliberate or accidental attacks or contamination with radiological (radioactive) materials. (JP 1-02)

Nuclear defense. The methods, plans, and procedures involved in establishing and exercising defensive measures against the effects of an attack by nuclear weapons or radiological warfare agents. It encompasses both the training for, and the implementation of, these methods, plans, and procedures. (JP 1-02)

Persistency. In biological or chemical warfare, the characteristic of an agent which pertains to the duration of its effectiveness under determined conditions after its dispersal. (JP 1-02)

Protection. 1. Measures that are taken to keep nuclear, biological, and chemical hazards from having an adverse effect on personnel, equipment, or critical assets and facilities. Protection consists of five groups of activities: hardening of positions; protecting personnel; assuming mission-oriented protective posture; using physical defense measures; and reacting to attack. 2. In space usage, active and passive defense measures to ensure that United States and friendly space systems perform as designed by seeking to overcome an adversary's attempts to negate them and to minimize damage if negotiation is attempted. (JP 1-02)

Protective mask. A protective ensemble designed to protect the wearer's face and eyes and prevent the breathing of air contaminated with chemical and/or biological agents. (JP 1-02)

Residual contamination. Contamination which remains after steps have been taken to remove it. These steps may consist of nothing more than allowing the contamination to decay normally. (JP 1-02)

Survey. The directed effort to determine the location and the nature of a chemical, biological and radiological hazard in an area. (JP 1-02)

Toxic chemical. Any chemical which, through its chemical action on life processes, can cause death, temporary incapacitation, or permanent harm to humans or animals. This includes all such chemicals, regardless of their origin or of their method of production, and regardless of whether they are produced in facilities, in munitions or elsewhere. (JP 1-02)

Toxic industrial biological. Biological material found in medical research or pharmaceutical manufacturing that are toxic to humans and animals or damages plants. (FM 4-02.7)

Toxic industrial chemical. Chemical materials or compounds that are used for multiple purposes such as fuels or solvents, or in manufacturing that are toxic to humans and animals or damages plants. (FM 4-02.7)

Toxic industrial material. Toxic industrial biological, toxic industrial chemical, and toxic industrial radiological materials. (FM 4-02.7)

Toxic industrial radiological. Radiation materials used in research, power generation, and medical treatment that are harmful to humans and animals if released outside their controlled environments. (FM 4-02.7)

Weapons of mass destruction. Weapons that are capable of a high order of destruction and/or of being used in such a manner as to destroy large numbers of people. Weapons of mass destruction can be high explosives or nuclear, biological, chemical, and radiological weapons, but exclude the means of transporting or propelling the weapon where such means is a separable and divisible part of the weapon. Also called WMD. (JP 1-02)

Index

A

Aerosol II-2, II-15, II-17, II-18, III-9, III-10, VI-1, VII-16, A-12, E-2, E-4, H-4

Aircrew mask VI-4, A-6

Antidote kit III-5, A-12

Avoidance I-10, II-20, VI-2, VII-1, B-31, B-35, F-5

B

Battle dress overgarment VI-1, VI-2, VI-6, A-1, A-2, A-3, B-6, B-8, B-21, B-22, B-23

Biological agent II-2, II-15, II-16, II-17, II-18, III-2, III-7, III-8, III-9, III-10, VI-2, A-17, A-18, H-3

Biological defense III-3

Biological protection II-15

Biological weapons I-11, I-12, II-14

Blister agent II-19, II-22, III-3, III-6, III-10, A-12, A-15

Blood agent II-24, II-25, A-12, E-2

C

Chemical agent I-3, II-3, II-4, II-18, II-19, II-20, II-21, II-22, II-24, III-3, III-5, III-6, III-7, III-8, III-10, IV-9, IV-10, VI-2, VII-2, VII-3, VII-16, VII-18, A-2, A-3, A-4, A-10, A-11, A-12, A-14, A-15, A-17, B-3, B-10, B-16, B-34, C-4, D-11, G-11

Chemical-agent monitor III-6, IV-10, VII-12, A-14, B-7, B-10, B-13, B-27, B-28, B-29

Chemical defense II-19, II-20, III-3, H-5

Chemical gloves III-4, IV-7, IV-8, IV-9, IV-11, VI-1, VI-2, VI-3, VII-15, A-2, B-16, B-26, C-4, G-2, G-3

Cold weather III-1, III-2, III-3, III-4, III-5, III-6

Collective protection operations II-25

Combatant command I-8

Contamination I-2, I-3, I-11, I-12, I-13, II-3, II-6, II-14, II-17, II-19, II-20, II-21, II-22, II-26, II-27, II-30, II-31, III-1, III-2, III-3, III-5, III-6, III-7, III-9, III-10, IV-11, V-1, V-2, V-3, VI-6, VII-1, VII-2, VII-3, VII-6, VII-7, VII-9, VII-10, VII-11, VII-14, VII-15, VII-16, VII-17, VII-18, A-2, A-3, A-4, A-5, A-10, A-11, A-14, A-15, A-16, B-2, B-3, B-4, B-5, B-7, B-8, B-11, B-13, B-14, B-15, B-17, B-19, B-30, B-31, B-33, B-35, C-3, C-4, D-3, D-6, D-8, D-9, D-10, D-12, D-13, F-3, F-4, F-5, F-6, F-7, G-2, G-7, G-8, G-11, H-3, H-4

Contamination control III-19, VII-7, VII-8, B-18, B-19, B-31, D-3, D-6, D-8, D-13, F-5

Countermeasures I-6, II-7, II-27, II-29, IV-9, V-2, V-6, V-7, VII-17, C-1, C-4, C-5

D

Decontamination I-1, I-5, I-13, II-1, II-4, II-14, II-18, II-21, II-26, II-27, II-28, II-30, III-2, III-5, III-6, IV-3, IV-4, IV-5, IV-6, VI-3, VI-4, VI-6, VII-2, VII-3, VII-4, VII-7, VII-17, VII-18, A-1, A-2, A-3, A-4, A-10, A-11, A-14, B-3, B-6, B-7, B-9, B-12, B-16, B-18, B-19, B-29, B-30, D-6, D-8, D-9, D-13, F-3, F-5, F-6, G-11, H-4

Decontamination equipment II-29, A-10, B-6

Depleted uranium D-1, D-7, D-12, D-13

Desert III-1, III-7, IV-2, C-6

Detection I-5, I-8, I-12, II-2, II-4, II-6, II-18, II-20, II-21, II-22, II-27, II-29, III-6, III-10, IV-5, V-4, VII-4, A-1, A-14, A-15, A-16, A-17, B-2, B-7, B-9, B-12, B-14, B-30, E-1

E

Entry and exit II-16, II-27, III-6, VII-11, VII-14, VII-15, VII-17, B-1, B-6, B-7, B-13, B-14, B-15, B-34

F

First aid equipment A-12, A-13, B-31, B-32

Fighting positions II-7, II-8, II-9, II-10, II-14, III-1, III-7, III-9

Fixed site collective protection VII-1, VII-4, VII-5, VII-8, B-32

H

Hand held assay II-19, A-17

Helmet covers G-2

Hybrid systems VII-12, VII-4, VII-15, VII-17

I

Individual protection I-11, I-12, I-13, II-1, VI-1, VI-4, VI-5, VII-1, VII-7, VII-16

Individual protective equipment I-3, I-5, I-12, II-1, II-14, II-15, II-20, II-21, II-27, III-3, IV-2, IV-4, IV-5, IV-9, V-1, V-5, V-6, VI-1, VI-4, VI-5, A-1, A-2, A-13, B-6, B-11, B-13, B-14, B-29, B-30, B-31, B-32

Industrial chemicals VI-3, E-1, E-2, E-3

J

Joint firefighters integrated response ensemble A-5

Jungle III-1, III-8

L

Littoral environment III-1, III-10

Low-level radiation D-1, D-3, D-5, D-6, D-7, D-8, D-9, D-10

M

Mission-oriented protective posture I-8, I-10, I-12, I-13, II-1, II-4, II-17, II-20, II-25, III-6, IV-1, IV-9, IV-10, IV-11, V-1, V-7, VI-1, A-13, C-1, C-3, C-5, C-6

MOPP gear I-4, I-13, II-1, II-16, II-25, III-6, III-7, III-8, IV-3, IV-4, IV-5, IV-11, IV-12, VI-4, VII-1, VII-3, VII-11, VII-12, VII-15, VII-16, VII-17, B-4, B-5, B-6, B-8, B-12, B-14, B-15, B-16, B-34, C-1, C-3, C-4, C-5, C-6, D-11

Mobile collective protection VII-1, VII-4, VII-12, VII-16

MOPP analysis I-12, II-1, III-3, IV-1, IV-2, IV-3, IV-4, V-1

MOPP guidance I-10, IV-3

MOPP levels I-4, I-6, I-8, I-11, I-12, II-1, II-5, II-6, II-17, II-20, II-21, II-25, II-26, II-30, IV-1, IV-3, IV-4, IV-5, IV-6, IV-7, IV-8, IV-9, IV-10, IV-11, V-2, V-4, V-5, V-6, V-7, V-8, VI-1, VI-2, VII-1, VII-3, VII-12, VII-15, VII-16, A-10, B-4, B-8, B-17, B-33, C-1

Mountain II-7, III-1, III-8, III-9, IV-2

N

NBC shelters VII-6, E-1, E-2, E-6, I-1, I-2

Navy collective protection VII-1, VII-17

Nerve agent II-19, II-22, III-3, III-10, IV-6, IV-9, A-12, A-13, A-14, A-15, C-4, E-1, E-2

Noncombatant I-5, III-9, A-8, F-1, F-2, F-4, F-5, F-6

Nonpersistent agent III-7, III-8, IV-9

NBC defense I-4, I-5, I-6, II-1, II-2, II-28, III-7, III-8, III-9, III-10, VII-1, VII-5, A-3, A-14, E-1, G-1, G-2

NBC environment I-4, I-6, I-7, I-8, I-13, II-17, III-1, III-9, IV-1, V-1, V-2, V-3, V-4, V-5, V-6, V-7, VII-1, A-6, A-13, B-3, B-15, B-31, F-2

NBC preparedness I-1, I-8

Nuclear defense III-1, III-7

Nuclear protection II-7, II-12

O

Operational exposure D-1, D-2, D-4, D-8

Overshoes A-4, G-5

P

Persistency II-28, III-10

Physiological factors C-1, D-11

Physiological and psychological impacts V-1

Psychological factors V-1, C-1, C-4, D-10, D-11

Portable decontamination A-11

Preattack actions II-7, II-16, II-20, II-25, II-27, II-28, B-30, F-5, F-6

Pretreatment I-3, I-13, A-13

Protecting the force II-7, VI-1, D-1

Protection I-1, I-3, I-4, I-4, I-5, I-6, I-7, I-11, I-12, I-13, I-14, I-15, I-16, I-17, I-18, I-19, II-24, II-25, II-26, II-27, II-28, II-29, II-31, III-1, III-2, III-3, III-4, III-6, III-7, III-8, III-9, IV-1, IV-3, IV-4, IV-5, IV-8, IV-9, IV-10, V-4, VI-1, VI-2, VI-3, VI-4, VI-5, VI-6, VII-1, VII-5, VII-7, VII-8, VII-9, VII-10, B-1, B-2, B-3, B-32, B-33, B-35, C-4, D-1, D-5, D-8, D-10, D-12, E-1, E-2, E-3, E-4, F-2, F-3, F-4, G-12, H-4, I-1, I-3

Protective clothing II-19, II-20, III-4, VI-1, VI-2, VI-5, VI-6, VII-1, VII-2, VII-10, A-1, B-15, B-16, B-19, C-1, C-4, D-6, E-1, G-2

Protective masks I-5, I-7, III-3, III-4, III-5, IV-4, IV-5, IV-6, IV-7, IV-9, VI-3, VI-4, VI-5, VII-15, A-5, A-6, A-7, A-8, A-9, A-10, B-6, B-8, B-12, B-19, B-32, C-4, C-5, E-1, F-4, G-9, G-10, I-1

Protective undergarments VII-1, A-1

R

Residual contamination III-10

S

Self-contained, toxic-environment protective outfit VI-3, A-3

Shielding values II-9, D-7, D-12, I-1, I-3

Skin decontamination A-2, A-10, A-11, B-6, B-9

T

Toxic industrial materials (TIM) I-1, I-2, I-3, I-5, I-10, I-11, I-12, I-13, II-1, II-7, II-27, II-28, II-29, II-31, III-9, A-1, A08, E-1

Toxic chemical I-11, II-29, III-5, E-1, E-2, E-3

Transportable collective protection VII-1, VII-4, VII-11

U

Urban III-1, III-9, III-10

V

Vector II-15, II-17, III-2, III-8, A-4

Ventilated Facepiece II-25, VII-12, VII-14, VII-15, VII-16

W

Wartime shelters B-29

Water consumption tables C-1, C-5

Weapons of mass destruction H-1

Work/rest tables C-1, C-6

FM 3-11.4 (FM 3-4)
MCWP 3-37.2
NTTP 3-11.27
AFTTP (I) 3-2.46
2 JUNE 2003

By Order of the Secretary of the Army:

Official:

ERIC K. SHINSEKI
General, United States Army
Chief of Staff

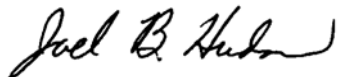

JOEL B. HUDSON
Administration Assistant to the
Secretary of the Army
0317802

DISTRIBUTION:

Active Army, Army National Guard, and US Army Reserve: To be distributed in accordance with the initial distribution number 110736, requirements for FM 3-11.4

By Order of the Secretary of the Air Force

DAVID F. MACGHEE, JR.
Major General, USAF
Commander
Headquarters Air Force Doctrine Center

Air Force Distribution: F

Marine Corps PCN: 143 000130 00

PIN: 080891-000