

LESSON ONE: THE TARGET

No study of the methods can be carried out without first considering the target at which the techniques are directed: the human body.

In the assault on the body the aims are to: 1 - Stop the breathing, 2 - Start the bleeding, 3 - Promote established shock.

These aims are what all weapons are designed to fulfill. There is no point in riddling a man with bullets if not one of them hits a vital spot. Similarly, it is a truism that a man can be tortured to death by a thousand cuts with not one being fatal in itself. There then must, ideally, be one blow, one slash, one bullet that causes death.

First we must consider the medium that gives all life — oxygen. Cut off oxygen, cut off life. There are several parts of the body that control our intake of oxygen in the form of air. Primarily there are the motor nerves of the brain that are the stimulus for the act of breathing. This is located in the back of the head, just above the spine. This can be crushed with a club or torn with a bullet. A blow with the hand must be very forceful indeed but a good booted kick would be adequate to cause the damage necessary. Working downwards we come to the neck. Blows to the back of the neck apart from damaging the spine, can force the vertebrae forward and impinge on the windpipe and cause asphyxiation. The wind pipe can be slashed and the blood will fill the lungs. Usually, however, this method of death is the result of severe blood loss, but the net result is oxygen starvation. Naturally, choking causes death and it must be divorced from strangulation at this point.

Choking is the cutting off of air to the lungs as the result of a constriction or crushed windpipe.

Strangulation is the depriving of oxygenated blood going to the brain by stemming the flow at the carotid arteries. This is death by anoxia.

The lungs and breathing system can be assailed by gases. Smothering, too, can be accomplished by assassination methods.

Attacking the lungs themselves is not a very quick death as in the case of a bullet or knife puncture for this deflates the lung. The lung on the opposite side can carry on alone —if need be. This must be kept in mind and steps should be taken to insure the failure of both lungs.

The second vital function that serves as a target is the system that carries oxygen — the blood.

Kill

The severing of a major blood vessel is one of the best ways of causing death. This can be accomplished with blade, bullets and in some cases with bludgeons. (The blows are directed at the ribs and breastbone to split or splinter them and to drive them into the heart. Severe palm heel strikes have been known to do this also. Driving the fist into the floating ribs can force them into the liver, but death will not immediately ensue.)

The seat of power in this system is the heart. The heart can be destroyed by bullets, daggers, or even with a sharp ice-pick or knitting needle.

Any wound to the heart would be desirable. However, there are also large veins and arteries just above it. Locations to cut are obvious, namely: the neck, wrists, inside of the elbows, under the armpits, inside the thighs and the kidneys. The blood can be attacked with poisons and gases also.

The third and final consideration is shock. This involves the third major system of the body — the nervous system. Shock can be brought on by any of the previous conditions and is a primary cause of death.

Attacks on this system involve electrocution, spinal damage, brain destruction, traumatic burns, and gross damage to the vital organs.

The easiest way to bring on shock is by severing a major artery. It is clear that all the vital targets are interrelated and the destruction of one is the destruction of all. Even so it is imperative to attempt to destroy at least two of these targets and if possible all three when you kill the subject.

To Review: The aims are a/ stop the breath, b/ start the bleeding, c/ promote shock.

The Targets: (i) the brain
(ii) the heart
(iii) the spine

THE TARGETS

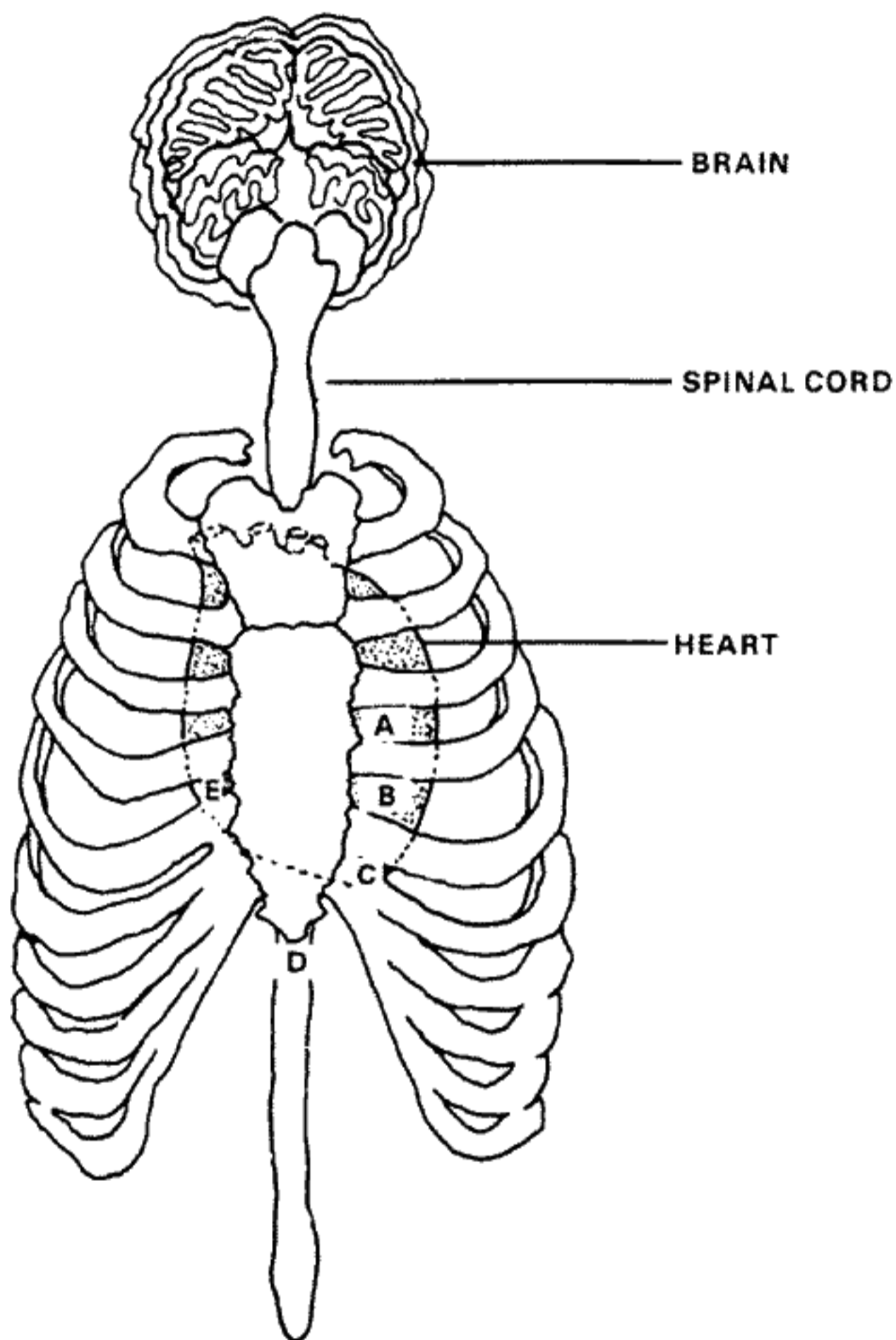

A B C D Are all places to attack with the knife, or needle-pick. E is an alternate

BLANK

PAGE

LESSON TWO: TO KILL UNARMED

Let us now consider the instruments that cause individual destruction. . . .

Evolution of weapon design lends itself readily to the present discussion. The first weapon used by one man to kill another was himself; his own fists, feet and teeth were the natural weapons that he used.

The grappling, throwing and in-fighting techniques are only peripheral to this study, and as there are many fine books and courses on this subject they will not be delved into here.

In using one's bare hands to kill it is necessary to constantly bear in mind the vulnerable points of the body that allow access to the targets and to inflict the maximum possible damage to them.

Killing must, therefore, be the end product and the whole purpose of the assassin's function. In the case of bare-handed killing the action centres around the head and throat. Forceful, well-aimed blows are to be directed against the windpipe and the voice-box at the front of the neck. The intention is to achieve complete collapse and flattening of the windpipe. Once squashed the mucous in the throat effectively seals it and air can flow neither in nor out. This can be accomplished by using the fist but more commonly an edge of hand, or karate shuto is employed. Also if the subject has been downed, the foot can be stomped onto the voice-box with the same result.

The skin in the hollow of the neck is very thin and can be pierced much like one would a plastic bag with the fingers and nails and should be ripped open to allow access to the windpipe directly. The blood vessels in the neck such as the carotid arteries and the jugular veins can be severely damaged with edge of hand blows and the underlying nerves suffer also. They can be attacked even more directly with the teeth. These vessels are just under the skin and run along both sides of the windpipe and can be easily bitten into. The object is not to cut off blood but to tear these vessels out. The front teeth, or incisors, are used. They should sink into the skin and vessels and then the head is pulled away with a violent jerk, leaving a wound that will cause death in short order.

The throat can be constricted by the hands as in throttling and by the forearm in a rear strangle, or by the legs in a scissor grip. All require maximum strength to be applied to ensure death. The subject should be under control in five seconds and unconscious within another fifteen to twenty. The grip should be maintained for three minutes — until after the body has

THE DIFFERENCES BETWEEN STRANGLES AND CHOKES:

Affects the windpipe

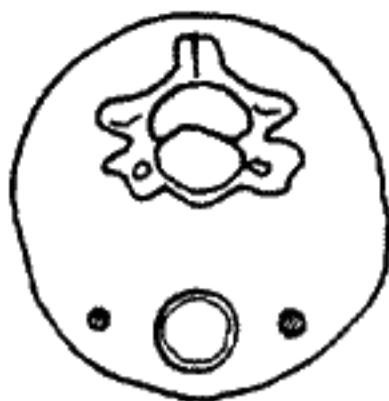

Crushed windpipe
ex: Stick strangle or
edge of hand blow.

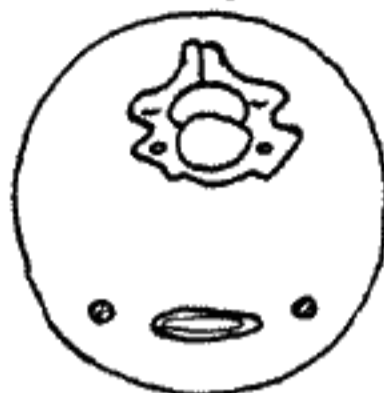

CHOKE
ex: Forearm pressure.

Affects carotid arteries

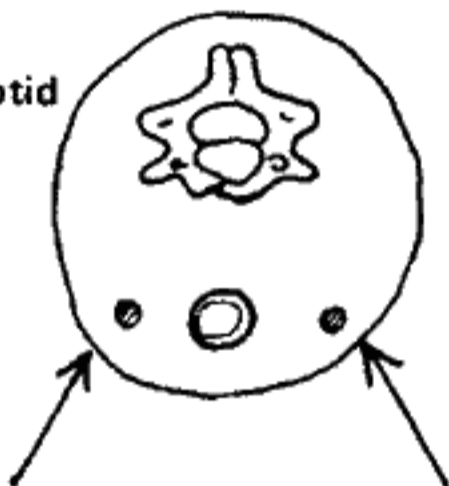

STRANGLE
ex: Finger Pressure

Affects both windpipe and arteries

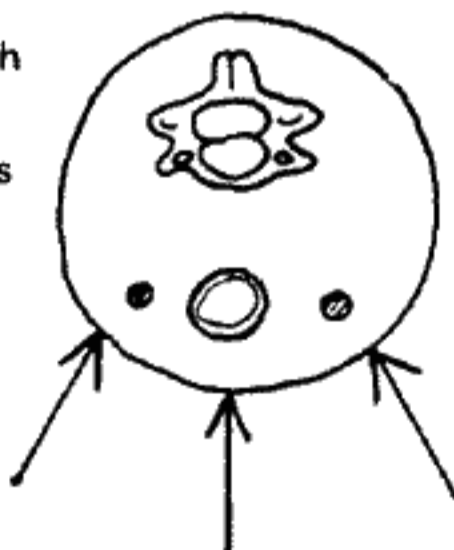

HANG
ex: Commando strangle.

Kill

stopped convulsing and tremors have ceased. At the end of that time a coup de grace should still be administered.

Another method of strangulation or more precisely, choking, is done with just two fingers. The thumb and forefinger are driven into the throat and get a tong-like grip on the horns of the thyroid cartilage. (Just above the larynx, or voice-box.) Firm digital pressure is applied and maintained until the subject expires.

At the back of the neck is the backbone and spinal cord. This is attacked forcibly with the edge of hand, elbows, knees and feet. (to be more effective the feet should be shod.)

Blows to the face are, as a general rule, not fatal and are not encouraged. The temples, however, are to be battered severely to bring on unconsciousness and death.

The head should be grasped when the subject is downed, lifted by the forelock or ears, and smashed unmercifully into the ground. This severely depresses the back and base of the skull and death will be quick.

A chin jab with the heel of the palm can cause a knock-out if delivered forcibly enough, even a broken neck.

The one exception to the face is the eyes. Severe damage to the brain can be done when the thumbs are jabbed into the eyes and pressing inwards, aiming for the center of the head, the thumbs break through the skull and are driven in to their full length. At the same time the head is grasped in the hands and given a jerk resulting in more brain damage. (The eyes, of course, are destroyed.)

When the subject has been downed the whole head can be targeted for the coup de grace which is delivered by jumping on it with both feet until it is squashed.

The feet can be used against the lower spine where the heel is dug into it with a forceful kick; the aim being derangement of the spine and the severing of the cord. The best point for this action is between the shoulder blades. A broken neck can cause death when it fails to give the head support and lolls forward and constricts the windpipe.

The bones about the heart can be crushed and driven inwards to impale it and cause death. In the case of the sternum, or breastbone, the heel of the palm driven in at an angle can cause splintering and lacerate the heart. The ribs can normally be crushed by the feet. They can cause the lungs to collapse if punctured also.

Very forcible and accurate blows to the plexus in the pit of the stomach and the groin can also result in death but normally only unconsciousness results. The same holds true with blows to the kidneys. If death does occur

HEAD SMASH

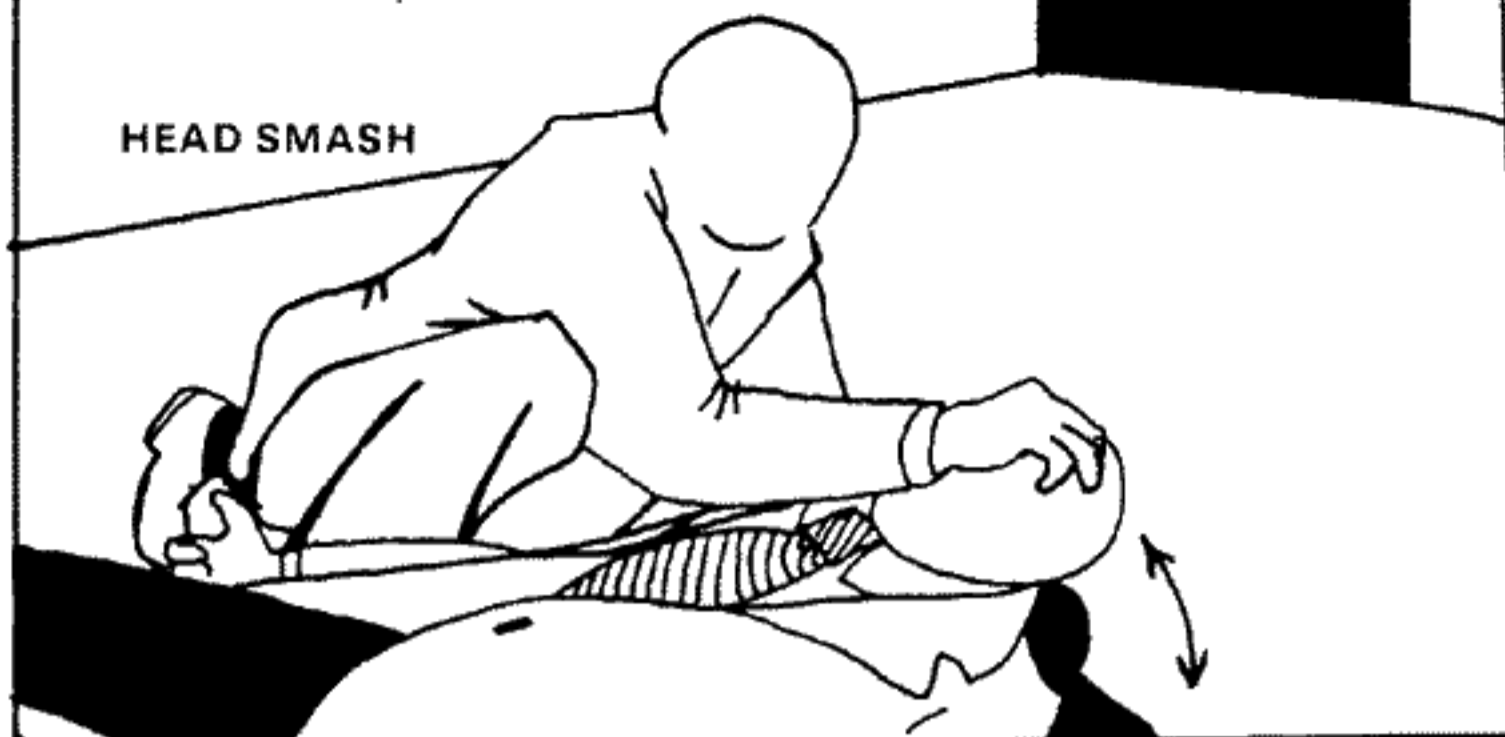

EYE GOUGE



TWO-FINGERED
STRANGLE

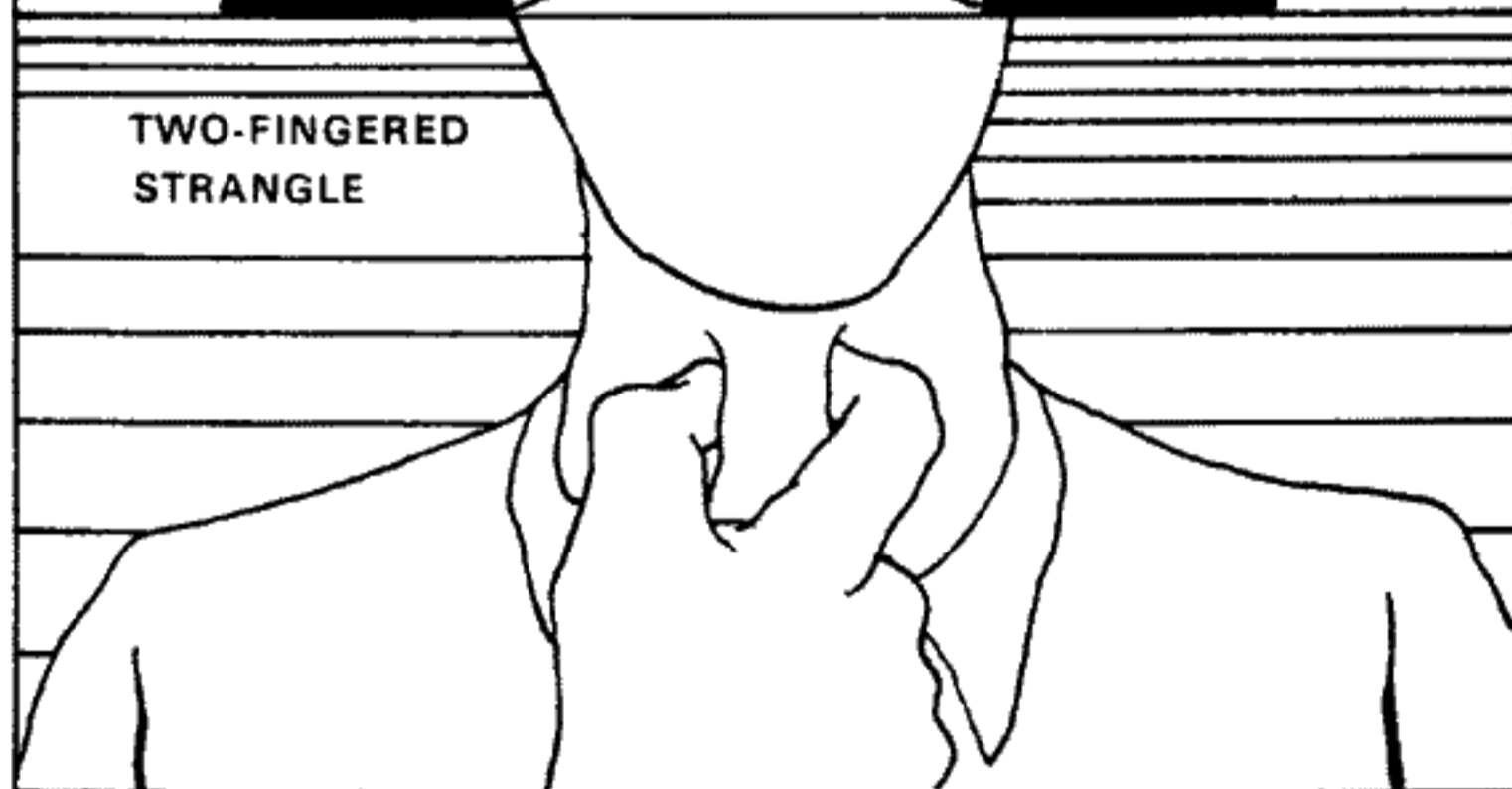

Kill

in these areas it is the result of severe shock.

Most hand-to-hand courses aim primarily at submission or control of the subject. Killing if it does take place is a by-product or spin-off and is normally anathema in most self-defense methods. The assassin must be absolutely ruthless, on the contrary, and must take every opportunity to kill.

BLANK

PAGE

LESSON THREE: CLUBS FOR KILLERS

The weapon we now consider is the lowly club. This weapon has been with us since caveman days and has proved its lethality ever since. It can be in several forms and comes under a variety of names these days: black-jack, baton, night-stick, sand-bag, cosh, flail, sap, etc. But basically it is a heavy, bone and muscle crushing instrument that is an extension of the human arm and fist.

For purposes of assassination it should be made as heavy as can be managed. The intention is to rain a killing blow or series of blows, on the head, spine, throat, and heart.

Iron bars and lead pipes are ideal and can be wrapped in newspaper or in a mailing tube for further concealment. Spring snapper coshes or the expedient of a sock filled with sand or a bar of soap are also deadly.

The prosaic hammer can be employed with telling effect and would not attract much attention anywhere. Half-bricks, large rocks, and two-by-fours can and have been used as clubs and are universally available. They are directed primarily at the head to cause massive, mortal brain damage.

(Fist strengtheners such as judo, yawara, kashi-no-bo sticks attack the same targets as the club. Brass and iron knuckles are in this category too.)

The efficiency of the lowly cudgel cannot be over-emphasized. It is often disregarded in assassination work or considered as a less than ideal substitute for other weapons. However it is a near perfect weapon in its own right. It is deadly, silent and ubiquitous. It has been doing its job for tens of thousands of years.

Any bludgeoning instrument must, of course, be heavy and a heavy blow must be struck. The best attack is from the rear and the blow delivered like the wind-up for a baseball pitch including the follow-through. One blow such as this should be sufficient to kill but two or more blows should be directed to two different vital areas.

Although clubs can be shorter, the ideal length is from fifteen to twenty-six inches. It is also important to use a club that will not break after a heavy clout. For this reason they should be tested in advance, or stick to lengths of pipe.

It is possible to strike a blow on the tip of the subject's genitals with a downward swing from the front. The club is withdrawn from the inner breast pocket or from under a jacket just prior to this attack and doesn't attract as much attention as an overhead blow. He must still be finished off.

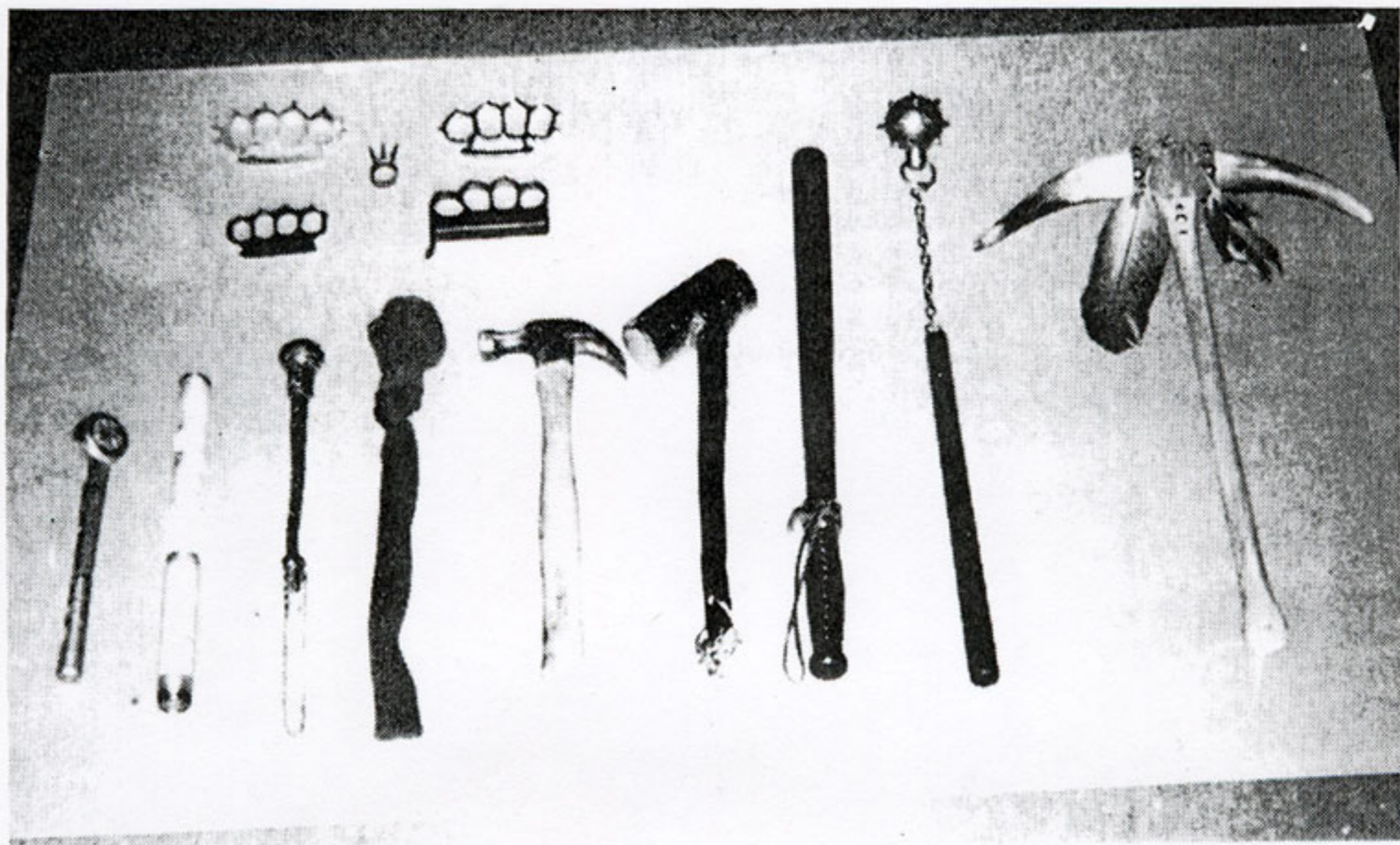

SAMPLE OF CLUBS AND BLUDGEONS

Left to right i Ratchet wrench ii Length of lead-pipe iii Snapping black jack iv Soap in a sock black jack v Hammer vi Shillelagh vii Truncheon viii Morning star ix Indian tomahawk Upper l. corner Aluminum, chromed, iron and brass knuckles w/trident knuckle duster.

Kill

Other blows delivered from the front are to be directed against the sides of the neck and to the temples. There must be no advance warning of the attack and your every move must be as natural as possible before launching it. From the rear, and by far the best place to attack your subject, the targets are the back and sides of the head (below the ears), the back and sides of the neck, between the shoulder blades, and the kidney areas. If possible always use both hands to achieve maximum force and always aim at a point five inches below the skin at the target site to insure there's no holding back.

BLANK

PAGE

LESSON FOUR: THE HATCHET JOB

Hacking weapons are very effective and include axes, hatchets, mattocks, broad swords, cleavers, machetes, etc.

The chief concern with these weapons is that they be sharp as possible and that they have a fair weight.

The prime target for these weapons is the neck and head. Disabling blows to the extremities may be first needed but decapitation and nothing less, should be established as the finishing manoeuvre. Decapitation satisfies all three requirements of mortal injuries — it is also visual proof-positive that death has occurred.

This points up the fact that the hatchet, or battle-axe — tomahawk, is one of the best all-around hand to hand combat weapons. It can be used as a club to down a man, and as a cleaver to kill him. It is easily portable and is always handy.

Swords as assassins' weapons may be antiquated, but swords are still concealed in canes and walking-sticks.

Machetes are excellent killers and are more portable than the sword and may be concealed in shopping-bags or wrapped as a parcel. They should be rated next to the hatchet in effectiveness.

Meat cleavers, as the name implies, do just that, and can be carried under a coat or wrapped in a newspaper for concealment. They can chop and cut and are very effective.

Mattocks or ice-axes are useful as is or shortened for concealment. Leon Trotsky was assassinated with one of these

When used as a weapon, the tendency to hack and hack must be discouraged. Lopping off arms and legs and attacking the face is unnecessary and only adds to the disorder and confusion. What is desired is a one-two approach. One, a downing or knock-out blow, Two, severing the head.

Severing the spine at the neck is considered a partial decapitation, and blood loss will not be great unless—by rolling the subject over and then chopping the throat—the head detached. Complete decapitation is the complete removal of the head. If time and circumstances allow, this is what should be done.

Although the neck is a prime target, the skull can be bisected. The chest cavity can also be penetrated to the heart with these weapons resulting in mortal wounds.



HACKING WEAPONS

Top walking stick mattock (ice axe)

Left to right

i Machete (South America, Cuba, Africa, Asia) ii Hatchet (North America) iii Hatchet (North America) iv Hand Axe (North America, Europe v Pruning Axe (Europe) vi Gurkha Kukri (India, Nepal) vii Bowie Axe (North America)

HATCHET TO THE MEDULLA

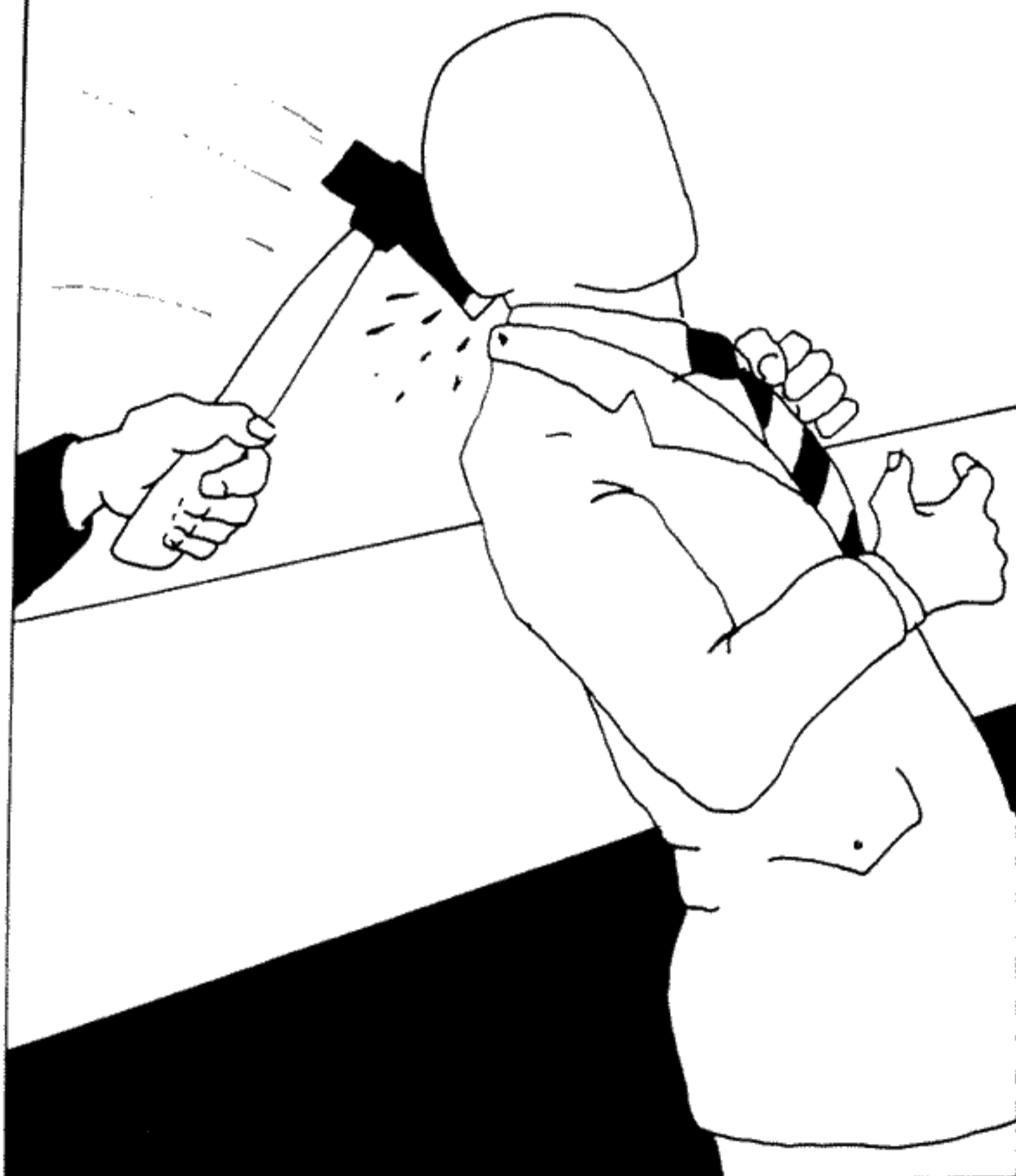

DECAPITATION

Instant termination

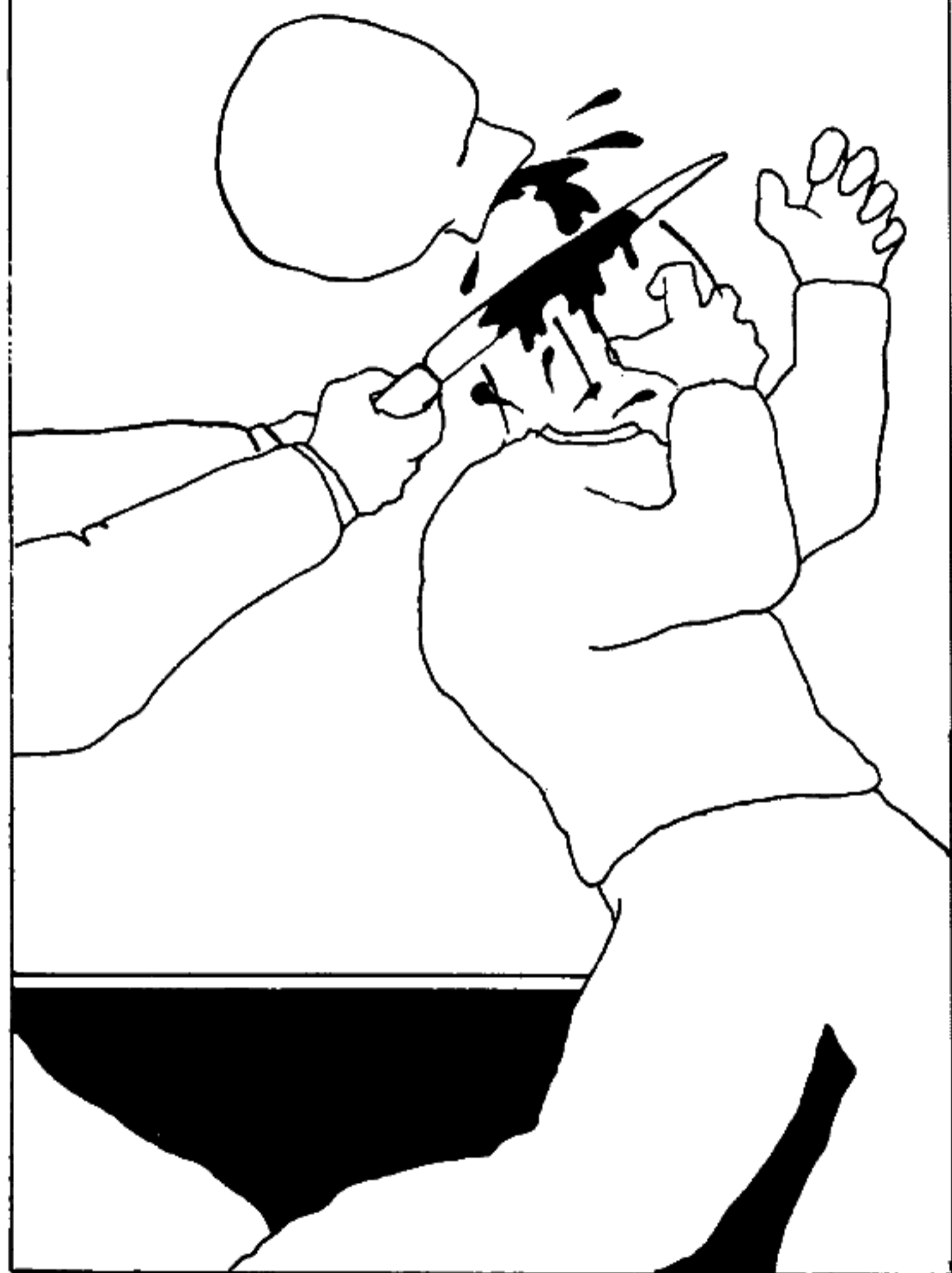

Kill

If the subject's execution is to be ritualized, kneel him down, hands tied behind his back. Pass the blade of the weapon lightly over the back of his bowed head. This causes the muscles to stiffen. Then chop for a clean kill.

BLANK

PAGE

LESSON FIVE: KNIFEWORK

One part of the cloak and dagger business that has gone low-profile is the dagger. It is one of the most popular instruments for assassins and should be treated here in some detail.

Its purpose is to slash and pierce, or rather, to cut and thrust; it can serve as a judo stick for butt strokes also.

The ideal dagger is one modelled after the Fairbairn-Sykes pattern and was designed for use by Commando troops.

Killing enemy sentries with combat knives is fairly well known and is taught by all major armies. Basically, the subject is approached from the rear, grasp the mouth and nose in a clamped palm and simultaneously thrust the knife into the right kidney area, withdraw the knife and slash the throat from ear to ear.

Some other variations: instead of slicing the throat the knife is stabbed into the neck about three to four inches below the ear until it protrudes from the opposite side; then the knife is slashed outwards, through the throat. The knife can also be stabbed downwards, through the gap between the collar bone and shoulder blades to sever the subclavian artery. This attack is very useful if the subject is in a sitting position. The knife should be worked backwards and forwards during the withdrawal and one must try to slash as much of the underlying tissue as possible in the process.

One thing that must be considered at this point is the issue of blood — there is a terrific amount gushed about in any throat cutting operation. It can squirt back into your mouth — keep it closed; into your eyes — try to avoid it because it will temporarily blind and disconcert you. A gurgling sound will most likely issue from the subject and cannot be squelched even if the initial outcry was. Be prepared for the bowels and bladder to let go while you're holding him. If you're in mufti you'll have to consider where to place your feet because blood will fall onto your pantleg and shoes. It might be a good idea to roll up your sleeves because if he sprays your arms you can then wipe the blood off and roll them down again. An added precaution would be an overcoat or a reversible jacket.

In a frontal attack the throat can be targeted but again be prepared for the blood. Most likely the heart will be the prime target. When stabbing into the chest the blade should be horizontal to allow for clearance through the ribs. The knife can also be thrust under the rib-cage to the heart. The thrusts in both cases should be well-directed but strong. It is normally necessary to

KNIFEWORK

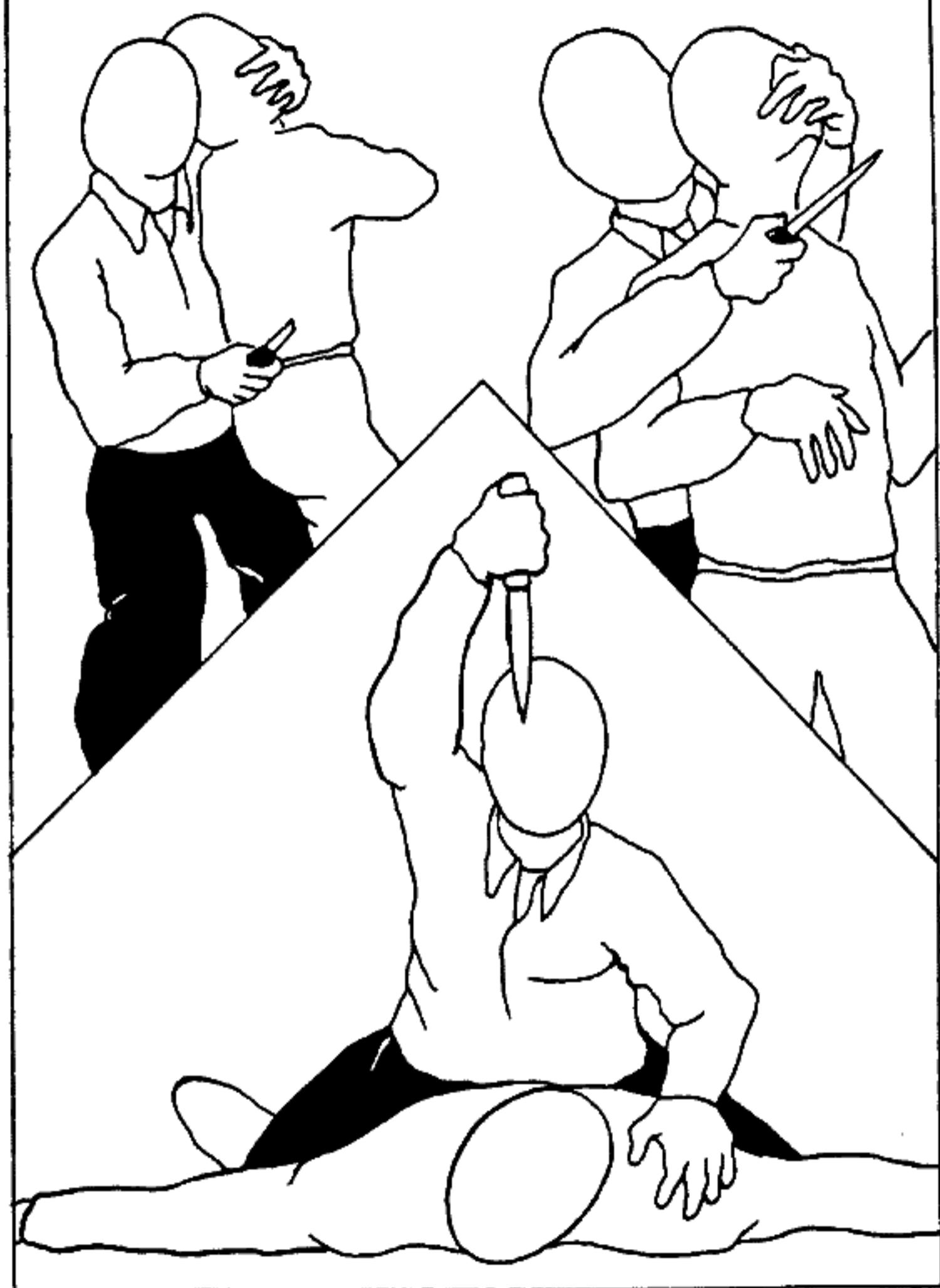

Kill

penetrate one-and-one-half to two inches of flesh to reach the heart and an additional two to three inches to be through it enough to insure death. The subject should collapse the moment the knife enters so be prepared for it and withdraw the knife quickly or else follow him down and then extract the knife, otherwise the blade may snap. Most experts say to leave the knife in but I don't advocate it because it can be traced, you may need it for self-defense, and good knives are hard to come by.

When withdrawing the knife from a deep stab wound it is oftentimes difficult because the flesh of the body has a tendency to contract and grip the blade and suction adds to the problem and care must be taken not to snap the blade. If penetration was as deep as it should have been you may well require both hands to withdraw the knife.

If the subject is to be killed in a walk-by, pass him on your knife-hand side with the blade flat against your forearm and the handle grasped solidly. As you draw even with the subject swing your arm back and thrust the knife into his kidney area, in this case, leave it there and without losing your pace keep on moving through the crowd. The main point is the neat, timed, execution of the movements. In most cases the subject will stagger, then fall and a few more seconds before passers-by realize that he's been stabbed. As there is no direct connection with you, and by that time you'll be several yards away — you're home free.

A more open attack in the street that requires greater speed and more risk, is to approach on a walk-by, knife-hand side again, the dagger is in your suitcoat top left pocket, behind the handkerchief. (The F-S Comman-do knife can fit there if the blade is thrust through the bottom of the pocket's seam and between the lining.) As you approach the subject make a natural move for the handkerchief and from about a pace away, draw the knife in a high sweeping arc and slash the subject's throat.

The heart could be stabbed in a similar manner and the knife could also be kept in a sheath in the front pocket. In the walk-by, saunter along with your hand in your knife pocket, pass on the knife-hand side, and again from a pace away, draw the knife and stab under the ribs to the heart. This technique can be done on a rear approach, with the assassin walking by to overtake the subject, the dagger is thrust into the kidneys.

Slashes to the wrists, inside elbow joints, under the armpit, inside the thighs, all attack major arteries and if unattended will cause death. Stabs and slashes to the stomach and abdomen to disembowel result in shock but death is not so sure so a follow-up action against the throat or heart is necessary.

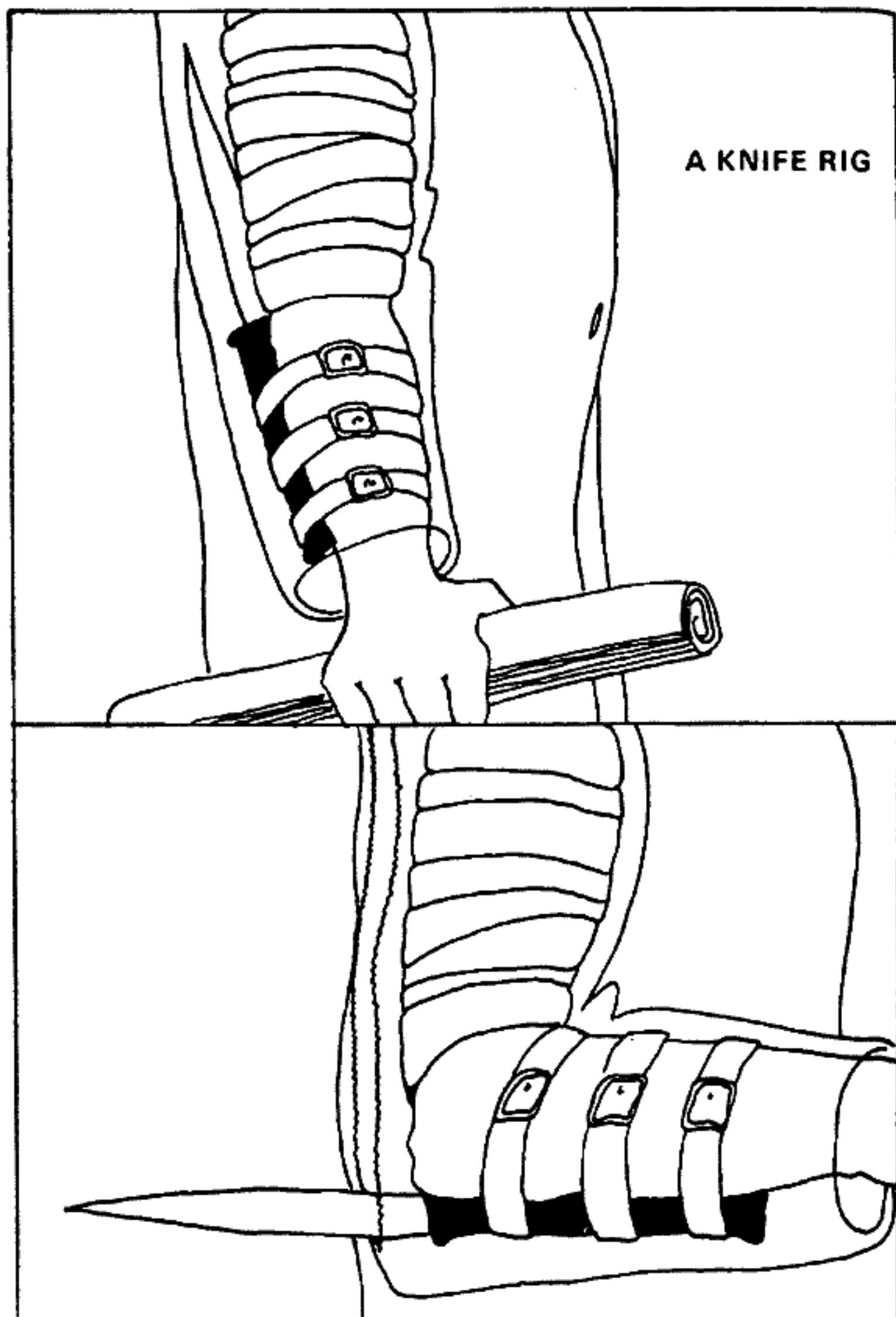

A KNIFE RIG

The knife is strapped to the fore-arm and worn under a rain-coat. (the upper arm is bandaged to forestall cutting one's self.) When the arm bends the blade cuts thru the coat. Pass the subject and jab it into his kidneys—Lower the arm and the knife returns to its former position.

NEEDLE KNIVES

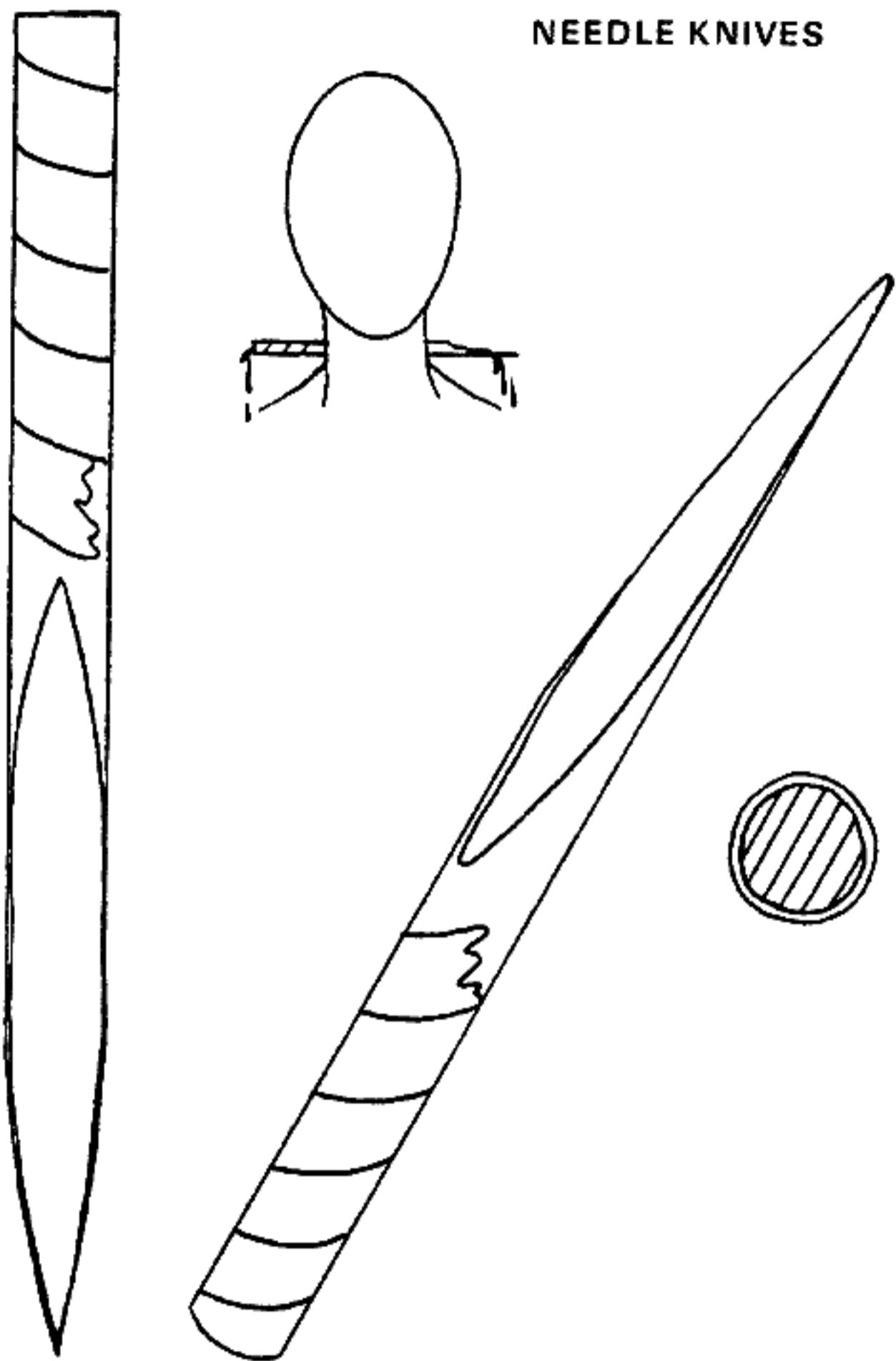

This knife acts as a funnel through which the blood flows-the blood will not coagulate.

Actual size Apart from piercing this knife cuts a circular hole like the above. $\frac{3}{8}$ " conduit tubing ground at an angle to produce a sharpened point and trough. Can be made longer for use as a lance. Taped handle $\frac{1}{2}$ size (can be barbed to prevent extraction.)

Kill

If you're using a single edged knife, and you really shouldn't for this type of work, after the subject has expired re-introduce the knife into the wound with the cutting edge reversed. This will lead the investigators to believe that a double-edged weapon was used.

There is a special rig for urban assassination shown in figure nine.

Another special dagger can be made from thin tubular steel or copper. The knife is about nine inches long and very much like an over-sized syringe needle. When thrust into the neck, chest, or kidney area, this knife is left in. The blood flows out of the hollow handle and will continue to flow in a constant stream as it does not allow the wound to close nor the blood to coagulate.

With ice-picks and stout needles, pinpoint accuracy is needed. The targets are through the eyes to the brain, through the ear canal to the brain, and up the nose to the brain. Attacking the throat is chancey as the point must do damage to the arteries and this precision is seldom possible. The rear of the neck and the rest of the backbone can be attacked to damage or sever the spine. (A sharpened screw-driver or thin, sharp chisel can be used here). Entry into the medulla through the base of the skull is also possible. From the front the only real target apart from the head is the heart. If your accuracy is what it should be, one penetration should be enough. There is very little blood and even so the blade or point should be passed through a balled-up handkerchief, and with the handkerchief affixed near the hilt or handle the ice-pick is jabbed into the heart for a kill. The cloth will catch the blood and then withdraw the point.

With these weapons the cause of death is sometimes very difficult to ascertain. The wounds to the brain through the cavities seldom leave any clues of foul-play even after a post-mortem. Even if they do, by then you should be well clear. The needle wound in the heart is even difficult to detect.

To get by magnetometers, glass knives or wooden slivers can be carried as well as aluminum, copper and other non-ferrous materials.

In personal searches razor blades can be taped or band-aided to the soles of the feet (kept within their paper wrappers, of course). It is one place searchers seldom look. A wound one-half inch deep to a neck artery is not too difficult to do with a razor blade. The two blades could be thumb-tacked to a narrow board so as the cutting edges extend over the side and this would be a handy slashing weapon.

Throwing knives I won't advocate for assassination because for most of us it's a fifty-fifty chance as to whether the knife will land correctly, and if it does will it hit a vital spot. If the knife must be used at long range make a lance or spear out of it by lashing it to a broomstick, mop, or inserting the

Kill

handle into a length of pipe. The targets are the same as with the knife but don't throw the spear unless you must but rather use it like a bayonet or pike.

Arrows can be considered as long range knives and can be used in assassination work. The difficulty in concealing the bow or crossbow is a drawback though. Collapsible bows and powerful crossbows with extending stocks can, however, be used. It is necessary that the arrowheads be razor-sharp and that you must have the skill to kill with the weapon at the distance you planned. Poison pods should also be used and these are made from the necks of toy balloons and affixed to the shaft just behind the arrowhead with the poison inside. Crossbows are perhaps the easiest to master for the assassin and are aimed much like rifles. Longbows require more skill but can be mastered with practice. Both weapons are silent and deadly and assassins should not fail to consider them in planning operations.

A final word on knives. Folding and switchblade knives should not be used in a killing situation due to the tendency of the blade to close on one's fingers during a slash.

BLANK

PAGE

SPECIAL WEAPONS

As most of these devices are home-made this precludes the possibility of their being traced. They are, in effect, "sanitized" and perfect for assassinations, where weapons are prohibited, or where customs in the hostile country are stringent so these can be made from local materials.

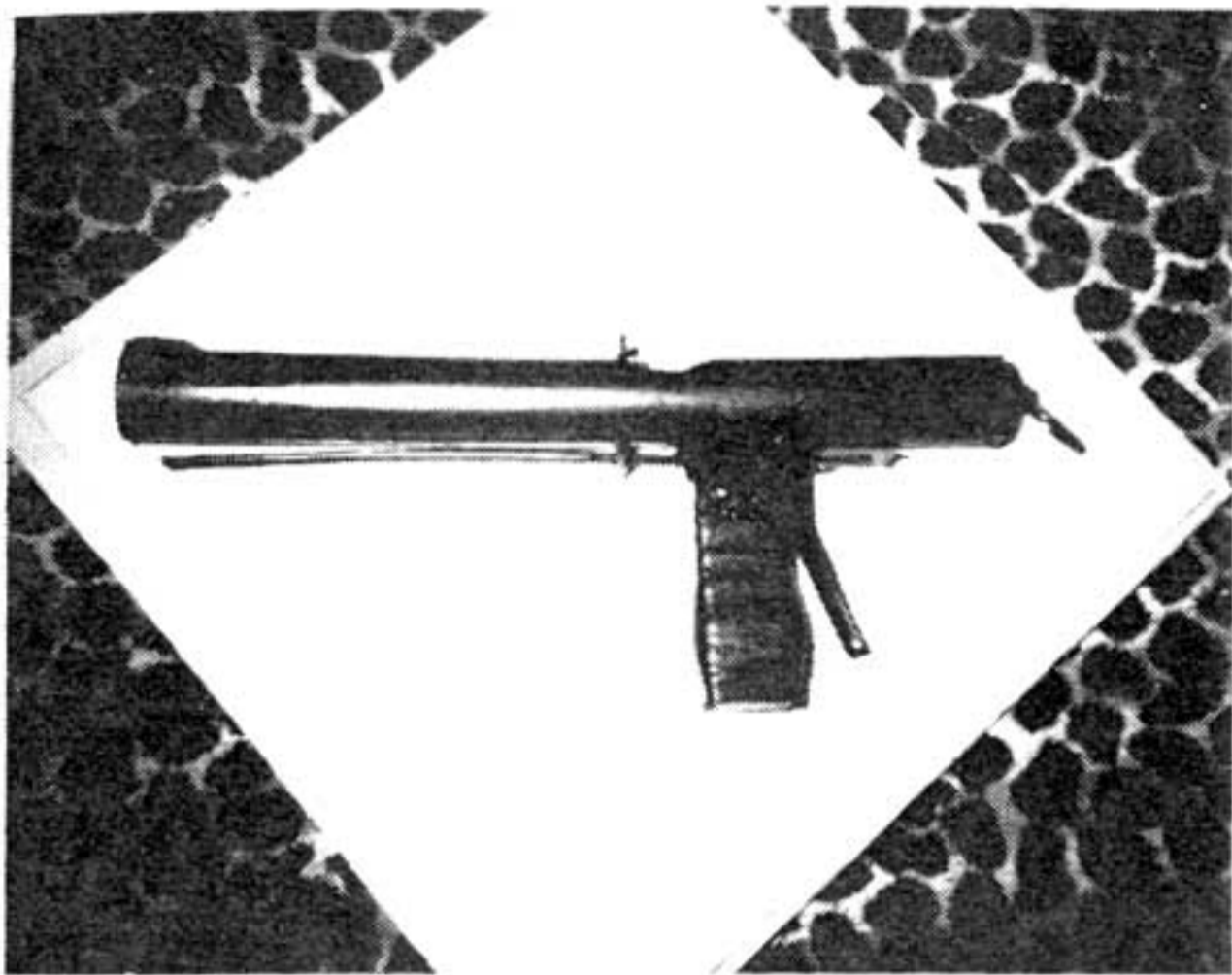

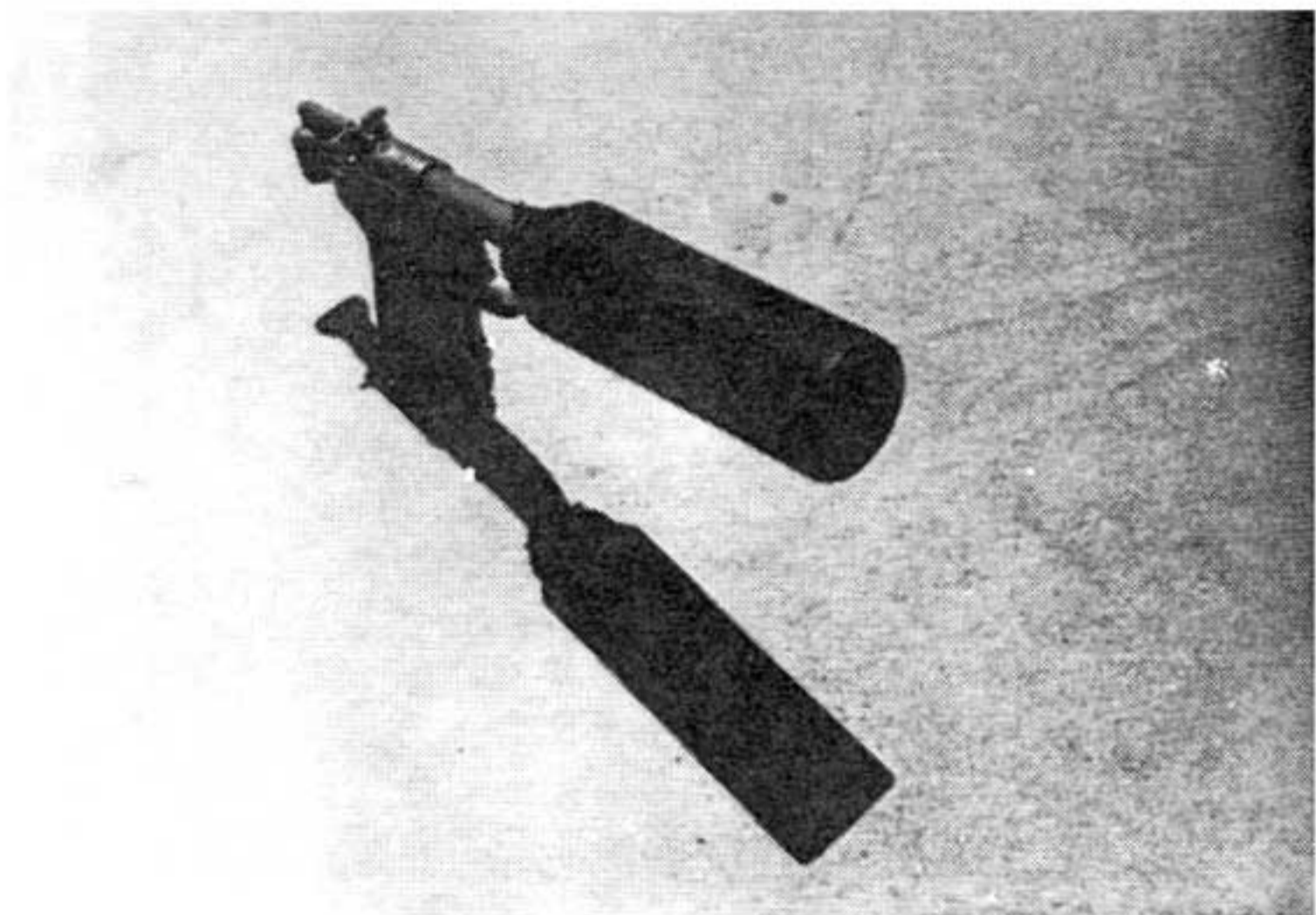



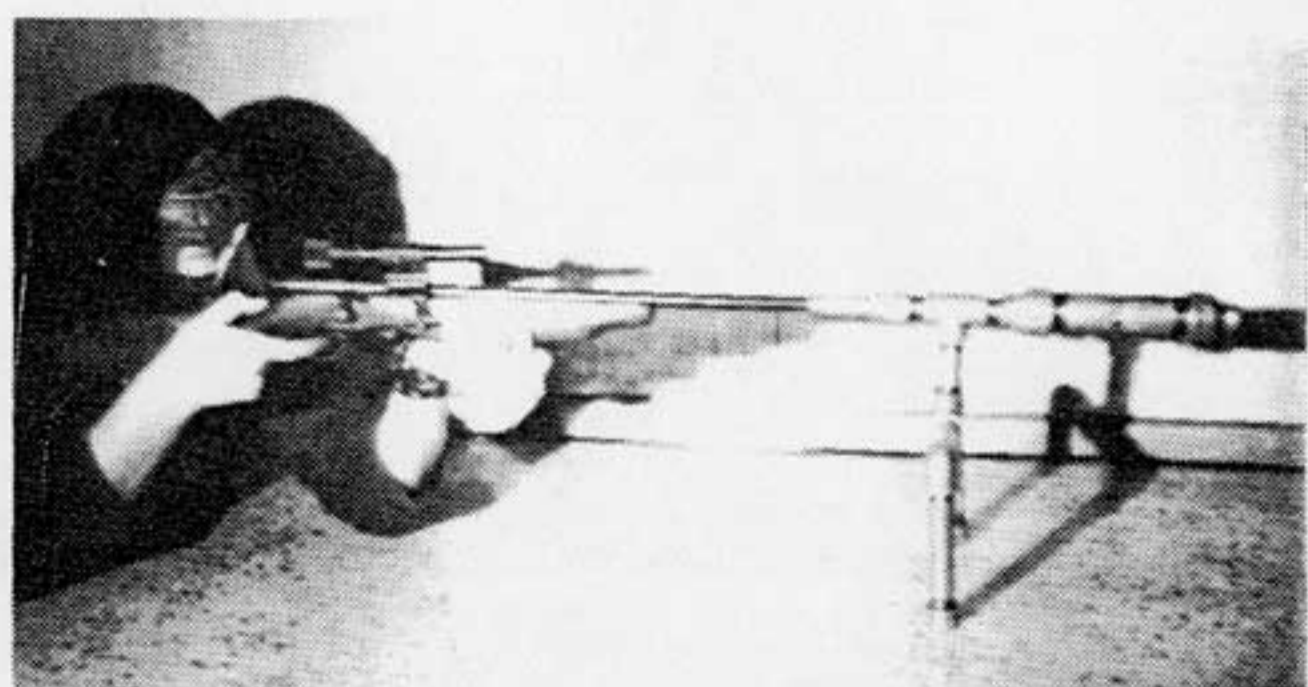

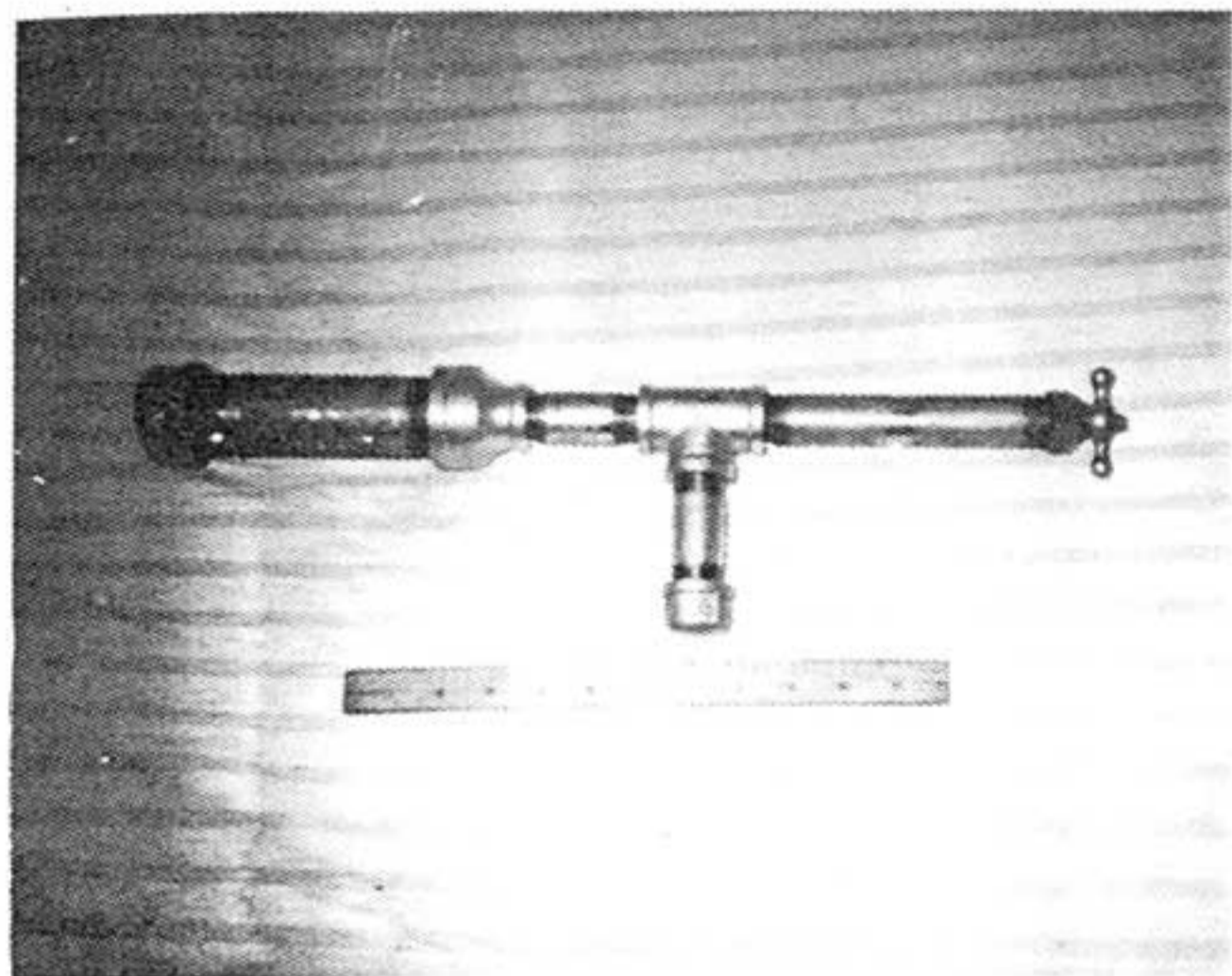

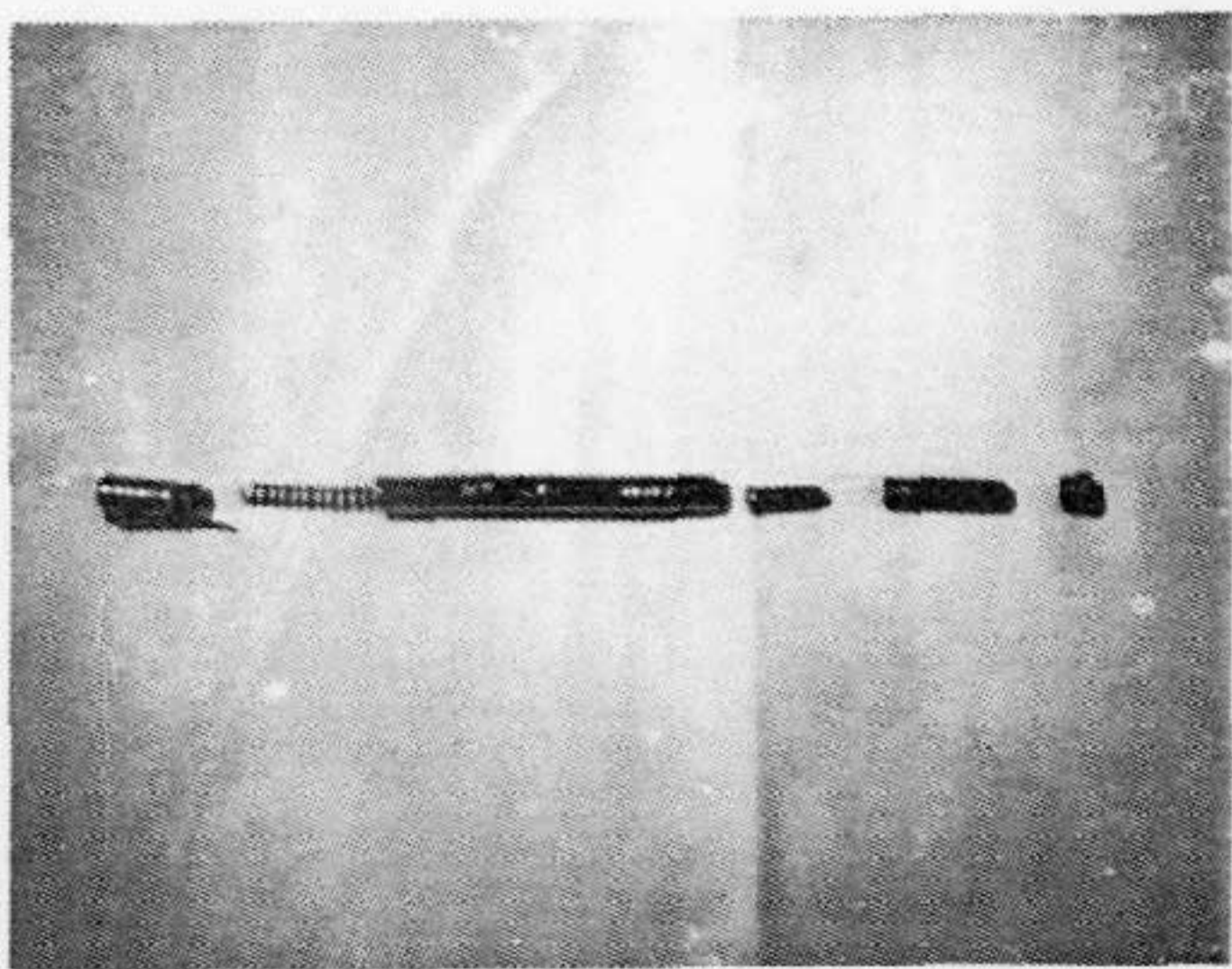
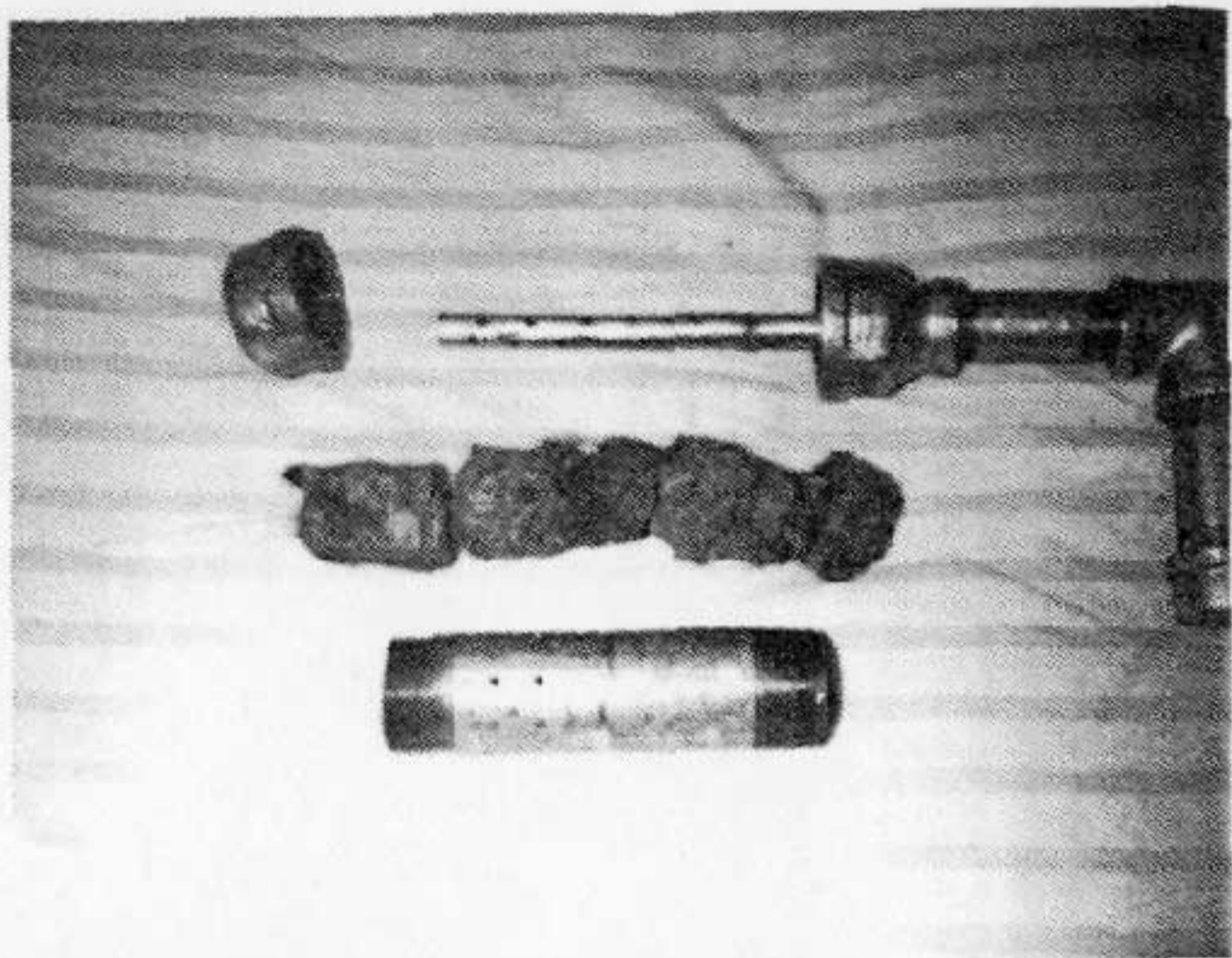

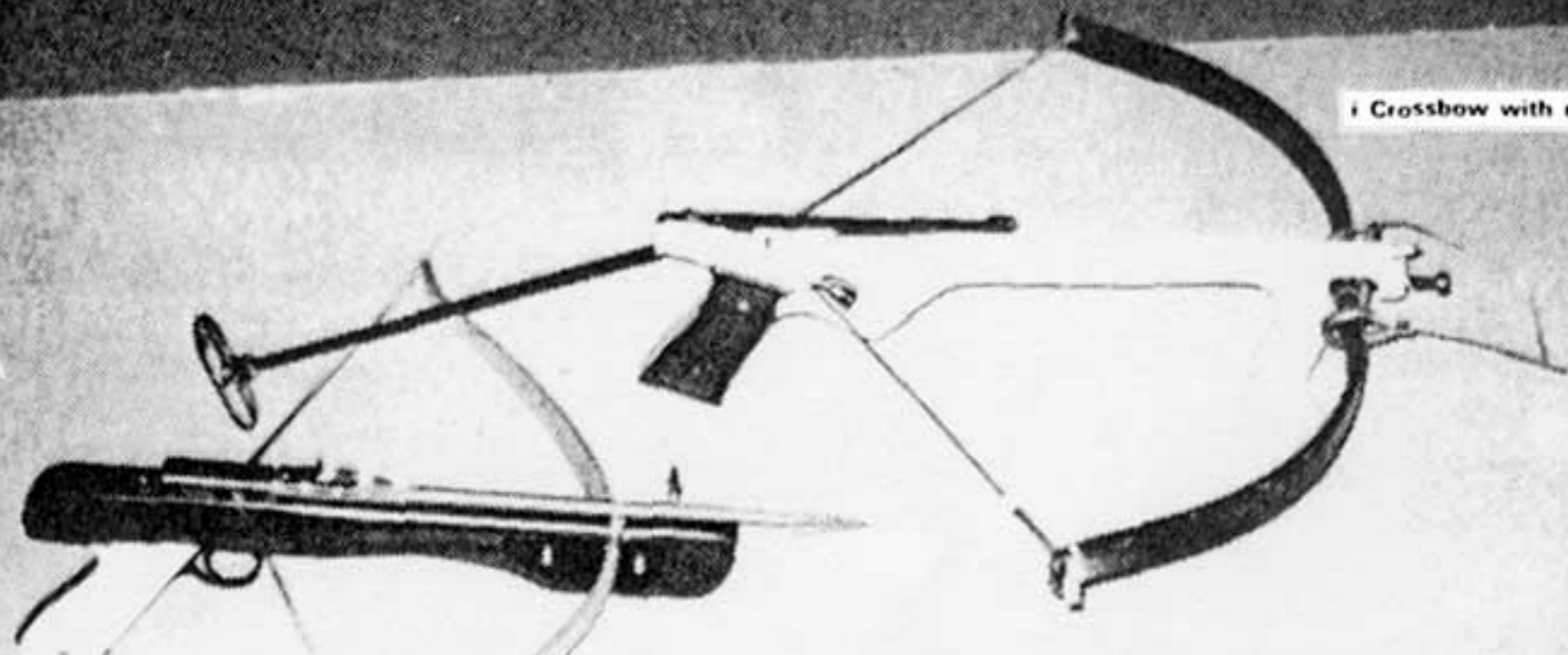

ii Pistol crossbow.

i Crossbow with removable butt.

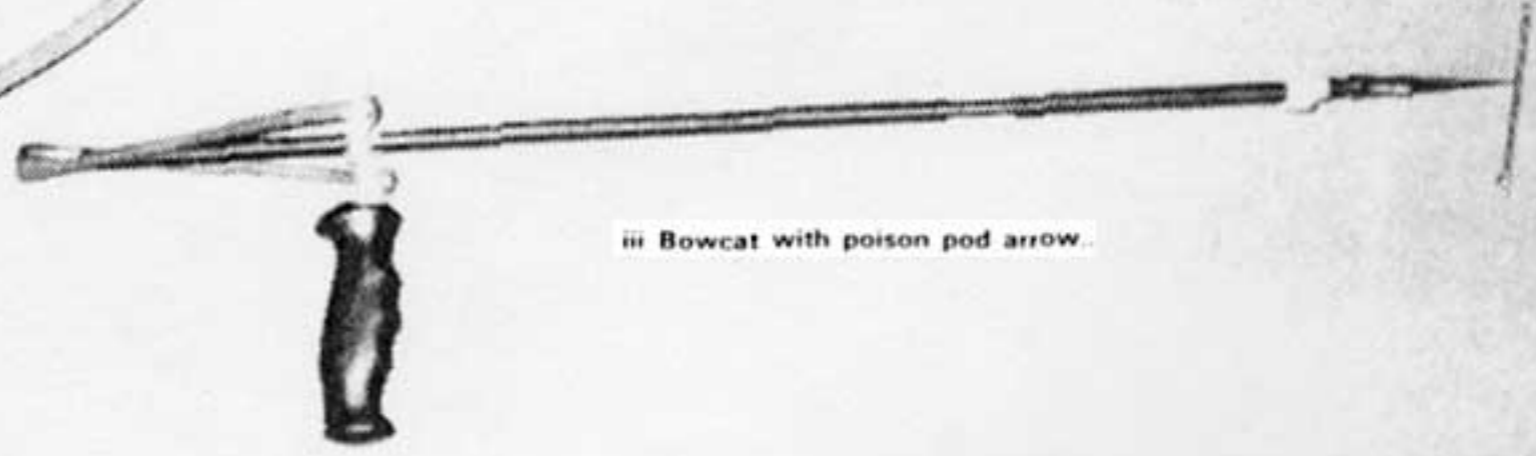

iii Bowcat with poison pod arrow.

BLANK

PAGE

KNUCKLE PISTOL* .22 CALIBRE

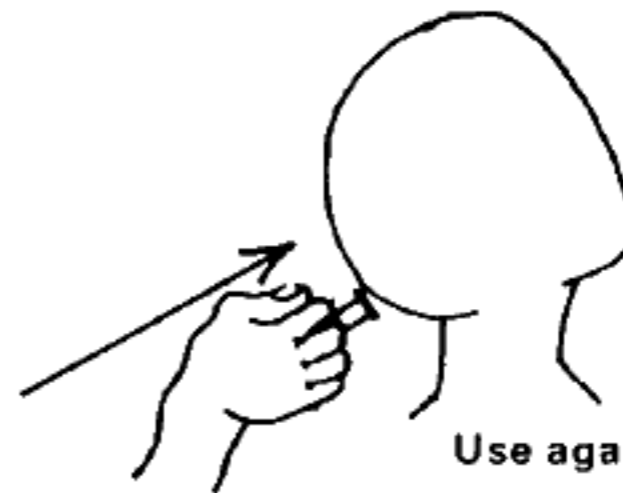
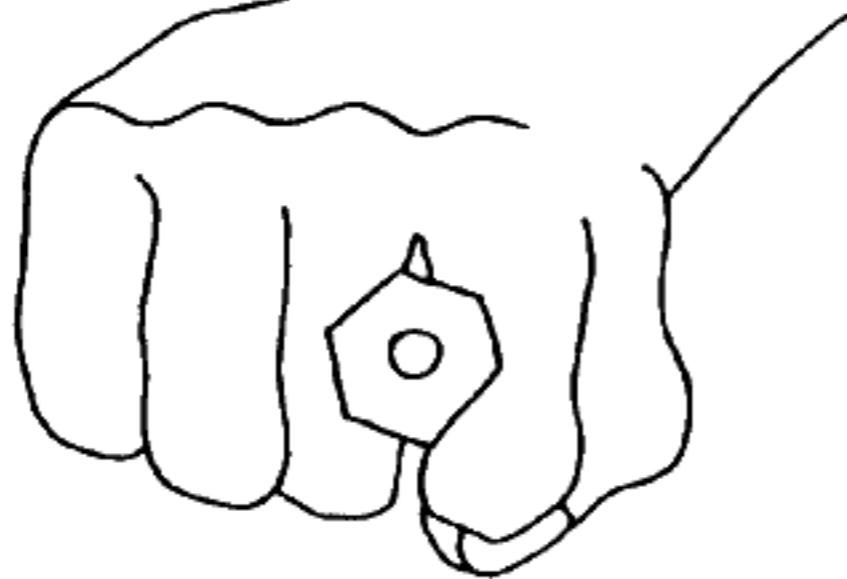

Use against the skull, sternum or any boney surface.

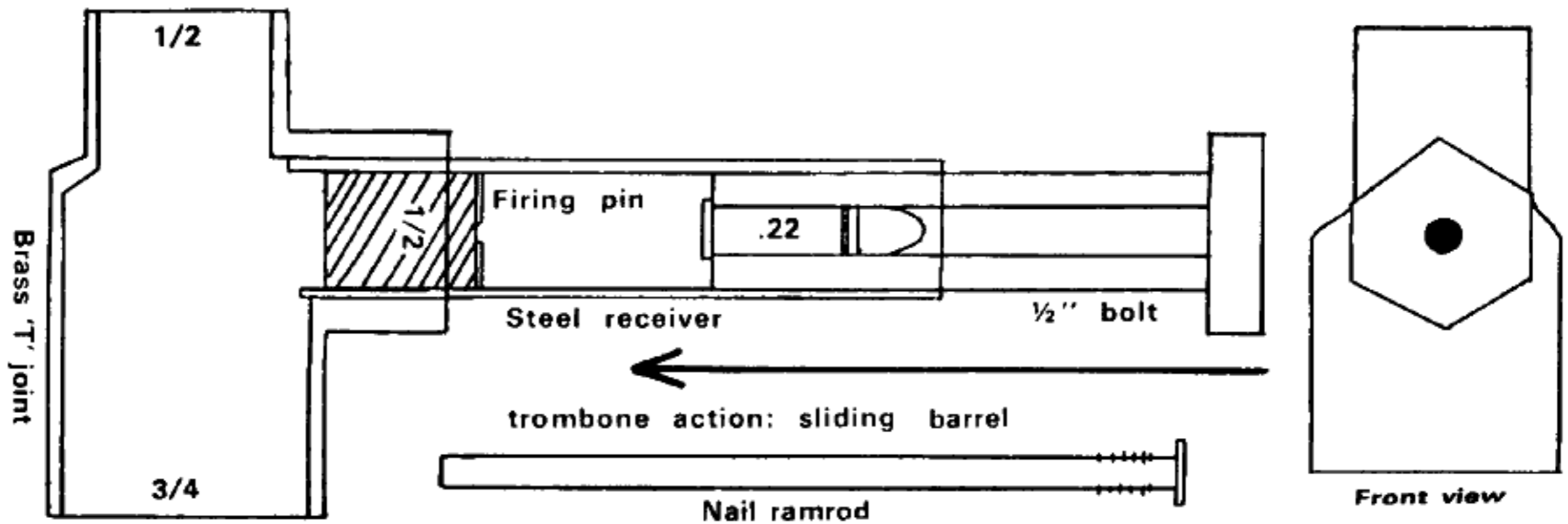

* This pistol is quiet firing because of the muzzle to skin contact can be made in large dimensions in .38 cal. By hooking an elastic band over the muzzle and around the butt it can be fired on the pull-release principle for longer range.

THE COMMANDO STRANGLE

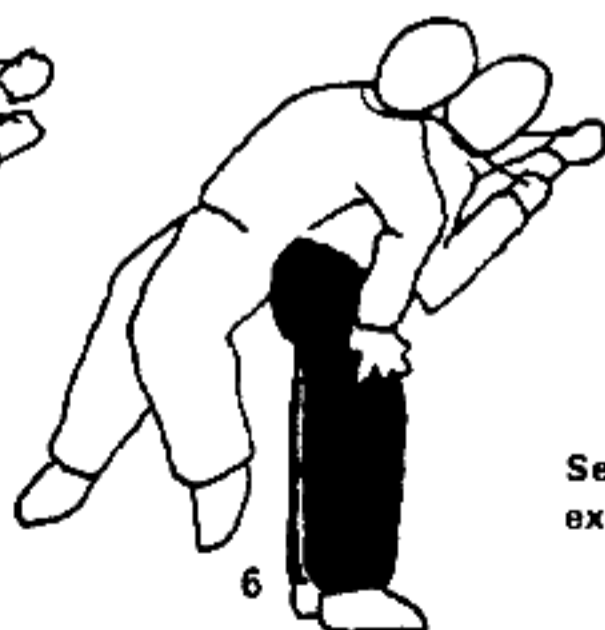
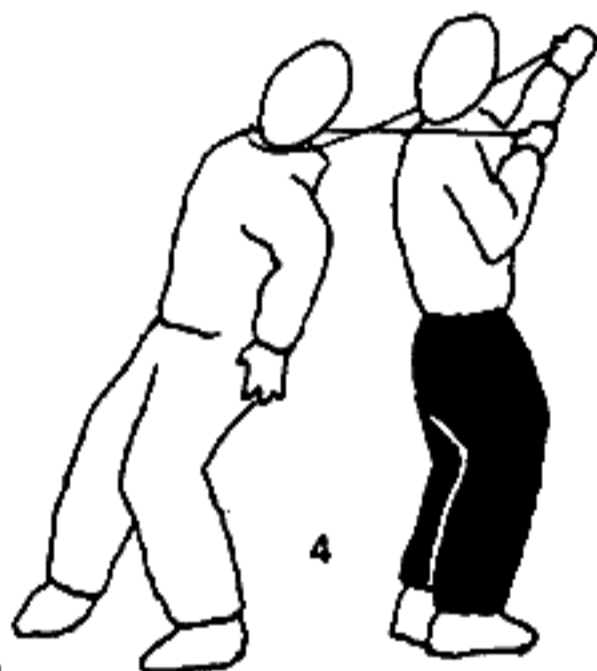
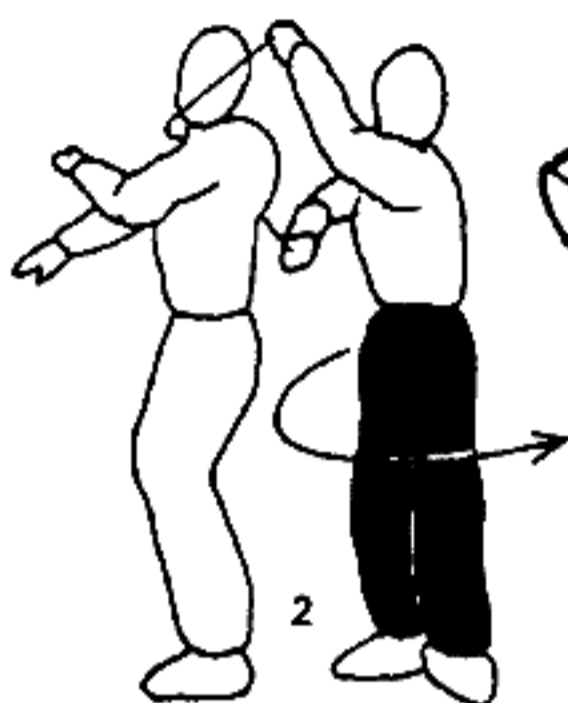
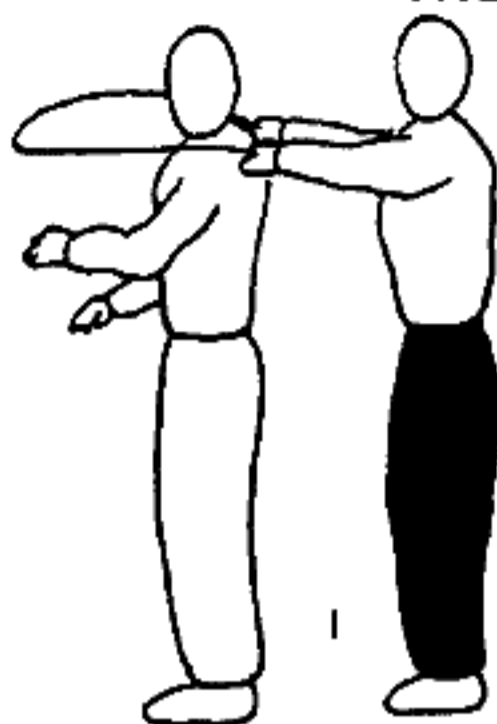

See pg. 39 for explanation.

LESSON SIX: HANG TOUGH

Let us now consider mechanical strangulation where devices other than the bare hands are used. These include cord, wire, rope, sticks, pipes, etc.

The so-called Commando Strangle is one of the most effective and easily mastered techniques. The approach is made from the rear. The weapon is a length of wire (24-30 ins. long) affixed at each end to wooden dowels for handles. In this form it's usually referred to as the steel sling.

Holding on to both handles the wire is thrown over the subject's head and a rearward pull is applied, quickly turn around so that the wires come over your shoulder, continue pulling him backwards and holding onto the sling. In so doing the wires cross and the subject and assassin stand back to back. At this point the assassin bends over at the waist and lifts the subject from the ground and hangs and strangles him in that position till the subject expires.

The whole procedure takes only a few, brief seconds, and there is no defense. When the subject has expired he can be thrown over the shoulder and deposited at your feet.

There are other methods and these call for the looping of cords over the head of the subject and crossing them at the rear of the neck. These methods do not call for a change of position. If stouter material such as rope or lady's nylons are used it is advisable to tie two knots corresponding to the arteries on the neck so as to give the rope more "dig".

If a slip knot is used throw the loop over the subject's head, draw it tight with your right hand and put your left hand under the knot, between it and the subject's neck. When the cord has tightened up, close your hand over the knot and give it a twist. This brings terrific pressure to bear on the throat and allows you to be at arm's length from the subject.

Using a length of stick is also very effective. Hold the stick in both hands allowing a space for his neck. The assassin approaches from the rear, and raises his arms over the subject's head and drops them quickly and pulls the stick tight against his neck. The subject is drawn close and pressure is applied. A variation of this method is to use opposite hand positions to effect an 'X' strangle. This means that the right hand puts the stick under the subject's chin from the left and then the left hand grasps the other end of the stick on the right. Good pressure can be achieved from this method and the windpipe is nearly always crushed in stick strangles.

BLANK

PAGE

LESSON SEVEN: A DOSE OF DEATH

Another assassination technique that has been used through the ages is the use of poisons. These can be inhaled, injected, imbibed, absorbed, or eaten.

One of the most lethal poisons is cyanide and its brothers hydrocyanic acid, and cynogen gas.

Inhaling cynogen or consuming cyanide brings on a condition called histotoxic anemia where the ability of the body to absorb oxygen from the blood is impaired or abolished resulting in rapid death.

Cynogen can be liberated from aerosols, squeeze bottles, or specially designed projectors. In most cases the assassin must take an antidote before and after firing the gas at the subject's face so that he himself does not fall victim to the effects of the gas. The antidote is either sodium thiosulfate or sodium nitrate tablets before and amyl nitrate or a urinated handkerchief inhalant after. The second choices in both cases aren't as effective. Although death is rapid it is preceded by vomiting, diarrhea, and convulsions.

Strychnine is a very effective poison that attacks the nervous system and causes the body to bend like a bow in death. To counteract this effect and so to disguise the poisoning, a portion of cyanide is also given. The symptoms of both poisons are, in effect, opposite but mutually effective in causing death resulting in no outward symptoms of poisoning.

Another way to disguise the symptoms when using the drug morphine, which causes a characteristic narrowing of the pupils, is to administer bella donna drops to the eyes which cause dilation of the pupils and so negates this symptom. Four grains of morphine is more than enough to bring on death to a non-addict.

Overdoses of other drugs such as heroin can be administered and injected in walk-bys in much the same technique as the knife. These drugs are available nearly everywhere.

A kitchen syringe that is used to inject butter and oils into roasts can be used to inject poisons such as black leaf nicotine benzene or kerosene into the subjects stomach.

An assassin can kill with the hypodermic syringe with a 20cc. capacity or more. The empty syringe is inserting into a vein and the air injected. This causes a bubble in the blood system resulting in death from embolism. A bicycle pump fitted with a syringe needle can pump air into the system in a

similar manner. This can be done if the subject is unconscious or under the control of accomplices.

Arsenic and thallium sulfate are common rat poisons and can be used in assassinations as well as the mercury from thermometers and barometers. Aconite and atropine are also effective.

If the subject is prone to use mouthwash, eye or ear drops, sulfuric or muriatic acids can be added into the bottles and the patent medicine taken out.

Poisons can be put into the foods and drink of the subject. Using poison toadstools in place of mushrooms is one example, cyanide in the drink is another. If the subject is using a taster to test for poisons he can be outwitted by putting the poison in the salt shaker. The normal scene is once the food passes the taster the subject then proceeds with his meal and normally salts to taste . . . !

Everybody knows about a Mickey Finn which is basically barbiturated booze, but the ice cubes can also be sabotaged by adding powdered glass to them before putting them in the fridge. It's impossible to spot the slivers suspended in the ice cubes and when the subject drains his glass he gets a mouthful of same. This creates havoc in the intestinal tract and death can result from internal hemorrhage.

The more esoteric poisons such as nerve gases like sarin are beyond the scope of this study and so are deferred. L.S.D. was, however, developed as a war gas and O.D.'s can kill and it can easily be introduced into a subject's meal through the sugar bowl or salt, or even from a Borgia ring into his drink; it is tasteless and fairly common nowadays.

Chlorine is a poisonous gas that is used in purifying the swimming pools that dot a lot of backyards. The trade chemicals that are added to the water contain the chlorine salts that can easily liberate the gas by doing the exact opposite of what the instructions recommend. The gas can be used against a sleeping subject and if possible from an upper floor so the heavy gas can work its way through the house. Household bleach mixed with vinegar will release chlorine gas too.

Phosgene is a similar gas and can be liberated by dripping carbon tetrachloride onto a hot plate or similar heated surface. It is an insidious poison that causes the lungs to fill with fluid and literally drowns the subject in his own juices.

Although not technically a poison but rather a chemical club, mace can be useful to the assassin who wants to get control of the subject before a fatal blow. It is essentially tear gas that has been added to kerosene causing the lachrymatory to be concentrated in the liquid and it attacks a defense

Kill

mechanism in the nose that causes the subject to go faint. It can be projected by aerosol or squeeze bottle and can be home-made.

Poisons, be they gases or drugs must be fatal, easy to administer, and easy to obtain. All of the ones mentioned here are common and can be found in the home as an insecticide or rodent killer, on the street such as hard drugs, or made up in a home lab, or prescribed by a doctor.

Poisonous snakes can be sent to the subject in a parcel and will bite him when he opens the package. The evidence slithers away.

Using snakes is killing at a distance similar to the use of bombs. The trouble with both methods is that it's not selective and must not be encouraged unless no other alternative is available. If it fails or kills someone other than the subject he is forewarned and alerted. This the assassin must not risk.

With poisons always give the double amount necessary to kill; this will insure that there's no chance of survival.

Used properly, poisons can be one of the most effective weapons in an assassin's armory. They're to be used in situations requiring quiet, rapid death.



tec
Ho
wi
As
ga
su
po
me



BAPTISM OF FIRE

Subject approaches. . .

With barbecue igniter between his teeth, the assassin drenches the subject in thickened gasoline.

LESSON EIGHT: FIERY RED

The use of fire as a weapon is not usually discussed in assassination techniques because it rightly belongs in the spheres of arson and explosives. However, a situation can be envisaged where the assassin plays the role of a window cleaner or a car washer along the route the subject is sure to pass. As the subject approaches the assassin grabs his water pail which is full of a gasoline and oil mixture and at the appropriate moment, throws it over the subject, drenching him. A match or lighter then need only be tossed into the pool to effect the instant immolation of the subject at his most unguarded moment.

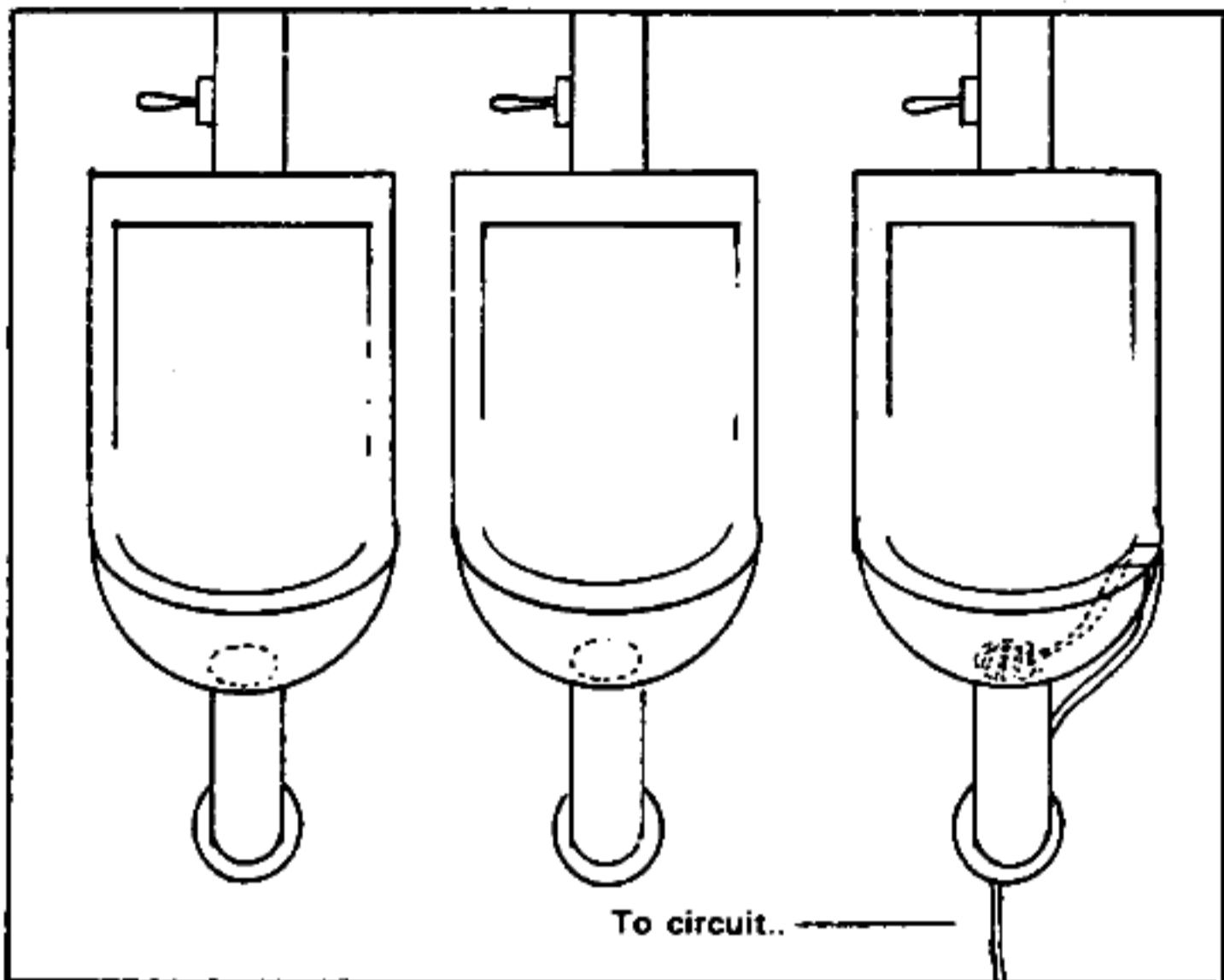

HOT WIRE HOOK-UP

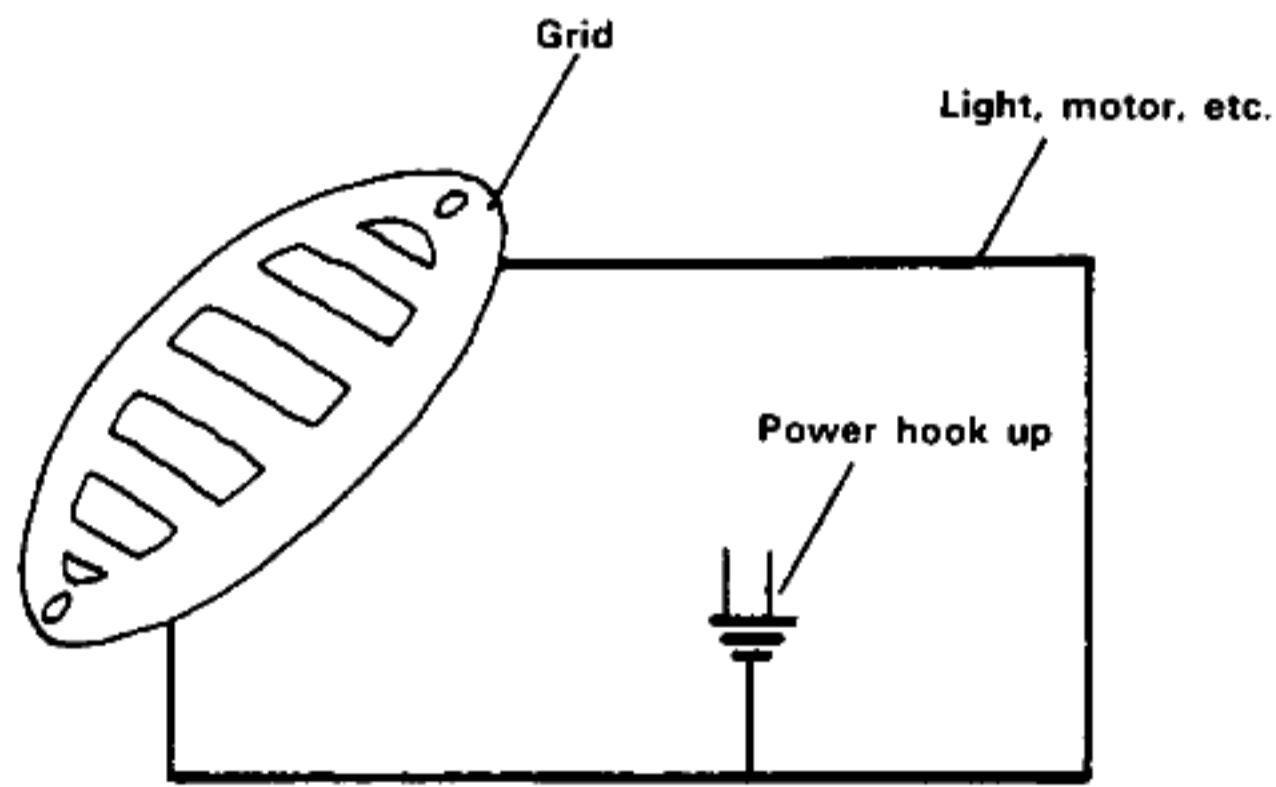

LESSON NINE: HOT WIRE

Essentially the weapon is an electrified grid in the urinal basin. This can take the form of a screen cover for the drain or a metal grill. If the urinal is porcelain completely the screen must be added by the assassin. The drain cover is connected to the electrical system of the wash room by means of an insulated cord that is hidden behind the plumbing.

What happens when the subject uses the urinal should be obvious now. The subject's urine which is a salty liquid and a perfect conductor of electricity, makes contact with the charged grid and the shock will kill him.

This system can be selective by rigging the circuit with a switch that you can control. The wiring need not be elaborate and can be carried in your pocket and be hooked up within a few minutes. Normal 110 volt current is sufficient because it is the amperage that kills. The only thing necessary to look out for is that the circuit is not grounded — except by the subject.

This method lends itself to be used in government or large public buildings.

BLANK

PAGE

LESSON TEN: SHOOT TO KILL

The final chapter in this study brings us to the use of firearms. I'm not going to go into much detail about what I feel, most readers should already know about firearms either through police, military, or hunting experience. How to handle weapons safely and the salient features of modern arms in general I expect you to know already.

It should also go without saying that the firearm is one of the assassin's most valuable tools in the trade of death. They are lethal, portable, and in some cases very quiet weapons that in the majority of missions the assassin will opt for.

Forget long-range shooting and concentrate exclusively on killing. This remark may sound facetious but the role of the assassin implies that he be able to get as close to the subject as possible, that he strike from short range, and that he inflict mortal injuries.

The range an assassin should fire his gun should be from less than five feet and no more than fifteen. Point-blank shooting being preferable to all else. Now long-range shooting is oft-times dictated but this is sniping and it's a different game entirely.

Remember always that it is the assassin's duty to kill and to be sure he's killed the subject he must be in a position where he literally can't miss.

Now the choice of firearm is also left open. The weapon must suit both the assassin and the situation. This can run the gamut from a sawed-off double barreled shot-gun to a .22 short stinger. The important thing is that the bullet penetrate a vital area and kill the subject. As a general rule you should use as heavy a caliber weapon as you can handle. For most of us this median will be either the .38 special or the 9mm. Weapons in this zone are the most adaptable to the exigencies which might arise in an assassination.

The targets are the same that have been mentioned all along: the head, spine, and heart.

A typical score would be to come up from behind, jab the gun into his backbone and fire at once. This will put him on the ground. Then shoot him in the heart by firing at it through his left shoulder blade. This will kill him. Now shoot him in the back of the head and this will kill him again.

Always, if possible hit two different combinations of targets, and all three to be sure.

A single shot weapon like a shotgun should be directed at the throat or back of the head — decapitation again is the intention.

Kill

There must be no hesitation when using the gun. The moment it is brought out of its concealment it is put into action immediately. The old gunslinger adage, "bring it out fast and put it away slow" is as true now as then. Use both hands to control and steady the gun, keep both eyes open, align the weapon and fire. This whole process should take only fractions of a second.

Consider that if the weapon is used on a muzzle to skin basis the sound of discharge will be considerably reduced. Another method silencing the report is in the situation where the subject is under the control of accomplices or rendered unconscious, is to jam the muzzle up his rectal orifice and fire the weapon. Apart from being virtually silent the cause of death is not immediately apparent to the examiner of the corpse, and indeed if a plastic or fibre-glass bullet were used it wouldn't show up on X-ray.

In some cases the assassin's weapons should be sanitized or else home-made because the possibility of tracing the weapon is nil. These special weapons should be smooth-bore to thwart rifling tracing and also to encourage the bullets to keyhole through the target.

Without getting too deeply into the realm of the bizarre, a specially loaded bullet made from a human tooth (bicuspid) could be fired under the jaw or through the mouth into the head. The tooth is a very hard bone and its enamel shell would allow it to penetrate into the brain. The intention here is also to hide the cause of death because the examiner in his search for a projectile will disregard bone fragments.

Dum-dum, hollow-point, and explosive bullets should also be considered as well as aluminum bullets which have an affinity to germs due to the porous nature of the metal. (For this reason wounds caused by aluminum fragments are always the last to heal and are prone to infection.)

Silencer equipped firearms have a special place in the assassin's arsenal. Because they dampen the muzzle flash, the investigator will have trouble trying to gauge the distance the weapon was fired from due to the silencer's effect on powder burns. That a silencer also reduces noise is so obvious that it need not be commented upon here at any length. These attachments have the quality of reducing recoil and so increasing accuracy. The assassin should never hesitate in using a silenced weapon in preference to its loud-mouthed brothers.

Another attachment that is home-made and useful where a muzzle to skin hit is envisaged, is the bell reducer used in plumbing fixtures. This can be threaded to the muzzle of the weapon and a steel wool pad is inserted into the mouth of the bell. The weapon so equipped is pressed against the target and fired. The subsequent noise of discharge is drastically reduced. Firing

into the chest is even more effective because the chest cavity itself becomes an expansion chamber, while the bullet penetrates the heart.

One of the best visual representations of an assassination that I've ever seen is the shooting of Lee Harvey Oswald by Jack Ruby. Ruby was strictly pro in that photo showing him pumping bullets into Oswald. One should note that the left hand is drawing back the jacket and the gun has no sooner cleared leather than it starts shooting. The grip on the gun is also interesting and further backs the suspicion of Jack being a pro. He's using his middle finger to squeeze the trigger and his index finger, the normal shooter's trigger finger, is pointed right at his target. He shoots where he points. This method is not too well known in the States but the method was SOP with wartime SOE and SIS agents of Britain. Another method advocated by them was the stamping of the right foot and thereby lunging forward and firing at the same time two shots in rapid succession at each target that presented itself.

It is worth considering the carrying of a backup weapon should the first one fail or if the bullets have all been fired. Learning to fire them both at the same time, as well as using your weak hand, also can double your fire-power in an emergency. The best way to accomplish this is after you've drawn your pistols, cross your wrists and have right wrist rest on top of the left wrist and the left or supporting wrist is pressed against the right. The aim is dynamic tension and will add to the overall support of both weapons. By crossing the wrists the weapons automatically become centered with your body and where you direct your body the guns will be directed there too. Remember that this method is only for use at close ranges otherwise the lateral dispersal will be too great for accuracy.

All this talk about technique is really not necessary, what is essential is that the weapon be brought out quickly, pointed, then fired. Some special weapons are already out because they're disguised or shielded from the subject's view and need only be pointed and fired. You should neither see the sights nor be conscious of them. The weapon must be a natural extension of your arm: look at where you're going to shoot and think the bullet into the target. (The will to kill, the complete lack of sympathy and compassion, and no hesitation in killing the subject is paramount. You must take his life as detachedly as you might swat a fly or crush an ant.)

I'm not going into the intricacies of long-range sniping, as distance is a mental buffer between the sniper and the subject and the attitudes required are also different. The sniper doesn't have to see, smell, or taste the blood of his subject and he doesn't need the killer instinct to the same degree as the close-up assassin.

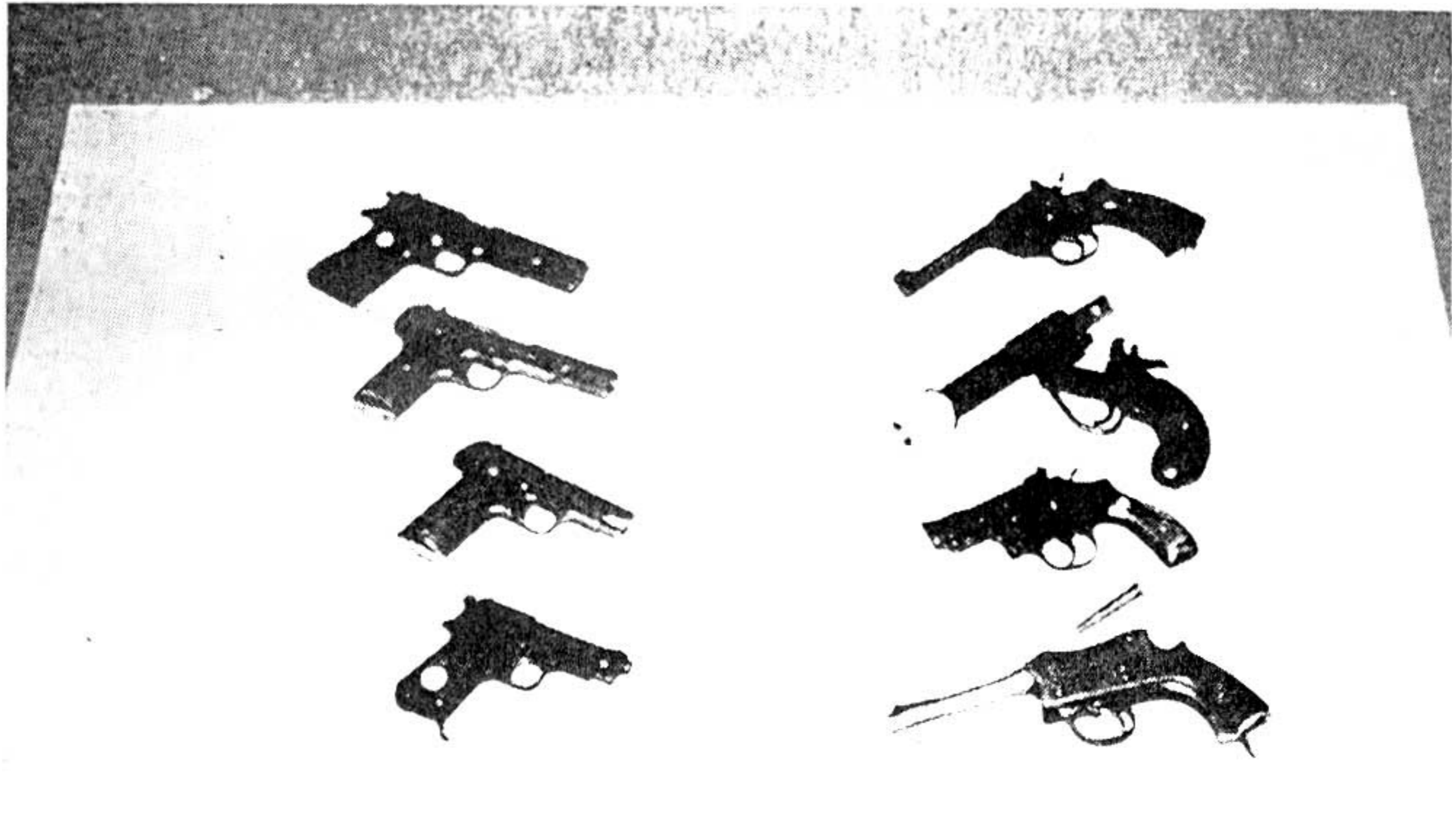

13

CLOSE COMBAT PISTOLS

Top to bottom left to right i 45 Auto ii Tokarev iii Astra iv Beretta v Enfield 38 vi 12 ga flare gun conversion vii 357 magnum viii 303 cal martin action pistol

Kill

The sniper must be accurate with his weapon. He has 216 sq. in. of target to hit to be in a lethal or seriously injurious area. This is basically the central zone from the top of the head to the groin, (36 ins.). The zone is roughly 6 ins. wide on a normally statured subject. The direction the subject is facing has no tangible effect on these figures.

The weapon should be suppressed (silenced) to allow for follow-up shots. The choice of weapon, ammo, and sights is left to the sniper-assassin's discretion as the circumstances for job will be varying.

In assassinating higher echelon VIP's it is often necessary to consider the use of armor-piercing bullets due to their penchant for armor-plated cars. They also would come in handy for penetrating the human shields of the dignitary or any other unfortunate that might step between you and the subject. The 30.06 AP would be a standard but the 2130 gr. 20m.m. AT Lahti should be considered.

The best place to hit a subject in such a vehicle would be at the turns which cause the inside escort to bunch up and the outside motorcycle escort to spread apart. Your position is on the outside flank. You should fire as the car slows for the turn. If you miss, reload and fire as it's turning. If you miss again you might have another chance to fire before the car picks up speed.

The sawn-off double barrelled shotgun is not often considered for assassination work but a 12 ga. side-by-side or over-and-under loaded with two number 1 buckshot cartridges will put 32/30 cal. pellets into the air; which is what most S.M.G.'s can do in full-auto. At the ranges mentioned with the handguns, the shotgun is truly an effective weapon. Normally the barrels are cut off just in front of the forestock and a vestigial butt remains just behind the pistol grip. The weapon is taped, or strapped to the fore-arm at this point and an overcoat with the right pocket removed is worn.

The shotgun is held under the coat and against the leg. The coat is unbuttoned. When the subject is in position the snout of the barrels pushes the coat open and the left hand comes up for support. Both barrels are discharged in quick, almost simultaneous action. They immediately go back under cover.

To put sugar on the frosting, strychnine pellets can be loaded with the buckshot. As it is poison that speeds up the system it will effect an even greater blood loss than can be expected from the buckshot pellets themselves. Like I say, it really isn't necessary.

In the world of assassination there is no such thing as over-kill. If you're sure the subject is dead, shoot him again and be dead sure. You are not a soldier who's job it is to put the enemy out of action. Your job is to destroy the subject completely. He is to be terminated with extreme prejudice. . . .
.KILL WITHOUT JOY!

BLANK

PAGE

APPENDIX A: THE SIGNS OF DEATH

(before rigor mortis)

i/ Lift the eyelids and the eyes will be rolled back and the pupils will not respond to the light.

ii/ Mirror Test: Place a hand mirror in front of the mouth and observe if any fogging takes place. A small feather held in front of the mouth will indicate the absence of breath.

iii/ Pin Test. A pin thrust into the skin and withdrawn will leave a hole. In live tissue the hole will close, not so with dead.

iv/ Feel for pulse. . .none.

v/ Stethoscope for heartbeat, there should be none.

BLANK

PAGE

APPENDIX B: YOUR FIRST

While it is true that the writer has taken a lot for granted in what he expects from the reader when it comes to killing, the student must nonetheless steel himself for act of killing.

Unless you're a fool you're going to be scared. Your hands are going to sweat — dry them. Your knees are going to knock — brace them. Your stomach is going to be queasy — this is caused by your diaphragm falling on it making you want to vomit and have butterflies. It can be controlled by thrusting both hands under your rib cage and lifting it off your stomach. Take a deep breath and still clutch the diaphragm and bend over. Straighten up and the diaphragm should be back in place and a lot of your fear will have left you. If it comes back, repeat. One of the biggest problems is holding your breath on approaching the subject. You must make every effort to breathe deeply and naturally. Your flushed face might well alert him, or if your approach is from the rear you might act impulsively, at the wrong moment because you want to get it over with. Take a deep breath and mouthe a silent yell. This will cause your fighting hormones to come into action, flex your stomach for energy, and increase your oxygen intake. It will also release a lot of your anxieties and tensions prior to the hit.

When you spot the subject be sure he's the man you've got to kill. Mistaken identity is common-place. When you do kill, by whatever method, be swift. There is no reason why the subject should be placed in agony. When you are assured he's dead, take a moment to clean up, check the area for incriminating objects. Nothing attracts attention more than speed so move away from the area in a calm, controlled manner. Proceed to your ex-filtration point.

The foregoing was for the unique case of the one man mission. In general assassins operate in teams of two, possibly three individuals. One to kill, one to cover, and one to transport.

BLANK

PAGE

APPENDIX C: SPECIAL WEAPONS

SOE LAPEL DAGGER

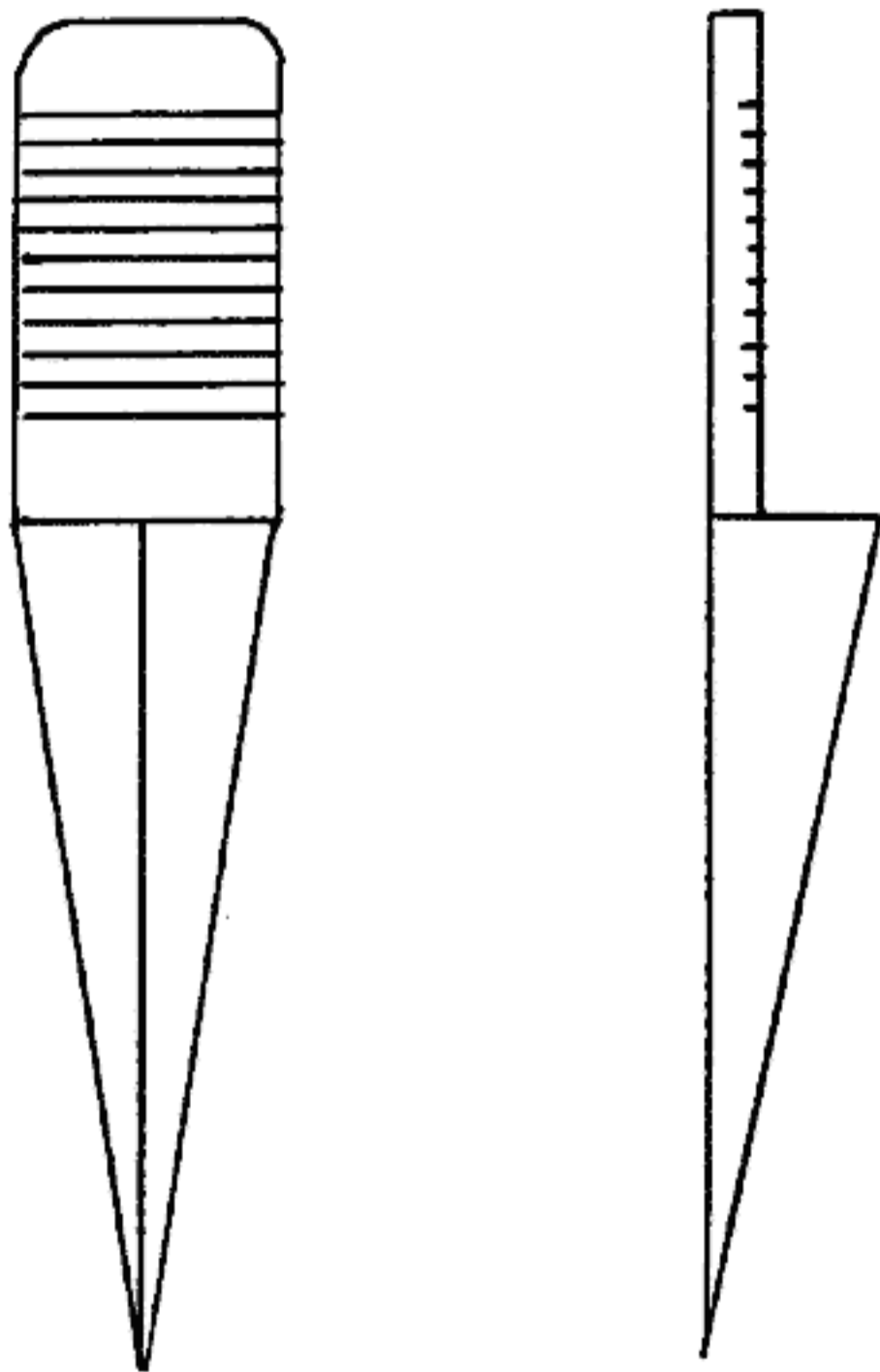

(actual size)

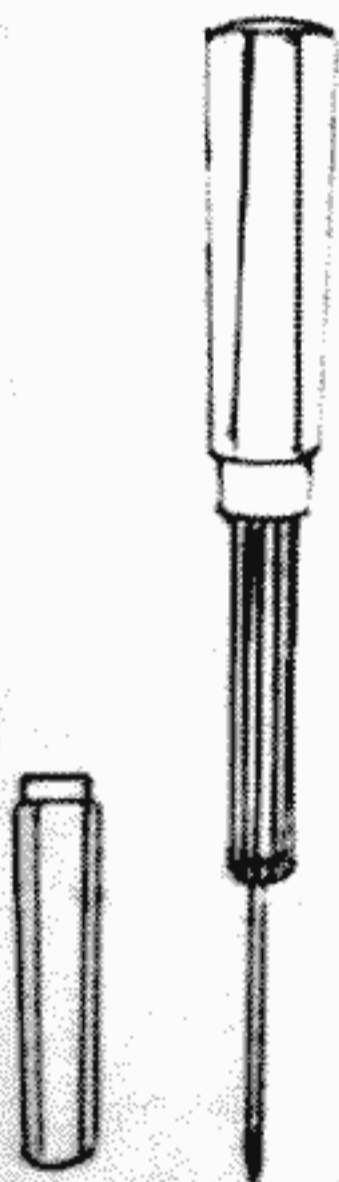

Cooking syringe can be filled with a poison and stabbed into the stomach of the subject

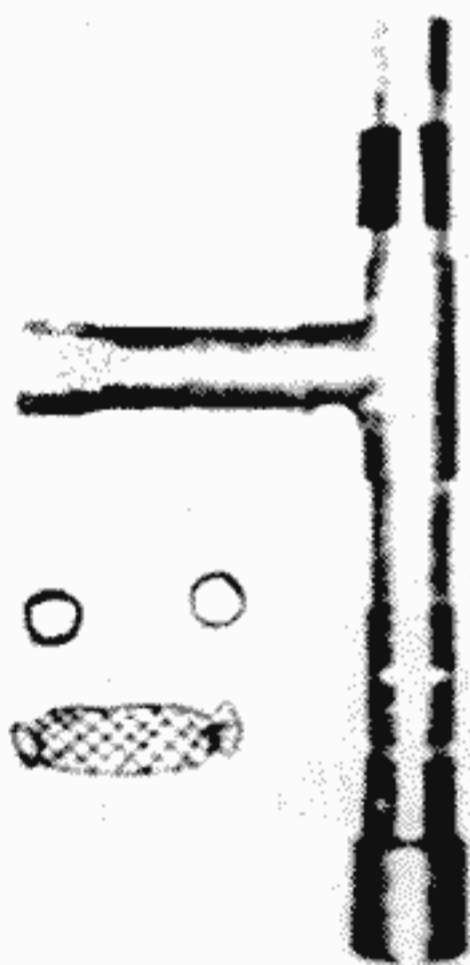

M V D cyanide gas pistol with sodium thiosulfate tablets, and amyl nitrite inhalant.

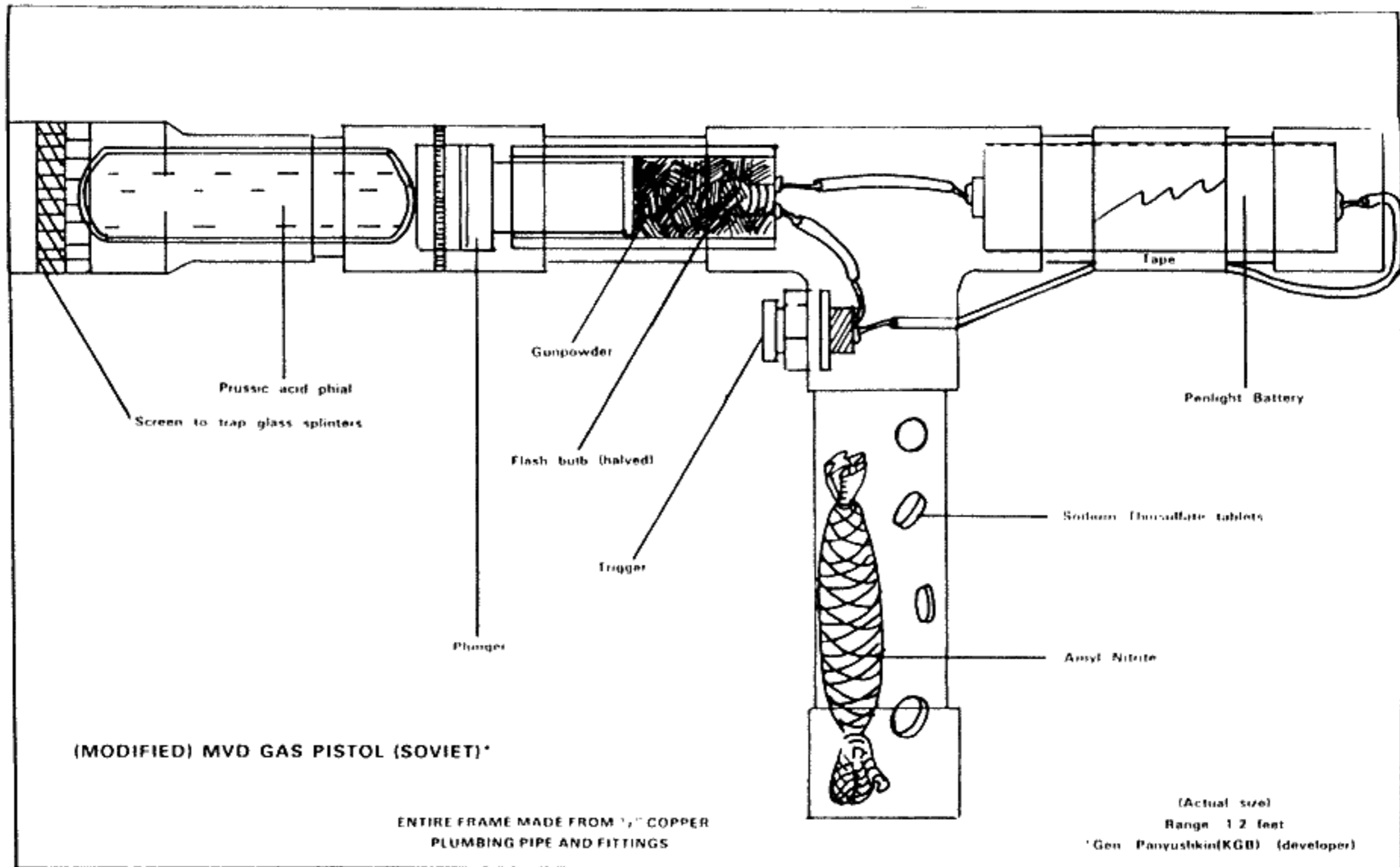

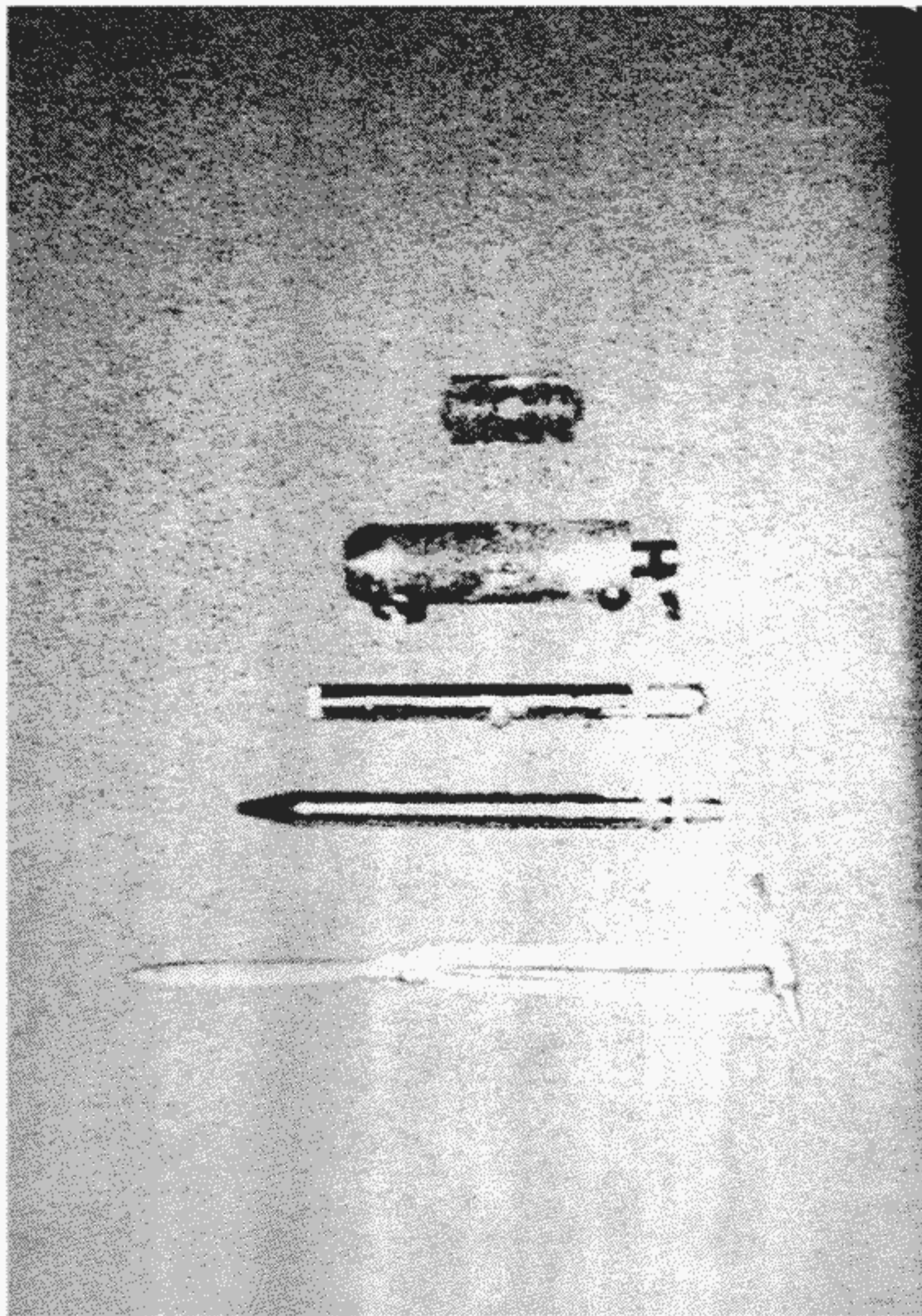

CONCEALABLE WEAPONS

top to bottom i Razor blade ii .22 firing device iii .22 cal stinger iv .22 cal dart projector v Balisong ball-point

BLANK

PAGE

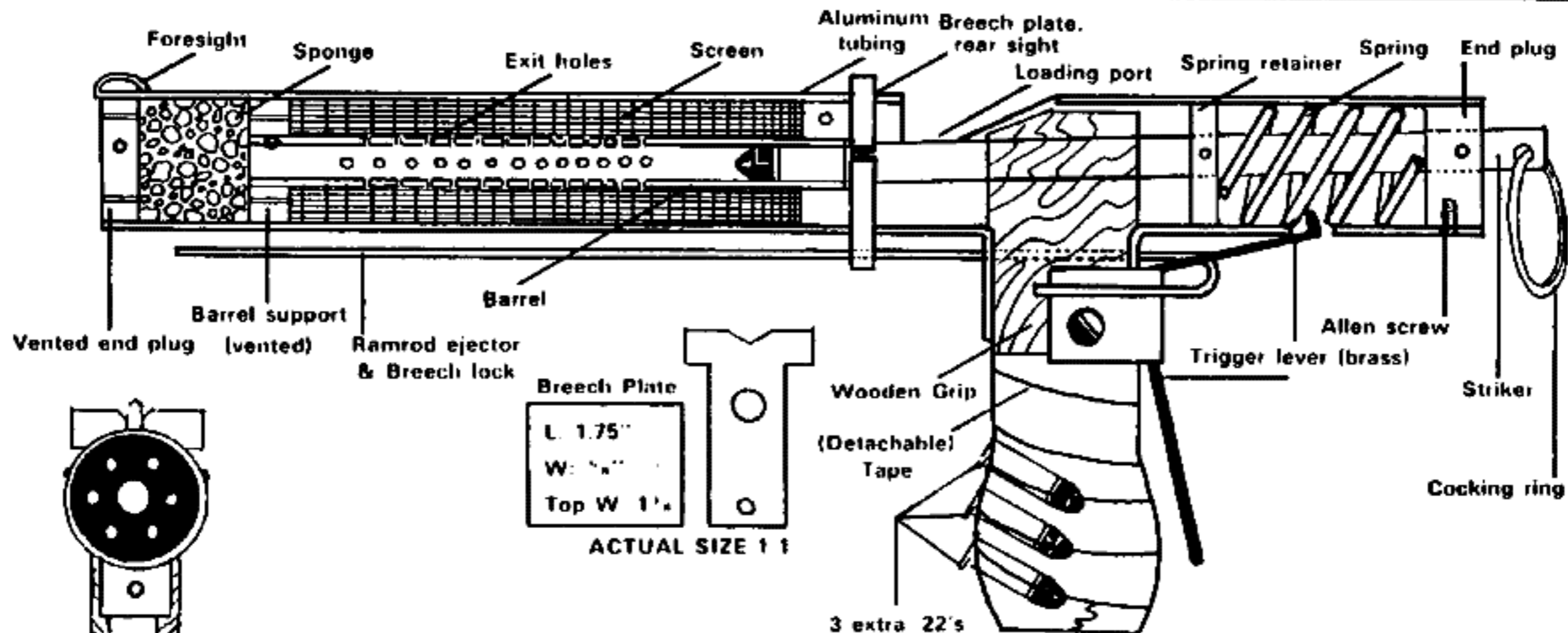

LIBROD PISTOL

Specs.

L: 12.5"
 Dia: 1.25"
 Wt. 15 oz.
 Exit Hole: 3/8"
 Firing Pin L: 6"
 W: 5/16"

Allen Screws: 8/32"
 Vent Holes: 1/8"
 Grip: Piece of
 hockey stick.
 Detachable
 when ramrod
 removed.

9 MM WATER-PIPE SILENCED PISTOL

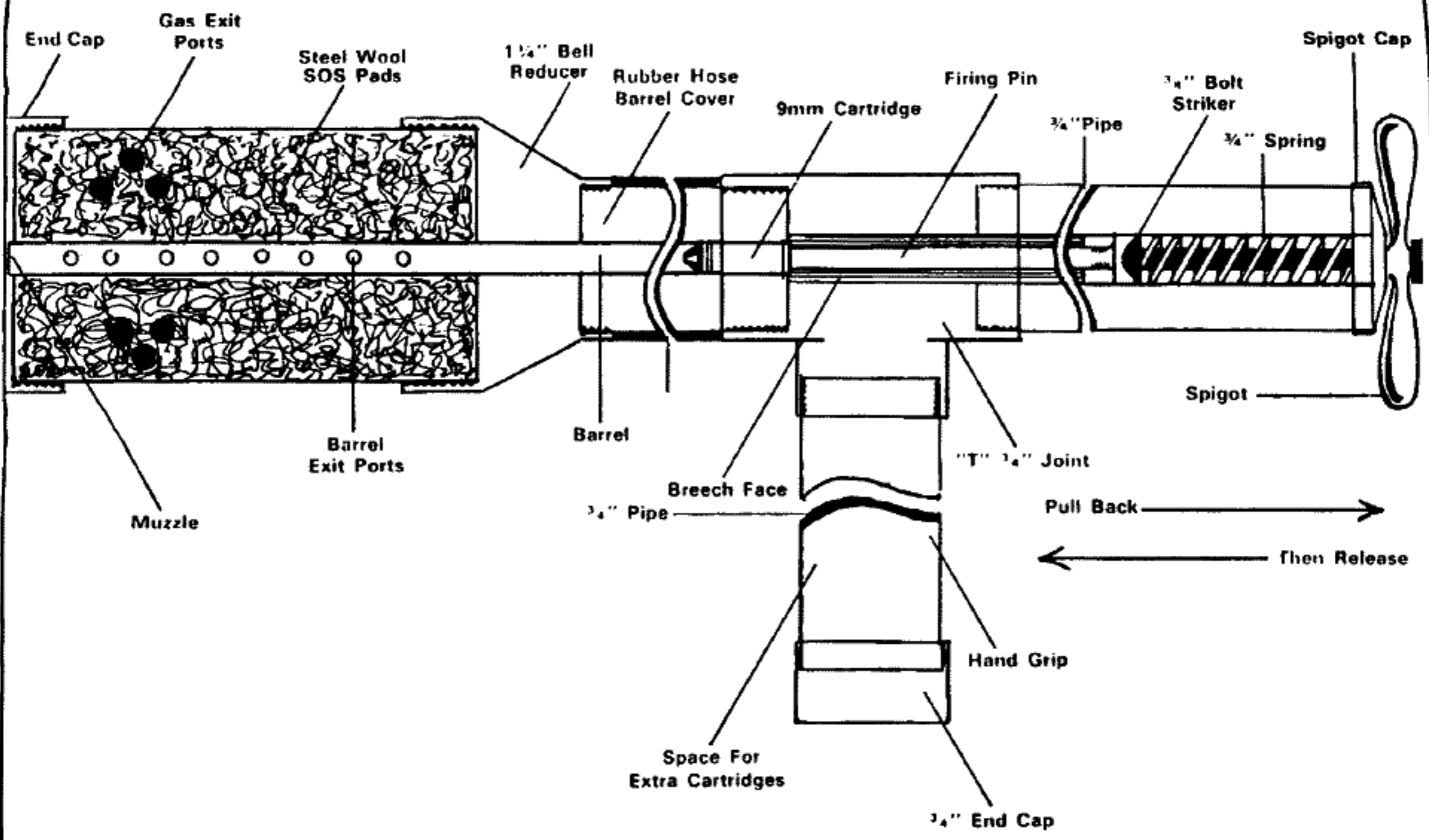

NOTES ON THE (9 MM) WATER PIPE MODERATOR AND PISTOL:

There are several good features about this pistol.

First, cost: Approx \$3.00 if you don't have the parts at home.

Second: simplicity: It was made with a 1/4" drill and a hacksaw.

Third, it cannot be traced. The parts can be assembled; the gun fired, then stripped and used in your plumbing or thrown away. The barrel is not rifled so the bullet has no traceable grooves on it.

Fourth: Even in its assembled mode it just looks like a piece of special plumbing it might even get unnoticed in a casual search.

It is strictly a crude close quarter weapon. It kills just as good as the best of them. One man's pipe dream becomes another man's nightmare.

9 mm Silenced Water-Pipe Pistol

Part	Function
1 six inch x 3/4" pipe	Spring housing
1 3" x 3/4" pipe	Hand Grip
1 3" x 3/4" pipe	Barrel Shroud
1 3/4" "T" joint	Breech, Striker, Hand Grip Housing
1 6" x 1 1/4" pipe	Moderator Sleeve
1 3/4" to 1 1/4" reducer	Moderator Cap
1 1 1/4" end cap	Moderator End Cap
1 3/4" pipe spigot	Pull Striker Release Handle
1 3/4" spring (5 in)	Main Spring
1 3/8" x 5" boltiker	
1 5" nail	Firing Pin
1 I.D. 3/8", O.D. 1/2" 10 inch pipe	Barrel
6 S.O.S. Pads	Baffle Gas Dissipators

When fired in small room the noise was loud but not unpleasant. No sharp crack or booming report. People in next room weren't sure what they heard. People concentrating on something else at the time didn't hear anything. When questioned about the noise said "What noise?".

Overall length 20 ins. It was made long to offset the weight of the moderator, being equally balanced and heavy, recoil slight.

Weight 6 lbs. (makes a hefty club)

Fires one shot at a time, each shell must be ejected by means of a wire rod pushed down the muzzle (a la Liberator).

Firing is accomplished by pulling on the spigot and releasing it, this drives the bolt against the firing pin nail, detonating the cartridge. The barrel is wedged into the barrle housing by putting it into a length of garden hose and jamming them both into the housing, this also serves as a gas tight seal. The Safety is in the spigot. The spigot is threaded to the 3/8" bolt by winding it up the bolt is drawn away from the firing pin until it's time to fire. There is a breech face composed of an outer layer of 3/4" pipe an inner layer of 1/2" lead pipe and a metal rod drilled to accept the firing pin is sweated into the half inch pipe. This is flush against the base of the 9 MM case.

EXODUS

by
L.Uksis

16 SHOT .22 CAL VOLLEY PISTOL
(TOP PLATE REMOVED)

Mock Pocket Novel
cover on outer
plate

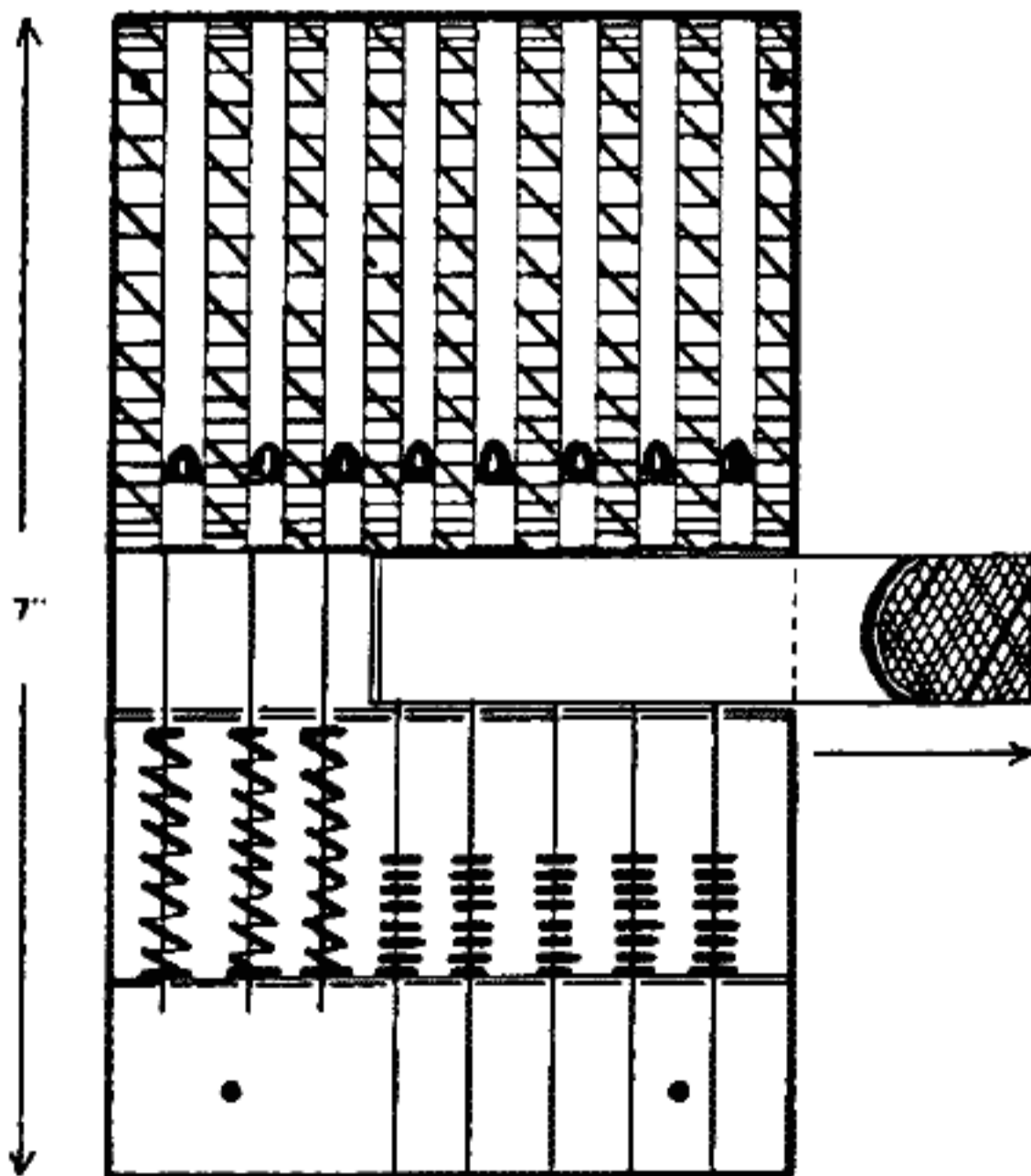
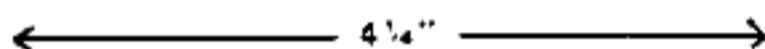
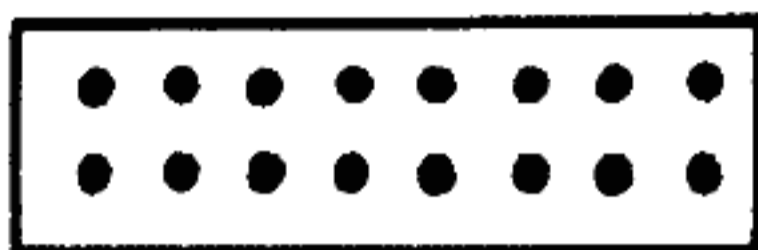
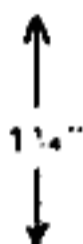
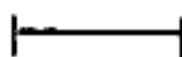

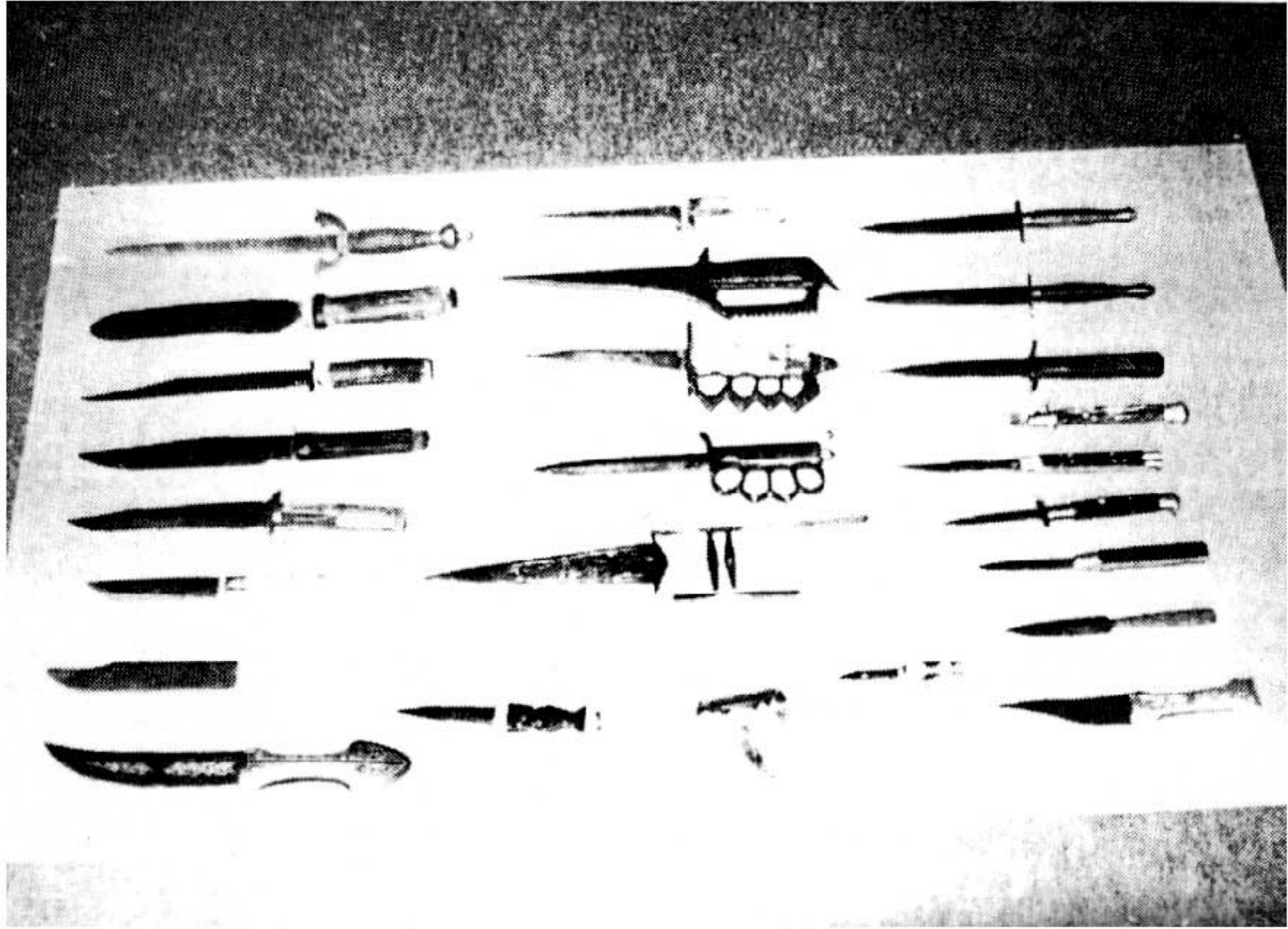

COMBAT KNIVES:

Top to bottom, left to right

- i Traditional dagger, European x Afgan dagger xvii F. and S. Com-
mando dagger
- ii Fighting knife War of 1812 (British) iii American Bowie iv Modern
fighting Bowie v Folding, Indian Bowie type vi Russian (Uzbeki)
dagger vii Cuban Bowie viii Arab Jambiya (Tunisia) i Sliver o'
Steel xii Male opener xiii Trench knife xiv Kator (India) (push
dagger) v Throat cutter gauntlet knife ix Skean dhu (Scots) xviii F.
and S. Commando dagger xix German Commando dagger xx Switch
blade xxi Balisone (Philippine) xvi Collar knife xxii Switch blade
xxiii Switch blade xiv Boot knife xv Jambiya (Arab)

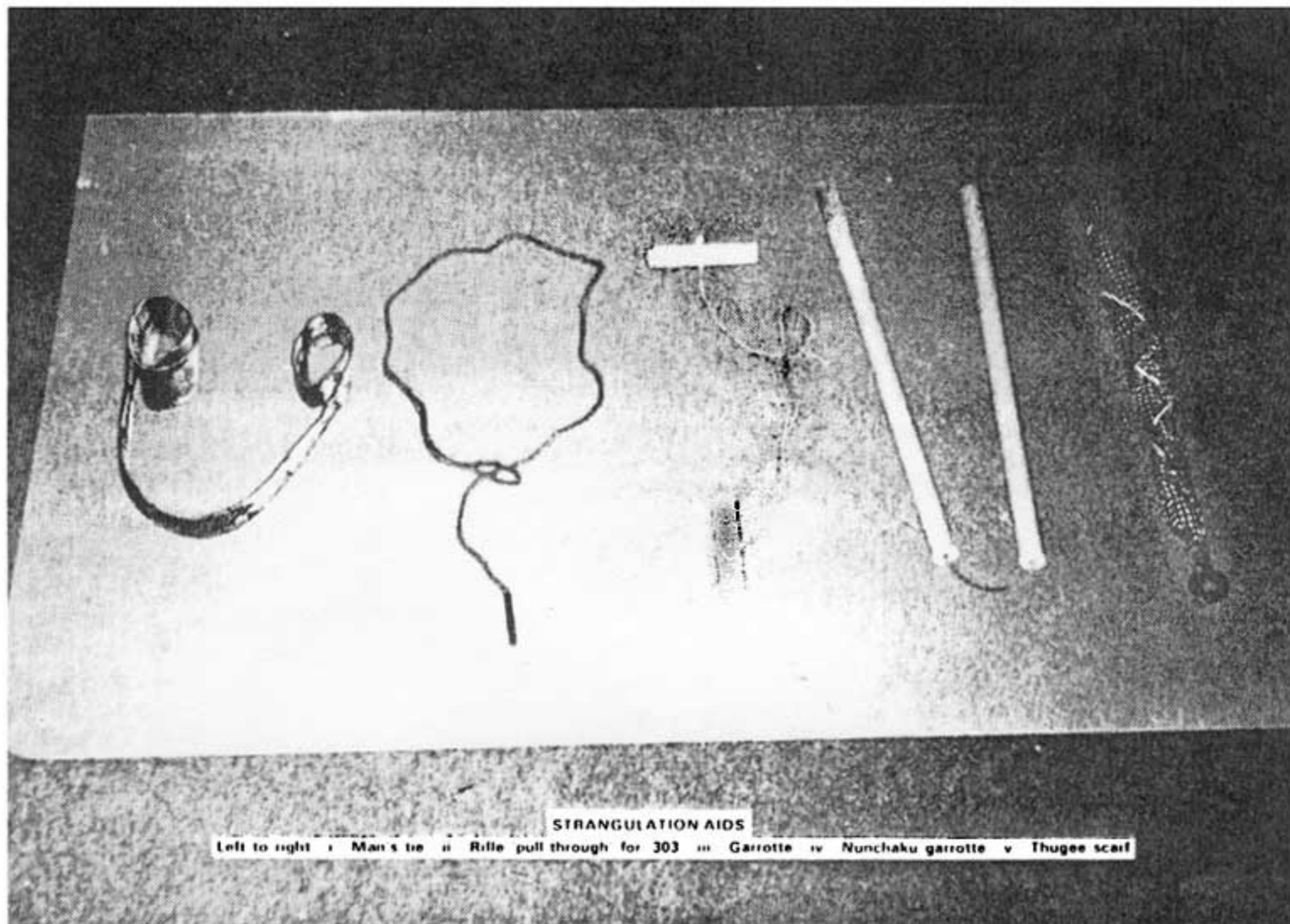



Throat cutter Gauntlet knife —Germany, Austria

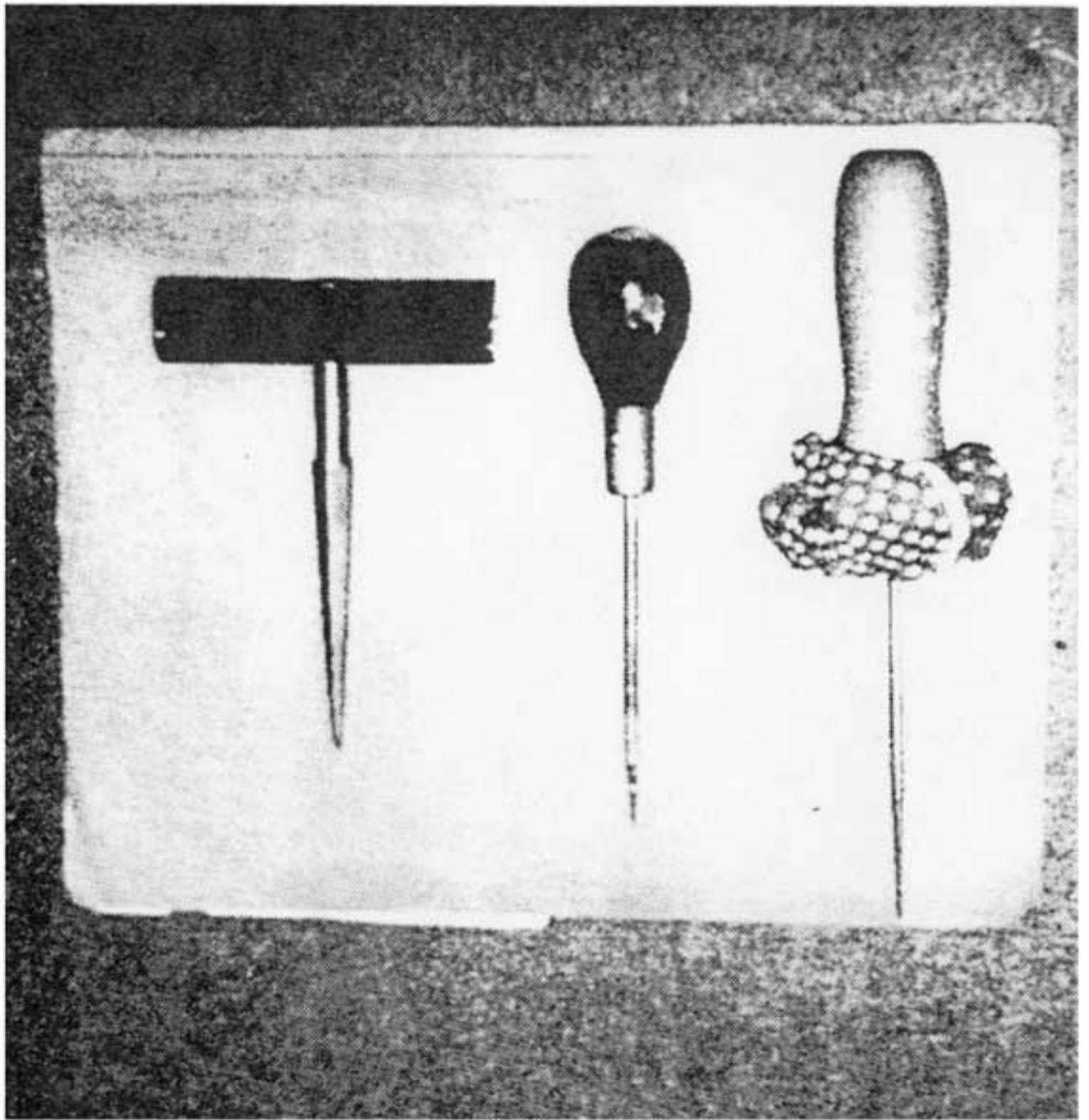

Piercing implements for attacking, spinal cord, heart, eyes and ears to the brain. Left to right i Sharpener reamer (push dagger) ii Awl iii Ice-pick with blood arrestor

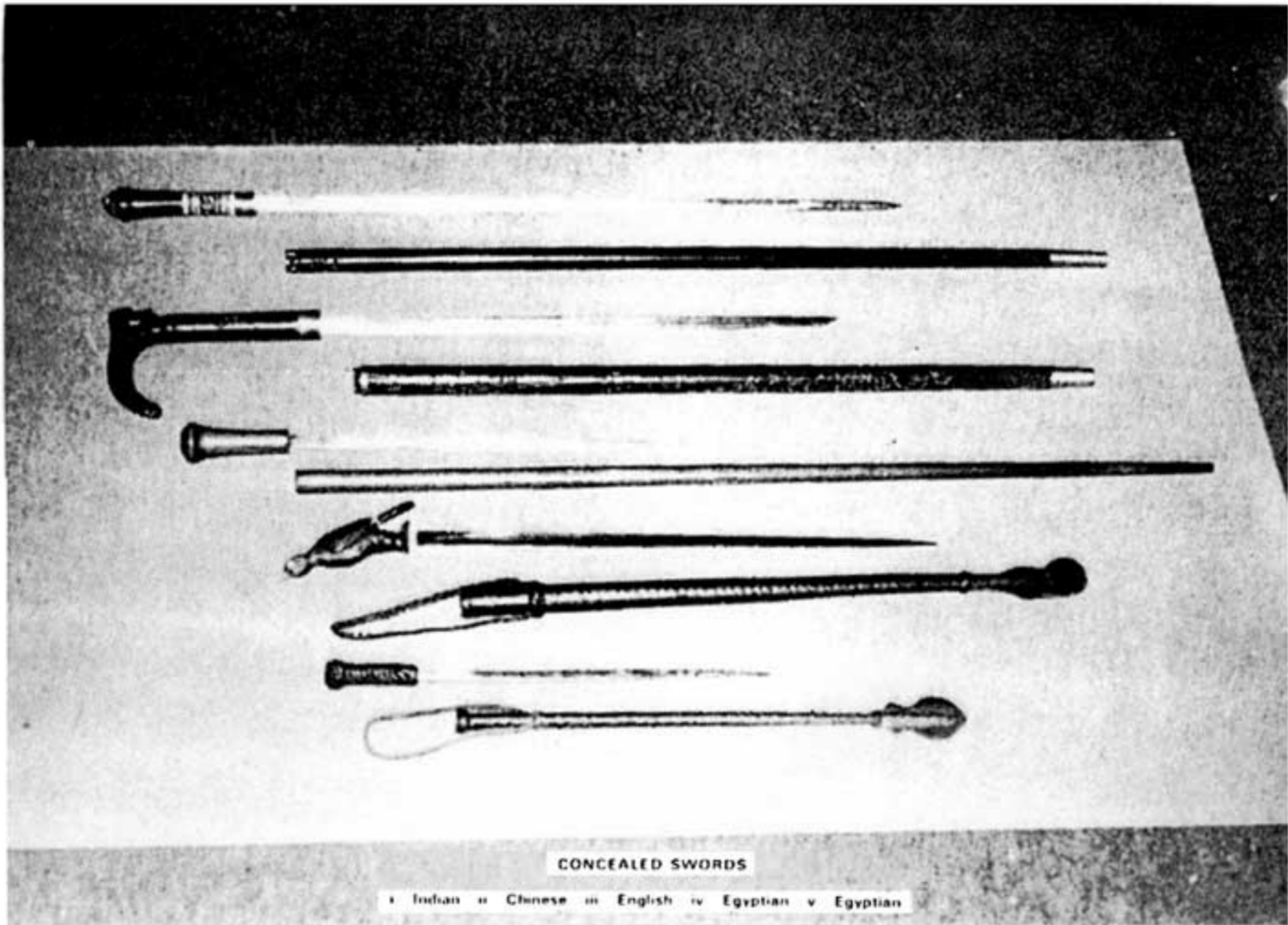

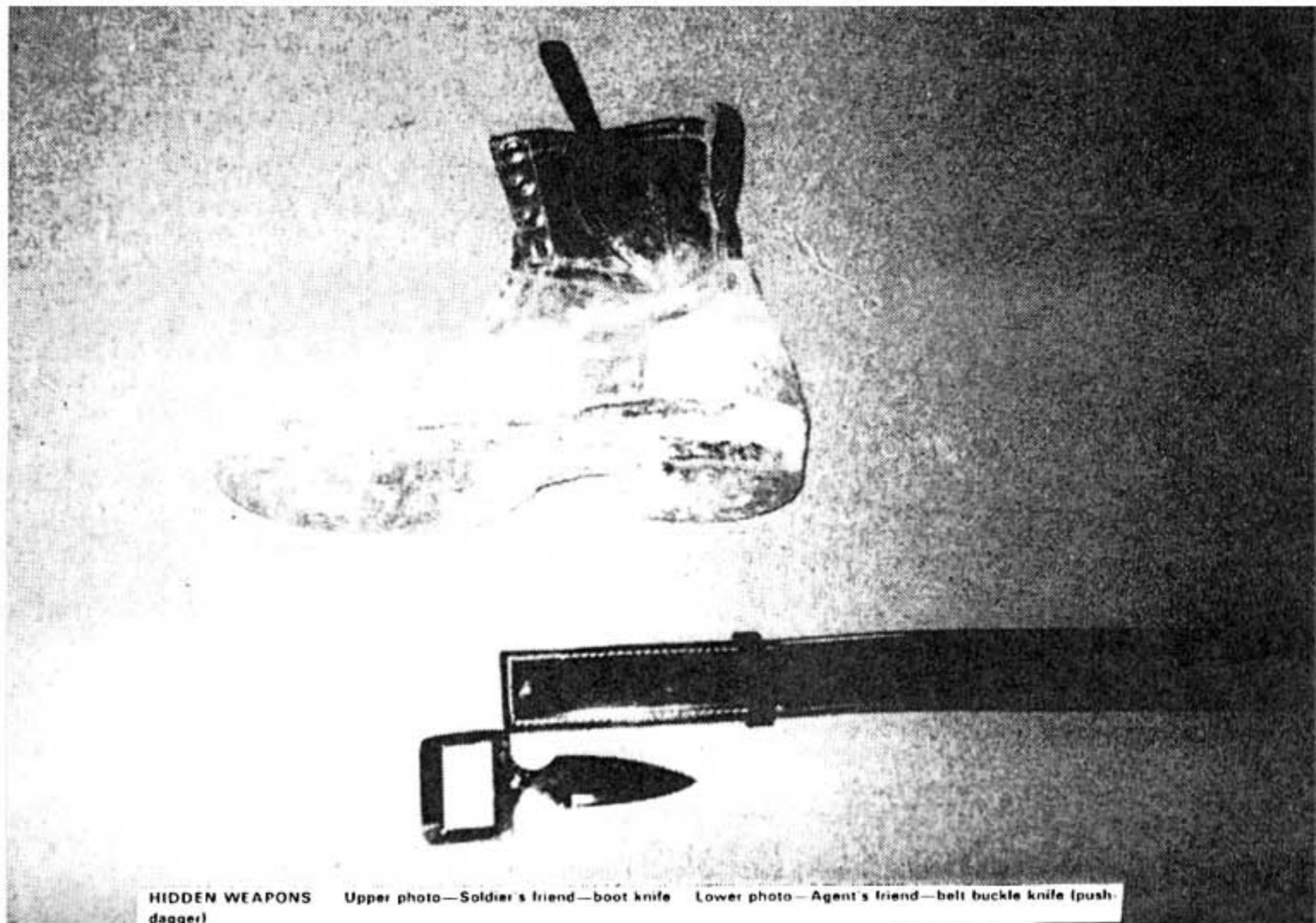

HIDDEN WEAPONS
dagger)

Upper photo—Soldier's friend—boot knife

Lower photo—Agent's friend—belt buckle knife (push-



A Borgia ring with poison inside-lid up: ready to pour

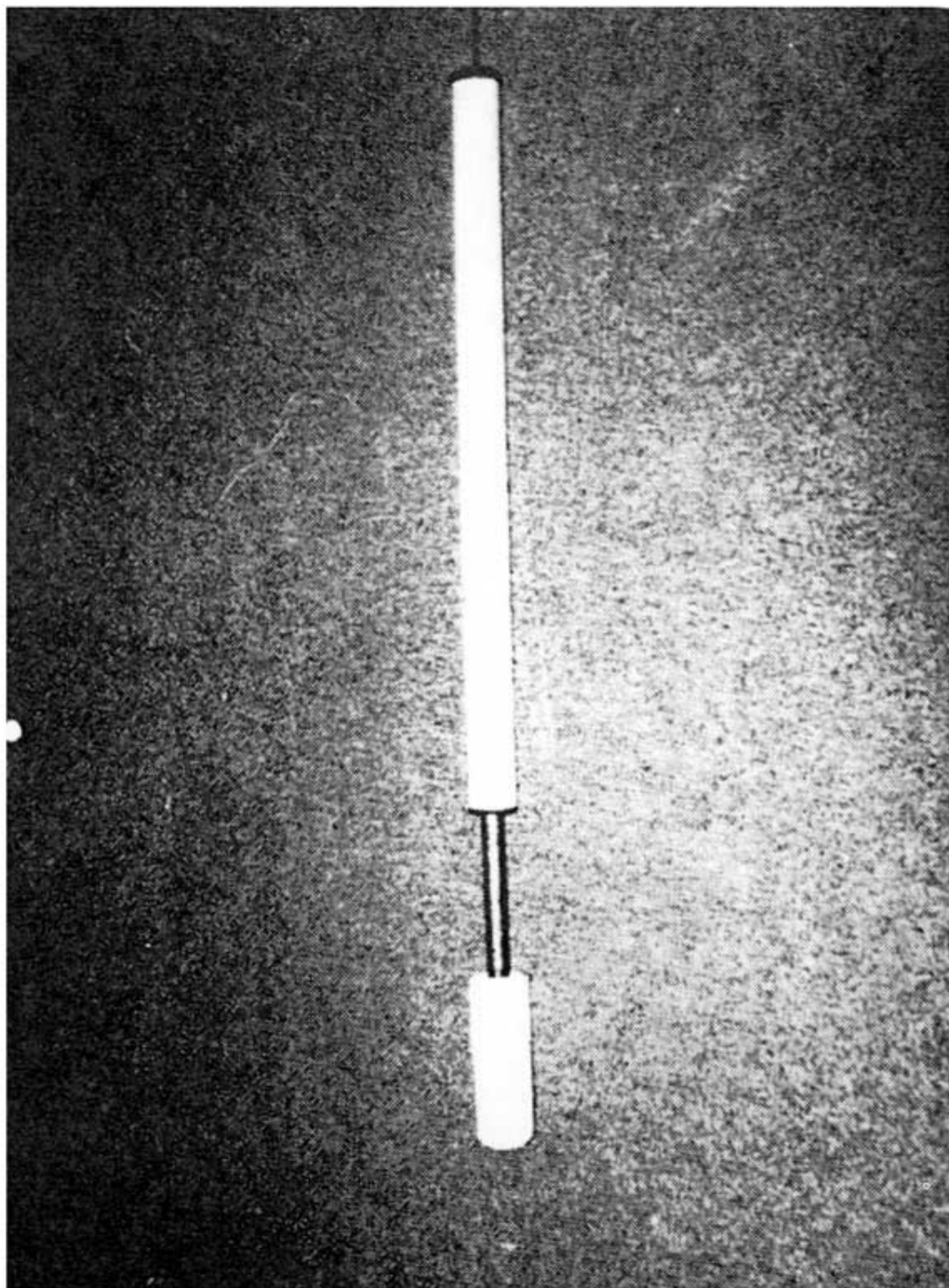

Bicycle pump hypodermic.



SILENT PISTOLS Top to bottom i Librod 22 cal ii PPK .22 cal with Parker-Hale moderator iii Cut-down .22 rifle with bell reducer (point blank) silencer-muzzle to skin

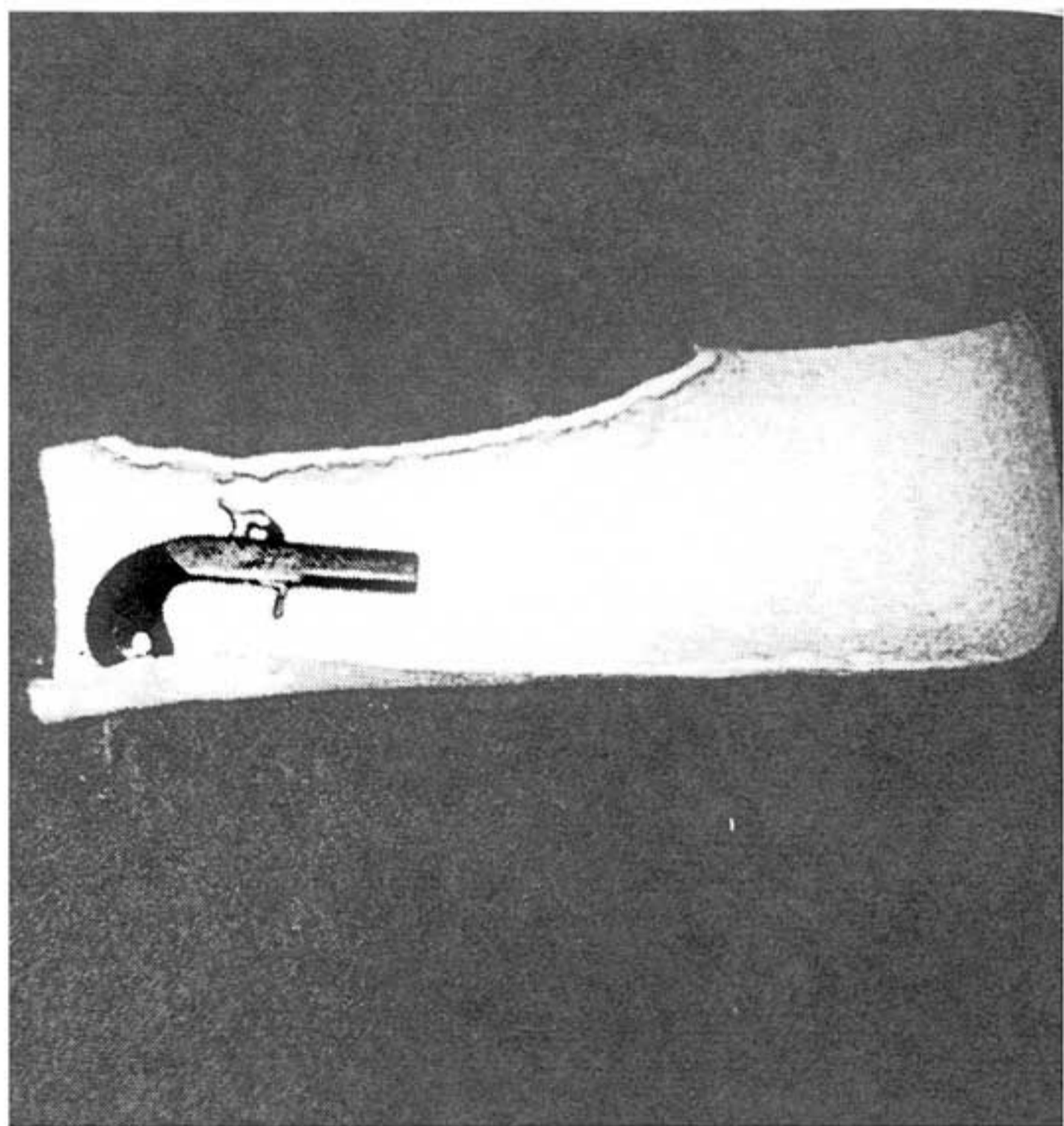

44 Derringer hidden inside an arm cast

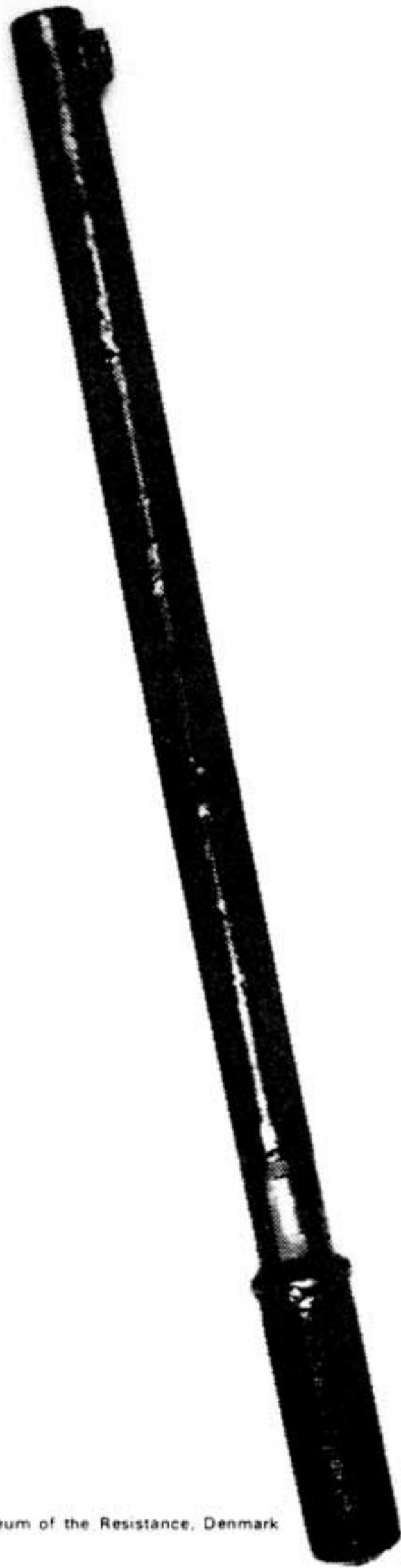

9mm bicycle pump gun. Courtesy Museum of the Resistance, Denmark

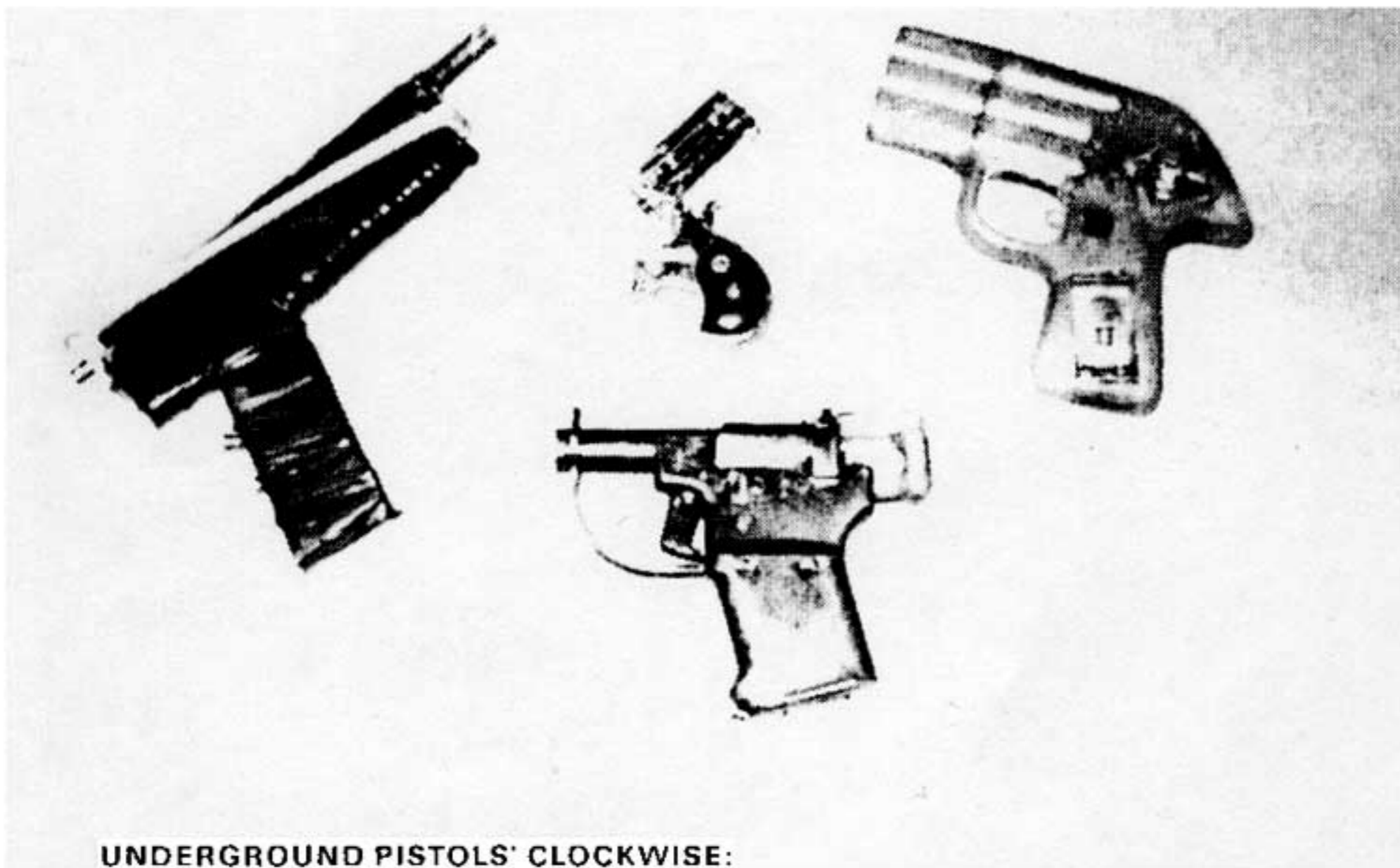

UNDERGROUND PISTOLS' CLOCKWISE:

- i .22 cal Zippgun ii .22 cal toy gun conversion iii Copy of Soviet Troika: three shot (30 cal) pistol. Electric firing, multiple selective, fires 1, 2, or all three chambers at once depending on setting. Barrels and components under plastic receiver-non-ferrous parts, (low magnetometer reading).
iv O.S.S. Liberator .45 cal. s/s.



HOME MADE WEAPONS Top to bottom.

i 12 ga. guerrilla musket ii .45 cal/.410 Walking stick iii 12 gage assault shot-gun note explosive ammo

All the above weapons made from common parts and materials such as 3/4 in. pipe for shot-gun barrels, plumbing fittings, table legs, nails, etc.

Type ii and iii operate on the trombone principle where the barrel is telescoped backwards sharply against a fixed firing pin.

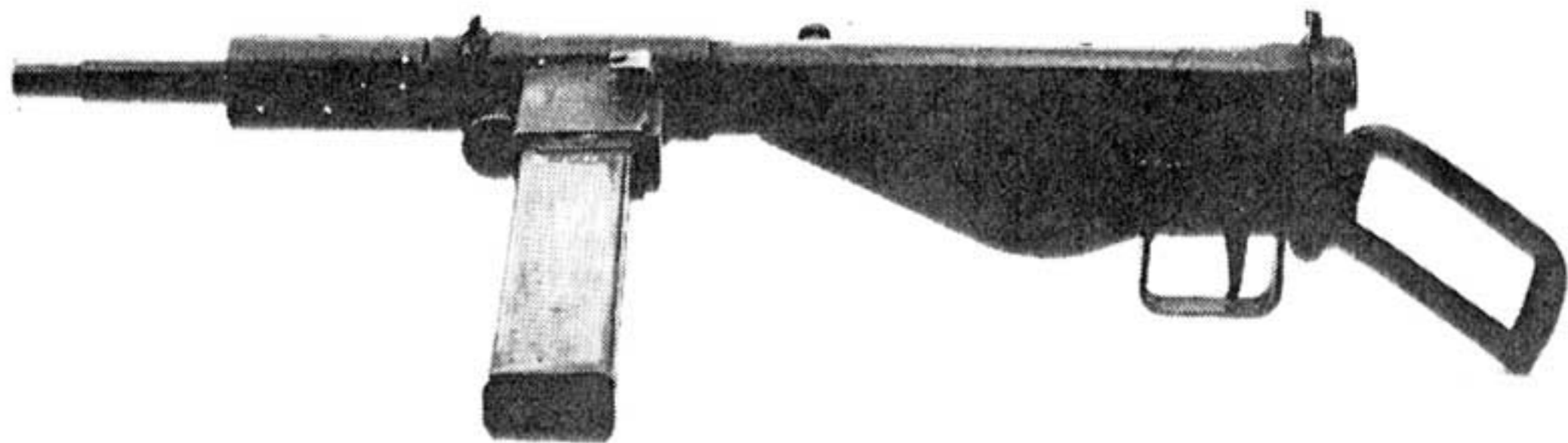

9mm homemade Sten courtesy of the Museum of the Resistance

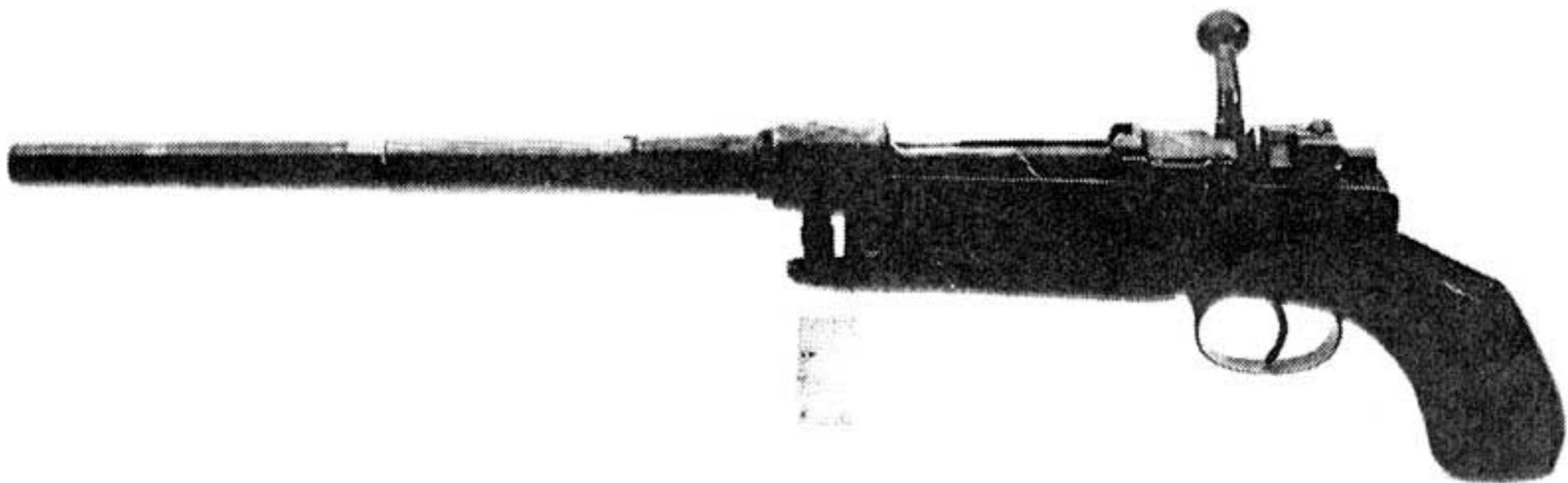

Cut-Down Mauser. Courtesy of Museum of The Resistance

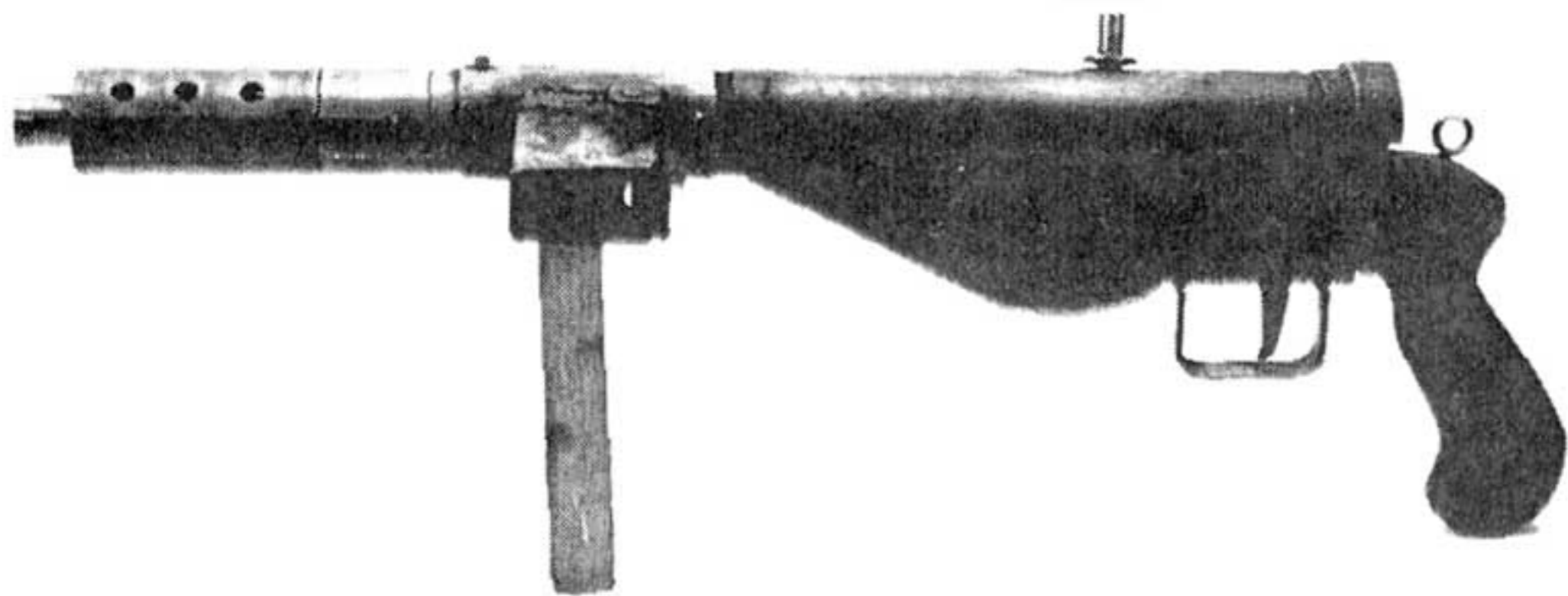

9mm home made Sten courtesy of the Museum of the Resistance

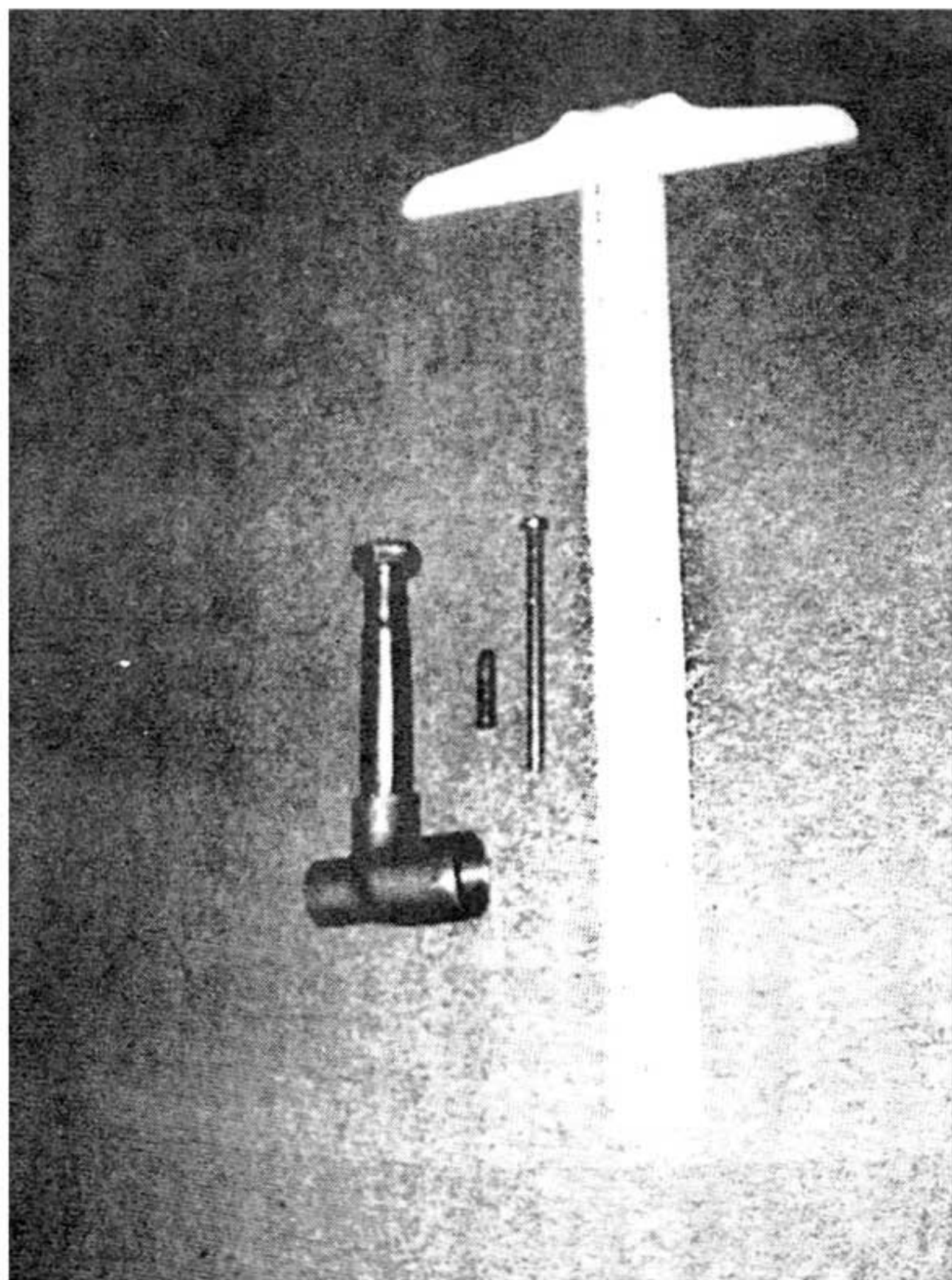

Knuckle pistol complete with .22 cartridge and six penny-nail ramrod-ejector

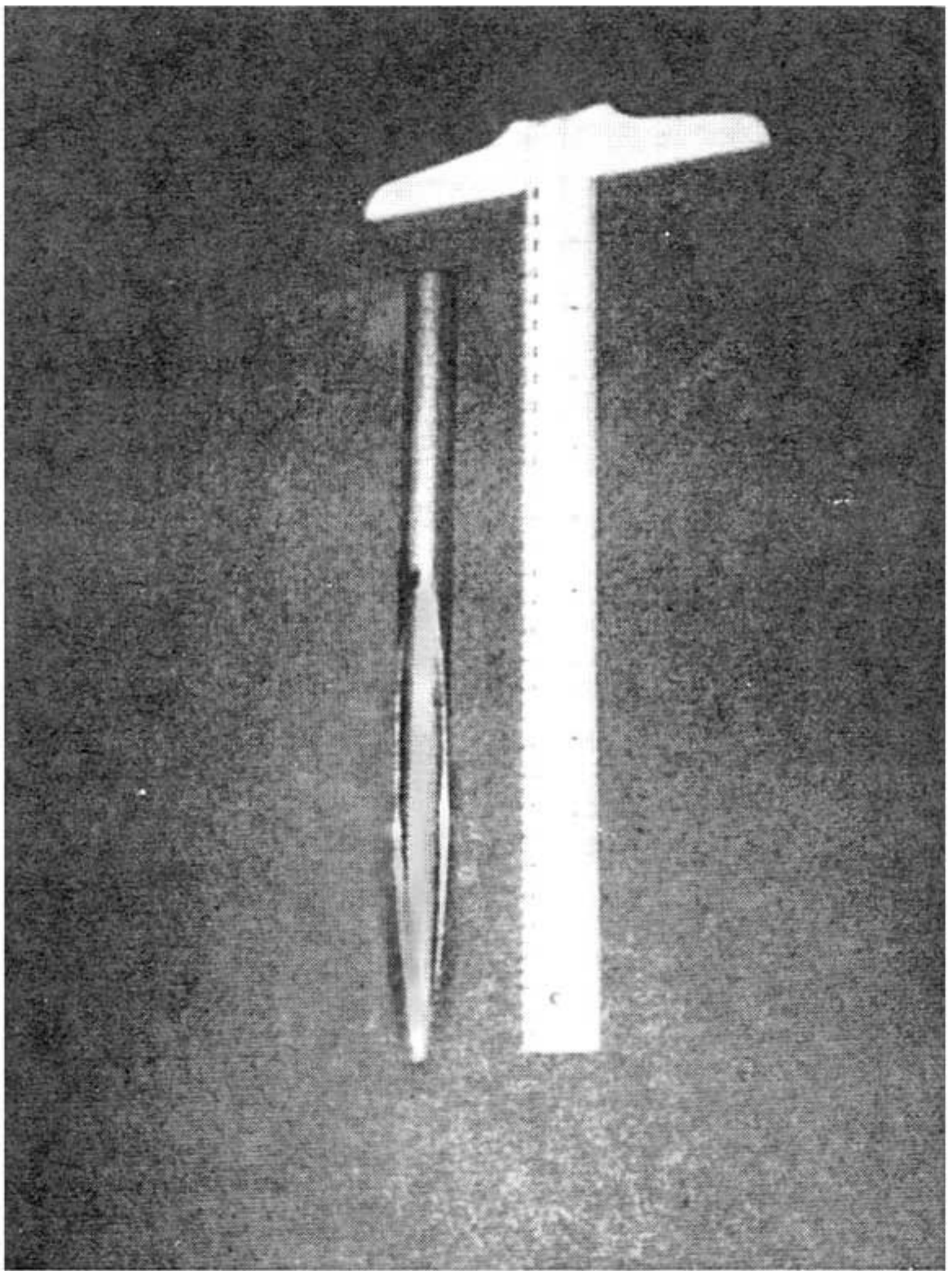

Hypodermic dagger with ruler to scale

APPENDIX D: A LIST OF POISONS

Acrylonitrile (cyanide-like)
Aniline (inhaled or absorbed)
Antimony trichloride (vapor)
Arsenic (Paris Green, Rat Poison, Ant Paste, Fowler's Solution)
Atropine (Bella Donna, Homatropine, Hyoscine, Hyoscyamine, Jimson Weed, Scopolamine)
Amytal, Barbital, Dial, Ipral, Pentobarbital, Phenobarbital, Seconal, veronal O.D.'s
Benzidine
Oil of Bitter Almonds (Cyanide)
Black Leaf 40 (nicotine)
Bromine (vapor)
Cadmium (vapor, death delayed 4 hrs.)
Cantharides (Spanish Fly) from vet.. O.D.
Carbon disulfide (vapor, liquid)
Carbon tetrachloride (phosgene vapor)
Cathartic pills
Cherry Laurel Water (cyanide)
Chloronitrobenzine
Copper Sulfate (Bluestone)
Curare (Intrococstrin, used by vets.)
Cyanogen (Ethanedinitrile, Dicyan, Oxalic Acid Dinitrile) Bromine cyanide, Cyanogen chloride, Iodine cyanide, Prussic Acid, Sodium cyanide, Potassium cyanide)
Ethylene Chlorohydrin (liquid, vapor)
Ethyl mercury chloride (liquid, solid, vapor)
Ethyl mercury chloride, Ethyl mercury phosphate, Ethyl mercury (same as above)
Fire extinguisher fluid (contains: Carbon tet., Methyl Bromide, Chloroform.)
Roach Poisons (1080, Sodium monofluoroacetate, Sodium fluosilicate)
Freon (when heated by flame)
Metallic hydrides (Arsine, Phosphine, Stipine gasses)
Metacide (Parathion)
Morphine (Codeine, Paregoric, Laudanum, Dilaudid, Heroin O.D.'s)
Nicotine sulfate

APPENDIX D: A LIST OF POISONS

Acrylonitrile (cyanide-like)
Aniline (inhaled or absorbed)
Antimony trichloride (vapor)
Arsenic (Paris Green, Rat Poison, Ant Paste, Fowler's Solution)
Atropine (Bella Donna, Homatropine, Hyoscine, Hyoscyamine, Jimson Weed, Scopolamine)
Amytal, Barbital, Dial, Ipral, Pentobarbital, Phenobarbital, Seconal, veronal O.D.'s
Benzidine
Oil of Bitter Almonds (Cyanide)
Black Leaf 40 (nicotine)
Bromine (vapor)
Cadmium (vapor, death delayed 4 hrs.)
Cantharides (Spanish Fly) from vet.. O.D.
Carbon disulfide (vapor, liquid)
Carbon tetrachloride (phosgene vapor)
Cathartic pills
Cherry Laurel Water (cyanide)
Chloronitrobenzine
Copper Sulfate (Bluestone)
Curare (Intrococstrin, used by vets.)
Cyanogen (Ethanedinitrile, Dicyan, Oxalic Acid Dinitrile) Bromine cyanide, Cyanogen chloride, Iodine cyanide, Prussic Acid, Sodium cyanide, Potassium cyanide)
Ethylene Chlorohydrin (liquid, vapor)
Ethyl mercury chloride (liquid, solid, vapor)
Ethyl mercury chloride, Ethyl mercury phosphate, Ethyl mercury (same as above)
Fire extinguisher fluid (contains: Carbon tet., Methyl Bromide, Chloroform.)
Roach Poisons (1080, Sodium monofluoroacetate, Sodium fluosilicate)
Freon (when heated by flame)
Metallic hydrides (Arsine, Phosphine, Stipine gasses)
Metacide (Parathion)
Morphine (Codeine, Paregoric, Laudanum, Dilaudid, Heroin O.D.'s)
Nicotine sulfate

Kill

Nitrobenzene

Oxalic Acid & Oxalates (Radiator cleaner delayed death)

Parathion (E-605, Thiphos, Thiophosphate)

Phosphorus-white (Fireworks and foreign match heads, rat poisons)

Phosgene (Carbon tet., Chloroform in contact with flame.)

Tetrachloroethane (acetylene tetrachloride)

Tetraethyl pyrophosphate (TEPP)

Thallium (Thalgrain rat poison)

Toxaphene (Chlorinated camphene)

Toluidine (vapor)

Weed killers (2, 4-D)

Note: Unless otherwise stated these poisons are either to be injected into the subject, or taken orally by him by adding it to his food. Use common sense in the application of these poisons and if possible double the O.D. necessary. This is only a short listing. Study it.



**"KILL
WITHOUT
JOY!"**

The Complete
How to Kill
Book



John Minnery

PREFACE

The object of this study is to instruct the reader in the techniques of taking another human life, up close, and doing it well. You may well find this booklet offensive, repulsive, brutal, and vicious. It is meant to be. It is completely contemptuous of human life and my only admonition to the would-be assassin is: Kill without joy.

No attempt is made to differentiate between the moral good or bad and the complexities of the motives of the reader are not delved into. This book will merely show you how to kill.

The victim (i.e. subject) can be said also to benefit because he is despatched with as little pain as possible and his suffering and misery need not be great.

This work will not teach you how to torture or brutally abuse another human being. It will not advocate the individual destruction of anyone in particular. In most cases it will not advise how to approach or dispose of the subject.

My only premise is there are times when one must attack with complete ruthlessness and fight with lethal fury. This fury and ruthlessness must be harnessed and directed to do the gravest possible damage — to kill.

The professional killer be he a soldier or a cold warrior (i.e. government directed assassin) has a duty to kill on command his country's enemies, who, for whatever reason, cannot be permitted to go on living. Special Forces have assassination squads that are employed in guerrilla and counter-insurgency operations. It is in the hope of making these people more effective that this booklet is written.

To kill at close range, five to ten feet or at arm's length and closer, requires the deftness of a surgeon and the ferocity of a rabid animal. One must have complete confidence in one's ability to kill, and this means he must know the human body— one must practice what amounts to black medicine and do the exact opposite of what a doctor might do to save life.

Most of the methods in this work are for urban situations which impose different restrictions on the choice of weapons that a soldier might have in the field. The assassin will often be forced to kill in the open, in a park, on the street, in an alley, or room, or any one of a dozen other places where the risks of being discovered and captured are greatest. In most cases he will have only one chance and he must be sure he knows when, where and how to kill.

Brantford, Ont., 1973