

Stock is drilled with long shank drill in lathe chuck, centered on tail stock center. Fed into drill by tail stock pressure.

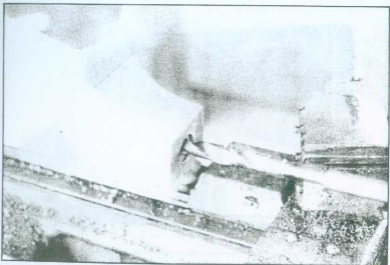

Close up of drilling operation.

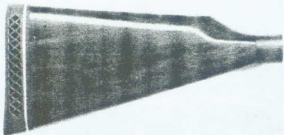

Buttstock assembly.

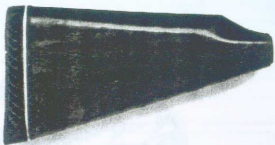

Buttstock, mounting bracket, nut.



Grip, can be shaped to individual preference.

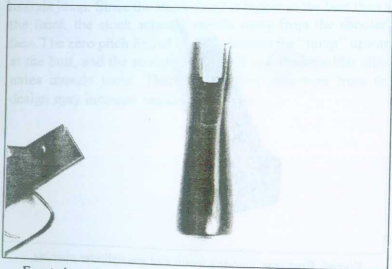

Front view, showing cut out for trigger housing, trigger guard.



Forend, side view.



Forend, from rear, showing tenon and gas cylinder opening.



Trigger assembly, grip, grip screw.

It should be noted here that the stock design of this gun contributes significantly to the reduced recoil and lack of muzzle jump. Since the stock comb is higher at the heel than at the front, the stock actually recoils away from the shooter's face. The zero pitch line of the butt lessens the "jump" upward at the butt, and the straight line recoil into the shoulder eliminates muzzle jump. Therefore, radical departure from this design may increase recoil appreciably.

TRIGGER ASSEMBLY

The trigger assembly consists of a housing, trigger, hammer, sear, disconnecter and safety, plus a hammer spring and guide, trigger and sear springs, plus appropriate pivot pins or screws.

The trigger housing is made from rectangular bar stock $\frac{3}{8}$ " wide, 6" long and $1\frac{1}{8}$ " deep. Since little or no stress or shock is imposed on this part, it can be made from whatever steel is available. I prefer better material than cold rolled even for parts such as this, simply because it machines cleaner. I used, and will continue to use, 4140 for this part.

The inside is cut out using a $\frac{3}{8}$ " end mill leaving a wall thickness including both sides, one end, and the bottom of .100" to .120". The other end which will be the forward, or front, end is cut out entirely. By using the measurements shown or tracing an overlay from the plan sheet, the holes can be properly located and drilled. As usual these holes should be started with a center drill, then drilled with an undersized drill and finished with the proper diameter drill. Since the holes for both the trigger and sear axis pins are threaded 8 x 40 or 8 x 32 to accept axis pins which screw in place, the holes should be a finished diameter of .136" on the threaded side. A number 29 drill is correct for this. The opposite side is larger at .164" - .166" to accept the pin body. Use a number 19 drill for this. The hammer axis pin uses a threaded hole $\frac{3}{8}$ " x 24" on both sides. These are drilled with a "Q" drill of .332" diameter. The pin at the upper front edge is $\frac{1}{4}$ " in diameter with one side tapped for a $\frac{1}{4}$ " x 28 thread. Use a $\frac{1}{4}$ " and a number 3 drill (.213) respectively. This pin is used only to wedge the forward end of the trigger housing in place.

A slot $\frac{1}{4}$ " wide and $\frac{1}{2}$ " long is cut in the bottom for the trigger to fit through and the trigger guard bent to shape from .100" - .125" sheet metal $\frac{1}{2}$ " wide. A $\frac{1}{8}$ " wide slot is cut in the trigger housing just forward of the trigger opening and a

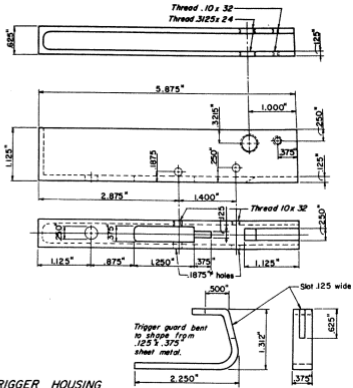
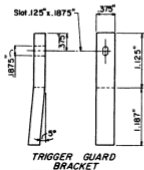

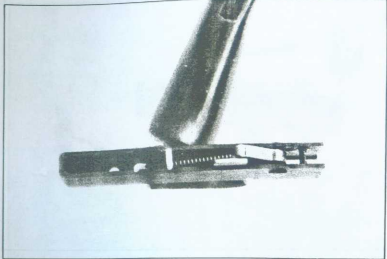

Top view of trigger assembly, showing hammer in cocked position.

matching slot in the forward end of the trigger guard. Taking care to keep this slot lined up the guard is attached to the housing by welding or silver solder. The safety lever works laterally in this slot.

A $\frac{1}{4}$ " hole is drilled through the bottom rear of the housing for a retaining bolt $\frac{1}{4}$ " x 28" x 5" which is purchased commercially. Wait until the grip is installed in its proper position to drill this hole, which is marked through the hole in the grip assuring matching.

The trigger safety, and hammer are cut to shape from $\frac{1}{4}$ " high carbon steel such as 4340. A section of automobile leaf spring works well here. The sear should be made from $\frac{5}{16}$ " material of the same quality, note that spacers are fitted to both the trigger and sear to keep them centered between the walls of the housing. The hammer is centered by using the $\frac{3}{8}$ " by 24 T.P.I. hammer screw with a small $\frac{1}{4}$ " pin extending through the



Trigger assembly with magazine catch.

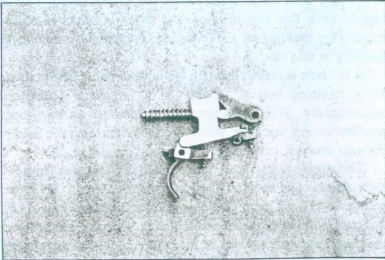

Trigger/hammer assembly in approximate assembled position.

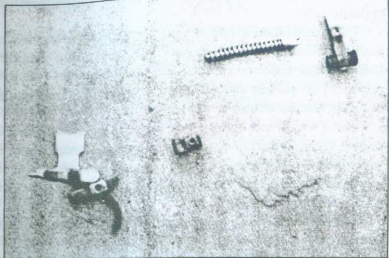

Trigger with trigger bar, sear, hammer spring and guide, hammer with axis pin in place.



Hammer axis pin and boss.

hammer and into the bushing threaded into the housing from the opposite side.

The combination trigger bar and disconnecter is also made from ¼" material with the forward portion thinned to clear the hammer and hammer spring. The upper "humps" on the disconnecter portion should be left oversize to permit fitting after the rest of the gun is assembled.

Three small coil springs are required as shown for the trigger, sear and disconnecter. No specific size is required here so long as they are strong enough to return these parts to their pre-fired position and hold them there. Drill "pockets" as shown for the springs to fit in.

The same applies to the hammer spring. The size can vary as long as it is strong enough to throw the hammer forward with sufficient force to fire the shell consistently. The spring guide is made to match.

SMALL PARTS

The stock mounting bracket is made in three parts due to the complicated machining required for one piece construction. The tubing portion is .500" inside and .625" outside diameter. The rear end is threaded 28 threads per inch to mate with the stock nut which is simply turned to the configuration shown and threaded inside. The front portion is made by boring a piece of the same tubing used for the inner receiver and threading it inside to screw on the rear thread tenon, a bushing is made as shown and the tube inserted in the center hole and silver soldered in place. The outer sleeve is then screwed on and silver soldered. Note the flats on each side of the bushing which permits use of a wrench to tighten and remove.

The rear and front spacers are made from $\frac{3}{8}$ " flat stock while the gas cylinder bracket is made from $\frac{1}{2}$ ". Both spacers should have a shoulder $\frac{1}{8}$ " deep around the entire perimeter of each. The outside to the same width as the outer receiver and the smaller portion a snug fit inside the ends of the outer receiver. The hole in each should have the same relation to the shoulders as this causes alignment of both receivers to remain fixed. The gas cylinder bracket must have the same distance between centers of the two holes as the front spacer to assure alignment of the gas cylinder parallel to the bore. Note that a cup is milled into the front side of the front spacer leaving a flange to support the rear end of the forend.

For ease of manufacture, the operating handle is made in two parts and welded together. As long as the two legs on the vertical part fit the slots in the horizontal portion closely, silver solder will suffice to join them together. Note that the front and rear surfaces of the diagonal slot are not perpendicular to either the horizontal or vertical axis but are cut on a spiral or helix which remains at a right angle to the bolt lug cam during its movement through the locked and unlocked positions. The flange at the top serves as a guide and should be .125" wide and



Operating handle, side view.



Operating handle, top view.

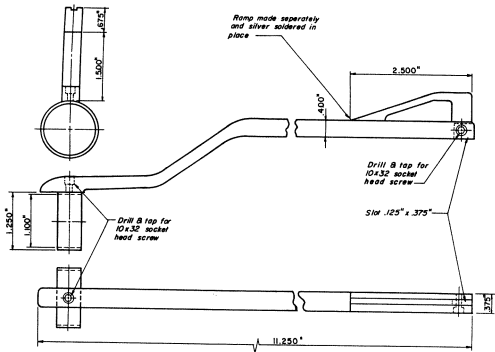

OPERATING HANDLE GUIDE

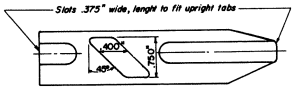
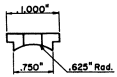
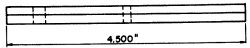
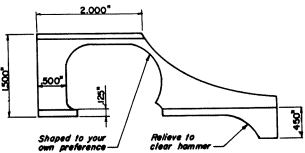

OPERATING HANDLE

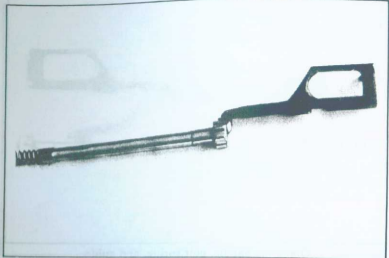

Operating handle shown in correct relationship with bolt spring and guide. Fluted portion of bolt spring guide is to reduce friction.

.200" deep to mate with the slot in the under side of the operating handle guide.

The operating handle guide can be bent to shape from $\frac{3}{8}$ " key stock or sawn and milled from $\frac{3}{8}$ " flat stock. Whichever method is used, it must have a $\frac{1}{8}$ " wide by .220" deep slot milled lengthwise for the flange on the operating handle to fit into. A sleeve is made from the same $1\frac{1}{4}$ " tubing used for the inner receiver and bored to a slip fit over the tenon at the rear of the inner receiver. This sleeve is fastened to the guide bar by a 10 x 32 screw and silver solder. The front end of the guide bar is slotted to mate with the rear spacer and both are drilled and tapped for the 10 x 32 screw which holds them together at the front.



Operating handle, bolt spring, and guide.



Bottom view of guide showing cut out portion for hammer clearance.

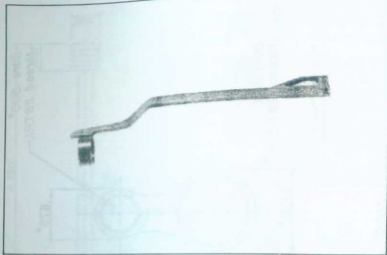

Combination carrying handle/operating handle guide, side view.

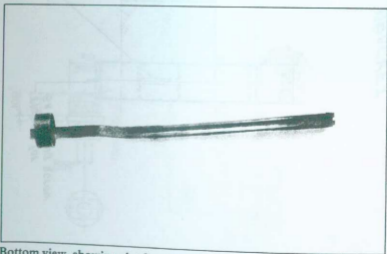

Bottom view, showing slot for operating handle which the "draftsperson conveniently left off the book drawing. It is shown on the large plan sheet.

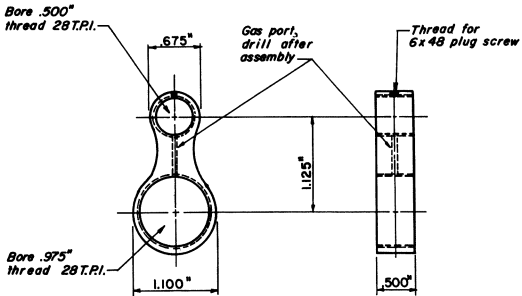

GAS CYLINDER BRACKET

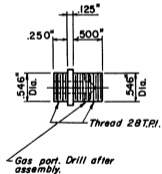
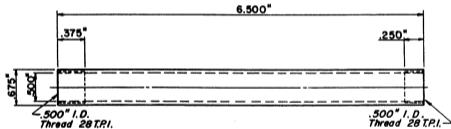
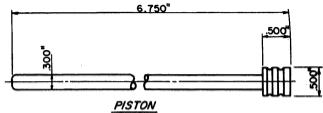
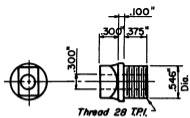

GAS CYLINDER



Gas piston, spring, retainer.



Gas piston assembly.

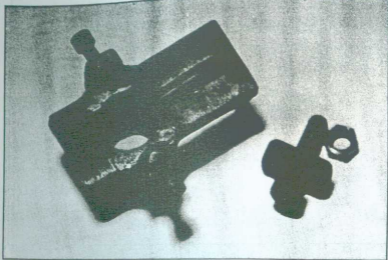

Fixture permits proper hole spacing, boring in lathe.

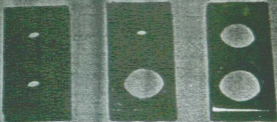

Progression of bracket fabrication.



Side view of fixture.

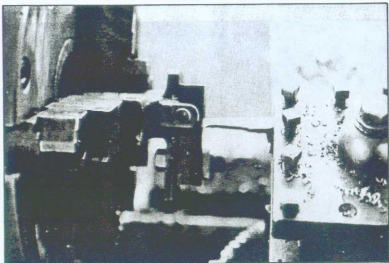

Boring front spacer.



Boring bracket to size.



Threading bracket.

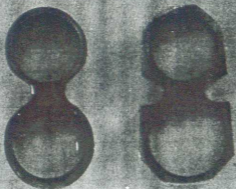

Outside contour progression of bracket.

The bolt spring guide is turned from 4140 or 4340 steel. The larger portion a close fit to the receiver bore and the smaller portion just fitting the stock mounting bracket tub. A $\frac{1}{4}$ " hole can be drilled lengthwise, if desired, just to make it lighter. The slot in the lower side is to provide clearance for the hammer. The slot on the upper side mates with the rear leg of the operating handle to prevent its turning.

As long as they are available, the use of bolt springs such as are used in 1100 Remington or similar autoloading shotguns will save a lot of time and trouble. If you do have to wind one it should be made from music wire with a diameter of .051" - .052", an uncompressed length of approximately 14" and contain some one hundred coils.

The gas piston is made from tubing. The forward end



Projection on front sight band mates with notch in barrel band, prevents movement.

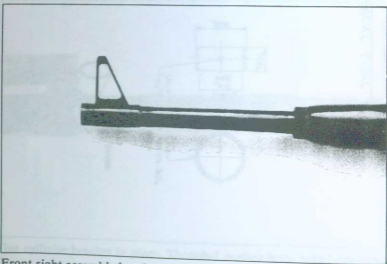

Front sight assembled on barrel, forend retainer nut as shown on plan.

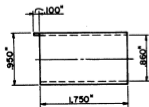
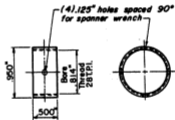
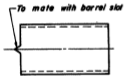
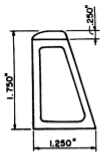

FRONT SIGHT ASSEMBLY

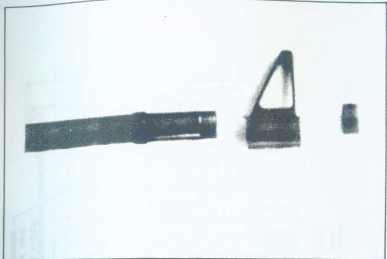

Front sight assembly.

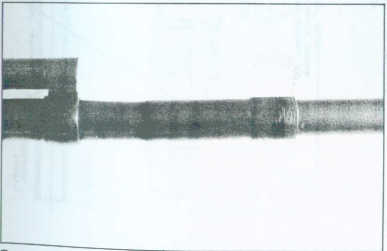

Gas cylinder bracket in place. Threaded portion is for barrel retaining nut.

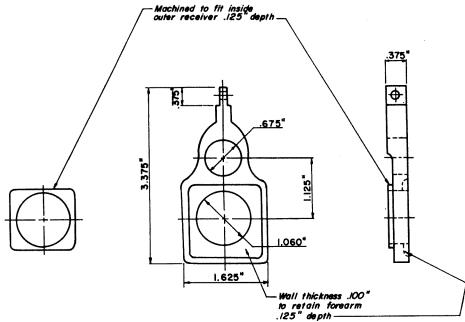

FRONT SPACER

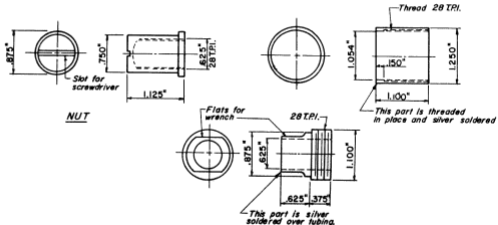
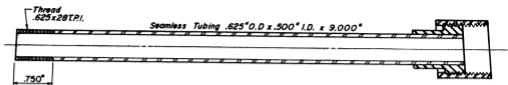

STOCK MOUNTING BRACKET AND NUT

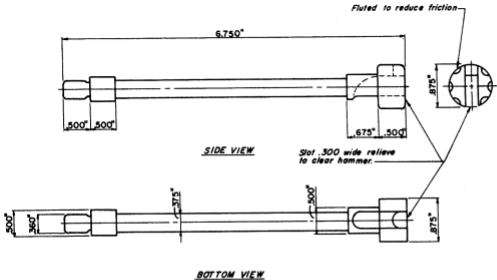

BOLT SPRING GUIDE

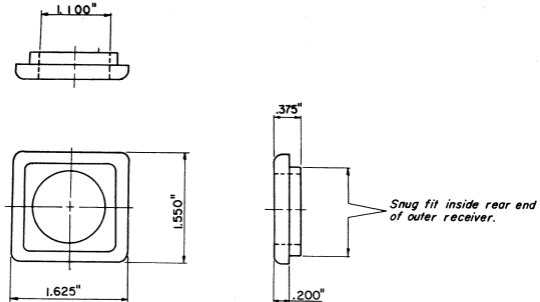

REAR SPACER

threaded to receive a plug which, in turn, screws into the gas cylinder bracket. The rear end is also threaded to accept a bushing which encircles the gas piston rod and holds the return spring in place. A Colt M 1911.45 auto recoil spring works well as a return spring.

The gas piston should be turned and lapped to a close fit. The piston and rod can be made separately and screwed together, or turned in one piece from round stock. It may also be desirable to fit one or more piston rings as shown in the drawing to attain a tighter seal.

The front sight is made by shaping the upright, or blade, portion from $\frac{1}{4}$ " to $\frac{3}{8}$ " flat stock which is silver soldered to the tubing which must fit the barrel closely, also some means should be provided to maintain the vertical position of the blade. One way of doing this is, as shown, cutting one or more notches in the barrel collar and corresponding projections on the sight sleeve which mate together preventing the sight from turning.

Both the forend nut and front sight nut are turned from round stock, bored to diameter and threaded to fit the barrel threads. Some means should be provided to tighten and to remove these nuts. This can be done by cutting opposing flats on each nut so that a wrench can be used or drilling one or more holes around the rim to permit the use of a proper spanner wrench. Such wrenches can be made by forging a curve in a short length of flat stock and installing a stud either by drilling and tapping or silver soldering.

The magazine release is made from $\frac{3}{8}$ " flat stock, the sides thinned to fit inside the slot at the rear of the magazine box. The upper end has a pocket drilled to accept a small coil spring and the hole drilled for a $\frac{1}{8}$ " diameter pivot pin. The hook portion which engages the rear side of the magazine and latches it in place should be left oversize for final fitting when the gun is

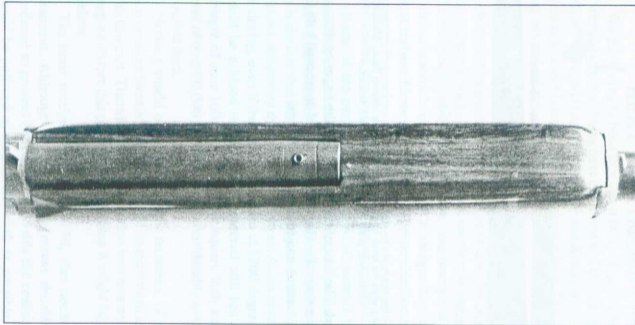

Socket screw plugs hole made during gas port drilling, permits cleaning of orifice.

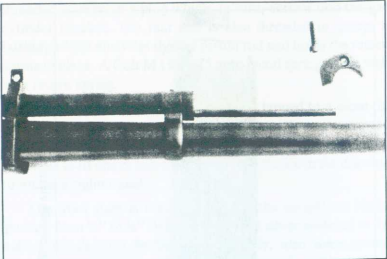

Forend can also be held in place using system shown here. Method shown on plan is stronger, simpler, neater.

assembled. The face of the lever which the finger contacts to release the magazine should be checkered or grooved both for cosmetic reasons and to minimize slippage.

HEAT TREATMENT

We have already been through a fairly lengthy description of what takes place during heat treatment and the reason for it in "*Home Workshop Guns for Defense and Resistance*" Volumes I and II so there is no point in repeating it here. Suffice to say that several of the component parts described here require hardening and tempering mostly to prevent battering and/or rapid wear.

It should be pointed out, for the benefit of the uninformed, that pressures in a 12 ga. shotgun are very low in comparison to rifle and pistol cartridges. Therefore, less strength is required from the materials used to produce a shotgun that is safe to shoot and use. However, since far longer trouble free use can be expected from a gun built from quality materials and properly heat treated, the end result is worth the extra effort.

Some of the parts, if built from 4130 aircraft tubing as described, are satisfactory "as is." In fact, the primary purpose in using this material aside from desirable dimension availability is the fact that it is intended to be subjected to welding heats without completely drawing all the temper. As an example after hardening, even if the temper is drawn at 1200 degrees, which would be a blood red color, the material still has a tensile strength of over 100,000 pounds per square inch and a yield point of over 90,000 P.S.I. which is considerably more than is required here.

Nothing would be gained by heat treatment of the outer receiver since there is little pressure and no movement associated with this part. There is a good chance that heat treatment would warp or distort this part to a point where it might be rendered useless.

The inner receiver, built from 4140, also needs no heat treatment. Although the locking lug recess should be case hardened to prevent battering. To do this the contact surface should be polished as smooth and slick as possible, then the

contact surface and immediate area around it is heated cherry red with the acetylene torch and dipped in a hardening compound such as "Kasnit." The Kasnit powder sticks to the metal, melting and forming a coating. The steel is then again heated to a bright red and quenched in water. This system is capable of imparting a deep surface hardening and can be repeated on the same material with some increase in hardness.

The other parts requiring heat treatment are the hammer, sear, disconnecter/trigger bar, safety, magazine release, firing pin, and gas piston. While it is desirable and advisable to properly harden and temper these parts, preferably through the use of a proper oven, the "Kasnit" treatment described above will suffice if properly done. In fact, this treatment will probably work out better in a home workshop operation since it is not only almost foolproof but imparts a deep surface hardness while retaining a softer core thus creating shock and wear resistance without brittleness.

The locking lug on the breech bolt should be given the same treatment. If automobile axle material is used to make the breech block, as suggested, then no heat treatment is required or even desirable.

The magazine spring is the only part which actually presents a problem. This thin and relatively fragile part is difficult to heat and cool evenly. Therefore, if at all possible, professional heat treatment is desirable. In the event that this is not possible, some means must be found to evenly heat the part to 1475° - 1525° F. and quench in oil. The part must then be tempered at 700° which, if 1075 steel is used will produce a medium spring temper having a hardness of RC 47 and a tensile strength of 230,000 P.S.I. Probably the most foolproof way to accomplish this is to build a steel box for slightly larger than the formed spring from ¼" or thicker steel plate. The box doesn't need to be air or water tight so simply tack welding the sides and

ends to the bottom plate will suffice. The sides should be deeper than the spring width.

In use the formed spring is placed inside the box and the whole business evenly heated until its color is just beginning to change from red to orange. A forge is desirable for this if no oven or furnace is available. Then without being allowed to cool the box, spring, and all is quenched in warm S.A.E. 10 motor oil. Then, just as a precaution against cracking or breaking it, the spring is placed on a piece of aluminum foil in a kitchen oven and held at the highest temperature the oven will attain for a period of at least an hour. The spring must now be polished as much as possible so that smooth bright metal can be seen. Then the part is put back in the box and heated until the steel progresses through the straw colors, followed by brown, purple, dark blue and finally a light pale blue, at which time the heat is removed and the spring allowed to cool. If all this was properly done, you now have a functional spring, if not you start over and keep trying until it does work.

It should be noted that it is better that component parts be on the soft side rather than too hard. Excessively hard parts are prone to break whereas the too soft part will usually only batter, bend, or wear excessively, conditions that will probably be noticed and corrected as the gun is inspected from time to time.

As a convenience the following table contains a type of steel suitable for each part of this gun together with suggested heat information which is optional to the "Kasenit" treatment previously recommended. Please note that, as stated before, since I have no control over the materials or procedures that you use, I cannot accept any responsibility whatsoever for the results obtained.

Part	Material	Harden	Temper	Hardness	Tensile Strength P.S.I.
Outer Receiver			None Necessary		
Inner Receiver	4140		None Necessary		
Barrel	4140		None Necessary		
Breech Block	4340	1475°-1550°	1000°	Rc38	178,000
Hammer	4340	1475°-1550°	800°	Rc44	210,000
Sear	4340	1475°-1550°	800°	Rc44	210,000
Trigger	4340	1475°-1550°	1100°	Rc35	160,000
Trigger Bar	4340	1475°-1550°	800°	Rc44	210,000
Safety	4340	1475°-1550°	1000°	Rc38	178,000
Gas Piston	4340	1475°-1550°	1000°	Rc38	178,000
Gas Cylinder	4140	1525°-1625°	1100°	Rc31	142,000
Operating Handle	4140	1525°-1625°	1100°	Rc31	142,000
Spacers	4140		None Necessary		
Magazine Spring	1075	1475°-1550°	700°	Rc47	230,000
Stock Mounting Bracket	4140		None Necessary		
Carrying Handle					
Bolt Guide	4140		None Necessary		
Sights	4140		None Necessary		
Firing Pin	4340	1475°-1550°	1000°	Rc38	178,000

FINISHING

With the component parts fitted and heat treated, it is desirable to smooth the exposed surfaces and color them in a manner that will hopefully contribute to rust prevention, prevent light reflection and be pleasing to the eye. In previous volumes I have given detailed descriptions including formulas for both nitrate blueing or "blacking" and rust blue methods. In this volume I shall try to describe a method sometimes referred to as "fume" blueing or "fuming." This method is probably the simplest and most foolproof and requires less equipment than most.

Regardless of the method used to impart the color, all methods have one common requirement. Polishing. The end result will be directly proportionate to the quality of the polish job.

As a final finish for a firearm of this type it is many times desirous to obtain a "satin" finish or a dull non-reflective finish. This is obtained by first removing all rough spots, blemishes, and tool marks in the same manner used in any other finish. While it is possible to save time and labor through the use of power polishing equipment, an equal or better job can be done with files and progressively finer grades or grits of abrasive cloth.

The files are used to smooth up the metal surfaces, removing tool marks, dents, and other blemishes. The curved surfaces are then cross polished by using strips of cloth in a shoe shining motion. These parts are then polished along with the flat surfaces in a lengthwise motion with strips of cloth wrapped around a flat file or block of wood. This process is repeated using progressively finer grits of abrasive cloth until a smooth mar free surface is obtained.

The parts which are to receive the dull finish are now given a "bead blast" finish through use of a glass bead machine. Such a rig utilizes compressed air to drive a uniform size of fine glass

beads against the surface of the metal at high velocity creating a dull or frosted appearing surface. Many automobile body shops as well as aircraft engine shops have such machines and usually will do this for a nominal fee.

The parts are now degreased by the same method used with the other blueing processes. This can be done by boiling in clean water using a couple of tablespoonsful of lye per gallon or using one of the commercial solutions produced for this purpose.

Along with a tank to boil the parts in, plus a suitable heat source, it is also necessary to have at least one, preferably two, plastic boxes, both as airtight as possible to place the parts in while the actual fuming takes place. One box must be of sufficient size to accept the barreled receiver. The other needs only to be large enough for the remaining parts.

Sign shops often have scrap plastic sheets or discarded signs made from $\frac{1}{8}$ " to $\frac{1}{4}$ " thick plastic from which a top, bottom, sides and ends can be sawn and, using plastic cement, built into a satisfactory receptacle.

You will also need a small quantity of both concentrated nitric and hydrochloric acids, as well as several (4 to 6) plastic glasses to hold the acids.

Then with the parts degreased by boiling in the degreasing solution, rubber plugs or corks are placed in each end of the barrel and the open end of the gas cylinder. Any areas which you don't want blued can be masked off or coated with shellac, varnish, lacquer, etc. The parts are next placed inside the plastic boxes. Six or eight drops of each acid are placed in each cup (don't mix them) and two cups of each acid placed in the long box and one or two of each in the smaller box and the covers put in place. The actual rusting takes place in, usually, one to three hours. Therefore, the work should be observed frequently after the first hour and removed when the desired color is obtained. Making the box lids from clear plastic can be an aid to easy inspection.

When finished the parts are boiled in clean water to stop any further action and oiled in the same manner used with other methods.

It is possible to achieve about any degree of luster desired by varying the acid quantities, since the nitric acid does the actual blueing while the hydrochloric fumes simply etch the surface. So, a bit of experimenting is necessary to achieve the finish desired.

Please note that this method of blueing did not originate with me. As far as I know a chemist and top gunsmith by the name of Philip Pilkington developed this system. I have described it here simply as an alternative to the methods presented in my other books.

ASSEMBLY AND TEST FIRING

Assuming that you have all the component parts built to the specified sizes and shapes, it stands to reason that you should surely be able to assemble them in the proper order without instruction. Let's run through it once anyway just in case some one or two doesn't completely understand.

The front spacer is installed in place over the barrel thread tenon and the inner receiver screwed on as tight as you can get it. The spaced vertical center line should be in line with the bolt slot centerline. The gas cylinder bracket is then threaded onto the barrel hoping all the time that it lines up vertically. If it does not, metal must be removed from the rear face of the bracket or the front of the barrel shoulder until it does. The gas cylinder is now inserted through the hole in the front spacer and screwed tightly in place. Then the gas port is drilled through the bracket, gas cylinder and upper wall of the barrel and the hole through the upper side of the bracket and cylinder enlarged with a No. 31 drill and tapped to receive a 6 x 48 plug screw.

The bolt is now pushed in place through the open rear end of the inner receiver and the chamber cut to its finished depth. This is done using an extension on the chamber reamer which extends past the rear of the receiver allowing it to be turned with the barrel and receiver assembled.

Index marks are made with a sharp punch or chisel on the receiver, spacer, and barrel to insure realignment after they are disassembled. And with the extractor position marked with the bolt both in the locked and unlocked positions the barrel is removed and clearance for the extractor cut both in the barrel and receiver. Final assembly of these parts can now be made. The gas piston is inserted in the cylinder and the operating handle and operating handle guide installed.

The bolt assembly should now slide, fore and aft, in the receiver with no roughness or tendency to bind. If such is encountered, coating the contact surfaces of the parts with fine

lapping compound and working the action a number of times will usually remove the rough spots. All traces of the lapping compound must be removed after use to prevent continued metal removal. Several careful washings in gasoline or solvent may be necessary to accomplish this.

The forend can now be slipped over the barrel and secured in place with the forend nut. The front sight installs in the same fashion simply by slipping the sleeve over the barrel and installing the retaining nut.

The magazine latch together with the corresponding spring is inserted in its slot at the rear of the magazine well and pinned in place. The lower sleeve portion of the operating handle guide is placed over the rear end of the inner receiver and the screw installed which holds it to the front spacer. Then, the entire inner receiver assembly is inserted into the outer receiver, the rear spacer installed over the threaded shank and the bolt spring guide inserted into the rear end of the inner receiver. The stock mounting bracket is now threaded in place and tightened thereby drawing both front and rear spacers securely against both ends of the outer receiver, the flanges on both spacers maintaining proper alignment, the butt stock is pushed in place over the spring inserted in the tube, and the stock nut installed. The recoil pad is now installed using the two screws which hold it in place.

The trigger assembly is assembled by first installing the safety in the slot provided, next the sear and sear spring are installed followed by the trigger and trigger bar. The hammer is next put in place by first screwing the bushing into the left side of the housing, then with the hammer in position, the hammer pin is screwed in from the right side. The bushing and oversize screw portion on the hammer pin serve a twofold purpose of centering the hammer between the housing walls and reinforcing the comparatively thin housing walls. The hammer spring and guide are now put in place, the hammer placed in the

cocked position and the safety engaged. The assembly is now installed on the gun by engaging the cross-pin at the front of the housing with the corresponding slot at the upper rear of the magazine well, the grip placed in position and the bolt installed through the hole in the grip and tightened. The gun should now be a relatively solid assembly depending mainly on proper tolerances in the mating parts.

The magazine is assembled by installing the follower through the lower end followed by the magazine spring, bottom plate retainer and bottom plate.

Disassembly of the weapon is accomplished in reverse order.

Now that the gun is assembled, several steps must be taken before test firing to assure proper function and safe operation. Since the disconnecter legs on the trigger bar were purposely left oversize during manufacture, it should be necessary to remove metal from the front side of both of these legs until the trigger will push the sear out of engagement with the hammer only when the bolt is closed. Properly fitted, the hammer will fall only when the operating handle is within $3/16''$ to $1/4''$ of its extreme forward, or closed position. Further rearward movement of the handle must push the trigger bar downward, out of engagement with the sear preventing firing.

There are people who would foolishly leave this disconnecter portion of the trigger bar off the gun hoping to achieve full automatic operation. This should not be attempted since such condition will permit the gun to fire before the bolt is locked which not only places unnecessary strain and shock on parts of the gun, but many times causes the bolt to open while high enough gas pressures are present in the barrel to blow the case apart.

The safety should block the sear completely when engaged preventing any sear movement whatever, at the same time the trigger bar must have a slight clearance as it engages the sear

enabling it to snap upward when the trigger is released and the bolt is locked.

With the disconnecter and safety fitted as described and the chamber cut to the proper depth the magazine is fitted for proper feeding. This is done by engaging the safety and with a single round in the magazine, inserting the magazine in the gun, pulling the operating handle to the rear and allowing it to snap forward. Properly fitted, the shell head will move forward just enough to free it from the magazine lips just as the front end of the shell enters the chamber. Since the guide ramp between the magazine and barrel guides the forward end into the chamber and the top side of the inner receiver also serves to guide it in by limiting the shell's upward movement, if the magazine lips turn the shell loose at the proper time as described above, the gun will feed properly. It may be necessary to cut the magazine lips back somewhat to achieve this.

With proper feeding accomplished, the gun can be test fired. While shotgun pressures are comparatively low, it is still a good idea to wear shooting glasses and hold the gun with something solid between it and you when firing for the first time.

The gun should be fired only enough to determine that it does function and fire. Heat treatment of the required parts must be done before they are distorted or broken through any more use than absolutely necessary in the soft state.

It may very well happen that the action does not open completely during this phase of testing. No effort should be made to correct this until after heat treatment and final polishing and even then several rounds should be fired before corrective action is taken since slight "wearing in" will many times correct the problem. If the condition remains it will be necessary to either drill the gas port slightly larger, reduce the stiffness of the bolt spring, or both.

COMPONENT SOURCES

The following is by no means a complete list of sources from whom certain parts or materials can be obtained.

BARRELS

- Numrich Arms Co., West Hurley, N.Y. 12491
Sarco Inc., 323 Union St., Stirling N.J. 07980
E. R. Shaw Inc., Prestly & Thomas Run Rd., Bridgeville, PA 15017
P&S Sales, P.O. Box 45095, Tulsa, OK 74145
Federal Ordnance, Inc. 1443 Potrero Ave., El Monte, CA 91733

STOCK WOOD

- Don Allen, Rt. 4, Northfield, MN 55057
E. C. Bishop & Son, Box 7, Warsaw, MO 65355
Jack Burres, 10333 San Fernando Rd., Pacoima, CA 91331
Calico Hardwoods, Inc. 1648 Airport Rd., Windsor, CA 95492
Reinhart Fajen, Box 338, Warsaw, MO 65355
Flaigs Lodge, Millvale, PA 15209
Johnson Wood Products, Rt. 1, Strawberry Point, IA 52706
Oakley & Merkley, Box 2446, Sacramento, CA 95811
Roy Schaefer, 965 W. Hilliard Lane, Eugene, OR 97404

CHAMBER REAMERS

- Clymer Mfg. Co., 14241 W. Eleven Mile Rd., Oak Park, MI 48237
F. K. Eliot, Box 785, Ramona, CA 92055
Keith Francis, Inc., 1020 Catching Slough Rd., Coos Bay, OR 97420
Bob Brownells, Main & Third, Montezuma, IA 50171

SPRINGS, SPRING MATERIAL

- W. C. Wolf Co., Box 232, Ardmore PA 19003
Frank Mittermier, 3577 E. Tremont, New York, N.Y. 10465
Brownells, Main & Third, Montezuma, IA 50171

OTHER

- Kasnit Inc., 3 King St., Mahwah NJ 07430 (Surface Hardening Compound)
Clover Mfg. Co., 139 Woodward Ave., Norwalk, CT 06856 (Abrasive, lapping compound)
Twin City Steel Treating Co., 114 S. 3rd, Minneapolis, MN 55414 (Heat Treating)
Wholesale Tool Co., 12155 Stephens Dr., Warren MI 48090
Wholesale Tool Co., 4200 Barringer Dr., Charlotte N.C. 28210
Wholesale Tool Co., 7240 E. 46th St., Tulsa, OK 74145 (above four stores have machine tools, cutting tools, reamers, taps, bolts, nuts, screws, drill rods, and almost anything else you might need, usually for immediate delivery and at a good price.)