

DOCTRINE FOR SPECIAL FORCES OPERATIONS

DISTRIBUTION RESTRICTION

Distribution authorized to US government agencies only to protect technical or operational information from automatic dissemination under the International Exchange Program or by other means. This determination was made on 29 January 1988. Other requests for this document will be referred to Commander, US Army John F. Kennedy Special Warfare Center and School, ATTN: ATSU-DT-PDM, Fort Bragg, NC 28307-5000.

DESTRUCTION NOTICE

Destroy by any method that will prevent disclosure of contents or reconstruction of the document.

*This publication supersedes FM 31-20, 30 September 1977.

Table of Contents

Prefacevi

CHAPTER 1

Overview of Special Forces Operations

Strategic Environment 1-1
 Contemporary Perspective 1-2
 Nature of Special Operations 1-4
 SO Principles 1-5
 Applications of the Principles of War 1-6
 SO Imperatives 1-9
 Special Forces 1-12
 Role of Special Forces in War 1-13
 Role of Special Forces in Conflict 1-16
 Role of Special Forces in Peace 1-18

CHAPTER 2

Threats to Special Forces Operations

General War 2-1
 Limited War 2-3
 Conflict 2-3

CHAPTER 3

Special Forces Missions

Unconventional Warfare 3-1
 Foreign Internal Defense 3-2
 Direct Action 3-3
 Special Reconnaissance 3-4
 Counterterrorism 3-4
 Collateral Activities 3-5
 Other SO Activities 3-6
 Multiple and Follow-On Missions 3-7

CHAPTER 4

Special Forces Organization and Functions

Special Forces Group (Airborne) 4-1
 Headquarters and Headquarters Company, SFG(A) 4-2
 Support Company, SFG(A) 4-5
 SF Battalion, SFG(A) 4-7

Headquarters Detachment (SFOD C), SF Battalion	4-8
Support Company, SF Battalion	4-10
SF Company, SF Battalion	4-11
Operational Detachment (SFOD A), SF Company	4-13
Chemical Detachment, SFG(A)	4-16

CHAPTER 5

Command and Control of SF Operations

Joint Environment	5-1
Theater Special Operations Command	5-2
Army Special Operations Task Force	5-2
Theater Army Special Operations Support Command	5-5
SF Command and Control System	5-7
Command Relationships in the COMMZ	5-10
Deployment C2	5-16
Command Relationships in the JSOA	5-17
SF C2 at Conventional Headquarters	5-19
SF Control of Conventional Maneuver Units	5-21
SF Communications in a Developed Theater	5-22
SF Communications in an Undeveloped Theater	5-23

CHAPTER 6

Operational Bases

Basing Considerations	6-1
Operations Center	6-5
Support Center	6-10
Signal Center	6-12
Alternate Bases	6-14
Base Defense	6-14
NBC Defense	6-16

CHAPTER 7

Special Forces Mission Planning and Preparation

Joint SO Targeting Process	7-1
Assignment of Missions and Operational Areas	7-6
SF Team Selection	7-6
Support and Sustainment Planning Process	7-10
Deliberate Mission Planning Process	7-10
Time-Sensitive Mission Planning Process	7-16
Planning Considerations	7-16
Operations Security	7-18
Deception	7-19
Psychological Impact	7-19
SF Teams in an NBC Environment	7-19

CHAPTER 8

Infiltration and Exfiltration

Planning Considerations	8-1
Air Infiltration	8-2
Water Infiltration	8-3
Land Infiltration	8-3
En Route Evasion and Escape Plan	8-4
Exfiltration	8-5
Stay-Behind Operations	8-5

CHAPTER 9

Unconventional Warfare

Resistance and Insurgency	9-1
Three Phases of an Insurgency	9-2

Resistance Organization	9-4
Seven Phases of US-Sponsored UW	9-5
SF-Resistance Relationships	9-11
Psychological Operations	9-12
Discipline	9-13
Resistance Logistics	9-14
Resistance Health Service Support	9-15

CHAPTER 10

Foreign Internal Defense

Internal Defense and Development	10-1
Special Forces FID Operations	10-2
SF Organization for FID Operations	10-6
SF Rear Operations	10-8

CHAPTER 11

Direct Action

Nature of DA Operations	11-1
Command and Control of DA Operations	11-2
CSAR Operations	11-2

CHAPTER 12

Special Reconnaissance

Nature of Special Reconnaissance	12-1
Employment Considerations	12-2
Communications Requirements	12-2

CHAPTER 13

Intelligence and Electronic Warfare

IEW Support From Higher Headquarters	13-1
Situation Development	13-2
Target Development	13-2
Electronic Warfare	13-3
Counterintelligence	13-4

CHAPTER 14

Combat Service Support of SF Operations

Theater Army	14-1
Combat Service Support at the SFOB and FOB	14-3
Sources of Supply	14-4
Developed Theater Logistics	14-5
Developed Theater Personnel Service Support	14-8
Developed Theater Health Service Support	14-9
Undeveloped Theater CSS	14-9
Reconstitution	14-11
Resupply of SF Teams in the JSOA	14-12

CHAPTER 15

Psychological Operations in Support of SF Operations

PSYOP in a Conflict Environment	15-1
PSYOP Planning	15-2
PSYOP Organization for Special Operations	15-3
PSYOP Area Assessment	15-4
PSYOP in Support of UW	15-5
PSYOP in Support of FID	15-6
PSYOP in Support of Other SF Operations	15-6

CHAPTER 16

**Civil Affairs Support
to Special Forces**

Command Support Operations _____ 16-1
 Role of CA in UW _____ 16-2
 Role of CA in FID _____ 16-2
 Role of CA in DA and CT _____ 16-3

APPENDIXES

Operating Systems _____ A-1

**Sample Group
Operation Plan** _____ B-1

**Sample Battalion
Operation Plan** _____ C-1

**Preliminary Assessment
Format** _____ D-1

**Sample SOC
Mission Letter** _____ E-1

**Sample Group
Mission Letter** _____ F-1

**Sample Battalion
Mission Letter** _____ G-1

**Special Forces
Mission Briefback Format** _____ H-1

**Area Study
Outline Format** _____ I-1

**PSYOP Support of
a US-Sponsored
Resistance Force** _____ J-1

GLOSSARY

Part I. Acronyms _____ Glossary-1
 Part II. Definitions _____ Glossary-5

REFERENCES

_____ References-1

INDEX

_____ Index-1

Preface

Field Manual (FM) 31-20 is the Special Forces (SF) principles manual. It is directly linked to and must be used in conjunction with the doctrinal principles found in FMs 100-5 and 100-20 and the projected FM 100-25. It describes SF roles, missions, capabilities, organization, command and control, employment, and support across the operational continuum and at all levels of war. It provides the authoritative foundation for SF subordinate doctrine, force design, materiel acquisition, professional education, and individual and collective training. It supports the doctrinal requirements of the Concept Based Requirements System.

This manual provides the doctrinal principles to plan and prepare SF operational elements for commitment and to direct and sustain those elements after commitment. The user must adapt the principles presented here to any given situation using his own professional knowledge, skills, and judgment. Because this manual articulates the collective vision of the senior SF leadership, users must understand that it describes emerging doctrinal requirements as well as current operational capabilities.

This manual is unclassified to ensure its Armywide dissemination and the integration of SF into the Army's systems. As the preparing agency for this manual and all SF doctrinal and training publications,

the US Army John F. Kennedy Special Warfare Center and School (USAJFKSWCS) will publish a series of subordinate field manuals to disseminate the specific SF tactics, techniques, and procedures (TTP) necessary to plan and conduct SF operations. The provisions of this publication are the subject of the international agreements listed in the references in the back of this book.

There are numerous terms, acronyms, and abbreviations found within this manual. Users should refer to Parts I and II of the Glossary for their meanings or definitions.

SF commanders and trainers at all levels should use this manual in conjunction with Army Training and Evacuation Program (ARTEP) mission training plans to plan and conduct their training.

The proponent of this publication is Headquarters, Training and Doctrine Command (HQ TRADOC). Users of this manual should submit comments and recommended changes on DA Form 2028 (Recommended Changes to Publications and Blank Forms) to Commander, USAJFKSWCS, ATTN: ATSU-DT-PDM, Fort Bragg, NC 28307-5000.

Unless otherwise stated, whenever the masculine gender is used, both men and women are included.

CHAPTER 1

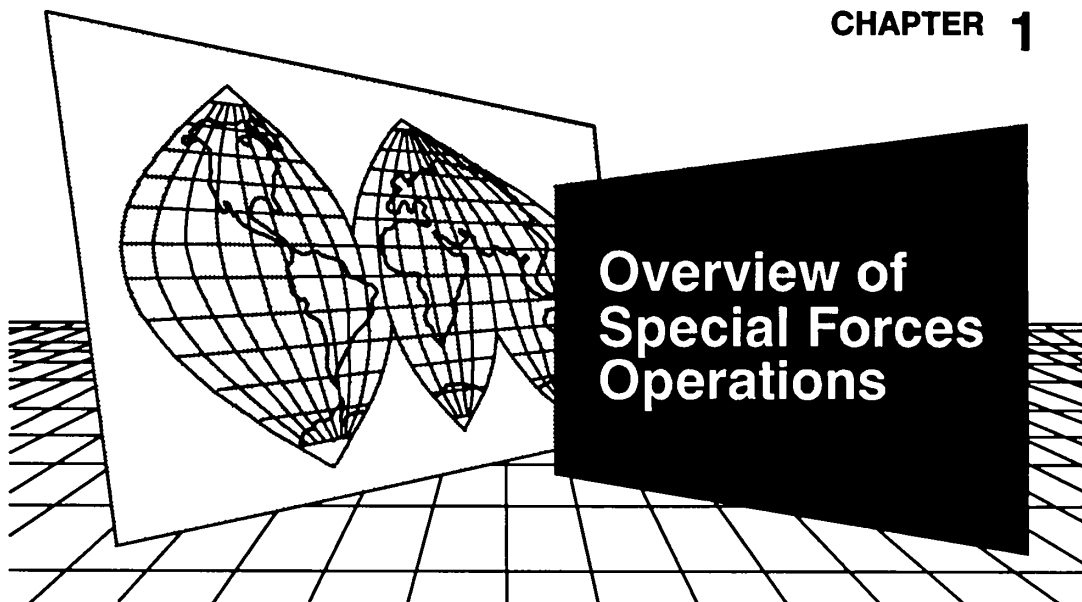

SF operations occur across the operational continuum and at all levels of war. They are an integral part of the broader category, special operations (SO). This chapter provides an overview of the strategic environment in which SF operations occur. It defines and describes the nature of SO. It discusses the principles that govern the design and execution of SO. It defines SF and discusses its roles in peace, conflict, and war. By placing SF operations in contemporary perspective, this chapter provides the foundation for all SF doctrine.

Strategic Environment

The threats to US national interests and objectives are more diverse now than ever before. The US national security policy and strategy are designed to protect US national interests from these threats. The President's annual report, *National Security Strategy of the United States*, and the annual *Secretary of Defense's Defense Planning Guidance* outline US national interests, major threats to those interests,

and major US national security objectives, policy, and strategy. Key US national interests include—

- The survival of the United States as a free and independent nation, with its basic values intact and its institutions and people secure.
- A healthy and growing US economy that provides individual opportunity for prosperity and a resource base for US national endeavors.
- A stable world without major threats to US interests.
- The growth of human freedom, democratic institutions, and free market economies throughout

the world, linked by a fair and open international trading system.

- Healthy and vigorous alliance relationships.

The Soviet Union still poses the main threat to US interests worldwide. Its military power and active diplomacy continue to threaten our interests in many parts of the world. However, the United States also faces other serious threats. These threats include—

- Regional conflicts.
- Proliferation of nuclear, biological, and chemical (NBC) and high-technology weapons.
- International terrorism.
- International drug trafficking.
- Radical politico-religious movements.
- Instability in countries that are important to the United States and its friends and allies.

National security strategy is the art and science of developing and synchronizing the political, military, economic, and informational elements of national power to secure national security objectives. The National Security Council (NSC) assists the President in formulating national security strategy. US national security strategy appears in classified national security directives (NSDs) and other classified NSC documents. In general, the goal of US peacetime strategy is to deter aggression and acts of intimidation against the United States and its allies. The goal of US national security strategy in conflict is to protect US and allied interests while precluding or limiting the direct employment of US combat forces. In war, the US strategic goal is to rapidly end

war on favorable terms at the lowest possible level of hostilities. National security objectives include—

- Securing the interests of the United States and its allies.
- Encouraging and assisting US allies and friends to defend themselves against aggression, coercion, subversion, insurgency, and terrorism.
- Ensuring US access to critical resources, markets, the oceans, and aerospace.
- Defending and advancing the cause of democracy, freedom, and human rights throughout the world.
- Resolving peacefully those regional disputes that affect US interests.
- Building effective and friendly relationships with all nations with whom there is a basis of shared concerns.

National military strategy is the art and science of employing the armed forces of a nation to secure national security policy objectives by the threat or application of force. The Joint Chiefs of Staff (JCS) formulate national military strategy for the Secretary of Defense. National military strategy appears in the Joint Strategic Capabilities Plan (JSCP) and other joint strategic planning documents. It supports the goals of national security strategy. National military strategic objectives include—

- Deterring Soviet direct and indirect expansionism worldwide.
- Defending North America and the Western Hemisphere.
- Promoting the collective security of Western Europe.
- Promoting regional stability in Latin America, East Asia, the Pacific, the Middle East, South Asia, and Africa.

Contemporary Perspective

Historically, US national security strategy, national military strategy, and military force development

have stressed deterrence through preparation for war with the Soviet Union and its allies and surrogates. The effectiveness of US nuclear and conventional deterrence has made the likelihood of such a war improbable. Nevertheless, the risks remain disproportionately high.

While the United States has successfully deterred war with the Soviet Union, conflicts short of war have become pervasive. These conflicts can directly affect each of the national security objectives stated above.

The contemporary strategic environment dictates that the US armed forces think in terms of an operational continuum made up of three conditions: peace, conflict, and war (Figure 1-1).

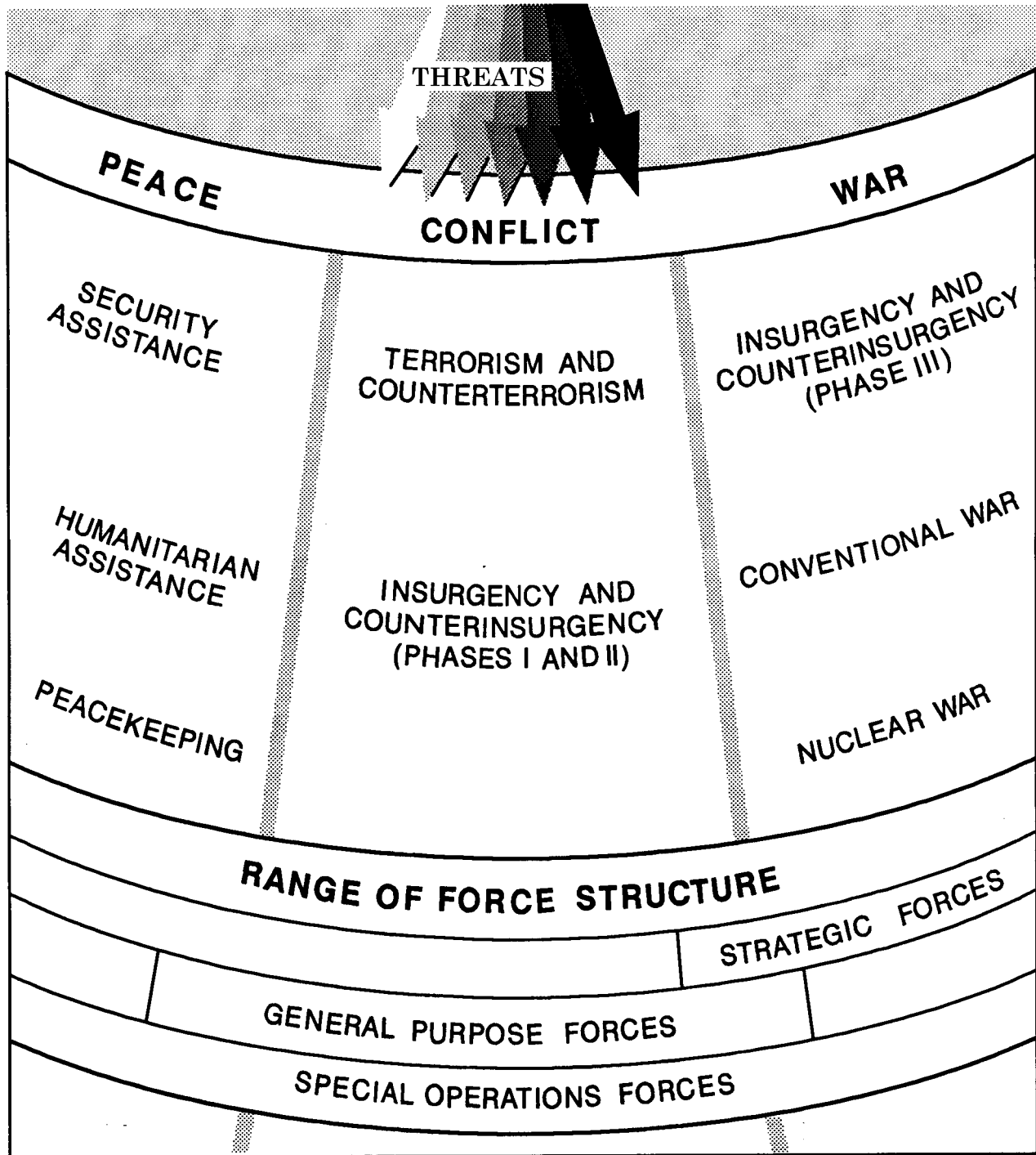

Figure 1-1. Operational Continuum.

Peace is defined as nonmilitary competition between states and other organized parties. Competition among foreign powers is inevitable in peace. Peaceful competition may promote conditions that lead to conflict or war. The military element of national power supports the three nonmilitary elements by preventing and deterring conflict and war.

Conflict is defined as a politico-military struggle short of conventional armed hostility between states or other organized parties. It is often protracted and generally confined to a geographic region, but may have global implications. The parties to a conflict often use military power in a strategically indirect manner to support or counter subversion, sabotage, terrorism, and insurgency. However, they can also use military power directly in short-duration, limited-objective contingency operations by conventional military forces and special operations forces (SOF). The term **low-intensity conflict (LIC)** represents the US perspective of a conflict. The term suggests that the conflict does not directly threaten US vital national interests. Another party to the same conflict may consider it a struggle for national

survival. From the US perspective, LIC includes the active support of parties to a conflict.

War, declared or undeclared, is defined as conventional, unconventional, or nuclear armed action between states or other organized parties. It may include any of the actions described in conflict, above. War may be general, involving the national survival and the total resources of nations. However, it is more commonly limited, with restraints on resources and objectives. The same war may be general for one party and limited for another party. War may include any of the actions included in the description of conflict.

The United States must have credible and competent military options to protect its national interests across the operational continuum. Strategic success requires a balanced force structure of strategic (nuclear) forces, general purpose forces, and SOF. These forces must deal with the full range of global threats—from the certainty of peacetime competition and conflict to the unlikely but potentially devastating threat of strategic nuclear war.

Nature of Special Operations

SO are actions conducted by specially organized, trained, and equipped military and paramilitary forces to achieve military, political, economic, or psychological objectives by nonconventional means in hostile, denied, or politically sensitive areas. They are conducted in peace, conflict, and war, independently or in coordination with operations of conventional forces. Politico-military considerations frequently shape SO, requiring clandestine, covert or low-visibility techniques, and oversight at the national level. SO usually differ from conventional operations in their degree of risk, operational

techniques, mode of employment, independence from friendly support, and dependence upon operational intelligence and indigenous assets.

Public law (10 USC 167) states that SO activities include the following as far as they relate to SO:

- Direct action (DA).
- Strategic reconnaissance, which the US Special Operations Command (USSOCOM) has incorporated into a broader activity called special reconnaissance (SR).
- Unconventional warfare (UW).
- Foreign internal defense (FID).
- Civil affairs (CA).
- Psychological operations (PSYOP).
- Counterterrorism (CT).
- Humanitarian assistance (HA).

- Theater search and rescue (SAR).
- Such other activities as may be specified by the National Command Authorities (NCA).

SOF are those forces specifically organized, trained, and equipped to conduct SO activities or provide direct support (DS) to other SOF. They provide a versatile military capability to defend US national interests. They are an integral part of the total

defense posture of the United States and a strategic instrument of national policy. These forces serve as force multipliers. They can function in an economy of force role to provide substantial leverage at a reasonable cost and effort. SOF thus provide military options for national response that can stabilize an international situation with minimum risk to US interests (Figure 1-2).

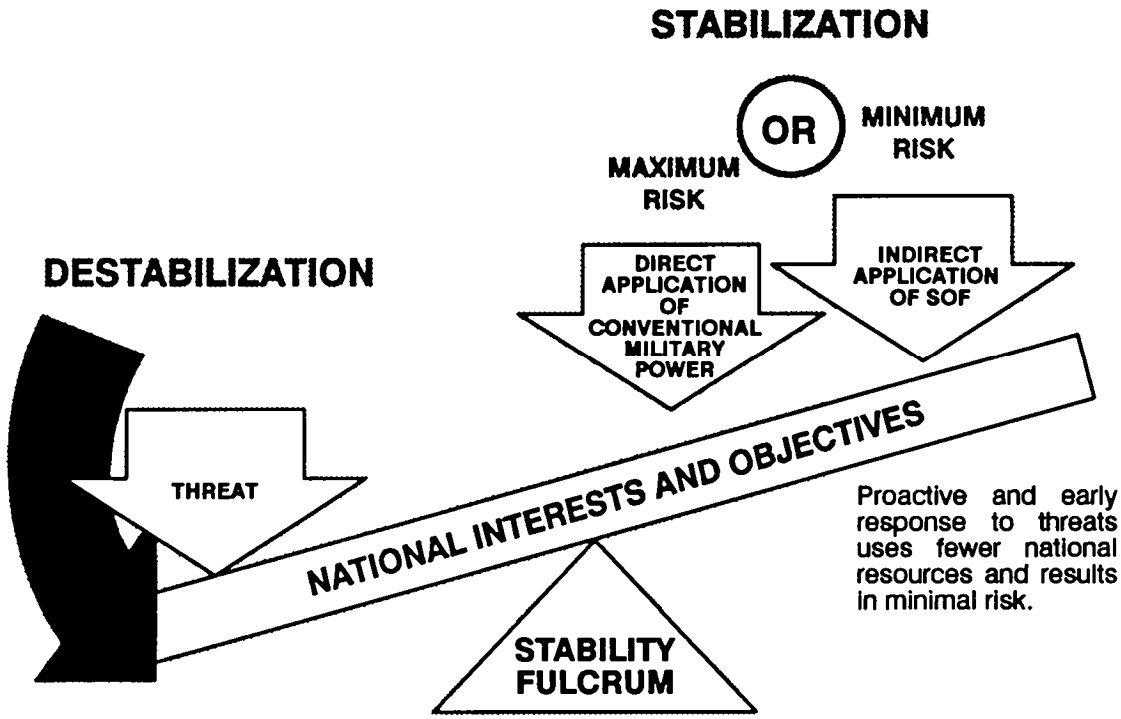

Figure 1-2. National Response.

SO Principles

When conducting tactical combat operations, SOF conduct their operations in accordance with the fundamentals of AirLand battle (ALB). AirLand

battle, the US Army's keystone warfighting doctrine, explains how Army forces plan and conduct major operations battles, and engagements in conjunction with other services and allied forces. It does not address military strategy or the formulation of strategic guidance. However, it does favor a strategy

that quickly and decisively attains the military strategic objectives of the war. (For a detailed discussion on AirLand battle, see FM 100-5.)

At the tactical level, SO often share many of the characteristics of light infantry combined arms operations. However, the fundamentals of AirLand battle doctrine focus primarily on conventional war fighting. The traditional objective of military power in war has been to generate maximum combat power at the decisive time and place to defeat hostile military forces. The traditional dynamics of military power are inappropriate in a conflict environment where—

- Nonmilitary aspects of the situation dominate military operations, or where

- No clearly defined enemy or battlefield exists.

In such an environment, the focus of military operations is different (Figure 1-3). Consequently, the contemporary dynamics of military power are more subtle. Commanders must influence (rather than dominate) their operational environment to create favorable politico-military conditions for achieving specific national security objectives. Because SO normally occur in such an environment, SOF commanders must adapt the fundamentals of AirLand battle to account for the politico-military implications of SO (Figure 1-4). They must learn to apply military power indirectly through the military and paramilitary forces of a foreign government or other political group or directly through the surgical use of combat power.

Application of the Principles of War

SOF commanders must apply the principles of war differently than conventional commanders. SOF commanders must recognize the effect of their operational environment and force capabilities on their application of the principles of war (Figure 1-5).

Objective

Objectives assigned SOF may often be as political, economic, or psychological as they are military. In war and protracted conflict, SO objectives usually focus on hostile military vulnerabilities. In other situations, SOF may be assigned objectives that lead directly to accomplishing national or theater political, economic, or psychological objectives.

Offensive

SO are inherently offensive actions. SOF may be employed as part of a strategic defensive, and hostile activities may force SOF to assume a tactical

defensive posture. Nevertheless, at the operational level, SOF are an offensive capability.

Mass

In contrast to conventional forces, SOF cannot hope to bring overwhelming combat power against a target except at the lowest tactical level. They do not normally seek dominance in size of force or firepower. Instead, SOF focus on selecting and applying sufficient military power to accomplish the mission without adverse collateral effects. The application of minimum force is dangerous, but SOF commanders must sometimes accept the higher risk associated with not massing in the conventional sense. They may have to compensate for their lack of combat power through the use of such combat multipliers as surprise, superior training, and unconventional tactics. Nonetheless, SOF commanders must concentrate their combat power, albeit subtly and indirectly, so that the effects of their actions are felt at decisive times and places. SOF must not be at the margin of their operational capabilities at critical points of mission execution. Care must be taken not to fragment the efforts of SOF by committing them

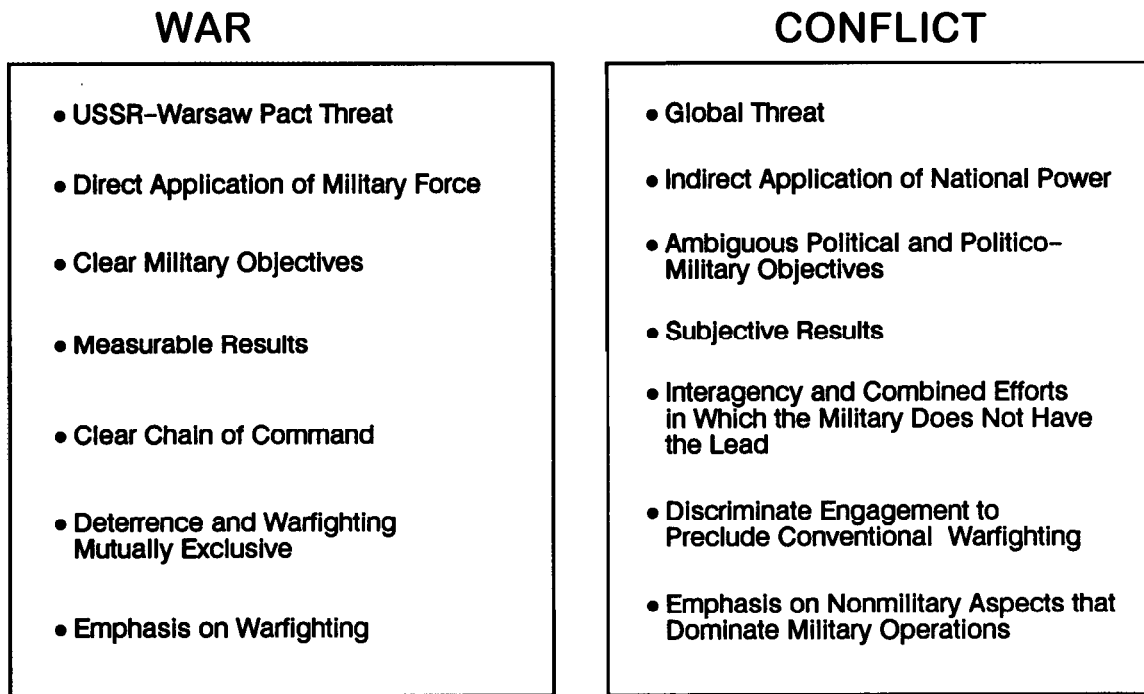

Figure 1-3. Differences in Focus.

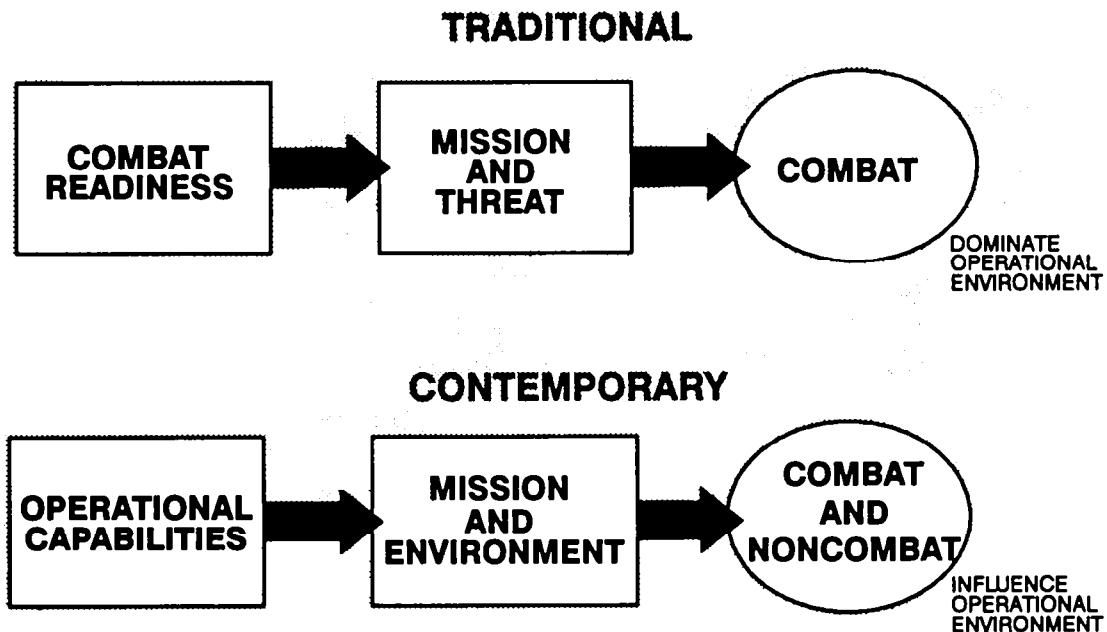

Figure 1-4. Dynamics of Power.

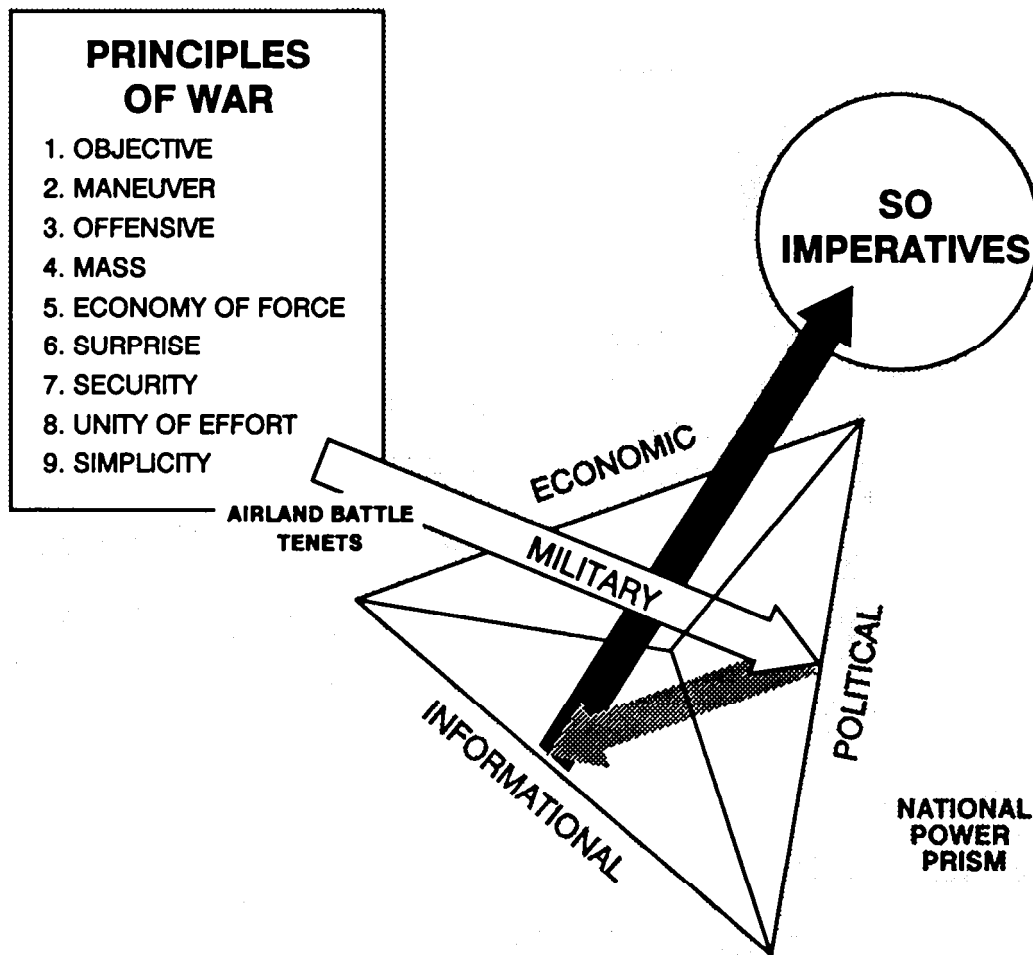

Figure 1-5. Application of Principles of War.

against targets that are tactically attractive, but operationally or strategically irrelevant.

Economy of Force

SOF are often employed as a strategic economy of force measure to allow the concentration of other forces elsewhere. Many SO are specifically designed to divert hostile forces into secondary theaters, preventing hostile concentration against the friendly main effort. SOF are particularly effective when employed in combination with indigenous or surrogate forces to create a force multiplier effect.

Maneuver

SOF do not maneuver against an enemy in the classic sense. Once committed, SOF often lack the tactical

mobility and reinforcement capability of the hostile forces opposing them. With respect to SO, maneuver implies the ability to infiltrate and exfiltrate denied areas so as to gain a positional advantage from which SOF can attack hostile vulnerabilities. They must anticipate hostile reactions and pre-position combat power to counter those reactions. This characteristic of SO dictates that SOF commanders accept calculated high risks to achieve decisive results. Indecision and hesitation may result in a lost opportunity, mission failure, or needless loss of life.

Unity of Command

To achieve unity of command, SOF organize jointly with clean, uncluttered chains of command that minimize the layering of headquarters. However, SO

are often conducted as interagency activities of the US government. In such cases the Department of Defense (DOD) will often play only a supporting role, and interagency cooperation will be the only means of achieving unity of effort. SOF commanders must synchronize their activities with nonmilitary members of the Country Team. During combined operations with indigenous military forces, SOF commanders must stress the requirement for cooperation between indigenous military and civilian organizations.

Security

In SO, security is often a dominant consideration, rather than a supporting consideration as is often the case in conventional operations. Because of the nature of many SO, a breach in security can affect national credibility and legitimacy as well as mission success. SOF commanders must emphasize security throughout mission planning, during execution, and possibly for many years after the mission incomplete. As a result, SO may require compartmentation and/or deception measures. Active and passive counterintelligence (CI) efforts must minimize the potential for hostile penetration or accidental disclosure of sensitive information.

Surprise

SOF achieve surprise by exploiting indirect approaches and doing the unexpected. SO often require bold, imaginative, and audacious actions, particularly when applying combat power directly and with surgical precision. In other SO, however, surprise can take on a more subtle meaning. SOF often conceal not only their capabilities and intentions, but also their activities. Indirect SO exploit the hostile power's inadaptability or misunderstanding of the operational environment. These operations can create unsettling conditions within a hostile power's environment without revealing the source. The effects of surprise are maximized when the hostile power cannot define the means of the disruption and, therefore, cannot implement effective countermeasures.

Simplicity

Although SOF often use sophisticated and unorthodox methods and equipment, their plans and procedures must be simple and direct. A complex and inflexible plan that relies on precise timing is less likely to withstand changing situations and the stress and confusion that accompany its execution.

SO Imperatives

While the principles of war *characterize* successful SO, the SO imperatives discussed below *prescribe* key operational requirements. SOF commanders must incorporate these imperatives into their mission planning and execution if they are to use their forces effectively (Figure 1-6).

Understand the Operational Environment

SOF commanders cannot dominate their environment. They must assess and understand all aspects of

the environment-political, economic, sociological, psychological, geographic, and military-before acting to influence it. The conditions of conflict can change based on military successor defeat, a change in hostile strategy or tactics, or fluctuating levels of US support. They must know who the friendly and hostile decision makers are, what their objectives and strategies are, and how they interact. They must influence friendly decision makers to ensure they understand the implications of SO mission requirements and the consequences of not adequately supporting them. SOF commanders must remain flexible and adapt their operations to changing realities. They must anticipate these changes in their environment to exploit fleeting opportunities. They

- **Recognize political implications.**
- **Facilitate interagency activities.**
- **Engage the threat discriminately.**
- **Consider long-term effects.**
- **Ensure legitimacy and credibility of SO.**
- **Anticipate and control psychological effects.**
- **Apply capabilities indirectly.**
- **Develop multiple options.**
- **Ensure long-term sustainment.**
- **Provide sufficient intelligence.**
- **Balance security and synchronization.**

Figure 1-6. SO Imperatives.

must also assist their supported indigenous military forces to adjust their strategy and tactics.

Recognize Political Implications

SOF commanders must not anticipate a conventional battlefield environment where military concerns dominate. The role of SOF infrequently a supporting one that creates the conditions for decisive non-military activities to occur. Whether conducting SO independently or in coordination with conventional military operations, SOF commanders must consider the political effects of their military activities.

Facilitate Interagency Activities

When participating in an interagency and often combined effort such as SO, commanders must strive for unity of effort (synchronization), but recognize the difficulty of achieving it. They must anticipate ambiguous missions conflicting interests and objectives, compartmentation of activity, and disunity of command. Lacking unity of command, SOF commanders must facilitate unity of effort by—

- Requesting clear mission statements and the decision makers' intent.

- Actively and continuously coordinating their activities with all relevant parties (US and non-US, military and nonmilitary).

Engage the Threat Discriminately

SOF commanders have limited resources they cannot easily replace. Their missions often have sensitive political implications. Therefore, SOF commanders must carefully select when, where, and how to employ SOF (Figure 1-7).

Consider Long-Term Effects

SOF commanders must place each discrete problem in its broader political, military, and psychological context. They must then develop a long-term approach to solving the problem. They must accept legal and political constraints (such as less than optimal rules of engagement [ROE]) to avoid strategic failure while achieving tactical success. SOF commanders must not jeopardize the success of national and theater long-term objectives by their desire for immediate or short-term effects. SO policies, plans, and operations must be consistent with the national and theater priorities and objectives

they support. Inconsistency can lead to a loss of legitimacy and credibility at the national level.

Ensure Legitimacy and Credibility of SO

There are significant legal and policy considerations to many SO, particularly in conflict situations short of war. In modern conflict, legitimacy is the most crucial factor in developing and maintaining internal and international support. Without this support the United States cannot sustain its assistance to a foreign power. The concept of legitimacy is broader than the strict legal definition contained in international law. The concept also includes the moral and political legitimacy of a government or resistance organization. Its legitimacy is determined by the people of the nation and by the international community based on their collective perception of the credibility of its cause and methods. Without legitimacy and credibility, SO will not receive the

support of foreign indigenous elements, the US population, or the international community. SOF commanders must ensure their legal advisors review all sensitive aspects of SO mission planning and execution.

Anticipate and Control Psychological Effects

All SO have significant psychological effects. Some may be conducted specifically to produce a desired psychological effect. SOF commanders must integrate PSYOP into all their activities to control these effects.

Apply Capabilities Indirectly

Whenever participating in combined operations, the primary role of SOF is to advise, train, and assist indigenous military and paramilitary forces. The supported non-US forces then serve as force multipliers in the pursuit of US national security

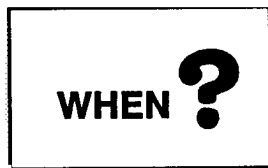

Employ SOF when nonmilitary options are insufficient and other military (conventional) options are inappropriate or infeasible.

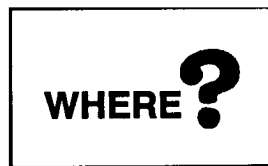

Employ SOF where results required are beyond the area of influence of conventional military forces.

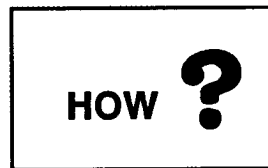

Employ SOF—

- With surgical precision to minimize collateral effects.
- In a concealed or covered manner so that only the effects are detectable.
- Indirectly through the military forces of a foreign government or political group.

Figure 1-7. SOF Employment Criteria.

objectives with minimum US visibility, risk, and cost. SOF commanders must avoid taking charge when supporting a foreign government or group. The foreign government or group must assume primary authority and responsibility for the success or failure of the combined effort. All US efforts must reinforce and enhance the legitimacy and credibility of the supported foreign government or group.

Develop Multiple Options

SOF commanders must maintain their operational flexibility by developing a broad range of options and contingency plans. They must be able to shift from one option to another before and during mission execution.

Ensure Long-Term Sustainment

SOF are currently engaged in protracted conflict around the world. They must prepare to continue this effort for the foreseeable future. The US response to conflict varies from case to case. Resourcing of any particular US support effort may also vary. SOF commanders must recognize the need for persistence, patience, and continuity of effort. They should not begin programs that are beyond the economic or technological capacity of the host nation (HN) to maintain without US assistance. US funded programs can be counterproductive if the population becomes dependent on them and funding is lost. SO policy,

strategy, and programs must therefore be durable, consistent, and sustainable.

Provide Sufficient Intelligence

SOF normally cannot infiltrate denied territory and develop an ambiguous situation. They do not have the combat power or the reinforcement and support capabilities of conventional forces to deal with unanticipated hostile reactions. The success of SO missions often depends on the executors receiving detailed, near-real-time, all-source intelligence products. This need for national and theater intelligence at the tactical level is unique to SOF. SOF intelligence requirements (IR) impose great demands on supporting intelligence capabilities. SOF commanders must identify their IR in priority. They must note which are mission essential and which are just nice to have. Without realistic priorities to guide it, the intelligence community can quickly become overcommitted attempting to satisfy SOF IR.

Balance Security and Synchronization

Security concerns often dominate SO, but compartmentation can exclude key personnel from the planning cycle. SOF commanders must resolve these conflicting demands on mission planning and execution. Insufficient security may compromise a mission, but excessive security will almost always cause the mission to fail because of inadequate coordination.

Special Forces

As a component of Army SOF (ARSOF), SF plans, conducts, and supports SO in all operational environments in peace, conflict, and war. SF operations are normally joint and may be combined and/or part of an interagency activity. They may support or be

supported by conventional forces. The role of SF varies with the environment and the level of activity.

SF is an unconventional combat arm. It combines at the lowest tactical level the functions performed by several conventional branches of the Army. In effect it is a **combined arms** branch. As a result, neither SF nor the conventional Army has thought

of SF operations as being combined arms operations. At best, SF commanders have employed the tactics of supplementary or reinforcing combined arms. They have used PSYOP, lift assets, and other resources to increase the effectiveness of independent SF operations. The old H-series table of organization and equipment (TOE) supported this concept of employment by consolidating all combat support (CS) and combat service support (CSS) assets at group level. Battalion commanders dealt only with **operational matters**. Their CS and CSS assets were provided from external sources when required.

The L-series TOE and the concept of SF employment in this publication recognize the complementary combined arms nature of SF operations. They also shift the level of combined arms integration from group to battalion. SF commanders must now integrate and synchronize their organic capabilities with those of other SOF and theater assets. By doing so, they generate sufficient military power to influence their operational environment. They apply this military power through indirect means or through the direct application of combat power in a specific, usually surgical, economy of force operation.

The Army uses seven battlefield operating systems (BOS) to analyze and integrate its activities (Figure 1-8). These BOS represent a new way of thinking about war because they orient on functions rather than the units that perform them. The BOS focus on

battlefield functions performed in a combat zone by Army units at corps level and below. In contrast, SF units normally focus on functions performed in a theater of operations by joint and combined forces at echelons above corps (EAC). Therefore, SF commanders must apply the BOS differently than conventional Army commanders do (see Appendix A).

The centerpiece of SF operations is the SF operational detachment (SFOD) A, also known as the A detachment. The SFOD A is a simple but versatile combined arms organization. Its activities do not revolve around a single weapon system (like a tank crew) or a single battlefield function (like a rifle squad). They cut across all BOS functions. Detachment members are generalists with expertise in at least one specialty, not functional specialists. Each member performs multiple functions during mission planning and execution.

Like the conventional Army, SF task organizes its elements into teams to execute a specific mission. An **SF team** is any size operational element composed mainly of SF members and led by a member of an SF chain of command. An SF team may be organized according to modification table(s) of organization and equipment (MTOE). It may be an SFOD A a composite team of hand-picked individuals or a combined arms team organized for a specific mission. It may also be as small as a two-man team or as large as a reinforced SF company.

Role of Special Forces in War

In a limited or general war, SF can perform its missions at the strategic, operational, or tactical level to influence, deep, close, or rear operations. However, the primary role of SF is to conduct and support deep operations beyond the forward limits of conventional military forces. Such operations may extend into a hostile power's homeland or into the territory

of hostile states that threaten lines of communication (LOC) in the friendly strategic rear. The impact of these operations may be felt throughout the theater of war.

During war, the strategic role of SF focuses on the hostile power's long-term capacity to continue hostilities. This role has two aspects.

The NCA, through the Chairman, Joint Chiefs of Staff (CJCS), may direct a unified commander to conduct SO in pursuit of national strategic objectives.

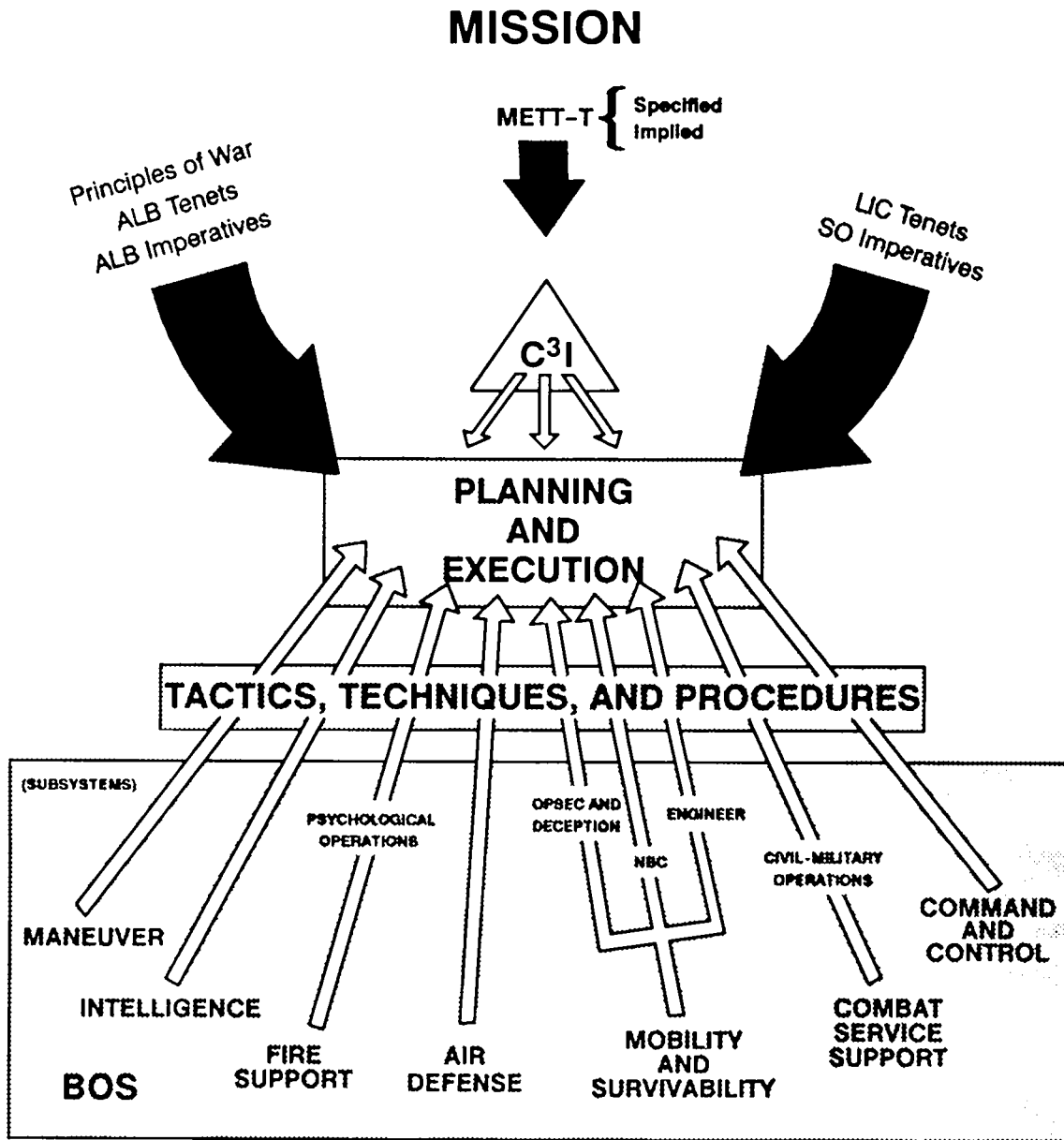

Figure 1-8. Battlefield Operating Systems.

For example, SF teams may deploy into denied territory to—

- Collect and report information of national strategic importance.
- Develop and support insurgences in the hostile power's strategic rear.
- Disrupt the economy.
- Protect friendly strategic LOC threatened by hostile regimes in the theater's strategic rear.
- Accomplish other missions with decisive strategic implications but with no *near-term* effect on conventional military operations.

MYTH: SF operates at the strategic level and is not part of the AirLand battle.

FACT: In war, SF conducts SO to support, complement, and extend conventional military operations. The employment of SF depends on the mission, not the environment in which it operates or its location on the battlefield. SF can be committed anywhere on the battlefield—deep, close, or rear (Figure 1-9).

SF also supports the unified commander's theater campaign plan by conducting deep operations in pursuit of theater strategic military objectives. The unified commander may employ SF teams to interdict the advance of hostile forces to gain more time for employing conventional forces. SF teams may perform SR tasks at the theater strategic level to identify hostile capabilities, intentions, and activities of importance to the unified commander. SF teams may also delay, disrupt, or harass the hostile power's strategic second-echelon forces (or divert them to secondary theaters of operations) to—

- Alter the momentum and tempo of hostile operations.
- Prevent the hostile power from conducting continuous theater strategic operations.

SF also conducts SO as strategic economy of force operations in secondary theaters. These operations may include FID missions in the strategic rear of the theater of war.

At the operational level, SF deep operations support the theater of operations commander and his subordinate land, air, and naval force commanders. At this level, SF operations have a **near-term** effect on **current** theater operations. By attacking hostile operational follow-on forces, SF disrupts their combined-arms operations and breaks their momentum, creating opportunities for friendly decisive action. SF operations can also—

- Collect and report military information of operational significance.
- Screen an operational land force commander's open flank.

- Attack or secure (for limited periods) critical facilities of operational significance.
- Divert hostile forces from the main effort.

At the tactical level, SF supports (and is supported by) conventional military forces whenever their operational areas converge. SF units lack the firepower, tactical mobility, real-time communications, and CSS capabilities to conduct sustained close combat operations. SF teams gain mobility and protection advantages through stealth and the use of restrictive terrain. They gain firepower advantage through surprise and superior training. SF missions generally rely on detailed pre-mission preparation that is unsuitable for fluid close operations. An SF team may conduct a DA or SR mission of strategic or operational significance in the corps main battle area. However, the priority of the mission and the nature of the target must justify the diversion of SF assets to a mission more suitable for conventional forces.

During a limited or general war, SF units may conduct operations in friendly rear areas. Friendly rear security forces may be nonexistent, particularly when US forces are operating in liberated or occupied territory. Available HN rear security forces may need advisory assistance or other support similar to the support SF provides in a FID mission. SF rear operations are proactive rather than reactive. SF teams do not defend base clusters or perform military police (MP) functions. They organize, train, and support (or direct) indigenous tactical combat forces to actively locate and destroy hostile insurgent and/or SO forces in contested areas. SF teams only conduct unilateral rear operations as an extreme measure.

SF rear operations are proactive rather than reactive. SF teams do not defend base clusters or perform military police (MP) functions. They organize, train, and support (or direct) indigenous tactical combat forces to actively locate and destroy hostile insurgent and/or SO forces in contested areas. SF teams only conduct unilateral rear operations as an extreme measure.

Once hostilities end, SF plays an important role in US posthostility consolidation activities. SF teams facilitate the early redeployment of US conventional combat forces by performing security assistance and FID missions that enhance the military capabilities of US allies in the region.

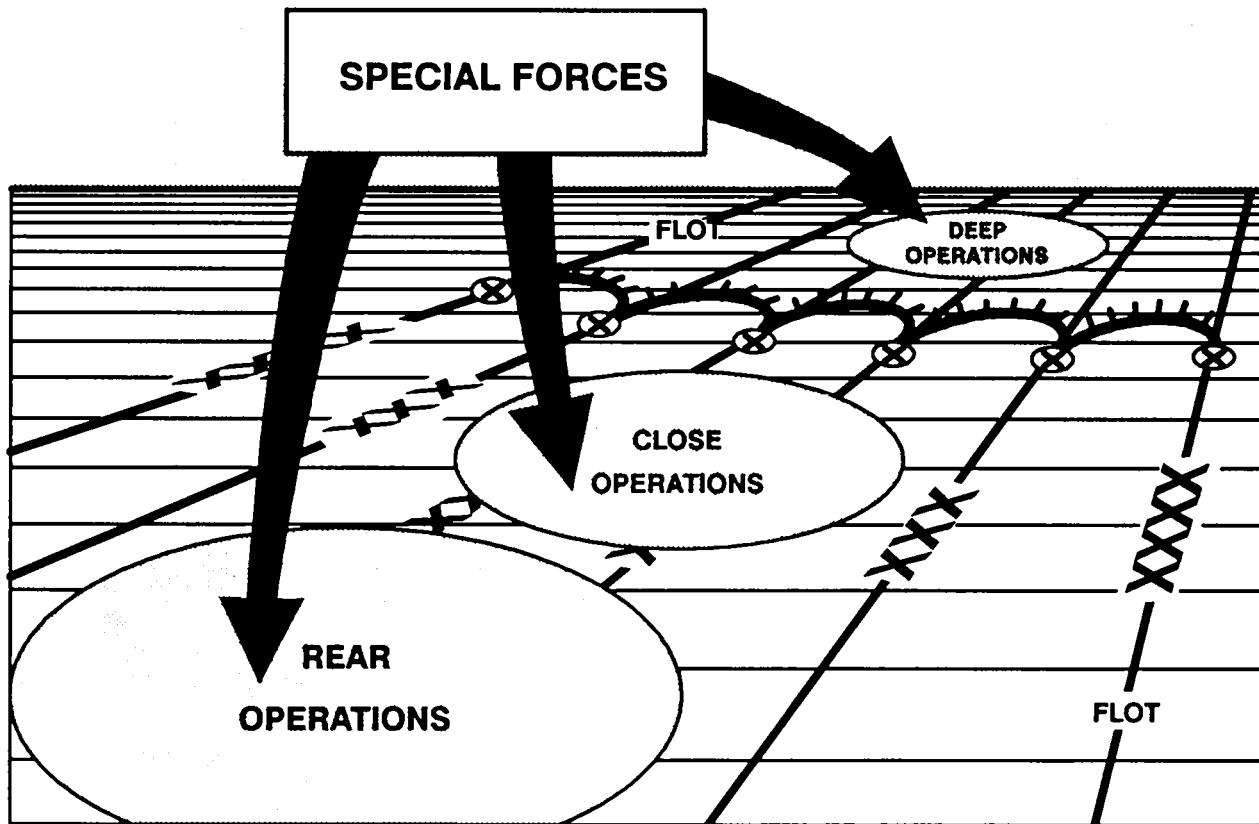
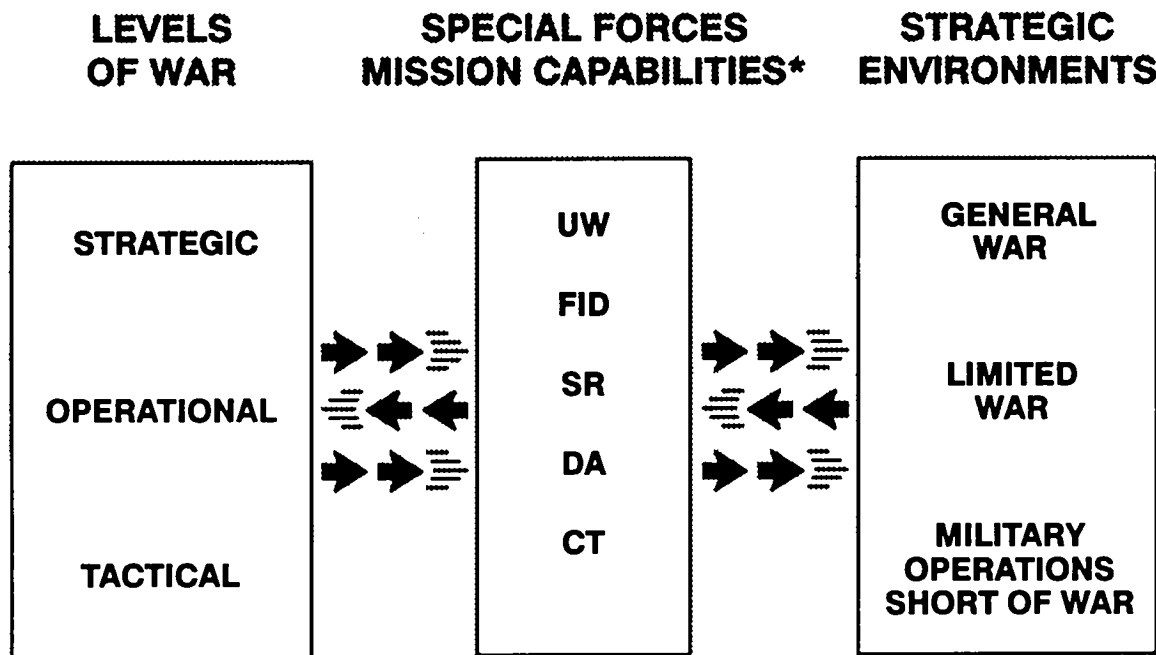

Figure 1-9. Role of SF in AirLand Battle.

Role of Special Forces in Conflict

In conflict situations short of war, the commitment of conventional combat forces may be premature, inappropriate, or infeasible. It may also increase the risk of further escalation to an unacceptable level. In these situations, when nonmilitary instruments of national power are inadequate to respond to a

conflict, SF provides the NCA with options for discriminate engagement that preclude or limit the need to employ conventional combat forces. The low visibility of SF operations helps the United States and its allies to maintain diplomatic flexibility. SF operations also allow other powers (friendly, neutral, and hostile) to accept the outcome of an operation because they avoid the publicity of a more obvious use of military force. Some operations, such as overt DA and CT missions, may have high visibility and affect the prestige of the nation.



* In DEEP, CLOSE, and REAR operations.

Figure 1-10. SF Operations Across the Operational Continuum.

MYTH: SF is primarily a LIC force.

FACT: SF has great utility in conflict short of war. However, it can perform any of its five primary missions across the operational continuum—during peace, conflict, or war (Figure 1-10). (For a detailed discussion of LIC, see FM 100-20.)

SF can conduct a FID mission to support a friendly government against an insurgent threat. The SF organization and its capabilities and operational methods make it ideally suited to conduct or support FID programs in a counterinsurgency environment. The primary SF mission in FID is to advise, train, and assist HN military and paramilitary forces.

SF can conduct a UW mission to support an insurgent or other armed resistance organization. The

United States may undertake long-term operations in support of selected resistance organizations that seek to oppose or overthrow foreign powers hostile to vital US interests. When directed, SF units advise, train, and assist indigenous resistance organizations. These units use the same TTP they employ to conduct a wartime UW mission. Direct US military involvement is rare and subject to legal and policy constraints. Indirect support from friendly territory will be the norm.

SF can conduct a DA or SR mission in support of a contingency operation. Contingency operations are politically sensitive military operations normally characterized by the short-term, rapid projection or employment of military forces in conditions short of war. Such employment can also require a large, highly visible buildup of military forces over extended periods. SF units task organize to participate in contingency operations either unilaterally or in conjunction with other military forces or government agencies.

Role of Special Forces in Peace

SF has both preventive and deterrent roles in peace. In its preventive role, SF participates in foreign internal development efforts and other programs designed to improve Third World conditions. In its deterrent role, SF maintains strategic capabilities that help convince hostile powers to respect US

national interests and refrain from acts of international aggression and coercion.

In peacetime, many SF training activities also have operational *real world* significance. For example, they may provide US presence in a troubled region, demonstrate US commitment, or otherwise contribute to collective security. The strategic value and political sensitivity of SF units make them inappropriate for employment in peacekeeping operations.

CHAPTER 2



The threats to SF operations are global and vary with the geopolitical environment, the SF mission, and the nature of conflict. Threat capabilities increase each year. The Soviets, their allies and surrogates, and nonaligned Third World countries continually improve the quantity and quality of their military capabilities. SF commanders must analyze the specific threats that exist in their particular operational areas. They must also recognize that threats considered under conflict also exist within the context of general and limited war, making threat analysis even more difficult. This chapter examines the diverse nature of these threats in terms of what SF can expect to face in general war, limited war, and conflict.

General War

In general war, the survival of the nation is at stake. The use of chemical and nuclear weapons is probable.

Nature of the Threats

General war poses the greatest threats to SF capabilities to infiltrate, communicate, and conduct operations in denied territory. The primary threats to SF in general war are—

- Hostile early warning, air defense, and coastal security and border security systems encountered by SF teams during infiltration and exfiltration.

- Hostile rear area security operations directed against deployed SF teams.
- Hostile interception and disruption of SF communications.
- Hostile NBC operations directed against SF bases and deployed SF teams.
- Hostile surveillance and deep attack of SF bases and deployments in the continental United States (CONUS) and overseas.

Infiltration and Exfiltration

The threats to each method of infiltration and exfiltration are different. The following paragraphs

illustrate typical threats SF teams face when infiltrating and exfiltrating by air, land, and sea.

SF teams infiltrating and exfiltrating by air must avoid an extensive and integrated air defense system. This system provides complete coverage at medium to high altitudes with a high redundancy of coverage in heavily defended areas. The Soviets in particular have made concerted efforts to improve low-altitude detection by—

- Increasing radar site density.
- Elevating radar antennas to overcome terrain limitations.
- Using height-finding early warning radars.
- Exploiting new radar technologies.
- Employing airborne early warning systems to detect aircraft flying at low altitudes.

SF teams infiltrating and exfiltrating by sea must pass through coastal security forces arrayed in overlapping zones. The outer ring consists of hostile surface craft and patrol submarines supported by land-based naval aviation. Closer to shore, coastal patrol vessels protect the coast from clandestine delivery and recovery. Fixed and mobile land-based coastal security forces defend key coastal installations and frontiers.

SF teams infiltrating and exfiltrating by land must avoid hostile border security forces. These forces employ sensors, minefield, other barriers, patrols, checkpoints, and other populace control measures to detect clandestine movement across closed borders. Once SF teams cross the border, they still face the rear area security threats discussed below.

Hostile Rear Area Security

SF teams must be able to operate in a restrictive social environment. Hostile powers rely on active and passive defense measures to protect their rear areas from disruption. They normally impose stringent populace and resources control (PRC) measures. If SF teams threaten their rear, hostile powers may dislocate entire civilian populations and dedicate significant combat power to isolate and neutralize the teams. In addition to regular military and internal security units, hostile powers employ local defense units drawn from the civilian population in threatened areas. A variety of fixed- and rotary-wing aircraft normally support these ground forces and

pose a significant threat to SF. Hostile police activity and informer networks also make SF operations difficult, even with the use of clandestine techniques. Moreover, significant portions of the population are likely to report any SF activity they detect.

Electronic Warfare

Hostile forces have an extensive electronic warfare (EW) capability. The Soviets in particular have large numbers of EW systems with broad coverage at great distances. Because SF communications have a unique electronic signature, their detection compromises the presence of an SF team even if the hostile force cannot locate it.

Hostile NBC Capabilities

Hostile forces have NBC weapons and plan for their use. Special Forces operational bases (SFOB) have always been likely NBC targets in general war. Now NBC weapons proliferation has greatly increased the likelihood of these bases becoming targets in a regional conflict. Moreover, recent combat experiences in the Third World indicate that SF teams deployed in remote and denied areas may also become targets. The risks for SF are significant.

The principal nuclear risk to SF teams is from the collateral damage effects of friendly nuclear bursts. There is also a danger of widespread fallout from large battlefield and theater weapons.

Biological weapons and toxins pose a significant threat to SF teams and their indigenous forces in remote areas. These weapons effectively cover wide areas with minimal resources. Their use is hard to verify, and defensive warning systems and protective measures are rudimentary.

Chemical weapons are generally low technology, inexpensive, and militarily significant even in modest quantities. The psychological impact of these weapons is tremendous, even when they produce relatively few casualties. Use of these weapons causes untrained or unequipped personnel to abandon their mission and leave the area.

Surveillance and Deep Attack

Hostile SOF and intelligence and sabotage agents pose a significant threat to SF in and around US

military installations, both in CONUS and abroad. During their normal peacetime activities, SF units are vulnerable to surveillance, sabotage, terrorism,

and direct attack. Strategic sabotage may adversely affect an SF unit's transition to active operations.

Limited War

From the US perspective, a limited war is generally confined to a specific region of the world. It is fought for limited objectives and does not threaten US national survival.

Nature of the Threats

In a limited war, SF may face all the threats associated with general war. Many regional powers now have military capabilities similar to those previously belonging only to superpowers. The armed forces of many Third World countries have a mix of Western and Communist weapons. These countries blend US, North Atlantic Treaty Organization (NATO), and Soviet doctrine to meet their particular wartime needs and their existing technologies. As a result, their military capabilities are difficult to analyze.

Infiltration and Exfiltration

Most regional powers do not have border or coastal security or air defense systems as integrated and comprehensive as those of the Warsaw Pact nations. SF infiltration and exfiltration usually do not pose the same problem anticipated in general war.

Hostile Rear Area Security

Internal security measures vary widely from country to country. The threat faced by SF teams may be similar to that discussed under general war, depending on the following factors:

- Density and capabilities of internal security forces.
- Severity of hostile PSYOP and PRC measures.
- Attitude of the local population.

Electronic Warfare

Hostile EW capabilities may not be extensive or integrated in a limited war. However, they still pose a significant threat to the SF command and control (C2) system.

Hostile NBC Capabilities

The use of nuclear weapons in limited war is improbable, but the likelihood of their use increases with Third World nuclear proliferation. The probability of biological and chemical weapons use in limited war varies from region to region. Chemical proliferation has greatly increased the likelihood of SF units becoming chemical targets during a conflict. Nonnuclear nations may use biological or chemical weapons for their psychological effect or as weapons of mass destruction.

Conflict

Conflict encompasses a broad range of complex environments for SF operations. The threats are not

easily identifiable. Much of the Third World is plagued by high population growth rates, social unrest, and political and economic instability. These conditions provide fertile ground for banditry,

terrorism, and insurgency. The Soviets and their allies have developed an effective strategy that supports and encourages **wars of national liberation**. Their aim is to establish Marxist-Leninist regimes and obtain bases of geostrategic importance. However, the Soviet Union is not the only foreign power exploiting Third World instability. Radical and reactionary states and other self-directed political groups also use armed conflict to pursue their interests. These interests may either threaten or complement US national interests.

Nature of the Threats

When operating in hostile or denied territory, SF teams face threats similar to those found in a limited war. When operating in friendly or contested territory, SF units are still subject to acts of espionage, sabotage, terrorism, and insurgency. **This section addresses only those threats not addressed in the previous paragraph.**

Insurgent organizations are the primary threats to SF in a counterinsurgency environment. Each insurgent organization is unique. Nevertheless, insurgent organizations can be categorized according to the general strategy they pursue.

The **subversive strategy** employs both legal and illegal means to penetrate and seize control of the established political system. Subversive insurgencies can quickly shift to the critical-cell strategy when conditions dictate. Examples of subversive insurgencies include Hitler's rise to power and the Communist takeover of Czechoslovakia.

The **critical-cell strategy** employs armed violence as a catalyst to create dissatisfaction and undermine the legitimacy of the established government without extensive political organization. A critical-cell insurgency may co-opt a mass popular revolution, as Lenin did in Russia. The insurgency may instead provide an armed cell around which mass popular support can rally in an atmosphere of disintegrating legitimacy. The Cuban revolution is an example.

The **mass-oriented strategy** emphasizes mobilization of the masses and extensive political organization as a prerequisite for a protracted politico-military struggle. Examples of this strategy include the Maoist

revolution in China, the Communist insurgency in Vietnam, and the Shining Path insurgency in Peru.

The **traditional strategy** employs existing tribal, racial, religious, linguistic, or other similar groups as the basis for a resistance organization. The traditional insurgency frequently seeks withdrawal from government control through autonomy or semi-autonomy, usually in response to government violence or other very specific grievances. Examples of this strategy include the Mujahideen in Afghanistan, the Ibo revolt in Biafra, and the Karen separatists in Burma.

International terrorist organizations have sophisticated covert and clandestine infrastructures and support mechanisms. Many receive support from foreign governments hostile to the United States and its allies. These organizations can inflict heavy damage and casualties that would preclude SF mission success. They generally consider SF personnel to be lucrative and legal targets.

Terrorist strategies are usually shorter range than insurgent strategies. Terrorists frequently do not seek popular support. They exploit mass media to publicize a cause, obtain a policy change, or intimidate a particular group.

Insurgences seldom follow precisely one of these four strategies. Terrorists and insurgents modify their strategies to fit their existing situation.

Hostile Rear Area Security

In a friendly nation, the security threat takes the form of espionage, sabotage, terrorism, and subversive activity. The severity of the threat varies widely from country to country.

Electronic Warfare

Hostile EW capabilities vary widely. SF must not equate intensity of conflict with sophistication of EW threat. Even insurgent and terrorist organizations may have significant EW capabilities.

Hostile NBC Capabilities

Hostile NBC capabilities also vary widely from conflict to conflict. Insurgents and terrorists may acquire and use NBC weapons to advance their cause.

CHAPTER 3

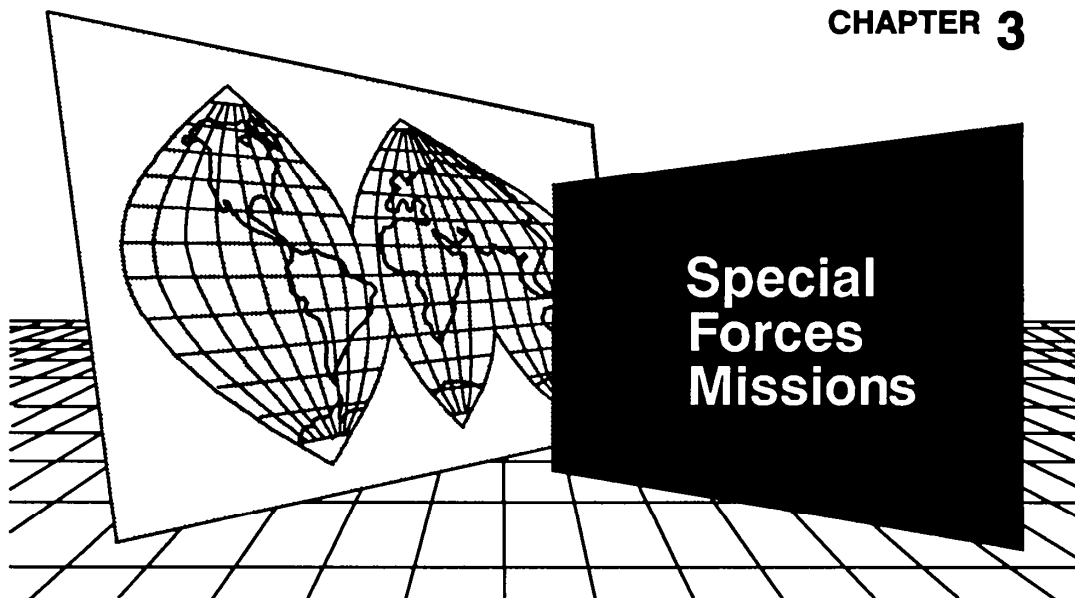

SF plans, conducts, and supports SO in all operational environments and across the operational continuum. The US Army organizes, trains, equips, and provides SF to perform five primary missions—UW, FID, DA, SR, and CT. (For SF, CT is a primary mission only for designated and specially organized, trained, and equipped SF units.) Mission priorities vary from theater to theater. SF missions are dynamic because they are directly affected by politico-military considerations. A change in national security policy or strategy may radically alter the nature of an SF mission. Indeed, a policy change may add or drop a mission. This chapter describes each SF mission in detail. Although the missions are treated separately, they are all interrelated.

Unconventional Warfare

UW is a broad spectrum of military and paramilitary operations, normally of long duration, predominantly conducted by indigenous or surrogate forces who are organized, trained, equipped, supported, and directed in varying degrees by an external source. UW includes guerilla warfare (GW) and other direct offensive low-visibility, covert, or clandestine operations, as well as the indirect activities of subversion, sabotage, intelligence collection, and evasion and escape (E&E).

MYTH: Insurgency differs from UW because insurgency gives priority to infrastructure and political development, while UW emphasizes military operations. SF conducts UW only during war.

FACT: Successful UW combat employment depends on an insurgent infrastructure resilient enough to withstand the hostile power's retaliation. SF can conduct UW in conflict or war.

UW is the military and paramilitary aspect of an insurgency or other armed resistance movement. Armed resistance provides UW with its environmental context. UW is thus a protracted politico-military activity. SF units do not create resistance movements. They provide advice, training, and assistance to indigenous resistance organizations already in existence. From the US perspective, the intent is to develop and sustain those organizations and synchronize their activities to further US national security objectives. When conducted independently, the primary focus of UW is on politico-military and psychological objectives. Military activity represents the culmination of a successful effort to organize and mobilize the civil population. When UW operations support conventional military operations, the focus shifts to primarily military objectives. However, the political and psychological implications remain. Regardless of whether UW objectives are strategic or operational, the nature of resistance and the fundamental UW doctrine, tactics, and techniques remain unchanged. UW includes the following interrelated activities: GW, E&E, subversion, and sabotage.

GW consists of military and paramilitary operations conducted by irregular, predominantly indigenous forces in enemy-held or hostile territory. It is the overt military aspect of an insurgency or other armed resistance movement.

E&E is an activity that assists military personnel and other selected persons to move from an enemy-held, hostile, or sensitive area to areas under friendly control. The special operations command (SOC) plans and directs all E&E activities in the theater.

The SOC may task the SF group to conduct and support these special category (SPECAT) activities. (See FM 21-77A for a detailed discussion of E&E.)

Subversion is an activity designed to undermine the military, economic psychological, or political strength of a nation. All elements of the resistance organization contribute to the subversive effort, but the clandestine nature of subversion dictates that the underground perform the bulk of the activity.

Sabotage is an activity designed to injure or obstruct the national defense of a country by willfully damaging or destroying any national defense or war materiel, premises, or utilities, to include human and natural resources. Sabotage may be the most effective or the only means of attacking specific targets beyond the capabilities of conventional weapons systems. It is used to selectively disrupt, destroy, or neutralize hostile capabilities with a minimum of manpower and materiel resources.

In UW, intelligence collection is designed to collect and report information concerning the capabilities, intentions, and activities of the established government, or occupying power, and its external sponsors. In this context, intelligence collection includes both offensive and defensive low-level source operations.

Contemporary UW takes on new significance for several reasons. Historically, SF has focused on UW as an adjunct to general war. However, the new US policy of supporting selected anti-communist resistance movements requires SF to focus on UW during conflicts short of war. Moreover, global urbanization dictates a shift in emphasis from rural GW to all aspects of clandestine resistance.

Foreign Internal Defense

FID is the participation by civilian and military agencies of a government in any of the action

programs taken by another government to free and protect its society from subversion, lawlessness, and insurgency. The primary SF mission in this inter-agency activity is to organize, train, advise, and assist HN military and paramilitary forces.

MYTH: SF is the Army's answer to counterinsurgency.

FACT: SF is well suited for FID missions in a counterinsurgency environment, but only within the context of a larger effort that is usually joint and interagency in nature.

In a counterinsurgency environment, SF operations may occur within or outside the HN. When

performing a FID mission, SF teams train, advise, and support HN forces conducting counterinsurgency operations. Other SF teams may conduct DA, SR, and CT operations in the HN, either unilaterally or with indigenous personnel. Still other SF teams may perform any or all of their wartime missions in hostile or politically sensitive territory near the HN.

In a limited or general war, SF units may conduct FID missions against armed resistance organizations opposing friendly conventional military operations. SF may also conduct FID missions to counter insurgencies in the strategic rear of the theater.

Direct Action

DA operations are short-duration strikes and other small-scale offensive actions by SOF to seize, destroy, or inflict damage on a specified target or to destroy, capture, or recover designated personnel or materiel. In the conduct of these operations, SOF may—

- Employ direct assault, raid, or ambush tactics.
- Emplace mines and other munitions.
- Conduct standoff attacks by fire from air, ground, or maritime platforms.
- Provide terminal guidance for precision-guided munitions.
- Conduct independent sabotage.

SF DA operations are normally limited in scope and duration and have a planned exfiltration. They are designed to achieve specific, well defined, and often time-sensitive results of strategic or operational significance. They usually occur beyond the range (or other operational capabilities) of tactical weapons

systems and conventional maneuver forces. DA operations typically involve the—

- Attack of critical targets.
 - Interdiction of critical LOC or other target systems.
 - Capture, rescue, or recovery of designated personnel or materiel.
-

MYTH: SF performed DA operations because the Army did not have any ranger units; now rangers are the primary DA force.

FACT: The roles of SF and rangers overlap in DA operations. SF DA operations require unconventional tactics and techniques, area orientation, and language qualification. Ranger DA operations use conventional tactics and specialized ranger techniques in platoon or greater strength. On occasion, DA operations may require a mix of SF and rangers. An SF team may serve as an advance party for an operation requiring ranger combat power, or a ranger force may provide security for a surgical SF operation.

Special Reconnaissance

SR is reconnaissance and surveillance conducted by SOF to obtain or verify, by visual observation or other collection methods, information concerning the capabilities, intentions, and activities of an actual or potential enemy. SOF may also use SR to secure data concerning the meteorological, hydrographic, or geographic characteristics of a particular area. SR includes target acquisition, area assessment, and post-strike reconnaissance.

MYTH: SR is essentially the same as the tactical reconnaissance performed by corps long-range surveillance units (LRSUs), but SF teams conduct SR deeper and for longer periods in hostile territory.

FACT: SF may employ battlefield reconnaissance and surveillance techniques similar to those used by LRSUs. However, SR is frequently more technology-intensive. SF teams use their UW tactics and techniques, area orientation, and language skills to accomplish more difficult reconnaissance tasks. They may use sophisticated clandestine collection methods.

SF may conduct SR in any operational environment in peace, conflict, or war. SF teams normally conduct SR missions beyond the sensing capabilities of tactical collection systems.

SR typically seeks to obtain specific well-defined, and time-sensitive information of strategic or operational significance. SF may use advanced reconnaissance and surveillance techniques or more sophisticated clandestine collection methods. During the critical transition from peace to war, the NCA, JCS, and unified commanders may have priority intelligence requirements (PIR) that only SF teams can collect. During war, SF teams deploy to named areas of interest (NAI) to collect and report information in response to specific PIR of the unified commander and his subordinate operational force commanders.

In a conflict, SF teams may perform SR missions at the strategic, operational, or tactical level. At the strategic level, SF teams collect and report critical information for the NCA, JCS, or unified commander in crisis situations and in support of national and theater CT forces. SF teams perform operational-level SR missions in support of insurgency, counterinsurgency, and contingency operations. SF teams may also perform tactical reconnaissance when the nature or sensitivity of the mission makes the use of LRSUs inappropriate.

Counterterrorism

CT is offensive measures taken by civilian and military agencies of a government to prevent, deter, and respond to terrorism. The primary mission of SOF in this interagency activity is to apply specialized

capabilities to preclude, preempt, and resolve terrorist incidents abroad. SOF involvement in CT is limited by HN responsibilities, Department of Justice (DOJ) and Department of State (DOS) lead agency authority, legal and political restrictions, and appropriate DOD directives. When directed by the NCA or the appropriate unified commander,

designated SOF units conduct or support CT missions that include—

- Hostage rescue.
- Recovery of sensitive material from terrorist organizations.
- Attack of the terrorist infrastructure.

Because of the very low profile of most terrorist organizations, identifying targets for CT missions can be extremely difficult. While a preemptive strike against terrorists may be preferred, CT missions must often be conducted after the terrorists have already initiated a terrorist incident.

For SF, CT is a special mission, not a generic mission applicable to all SF units. SF participation in CT is limited to those specially organized, trained, and equipped SF units designated in theater contingency plans. These designated SF units respond as directed by the NCA or unified commander to resolve specific situations arising from a terrorist incident. As part of the counterterrorist enhancement program (CTEP), these designated SF units may also train selected HN forces to perform CT missions.

Many CT missions remain classified. Further discussion of CT is beyond the scope of this publication.

Collateral Activities

In addition to their five primary missions, SF units perform collateral activities. These activities include SA, HA antiterrorism and other security activities, counternarcotics (CN), SAR, and special activities. SF units conductor support collateral activities using their inherent capabilities to perform their primary missions. SF commanders should anticipate their collateral requirements and ensure their units prepare for them.

Security Assistance

SA is a group of programs authorized by the Foreign Assistance Act, the Arms Export Control Act, or other related US statutes. The US government provides defense articles and services, including training, to eligible foreign countries and international organizations that further US national security objectives. The primary SF role in SA is to provide mobile training teams (MTTs) and other forms of mobile training assistance. Public law prohibits personnel providing SA services (to include mobile training assistance) from performing combatant duties. (See DOD 5105-38-M, AR 12-1, and AR 12-15 for detailed discussions on SA programs.)

Humanitarian Assistance

HA is any military actor operation of a humanitarian nature. These activities include disaster relief, non-combatant evacuation, and support to and/or resettlement of displaced civilians. SF units are well-suited to perform HA activities in remote areas, particularly in a conflict environment. Several programs authorize the use of DOD resources for humanitarian and civil assistance and for foreign disaster relief. Combatants to include members of certain friendly resistance organizations, are eligible for assistance under some of these programs. All SF participation in such activities requires significant interagency coordination.

Antiterrorism and Other Security Activities

These activities ensure the physical security of important persons, facilities, and events meets acceptable security standards. Responding to requests from the services and other government agencies, SF can provide training and advice on how to reduce vulnerability to terrorism and other hostile threats. SF teams use their UW expertise to anticipate hostile activity and evaluate the adequacy of existing physical security systems. When directed, SF capabilities can augment existing security for important persons and events.

Counternarcotics

CN activities are measures taken to disrupt, interdict, and destroy illicit drug activities. The levels of violence used by the drug infrastructure dictate the increased use of military and paramilitary forces in CN activities. A 1981 amendment to the Posse Comitatus Act (18 US Code 1385) authorizes specific DOD assistance in drug interdiction and drug eradication. The primary SF role in this interagency activity is to support US and HN CN efforts abroad.

The DOS's Bureau of International Narcotics Matters and the DOJ's Drug Enforcement Administration (DEA) are normally the lead US operational CN agencies within a HN. When these agencies or the HN requests military assistance, SF teams may be directed to provide in-country or out-of-country (offshore) training to US and HN CN forces. SF advisors may also assist CN staffs in planning, organizing, and conducting large-scale, long-term CN operations. When authorized and subject to legal and policy constraints, SF advisors may also accompany CN forces on actual operations.

Search and Rescue

SF can participate in theater SAR efforts. These activities are designed to locate, recover, and restore

to friendly control selected persons or materiel that are isolated and threatened in sensitive, denied, or contested areas. They focus on situations that involve political sensitivity and/or remote or hostile environments. These situations may arise from a political change, combat action, chance happening, or mechanical mishap. When directed, SF units perform combat search and rescue (CSAR) missions using collateral capabilities inherent in a DA recovery mission. SF does not employ standard CSAR procedures when executing such a mission.

Special Activities

Special activities require presidential approval and congressional oversight. Executive Order 12333 states that no agency except the Central Intelligence Agency (CIA) may conduct any special activity in peacetime unless the President so directs. When directed by the President, the DOD performs special activities during war declared by Congress or during any period covered by a presidential report under the War Powers Resolution. Whether supporting or conducting a special activity, an SF unit may perform any of its primary wartime missions, subject to the limitations imposed on special activities. Such activities are highly compartmented and centrally managed and controlled.

Other SO Activities

The categorization of SO activities as primary missions and collateral activities focuses on *what* SOF do. In some cases, it is more important to focus on *why* SOF conduct SO. The physical result of SO may be secondary to some greater purpose. Deception operations, demonstrations, and shows of force are examples of such operations.

Deception Operations

SF can support and enhance a national or theater deception plan. SF deception operations distort, manipulate, or falsify facts to induce a foreign government or group to react in a manner favorable to US interests. These operations also enhance friendly operations security (OPSEC). SF may perform deception as part of another mission or as an operation in itself. Whenever possible, the SF

deception role should be combined with other SO to make the deception more credible.

Demonstrations and Shows of Force

These operations are overt demonstrations of national intention or resolve. The NCA initiate them to influence another government or political group to respect US interests or to enforce international law.

They may involve the forward deployment of military forces, combined training exercises, and the introduction or buildup of military forces in a region. Demonstrations and shows of force are not meant to deceive the target audience. These operations may meet with a hostile response, so they must be planned and executed to counter such a response. SF units are well-suited for certain demonstrations and shows of force because of their strategic capabilities.

Multiple and Follow-On Missions

Actual operational requirements often cut across doctrinal mission lines. An SF team may conduct an operation involving multiple missions. It may also receive a follow-on mission after its initial mission.

Multiple missions are appropriate when operational requirements demand the application of TTPs drawn from more than one doctrinal mission. For example—

- An SF team may acquire a target (SR mission) and then provide terminal guidance for precision guided munitions launched against the acquired target (DA mission).

- An SF team may conduct an area assessment (SR mission) and then remain in the joint special operations area (JSOA) to develop an indigenous resistance organization (UW mission).

Follow-on missions are appropriate when the risk of exfiltration is greater than the risk of remaining in the operational area. They are also appropriate when the importance of the follow-on mission justifies leaving the SF team in the JSOA. For example—

- An SF team may conduct a DA mission against a specified target, then link up with a resistance organization or a bypassed or cutoff conventional force to conduct a UW mission.
- An SF team conducting another mission may be directed to recover a downed aircrew or other designated personnel or materiel.

CHAPTER 4

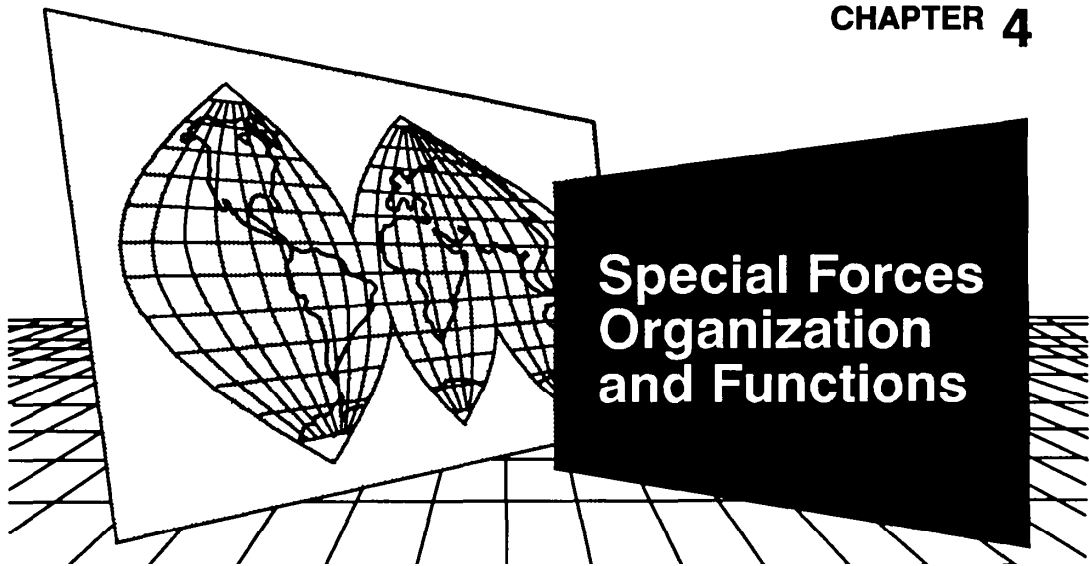

SF group commanders routinely task organize companies and battalions to create mission-oriented teams and task forces. This chapter describes the formal organization of the SF group and its organic elements. Later chapters will expand on this chapter to explain how and why SF commanders task organize their units.

Special Forces Group (Airborne)

The Special Forces group (airborne) [SFG(A)] is a multipurpose and extremely flexible organization. Its mission is to plan, conduct, and support SO in any operational environment in peace, conflict, and war. Figure 4-1 depicts the group's organization.

The group's C2 and support elements can function as the headquarters for an Army special operations task force (ARSOTF) or for a joint special operations task force (JSOTF) when augmented by resources from

other services. The group's C2 and support elements can (see Chapter 5)—

- Establish, operate, and support an SFOB and three forward operational bases (FOBs).
- Provide three special operations command and control elements (SOCCs) to conventional headquarters at corps level or higher.
- Train and prepare SF teams for deployment.
- Direct, support, and sustain deployed SF teams.

The group's SF teams infiltrate and exfiltrate specified operational areas by air, land, or sea. They conduct operations in remote areas and non-permissive environments for extended periods with

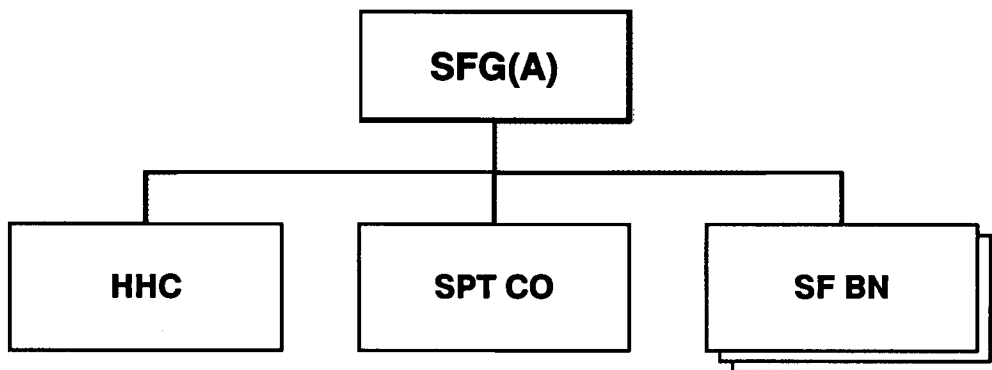

Figure 4-1. SFG(A) (TOE 31-800L0).

minimal external direction and support. SF teams can also—

- Develop, organize, equip, train, and advise or direct indigenous military and paramilitary forces.
- Plan and conduct unilateral SF operations.
- Train, advise, and assist other US and allied forces or agencies.
- Perform other SO as directed by the NCA or a unified commander.

Headquarters and Headquarters Company, SFG(A)

The group headquarters and headquarters company (HHC) provides C2, staff planning, and staff supervision of group operations and administration. Its organization is depicted in Figure 4-2.

Functions

The group headquarters commands and controls assigned and attached forces. It—

- Plans, coordinates, and directs SF operations separately or as a part of a larger force.
- Trains and prepares SF teams for deployment.

- Provides command and staff personnel to establish and operate an SFOB.
- Provides advice, coordination, and staff assistance on the employment of SF elements to a joint SOC, JSOTF, security assistance organization (SAO), or other major headquarters.
- Provides cryptomaterial support to the SFOB and its deployed SF teams.

The headquarters company provides routine administrative and logistical support to the group headquarters. It depends on the group support company for unit-level maintenance of its organic wheeled vehicles, power generation equipment, and signal equipment. When the group establishes an SFOB, the HHC commander serves as headquarters commandant under the direct supervision of the deputy group commander. As headquarters

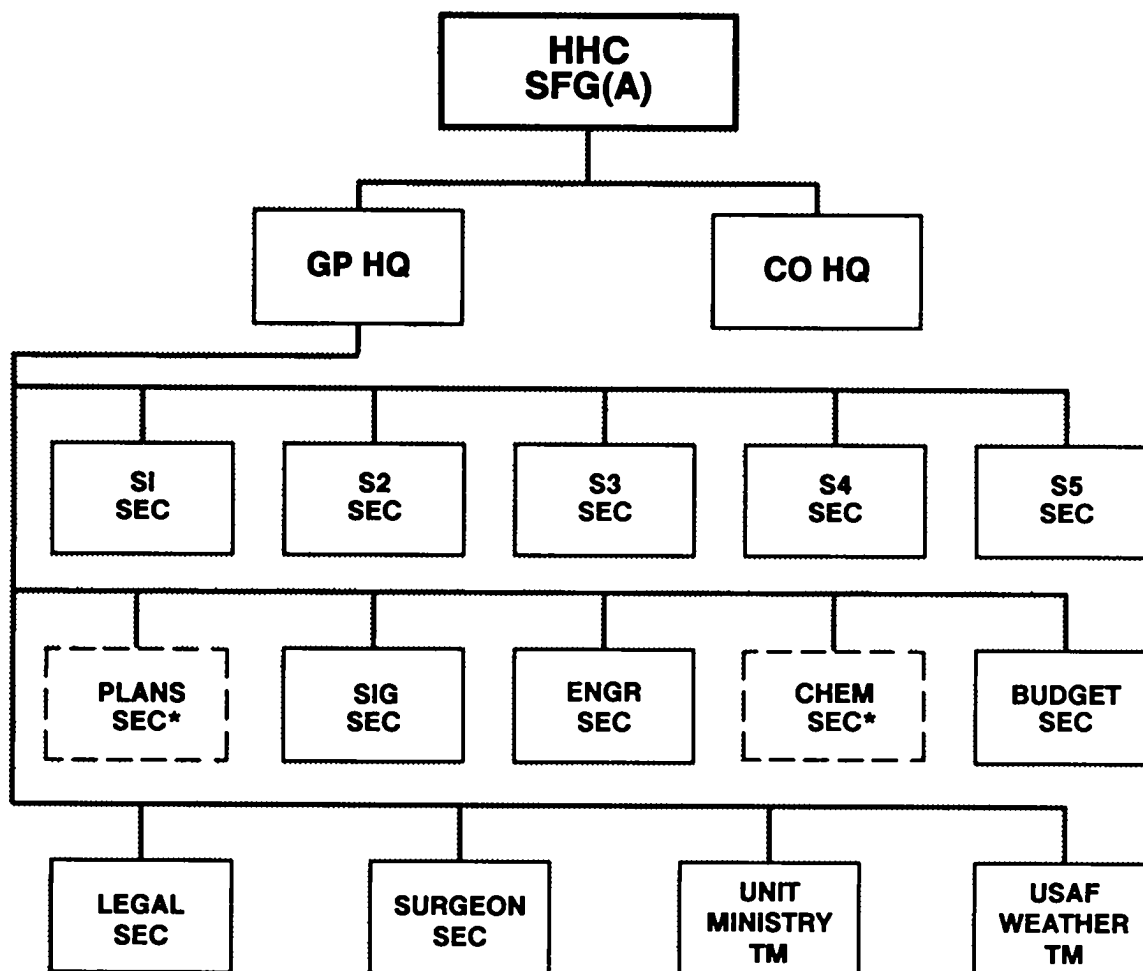

* Not on TOE. Group commander may establish provisionally or by MTOE.

Figure 4-2. HHC, SFG(A) (TOE 31-802L0).

commandant, the HHC commander is responsible for the movement, internal administration (to include space allocation, billeting, and food service), and physical security of the group headquarters and the SFOB operations center (OPCEN).

Command and Staff Responsibilities

The group commander exercises command of the group and its attached elements. When the group establishes an SFOB, he is the SFOB commander.

The deputy commander performs those duties assigned to him by the group commander. He assumes command of the group in the commander's absence. When the group establishes an SFOB, he serves as the OPCEN director. The group commander commands the group, but the deputy commander directs its day-to-day activities. The relationship between the group commander and his deputy commander normally is such that the deputy commander can act for the commander when the commander is absent or involved with more important tasks.

The executive officer (XO) performs duties similar to those of a chief of staff. He directs the group staff and assigns specific responsibilities to prepare plans, orders, reports and other staff actions. When the group establishes an SFOB, he serves as director of the battle staff.

The S1 is the principal staff officer for all personnel service support (PSS) matters and other administrative matters not assigned to another coordinating staff officer. He may perform special staff officer duties, such as inspector general, provost marshal, public affairs officer, and special services officer. Additional duties include safety, postal operations, and the management of stragglers and hostile prisoners of war (PWs). His primary operational concerns are replacement operations, strength management, and casualty reporting. He directly supervises the group personnel section and exercises staff supervision over attached PSS and MP units.

The S2 is the principal staff officer for all matters pertaining to intelligence and counterintelligence. He plans for the collection, processing, and dissemination of intelligence that is required for SF group operations. He advises the commander in the employment of group intelligence assets. He provides special security office (SSO) support to the SFOB. He provides the S3 with intelligence support for the OPSEC program, EW operations, and deception planning. He exercises staff supervision over the group's military intelligence (MI) detachment, the DS engineer terrain detachment (when attached from the theater army [TA] engineer command), and attached MI units.

The S3 is the principal staff officer for all matters pertaining to the organization, training, and operations of the group. He has overall staff responsibility for PSYOP, OPSEC, EW, CSAR, and deception. He exercises staff supervision over organic and attached aviation and PSYOP units.

The S4 is the principal staff officer for all logistics matters. He is the group's primary logistical planner and coordinator. He exercises staff supervision over the group support company's service detachment and attached logistical units. He coordinates closely with the four support company commanders, who are the principal logistical operators of the group.

The S5 is the principal staff officer for all CA matters. He plans and coordinates the group's civil-military operations (CMO), to include foreign nation support (FNS). He advises the commander on politico-military matters and assists him in meeting his legal and moral obligations to the local populace. He exercises staff supervision over attached CA elements.

The signal officer is the principal staff officer for all signal matters. He plans and recommends employment of SF group communications. He is also the tactical command information systems (TCIS) management officer with staff responsibility for automation. He assists the S3 in preparing EW plans and is responsible for electronic counter-countermeasures (ECCM). He supervises the group's frequency manager and preparation of the group signal operation instructions (SOI). He coordinates and exercises technical supervision over training of organic and attached communications personnel. He exercises staff supervision over the SFOB signal center (SIGCEN). He is also the group communications security (COMSEC) officer and supervises the group COMSEC custodian, who maintains the group COMSEC account.

The budget officer is the principal staff officer for all matters pertaining to programming, budgeting, receiving, handling, safeguarding, and disbursing all program funds. These include special mission funds, intelligence contingency funds, foreign currency operations, and commercial accounts. He coordinates and exercises technical control over group financial policies, plans, and services. If the budget officer is qualified and acceptable under the provisions of AR 37-103, the supporting finance and accounting officer may appoint him as a deputy or Class B agent officer.

The engineer is the principal advisor to the commander and staff on engineer matters. He exercises staff supervision over attached engineer units. He coordinates and exercises technical supervision over training of organic and attached engineer personnel. He plans and coordinates the group's real estate and construction requirements and real property maintenance. He establishes the group's emergency action facility (EAF) and manages the group's emergency action program (EAP).

The chemical officer is the principal advisor to the commander and staff for all matters concerning offensive and defensive chemical operations. He exercises technical supervision over group NBC activities and staff supervision over attached chemical units.

The flight surgeon is the principal advisor to the commander and staff for all matters affecting the mental and physical health of the group, attached elements, and its supported indigenous forces. He directly supervises the group's medical section and exercises staff supervision over attached medical units. He coordinates and exercises technical control over training of organic and attached medical personnel.

The chaplain is the principal advisor to the commander and staff on moral, ethical, and religious issues affecting the unit mission. He plans and coordinates the activities of unit ministry teams (UMTs) to ensure comprehensive religious support of all assigned and attached personnel and their

families. He assesses the religious attitudes of indigenous populations to determine the impact of these attitudes on SF operations.

The judge advocate is the principal advisor to the commander and his staff on legal matters. He advises on matters involving military law, US domestic law, foreign law, status of forces agreements, international law, operational law, and ROE. He reviews all sensitive mission taskings, plans, and orders to ensure they adequately address legal issues. He may perform additional duties as public affairs officer when no full-time public affairs officer is attached to the group.

The command sergeant major (CSM) is the group's senior noncommissioned officer (NCO). He is the principal advisor to the commander and staff on matters pertaining to enlisted personnel. He monitors policy implementation and standards on the performance, training, appearance, and conduct of enlisted personnel. He provides counsel and guidance to NCOs and other enlisted personnel.

Support Company, SFG(A)

The group support company (Spt Co) provides intelligence support, CSS, and signal support to the SFOB and its deployed SF teams. The company's aviation platoon provides general aviation support to the entire group. The company's organization is shown in Figure 4-3. Its functions are discussed below.

The Spt Co commander commands all personnel and elements assigned or attached to the company. His company headquarters provides routine administrative and logistical support to the SFOB support center (SPTGEN) and SIGCEN. He is the group's primary logistical operator. When the group establishes an SFOB, he serves as the SPTCEN director. His duties require direct interface with TA logistical support elements (see Chapter 14). In

coordination with the S3 and headquarters commandant, the Spt Co commander prepares the base defense plan and supervises base defense operations center (BDOC) activities (see Chapter 6).

The MI detachment provides integrated all-source intelligence collection management, analysis, production, and dissemination in support of group-level situation and target development. These functions correspond to those performed by the tactical operations center (TOC) support element of a conventional MI unit. The detachment establishes and operates a tactical sensitive compartmented information facility (SCIF) in the SFOB OPCEN and provides sensitive compartmented information (SCI) communications between the SFOB and the deployed FOBs. It provides interrogation and CI support, to include CI support of the group's OPSEC and deception programs. The detachment commander works for the deputy group commander

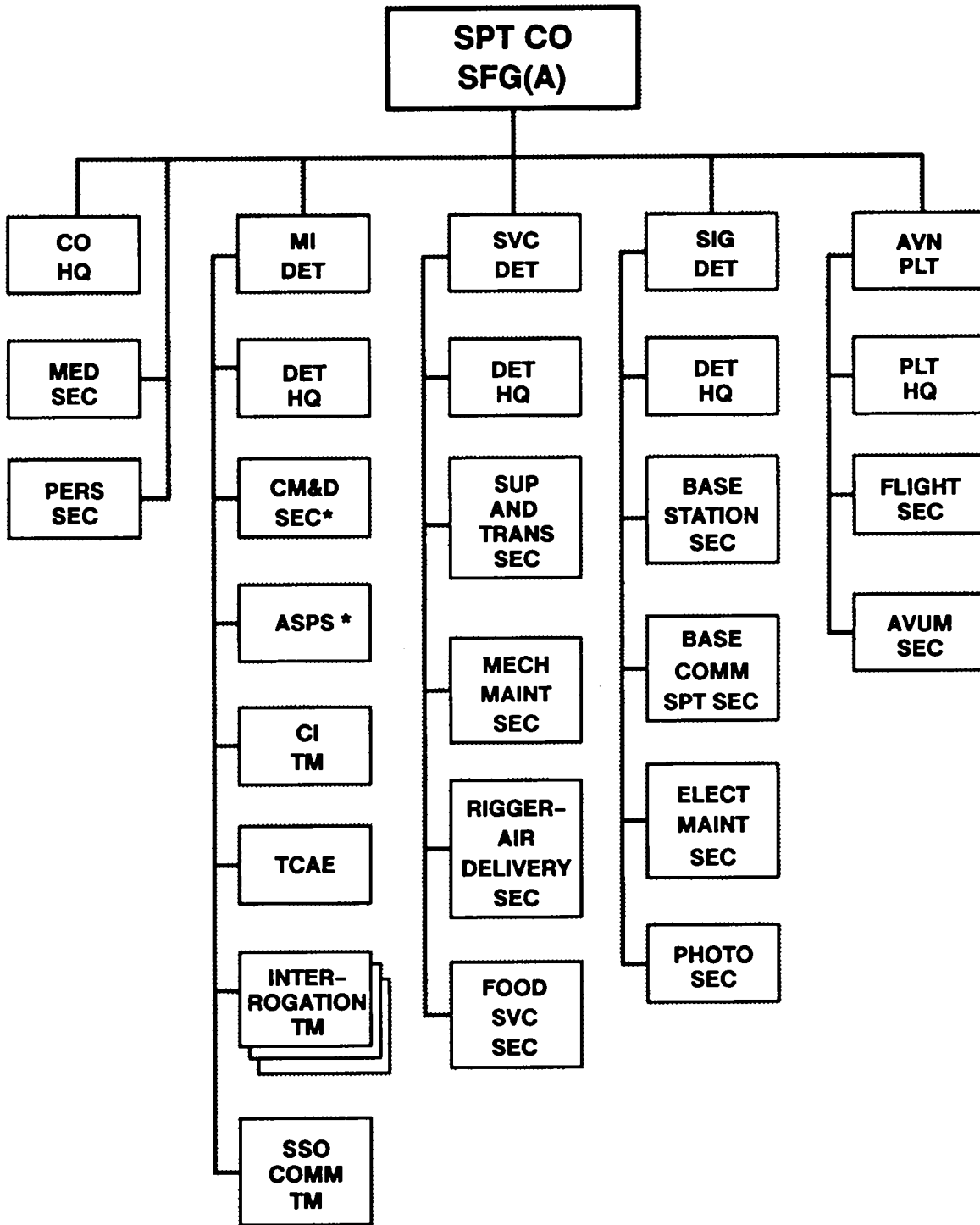

* ASPs and CM&D section are consolidated on TOE.

Figure 4-3. Spt Co, SFG(A) (TOE 31-803L0).

under the staff supervision of the group S2. When the detachment is formally detached from the support company, the detachment commander exercises normal company-level command. However, the detachment remains dependent on the Spt Co for administrative and logistical support.

The service detachment performs unit-level supply, services, and maintenance functions for the group HHC and Spt Co and their attached elements. When the group establishes an SFOB, the service detachment commander coordinates and supervises SPTCEN logistics. He works for the Spt Co commander under the staff supervision of the S4.

The signal detachment has two primary functions. It installs, operates, and maintains secure SFOB radio communications with the FOBs and deployed SF teams. It also installs, operates, and maintains continuous internal SFOB communications. This base communications support includes communications center services, telephone communications, electronic maintenance, and photographic support. When the group establishes an SFOB, the signal detachment commander serves as the SIGCEN director. When the detachment is formally detached from the Spt Co, the detachment commander exercises normal company-level command. However,

the detachment remains dependent on the Spt Co for administrative and logistical support.

The aviation platoon provides limited general (non-tactical) aviation support to the group and its attached elements. The platoon headquarters receives, processes, and coordinates all group general aviation support requirements. It also establishes and operates the SFOB's flight OPCEN. The aviation unit maintenance (AVUM) section maintains organic aircraft and avionics equipment used by the flight section.

The medical section provides health service support (HSS) to the SFOB. This support includes unit-level medical support, medical supply (to include maintenance of the Class VIII basic load), emergency medical and resuscitative treatment for all classes of patients, emergency dental treatment, preventive medicine support, and veterinary support.

The personnel section collocates with the supporting military personnel office (MILPO). The section augments the MILPO to perform personnel management functions for the entire SF group. When elements of the group are supported by more than one MILPO, members of the personnel section may be attached to each supporting MILPO.

SF Battalion, SFG(A)

Like the SF group, the SF battalion plans, conducts, and supports SO in any operational environment in peace, conflict, and war. The SF battalion's organization is shown in Figure 4-4. Its functions are discussed below.

The battalion's C2 and support elements can function as the headquarters for an ARSOTF or for a JSOTF when augmented by resources from other services. The C2 and support elements can—

- Establish, operate, and support an FOB.
- Provide one SOCCE to a corps or higher headquarters.

- Train and prepare SF teams for deployment.
- Direct, support, and sustain deployed SF teams.

The battalion's SF teams infiltrate and exfiltrate specified areas by air, land, or sea. They conduct operations in remote areas and hostile environments for extended periods with minimal external direction and support. SF teams can also—

- Develop, organize, equip, train, and advise or direct indigenous military and paramilitary forces.
- Plan and conduct unilateral SF operations.
- Train, advise, and assist other US and allied forces or agencies.
- Perform other SO as directed by higher authority.

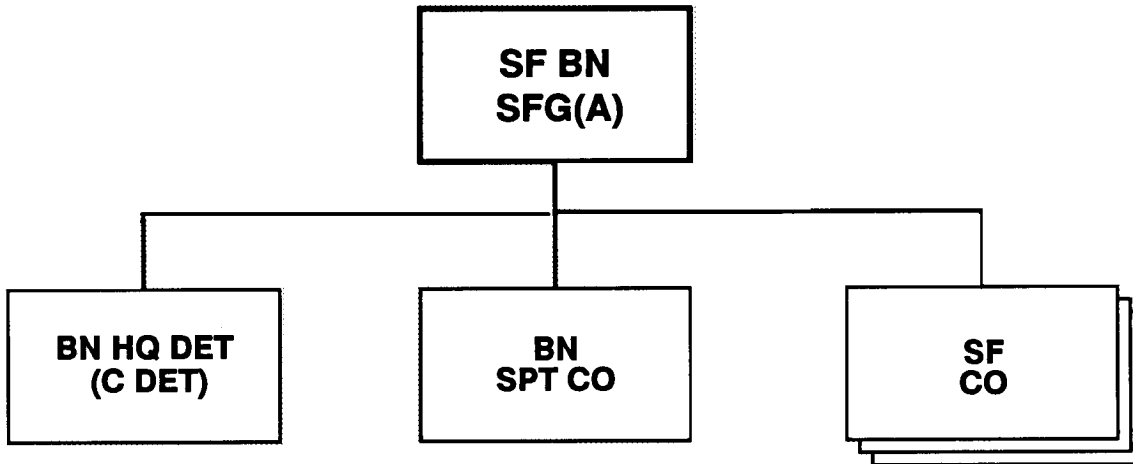

Figure 4-4. SF Bn SFG(A) (TOE 31-805L0).

Headquarters Detachment (SFOD SF Battalion

The SFOD C, also known as C detachment, provides C2, staff planning, and staff supervision of battalion operations and administration. The detachment's organization is shown in Figure 4-5.

Functions

The SFOD C commands and controls assigned and attached elements. The detachment—

- Plans, coordinates, and directs SF operations separately or as part of a larger force.
- Provides command and staff personnel to establish and operate an FOB.
- Provides advice, coordination, and staff assistance on the employment of SF elements to a

joint SOC, JSOTF, SAO, or other major headquarters.

Command and Staff Responsibilities

The battalion commander exercises command of the battalion and its attached elements. When the battalion establishes an FOB, he serves as the FOB commander.

The executive officer performs duties similar to those of a deputy commander and chief of staff. He directs the battalion staff and assigns specific responsibilities to prepare plans, orders, reports, and other staff actions. When the battalion commander establishes an FOB, he serves as FOB director and supervises the day-to-day base activities.

The S1 is the principal staff officer for all PSS matters and other administrative matters not assigned to another coordinating staff officer. His duties are

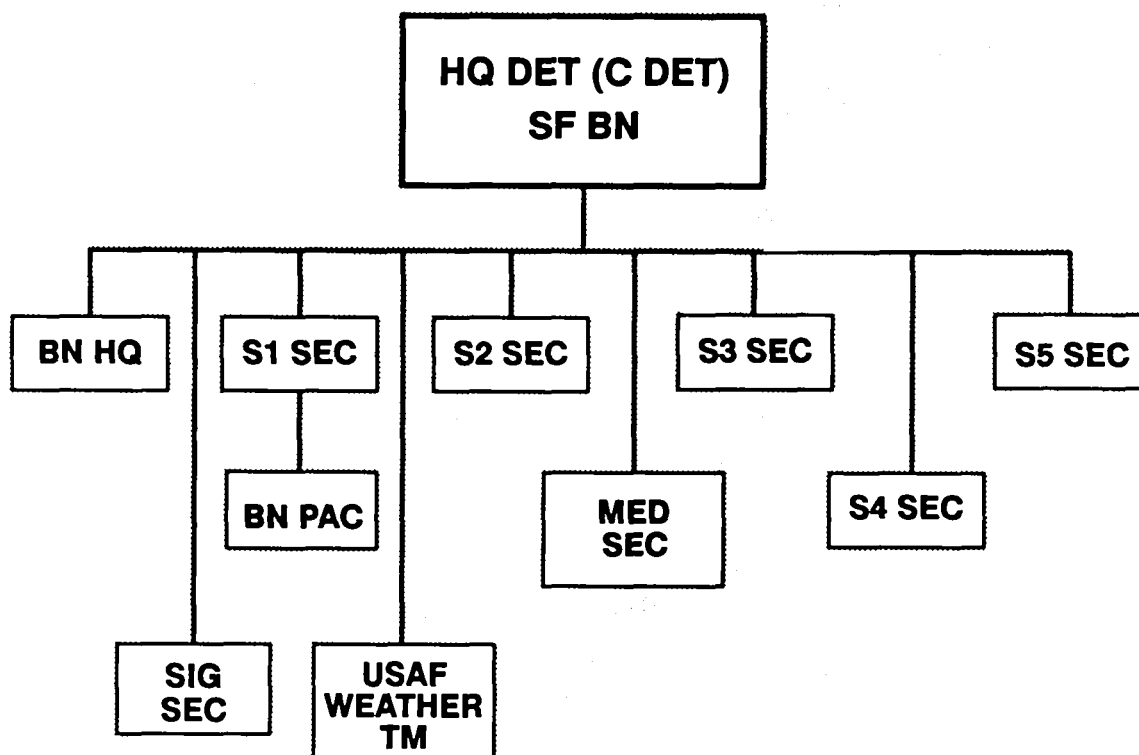

Figure 4-5. Hq Det (C Det), SF Bn (TOE 31-806L0).

similar to those of the group S1. Under his direct supervision, the battalion personnel administration center (PAC) provides consolidated unit-level personnel administrative support to the SF battalion.

The S2 is the principal staff officer for all matters pertaining to intelligence and CI. His duties are similar to those of the group S2. He provides special security representative (SSR) support to the battalion. The SSR functions under the technical control of the supporting SSO. The supporting SSO will be the group SSO only when the two headquarters are collocated.

The S3 is the principal staff officer for all matters pertaining to the organization, training, and operations of the battalion. His duties are similar to those of the group S3. When the battalion commander establishes an FOB, the S3 serves as OPCEN director.

The S4 is the principal staff officer for all logistical matters. His duties are similar to those of the group S4. He coordinates closely with the battalion Spt Co commander, who is the battalion's principal logistical operator.

The S5 is the principal staff officer on all CA matters. His duties are similar to those of the group S5.

The signal officer is the principal staff officer for all signal matters. His duties are similar to those of the group signal officer.

The flight surgeon is the principal advisor to the commander and staff for all matters affecting the mental and physical health of the battalion, attached elements, and its supported indigenous force. His duties are similar to those of the group flight surgeon.

The CSM is the battalion's senior NCO. His duties are similar to those of the group CSM.

Support Company, SF Battalion

The battalion Spt Co provides intelligence and EW support, CSS, and signal support to an FOB and its deployed SF teams. The company's organization is shown in Figure 4-6. Its functions are discussed below.

The battalion Spt Co headquarters provides routine administrative and logistical support to the battalion headquarters detachment, the company's organic elements, and the FOB SPTCEN and SIGCEN. The company headquarters includes personnel to maintain the battalion's diving and marine equipment. The Spt Co commander commands all personnel and elements assigned or attached to the company. His duties are similar to those of the group

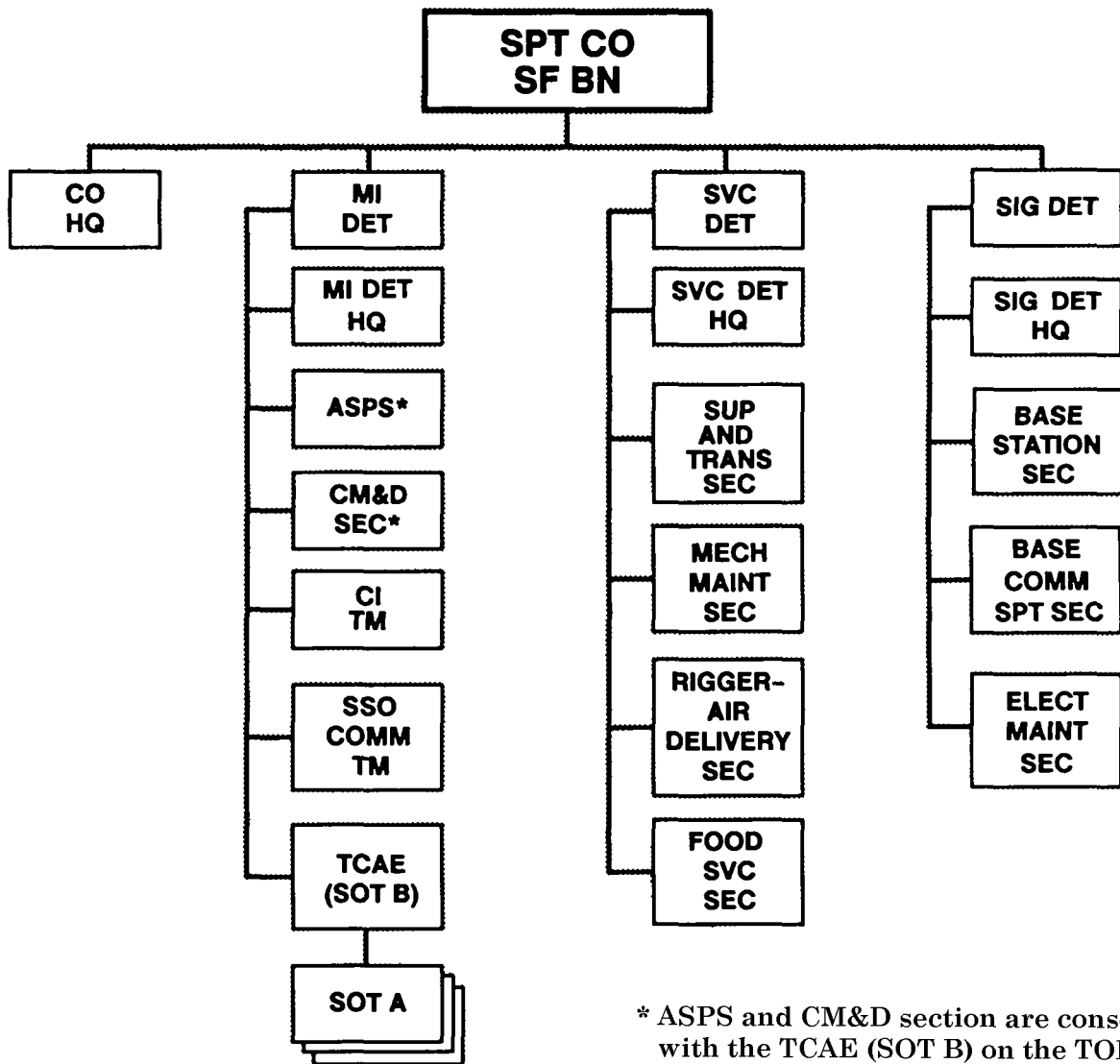

Figure 4-6. Spt Co, SF Bn (TOE 31-808L0).

Spt Co commander, except that his company has no organic aviation platoon. When the battalion establishes an FOB, he serves as SPTCEN director.

The battalion MI detachment mission and organization are similar to those of the group MI detachment, with five exceptions

- The battalion MI detachment has more limited capabilities. It depends on the group intelligence data base and other technical assistance from the group MI detachment.
- The detachment has three organic special operations teams (SOTs) A. The SOTs A deploy with SF teams to provide SIGINT and EW support.
- When specifically authorized and directed, the CI team participates in active CI operations.

- The detachment does not have any organic interrogation teams.
- The detachment commander works for the battalion commander under the staff supervision of the S2.

The battalion service detachment performs functions similar to those of the group service detachment. Its sections support the entire SF battalion and its attached elements.

The battalion signal detachment performs functions similar to those of the group signal detachment. When the battalion establishes an FOB, the detachment Commander seines as SIGCEN director. The base communications support section is smaller by TOE because it has no capability to communicate with subordinate bases. The detachment has no organic photo section.

SF Company, SF Battalion

The SF company plans and conducts SO in any operational environment in peace, conflict, and war. Its organization is shown in Figure 4-7.

The SF company headquarters (SFOD B, also known as B detachment) is a multi-purpose C2 element with many employment options. It is organized as shown in Figure 4-8. It can command and control one to six SFODs A. It cannot isolate and deploy SF teams independently without significant augmentation.

Functions

The SFOD B can—

- Plan and conduct SF operations separately or as part of a larger force.
- Rain and prepare SF teams for deployment.
- Infiltrate and exfiltrate specified operational areas by air, land, or sea.

- Conduct operations in remote areas and hostile environments for extended periods with minimal external direction and support.
- Develop, organize, equip, train, and advise or direct indigenous forces of up to regimental size in SO.
- Thin, advise, and assist other US and allied forces and agencies.
- When augmented, establish and operate an advanced operational base (AOB) to expand the C2 capabilities of an SFOB or FOB.
- Serve as an SOCCE at a corps or higher headquarters.
- Serve as a C2 element (area command) in a specified operational area.
- Serve as a pilot team to assess the resistance potential in a specified operational area.
- Establish and operate an isolation facility (ISOFAC) for an SFOB or FOB.
- Augment the C2 capabilities of an SFOB or FOB.
- Perform other SO as directed by higher authority.

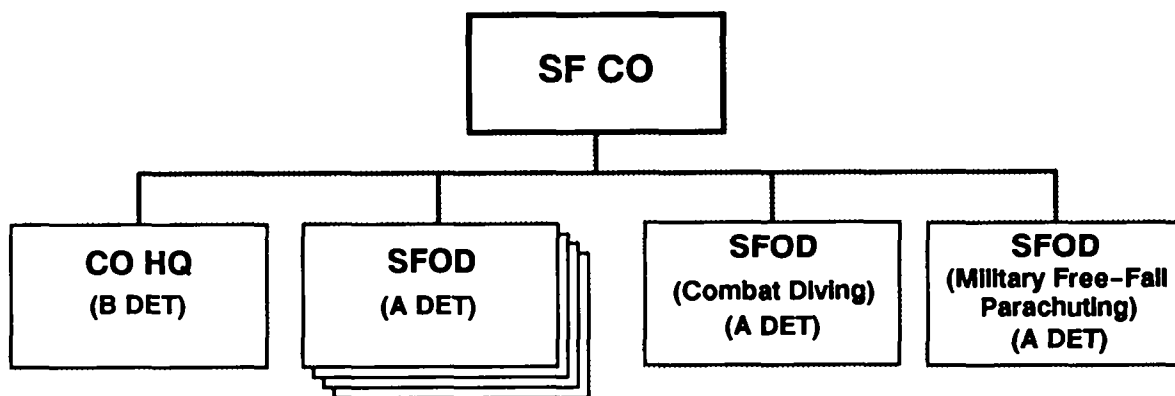

Figure 4-7. SF Co, SF Bn (TOE 31-807L0).

Command and Staff Responsibilities

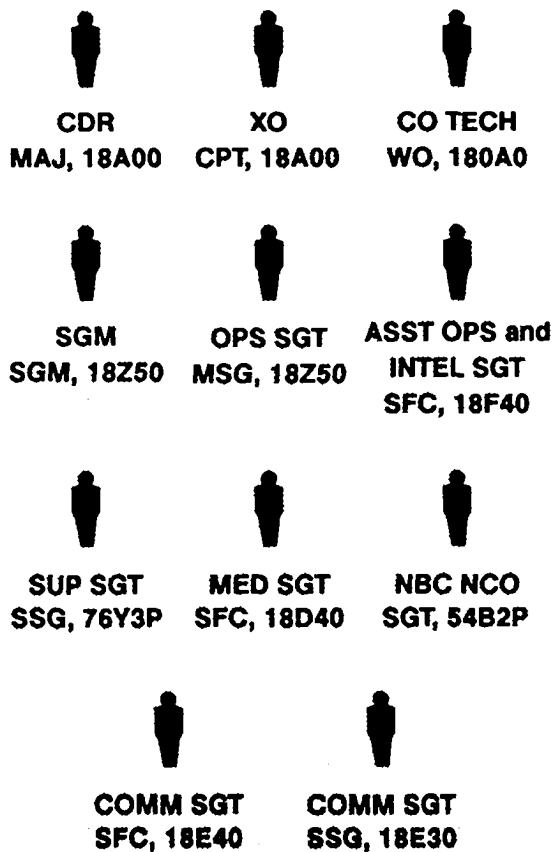

Figure 4-8. Co Hq (B Det), SF Co.

The company commander exercises command of the personnel and elements assigned or attached to the company. When the company establishes an AOB, he serves as AOB commander.

The company XO directs the company staff and assigns specific responsibilities to prepare plans, orders, reports, and other staff actions. In coordination with the company sergeant major, he directs and supervises company administrative and logistical activities.

The company technician has staff responsibility for all matters pertaining to the organization, training, intelligence and CI activities and combat operations of the company and its SFODs.

The company sergeant major is the senior NCO of the company. He is the commander's principal advisor on matters pertaining to enlisted personnel. He supervises the daily training, operations, and administration of the company.

The operations sergeant and assistant operations sergeant assist the XO and company technician in accomplishing their duties. When the SF company and its SFODs are uncommitted, they manage the company's training program for the company commander.

The medical sergeant—

- Provides routine, preventive, and emergency medical care.
- Establishes field medical facilities to support operations.
- Trains allied and indigenous personnel in basic emergency and preventive medical care.
- Gathers medical information.
- Provides mission related veterinary care.

The two communications sergeants—

- Advise the commander on communications matters.
- Prepare communications plans and annexes.
- Assemble the SOI.
- Install, operate, and maintain frequency modulated (FM), amplitude modulated (AM), high frequency (HF), very high frequency (VHF), ultra high frequency (UHF), and super high frequency

(SHF) radio communications equipment to transmit and receive voice, continuous wave (CW), and burst radio messages.

- Rain detachment members and indigenous forces in signal equipment and procedures.
- Manage unit frequencies.

The supply sergeant is the company's principal logistical planner and operator. He coordinates closely with the battalion S4 and service detachment commander to meet the unique needs of the company and its SFODs.

The NBC NCO supervises, operates, and maintains the company's NBC detection and decontamination equipment. He also assists in establishing, administering, and applying NBC defensive measures.

All detachment members must be capable of advising, assisting, or directing foreign counterparts in their functional areas up through regimental level.

Operational Detachment (SFOD A), SF Company

The SFOD A, also known as A detachment, is the basic SF unit. Its organization is shown in Figure 4-9.

Functions

The SFOD A is specifically designed to organize, equip, train, advise or direct, and support indigenous military or paramilitary forces in UW and FID operations. The detachment has two enlisted specialists in each of the five SF functional areas weapons, engineer, medical, communications, and operations and intelligence. The detachment can serve as a manpower pool from which SF commanders organize tailored SF teams to perform DA SR, or other missions. By TOE, each SF company has

one SFOD A trained in combat diving and one SFOD A trained in military free-fall (MFF) parachuting. The SFOD A can—

- Plan and conduct SF operations separately or as part of a larger force.
- Infiltrate and exfiltrate specified operational areas by air, land, or sea.
- Conduct operations in remote areas and hostile environments for extended periods of time with a minimum of external direction and support.
- Develop, organize, equip, train, and advise or direct indigenous forces up to battalion size in SO.
- Rain, advise, and assist other US and allied forces and agencies.
- Plan and conduct unilateral SF operations.
- Perform other SO as directed by higher authority.

Command and Staff Responsibilities

The detachment commander exercises command of his detachment. He may command or advise an indigenous combat force up to battalion size.

The detachment technician serves as second in command and ensures that the detachment commander's decisions and concepts are implemented. He assigns specific responsibilities to prepare plans, orders, reports, and other actions. He prepares the administrative and logistical portions of area studies, briefbacks, and operations plans (OPLANs) and operations orders (OPORDs). He can recruit, organize, train, and supervise indigenous combat forces up to battalion size.

The operations sergeant is the senior enlisted member of the detachment. He advises the detachment commander on all operations and training matters. He provides tactical and technical

guidance and professional support to detachment members. He prepares the operations and training portions of area studies, briefbacks, and OPLANs and OPORDs. He supervises the preparation of detachment training products. He performs the duties of the detachment technician in his absence. He can recruit, organize, train, and supervise indigenous combat forces up to battalion size.

The assistant operations and intelligence sergeant plans, coordinates, and directs the detachment's intelligence training, collection, analysis, production, and dissemination. He also assists the operations sergeant in preparing area studies, briefbacks, OPLANs and OPORDs. He field interrogates and processes hostile PWs. He briefs and debriefs friendly patrols. He performs the duties of the operations sergeant in his absence. He can train, advise, or lead indigenous combat forces up to company size.

The two weapons sergeants employ conventional and UW tactics and techniques as tactical mission leaders. They train detachment members and indigenous forces in the use of individual small arms, light crew-served weapons, and antiaircraft and antiarmor weapons. They help the operations sergeant prepare the operations and training portions of area studies, briefbacks, and OPLANs and OPORDs. They recruit, organize, train, and advise or command indigenous combat forces up to company size.

The two engineer sergeants supervise, lead, plan, perform, and instruct all aspects of combat engineering and light construction engineering. They construct and employ improvised munitions. They plan and perform sabotage operations. They prepare the engineer and targeting portions of area studies, briefbacks, and OPLANs and OPORDs. They can recruit, organize, train, and advise or command indigenous combat forces up to company size.

The two medical sergeants provide emergency, routine, and long-term medical care for detachment members and associated allied or indigenous personnel. They train, advise, and direct detachment members and allied or indigenous personnel in routine, emergency, and preventive medical care. They establish field medical facilities to support detachment operations. They provide veterinary care. They prepare the medical portion of area studies, briefbacks, and OPLANs and OPORDs. They can train, advise, or lead indigenous combat forces up to company size.

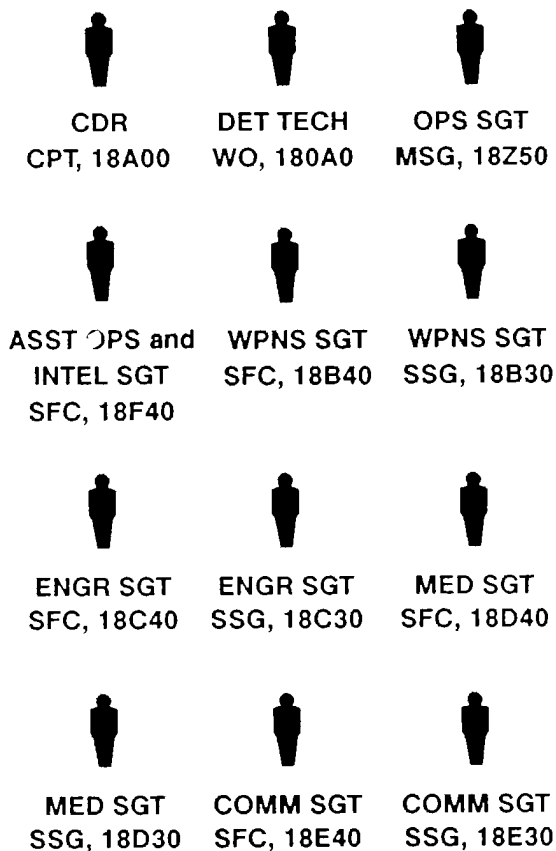

Figure 4-9. SFOD (A Det), SF Co.

The two communications sergeants install, operate, and maintain FM, AM, HF, VHF, UHF, and SHF radio communications in voice, CW, and burst radio nets. They advise the detachment commander on communications matters. They train detachment members and indigenous forces in communications. They prepare the communications portion of area studies, briefbacks, and OPLANs and OPORDs. They can train, advise, or lead indigenous combat forces up to company size.

All detachment members must be capable of advising, assisting, or directing foreign counterparts in their functional areas up through battalion level.

SFOD A Staff Assignments

In anticipation of a UW or FID mission and to ensure functional coverage of all pre-mission activities, the SFOD A commander organizes a detachment staff using the staff assignment guide at Figure 4-10. The detachment communications sergeants perform special staff functions related to their field or serve as assistant staff members, at the discretion of the detachment commander. Detachment staff members perform those duties outlined in FM 101-5 for their particular functional area.

DETACHMENT MEMBER	STAFF ASSIGNMENTS
Detachment Technician	Staff supervisor and coordinator (XO) Adjutant and administrative officer (S1) Logistics officer (S4) CA and PSYOP officer
Operations Sergeant	Assistant XO Assistant S1 Operations and training officer (S3)
Assistant Operations and Intelligence Sergeant	Intelligence officer (S2) Assistant S3
Medical Sergeants	CA NCO PSYOP NCO
Engineer Sergeants	Supply NCO Assistant CA NCO
Weapons Sergeants	Security NCO Training NCO

Figure 4-10. SFOD A Staff Assignment Guide.

Chemical Detachment, SFG(A)

When available, a separate SF chemical detachment will be attached to each SF group to provide dedicated NBC support. Under the staff supervision of the group chemical officer, the detachment headquarters augments the NBC control element at the

SFOB. Its organic decontamination teams provide NBC decontamination support to the SFOB and FOBs. The reconnaissance teams(s) perform NBC SR, to include chemical and biological agent sampling and collection. A reconnaissance team may deploy independently or may be attached to a larger SF team. Both the decontamination and reconnaissance teams can also perform foreign military training and assistance missions when required.

CHAPTER 5

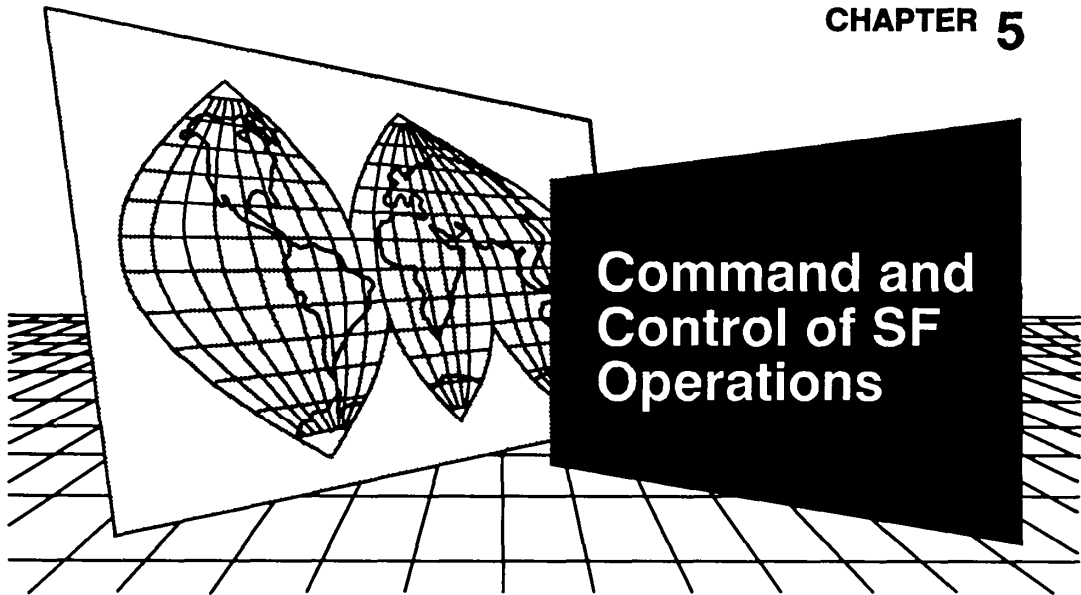

SF operates under many varied C2 arrangements. The exact C2 structure is determined by the requirements of the commander at each echelon of command. SF operations are inherently joint. They are directly controlled by higher echelons, up to the NCA, often with minimal involvement of intermediate headquarters. They may require oversight at the national level. This chapter discusses C2 of SF operations from the unified command level down to the organization within the operational area. It provides a number of generic command relationships that commanders may choose depending on the situation. This chapter also discusses the SF communications system that supports these C2 arrangements.

Joint Environment

SO require a responsive and unified C2 structure. Unnecessary layering of headquarters within the SO chain of command decreases responsiveness and compromises security. All SF commanders must

understand the nature of joint operations because their abbreviated chains of command place them in frequent contact with joint headquarters. Every operational headquarter above SF group level is joint. Thus, dealing with a joint headquarters is as common to an SF commander as dealing with a division headquarter is to a conventional combat arms commander. (See JCS Pubs 0-2 and 3-0 for detailed discussions of joint operations.)

Theater Special Operations Command

The NCA have established five regional unified commands with a broad strategic responsibility for US unified military operations in an area of responsibility (AOR). For the remainder of this publication, the US regional commander in chief (CINC) is assumed to be the theater of war commander (theater CINC). (See JCS Pubs 0-2 and 3-0 for detailed discussions of joint theater operations.)

The regional CINCs exercise COCOM over assigned SOF (Figure 5-1). Each regional CINC has established a subordinate unified SOC to exercise operational control (OPCON) of his theater-level joint SOF (Figure 5-2). In wartime, this SOC may develop into a combined organization.

In some situations, the CINC may establish a JSOTF to support a subordinate area commander or to perform sensitive SO on a functional basis. The JSOTF may be under the OPCON of the supported area commander, or it may remain under the OPCON of the theater SOC. With augmentation

from the other services, an SF group or battalion headquarters can function as a JSOTF headquarters.

The SOC commander exercises direct OPCON of assigned SOF. He begins SOF mission planning by developing the theater CINC's strategic guidance into a sequence of integrated SO that support the theater strategy and campaign plan. The SOC commander must maintain a theaterwide perspective. He must fully understand the theater CINC's vision and how each conventional force commander intends to implement his aspect of the theater campaign. He must identify and anticipate theater operational and intelligence requirements that SOF can address. He must then develop and recommend SO that satisfy those requirements. (See JCS Pub 3-05 for more information on joint SO doctrine.)

The SOC commander may be dual-hatted as the CINC's special staff officer for SO. In this case, the SOC commander places a special operations staff element (SOSE) at the CINC's joint operations center (JOC) to perform SO special staff functions under the SOC commander's direction.

Army Special Operations Task Force

The SOC or JSOTF commander may establish an ARSOTF to function as the operational Army component headquarters. An ARSOTF is organized around the nucleus of an SF group or battalion or a

ranger regiment or battalion. It includes a mix of SF, ranger, and SO aviation; supporting SO PSYOP, CA, and signal assets; and other CS and CSS assets as required (Figure 5-3). The ARSOTF headquarters performs functions similar to those of a conventional combined arms brigade headquarters. The ARSOTF commander and staff coordinate directly with the supporting TASOSC to obtain required CS and CSS.

COMBATANT COMMAND (COCOM)

The authority to perform those functions of command involving organizing and employing commands and forces, assigning tasks, designating objectives, and giving authoritative direction necessary to accomplish the mission. COCOM includes directive authority over all aspects of military operations, joint training, and logistics. COCOM should be exercised through the commanders of assigned normal organizational units or through the commanders of subordinate commands and forces. COCOM provides full authority to organize and employ forces as the CINC deems necessary to accomplish assigned missions and to retain or delegate operational control or tactical control as necessary. COCOM does not, of itself, include such matters as administration, discipline, internal organization, and unit training. COCOM is exercised solely by the commanders of unified and specified commands.

OPERATIONAL CONTROL (OPCON)

The authority to perform those functions of command over subordinate forces involving organizing and employing commands and forces, assigning tasks, designating objectives, and giving authoritative direction necessary to accomplish the mission. OPCON includes directive authority over all aspects of military operations and joint training. OPCON should be exercised through the commanders of subordinate organizations. OPCON normally provides full authority to organize commands and forces as the commander deems necessary to accomplish assigned missions and to retain or delegate operational control or tactical control as necessary. OPCON may be limited by function, time, or location. It does not, of itself, include authoritative direction for logistics or such matters as administration, discipline, internal organization, or unit training. OPCON may be exercised by commanders at any echelon (CINC and below).

TACTICAL CONTROL (TACON)

The detailed and usually local direction and control of movements or maneuvers necessary to accomplish assigned missions or tasks. TACON provides sufficient authority for controlling and directing the military operations of designated forces or the tactical use of combat support assets. It does not provide organizational authority or authoritative directions for administration and logistics. TACON may be exercised by commanders at any echelon (CINC and below).

ADMINISTRATIVE CONTROL (ADCON)

The direction or exercise of authority over subordinate or other organizations in respect to administrative matters such as personnel management, supply, services, and other matters not included in the operational missions of the subordinate or other organizations. (This is the JCS Pub1-02 term for what the Army calls "command less OPCON.")

Figure 5-1. Command Relationships.

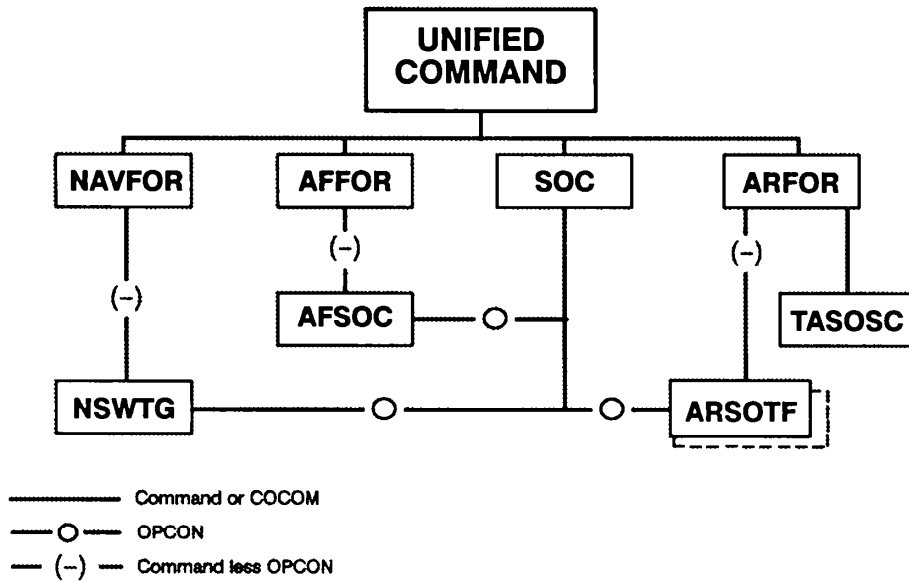
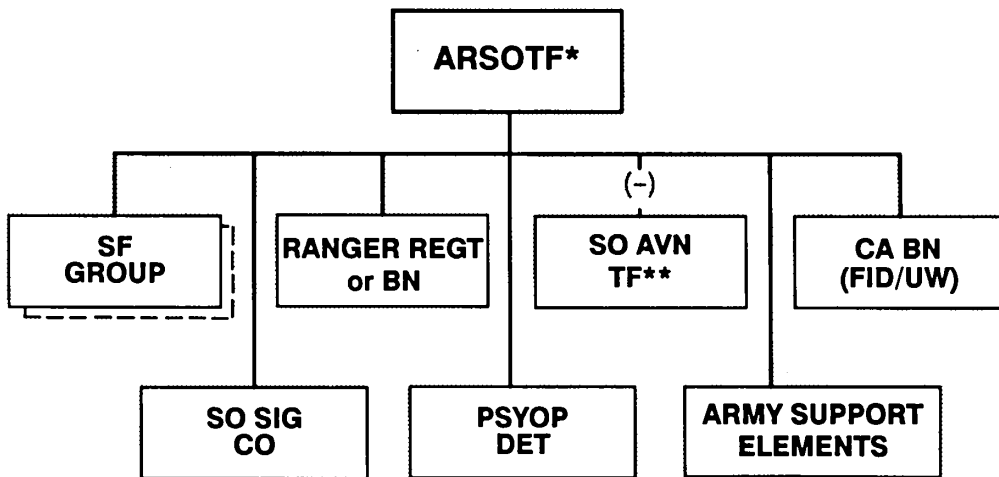

Figure 5-2. Theater SOF Command Relationships.



*ARSOTF HQ is normally an SF Gp or Ranger Regt HQ.
 **SO Avn TF may be under OPCON of theater Air Force Special Operations Command.

Figure 5-3. Type ARSOTF.

Theater Army Special Operations Support Command

The TA commander exercises command of all Army forces assigned or attached to a unified command, less OPCON of those Army forces operationally controlled by a joint or combined commander. He may exercise command directly (Figure 5-4) or through a subordinate area commander (Figure 5-5). The TA commander retains responsibility for CS and CSS of all assigned or attached Army forces, regardless of who exercises OPCON.

ARSOF depend on the TA for all DS- and general support (GS)-level CS and CSS. The mission, the duration and scope of operations, and the operational environment determine the actual requirements. The TA commander attaches appropriate TA elements to ARSOF and/or tasks appropriate TA elements to support ARSOF on a task, mission, or area basis. When deployed independently into an

undeveloped theater, ARSOF require significant augmentation by attachment, MTOE, and/or tables of distribution and allowances (TDA) until the TA becomes established.

The theater army special operations support command (TASOSC) is a subordinate functional command of the TA. The TASOSC mission is to plan and coordinate the support and sustainment of theater ARSOF conducting SO. By providing the vital link between the TA and theater ARSOF units, the TASOSC ensures that the TA meets its administrative, support, and sustainment responsibilities for ARSOF.

The TASOSC has no operational mission and does not layer itself between the SOC and theater ARSOF (Figure 5-6). Rather, it functions as a supporting headquarters, responding to the needs of the theater ARSOF as a division support command responds to the needs of its supported brigades. (See FM 100-25 for a more detailed discussion of the TASOSC.)

The TNOSC commander anticipates, plans, and coordinates ARSOF support requirements with the

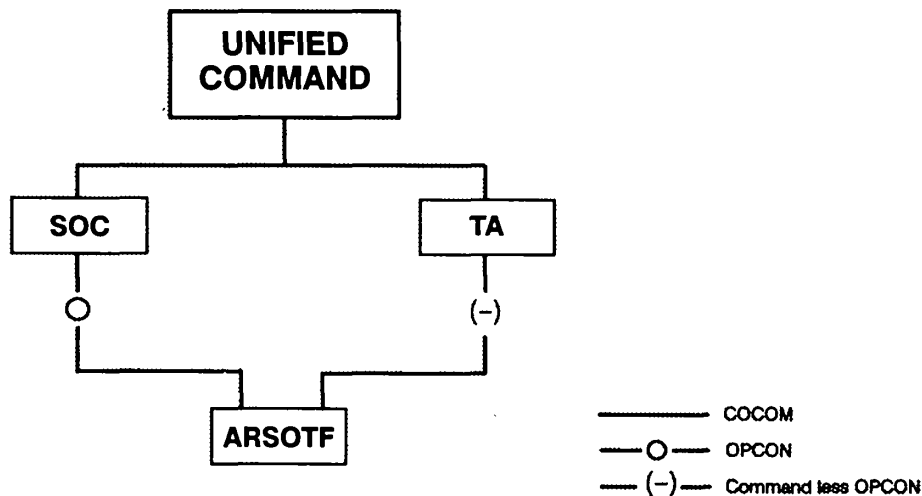

Figure 5-4. TA Exercising Direct Command (less OPCON) of ARSOTF.

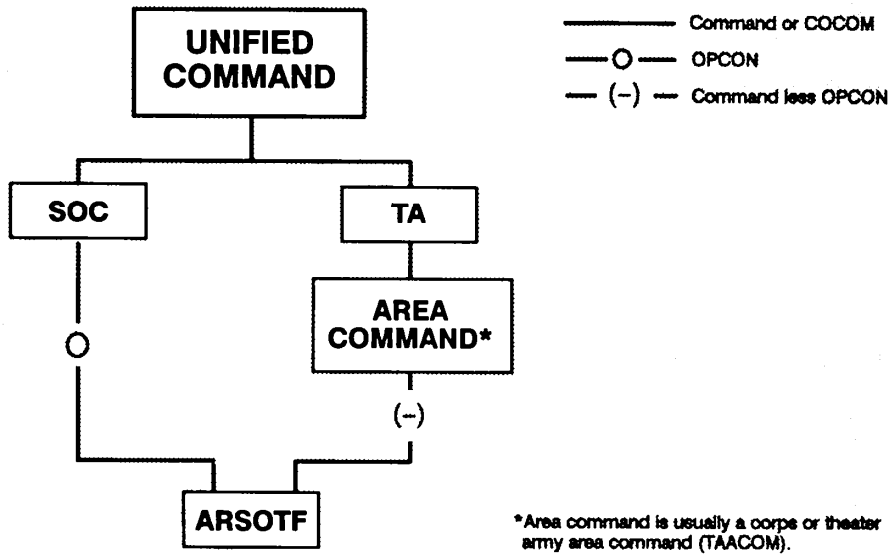

Figure 5-5. TA Exercising Command (less OPCON) Through an Area Command.

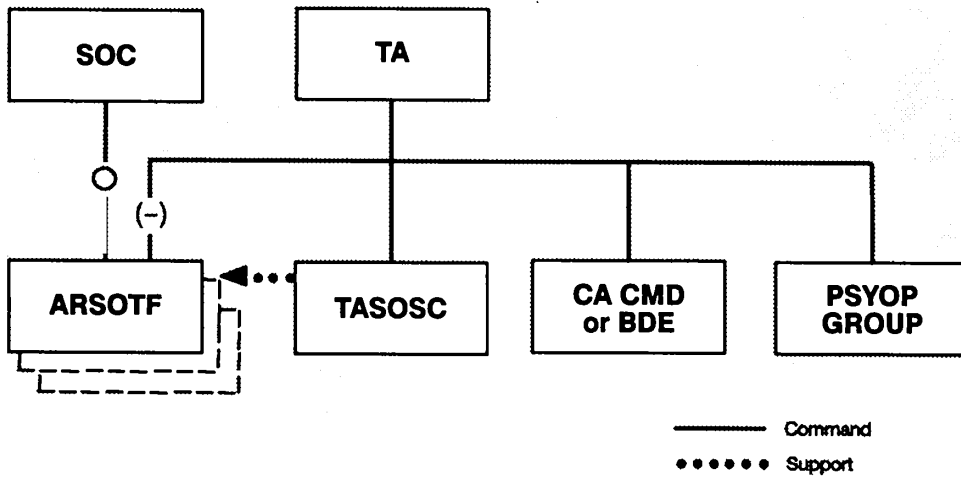

Figure 5-6. ARSOF Command Relationships in a Theater Army.

theater SOC and appropriate TA elements. More specifically, he and his staff—

- Plan and coordinate Army CS and CSS for assigned and attached ARSOF and, when directed, other service and allied SOF.
- Plan, coordinate, direct, and supervise CS and CSS operations by assigned and attached Army support forces.

To accomplish his mission, the TASOSC commander normally collocates his headquarters with the theater SOC. He places a SOSE at the TA headquarters. The SOSE performs SO advice, planning, and coordination functions parallel to those of a field artillery fire support element or other special staff element at a tactical headquarters.

Because ARSOF need timely and detailed intelligence available only at the national and theater level,

the TASOSC commander collocates an intelligence support element (IE) at the theater CINC's joint intelligence center (JIC) or at the TA MI brigade's echelons above corps intelligence center (EACIC). The IE performs intelligence collection management and dissemination, all-source intelligence production, and SO target development in support of ARSOF intelligence requirements.

The TASOSC commander places SO liaison elements at the appropriate theater army area commands (TAACOMs). These liaison elements coordinate ARSOF logistical, personnel service, and health service requirements within the TAACOMs' area of responsibility. The TASOSC headquarters coordinates other ARSOF support requirements directly with other TA functional commands and the theater army materiel management center (TAMMC), exchanging liaison elements when required.

SF Command and Control System

SF commanders employ the standard Army staff organization and military decision-making process described in FM 101-5. However, their C2 facilities differ significantly from those found in conventional military organizations. The SF group commander exercises command and control through a network of operational bases. These operational bases combine the functions of command post and unit trains into a single entity. They are normally located at secure and logistically supportable sites in the communications zone (COMMZ).

Special Forces Operational Base

The SFOB is a command, control, and support base established and operated by an SF group from organic and attached resources. It is primarily a planning and coordinating center. At the SFOB, the

group commander and staff develop the SOC commander's operational guidance into tactical missions for the battalions to plan and execute. The group commander assigns specific missions and operational areas to the battalions, allocates SFODs and other resources among them, and synchronizes their activities. He identifies and coordinates group support requirements with the TASOSC. He also ensures the sustainment of the battalions and their deployed SF teams. Appendix B provides a sample SF group OPLAN. Specific SFOB functions include—

- Planning and directing SF operations, to include synchronizing the activities of subordinate FOBs.
- Ensuring that subordinate battalions receive sufficient CS and CSS.
- Coordinating group activities with higher, adjacent, and supported headquarters.

At the SFOB, the group commander and staff also prepare, deploy, control, and support selected SPECAT teams that require group-level control. When required, the group commander tasks an

SFOD B to establish and operate an ISOFAC and supervise SPECAT mission planning. When the number of SPECAT missions exceeds the C2 capabilities of an augmented SFOD B, the group commander may collocate an FOB with the SFOB for planning, execution, and support of SPECAT missions.

NOTE: A SPECAT team is an SF team with a particularly sensitive mission requiring centralized control. Examples of SPECAT missions include CT, E&E, national strategic SR, DA with special munitions, and special activities. Many of these missions use a SPECAT message handling system for communications, but the two uses of the term SPECAT are not necessarily related.

Group Battle Staff

To command effectively, the group commander must free himself from detailed mission planning and the daily activities of the SFOB. He must instead focus on broader issues, such as the—

- Current and future operational and intelligence requirements of the theater CINC and the conventional force commanders that the SF group supports.
- Design, execution, and sustainment of sequential and cumulative SF operations to support the theater campaign plan and the major OPLANs of the conventional force commanders.
- Synchronization of battalion activities, to include Supervising the battalions' decentralized execution of his operational and sustainment concepts.

To assist in these functions, the group commander may establish a battle staff. Normally directed by the group XO, the battle staff operates out of the SFOB OPCEN but physically locates with the group commander. The battle staff thus functions in a manner similar to a conventional unit's command group or tactical command post. Anywhere the group commander travels, the battle staff can prepare an estimate or a fragmentary order. It keeps the SFOB OPCEN informed of new developments. It may direct the OPCEN to begin planning for a new mission, reallocate available resources, or request additional assets.

The battle staff reflects the group commander's personal leadership style, but it must remain small,

mobile, and responsive to his needs. A type battle staff could include the following:

- Executive officer.
- S3 or assistant S3 (situation dependent).
- S2 or assistant S2 (situation dependent).
- Assistant S1.
- S4 or assistant S4 (situation dependent).
- S5 or assistant S5 (situation dependent).
- CSM.
- Signal officer or NCO with a secure tactical satellite communications (TACSATCOM) package linking the battle staff to the SOC, TASOSC, SFOB, and FOBs.

Forward Operational Base

The FOB is a command, control, and support base established and operated by the SF battalion. The organization and functions of an FOB vary with the mission, the duration and scope of operations, and the security, communications, intelligence, and CSS requirements. An FOB may be subordinate to or independent of the SFOB. Command relationships, not physical location, determine whether the FOB is independent of or subordinate to the SFOB. Either type may be collocated with the SFOB or established in another theater of operations.

The subordinate FOB is an intermediate base whose commander reports directly to the group commander. It does not have the SFOB's broad planning and coordinating responsibilities. The subordinate FOB commander and staff plan and execute missions as directed by the SF group commander.

The independent FOB is a separate base whose commander reports directly to the SOC, a JSOTF, an SAO, or a major conventional headquarters. Its organization and functions are similar to those of an SFOB, except that the battalion commander does not coordinate the activities of other FOBs. The commander and staff of an independent FOB coordinate directly with the SOC for operational matters and with the TASOSC for intelligence and CSS requirements. The SF group commander does not have OPCON of the FOB's activities.

The SF battalion commander establishes an FOB to prepare, deploy, control, and support SF teams in specified operational areas. The FOB may be

organized on an area or functional basis. If the FOB is organized on an area basis, the battalion commander plans, conducts and supports all SF operations in a specific theater of operations or in support of a specific conventional force. If the FOB is organized on a functional basis, the battalion commander plans, conducts, and supports a specific type(s) of SF operation(s) throughout the group's operational area. Appendix C provides a sample battalion OPLAN. Specific FOB functions include—

- Planning and conducting SF operations as directed by higher authority.
- Training, preparing, deploying, directing, and supporting subordinate SF teams.
- Coordinating battalion activities with higher, adjacent, and supported headquarters.

Advanced Operational Base

The AOB is a command, control, and support base established and operated by the SF company. The AOB is small, light, and mission-oriented. AOB elements perform functions similar to a conventional unit's jump TOC and/or combat trains. The SF company commander may establish an AOB to support a specific mission, such as a company-level FID mission, when no FOB is required. He may establish an AOB to extend the span of control of an SFOD or FOB.

The organization and functions of an AOB vary with the mission, the duration and scope of operations, and the security, communications, and CSS requirements. In general, the AOB may function as a launch and recovery site, a radio relay site, or a mission support base.

Launch and Recovery Site. Distances or other circumstances, such as a shortage of lift assets, may preclude direct infiltration from and exfiltration to the FOB. In this situation, the group or battalion commander may direct an SF company (SFOD B) commander to establish an AOB as a marshaling base, intermediate staging base (ISB), or launch and recovery site. At this AOB, the SFOD B receives SF teams after their isolation at an FOB and supports their activities before infiltration. It also receives the teams after exfiltration and transfers them to the FOB for debriefing and postmission activities. If

reinforced, the detachment may also be responsible for resupply and other sustainment operations during mission execution and/or for initial debriefing after exfiltration. The SFOD B commander must ensure the following are provided at the AOB:

- OPSEC for the supported force and its activities at the base.
- Compartmented mess, billeting, latrine, and shower facilities for the supported force.
- Access to secure communications and processed mission intelligence.
- Access to an airfield or other means of infiltration or exfiltration, preferably with an all-weather capability.
- Facilities for planning, maintenance, and other final mission preparation (to include sites for training, rehearsals, and test firing of weapons).
- Facilities for conducting resupply and other sustainment operations, as required.

Radio Relay Site. Circumstances (for example, distance, OPSEC, or political constraints) may preclude direct communication between deployed teams and the operational base controlling their activities. In this situation, the group or battalion commander may direct an SFOD B commander to establish and operate an AOB as a radio relay site. Radio relay may be a primary or collateral mission for the AOB. If it is the primary mission, the AOB will be much smaller than an AOB established as a launch site, because it has no requirement to support SF teams. The group or battalion commander must attach an SF signal element to the SFOD B at the AOB if communications requirements exceed its organic capabilities.

Mission Support Base. When conducting SF operations in friendly territory, there may be no need for an FOB. The FOB, if one exists, may be distant from where an SFOD B commander needs his own mission support base. In either case, the group or battalion commander may direct the SFOD B commander to establish an AOB to serve as command post and unit trains for his subordinate SF teams and their counterpart HN forces. Such an AOB must have capabilities similar to those required at a launch site. A mission support base needs a helicopter landing zone, a resupply drop zone, and/or a tactical airstrip as a means of air sustainment, plus access to the local surface (land or water) transportation system.

The SF company may not have the organic resources to support an AOB. The SFOD B has excellent C2 capabilities to establish and operate an AOB. However, it has only limited organic capabilities to provide security, intelligence, communications, or CSS to a supported force. The group or battalion commander must provide the required augmentation from internal assets or coordinate with the TASOSC or other appropriate commander to obtain required augmentation from TA, HN, or commercial sources. Attachment of SF group or company resources may

reduce the capability to establish the SFOB or FOBs

Operational bases are normally fixed. However, they may have to displace when their location becomes untenable because of hostile activity or natural disaster. The group and battalion commanders and their staffs must carefully plan and coordinate contingency displacement plans to ensure continuity of operations. They must shift minimum operational and emergency communications to their alternate base before displacement begins.

Command Relationships in the COMMZ

Command relationships are based on the mission, the duration and scope of operations, the CS and CSS requirements, the security considerations, the signal capabilities, and the desired degree of control over operations. The flexible nature of the SF group allows it to be task organized as required. The following situations depict the most common command relationships for SF operations.

The first four situations depict possible command relationships for wartime and contingency SF operations when those operations do not directly impact on conventional combat operations.

Situation 1 (Figure 5-7) depicts one SF group assigned to the TA of a unified command and under the OPCON of the theater SOC. The group commander establishes an SFOB and three subordinate FOBs to command, control, and support all SF operations in the theater of war. This arrangement provides the SF group commander with a decentralized C2 system.

Situation 2 (Figure 5-8) depicts an independent FOB reporting directly to the SOC. The SOC commander uses an independent FOB when total SF requirements do not exceed the capabilities of a single FOB. He may also use an independent FOB when OPSEC or other peculiar circumstances dictate that he

directly control a portion of the theater's SF operations.

Situation 3 (Figure 5-9) depicts the establishment of two AOBs to extend the span of control of the SFOB and an independent FOB. This arrangement permits the SF group or battalion commander to provide closer coordination of SF operations than the range of his communications system or infiltration, exfiltration, or resupply means would otherwise permit.

Situation 4 (Figure 5-10) depicts a highly centralized C2 system. The group commander establishes an SFOB and directly commands, controls, and supports all SF operations in the theater. In this situation, the group commander may have to consolidate group resources to expand normal SFOB capabilities.

The next three situations depict the command relationships when SF units conduct an SA or a FID mission. Other SF units may simultaneously conduct UW, SR, or DA operations to support the HN counterinsurgency effort, using any of the command relationships previously discussed.

Situation 5 (Figure 5-11) depicts the deployment of an SF team as a security assistance team (SAT) to conduct an SA mission in response to a potential or latent insurgency in a HN. The in-country SAO is under the combatant command (COCOM) of the regional CINC. However, the SAO chief serves under the direction and supervision of the Chief of

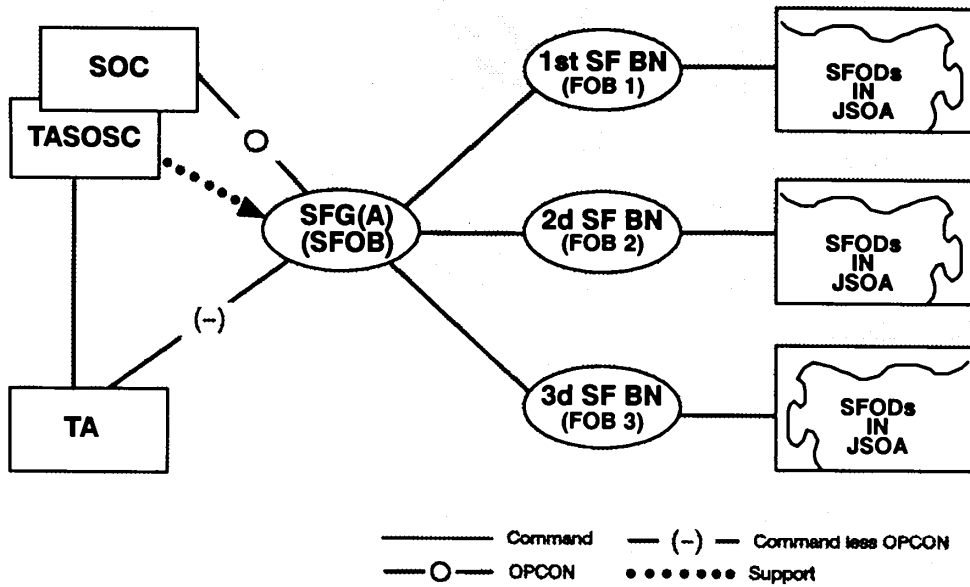

Figure 5-7. (Situation 1) A Decentralized C2 System.

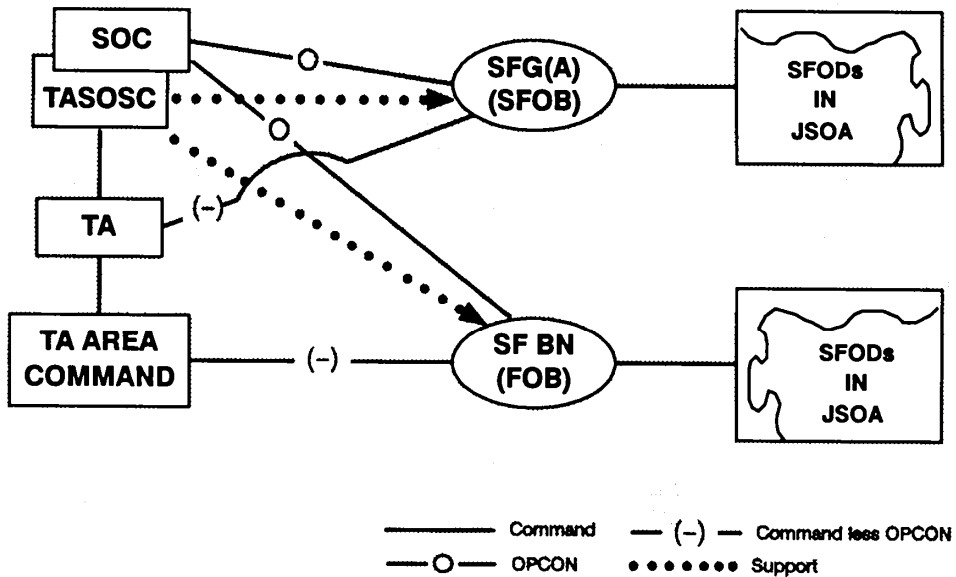

Figure 5-8. (Situation 2) An Independent FOB Reporting Directly to the SOC.

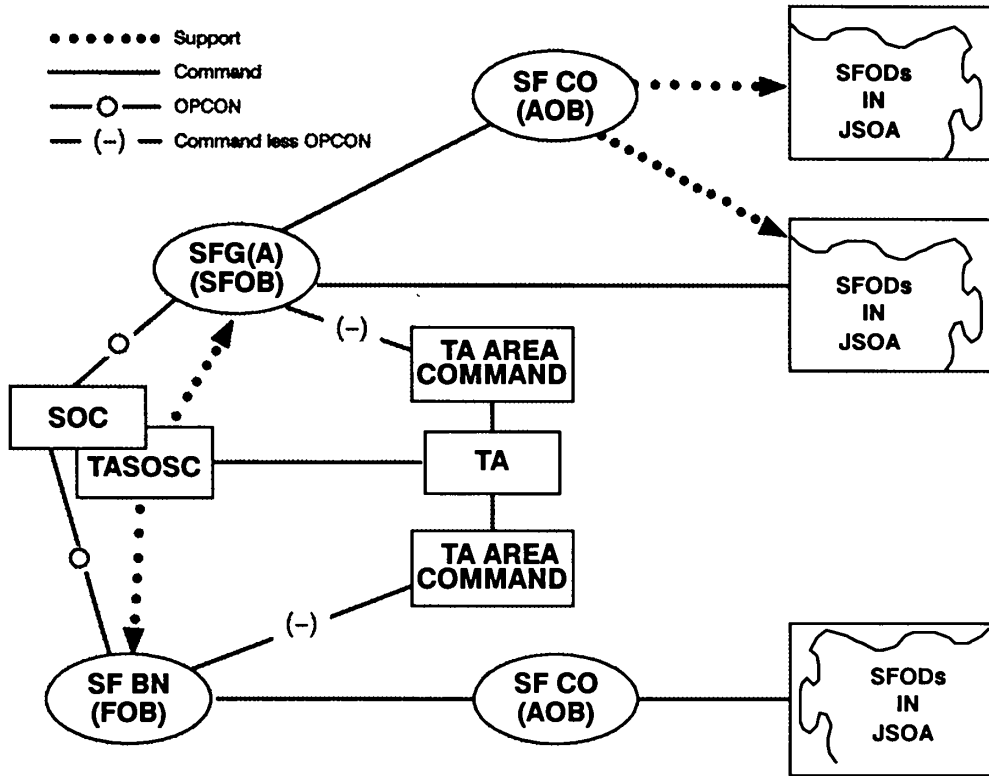

Figure 5-9. (Situation 3) Expansion of Control Using AOBs.

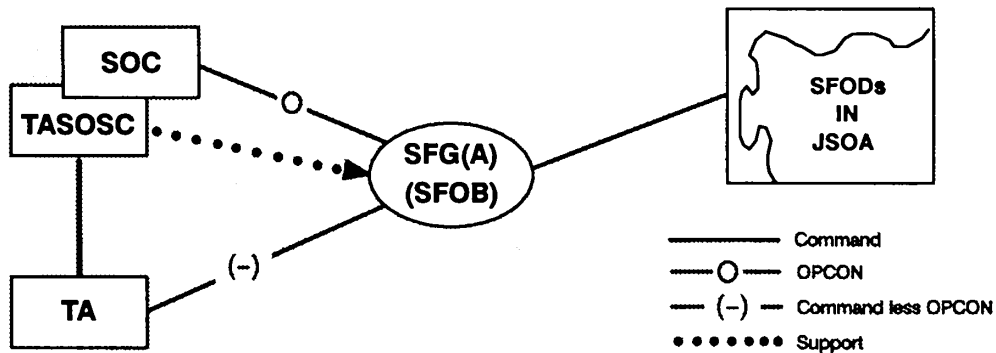

Figure 5-10. (Situation 4) A Centralized C2 System.

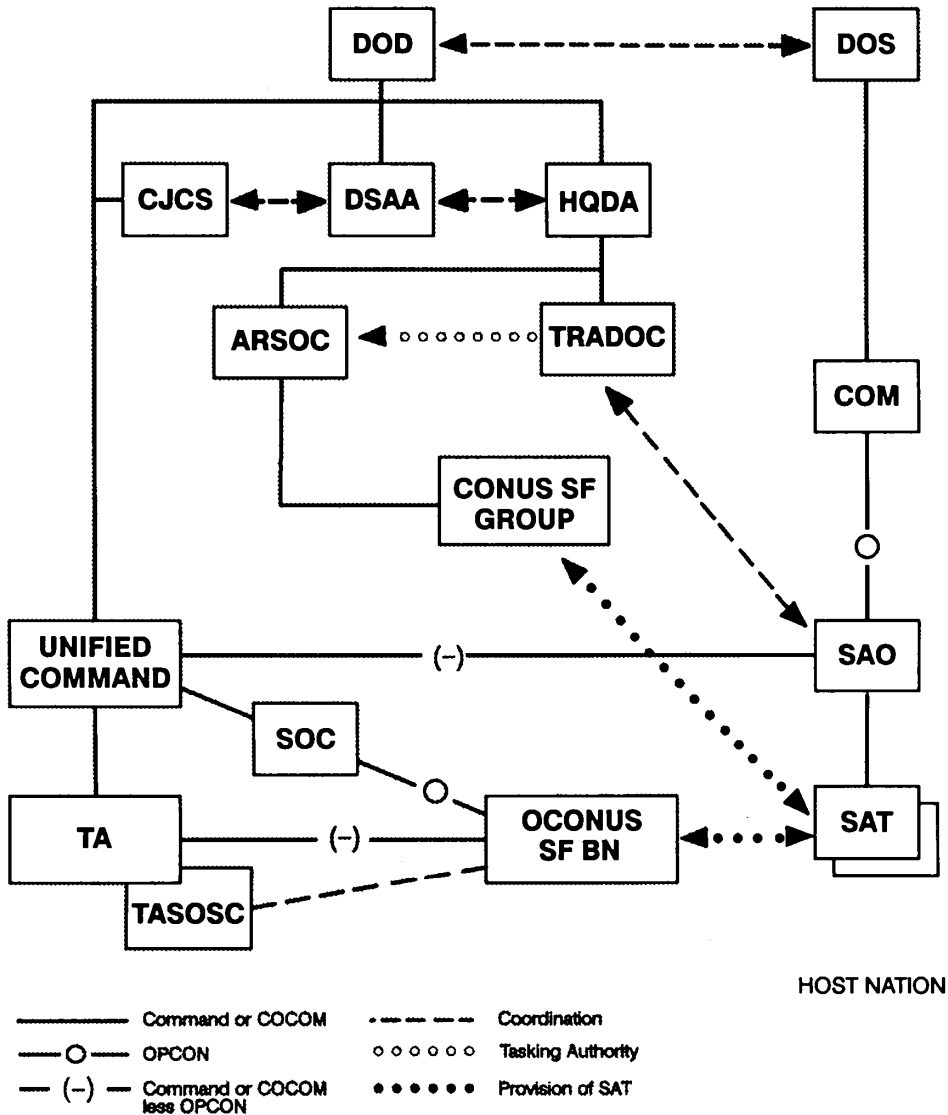

Figure 5-11. (Situation 5) Deployment of an SF Team as an SAT.

the US Diplomatic Mission (COM) to the extent provided by law and the presidential letter defining the COM'S authority and responsibility. In military terms, the COM'S authority over the SAO chief roughly corresponds to OPCON. The SAO chief must ensure that all SAO activities are fully

coordinated with the COM and other members of the US Country Team.

NOTES: The generic term SAT encompasses all DOD elements assigned to execute SA training programs administered by the Defense Security Assistance Agency (DSAA). From the SF

perspective, the most common forms of SAT are the MTT and the training assistance field team (TAFT).

The generic term SAO encompasses all DOD elements, regardless of actual title, assigned in foreign countries to manage SA programs administered by DOD.

The SAO chief is responsible for properly executing those in-country SA programs administered by DOD through the DSAA. When the SAO chief is designated the US defense representative (USDR), he also provides oversight and in-country supervision of all DOD personnel assigned to non-SA functions. As USDR, he serves as a channel of communication

between non-SA personnel and the HN government and the COM, the regional CINC, and other interested agencies.

Whenever an SF team deploys on an SA mission, the SAO exercises operational and administrative control of the team while it is in the HN. The SAO provides all possible assistance so that the SAT can accomplish its mission. The regional CINC exercises COCOM of the SAT through the SAO. The parent SF unit relinquishes command of the SF team for the duration of its SA mission.

Situation 6 (Figure 5-12) depicts the deployment of an SF team on a non-SA FID mission in response to

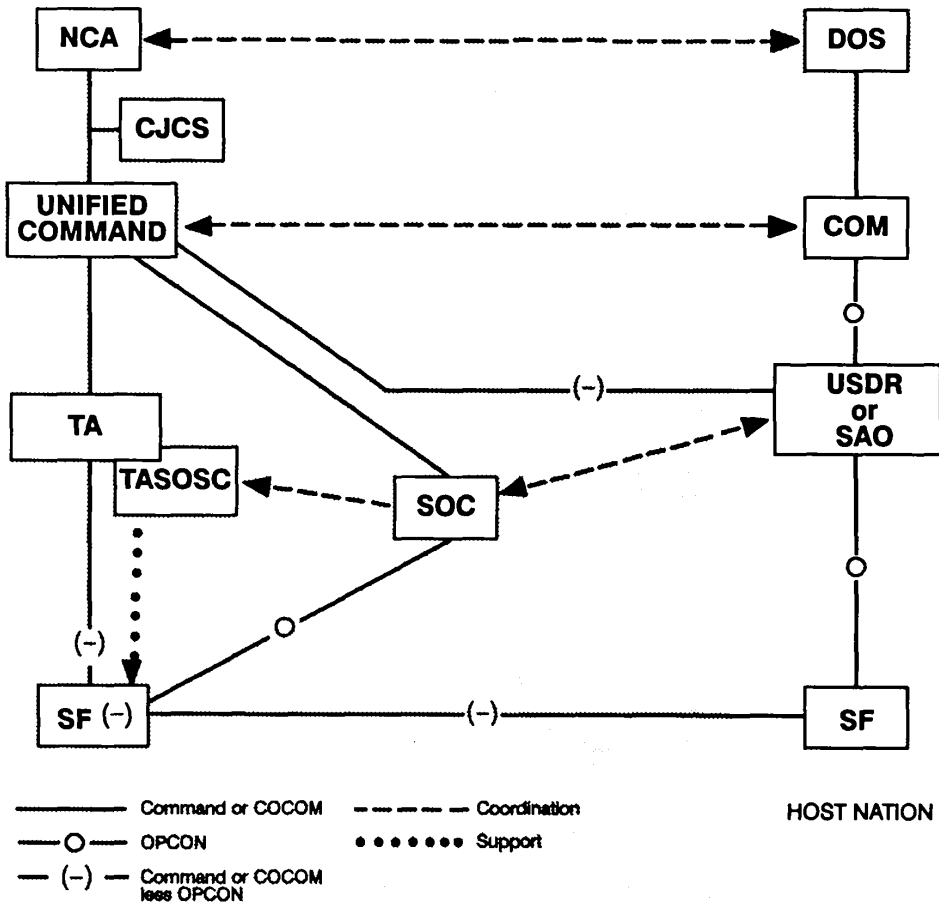

Figure 5-12. (Situation 6) SF Team Deployment on a Non-SA FID Mission.

an active insurgency in the HN. In this situation, the regional CINC exercises COCOM through the operational chain of command. He places the SF team under the OPCON of the in-country SAO chief in his capacity as USDR. The parent SF unit retains command (less OPCON) and supports the deployed SF team as required from a CONUS or third-country FOB. The SF team's activities are funded from

non-SA programs, and SAO personnel performing oversight and supervisory responsibilities for the SF team may have to be identified as non-SA personnel on the SAO joint manning document.

Situation 7 (Figure 5-13) depicts the deployment of an SF battalion to country A in response to a major insurgent threat. As in Situation 6, the regional

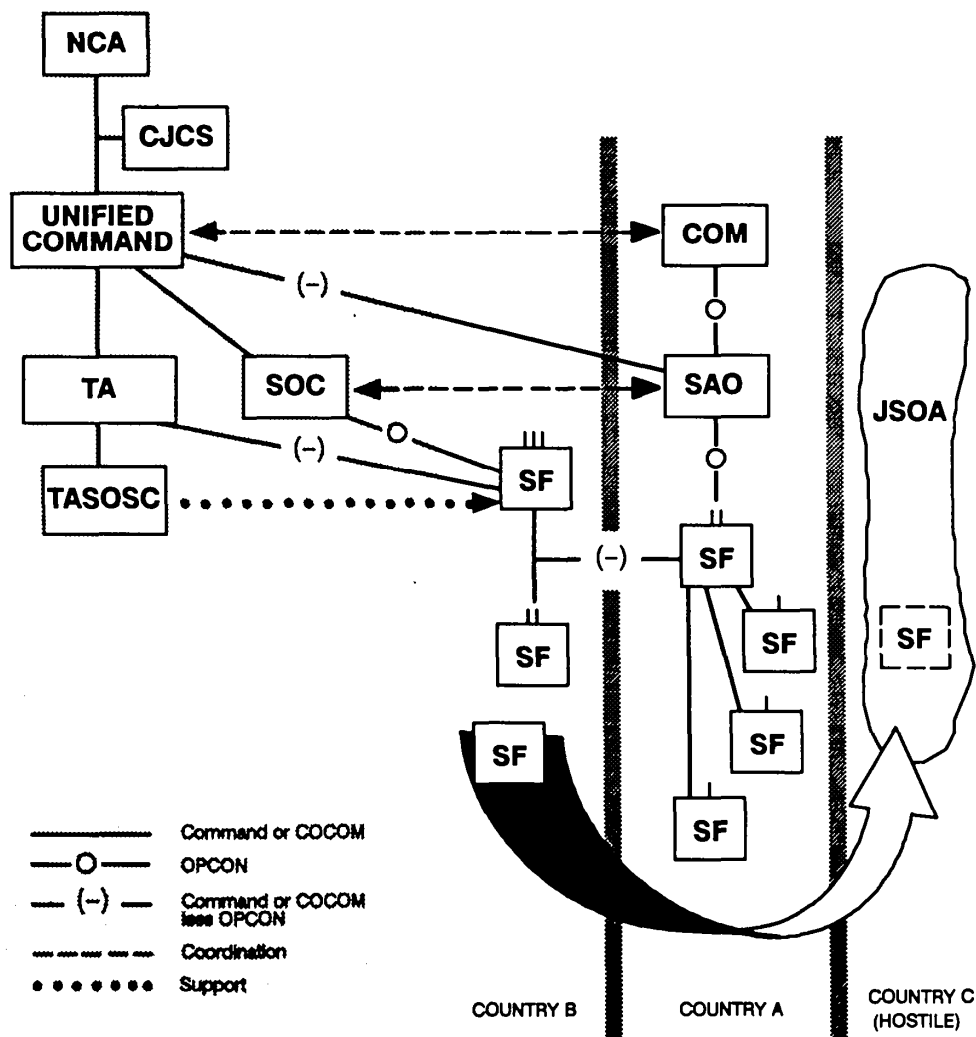

Figure 5-13. (Situation 7) SF Bn Deployment.

CINC exercises COCOM of all DOD elements, to include the SAOs in each country. The SF battalion establishes an independent FOB under the OPCON of the SAO chief in his capacity as USDR. The parent SF group retains command (less OPCON) of the SF battalion. The SF group has established an SFOB

and one subordinate FOB. The FOB, collocated with the SFOB in country B, conducts SF operations in country C, the hostile power sponsoring the insurgency. The SF group is under the OPCON of the SOC, which directs all SF missions not under the OPCON of an SAO.

Deployment C2

The overseas deployment of a CONUS-based SF unit involves the transfer of COCOM from the USSOCOM CINC (USCINCSOC) to the gaining regional CINC. Only the NCA can authorize such a transfer. The actual transfer can occur in one of two ways (Figure 5-14).

In a war or long-term conflict situation, the SF unit moves from the home station to a port of embarkation. From there the SF unit moves by air or sea into the gaining CINC's AOR. At a predetermined point (for example, upon crossing a specified latitude or longitude), COCOM formally passes to the gaining CINC. The gaining TA commander receives the SF unit at the port of debarkation (POD). The TASOSC

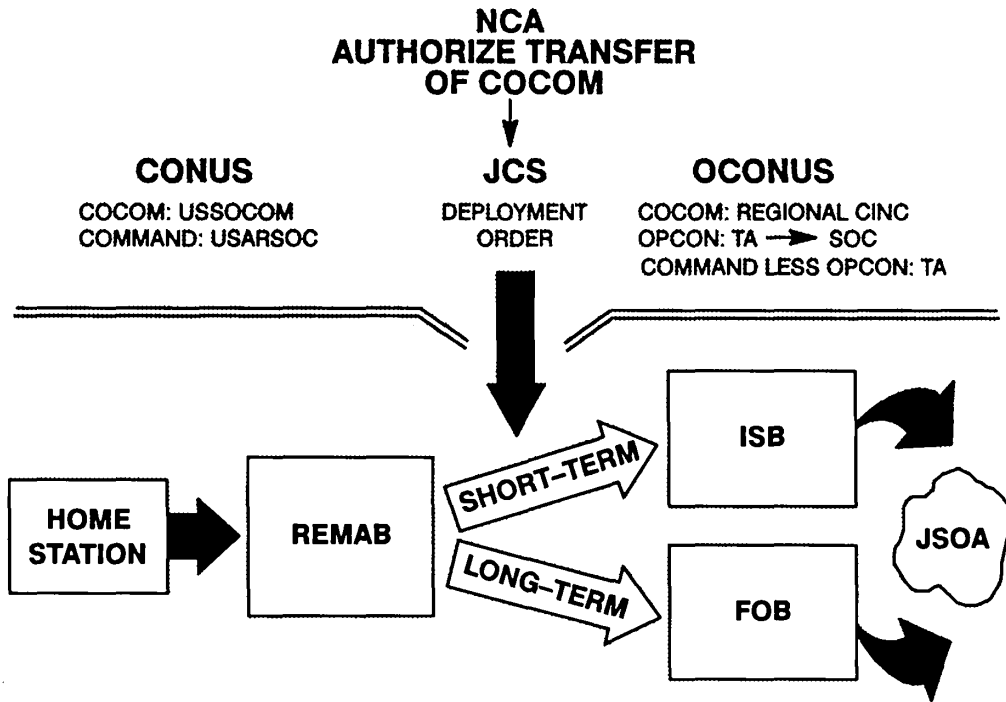

Figure 5-14. Deployment C2.

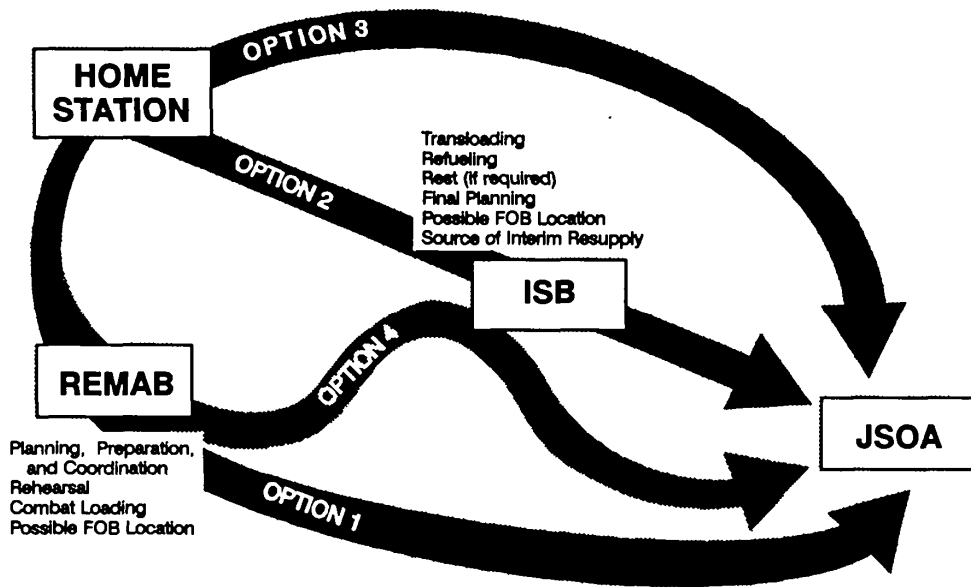

Figure 5-15. Short-Term Deployment Options.

assumes full command of the SF unit until it arrives at its SFOB or FOB and becomes operational. The TASOSC commander then passes OPCON to the theater SOC commander.

In a short-term contingency situation, the SF unit moves from the home station to a remote marshaling base (REMAB), an ISB, or directly to the operational area (Figure 5-15). The REMAB is a secure base to which the entire SF unit, including organic and attached support elements, deploys to

plan and prepare for a mission. The REMAB may be in CONUS, or it may be overseas in the gaining CINC's (or another CINC's) AOR. If the REMAB is overseas, the NCA will specify in the deployment order when, and to whom, COCOM passes.

The ISB is a secure base overseas to which the SF unit deploys to perform final planning, coordination, and task organization. An ISB is used when distance or other factors preclude infiltration directly from the home station or the REMAB.

Command Relationships in the JSOA

A JSOA is an area of land, sea, and airspace assigned to a joint SO commander to conduct SO. The SOC

or JSOTF commander assigns specific JSOAs (or sectors of a JSOA) to an SF commander for mission execution. The scope and duration of the SF operation, the size and composition of indigenous forces, the hostile situation, and the political situation all influence the number and composition

of SF teams deployed into a JSOA. Additional SF teams may deploy later because of increased tempo in operations, expansion of existing resistance forces, or a change in the political situation. The three most common methods of employing SF into a JSOA are discussed below.

A tailored SFOD A or B may deploy into a JSOA when the situation is not well known, when the indigenous force is small, or when the indigenous force is so well developed that only minimum coordination is needed. The detachment normally coordinates directly with the FOB staff on all operational, administrative, and logistical support matters (Figure 5-16).

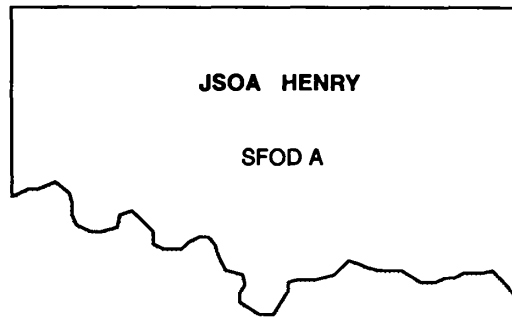

Figure 5-16. Single SFOD.

Two or more tailored SFODs A or B may infiltrate concurrently, each establishing a separate sector command. This arrangement is useful when the size of the JSOA, the hostile situation, or the nature of the indigenous force precludes effective operations by a single SF chain of command in the JSOA. Each detachment coordinates directly with the FOB staff on all operational, administrative, or logistical support matters. There is normally no lateral communication between detachments (Figure 5-17).

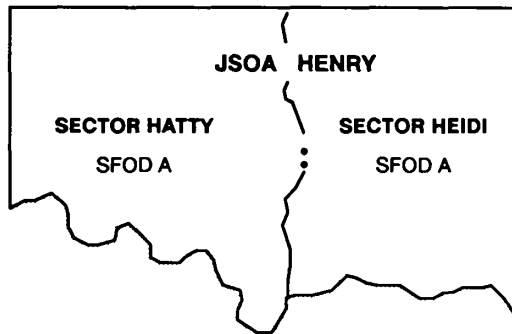

Figure 5-17. Multiple SFODs.

As activities in the JSOA expand, a tailored SFOD B may deploy to establish and/or advise an area command. The area command directs the activities of the SF teams in subordinate sectors. In this situation, subordinate SF teams coordinate all operational matters with the SFOD B, which in turn coordinates directly with the FOB staff. Each subordinate SF team continues to coordinate routine administrative and logistical support directly with the FOB staff (Figure 5-18). When the situation dictates, a more senior commander and staff may augment the detachment's organic capabilities.

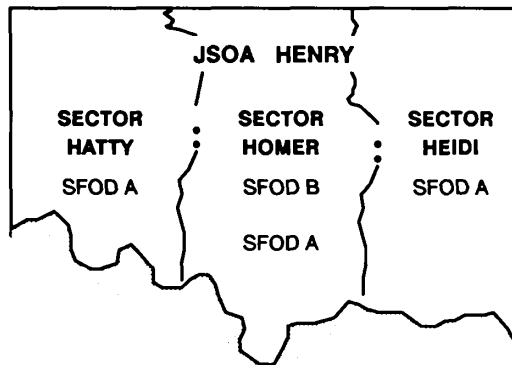

Figure 5-18. SFOD B Area Command.

All external agencies must coordinate with the SOC or JSOTF before conducting any activities that may affect operations within the JSOA. The SF group or battalion commander may recommend that the SOC or JSOTF commander designate a JSOA as a restricted fire area, depending on the situation.

In addition to SF, other US or allied military organizations and nonmilitary agencies may have elements operating in the JSOA. The SOC commander makes every effort to identify these

other elements. He coordinates to establish command and support relationships and the proper degree of liaison, coordination, and cooperation among elements.

SF C2 at Conventional Headquarters

SF operations often require synchronization with conventional military operations. When directed, the SF group or battalion commander collocates an SOCCE (a reinforced SFOD B) with the supported conventional force command post. The SOCCE commander advises the supported commander on the capabilities and limitations of supporting SF teams and provides required communications links. The SOCCE synchronizes SF operations with conventional force operational and intelligence requirements. It coordinates conventional force support of SF operations. It receives SF operational, intelligence, and target acquisition reports directly from the deployed SF teams and provides them to the conventional force commander and staff. The SOCCE also deconflicts SF operations with the operations of the supported conventional force. When linkup becomes imminent, the SOCCE assists the conventional force staff with linkup planning. The actual situation will dictate whether the SOC or conventional commander exercises OPCON of the supporting SF teams.

When the *area of interest* of a conventional force commander encompasses a JSOA, mutual coordination must occur to identify SF mission requirements and to synchronize all supporting SO with conventional combat operations. In Situation 8 (Figure 5-19), a field army area of interest encompasses the JSOA, although SF operations are beyond the field army's area of operations. The SOCCE commander identifies the field army's SF mission requirements and coordinates them with the FOB staff. The FOB commander retains OPCON and provides administrative and logistical support to the SF teams in the JSOA.

The theater CINC passes OPCON of deployed SF teams to a conventional force commander when—

- The conventional force commander requests and receives dedicated SF support on a mission basis.

- The theater CINC commits the conventional force to an area in which SF operations are ongoing.
- The conventional force approaches a JSOA and linkup becomes imminent.

When the *area of operations* of a conventional force commander encompasses a JSOA, the conventional force commander normally exercises OPCON through the collocated SOCCE. In Situation 9 (Figure 5-20), a corps area of operations encompasses the JSOA. Conventional and SF operations directly impact on each other. In this situation, the CINC directs the SOC commander to pass OPCON of appropriate SF teams to the corps commander. The SOCCE commander directly controls the deployed SF teams. The FOB commander retains command (less OPCON) of the deployed SF teams and continues to provide administrative and logistical support. The SOCCE commander keeps the FOB commander informed of the status and activities of SF teams under SOCCE control.

If friendly offensive operations are successful, the conventional force will link up with SF teams and take control of the JSOA. During this phase of the operation, SF teams may be placed under the OPCON of the appropriate tactical commander. The tactical commander then becomes responsible for integrating the SF teams and their indigenous forces into his combat operations. He exercises OPCON through the collocated SOCCE at his command post.

When assigned an SOCCE mission, the SFOD B commander task organizes into two shifts to conduct continuous operations according to the standing operating procedures (SOPs) of the supported headquarters. The XO and company technician are normally the shift leaders, freeing the detachment commander and sergeant major to vary their schedules as required. Each shift leader organizes his shift to coordinate SF operations with the plans, current operations, intelligence, targeting, and CSS cells of the supported headquarters. The operations sergeant supervises the routine activities of his shift and ensures its efficient operation and administration. The communications sergeant manages SOCCE message traffic and supervises the attached signal element.

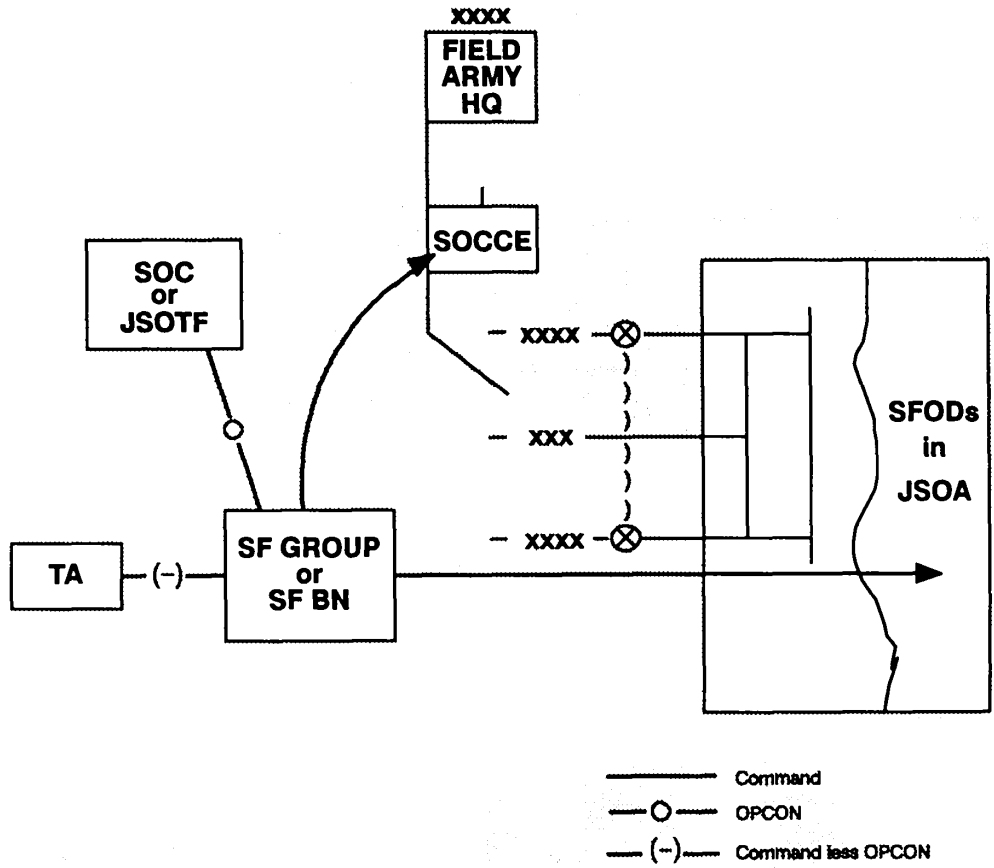

Figure 5-19. (Situation 8) SOCCE When SFODs Operate in Field Army Area of Interest.

In Situations 8 and 9, the SOCCE uses organic and attached radio and telephone equipment to enter the supported unit's communications system. It also maintains secure communications with the FOB or SFOB commander controlling its activities. In Situation 9, the SOCCE must also establish and maintain direct communications with its subordinate SF teams.

SOCCE communications to its subordinate SF teams will normally flow through the parent FOB. If the mission requires direct communications between the SOCCE and its SF teams, the SF battalion commander must augment the SFOD B with a signal element from the battalion signal detachment.

SOCCE communications to the parent FOB depend on the theater communications system (TCS). Organic long-range HF radio or UHF tactical satellite terminals will be used when the SOCCE is deployed in an undeveloped theater before the TCS becomes operational.

Administrative and logistical support for the SOCCE will be provided on the basis of an agreement between the supported headquarters and the TASOSC. The parent FOB must provide DS and limited GS maintenance of SF-peculiar equipment. The FOB must continue to conduct mission preparation, isolation, infiltration, resupply, and exfiltration of SF teams supporting the conventional force.

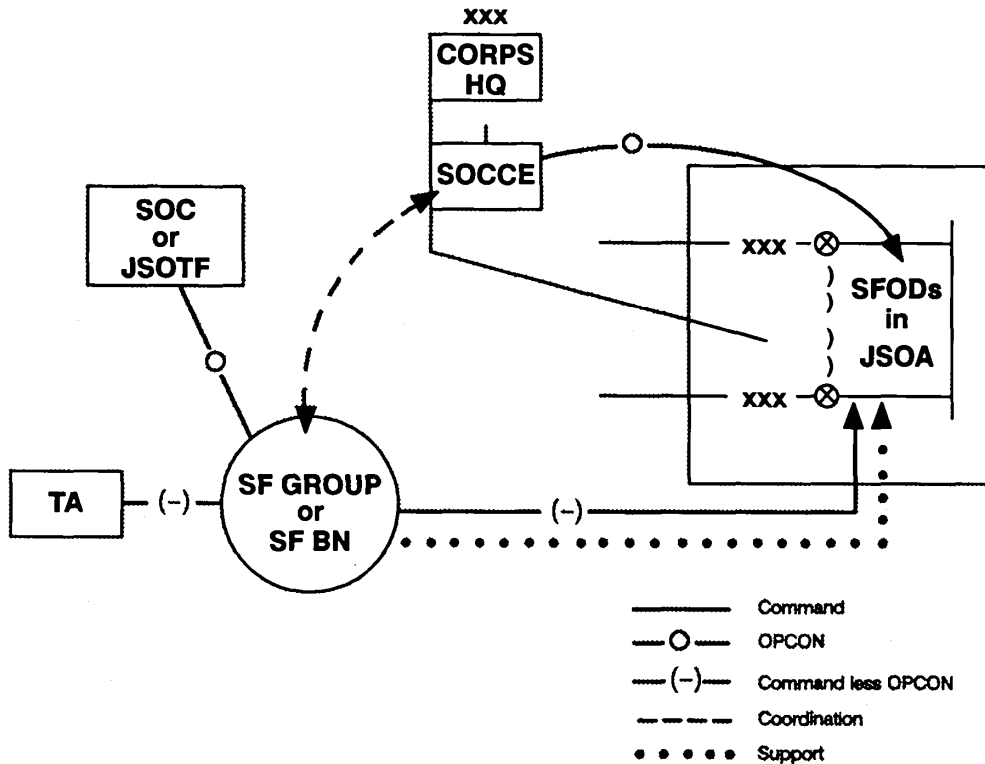

Figure 5-20. (Situation 9) SOCCE When SFODs Operate in Corps Area of Operations.

SF Control of Conventional Maneuver Units

In some situations an SF unit may receive OPCON or attachment of a conventional maneuver unit. This is most likely to occur—

- In a counterinsurgency environment when an SF-supported indigenous combat force requires

additional combat power for a specific combined arms operation.

- When SF teams performing DA or SR operations require a conventional reaction or reinforcement force.
- In linkup or postlinkup combat operations during the combat employment phase of an insurgency.
- During contingency operations when the ARSOTF headquarters is the senior Army headquarters in the operational area.

SF Communications in a Developed Theater

The SFOB and FOBs are normally located in the COMMZ. The TCS provides area signal support to the SF group and its subordinate elements. The TCS may be an Army, Air Force, or Navy system. See Figure 5-21 for an example of SF communications in a developed theater.

The SOC J6 coordinates the installation, operation, and maintenance of communications links from the SOC to subordinate elements (to include the SFOB and independent FOBs reporting directly to the SOC). These links include multichannel SHF and HF, single-channel HF and UHF satellite communications (SATCOM), and limited wire and/or cable support. Dedicated JCS, Army (SO signal battalion), Air Force, or Navy communications assets provide this support to the SOC.

The TASOSC information management officer plans and coordinates TCS and defense communications system (DCS) access for all ARSOF in the theater. He exercises technical control of all ARSOF communications. The TASOSC relies on area access to the SOC's dedicated communications package, or the TA communications system, to communicate with its subordinate ARSOF elements.

The SF group uses organic signal assets to provide communications to subordinate FOBs and deployed SF teams. The SF group and battalion signal detachments have the organic assets to—

- Install, operate, and maintain two internal single-channel HF radio teletypewriter (RATT) nets: one for SCI and one for command, operations, and support. When HF multichannel equipment becomes available, it will replace the RATT systems.
- Terminate landlines connecting them to the TCS. The TCS provides the primary means for the

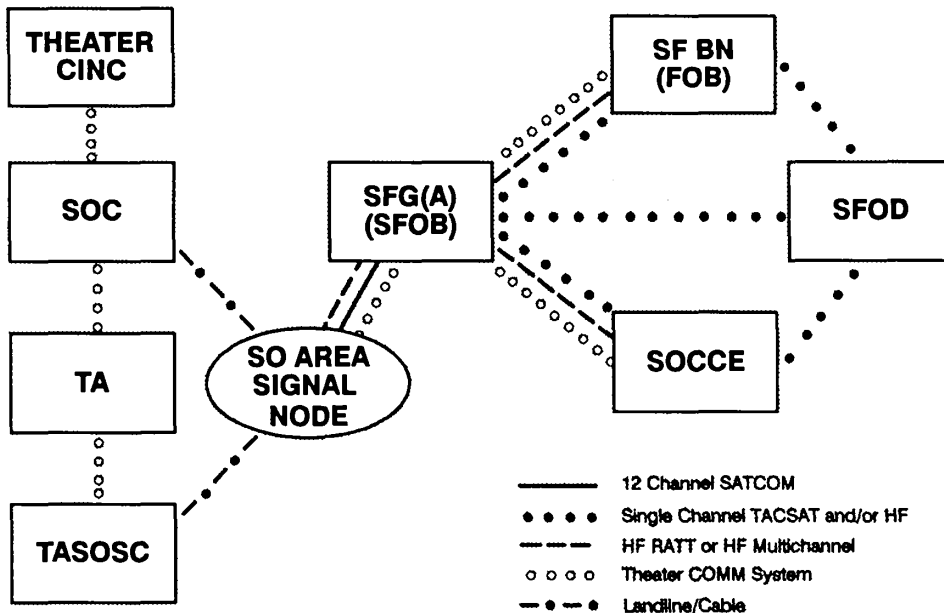

Figure 5-21. Type SF Communications in a Developed Theater.

SFOB, FOBs, AOBs, and SOCCEs to exchange operational and intelligence data.

- Communicate with their deployed teams using HF burst and/or UHF SATCOM burst. When

required, the SOCCEs and AOBs can also communicate with the SFOB, FOBS, and deployed SF teams using these same systems. These systems also provide backup communications between the SFOB and FOBs.

SF Communications in an Undeveloped Theater

In an undeveloped theater of operations, no TCS is available. The SOC J6 and TASOSC information management officer provide or coordinate the same communications links established in a developed theater. In an undeveloped theater, the TA signal brigade or an SO signal battalion must augment the

SF group's organic signal detachments. The augmentation package establishes secure communications links between the SFOB and its subordinate elements until the theater develops and TCS becomes operational. If the responsible service cannot provide the required communications, the SOC J6 must obtain JCS-controlled joint communications support element (JCSE) assets to provide the support. See Figure 5-22 for an example of SF communications in an undeveloped theater.

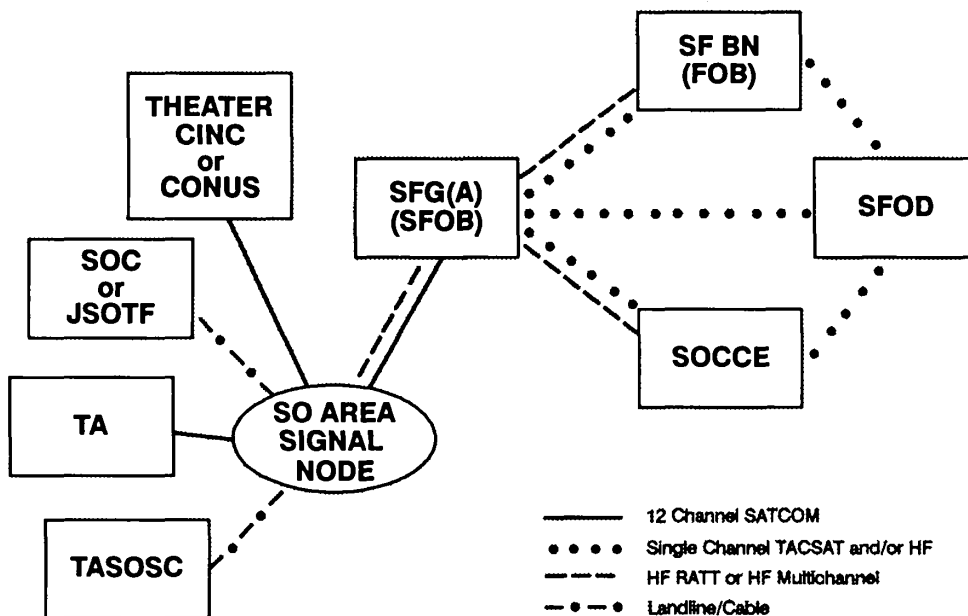
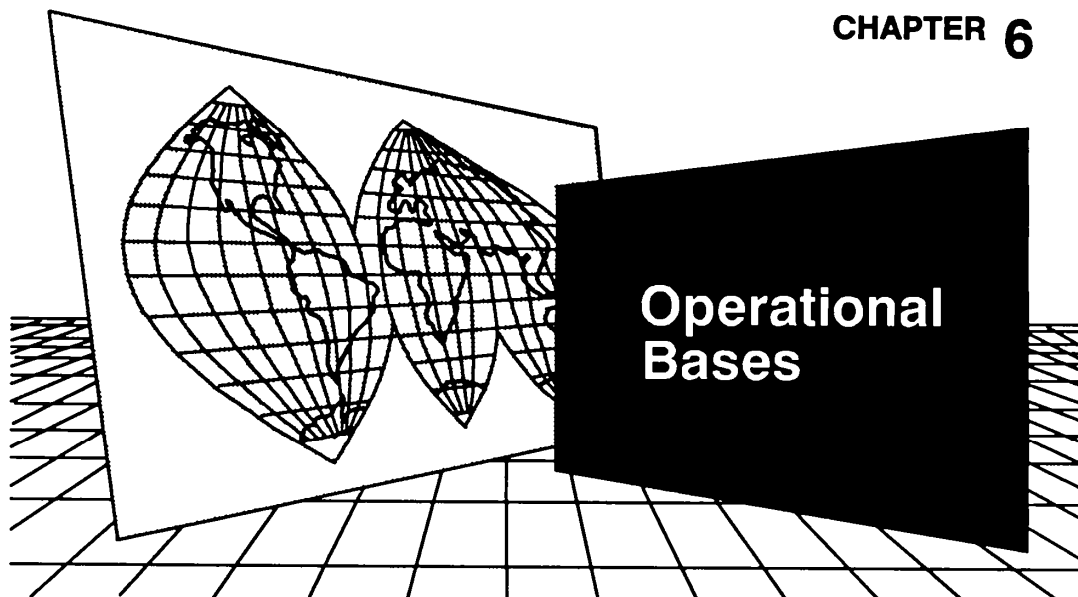

Figure 5-22. Type SF Communications in an Undeveloped Theater.

CHAPTER 6



The SF group design permits SF commanders to task organize according to mission requirements and the operational environment. Chapter 5 describes how SF commanders exercise C2 through a network of operational bases. This chapter describes how SF commanders establish, operate, and defend their bases.

Basing Considerations

The group commander recommends SF base locations to the SOC commander for approval. The mission will largely determine the number and configuration of bases. Based on the anticipated duration and scope of operations, the group commander decides whether to employ an SFOB only, an FOB only, or an SFOB with subordinate FOBs. The group commander must ensure that the base locations provide him responsive C2 and sufficient OPSEC.

Base Location

The group commander should locate the SFOB and FOBs at secure, logistically supportable locations within the COMMZ. They should be within a reasonable distance of departure sites to simplify infiltration and resupply operations. Bases should provide reasonable access to a main supply route. They should have a securable base perimeter. Locating bases within existing facilities enhances OPSEC by reducing their visual and electronic signature. However, their collocation with an airfield, port facility, or major conventional headquarters may increase the risk of their total destruction.

The SFOB and FOBs need not be located in the region they support. They may remain at a CONUS base, locate in a friendly nation outside the supported CINC's region, or be established at sea.

The training of uncommitted SFODs continues after actual SF operations begin. Uncommitted SFODs train in basic and specialized SF skills between combat missions. SF base locations must therefore provide suitable training sites.

Base activities may be consolidated at one site or dispersed at several smaller sites. Dispersal may improve OPSEC by reducing the signature of the

base, but dispersal also complicates base functions. The SF group and battalion are limited in their TOE capability to support dispersed base facilities.

Base Organization

Each SF group and battalion commander normally organizes his operational base into an OPCEN, SPTCEN, and SIGCEN (Figure 6-1). All three centers have their own organization and functions, but their activities are interdependent (Figure 6-2). A type arrangement of a consolidated operational base is shown at Figure 6-3.

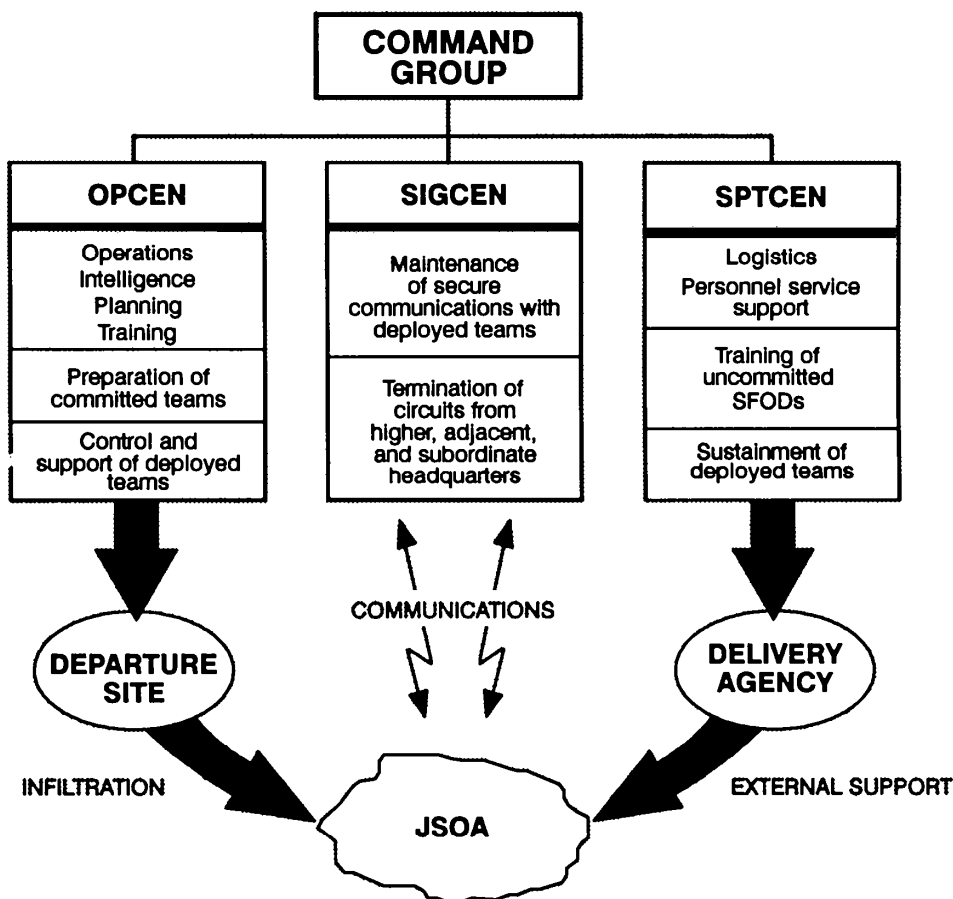

Figure 6-1. A Type SF Operational Base.

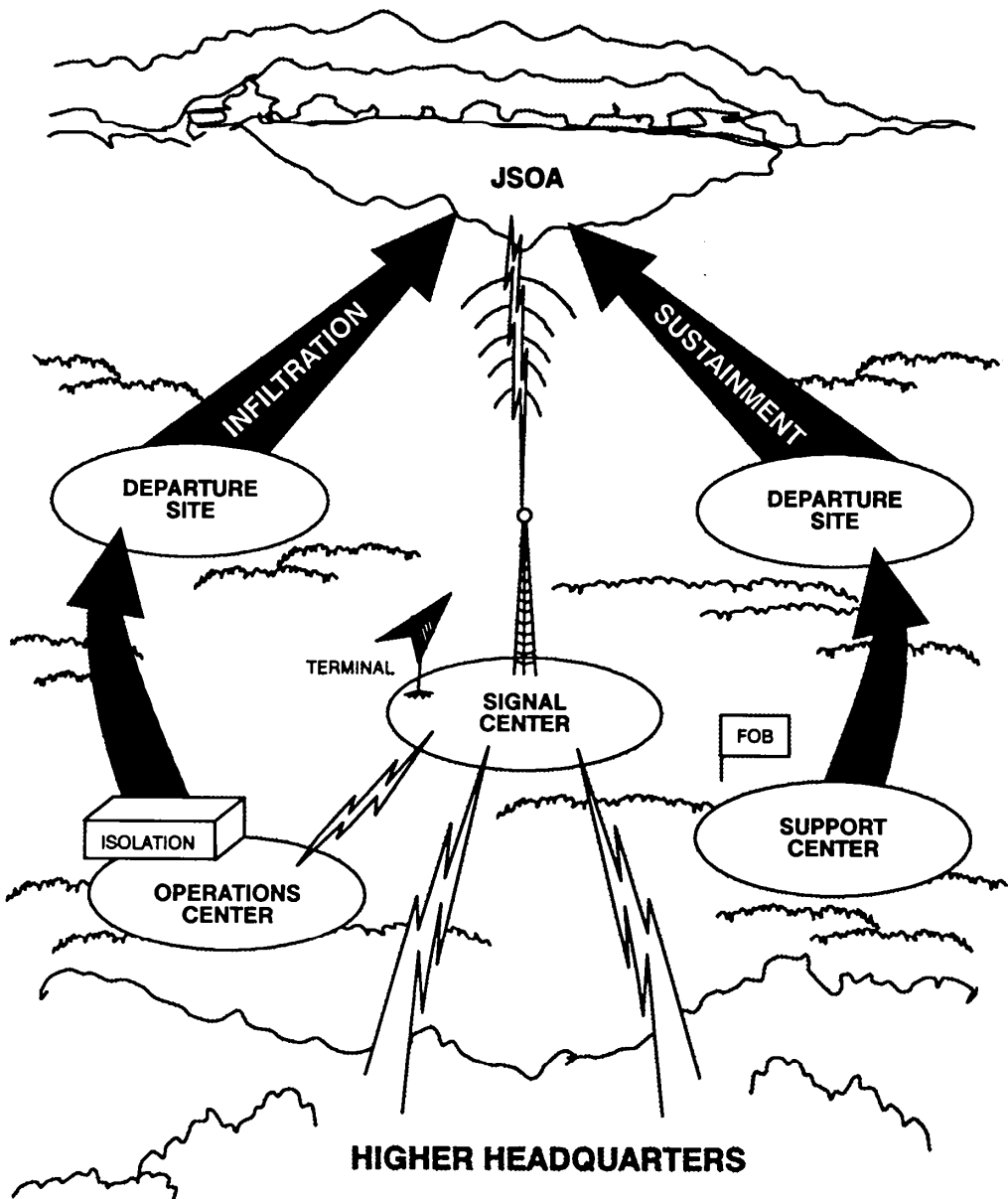
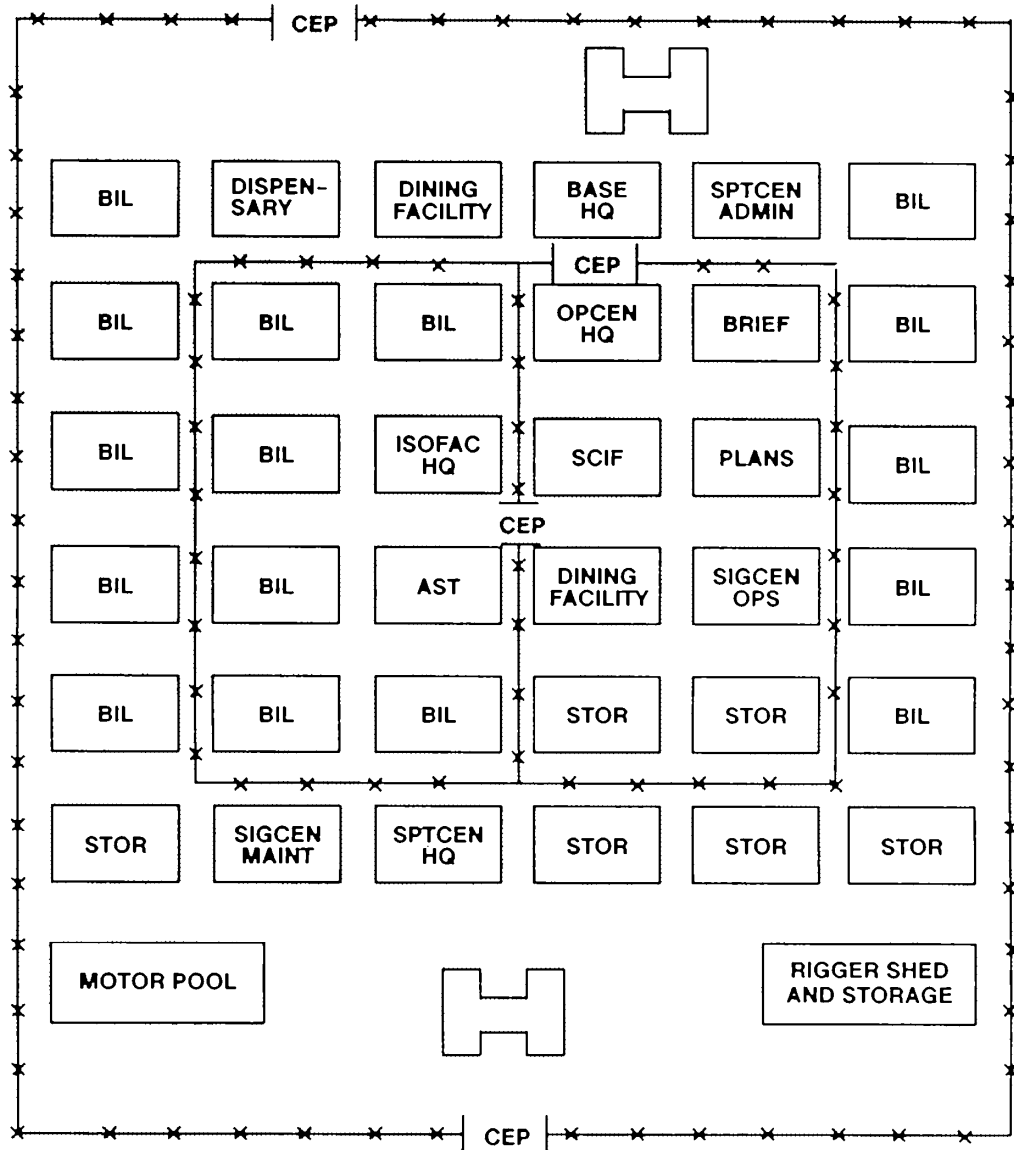

Figure 6-2. Interdependence of Operational Base Centers.



- NOTES:
1. CEP denotes controlled entry point.
 2. BIL denotes billeting area.
 3. STOR denotes storage area.
 4. SIGCEN transmission site is at a remote location and not shown.

Figure 6-3. A Type Physical Arrangement of a Consolidated Operational Base.

Operations Center

The OPCEN is the functional activity that directs and controls SF operations in a designated operational area. It performs the functions of a conventional

unit's TOC. The organization of a type OPCEN is shown in Figure 6-4.

OPCEN Director

Based on approved plans and guidance from the base commander, the OPCEN director supervises all operational aspects of mission planning and execution.

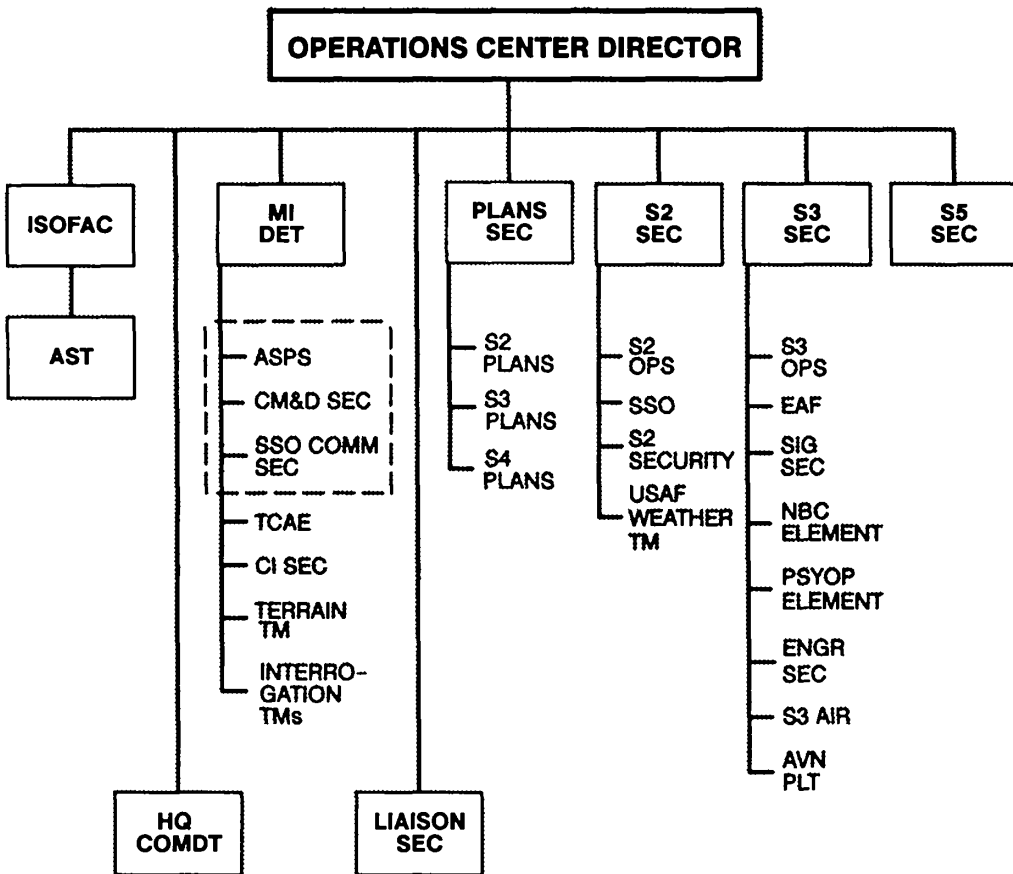

--- Under OPCON of S2

Figure 6-4. A Type SF Operations Center.

The OPCEN director ensures the total synchronization of S2 S3, and S5 activities within the OPCEN.

S2 Section

Under the staff supervision of the unit S2 the base S2 section is the focal point for all-source intelligence production and intelligence collection management. The section includes both the unit S2 section and elements of the group or battalion MI detachment task organized into three branches.

The S2 operations branch directs and coordinates the daily operations of the S2 staff. It exercises staff supervision of the tactical SSO, the attached US Air Force (USAF) weather team, and the MI detachment's all-source intelligence center (ASIC).

The S2 plans branch plans and coordinates intelligence support for future and contingent SF operations. It physically locates with the S3 plans branch or the consolidated plans section.

The S2 security branch develops unit security programs and supervises their implementation. Under its staff supervision, the MI detachment's CI section provides CI support to the S3's OPSEC program and deception planning.

The attached USAF weather officer serves as a special staff officer on all matters related to weather. His team provides operational weather support to the base, to include current and future weather data and climatic analysis and studies. The team prepares weather briefings for all SF teams in isolation. It also prepares operational area weather reports for deployed SF teams. When directed, the weather officer may attach USAF SO weather personnel to SF teams to provide weather data from denied territory.

MI Detachment

The MI detachment commander is the unit's principal intelligence producer and executor. He is responsible to the OPCEN director and base commander for providing required intelligence support. The MI detachment commander establishes and operates a tactical SCIF in the OPCEN. Within the SCIF, the unit S2 provides the SSO and exercises OPCON of the ASIC. The MI detachment com-

mander serves as ASIC chief. In this capacity he responds to formal taskings from the S2. In addition to his functions as ASIC chief, the MI detachment commander also directs and controls the technical control analysis element (TCAE) (formerly called the SOT B), the SSO communications team, and the interrogation and CI sections. Proper intelligence and electronic warfare (IEW) support depends on direct daily contact and informal tasking and coordination between the S2 staff elements and the various sections of the MI detachment.

The collection management and dissemination (CM&D) section performs intelligence collection management for the S2 operations branch. The CM&D section recommends PIR and IRs for the base commander's approval. It obtains the commander's approved requirements from the unit S2, prioritizes them based on S2 guidance, and translates them into collection missions. It then prepares the unit collection plan and forwards the unit's prioritized requirements to the TASOSC ISE. The CM&D section has tasking authority over organic and attached MI collection assets, such as the organic SOTs A and any attached HUMINT assets. (The S3 tasks those missions performed by SF teams or other subordinate non-MI assets.) The section also disseminates combat information and intelligence within the base and to higher, adjacent, and lower headquarters.

The all-source production section (ASPS) performs the base's intelligence preparation of the battlefield (IPB). The section processes, correlates, and integrates all-source intelligence in response to taskings from the CM&D section. The ASPS is thus the focal point for all situation and target development within the base. It develops and maintains the unit's intelligence data base, to include the intelligence journal, order of battle (OB) information, IPB products, targeting data, and situation map. It monitors the CM&D collection plan and recommends revisions to close identified gaps. It receives and processes intelligence products and combat information from higher, lower, and adjacent commands. It prepares intelligence estimates, reports, summaries, and briefs as required.

The TCAE collocates with the ASIC in the SCIF. There it serves as the focal point for SIGINT operations. At group level, the TCAE provides

centralized technical control over deployed SOTs A. It analyzes and correlates intercepted SIGINT data from the SOTs A with data from other sources and passes the product to the ASPS and the TAOSC ISE. It develops and maintains the SIGINT technical data base and the electronic order of battle (EOB) data base. It also links theater and national intelligence systems to integrate technical data produced by tactical units with data produced by the National Security Agency. The battalion TCAE requires technical support (for example, SIGINT technical data) from the group TCAE to exercise direct technical control over its deployed SOTs A.

The SSO communications section locates adjacent to the ASIC in the SCIF to provide secure SCI communications between the SFOB and its deployed FOBs. Higher headquarters provide SCI communications to the SOC J2 and TASOSC ISE.

The CI section operates from the OPCEN in close coordination with the S2 security branch and the ASPS. The primary function of the section is to perform CI analysis in support of the ASIC and the unit's OPSEC and deception programs. It performs source administration functions. It also supports the unit S2's personnel security and information security functions. Its CI teams conduct liaison with US and HN security organizations in the vicinity of the base. When provided by MTOE, counter-SIGINT teams provide communications monitoring and analysis for commercial and military landlines and radio-telephones at the base. The CI section coordinates with the supporting TA CI unit for investigative, technical, and operational support.

The interrogation teams deploy from the SFOB as required. One team may be permanently located at the theater's joint interrogation facility. Interrogators exploit PWs, line crossers, refugees, and informants. They conduct initial exploitation of captured documents. They also debrief friendly personnel who are returned PWs or who have escaped from hostile or denied territory. They establish liaison with other US, allied, or HN interrogation services and interrogation centers. Interrogators can act as interpreters or translators when other linguists are not available.

The supporting terrain team, while not part of the group MI detachment, collocates with and functions

as an essential element of the group ASIC. The MI detachment commander, as ASIC chief, tasks the team and controls its activities. The terrain team collects, compiles, and produces graphic and textual terrain data to support the group's needs. It also assists the ASPS in its IPB function by producing general and detailed terrain analysis, terrain studies, overlays, and overprinted maps.

S3 Section

Under the staff supervision of the unit S3, the base S3 section is responsible for the unit's organization, training, and operations. The section is organized into three branches.

The S3 operations branch directs and coordinates current SF operations being conducted by subordinate units. It exercises staff supervision of the ISOFAC and, at group level, the tactical EAF. Other specific functions include—

- Receiving, processing, and approving air support requests.
- Coordinating infiltration, exfiltration, resupply, and recovery operations.
- Monitoring training of uncommitted SFODs.
- Recommending employment of special weapons.
- Planning and coordinating offensive EW.
- Integrating PSYOP and CA into current operations.
- Managing the Class V unit basic load (UBL).
- Preparing the unit readiness report.
- Preparing other reports to the SOC, JSOTF, TASOSC, and other higher headquarters.

The S3 plans branch coordinates and prepares the unit's contingency plans. It also coordinates and prepares preliminary assessments (PAs) and mission concepts (MICONs) in support of the targeting process. It reviews plans of subordinate elements and coordinates plans with the other centers of the base. It anticipates future SF operations as far in advance as possible. This branch also maintains and revises the unit MTOE and augmentation TDA. The S2 and S4 plans branches collocate, as needed, with the S3 plans branch to facilitate the planning process. This consolidated plans section operates under the direct supervision of the OPCEN director.

In garrison, the area specialist team (AST) is an integral part of the S3 plans branch. There should be an AST assigned to each battalion, with a fourth AST to support those SPECAT missions controlled at group level. Each AST consists of an area specialist officer (ASO), an area specialist sergeant, and an intelligence analyst. The ASTs are the focal points for mission planning, targeting, and area study within the group. During actual operations, the ASTs normally augment the SFODs B that establish and operate the ISOFACs.

The S3 training branch plans, programs, coordinates, and manages the unit training program. When the group or battalion is committed to actual operations, the training branch plans, programs, coordinates, and supervises training for uncommitted detachments and replacements for committed detachments. Although it is part of the S3 section, this branch physically locates in the SPTCEN.

Isolation Facility

The ISOFAC is a maximum security facility established to isolate SF teams performing their mission planning and preparation. OPSEC is paramount throughout this period. SF teams committed to separate missions and separate operational areas are isolated to preclude mission compromise.

An ISOFAC should be capable of isolating six SF teams simultaneously. The limiting factor is the inability of the base staff to plan and prepare more than six missions at the same time. The ISOFAC should include—

- Separate briefing, planning, billeting, and storage areas for each operational element in isolation.
- Dining, latrine, and shower facilities.
- A dispensary service.
- A recreation and exercise area.
- Staff administrative support.

The group and battalion commanders each task an SF company headquarters (SFOD B) to establish and operate the ISOFAC under the direct supervision of the OPCEN director. The three-man peacetime AST is attached to the SFOD B to provide its expertise in current OPLAN requirements, targeting, and area studies. The SFOD B commander

task organizes into three cells to conduct continuous operations with two overlapping shifts.

The commander and sergeant major constitute the command cell. The cell ensures the SF teams receive proper support from their initial commitment through mission completion and debriefing. It ensures the proper degree of OPSEC and compartmentation within the ISOFAC. This use of an SFOD B enables the group or battalion S3 to plan and coordinate future operations while the ISOFAC commander supervises current operations under the OPCEN director's control.

The XO, supply sergeant, NBC NCO, medical sergeant, and two communications sergeants constitute the support cell. The cell provides the interface between the ISOFAC and the SPTCEN and SIGCEN. It ensures that the SF teams' equipment is mission-capable. It receives, consolidates, and tracks support requests to ensure the SF teams receive the signal support and CSS they require. The cell secures and maintains nondeploying equipment for the deployed teams. It also assists the teams in preparing automatic and emergency resupply bundles (Chapter 14). After the teams deploy, the support cell actively monitors their sustainment posture and recommends resupply and replacement actions as required.

The company technician, two operations sergeants, and the attached AST constitute the operations cell. This cell provides the interface between the ISOFAC and the rest of the OPCEN. The cell ensures the SF teams receive sufficient operational guidance and intelligence. It also provides the OPCEN current updates on the teams' status and situation. It helps the S3 prepare mission support plans and reviews the isolated teams' concepts and plans before they are presented to the OPCEN director. It coordinates operational activities that involve more than one isolated team, ensuring proper OPSEC and compartmentation is maintained throughout this process. It obtains training and rehearsal sites and ensures its teams complete all predeployment training requirements. It prepares the isolation schedule and coordinates the briefback schedule with the base command group. After its supported SF teams deploy, it tracks the missions, processes team message traffic, and recommends team mission taskings.

Without augmentation, the SFOD B can isolate only three or four SF teams simultaneously. The group or battalion commander can greatly improve the capacity and efficiency of the ISOFAC operations cell by augmenting it with two additional AST NCOs (normally profiled or other nondeploying SFOD members) for each isolated element. These AST NCOs provide 24-hour interface between the isolated team and the ISOFAC cells. The AST NCOs actively participate in all aspects of mission planning and preparation for deployment. They process and track mission support requests. They act as escorts to move the teams in and out of the ISOFAC as required. After infiltration, they actively monitor missions until their completion, track team message traffic, compile and maintain a written record of the missions, and assist the teams to ensure successful mission execution. Upon mission completion, the AST NCOs assist in team debriefing and the preparation of team after-action reports. In the process of supporting teams, the AST NCOs become intimately familiar with the teams' plans of execution (POEs) and the personalities of team members. To preserve OPSEC, the AST NCOs cannot deploy on another mission until their supported missions are complete.

Each two-man AST can normally support two or three SF teams after deployment, depending upon the complexity of the mission. A battalion therefore needs an augmentation package of 6 two-man ASTs to deploy 18 SF teams in three isolation cycles.

S5 Section

Under the staff supervision of the unit S5, the S5 section is responsible for the CMO of the unit. The S5 coordinates closely with the S3 to integrate CA considerations into all group operations. The S5 also coordinates with the S2 to incorporate CA intelligence products and requirements into unit intelligence products and planning. The SOC commander may attach elements of a CA battalion (FID/UW) to the SF group. In this case, the S5 exercises staff supervision and makes employment recommendations.

The group S5 may direct and supervise the activities of the consolidated plans section. By placing the S2, S3, and S4 plans branches under S5 control, the group

commander creates a staff element corresponding to the J5 element of the SOC or JSOTF.

Liaison Section

The liaison section is under the direct supervision of the OPCEN director. The group commander exchanges liaison officers with the theater Air Force Special Operations Command (AFSOC) and Naval Special Warfare Task Group (NSWTG). He may also exchange liaison officers with US nonmilitary agencies and allied military organizations. The group staff coordinates closely with the appropriate liaison officers to ensure proper mutual support and to synchronize joint SO. By TOE, the SF group is not authorized any liaison officers. Without MTOE or TDA augmentation, the group commander must use personnel from uncommitted detachments.

NBC Element

The chemical officer establishes and operates the NBC element in the OPCEN. The NBC element receives and processes NBC reports from higher headquarters and deployed SF teams. It maintains the current NBC status of the unit. It briefs and assists committed SF teams during mission preparation. It also monitors unit NBC training.

Engineer Section

At group level, the engineer officer establishes and operates the tactical EAF in the OPCEN. The EAF receives and processes emergency action (EA) traffic. It manages and implements the group EA program using additional duty EA-trained personnel located throughout the OPCEN. It also monitors special weapons training and proficiency. In addition to these duties, the engineer performs the normal functions of a staff engineer, assists the S2 in the target development process, and monitors unit engineer training.

Signal Section

The signal officer establishes and operates the signal support coordination element (SSCE) in the OPCEN. The SSCE plans and coordinates all unit signal support. It directs the activities of the unit's signal detachment. It exercises technical control over the SSO communications section, subordinate units,

and deployed SF teams. The SSCE maintains the unit COMSEC account. It also manages automation within the unit.

PSYOP Element

Under the staff supervision of the unit S3, the PSYOP officer advises the commander and his staff concerning the psychological implications of specific SF operations. He recommends how to integrate

PSYOP into SF operations, and he coordinates external PSYOP support. He exercises staff supervision over attached PSYOP units. The SOC commander normally attaches a tailored PSYOP detachment to the group to provide direct PSYOP support (Chapter 15). The group commander further attaches PSYOP teams to subordinate SF commanders as required. At SF battalion level and below, the attached PSYOP commander also serves as PSYOP staff officer to the supported SF commander.

Support Center

The SPTCEN is the functional activity that provides CSS to the base and its deployed SF teams. It performs the functions of conventional unit trains. A type SF support center is shown at Figure 6-5. At the group SPTCEN, the group S1 and S4 plan and coordinate CSS for the entire SF group and monitor the CSS operations of the SFOB and subordinate bases. The SPTCEN performs the following functions:

- Plans and controls the administrative activities of the base, to include the coordination of facilities engineering and other base operations support.
- Maintains the UBL of all classes of supply.
- Manages assigned stocks.
- Coordinates movements.
- Develops and manages the maintenance plan.
- Requests external CSS and coordinates CSS requirements with supporting CSS units.
- Maintains control of personnel management and records.
- Supports the training and preparation of uncommitted SFODs.

SPTCEN Director

The SPTCEN director is the support company commander. He is responsible to the base commander for the execution of all base CSS operations. He is also responsible for SPTCEN housekeeping details, to

include billeting, food service, space allocation, and internal guard duties. The group SPTCEN director has no responsibility for the CSS operations of subordinate FOBs and AOBs.

S1 Section

The S1 supervises the S1 section of the SPTCEN. The S1 is responsible to the SPTCEN director and base commander for administration and management of personnel assigned or attached to the base. He assists SF teams during their mission preparation. Once SF teams deploy, the S1 monitors and responds to their support requests through the ISOFAC support cell. His primary concerns include—

- Personnel accountability and strength management.
- Casualty reporting.
- Personnel replacement operations.
- Personnel actions for deployed SF personnel.
- Other personnel services, to include any administrative support of indigenous forces.
- Base administrative services, to include operation of the base distribution center. The center processes all base correspondence except messages to and from deployed SF teams.

S4 Section

The S4 supervises the S4 section of the SPTCEN and exercises staff supervision over attached or supporting logistical units. The S4 assists SF teams

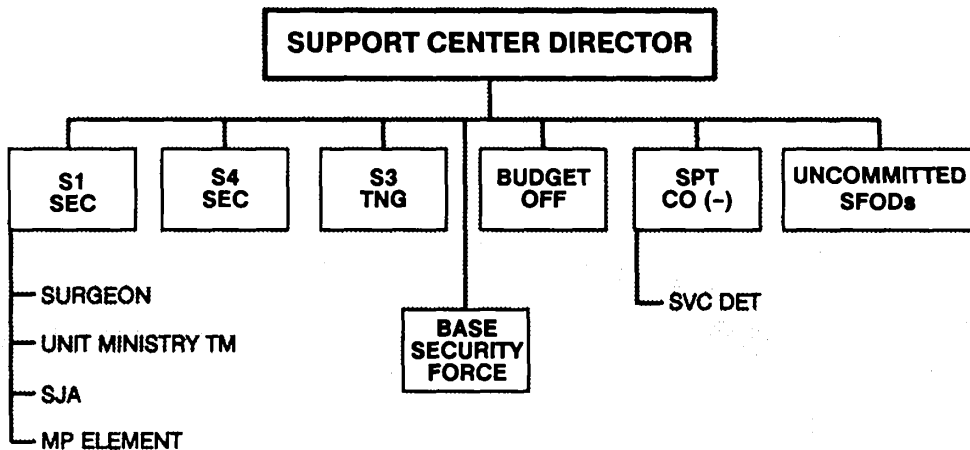

Figure 6-5. A Type SF Support Center.

with logistical matters during their mission preparation, to include any logistical support requirements for indigenous forces. Once SF teams deploy, the S4 monitors and responds to their support requests through the ISOFAC support cell. The S4 plans officer collocates, as needed, with the S3 plans section in the OPCEN to prepare the logistical portion of unit plans.

Service Detachment

The service detachment performs unit-level supply, services, and maintenance functions for the base and its attached elements. It also coordinates base transportation support.

The supply and transportation section performs consolidated unit-level supply functions for the base and its deployed SF teams. At group level it maintains the property book and basic loads (less Class I, VIII, and IX) for the group HHC and support company. At battalion level, it performs these functions for the entire battalion. The section also procures nonstandard and SF-peculiar supplies and equipment. The section's organic trucks provide local transportation support to the base, but the section depends on nondedicated drivers to perform this function.

The food service section provides consolidated food service to the base. The section establishes and operates a dining facility in the SPTCEN. In addition to its 24-hour feeding operation to support both base shifts, the section conducts remote feeding operations as required. The section also maintains the unit's Class I basic load.

The mechanical maintenance section performs consolidated unit-level maintenance support for the base's organic wheeled vehicles and power generation equipment. It also coordinates for DS maintenance support, evacuates damaged items to the supporting DS maintenance company, and maintains the unit's prescribed load list (PLL).

The rigger-air delivery section provides personnel and cargo parachute packing, unit-level maintenance of air delivery items, rigger support, and limited air delivery support to the base. It also coordinates external rigger and air delivery support when requirements exceed organic capabilities.

Uncommitted SFODs

All SFODs do not deploy simultaneously. Uncommitted SFODs prepare for contingency missions and rapid deployment in the event of a time-sensitive requirement. Uncommitted SFODs should not perform housekeeping duties or support functions at the expense of their combat readiness.

The SFOB SPTCEN normally has no responsibility to support the subordinate FOBs, except for providing technical assistance when required. If the SFOB and an FOB are supported by the same TA units, the group S1 and S4 may have to submit

consolidated reports and requests. They may also have to coordinate throughput distribution to the FOB or even to its AOBs. When two bases collocate, the group commander may decide to collocate or consolidate their SPTCENs for mutual support.

Signal Center

The mission of the SIGCEN is to install, operate, and maintain secure, reliable, long-range communications between the base and its—

- Higher, adjacent, subordinate, supporting, and supported headquarters.
- Deployed SF teams.

The SIGCEN also installs, operates, and maintains continuous internal base communications. A type signal center is shown at Figure 6-6.

Within the SIGCEN, the base station section provides HF radio burst and UHF tactical satellite (TACSAT) communications between the base and its deployed SF teams. The section can use these same means to provide backup communications among the SFOB and FOBs. The section establishes and operates separate receiver and transmitter sites. The transmitter site must be located away from the rest of the SIGCEN for technical as well as OPSEC reasons. The section's telecommunications center collocates with the receiver site. It receives and processes outgoing messages from the OPCEN telecommunications center for transmission to the SF teams. It also receives incoming messages from the receiver site for processing and forwarding to the OPCEN communications center.

The base communications support section provides internal communications support to the base. To accomplish this task, the section task organizes into two teams.

The OPCEN telecommunications center receives, processes, and distributes all incoming and outgoing message traffic. The center must be linked by messenger or other secure means to the supporting area SIGCEN. When augmented, the team also operates and maintains SATCOM, facsimile, and tactical radio equipment linking the OPCEN with other headquarters.

The section's switchboard team operates and maintains the base's internal telephone system. The signal detachment has no dedicated wire teams because SF bases are fixed. The detachment task organizes to install the telephone system during the occupation of the base. The base switchboard must be connected into the switchboard of the supporting area SIGCEN to obtain access to the TCS and DCS.

The base communications support section also maintains secure single-channel HF RATT communications between the SFOB and FOBs. When available, HF multichannel equipment will replace the section's RATT system(s).

The electronic maintenance section provides unit-level and DS maintenance of signal equipment (to include COMSEC equipment) to the base and its supported SF teams. The section also performs limited GS maintenance on SF-peculiar signal items.

At group level, the photo section provides limited ground and aerial still photographic support to the entire SF group. When the group's requirements exceed organic capabilities, the group signal officer coordinates through the TASOSC signal officer to obtain external support from the supporting echelons above corps (EAC) signal unit.

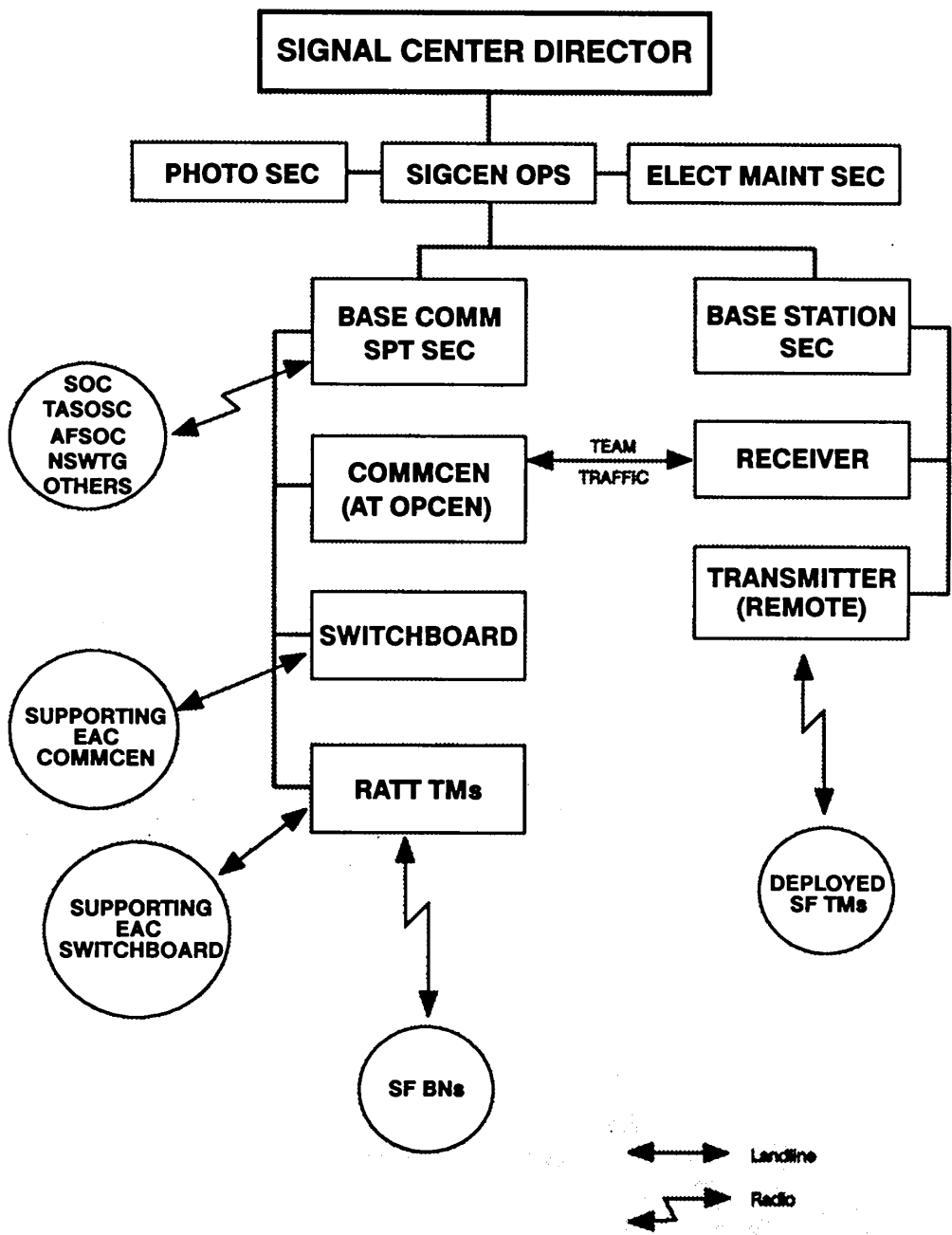

Figure 6-6. A Type SF Signal Center.

Alternate Bases

The group commander always designates a subordinate FOB as the alternate SFOB to assume the SFOB's functions if the primary SFOB is destroyed or becomes untenable. He also designates an alternate base for each deployed FOB and AOB. The group commander ensures each alternate base is prepared to assume the primary base's mission. He pays particular attention to emergency communications procedures, established intelligence links, and the provision of AST packages to the alternate ISOFAC. He may have to arrange augmentation

of normal TOE resources. Alternate C2 arrangements depend on standardized internal procedures to maintain continuity of operations should the primary base become inoperable.

Operational bases are normally fixed. However, they may have to displace because of hostile activity or natural disaster. The group and battalion commanders and their staffs must prepare displacement plans to ensure continuity of operations. They must shift minimum operational and emergency communications to their alternate base before displacement begins.

Base Defense

Operational bases are subject to the full range of hostile air and surface threats identified in Chapter 2. Because of the austere nature of SF organizations, they require dedicated security forces to protect their operational bases from hostile actions.

Security Forces

There are three options for obtaining base security forces: US unilateral, combined US and HN, or HN unilateral.

The preferred base defense option is for US elements to secure the group's bases and activities. The bases may be located within the perimeters of larger US installations. However, US installations and base defense assets may not be available, and the HN may not authorize US unilateral security operations beyond the base perimeter.

In a combined US and HN option, US base defense elements may provide physical security within the base perimeter. A HN or combined US and HN military or paramilitary force may provide security

beyond the perimeter (perhaps within the perimeter of a larger HN installation). If the supporting US base defense element cannot fully perform the base defense mission, the SF base commander may have to divert operational and support personnel to augment its capabilities. Any such diversion will require an MTOE or augmentation TDA change to provide the affected SF unit with adequate base defense weapons, communications, and other security equipment. The diversion will reduce the operational and support capabilities of the affected SF unit.

In the third option, the supported HN force may provide physical security to the base. The SF commander may also contract with the HN or another (third country or commercial) source for a dedicated security force.

Command and Control

The SPTCEN director, in coordination with the S3, headquarters commandant, and supporting base defense element commander, prepares the base defense plan. This plan provides options for the coordinated defense of the base against surface or air

attack, to include acts of sabotage and terrorism. The plan employs active and passive security measures by partitioning the base into security areas, assigning responsibility for the areas, and establishing a BDOC to coordinate and control base defense operations.

The BDOC commander is normally the supporting base defense element commander. If no supporting base defense element is available, the headquarters commandant serves as BDOC commander. In either case, the BDOC commander coordinates base defense activities. He ensures that unit guards are integrated into the base security plan. The BDOC maintains continuous communications with supporting security forces, to include any HN forces. It exercises OPCON of the designated base response force. In a combined US and HN effort, the BDOC commander and his HN counterpart must consider language capabilities. They must agree on—

- Chain of command.
- Rules of engagement.
- Organization and manning of the response force.
- Areas of responsibility.
- Employment tactics and techniques.
- Exchange of liaison personnel.
- Standardized secure communications.

The close defense area (CDA) is the area within the physical limits of the base perimeter. The perimeter should be large enough to accommodate base facilities but small enough that it does not unnecessarily commit resources to force protection in the CDA. Within the CDA, each SF unit develops a supporting base defense plan for its role in the coordinated defense of the base. The dedicated security force—

- Secures the perimeter itself and provides controlled access to the operational base.
- Defends critical facilities, to include the SCIF, EAF, ISOFAC, and SIGCEN.
- Provides controlled access to the OPCEN.
- Provides the primary response force in the event of penetration.

The main defense area (MDA) extends beyond the base perimeter to the projected maximum effective range of infantry indirect fire weapons and

man-portable air defense (MANPAD) systems. In situations where the dedicated security force is not responsible for security operations in the MDA the BDOC commander coordinates with his MDA counterpart to ensure effective coverage.

Outlying sites and surface transportation routes should be considered extensions of the main base. If applicable, they should be divided into security areas.

Detection and Assessment

Security forces in the MDA and CDA detect and assess threats by a combination of mounted and dismounted security patrols, electronic surveillance equipment, listening and/or observation posts, and active CI operations. If the security forces cannot prevent hostile penetration of the base perimeter, they destroy the hostile force or delay it until the response force arrives. The security forces then assist the response force as required.

With the exception of designated critical facilities, units protect their own specific facilities within the CDA. The BDOC commander coordinates and deconflicts unit security activities. Interior guards man both fixed and roving guard positions to defend specific buildings, sites, equipment, and personnel from intrusion and sabotage.

Delay

After detection occurs and an assessment is made, delay measures provide sufficient time for security forces to respond. The BDOC commander must develop a delay plan for each critical facility. Delay measures can be either passive or active. Passive measures include fences, lighting, wire obstacles, trenches, revetments, vehicle barriers, minefield, and other physical security barriers. Active measures include road blocks, guard posts, and entry control points. The combined effect of multiple measures minimizes the hostile force's freedom of action.

Response

The SF base commander establishes a response force around a nucleus of dedicated security personnel. He augments this nucleus with other base personnel

designated and trained to perform response force duties. The mission of the response force is to—

- Interdict, disrupt, apprehend, or destroy a hostile penetration force before it can disrupt a critical facility.

- Apprehend or destroy a hostile force that has gained access to a critical facility.
- Regain control of the CDA and reestablish the integrity of the base perimeter as soon as possible.

NBC Defense

Operational base elements employ standard NBC defense measures to protect themselves in an NBC environment. The most likely NBC threat to SF bases

is contamination with persistent chemical agents. SF base commanders must harden critical base facilities against chemical attack. They must also develop contingency plans for decontaminating the base or displacing in the event of contamination with persistent chemical agents.

CHAPTER 7

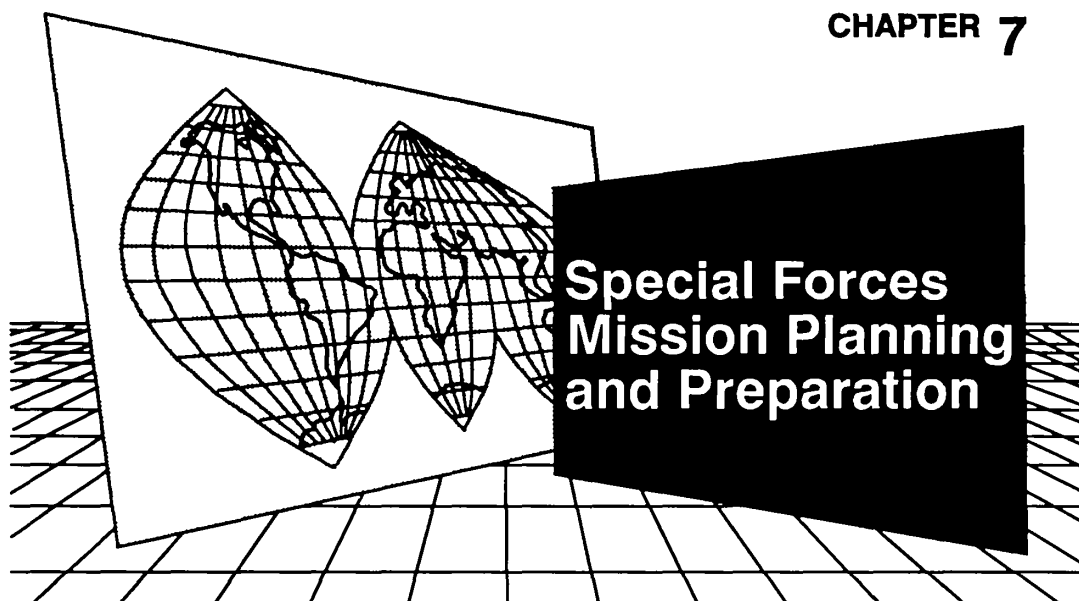

Detailed mission planning is vital to successful mission execution and SF team survival. SF mission planning is distinctive in its degree of jointness, its dependence on operational intelligence, and the level of participation by operators. This chapter describes the joint SO targeting process and how SF commanders plan missions and prepare SF teams for deployment. It covers both deliberate and time-sensitive planning. It also discusses employment considerations for SF teams operating in an NBC environment.

Joint SO Targeting Process

The joint SO targeting process influences how SF commanders plan and prepare for missions. It prescribes how the TASOSC ISE and SF MI detachments develop targets. (See JCS Pub 3-05.5 and FM 100-25 for detailed discussions of the joint SO targeting process.)

Deliberate SO mission planning begins at theater level with the joint SO targeting process (Figure 7-1). The CINC establishes a joint target board (JTB) to

direct the theater targeting process, to include SO targeting. The board consists of members of the CINC's staff and representatives of each subordinate command. The JTB ensures the effective employment of all theater-level deep surveillance and attack resources. With regard to SOF, the JTB —

- Establishes SO targeting objectives and priorities based on the CINC's SO targeting guidance and concept of SOF employment.
- Receives, consolidates, deconflicts, and prioritizes SO target nominations from subordinate force commanders, to include the SOC commander and, if necessary, from supported allied force commanders.

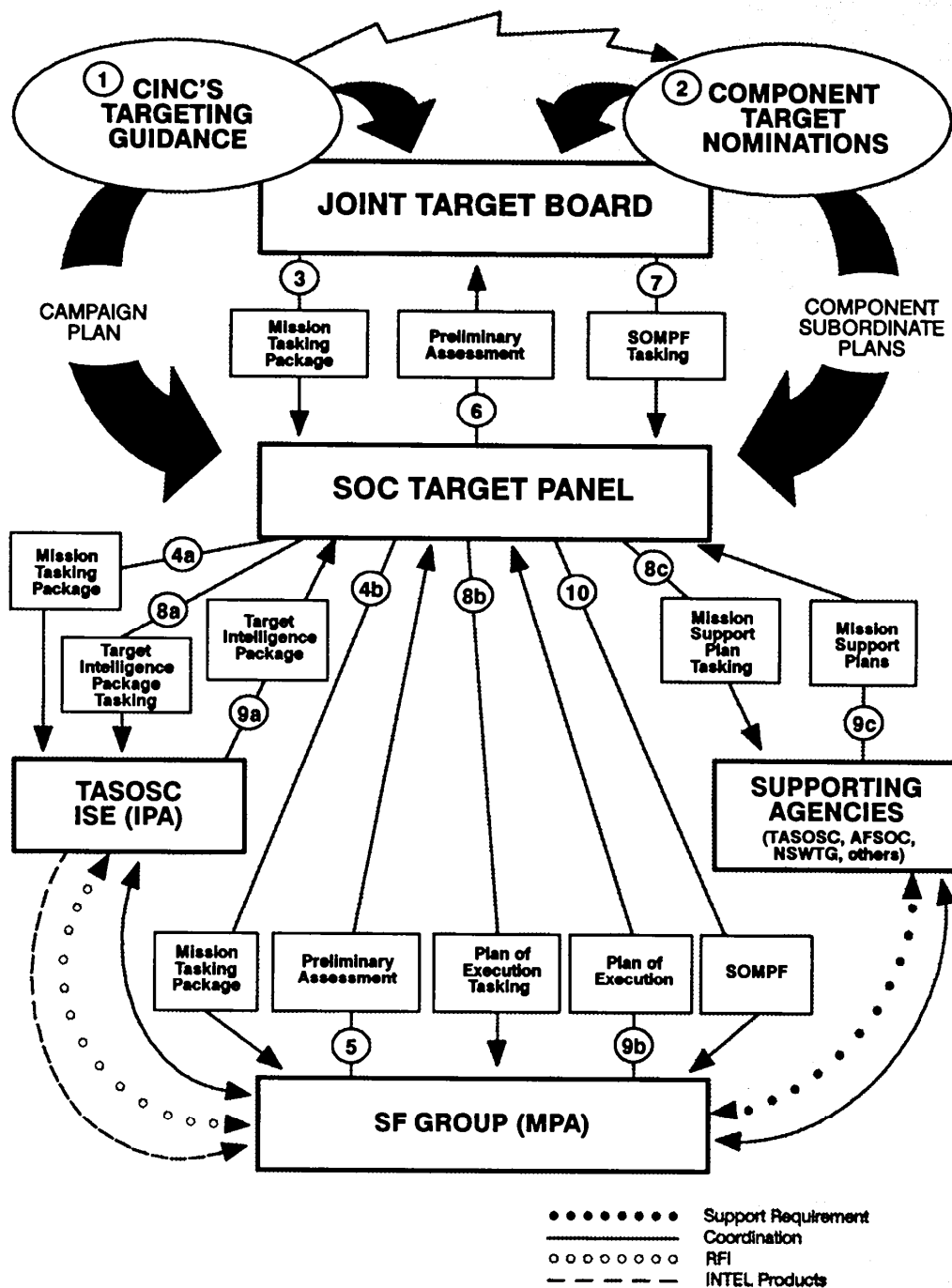

Figure 7-1. Joint SO Targeting Process.

- Tasks the SOC to assess, plan, and/or execute the mission.
- Determines support requirements and tasks appropriate agencies to support the mission.
- Tasks the service intelligence production agencies (IPAs) through their respective components to support the targeting process.

When a target, a target system, or an objective area is nominated for attack by a SOF unit, the JTB forwards the nomination in a mission tasking package (MTP) to the SOC target panel. The MTP includes target identity and location, desired results, and all available intelligence (Figure 7-2).

The SOC target panel designates the appropriate SOF unit as the mission planning agent (MPA) for the nominated mission. In SF, the MPA is normally the SF group responsible for the region where the nominated mission is to occur. The SOC target panel forwards the MTP to the MPA to perform a PA.

Upon receipt of the MTP, the SF group plans officer convenes the group target assessment group (TAG) to assess the SOC mission statement and MICON. If the TAG determines that the nominated mission is a valid SOF target and looks feasible, it develops courses of action (COAs) for further analysis. Based on the TAG assessment, the SF group commander issues initial planning guidance and directs the group staff to prepare staff estimates for each COA. The commander uses the results of this estimate process to determine if the group can execute the mission with an acceptable degree of risk.

The JTB also forwards the MTP through channels to the appropriate service IPA. The IPA provides the MPA with any additional intelligence required to perform the PA. As a minimum, the MPA needs imagery, an area study, maps, and OB intelligence to perform a PA.

The group plans officer formalizes the group commander's decision in PA format (Appendix D) and forwards the completed PA through the SOC target panel to the SOC commander. He concurs or non-concurs with the PA and forwards it to the JTB for approval. If the PA determines that the target is valid and feasible, the JTB adds the target to the approved target list and assigns it a priority. The JTB then

directs the SOC to prepare a special operations mission planning folder (SOMPF) for the target.

At the same time that it tasks the SOC to prepare an SOMPF, the JTB also tasks the appropriate service IPA to produce a target intelligence package (TIP) that supports the SOMPF. The TIP contains detailed information on the target, the operational area, and other aspects of the mission. The MPA cannot complete the POE until it receives the TIP. However, TIP and POE development can and should be concurrent activities to the extent possible.

The SOC commander directs the MPA to prepare a POE and other appropriate SOF units to prepare mission support plans. The SOC directive establishes joint support relationships and designates the MPA as the coordinating authority for the mission. Joint planning sessions between the MPA and supporting SOF units are essential if they are to produce quality plans. The scope of the supported MPA commander's coordinating authority over supporting SOF units is prescribed in the SOC directive. Unless otherwise specified by the SOC directive, the supported MPA commander has the authority to exercise general direction of the supporting effort, as prescribed in JCS Pub O-2.

The MPA prepares the POE (Figure 7-3). Based on the complexity of the planning requirement, SF commanders assign actual mission planning responsibility to the lowest possible level. An SF battalion, company, or SFOD staff may actually prepare the POE. As the POE planners refine the MICON, they develop a detailed list of specific operational, intelligence, and support requirements. The group staff forwards requirements beyond organic capabilities to the TASOSC or the appropriate supporting SOF unit for inclusion in its mission support plan. The POE planners periodically brief the SF battalion and/or group commander to ensure the planning effort adheres to his intent. POE development concludes with a formal decision brief to the SF group commander. The POE is then finalized and forwarded to the SOC target panel.

Concurrently and in close coordination with the MPA the TASOSC and supporting SOF units prepare their mission support plans. Mission support plans must identify how the supporting unit intends to meet the requirements identified by the POE

**SECTION I
TRANSMITTAL
DOCUMENTS**

**SECTION II
TARGET
IDENTIFICATION
DATA**

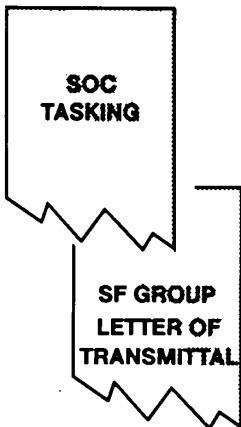

1. Name: _____
2. Basic Encyclopedia Number: _____

3. TDI Category: *(Functional classification as described in DIAM 65-3-1 and DIA TDI handbook).* _____

4. Country: _____
5. Coordinates: *(UTM and geodetic).* _____

6. General Description and/or Significance: *(Brief explanation of importance of installation in terms of impact should its use be partially or totally denied.)* _____

SECTION III CINC MISSION GUIDANCE

This five-part guidance contains the unified commander's mission statements and objectives. This information is required by the SOMPF development chain of command to conduct effective planning.



SECTION IV RECORD OF CHANGES

SECTION V RECORD OF DISTRIBUTION

Figure 7-2. Mission Tasking Package.

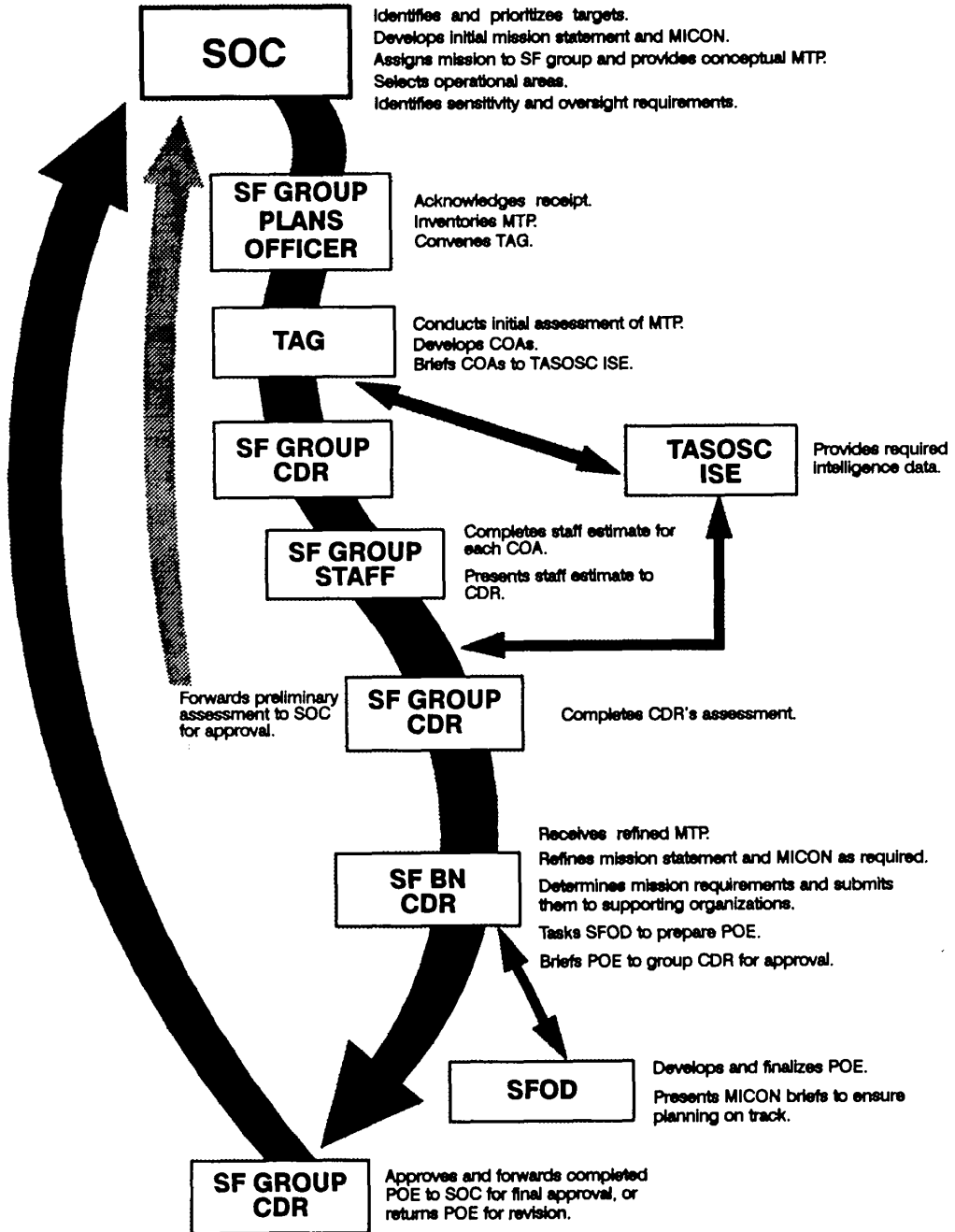

Figure 7-3. POE Development Flow.

planners. Depending on the nature of the mission, mission support plans and their annexes include but are not limited to—

- Infiltration, resupply, and/or exfiltration.
- Signal, intelligence, and other combat support.
- OPSEC and deception.
- Basing and other CSS.

Upon receipt of the POE and mission support plans, the SOC target panel assembles the SOMPF (Figure 7-4) and forwards it to the SOC commander for review and approval. Once the SOC commander approves the SOMPF, he may direct the MPA to conduct a POE capability demonstration. This demonstration should simulate the approved POE as

closely as possible, subject to OPSEC and other limitations. Following the demonstration, the MPA corrects identified shortfalls in the POE.

This deliberate targeting process must be modified to perform adaptive (time-sensitive) targeting during crisis or open hostilities. The key to adaptive targeting is concurrent activity. Upon receipt of an MTP, the MPA treats it like an alert order under the Joint Operations Planning System (JOPS) crisis action procedures. The MPA commander issues a warning order to the appropriate subunit and begins POE preparation as soon as the PA is complete. (See JCS Pub 5-02.4 for a detailed explanation of JOPS crisis action procedures.)

Assignment of Missions and Operational Areas

The SOC commander assigns missions to an SF group on the basis of the joint targeting process described above. In coordination with the group

commander, he also selects the JSOA for each SF mission (Figure 7-5). Missions range from a specific task (such as the attack of a point target) to abroad continuing mission-type order (such as the conduct of UW in a specified JSOA). Appendix E provides a sample SOC mission letter to an SF group.

SF Team Selection

Once the SOC commander assigns a mission and selects the JSOA the base (group or battalion) commander selects the SF team to execute the mission. The commander should select the team and/or task organize as early as possible to ensure

all team members participate in the mission planning process. Factors influencing his selection are shown in Figure 7-6.

Special Mission Requirements

Some SF mission taskings require capabilities that only certain SFODs have. These capabilities include

**BASIC
STRUCTURE**

**RESPONSIBLE
ORGANIZATION**

MISSION TASKING PACKAGE

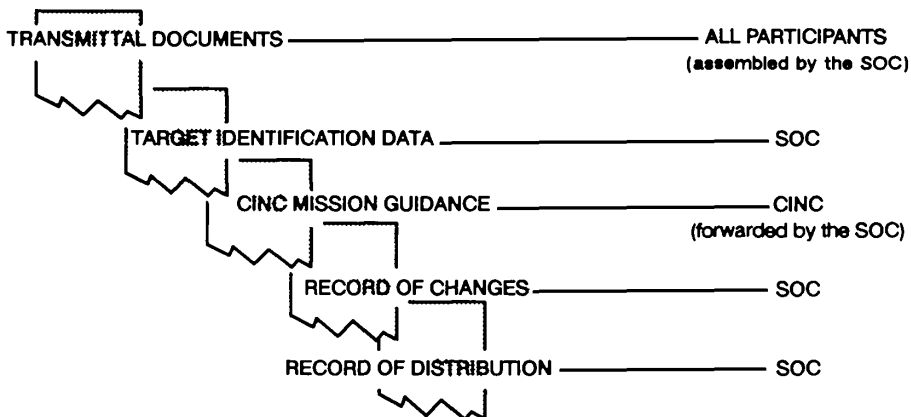

TARGET INTELLIGENCE PACKAGE

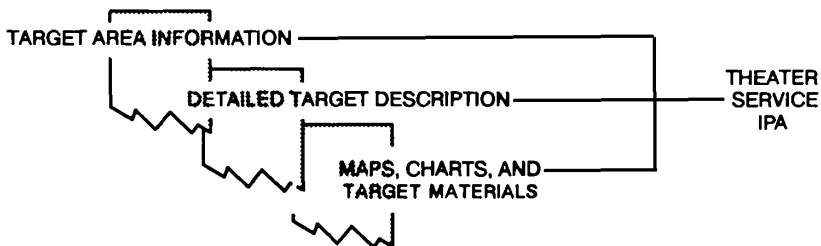

PLAN OF EXECUTION

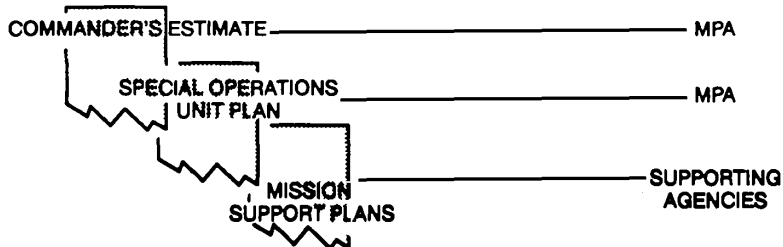

Figure 7-4. SOMPF Structure and Responsible Organization.

MISSION REQUIREMENTS	Mission requirements dictate the general location where the SF operational element must deploy to accomplish the mission.
TARGET POTENTIAL	The JSOA must contain targets of significance to the theater campaign plan or to the conventional military operation that the SF operational element will support.
RESISTANCE POTENTIAL	For UW operations, the JSOA must contain sufficient resistance potential that the SF team can develop into an effective resistance organization.
ACCESS TO URBAN AREAS	Urban areas provide access to key government activities; opportunities for acquiring intelligence, funds, supplies, and materiel; and a reasonably cohesive propaganda audience.
SIZE	The JSOA must contain adequate maneuver space. The SOC commander considers distance, terrain, natural boundaries, and the scope and duration of the mission. Political or military boundaries and cultural differences of the indigenous populations may also influence the size and shape of the JSOA.
TERRAIN	For rural-based UW operations, the JSOA must include some terrain that is difficult enough to discourage large-scale hostile military operations, but not difficult enough to preclude its use as a UW base complex. For other SF operations, terrain remains critical to the SOC commander's assessment of potential JSOAs.
SURVIVABILITY	For sustained UW operations, the JSOA must have sufficient agricultural resources and water to support the intended size UW force without excessive external logistical support. For all SF operations, the effects of climate on survivability must be considered.

Figure 7-5. JSOA Selection Criteria.

area orientation; language, MFF, and scuba qualification special weapons skills; NBC reconnaissance skills; and specialized clandestine collection skills.

Criticality or Sensitivity of Mission

Some SF missions may be so critical or sensitive that the SF group commander entrusts their execution only to certain SFODs. Examples of such missions include missions categorized as special activities.

Situation in the JSOA

The topography, hostile situation, political rivalries, or ethnic or cultural differences within the JSOA may require that two or more SF teams infiltrate simultaneously to independent sector commands.

Size and Composition of the Resistance Organization

The SOC and SF group may not know the size and composition of the resistance organization. If the size

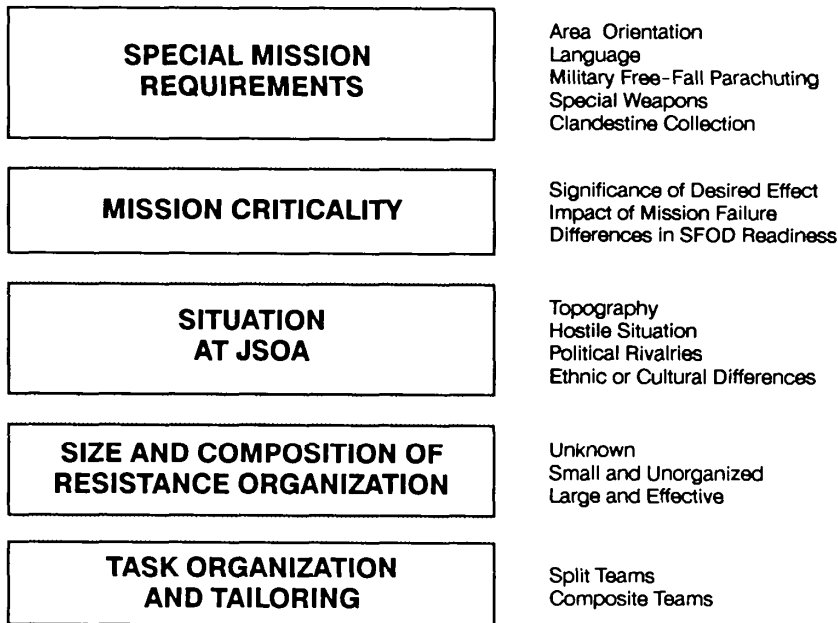

Figure 7-6. Considerations for Team Selection.

of the resistance organization is unknown, a small assessment or pilot team can infiltrate into the JSOA to establish contact with the resistance organization. The team determines the feasibility of developing the area's resistance potential. Once the pilot team has completed its area assessment, additional SF teams may infiltrate. The pilot team either exfiltrates or remains in the JSOA, as directed.

If the resistance organization is known to be small and unorganized, but has the potential for expansion, a tailored SFOD A may infiltrate to begin the initial development of the organization.

If the resistance organization is already large and effective, an SFOD B may infiltrate to coordinate external support and to synchronize resistance activities with those of the theater CINC.

Task Organization and Tailoring

Just as conventional units task organize to perform specific missions, SF commanders also task organize

their SFODs in response to mission requirements. Some missions may require multiple SFODs under the control of an SF company headquarters. Others may require a mix of skills not found in an integral SFOD. SF commanders can tailor their SFODs when an integral SFOD is not the optimal organization to perform a mission. They have two means of tailoring their SFODs: split teams and composite teams.

The SFOD can divide into two operational elements called split teams, each capable of conducting sustained operations on a reduced scale. The employment of split teams is appropriate when-

- The assigned mission does not require commitment of a complete SFOD.
- The hostile situation does not permit operations by a complete SFOD.
- A change in situation requires a deployed SFOD to split and execute an additional mission.

Certain SF missions require the organization of composite teams drawing individual soldiers from

established SFODs (or from outside the SF group) to obtain the proper mix of skills and experience needed to execute the mission. The group

commander must balance mission requirements against the effects on unit morale, readiness, and OPSEC before organizing composite teams.

Support and Sustainment Planning Process

Once an SF group commander receives the SOC mission letter, his staff prepares a statement of requirements (SOR). The SOR consolidates and prioritizes all group requirements that exceed its organic capabilities. A complete SOR addresses in detail all aspects of CS and CSS, to include—

- Logistics, including supply, services, maintenance, and transportation.
- Soldier support, including personnel services, legal services, finance services, postal services, and religious support.
- Health service support.
- Intelligence and CI support.

- Base defense, including NBC defense, air defense coverage, and MP support.
- Signal support, including frequency and COMSEC requirements.
- General aviation support.
- Engineer support, including real estate, real property maintenance activities, base development, and construction of training and rehearsal sites.
- Sustainment training of uncommitted SF teams.
- CA and PSYOP support.

The group S3 forwards the SOR to the TASOSC director of plans and operations (DPO) for action. Based on guidance from the SOC, the TASOSC DPO validates, consolidates, and prioritizes the SORs of all theater ARSOF. The TASOSC staff then plans and coordinates with the appropriate theater and TA organizations to ensure that all mission-essential requirements can be met.

Deliberate Mission Planning Process

Based on the SOC commander's MTP and other mission guidance, SF commanders conduct their own mission planning process. The objective of this process is to develop a comprehensive plan with contingency options that provide flexible execution. SF commanders must not tie themselves to a rigid

plan. They must anticipate the unexpected and remain agile enough to modify their plans as required to achieve their higher commanders' intent.

Deliberate SF targeting and mission planning require days or weeks to complete an adequate IPB and to prepare for commitment of an SF team. Team members must understand the political, social, economic, and military situation in the JSOA. They must know the ethnic groups, customs, taboos,

religions, and other essential data that could affect mission execution. The SF team can best achieve this level of area orientation through intensive area study before commitment.

Based on this planning process, SF group and battalion commanders provide their subordinate commanders with mission letters. These mission letters focus SF planning and training efforts before commitment. Appendixes E, F, and G provide sample SF mission letters.

MYTH: An SFOD can maintain proficiency in all SF missions.

FACT: An SF group can conduct all five SF missions simultaneously, but an SFOD must focus its training on no more than two SF missions at the same time. SF commanders must prioritize mission requirements and develop mission-essential task lists (METLs) that translate into realistic mission letters for their SFODs.

When the SOC receives an actual mission tasking, the SOC commander determines whether an existing SOMPF can be updated or modified to execute the mission. If no SOMPF exists for the mission, the SOC commander must begin the time-sensitive mission planning process. In either case, he issues an alert or execute order to the SF group commander and the appropriate supporting commanders (Figure 7-7a).

Based on the MTP or SOMPF he has been directed to execute, the SF group commander either retains the mission at group level or assigns the mission to a subordinate battalion commander for execution (Figure 7-7b). The appropriate commander then selects an SF team to plan and execute the mission.

Upon selection to execute a mission, the SF team is **committed**. It moves into an ISOFAC, receives its OPORD and mission briefing, and begins mission preparation (Figure 7-8). All SF OPLANs and OPORDs use the JOPS format to facilitate joint coordination of support requirements. In the mission briefing, the base commander and his staff provide the mission statement, the supported commander's intent, and sufficient information to allow the SF

team to complete its detailed mission planning. The SF team normally receives this information in an SOMPF before the mission briefing. Team members can then review the OPORD and SOMPF and prepare questions before the briefing.

At the end of the mission briefing, the ISOFAC commander and the AST NCOs provide the SF team with a proposed isolation schedule and a list of requirements already requested and/or provided for the team. These requirements may include—

- Ranges.
- Training facilities.
- Rehearsal sites.
- Updated intelligence products.
- Air items.
- Accompanying supplies.
- Items for emergency resupply.
- Mission-peculiar equipment.
- Isolation expendable available to supplement the team's isolation kit.

Based on the base commander's mission analysis, the SF team is given sufficient time to—

- Continue area studies.
- Receive operational intelligence briefings.
- Refine the POE based on the actual situation.
- Conduct any required specialized training.
- Request and receive specialized mission-peculiar equipment.
- Rehearse its activities.
- Resolve legal or policy issues concerning the mission.
- Commit the details of the mission to memory.
- Prepare a written OPORD.
- Prepare individual and team equipment for infiltration.

Given a complete SOMPF, a committed SF team needs at least 96 hours to do the tasks listed above (Figure 7-9). The team must refine the MICON based on the actual situation. It must then submit mission support requests to confirm or revise all support and sustainment requirements not already toploaded by the ISOFAC staff and AST NCOs. The AST NCOs facilitate the coordination that must occur to ensure team requirements are properly identified and met.

About halfway through mission preparation, the SF team commander provides the base commander

24-48 HOURS BEFORE SFOD ISOLATION

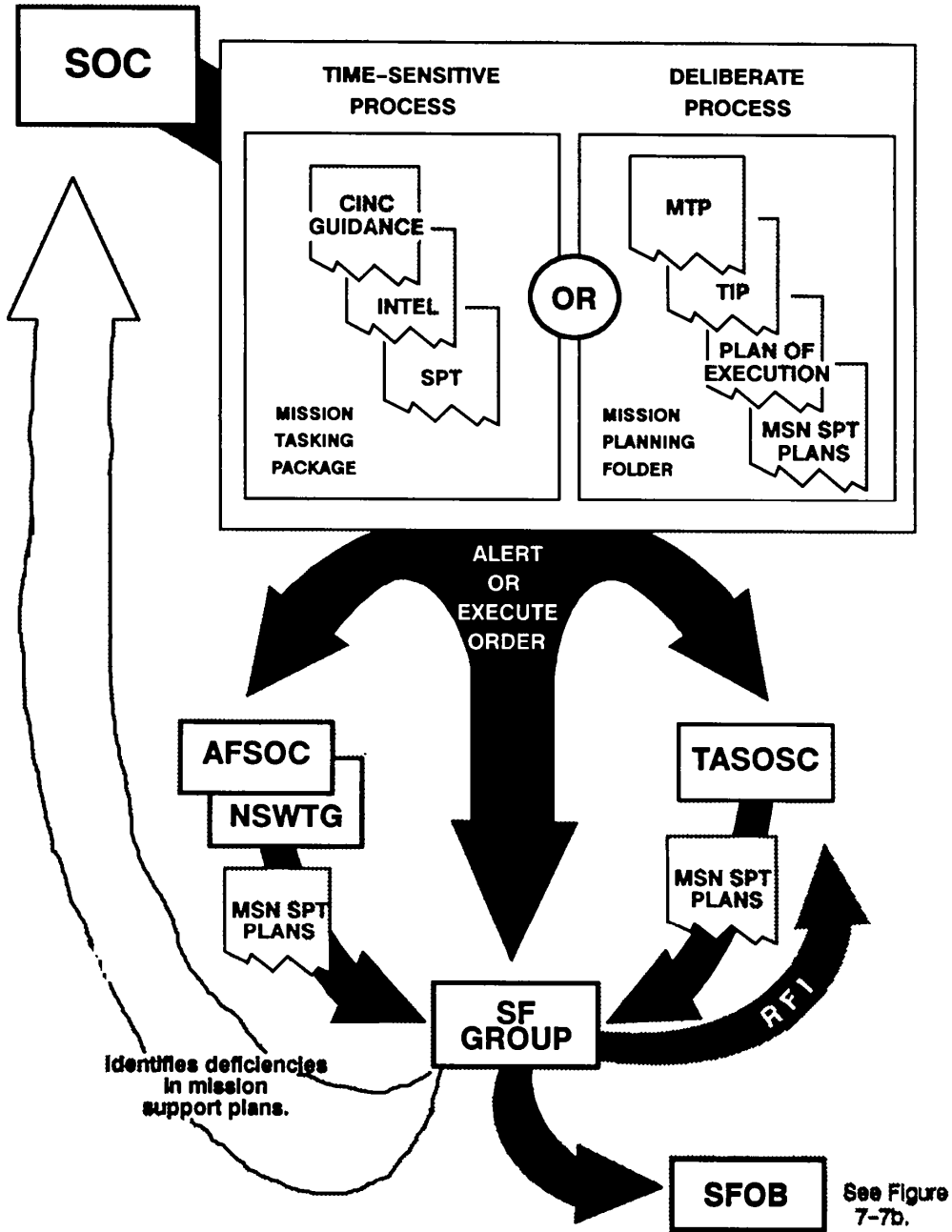

Figure 7-7a. SF Mission Planning Process.

96-120 HOURS OF SFOD ISOLATION

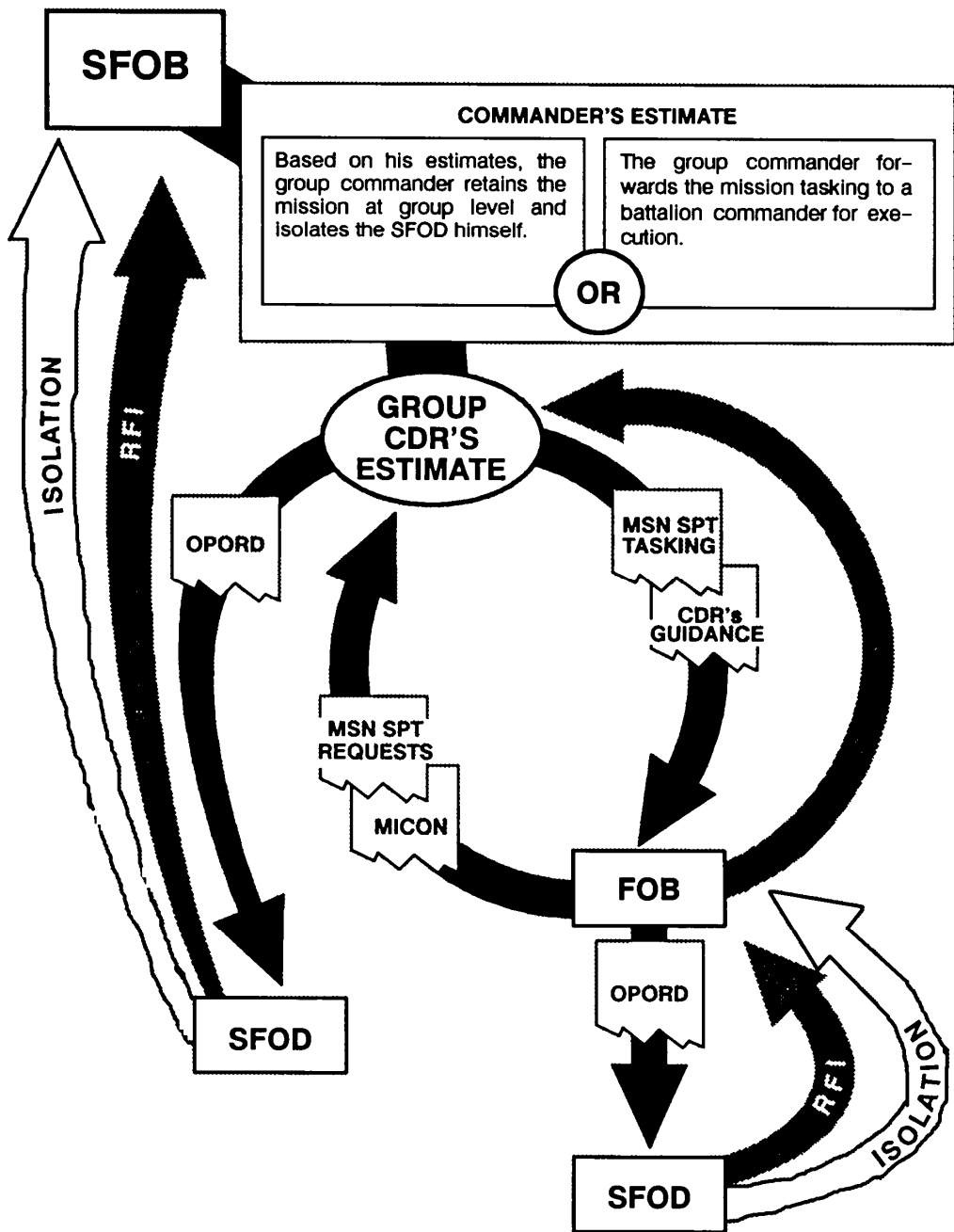

Figure 7-7b. SF Mission Planning Process.

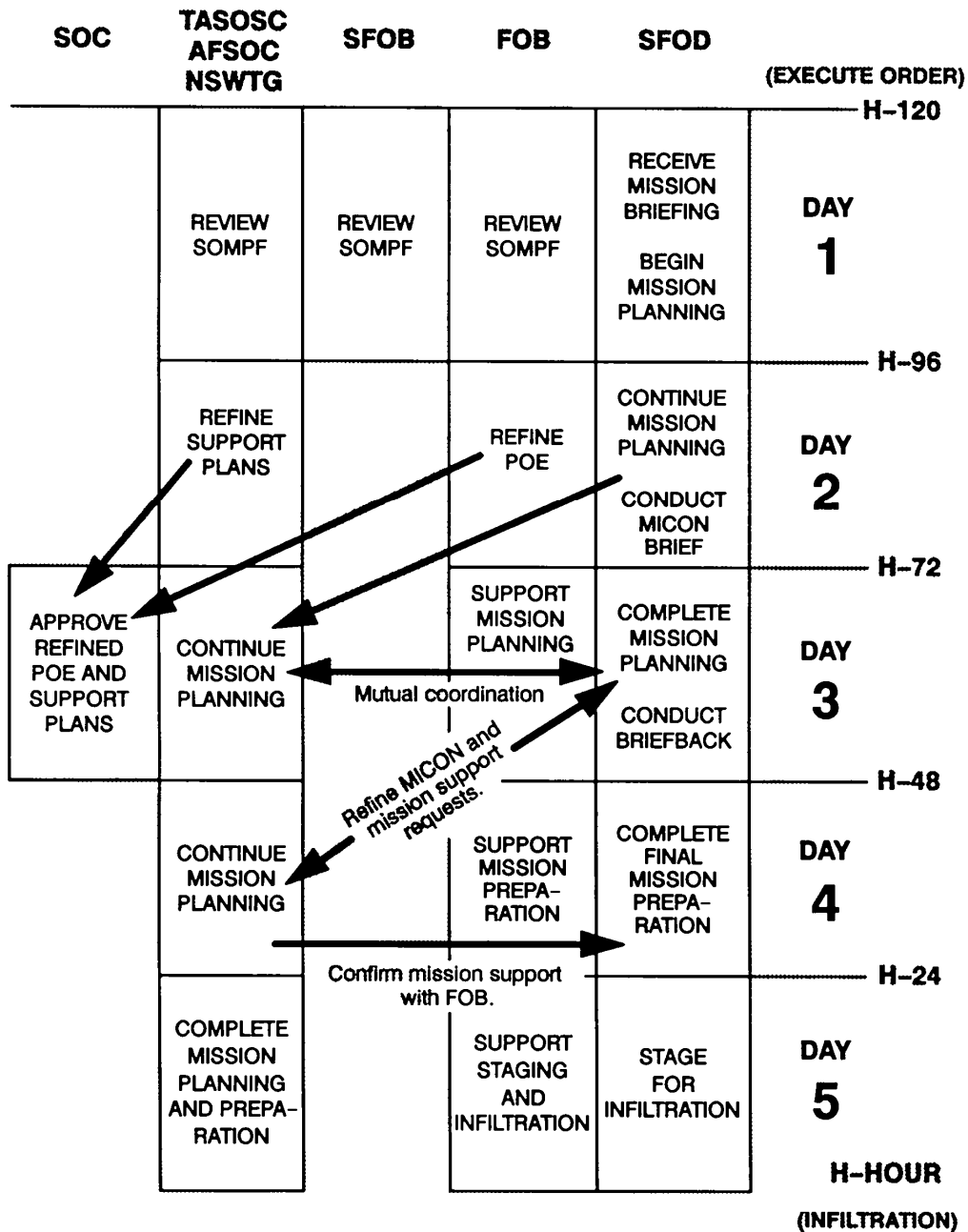

Figure 7-8. Sample SF Mission Planning Cycle (Deliberate Planning With Complete Mission Planning Folder).

SFOD ACTIVITIES

SUPPORT ACTIVITIES

(EXECUTE ORDER)

H-120

DAY 1

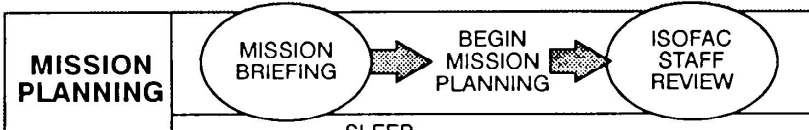

H-96

DAY 2

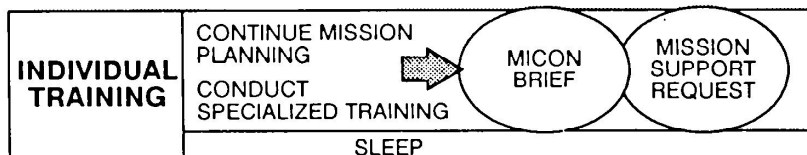

H-72

DAY 3

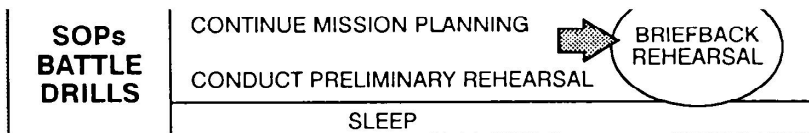

H-48

DAY 4

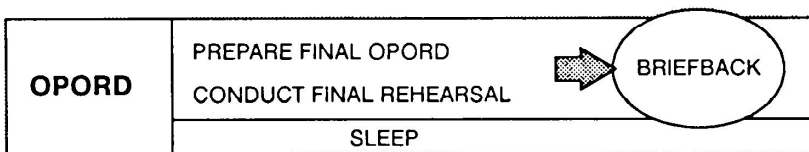

H-24

DAY 5

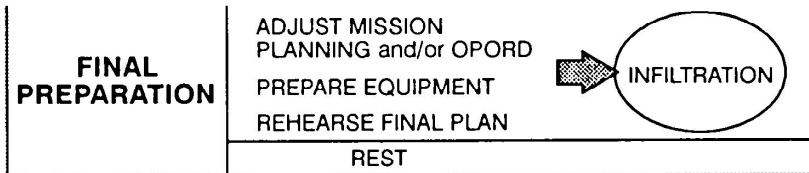

H-HOUR

(INFILTRATION)

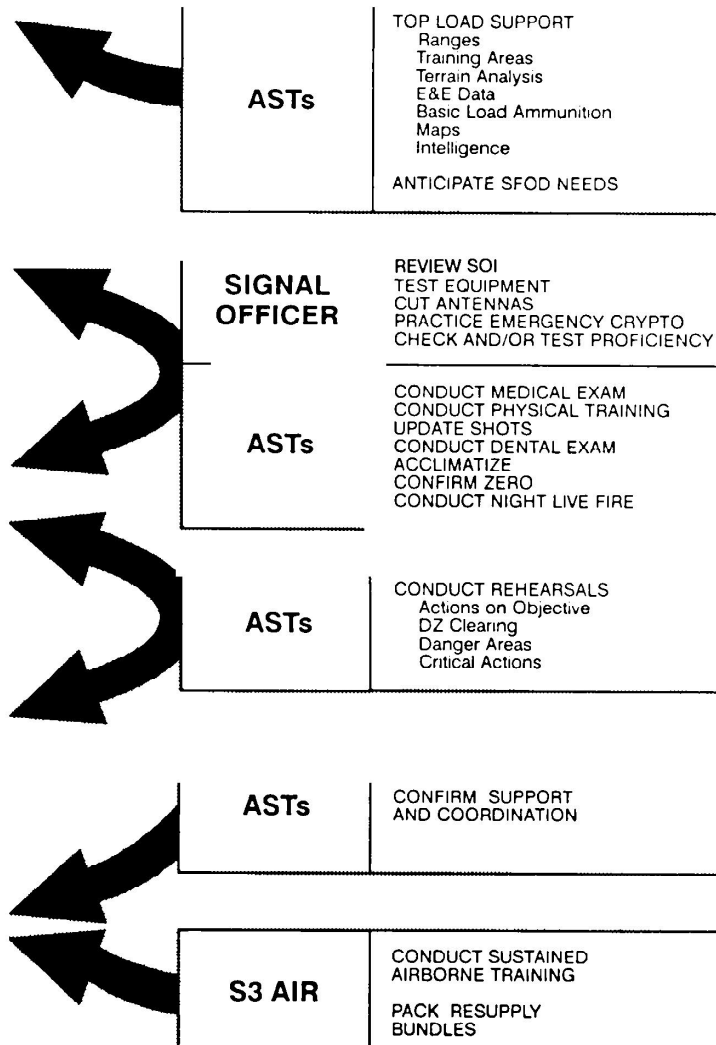

Figure 7-9. Minimum Requirements for Isolation Activities.

with a short and informal MICON brief to ensure his team's planning efforts meet the supported commander's intent. At the MICON brief, the SF commander presents employment options with a recommendation as to which option the base commander should approve.

When mission planning is completed, the SF team gives the base commander and his staff a mission briefback. Appendix H provides a briefback checklist. The mission briefback serves three functions. It—

- Ensures the team fully understands all aspects of the mission.
- Convinces the base commander that the SF team is ready to deploy and execute its mission.
- Allows the base commander and his staff to recommend changes to the plan if required.

Before the mission briefback, the base commander and his staff review the SF team's OPORD and

prepare appropriate questions and other briefback notes. During this review, the base commander and his staff ensure that air missions, operational project stocks, radio frequencies and all other support and sustainment requirements have been confirmed with the supporting organizations.

After the formal briefback, the base commander may conduct an unmarked map exercise to ensure that team members have committed to memory all pertinent mission information. He may also require a dress rehearsal of critical mission events.

After the mission briefback, the SF team needs time to modify its plan as directed and prepare its accompanying supplies and equipment for infiltration. It also needs at least 8 hours of uninterrupted rest between mission preparation and infiltration. When the base commander decides that the SF team is ready, he moves it to a staging area for subsequent infiltration.

Time-Sensitive Mission Planning Process

When preparing for an SF mission, time may be a critical factor. A time-sensitive mission may also impose time constraints on planning and other mission preparation, particularly if no SOMPF exists for the mission. Time is a significant factor because the success of the mission depends largely

on the quality of mission preparation. If there is not enough time for normal preparation, the SF base commander determines minimum essential preparation tasks. He then modifies the deliberate mission planning process to do those tasks in the time available (Figure 7-10). The SF base commander must inform the SOC or the JSOTF commander when he cannot accomplish these minimum essential tasks without an unacceptable degree of risk of mission failure.

Planning Considerations

The organization, training, and equipment of an SF team varies with the actual mission. The FOB or

SFOB commander must consider the following factors during initial mission planning:

- Mode of employment (for example, low visibility or clandestine).
- Method of infiltration, resupply, and exfiltration.

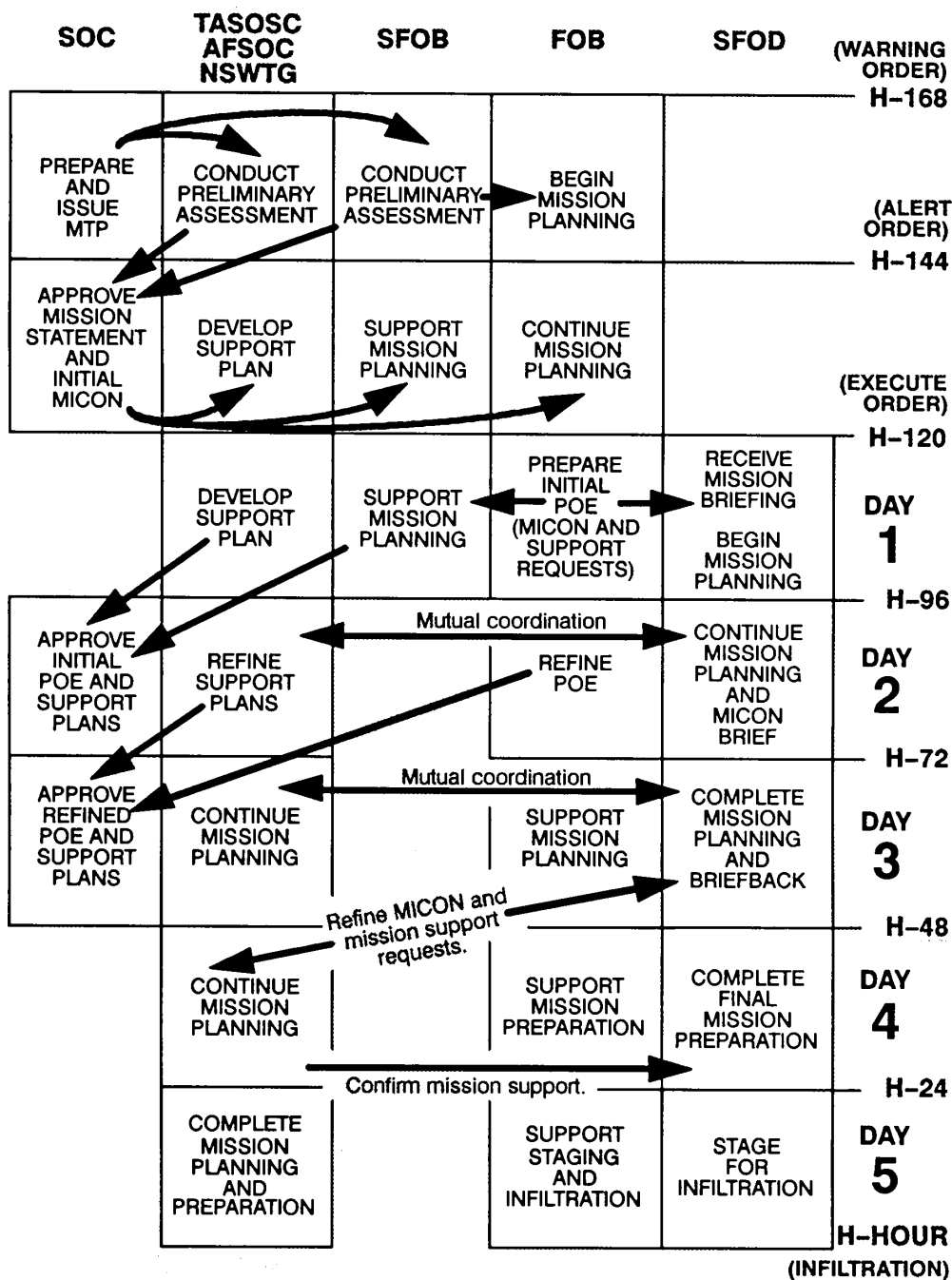

Figure 7-10. Sample SF Mission Planning Cycle (Time-Sensitive Planning Without Mission Planning Folder).

- Scope and duration of operation.
- Operational environment (permissive, semipermissive, or nonpermissive).
- Availability of indigenous support mechanisms.
- Communications requirements based upon the electronic threat, time sensitivity of transmission, and environmental conditions.
- Collection means (visual observation, photography, surreptitious entry, technical surveillance).
- Rules of engagement and other legal or policy considerations related to the mission.
- Cover (as required).

The use of foreign or commercial materiel, tactics, and techniques may permit the deployed SF team to pass a cursory visual inspection by a hostile observer, to avoid electronic identification, and to prevent identification by weapons signature. SF missions may require procurement and use of foreign or commercial—

- Weapons.
- Communications equipment.
- Clothing.
- Rations.

- Maps.
- Other specialized items.

Other specialized materiel requirements may include—

- SATCOM and other specialized communications equipment.
- Suppressed weapons.
- Specialized equipment for collecting information, such as telescopes, night vision devices, electronic surveillance and direction finding equipment, surreptitious entry devices, and remote sensor systems.
- Terminal guidance equipment, such as radar transponders and laser target designators.
- NBC defensive clothing or equipment.

The group commander must identify his contingency requirements for such equipment. He must coordinate with the TASOSC to procure sufficient quantities to properly train each SFOD in the equipment's use and repair before the SFOD is committed.

All equipment that could indicate the nature or operational area of the mission receives the same security classification as the mission itself.

Operations Security

OPSEC is a command responsibility. It must be an integral part of every SF mission, to include planning, training, preparation, and support activities.

The S3 provides staff supervision for OPSEC. OPSEC consists of signal security, physical security, and information security. All are interrelated; all must be considered simultaneously.

Signal security protects operational information by implementing communications security (for example, communications codes, secure voice equipment,

communications procedures) and electronics security (for example, radio silence and antenna positioning).

Physical security protects operational information or activity by using security forces, barriers, sensors, and secure containers to deny or limit access to facilities, areas, materiel, documents, or personnel.

Information security prevents disclosure of operational information by restricting access to or the release of written, verbal, graphic, or electronic information.

The commander must designate essential elements of friendly information (EEFI). He must then enforce appropriate OPSEC measures to protect those EEFI from threats identified in the CI vulnerability analysis.

Deception

Deception purposely misleads hostile decision makers by distorting, concealing, or falsifying indicators of friendly intentions, capabilities, or disposition. Deception is employed in concert with OPSEC to mask friendly activity.

The SF commander and his S3 must incorporate deception into every SF operation. They determine the deception objective, deception target, and deception story at the same time they develop their concept for the actual operation. The deception objective is the desired hostile activity-what the SF commander wants the hostile force to do. The deception target is the hostile commander who has the authority to direct that activity. The deception story is the perception of friendly activity that will cause the deception target to react as desired. For

example, the deception objective for an SF DA mission may be for a hostile commander to delay commitment of his reaction force until after the SF team has successfully withdrawn. The deception story might be that a feint conducted in a secondary sector by an indigenous resistance element under the control of another SF team is in fact the main attack.

The S3 and S2 OPSEC personnel determine what deception measures will portray friendly capabilities and intentions in such a way that the hostile commander will conclude that the deception story is true. Examples of deception measures include camouflage, smoke, ruses, feints, decoys, and demonstrations. Complete deception is not always necessary. It is often sufficient to create merely an element of doubt in the mind of the deception target, thereby delaying his reactions.

Psychological Impact

In addition to developing deception plans for each SF operation, SF commanders must consider the psychological impact of each SF operation. If the mission is to receive minimum publicity and operate with low visibility, SF commanders must assess the potential impact should the operation be exposed in a negative and sensational manner. If the negative

impact of failure outweighs the potential positive gain, the mission should be canceled. If the mission must still be conducted, a cover story should be developed to minimize embarrassment to key friendly personnel and countries. If an SF operation is designed to receive public recognition and openly project US interest and involvement in a country or situation, SF commanders and their PSYOP advisors must determine how best to portray the event. They must also determine what media means are capable of extracting maximum advantage without overplaying US involvement.

SF Teams in an NBC Environment

A critical factor in the mission planning process is the degree of NBC threat in the JSOA. The SF team

commander makes a risk assessment based on the level of NBC threat and his commander's planning guidance. During the risk assessment, the SF team commander weighs the danger posed by NBC attacks against the increased burden caused by the weight and bulk of the NBC gear to be carried. For example,

the weight of a protective mask may mean one less radio battery can be carried. The base NBC officer assists in considering such tradeoffs.

Deployed SF teams in remote and denied areas have the same NBC defensive requirements as conventional units. However, a number of factors greatly complicate their ability to survive and operate under NBC conditions. The physical and psychological effects of NBC weapons can be overcome, but only if SF commanders and soldiers plan for the NBC threat in their operational areas and adjust their training and operations accordingly. Deployed SF teams must modify conventional NBC defensive measures because they—

Do not have organic NBC defense specialists.

- Are not supported by NBC defense units.
- Have limited or no capability to replace contaminated clothing or equipment.
- Can only use man-portable NBC defensive equipment.
- May need to train and equip indigenous forces.
- Cannot easily retaliate in kind if targeted.

The principles of NBC defense are contamination avoidance, protection, and decontamination. Contamination avoidance is even more important for SF teams than it is for conventional units. Deployed SF teams and their indigenous forces are normally

foot-mobile and carry all essential equipment with them. Therefore, extended wear of chemical protective clothing is unacceptable in most circumstances.

SF teams operating with indigenous forces in denied areas in an NBC environment must ensure that NBC protective equipment is available to those forces. Possible sources of supply include battlefield capture of protective equipment, local manufacture of expedient protective equipment, and resupply from the SFOB or FOB. The SF teams must also train indigenous forces in the use of available NBC defensive equipment.

Deployed SF teams decontaminate to prevent casualties and enhance combat effectiveness. Their major concern is the decontamination of personnel and individual equipment. Decontamination means include the standard US individual decontamination kit, captured decontamination equipment, and locally sourced field-expedient decontaminants. Team personnel with specialized NBC training supervise decontamination and use NBC monitoring devices to ensure its completeness.

Evacuation of NBC (and other) casualties from denied areas may be impossible. SF medical sergeants must be trained to recognize the nature and severity of NBC injuries and to administer appropriate medical treatment within the operational area.

CHAPTER 8

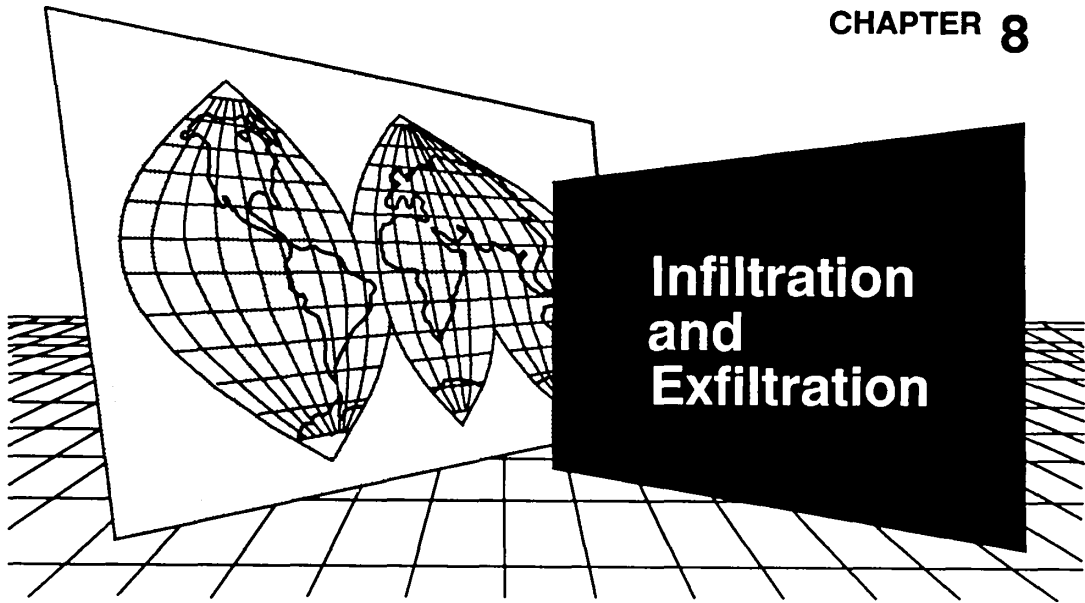

Infiltration and exfiltration planning is critical in SF operations. The sophisticated techniques and equipment available require detailed planning and coordination. This chapter discusses the basic considerations for air, water, and land infiltration and exfiltration. Although it discusses air, water, and land delivery separately, some missions may require a combination of means. (For detailed techniques and procedures, see TCs 31-19, 31-24, 31-25, and 57-1.) Mission planners should not feel constrained by the means mentioned in this chapter. SF teams can infiltrate or exfiltrate by any means—no matter how unorthodox—as long as it offers a reasonable chance of success.

MYTH: We can get you in, but we're not sure we can get you out.

FACT: SF teams are not expendable and do not stay in denied territory forever. SF operations pass through three stages during the employment phase—infiltration, mission execution, and exfiltration. Exfiltration must receive the same planning emphasis as infiltration.

Planning Considerations

Infiltration and exfiltration are almost always joint activities. SF does not perform its own air or water infiltration and exfiltration planning. Mission planners from the agencies providing the delivery or recovery means must be brought into the planning process as early as possible. Successful infiltration and exfiltration require—

- Timely, accurate, and detailed intelligence.
- Detailed mission planning and coordination.

- Flexible mission planning that addresses the unexpected.
- Adequate preparation, training, and rehearsals.
- OPSEC.
- Precise execution.

The FOB or SFOB commander considers the following factors when determining the most desirable method of infiltration or exfiltration for

a particular mission:

- Mission requirements, to include quantity and types of accompanying equipment and supplies.
- Hostile force capabilities.
- Terrain, weather, hydrography, and light data.
- Distance to the objective area.
- SF team capabilities.
- Capabilities of available delivery or recovery means.

Air Infiltration

Air infiltration is the most rapid means of clandestine infiltration. Techniques include static-line or

free-fall parachute entry and air-land operations by fixed-wing or rotary-wing aircraft. Rappel, fastrope, and hoist operations are also techniques for air infiltration. See Figure 8-1 for the advantages and disadvantages of air infiltration.

ADVANTAGES

- Flexibility
- Speed and Accuracy of Delivery
- Short Exposure to Hostile Countermeasures
- Precise Navigation
- Capability of Delivering Supplies in Excess of Individual Loads

DISADVANTAGES

- Vulnerability to Hostile Air Detection and Defense Systems
- Adverse Weather Conditions
- Injury to Personnel
- Damage or Loss of Equipment
- Need for Specially Trained Aircrews
- Need for Sterilization of Infiltration Site

Figure 8-1. Advantages and Disadvantages of Air Infiltration.

Water Infiltration

Up to the point of debarkation, water infiltration is the most secure and economical means of clandestine penetration. SF water infiltration means include—

- Water landing by freed-wing amphibious aircraft or properly prepared helicopters.
- Free drop from hovering helicopters.

- Surface and subsurface swimming.
- Small boats.

SF teams use various combinations of these delivery means and techniques to create deception, to increase the range of the mission, or to decrease the time required for transit. Naval aircraft, surface craft, and submarines may serve as intermediate delivery vehicles to support water infiltration. SF may also use inland waterways (canals, lakes, rivers) in conjunction with land infiltration. See Figure 8-2 for the advantages and disadvantages of water infiltration.

ADVANTAGES

- Long-Range Delivery Capability
- Relative Freedom from Weather Considerations Up to the Point of Debarkation
- En Route Operational Briefings, Rehearsals, and Intelligence Updates
- Surface Craft Transport of Large Quantities of Accompanying Supplies and Equipment

DISADVANTAGES

- Time Required for Unloading and Transhipment From Offshore Drop-Off Points
- Vulnerability of Landing Operations to Hostile Shore Defenses
- Loss of Personnel and Supplies During Ship-to-Shore Movement
- Limited Cargo Capacity of Submarines
- Need for Special Training
- Need for Additional Packaging to Waterproof Equipment
- Effects of Sea and Surf Conditions Resulting From High Winds

Figure 8-2. Advantages and Disadvantages of Water Infiltration.

Land Infiltration

Land infiltration in wartime is usually the least desirable means of clandestine penetration. SF teams

infiltrate on foot or by land vehicle when the hostile situation, geographic characteristics, or climate conditions prevent air or water infiltration. Overland movement in wartime is best done under conditions of limited visibility and over difficult terrain. It has

the greatest chance for success when hostile lines are overextended, the combat zone is fluid, or portions of the country's borders are inadequately secured. On the other hand, a well-organized defense may prohibit land infiltration. See Figure 8-3 for advantages and disadvantages of land infiltration.

In conflict situations short of war, land infiltration may offer less risk and greater mission security than air infiltration. Personnel with appropriate cover, language skills, and cultural training can infiltrate by rail, vehicle, or commercial air for legitimate appearing business or personal reasons.

ADVANTAGES

- Minimum Logistical Support
- Concurrent Area Familiarization and Intelligence Collection
- Flexibility of Movement and Timing
- Minimum Interservice Coordination

DISADVANTAGES

- Time Required
- Increased Vulnerability to Enemy Detection and Interdiction
- Limited Capability for Carrying Supplies and Equipment

Figure 8-3. Advantages and Disadvantages of Land Infiltration.

En Route Evasion and Escape Plan

The SF team commander and the delivery or recovery vehicle commander are jointly responsible for developing an en route E&E plan. The plan must enhance the survivability of the SF team and crew members after emergency evacuation of the aircraft or vessel. Each mission presents its own peculiar problems. Commanders should develop their plan according to where the emergency occurs. If it occurs—

- In friendly territory, the planning focus is on maintaining mission OPSEC.

- In denied territory, the planning focus is on returning to friendly control.
- In proximity to the objective area, the planning focus is on permitting the SF team to continue its mission if it has a reasonable chance of success.

The plan must address C2 during evasion. The SF team commander determines whether he can continue the mission. If he can continue the mission, he assumes command of all survivors, regardless of rank, and senior aircrew members consider themselves under his control for assisted E&E. If the SF team cannot continue the mission, then the senior ranking survivor assumes command for unassisted E&E. If the senior ranking survivor is an aircrew member, he should rely on the SF team commander for E&E advice and assistance.

Exfiltration

The planning considerations, preparations, tactics, and techniques for exfiltration are similar to those used for infiltration. However, several unique recovery means must be considered:

- Fulton recovery system (MC-130).
- STABO and similar rotary-wing personnel extraction systems.
- Helicopter rescue hoist.
- Assisted E&E.

When SF operations are conducted deep in hostile or denied areas, the distance to the JSOA normally precludes an all-land exfiltration. The initial phase of the exfiltration will normally be by land, terminating in an air or water recovery. Aircraft, surface craft, submarines, or various combinations of these three means can be used for the recovery of—

- Seriously ill or wounded SF personnel.
- SF teams following mission completion or abort.
- SF teams under direct hostile pressure.

Stay-Behind Operations

As an alternative to infiltration, stay-behind operations involve the pre-positioning of SF teams within their proposed JSOA before hostile forces overrun or occupy the area. (See TC 31-29 for a detailed discussion of stay-behind operations.)

These operations—

- Permit the SF teams to organize and train the resistance cadre or to prepare for unilateral SF operations.
- Require less external support because caching is possible.
- Are highly vulnerable to compromise before hostilities begin.

CHAPTER 9

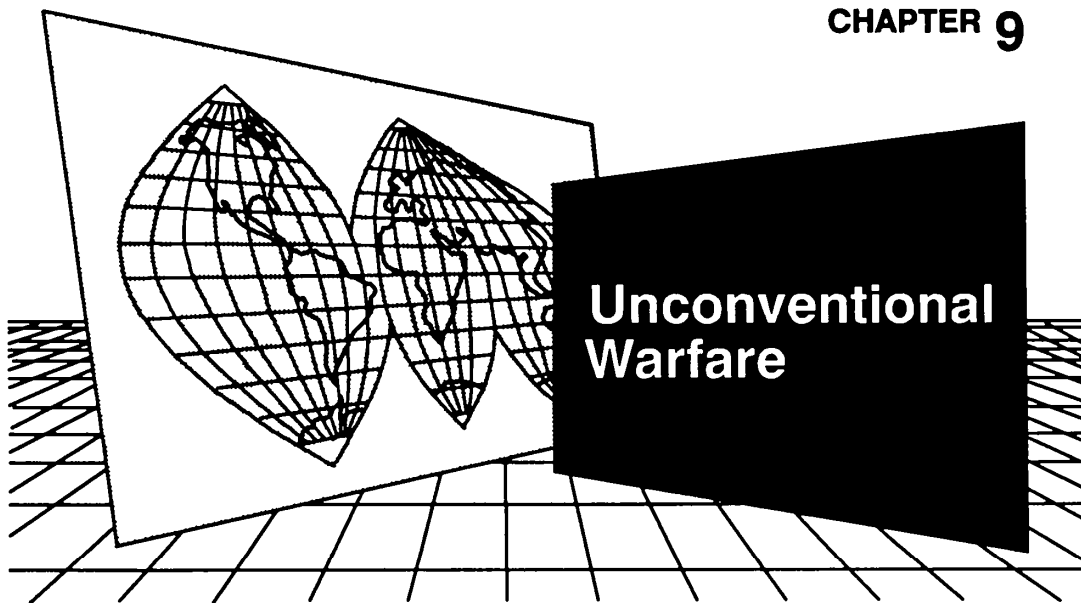

UW is the most challenging of all SF missions because it involves protracted operations with indigenous forces in denied territory. Building rapport with and adapting to the ways of an indigenous resistance organization require carefully planned and carefully executed actions. This chapter focuses on the doctrinal considerations for planning and executing such actions.

Resistance and Insurgency

A government's inability or unwillingness to meet the legitimate needs of its people may result in popular frustration and dissatisfaction. People may lose their faith and confidence because the government lacks legitimacy. They may also simply recognize that the government is incapable of effectively providing internal security and development. (See JCS Pub 3-07 and FM 100-20 for detailed discussions of the nature of insurgency.) The following factors are important in explaining

why people resist their established government or an occupying power:

- The people's attitudes concerning the conditions.
- The nation's political and cultural traditions, to include its experience with political violence.
- The degree of political participation by the populace.

Resistance may be either nonviolent or violent. Nonviolent resistance involves acts such as ostracism, tax evasion, boycotts, strikes, or civil disobedience. Violent resistance includes sabotage, terrorism, and guerrilla warfare. People usually resist nonviolently at first. However, they may willingly take up violent

resistance if a subversive cadre provides them a cause they perceive to be both worthy and achievable.

If the sociopolitical conditions are oppressive enough, resistance may develop into an organized resistance movement. A resistance movement is an organized effort by some portion of the civil population of a country to oppose or overthrow the established government or cause the withdrawal of an occupying power. The center of gravity in any resistance movement is the people's will to resist. The people bear the brunt of the established authority's retaliatory measures. While armed resistance may be LIC from the US perspective, it is total war for those who take up arms. Defeat means death or a life in exile.

An insurgency is an organized resistance movement that uses subversion and armed conflict to achieve its aims. The central issues in an insurgency are control and legitimacy. An insurgency is a protracted politico-military struggle designed to weaken government control and legitimacy while increasing insurgent control and legitimacy.

Each insurgency has its own unique characteristics based on its strategic objectives, its operational environment, and available resources. Revolutionary

insurgences seek to overthrow the existing social order and reallocate power within the country. Other insurgences seek to—

- Overthrow an established government without a follow-on social revolution.
- Establish an autonomous national territory within the borders of a state.
- Cause the withdrawal of an occupying power.
- Extract political concessions that are unobtainable through less violent means.

An insurgency often results from a government's unwillingness or inability to address social ills or the grievances of its people. However, an effective insurgent cadre with sufficient external support can mobilize causes as it does people and material resources. Few countries are stable and progressive enough to withstand a concerted effort directed against its most vulnerable weaknesses.

A resistance movement may also oppose an established government or occupying power within the context of a limited or general war. In this situation, conventional military power will usually be the decisive factor. UW operational objectives contribute to overall strategic success by supporting and complementing conventional military operations.

Three Phases of an Insurgency

A successful insurgency generally passes through three phases. These phases often overlap. An insurgency may move back and forth from one phase to another in response to the counterinsurgent effort made against it. Nevertheless, it is useful to view an insurgency in terms of these phases.

Phase I

Phase I, latent or incipient insurgency, is the phase in which the resistance leadership develops the

resistance movement into an effective clandestine organization. The resistance organization employs a variety of subversive techniques to prepare the population psychologically to resist. These techniques may include propaganda, demonstrations, boycotts, and sabotage. Subversive activities frequently occur in an organized pattern, but there is no major outbreak of armed violence. In the advanced stages of this phase, the resistance organization may establish a shadow government that parallels the established authority. During this phase, the resistance leadership (Figure 9-1)—

- Recruits, organizes, and trains cadres.
- Infiltrates key government organizations and civil groups.

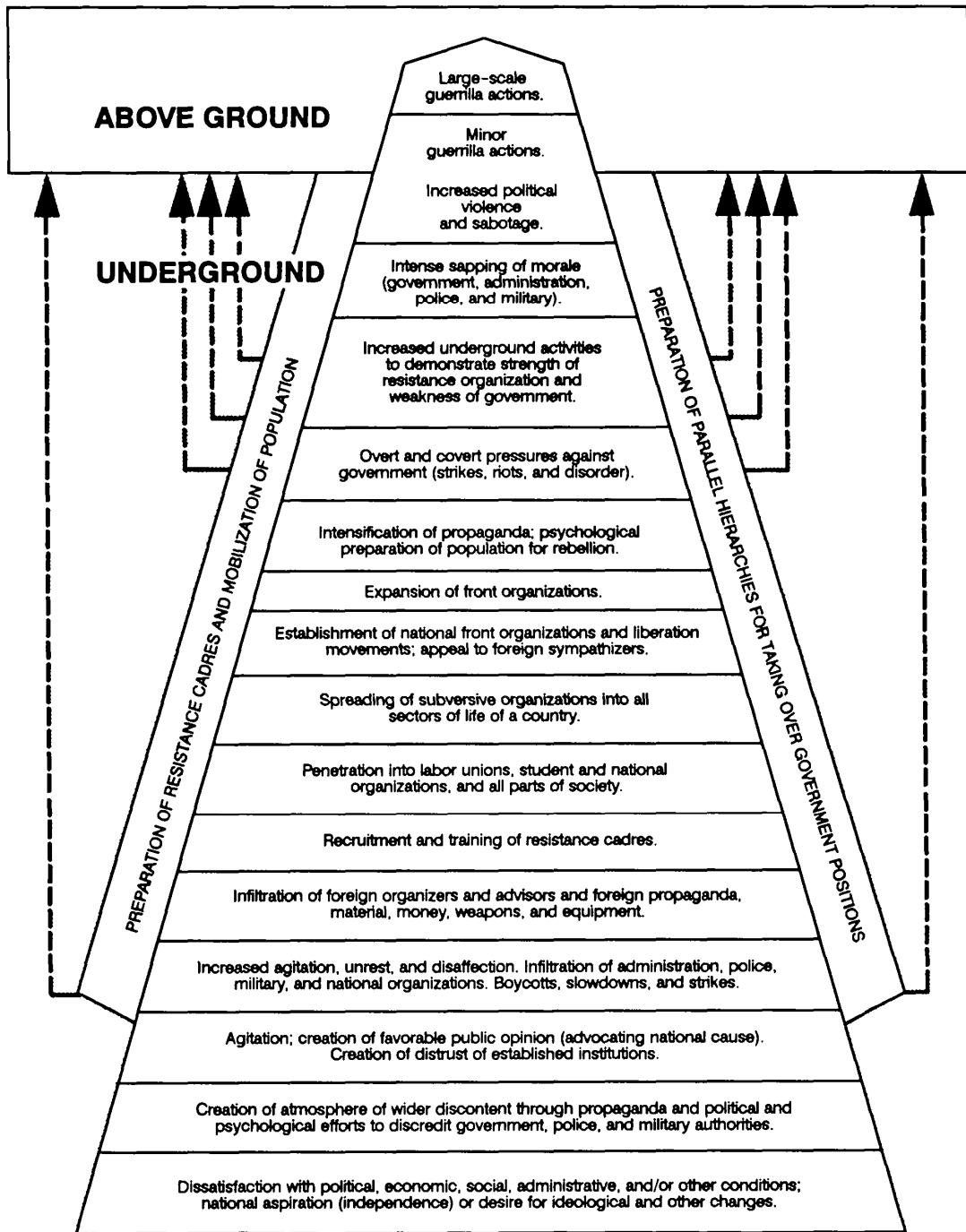

Figure 9-1. The Building of a Resistance Movement.

- Establishes cellular intelligence, operational, and support networks.
- Organizes or develops cooperative relationships with legitimate political action groups, youth groups, trade unions, and other front organizations to develop popular support for later political and military activities.
- Solicits and otherwise obtains funds.
- Develops sources of external support.

Phase II

Phase II, guerrilla warfare, begins with overt guerrilla activity. The guerrillas in a rural-based insurgency normally operate from relatively secure base areas in an insurgent-controlled territory. In an urban-based insurgency, the guerrillas operate clandestinely using a cellular organization to maintain OPSEC. In either situation, subversive activities continue. Clandestine radio broadcasts, newspapers, and pamphlets openly challenge the control and legitimacy of established authority. Recruiting efforts expand as the people lose faith in the established authority and decide to actively resist it.

Phase III

Phase III, mobile warfare or war of movement, begins with the transition from GW to conventional military operations. If successful, this phase brings about the final collapse of the established government or the withdrawal of the occupying power. Without direct intervention, a Phase III insurgency takes on the characteristics of a civil war. The resistance organization may achieve legal belligerent status. The resistance leadership becomes responsible for the population, resources and territory under its control. Specific actions include establishing an effective civil administration, providing balanced social and economic development, mobilizing the population to support the resistance organization, and protecting the population from hostile actions. In a limited or general war, conventional military forces may link up with the resistance organization and conduct the war of movement. In either case, Phase I and II activities continue and expand. If Phase III succeeds, the resistance organization begins posthostility consolidation activities. If it fails, the resistance organization reverts to Phase II or even Phase I.

Resistance Organization

Armed resistance requires an organization to be effective. A resistance organization includes both operational and support elements. The operational elements of a resistance organization belong to the guerrilla force and the underground. The auxiliary is the clandestine support element.

The **guerrilla force** is the overt military or paramilitary arm of the resistance organization. The guerrilla force conducts low-visibility combat operations. It is normally rural-based. Its members may be full-time or part-time.

The **underground** is a cellular organization that conducts clandestine subversion, sabotage, E&E, and intelligence collection activities. It may be rural-

urban-based and has its own clandestine support organization. This support organization can be urban or rural.

The **auxiliary** is the clandestine support element of the guerrilla force. Like the underground, the auxiliary is a cellular organization and can be rural- or urban-based. Auxiliary functions include—

- Security and early warning.
- Intelligence collection.
- Counterintelligence.
- Recruitment of new personnel.
- Air or maritime reception support.
- Communications.
- Psychological operations.
- Populace and resources control.
- Support of evasion and escape mechanisms.
- Internal logistical and medical support.
- Fund raising.

Classic UW doctrine distinguishes between a guerrilla force and an underground. However, classic rural insurgency is no longer the norm for contemporary political violence. There may be no

clear distinction between a guerrilla force and an underground. Some modern insurgences, like the Tupomaros in Uruguay and the Monteneros in Argentina, operated only in urban areas.

Seven Phases of US-Sponsored UW

The United States cannot afford to ignore the resistance potential that exists in the territories of its potential enemies. In a conflict situation or during war, SF can develop this potential into an organized resistance movement capable of significantly advancing US interests. The strategic politico-military objective of wartime UW is normally to influence conventional military operations. In conflict, however, the objectives may range from interdicting foreign intervention in another country, to opposing the consolidation of a new hostile regime, to actually overthrowing such a regime.

In a wartime resistance movement directed against an occupying power, the critical-cell strategy (see Chapter 2) may be appropriate. Little political organization is needed if the occupying power has not yet consolidated its gains and has mistreated or alienated the civilian populace. However, the critical-cell strategy has little chance of success against an indigenous communist government that has consolidated its power. The mass-oriented strategy is more likely to succeed against such an established government, but only if the resistance organization offers the population a credible alternative to communist rule.

When directed, SF supports selected resistance organizations that enhance US national interests. In wartime, SF teams infiltrate hostile areas to organize, train, equip, and advise or direct an indigenous resistance organization. In conflict situations where direct US military involvement is inappropriate, SF teams may instead provide indirect support from an external location.

Although each resistance movement is unique, the US sponsorship of a resistance organization generally passes through seven phases. These seven phases may not occur sequentially or receive the same degree of emphasis. They may occur concurrently or not at all, depending on the specific situation. For example, SF support to a large and effective resistance organization may be limited to providing logistical support. Nevertheless, describing UW in terms of the seven phases improves understanding of the mission. See Figure 9-2.

Psychological Preparation

The US government begins PSYOP as far in advance as possible. PSYOP prepare the resistance organization and the civil population of a potential UW operational area to accept US sponsorship and the subsequent assistance of SF teams. The US government may accomplish this psychological preparation through radio broadcasts, underground propaganda, or the insertion of US-sponsored clandestine resistance organizers. The population of a recently occupied country may already be prepared to accept US sponsorship, particularly if the country was a US friend orally before its occupation. In other cases, psychological preparation may be more difficult. Normal peacetime contacts between SF and indigenous elements contribute to the psychological preparation of allied and friendly populations.

Initial Contact

Other agencies of the US government normally establish contact with a resistance organization before an SF team infiltrates into the operational area to conduct UW. Contact is important to assess resistance potential in the operational area and the compatibility of US and resistance interests and

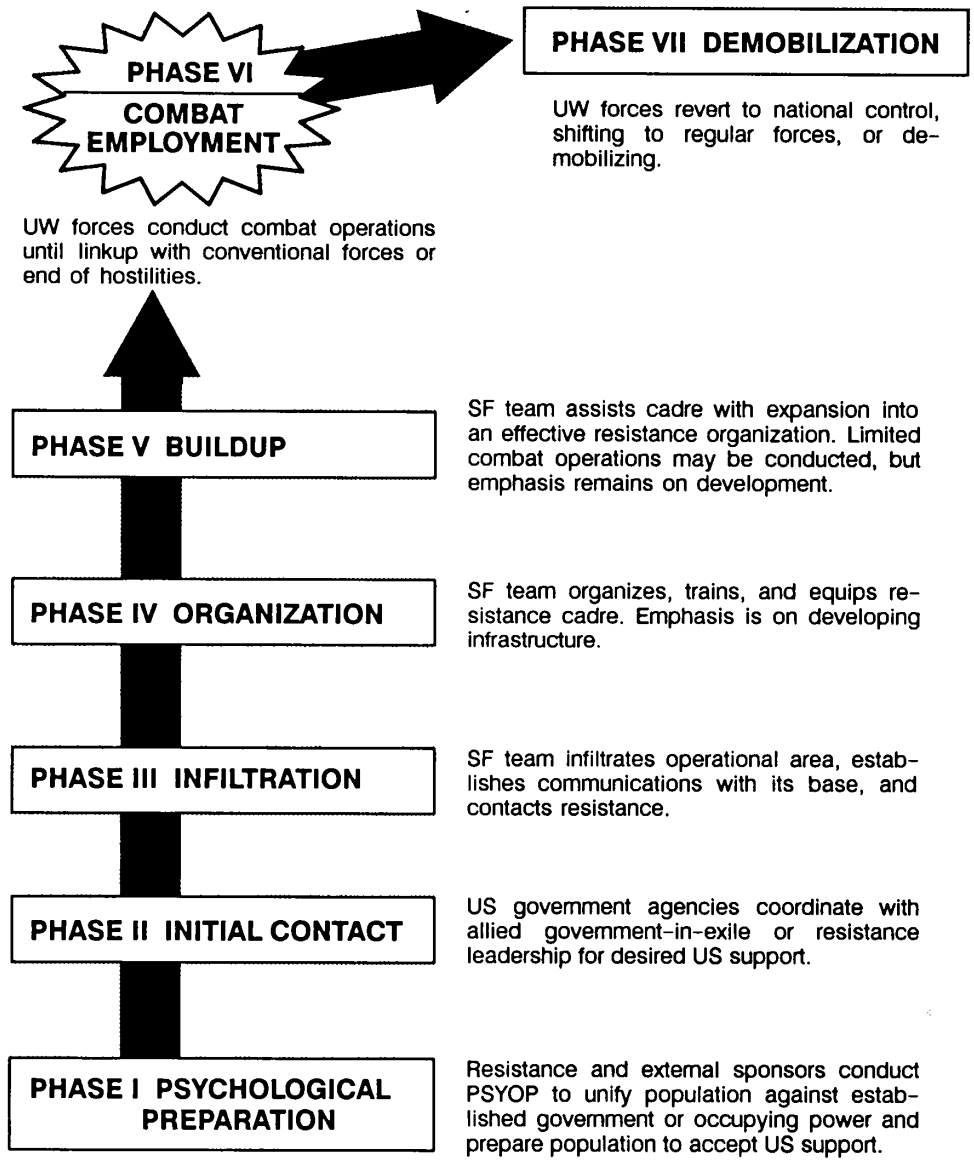

Figure 9-2. Seven Phases of US-Sponsored UW.

objectives. During the initial contact, arrangements are made for the reception and initial assistance of the SF team. If possible, the SOC

should arrange to exfiltrate a resistance leader from the operational area to brief the SF team in the ISOFAAC and accompany it during infiltration. This

person is known as an **asset**. The lack of an asset does not prevent infiltration of an assessment team to make the initial contact and assess the situation in the potential operational area.

Infiltration

During this phase, an SF team, with its accompanying supplies, clandestinely infiltrates into the JSOA. The team makes contact with the resistance organization, establishes initial communications with the FOB, and moves to the guerrilla base or another secure location. Immediately upon infiltration, the SF team begins a continuous area assessment to confirm or refute information received before infiltration.

Organization

The SF team begins to establish rapport with the resistance leadership by showing an understanding of, confidence in, and concern for the resistance organization and its cause. The SF team explains its capabilities and limitations and begins to assist the resistance leadership with the development of the resistance organization. The SF team must then prove its value in actual operations. Building rapport is a difficult and complicated process based on mutual trust, confidence, and understanding. It is not accomplished overnight. (See page 9-11, SF-Resistance Relationships.)

Before a resistance organization can successfully engage in combat operations, the resistance leadership must organize an infrastructure that can sustain itself in combat and withstand the anticipated hostile reaction to armed resistance. During the organization phase, the resistance leadership develops a resistance cadre to serve as the organizational nucleus during the buildup phase. The SF team assists the resistance leadership in conducting a cadre training program to prepare for the eventual buildup of the resistance organization.

The resistance leader and SF team commander must agree upon C2 arrangements. SF team members normally advise and assist counterpart resistance leaders. In some situations SF team members may actually direct some resistance activities.

The specifics of resistance organization depend on local conditions. UW requires centralized direction and decentralized execution under conditions that

place great demands on the resistance organization and its leadership. Armed rebellion inherently creates an ambiguous and unstructured environment. No two resistance organizations need the same degree or level of organization. The SF team commander should consider the following factors when advising the resistance leadership concerning organization:

- Effectiveness of existing resistance organization.
- Extent of cooperation between the resistance organization and the local population.
- Hostile activity and security measures.
- Political boundaries, natural terrain features, potential targets, population density, and other characteristics of the JSOA.
- Religious, ethnic, political, and ideological differences among elements of the population and competing resistance organizations.
- Proposed type and scope of combat operations.
- Degree of US influence with the resistance organization.

The C2 structure of the resistance organization must provide unity of effort. An **area command** is a combined (indigenous and SF) C2 structure that directs, controls, integrates, and supports all resistance activities in the operational area. The area commander is the indigenous resistance leader. The size and composition of the area command vary with the considerations listed above. The area command is compartmented but should include representatives from each resistance element. The SF team commander serves as an advisor to the area command. A large area command may establish subordinate regional, district, or sector commands to provide a mechanism for centralized planning and decentralized execution. See Figure 9-3 for an example of a highly structured resistance organization reporting to a national government-in-exile. There may not be such a political structure in existence. There may instead be a shadow government in the country itself, or the political basis for the resistance movement may be a loose confederation of tribal or national groups within the country.

An area command establishes an area complex to support resistance activities. The area complex is a clandestine, dispersed, and flexible network of facilities. It usually includes security, intelligence, and CI systems; communication systems; reception

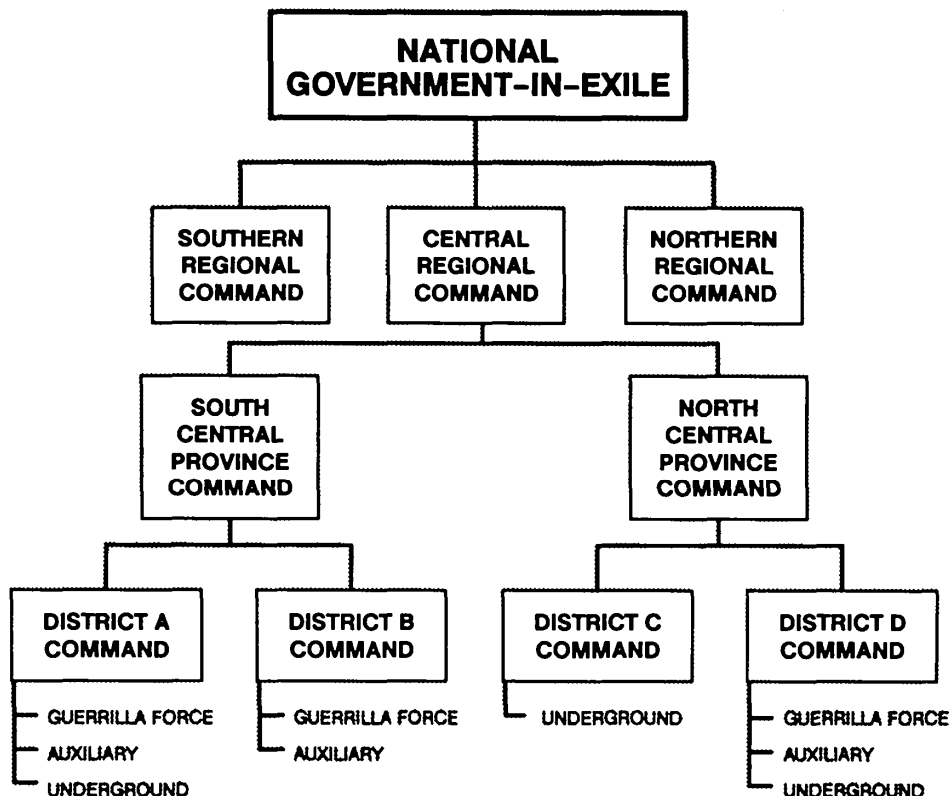

Figure 9-3. A Type Resistance Organization.

sites; logistical and medical facilities; training areas; guerrilla bases; and mission support sites (MSSs).

A guerrilla base is a temporary installation located in remote or resistance-controlled territory to support the guerrilla force. A base can be large or small, elaborate or simple. Bases are usually scattered, inconspicuous, and well-hidden in inaccessible terrain. Clandestine LOC link the guerrilla bases to each other and to their support. Despite any impression of permanence, guerrilla bases must have at least one good escape route and an alternate location to use when hostile forces threaten the primary base. Guerrilla bases must also have early warning and defense mechanisms to prevent hostile forces from surprising them and to

provide opportunities for the guerrillas to execute their escape plan.

An MSS is a relatively secure site that extends the operational radius of the guerrilla force. The guerrilla force occupies an MSS, seldom for longer than 24 hours, before or after an operation. The guerrilla force uses it to prepare for or recover from combat operations. When possible, the guerrilla force keeps the MSS under surveillance at least 24 hours before and after use.

The organization of the guerrilla force cannot be fixed according to standard, conventional TOEs. Guerrilla force missions and tactics dictate a simple, mobile, and flexible organization capable of rapid dispersion and consolidation in response to the

tactical situation. Each unit must be self-contained, with its own intelligence, communications, and logistical systems.

Guerrilla organization normally determines auxiliary organization. All auxiliary functions should be compartmented from each other and from the guerrilla force the auxiliary supports.

Buildup

During the buildup phase, the resistance cadre expands into an effective organization capable of successful combat employment. The resistance cadre recruits and trains new members. It organizes and equips new nets and guerrilla units. OPSEC is particularly important because the influx of new recruits greatly increases the likelihood of compromise.

The resistance organization may conduct limited offensive combat operations to gain confidence and confuse or harass the hostile power. However, the emphasis remains on developing the resistance infrastructure to support future operations. The SF team assists with intelligence collection and tary analysis. It also advises and assists with resistance logistics activities.

The resistance organization should not expand beyond the point of effectiveness or for the sake of sheer numbers. The SF team commander must monitor resistance recruiting to ensure that the resistance organization is not using SF support to prepare for a posthostilities conflict that is not in the US interest. He must carefully balance the competing demands of size and effectiveness against his mission requirements.

Combat Employment

During this phase, the resistance organization initiates combat operations to achieve its strategic politico-military objectives. The resistance organization synchronizes these combat operations with PSYOP and subversive activities for maximum effect. Resistance forces may conduct more conventional military operations as the situation permits, or they may revert to the buildup phase if the hostile reaction warrants this withdrawal. The SF team commander ensures that resistance activities continue to support the objectives of the

US unified commander, but he must recognize that resistance objectives will rarely be identical to those of the United States.

Interdiction is the basic UW combat activity. Interdiction operations drain the hostile power's morale and resources, disrupt its administration, and maintain the civilian population's morale and will to resist. By repeatedly attacking multiple and widely dispersed targets, the resistance organization confuses, frustrates, and demoralizes hostile forces. Such attacks force the hostile power to divide its reaction and reinforcement capabilities.

The resistance organization should not attack targets indiscriminately. Each target should contribute to destroying or neutralizing an entire target system. Interdiction is based on the assigned mission which directs, as a minimum, the results desired and the priorities for attack. Based on this mission, the area commander selects the specific target systems in his operational area. Major target systems vulnerable to UW interdiction operations include railway, highway, waterway, airway, communication, power, water supply, fuel supply, and air defense systems. (See TC 31-29 for a detailed discussion on target systems.)

The resistance organization's principal means of interdiction are raids, ambushes, and mining and sniping operations. Resistance forces can use mining and sniping alone to interdict LOC and hinder hostile repair efforts after a successful raid or ambush. Mining and sniping can also support raids and ambushes by—

- Preventing the escape of hostile troops from the objective area.
- Covering the friendly force's withdrawal.
- Delaying hostile reaction and reinforcement efforts.

In addition to combat operations, the resistance organization continues to collect, process, and disseminate intelligence. Accurate, timely intelligence is essential. Before each combat operation, the resistance organization supplements its normal intelligence activities with an intensive effort to collect detailed information on the specific target and the objective area. This effort includes continuous surveillance of the objective area without alerting the hostile power of friendly intentions.

The resistance organization's intelligence system may also respond to external taskings from the

government-in-exile and/or the theater CINC. When the SF team receives an intelligence collection mission, it may request that the resistance intelligence system execute the mission. If security or policy considerations preclude resistance participation, the SF team conducts the mission unilaterally.

If the theater CINC initiates conventional military operations in the operational area, the SF team commander closely coordinates resistance activities to complement and support those operations. Examples of this coordination include—

- Integrating resistance combat operations into the theater campaign plan.
- Coordinating resistance target acquisition and terminal guidance missions in support of theater interdiction operations.
- Ensuring resistance intelligence collection efforts support the theater intelligence collection plan.
- Ensuring resistance E&E, sabotage, and subversive activities further the objectives of both the resistance organization and the theater CINC.

Depending on its stage of development, the SF-supported resistance organization may be able to perform the following combat missions to support conventional military operations

- Conduct deception and economy of force operations to allow the conventional commander to concentrate his combat power elsewhere.
- Attack hostile air defense and deep attack weapon systems to support the conventional commander's fire suppression plan.
- Interdict or block approach routes or exit routes from an objective area.
- Occupy and hold key terrain features or facilities for a limited time to support the conventional force's scheme of maneuver.
- Seize and hold key installations (for example, bridges, tunnels, dams, and power and communications facilities) for a limited time to prevent their destruction by hostile forces.
- Harass and interdict hostile command and control, logistical, and reserve elements as part of the conventional commander's deep operations.
- Divert hostile attention and resources from the main battle area.

If conventional forces intend to link up with the resistance organization, the SF team coordinates

the linkup. When friendly conventional forces encompass the JSOA, the resistance organization may perform linkup missions. Although not strictly UW missions, these linkup missions include—

- Conducting conventional combat operations in the main battle area or rear area as an economy of force measure.
- Containing or destroying bypassed or cutoff hostile forces.
- Conducting tactical reconnaissance and surveillance missions.
- Screening difficult terrain and gaps between conventional units.
- Controlling tactical air strikes.
- Providing guides and interpreters to conventional units.
- Enforcing PRC measures to minimize civilian interference with conventional military operations.

After linkup, resistance forces revert to national control. These forces may demobilize, or they may reorganize as conventional combat forces for use in economy of force missions. Possible missions include rear area security of critical installations and LOC chokepoints and employment as tactical combat forces in the rear area.

In a conflict situation, or a secondary theater of operations during war, US policy and strategy may preclude the use of conventional military forces to assist an insurgency. In this case, the resistance organization may have to raise sufficient forces to challenge the established government or occupying power in a war of movement. In this phase, SO CA and PSYOP elements normally augment the SF team advising and assisting the area command. These elements take over responsibility for advising and assisting the resistance leadership on the political and psychological aspects of the insurgency, freeing the SF team to focus on combat operations. See Chapters 15 and 16 for more detailed discussions of CA and PSYOP support to UW.

Demobilization

Demobilization is an important and difficult phase of UW, yet is often neglected in initial UW planning. Demobilization planning should begin as soon as the US government decides to sponsor

a resistance organization. Once the resistance organization accomplishes its objectives, it should demobilize. Its shadow government may become the newly established government of the country. Resistance forces should be integrated into the reconstituted national army, even if this integration is only a transition stage toward their eventual return to civilian life. The manner in which the demobilization occurs will affect the postwar attitudes of the people and the government towards the United States.

Perhaps the greatest danger in demobilization is the possibility that former resistance members may resort to subversion of the new government, factional disputes, or banditry. The new government must make every effort to reorient and absorb former resistance members into a peaceful society

and gain their acceptance. To achieve this goal, the new government must—

- Bring arms and ammunition under government control.
- Assist resistance members in returning to civilian life.
- Take positive measures to prevent resistance members from beginning or participating in further political upheaval.

Because of their knowledge of resistance organization and history, SF teams initially remain in their operational areas to assist in demobilization. The SF team commanders and their supporting CA and PSYOP elements ensure transfer of US responsibility without loss of control, influence, or property accountability. The key to long-term strategic success in UW is the planning and execution of SF postconflict responsibilities.

SF-Resistance Relationships

The commander of an SF team with a UW mission occupies a very sensitive position. To the area commander, he is the direct representative of the US government. The SF team commander must be a diplomat as well as a military advisor. The SF team must establish a good working relationship with the resistance organization. This relationship develops from a common goal against a common enemy and resistance acceptance of US sponsorship and operational guidance. However, the SF team must recognize political considerations, personal antagonism, religious beliefs, and ethnic differences that affect its mission performance (Figure 9-4). Team members must know and respect local traditions, customs, and courtesies. They must be able to explain the policies and strategies of the US government and the theater CINC. They must be prepared to work with resistance members who

tolerate an SF presence only to obtain US material assistance.

Perhaps the most delicate responsibility of a deployed SF team commander is to ensure that competent indigenous personnel occupy key resistance positions. He should attempt to improve the knowledge, skills, and attitudes of resistance leaders and staff members. If all efforts fail and the individual's performance threatens the future effectiveness of the resistance organization, the SF team commander should carefully try to influence the selection of a replacement. In this potentially explosive situation, he must exercise extreme caution to avoid jeopardizing his mission.

SF soldiers need a working knowledge of the local language. When this is impossible to achieve, they must select interpreters carefully and use them cautiously. An interpreter is in a very sensitive and powerful position. He is the only person who knows what both parties to a conversation are saying. To be effective, he must have the trust and confidence of both the resistance organization and the SF team.

- The people are your greatest friends. Without their sympathy and active support, you cannot exist for extended periods of time. As a result, you cannot afford to alienate them by brutal behavior or lack of discipline.
- If you have to requisition something from the people, appeal to their patriotism; do not demand it.
- Do not forget that the laws of land warfare are valid even though they do not specifically cover every possible situation.
- For better or worse, you are practically dependent upon the goodwill of the people. You also depend upon their steady “I-do-not-know, I-have-not-heard-nor-seen-anything” replies to hostile interrogators, even though this attitude might mean their deportation or death.
- Even if the population should act only halfheartedly in your behalf, you will always find some people willing to help you as observers, scouts, and messengers.
- You must be extremely cautious in your contact with elements of the civilian resistance organization, even in liberated areas. You must not expose their cover for a temporary advantage since they may be captured by the hostile force after your departure.

Figure 9-4. The Keys to Good Relations and Support.

Psychological Operations

The resistance organization must have an effective PSYOP program. Proper PSYOP create unity, maintain resistance morale, and gain the sympathy and support of the civilian population. In addition

to the formal PSYOP program, the SF team commander must ensure the resistance organization considers the psychological implications of its activities. The ability of the resistance organization to obtain civilian support depends primarily upon its psychological impact on the population. The adverse effects of improper resistance activities may outweigh any tactical benefits.

Discipline

Resistance operations are decentralized and widely dispersed. They generally involve actions that the hostile power considers illegal. Resistance members may appear unkempt or bedraggled because of the environment in which they operate. These factors create opportunities for loose discipline and misconduct. However, strict discipline is essential to any resistance organization. Resistance leaders and members must understand that even minor infractions against the civilian population can have far-reaching consequences. Resistance members must know that their personal conduct must be above reproach when dealing with civilians.

To prevent ill-discipline and misconduct, the resistance leadership must develop and enforce a written code of discipline. Figure 9-5 provides a historic guide

for developing such a code. Each resistance member must understand its provisions, to include the penalties for violations. The resistance code of discipline should be simple. It should prescribe harsh but fair punishments for what would be minor offenses in a conventional military force. The code should incorporate the provisions of the Geneva Conventions to minimize hostile propaganda potential and enhance the legitimacy of the resistance organization.

Although the resistance leadership is responsible for maintaining discipline in the resistance organization, the SF team commander may recommend measures to ensure proper discipline. The SF team commander and area commander must also agree on disciplinary and judicial authority over the SF team. The SF team commander will **NOT** give up his disciplinary or judicial authority over members of his command.

RULES OF DISCIPLINE

Obey orders in all your actions.

Do not take a single needle or piece of thread from the masses.

Turn in everything captured.

Instructions of the General
Headquarters of the Chinese
People's Liberation Army
10 October 1947

POINTS FOR ATTENTION

Speak politely.

Pay fairly for what you buy.

Return everything you borrow.

Pay for anything you damage.

Do not hit or swear at people.

Do not damage crops.

Do not take liberties with women.

Do not ill-treat captives.

Figure 9-5. Mao's Three Main Rules and Eight Points.

Resistance Logistics

Each resistance organization must develop its own logistics system to meet its specific requirements and situation. In general, however, a resistance organization meets its logistical requirements by a combination of internal and external means.

The JSOA must provide the bulk of a resistance organization's logistical requirements. The area commander must balance his support requirements against the need to gain and maintain civilian cooperation. Imposing excessive demands on the population may adversely affect popular support. Logistical constraints may initially dictate the size of the resistance organization.

As the resistance organization expands, its logistical requirements may exceed the capability of the JSOA to provide adequate support. When this situation occurs, an external sponsor provides supplemental logistical support or the resistance organization reduces the scale of its activities. External support is normally limited to the necessities of life and the essential equipment and supplies required to conduct combat operations.

External support is an important means of demonstrating support and obtaining influence. When compared to a conventional unit, a resistance organization has fewer and more basic logistical requirements. External support requirements include the following:

- Food.
- Clothing.
- Shelter.
- Weapons.
- Ammunition.
- Demolitions.
- Communications.
- Medical support.
- Transportation.
- Storage.
- Maintenance.

Most areas suitable for guerrilla bases have some natural foods, but these foods usually cannot sus-

tain the energy of active guerrillas. The area commander must obtain high-calorie foods such as grains, sugar, and meats.

Guerrillas need seasonal changes of clothing in the temperate zone. Waterproof clothing is desirable. Guerrillas need sturdy, well-fitted shoes or boots because they depend on their feet for mobility.

Guerrillas require natural or constructed protection from the elements and hostile observation.

Captured weapons are initially the primary source of weapon resupply and replacement parts. The area commander must establish weapons accountability by type to determine the required rate of ammunition resupply.

During the organization and buildup phases, the resistance organization has minimal physical contact with hostile forces and requires little ammunition. During the combat employment phase, the area commander must impose strict fire discipline to conserve ammunition.

The amount of demolitions required depends on the number and types of combat operations to be accomplished in a given period. The interdiction of complex target systems by multiple attacks requires significant amounts of explosives.

Initially, most resistance communications are clandestine and non-technical. During the combat employment phase, resistance forces must rely on radios for tactical communication during combat operations.

The resistance organization requires basic medicines and other medical supplies to treat its members. Preventive medicine is especially important to a resistance organization because it normally does not have adequate facilities to treat diseases.

The area commander normally obtains transportation support from the auxiliary on a mission basis. The guerrilla force may have its own organic transportation system to meet its immediate needs. In remote or undeveloped areas, the primary means may be human porters or pack animals.

The area commander caches extra supplies and equipment throughout the operational area.

Caching is not a haphazard affair. Caches must support anticipated operational requirements or specified emergencies.

The resistance organization obtains repair material from the local economy and through battlefield recovery to perform all maintenance and repairs within its capability. It may establish repair facilities within the area complex. The sponsor includes necessary maintenance and repair items with all equipment it provides the resistance. Introducing sophisticated equipment into the JSOA may complicate the maintenance system.

Internal sources of resistance supply include the following

- Battlefield recovery.
- Purchase.
- Levy.
- Barter.
- Production.
- Confiscation.

Successful offensive operations permit resistance forces to satisfy some of their logistical requirements by battlefield recovery. Capturing supplies from hostile forces also avoids alienating civilians.

The resistance organization normally limits its purchases to critical items unavailable by other means. Excessive introduction of external currency may disrupt the local economy. Such disruption may not be in the interest of the resistance organization or the United States.

The resistance organization may organize a levy system to ensure an equitable system for obtaining supplies from the local population. Under a levy system, the resistance organization provides receipts and maintains records of levy transactions to facilitate

reimbursement at the end of hostilities. Obstacles to a levy system include—

- Chronic shortages among the local population.
- Hostile PRC measures, to include confiscation or destruction of local resources.
- Competition from the hostile power or rival resistance organizations.
- NBC or other contamination of local resources.

Barter may adversely affect the levy system. However, it may be the only method of obtaining critical items (such as medical supplies) or services.

Resistance forces often have to improvise their own field expedients. They may even have to plant and raise their own food, dig wells, and tend their own livestock. The area commander may consider establishing clandestine factories to produce items that are otherwise unobtainable.

Confiscation alienates the local population. The resistance organization should use confiscation only in emergencies or to punish individuals who refuse to cooperate or who actively collaborate with the hostile power. In all cases, resistance leaders must strictly control confiscation to ensure that it does not deteriorate into looting.

The deployed SF team commander is accountable for all equipment and supplies delivered to the JSOA. His control of US-provided material enhances his ability to influence resistance activities. He must establish positive control and maintain accountability for sensitive items such as weapons, ammunition, explosives, radios, drugs, and funds. An SF team member should be present at all deliveries of external supplies. The SF team should determine the quantities and disposition of sensitive items procured from other sources. The information helps in determining the proper distribution of US material, assessment of resistance capabilities, and demobilization.

Resistance Health Service Support

The goals of resistance HSS operations are to conserve the fighting strength of resistance forces

and to secure the support of the local populace. Resistance HSS must be mobile, responsive, and effective in preventing disease and restoring the sick and wounded to duty. The resistance organization normally has no safe rear area to treat its casualties. Wounded and ill personnel become a

tactical rather than a logistical problem. The SF team commander will find that HSS is a major tactical consideration in all operations.

A broad range of medical support may be available in the JSOA. Historically, some resistance organizations have developed highly organized and effective HSS systems. In most cases, however, the local population cannot support the area command with qualified medical personnel. For the SF team, HSS can be an effective way to establish rapport with the resistance organization. The SF medical sergeant is uniquely qualified as a physician substitute or independent duty medic. He can deliver a sophisticated level of medical care when physician care is

not available. Upon initial contact, he provides almost immediate access to the resistance membership. Each medical act can be an effective presentation of SF credibility.

As the requirement for doctors and other medical specialists increases, an SF medical team may infiltrate to establish and operate a clandestine hospital in the JSOA. An SF clandestine hospital is a medical treatment facility, or complex of facilities, providing in-patient medical care to resistance members. The SF medical team should infiltrate as soon as possible during the building phase so that its clandestine hospital is fully operational when the combat employment phase begins.

CHAPTER 10

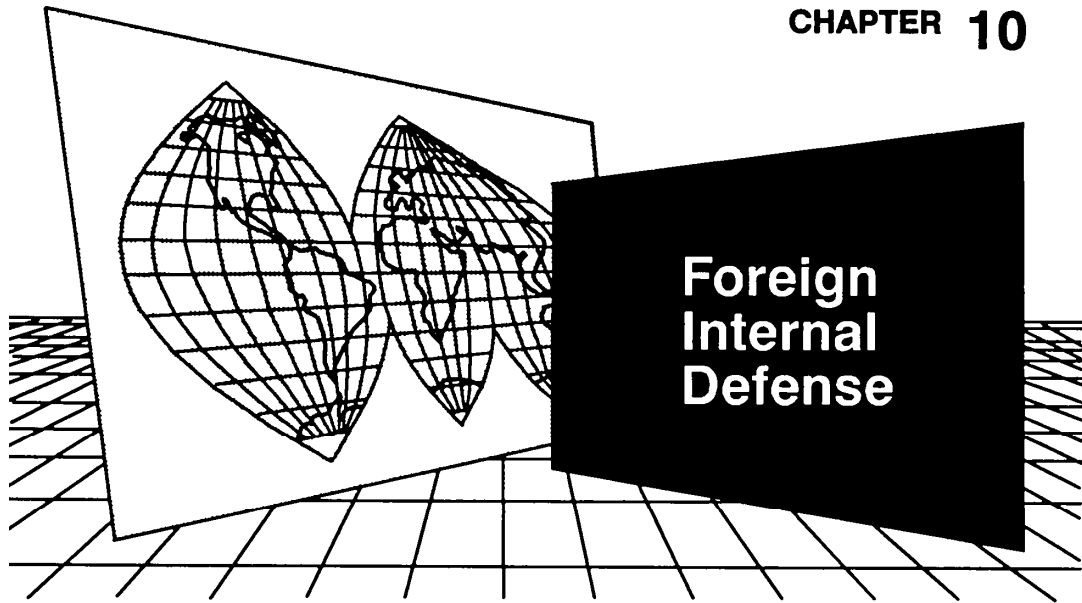

FID is not exclusively an SF mission. It is a joint and interagency activity of the US government. This chapter discusses employment considerations for SF teams conducting FID missions. It discusses the considerations for a transition to support a conventional expeditionary force. The chapter uses the term **Insurgency** for consistency with JCS Pub 3-07 and FM 100-20. In practice, SF teams may conduct FID missions to counter any armed resistance movement.

Internal Defense and Development

Internal defense and development (IDAD) are all the measures taken by a nation to promote its growth and protect itself from subversion, lawlessness, and insurgency. IDAD is an overall strategy for preventing or defeating an insurgency. It focuses on building HN institutions that are responsive to

the needs of the society. Successful IDAD programs eliminate problems before an insurgency can exploit them. The US IDAD strategy assumes that the HN government is responsible for preventing or defeating any threat to its own control and legitimacy. The primary US objective is to support a level of HN internal security that permits economic, political, and social growth through balanced development programs. (See JCS Pub 3-07 and FM 100-20 for detailed discussions of US support to counterinsurgency.)

Special Forces FID Operations

The primary SF mission in FID is to organize, train, advise, and assist HN military and paramilitary forces. The intent is to improve the tactical and technical proficiency of these forces so they can defeat the insurgency without direct US involvement. The capabilities that SF employs to perform its FID mission are those inherent to its UW mission. Only the operational environment is changed. To accomplish its FID mission, SF participates in the following types of operations:

- Training assistance.
- Advisory assistance.
- Intelligence operations.
- Psychological operations.
- Civil-military operations.
- Populace and resources control.
- Tactical operations.

Training Assistance

SF teams may develop, establish, and operate centralized training programs for the supported HN force. SF teams can also conduct individual, leader, and collective training programs for specific HN units. Subjects can range from basic combat training and leader development to specialized collective training. SF training assistance often develops a HN cadre that can then train the rest of the HN force on a sustained basis.

Whenever possible, SF soldiers should be able to conduct the training in the indigenous language or a third language common to both trainers and students. If this is impossible, the SF unit must obtain competent and trustworthy translators.

Advisory Assistance

SF may provide advisory assistance in two ways. SF teams may provide operational advice and assistance to specific HN military or paramilitary organizations. Individual SF soldiers may be assigned or attached to the SAO to perform advisory

assistance duties on a temporary or permanent basis. In either case, SF provides advisory assistance under the OPCON of the SAO chief in his role as in-country US defense representative.

The SF advisor must understand the total scope of SAO activities. He must know the functions, responsibilities, and capabilities of the other US agencies in the HN. Many SF activities cross the jurisdictional boundaries or responsibilities of other Country Team members. The SF advisor should seek out other Country Team members to coordinate his portion of the overall FID effort.

The SF advisor is first and foremost a representative of the United States in a foreign country. His mission is to implement established US policies. His functions and duty requirements are often quite different from those performed by conventional US military personnel. SF advisors frequently find themselves dealing with HN counterparts of quite different cultural, educational, and military backgrounds. Together they must resolve problems by means appropriate to the HN, without violating US laws and policies in the process. SF advisors operate under very specific ROE. The purpose of the ROE is to ensure the advisors remain advisors. The ROE are strictly enforced and violations normally result in that advisor's immediate removal from the HN.

Successful advisory assistance depends more on effective cross-cultural communications and close personal relationships than on formal agreements. To advise a HN counterpart effectively, the SF advisor must understand the HN's sociological, psychological, and political makeup. Advice may be the least desired assistance that SF offers. HN military leaders may tolerate it only to obtain material and training assistance. Even when they accept advice, they may not act upon it immediately. The SF advisor must realize that his counterpart will normally act within the context of his own sociopolitical experience. Political objectives and constraints, rather than military capabilities, often dictate the roles, missions, and force development of HN military and paramilitary forces. The SF advisor must always remain sensitive to the HN

environment in which he and his counterpart operate.

While refusing US advisors, HN military leaders may request and receive US mobility and fire support if the insurgency worsens. To coordinate this support and ensure it is properly employed, US liaison teams should accompany HN ground maneuver units receiving US direct combat support. Language-qualified and area-oriented SF teams are especially suited for this mission.

Intelligence Operations

An insurgency relies on secrecy and surprise to conceal itself and to overcome the HN government's superiority in military power and other resources. Effective intelligence operations penetrate the insurgents' screen of secrecy and permit the HN government to take advantage of its superior resources. HN and US intelligence operations support counterinsurgency planning and operations by providing information on the operational area and the insurgent organization. Intelligence operations must not focus only on obtaining military OB information. Of particular importance are intelligence operations that seek to neutralize or destroy the insurgents' political and intelligence infrastructure.

Psychological Operations

To defeat an insurgency, the HN government must retain or regain the confidence and support of its people. The objective of an IDAD program should not be to kill or even capture the insurgents. It should be to convince them to abandon a hopeless or worthless cause and support the HN government. PSYOP must therefore be an integral and vital part of an IDAD program. SF soldiers may have to educate their HN counterparts in the value and role of PSYOP in FID. They must then advise and assist HN forces in developing and implementing an effective PSYOP program. (See Chapter 15 for a more detailed discussion of PSYOP support of SF FID operations.)

Civil-Military Operations

CMO enhance the relationship between military forces, civilian authorities, and the population. SF advisors assist HN military forces in developing effective CA programs that mobilize the civil

population in support of the HN government's IDAD programs. SF CMO include civil assistance to the HN government and military civic action. (See Chapter 16 for a more detailed discussion of CA support of SF FID operations.)

Populace and Resources Control

PRC measures mobilize the human and material resources of the HN and deny these resources to the insurgents. PRC measures include personnel documentation, curfews, travel restrictions, rationing and price controls, licensing, and checkpoint operations. The enforcement of PRC measures should be primarily a HN police or paramilitary responsibility. HN military forces may assist in PRC operations. PRC operations may support military operations.

The HN government must integrate PSYOP into PRC operations to explain that PRC measures are the result of insurgent activity. The people must be persuaded that—

- The insurgents and not the HN government are to blame for the inconvenience of PRC measures.
- The government acts for the long-range benefit of the people.
- The activities of the insurgents are harmful to the people and require the imposition of PRC measures.
- Insurgents are the enemy of the people and must be denied support and supplies.
- Loyal citizens must declare themselves, their families, and their communities on the side of the government by full and voluntary compliance with the program.
- The government will reduce and eliminate the PRC program as the insurgent threat decreases.

The civil population is more likely to accept PRC measures enforced by HN personnel. SF teams should normally limit their participation to advice, training, and indirect support of PRC operations. SF advisors may accompany HN military or paramilitary personnel conducting PRC operations. However, they must convey to the population that they are only supporting a HN program rather than implementing a US-directed program.

Tactical Operations

Because of its extensive UW training, SF is particularly qualified to advise and assist the HN in such tactical operations as consolidation, strike, remote area, border, and urban area. The objective of tactical operations in FID is to provide a secure environment where balanced development can occur. Tactical operations should not be independent military actions aimed only at destroying insurgent combat forces and their base areas. They should be an integral part of a synchronized IDAD effort to gain broader strategic objectives. The SF team commander must convince his counterpart to integrate intelligence, CA and PSYOP activities into every tactical operation. SF advisors and their HN counterparts must know the impact their tactical operations have on the populace and other IDAD programs.

Consolidation Operations. Consolidation operations are long-term population security operations conducted in territory that is generally under HN government control. Their purpose is to—

- Isolate the insurgents from the civil population.
- Protect the civil population from insurgent influence.
- Neutralize the insurgent infrastructure.

The people are unlikely to support the HN government fully until the government provides sufficient long-term security to free its people from the fear of insurgent reprisals. Consolidation operations are designed to accomplish these objectives. They typically pass through the four stages shown in Figure 10-1.

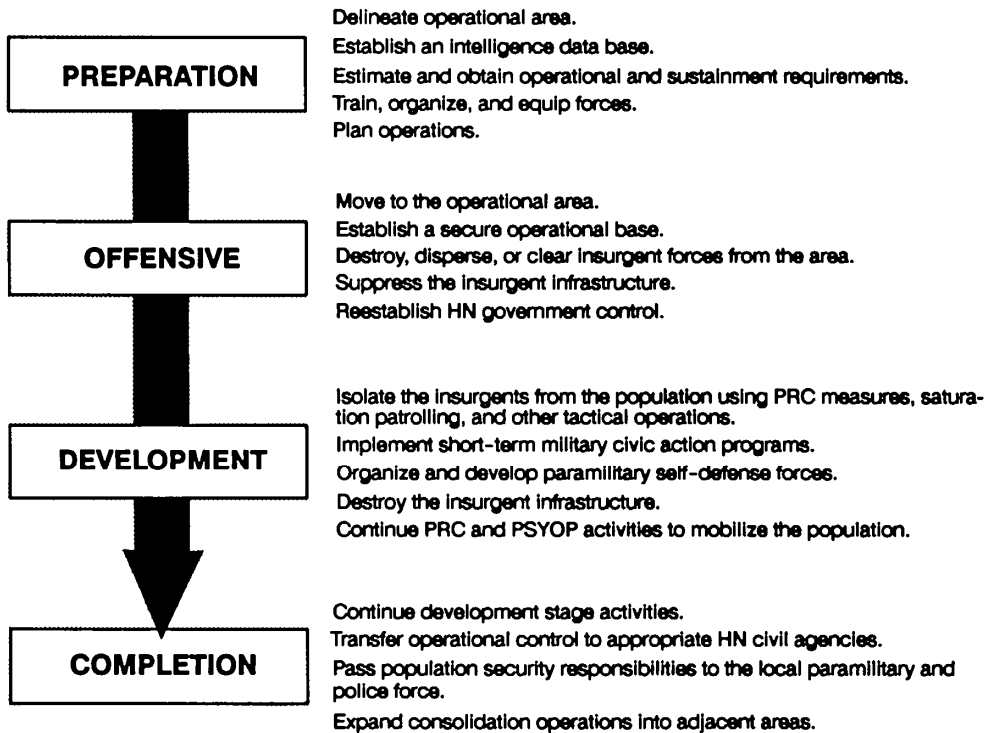

Figure 10-1. Four Stages of Consolidation Operations.

Strike Operations. Strike operations are short-duration tactical operations conducted in contested or insurgent-controlled areas. They support consolidation operations by preventing insurgent forces from contesting HN pacification efforts. Their purpose is to—

- Destroy insurgent forces and base areas.
- Isolate insurgent forces from their support.
- Interdict insurgent infiltration routes and LOC.

Strike operations are primarily offensive operations. They are characterized by small, highly mobile combat forces operating in dispersed formations to locate and fix the insurgent force. Once the insurgent force is located, strike force commanders attack, pursue, and destroy it. If contact with the insurgent force is lost, strike force commanders resume aggressive patrolling to reestablish contact and destroy the force before it can rest, reorganize, and resume combat operations. (See FM 90-8 for a detailed discussion of tactical counterinsurgency operations.)

SF advisors must advise against strike operations that overshadow and dominate the nonmilitary aspects of counterinsurgency. Counterinsurgency, like insurgency, requires a balanced approach in which tactical operations often play a supporting role. To defeat an insurgency, the HN government must isolate the insurgents from the population on which they depend for manpower, supplies, funds, and intelligence. When denied access to the population, the insurgents must do one of the following:

- Stand and fight for control over the population, subjecting themselves to the superior combat power of the established government and its allies.
- Retreat to their remote base areas, where isolation from the population diminishes their influence and reduces the relevance of the insurgency to the legitimate needs of the population.
- Revert to an earlier phase of insurgency and resume low-level subversive activities until conditions become more favorable.

Remote Area Operations. Remote area operations are operations undertaken in insurgent-controlled or contested areas to establish islands of popular support for the HN government and deny support to the insurgents. They differ from consolidation operations in that they are not designed to establish

permanent HN government control over the area. Remote areas may be populated by ethnic, religious, or other isolated minority groups. They may be in the interior of the HN or near border areas where major infiltration routes exist. Remote area operations normally involve the use of specially trained paramilitary or irregular forces.

SF teams support remote area operations to interdict insurgent activity, destroy insurgent base areas in the remote area, and demonstrate that the HN government has not conceded control to the insurgents. They also collect and report information concerning insurgent intentions in more populated areas.

PSYOP and CA programs assist in obtaining local support for remote area operations. Success is more likely if—

- A significant segment of the local population supports the program.
- The HN recruits local personnel for its remote area paramilitary or irregular force.

HN forces may conduct remote area operations to interdict infiltration routes in areas nearly devoid of any people. In this case, SF teams advise and assist irregular HN forces operating in a manner similar to the insurgents themselves, but with access to superior CS and CSS resources.

Border Operations. Border security should be the responsibility of HN police, customs, or paramilitary border forces. However, the threat may require combat-type border operations, particularly in remote areas. SF teams advise and assist HN forces assigned to prevent or interdict the infiltration of insurgent personnel and material across international boundaries. The intent is to isolate insurgent forces from their external support, to include external sanctuaries. Secondary purposes are to—

- Locate and interdict insurgent land infiltration routes.
- Destroy insurgent forces and base areas in areas adjacent to the border.
- Collect and report information concerning insurgent capabilities and intentions.

Border operations normally require restrictive PRC measures that are particularly annoying to border tribal and ethnic groups who do not recognize the international boundary. The HN government must

make a continuing PSYOP effort to gain and maintain the loyalty of the affected population.

Urban Area Operations. Clandestine insurgent activity may be extensive in urban areas. It can include terrorism, sabotage, and PSYOP in addition to political, organizational, intelligence, and logistical operations. This insurgent activity may strain the capabilities of police and other civil authorities. Police, internal security, and other HN government organizations will be high priority targets for the insurgents. The insurgents normally try to exploit local civilian organizations by subverting their goals and objectives to serve the insurgent cause. The insurgents strive to create situations that cause HN police and military forces to overreact in a manner that adversely affects the civil population.

SF teams, with assistance from assigned and attached MP and CI personnel, advise and assist HN forces engaged in urban area operations. The purpose of these operations is to—

- Eliminate the centralized direction and control of the insurgent organization.
- Create insurgent disunity.
- Destroy the insurgent infrastructure that threatens the HN government.

When military forces reinforce police in an urban area, their operations must be even more closely controlled and coordinated to minimize collateral

damage and prevent hostile propaganda victories that occur when US or HN military forces overreact to insurgent actions. As a result, the need for PSYOP and CA support greatly increases in urban areas.

Support of US Combat Forces. If the HN government's situation deteriorates to the point that vital US interests are in jeopardy, the NCA may commit US forces in a combat role to effect a decisive change in the conflict. Direct US military intervention can provide HN forces with the time and space to regain the strategic initiative and resume control of tactical operations.

In this situation, the committed US combat force is likely to find in-country SF teams with a myriad of formal and informal arrangements. The US conventional commander should treat this situation like a UW linkup operation. He should fully exploit SF experience and contacts during the critical transition period when his forces are deploying into the country. He should immediately exchange liaison personnel with the appropriate SF headquarters to exploit SF advice and assistance. The SF headquarters should provide all possible advice and assistance, to include—

- Situation and intelligence updates for incoming conventional commanders and their staffs.
- Use of in-place SF elements for initial coordination with HN and US Mission agencies.

SF Organization for FID Operations

When an SF unit is committed to a FID mission, it normally receives appropriate CS and CSS augmentation and may be designated as a security assistance force (SAF). The SF unit may instead be assigned to a SAF organized around another military organization. The SAF is similar to a conventional unit combined arms task force, but is specifically designed to support counterinsurgency. The composition and

command relationships of a SAF depend on its specific circumstances. A SAF is flexibly organized with the wide range of skills needed to augment the capabilities of the in-country SAO. When an SF unit is designated as the nucleus of a SAF, its normal augmentation includes—

- A CA element.
- A PSYOP element.
- A medical element.
- An engineer element.
- An MP element.
- An MI element.

- A signal element.
- Other combat, CS, and CSS elements as required.

An SF FID mission may require assets ranging from a single SF team to a reinforced SF group. In the early stages of an insurgency, the level of SF Participation may be as small as one SFOD under the direct OPCON of the SAO. In the more advanced stages, an SF battalion or company may establish an operational base (in or out of country) and exercise OPCON of SFODs for the SAO. Operational and support elements may be assigned to the base on a rotational or a permanent basis. When an entire SF group is committed, it normally establishes an SFOB and one or more FOBs. For OPSEC purposes, these bases should be established in CONUS or a third country, if possible.

When the entire SF group is committed, the SFOB commander and staff are primarily concerned with synchronizing SF activities with the activities of the HN and other US Country Team agencies. The FOB elements prepare, deploy, control, and support SAF operational elements. The SAP commander may assign missions to the FOBs on either a functional or a regional basis. In addition to supporting SF tactical operations, the SAP must be able to support intelligence, PSYOP, CA, PRC, and other operations. See Figure 10-2 for an example of a highly structured organization for counterinsurgency.

An SF team must coordinate its activities with the appropriate HN government officials and other US advisory elements in its operational area. There

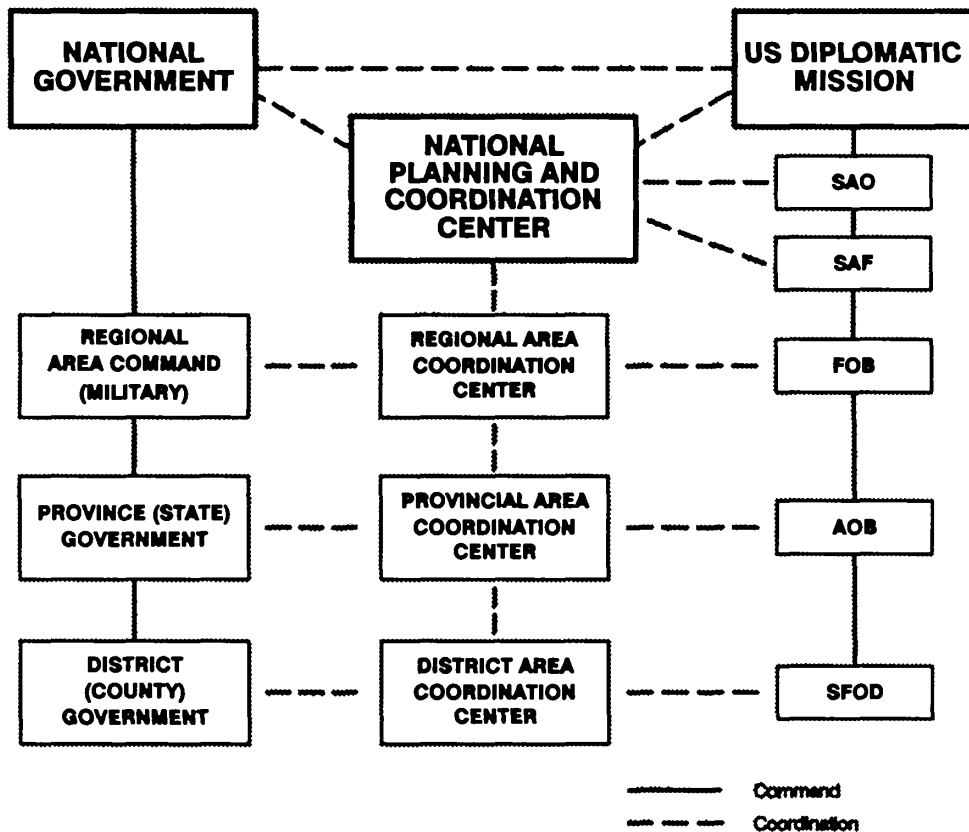

Figure 10-2. A Type Organization for Counterinsurgency.

may be an area coordination center (ACC) to facilitate this coordination effort. An ACC is a HN or combined (US/HN) civil-military headquarters responsible for planning, coordinating, and directing all IDAD activities within its jurisdiction. The integration of operational, intelligence, and support activities is its most critical function. The senior HN political or military official is the ACC director (chief), but he usually delegates normal day-to-day coordination to his deputy. A civilian advisory committee composed of leading citizens provides a communications link between the ACC and the local population. The SF commander may be the senior US advisor to the HN official directing the ACC. The SF team may coordinate its activities through

an interagency US advisory assistance team assigned to the ACC. See Figure 10-3 for a type provincial ACC organization.

If the US and HN establish a combined C2 organization, the SAO or SAF may be directed to pass OPCON of the SF team to the appropriate combined area commander. In this situation, the parent SAO or SAF—

- Retains command less OPCON.
- Provides all support and sustainment not provided by the area commander.
- May retain tasking authority for SF missions performed beyond the area commander's jurisdiction.

SF Rear Operations

During war, the theater CINC commits his assigned SF units primarily to deep operations. However, when hostile insurgents or hostile SOF present a significant threat to friendly rear areas, the theater CINC may commit SF elements to rear operations (Figure 10-4).

Conventional CSS units in the rear area establish, or are assigned to, mutually supporting base clusters for local defense. MP units secure the LOC between base clusters, conduct area reconnaissance to detect rear area threats, and fight to defeat threats that exceed base cluster defensive capabilities. When a threat exceeds MP combat capabilities, the MPs delay or disrupt the hostile force until a tactical combat force is committed to defeat it. (See FM 90-14 for a detailed discussion of rear operations.)

The MP rear area security mission outlined above may exceed MP capabilities within the theater of operations. MP capabilities are most likely to be inadequate under the very circumstances where the rear area threat is greatest—in hostile territory or

during Third World contingency operations when US LOC are extended. The bulk of MP activity may be restricted to the vicinity of the LOC and base clusters, conceding to hostile forces almost complete freedom of action in the more remote areas of the friendly rear. Even if HN internal security forces are available, they may require US advisory and training assistance to effectively counter the threat of a well-organized and popular insurgency.

When directed, SF teams organize, train, equip, and direct foreign combat forces to conduct offensive rear operations against a hostile insurgent or SOF threat. Under the OPCON of the appropriate TAACOM or combat unit (normally corps or higher), these forces operate in platoon or company strength in the remote areas of the friendly rear (Figure 10-4). They adopt counterinsurgent organization, tactics, and techniques. They live and fight for extended periods with minimal external support. Their activities include—

- Saturation patrolling of likely and suspected base areas.
- Upon detection of a base camp, employing raids and ambushes against it or reporting its location so that a conventional combat force can attack and destroy it.

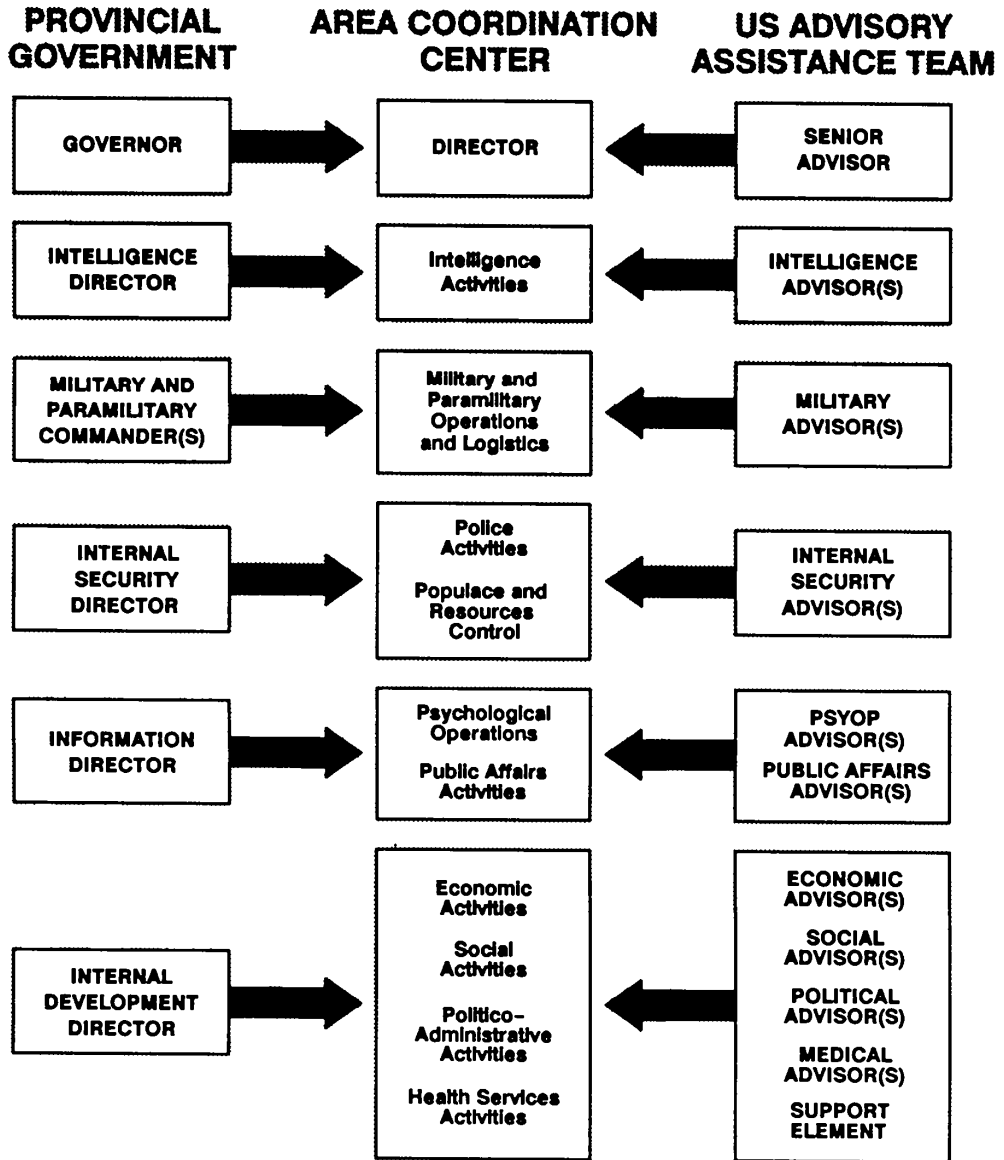

Figure 10-3. A Type Provincial ACC.

- Establishing ambushes along likely hostile infiltration routes to friendly base clusters.
- Reacting to hostile attacks by trailing and hunting down the attackers.

Depending on the nature of the specific situation, these SF-directed combat forces may require additional CS and CSS resources. Such support may include artillery, combat aviation, and close air support (to include AC-130 gunships) on a mission basis.

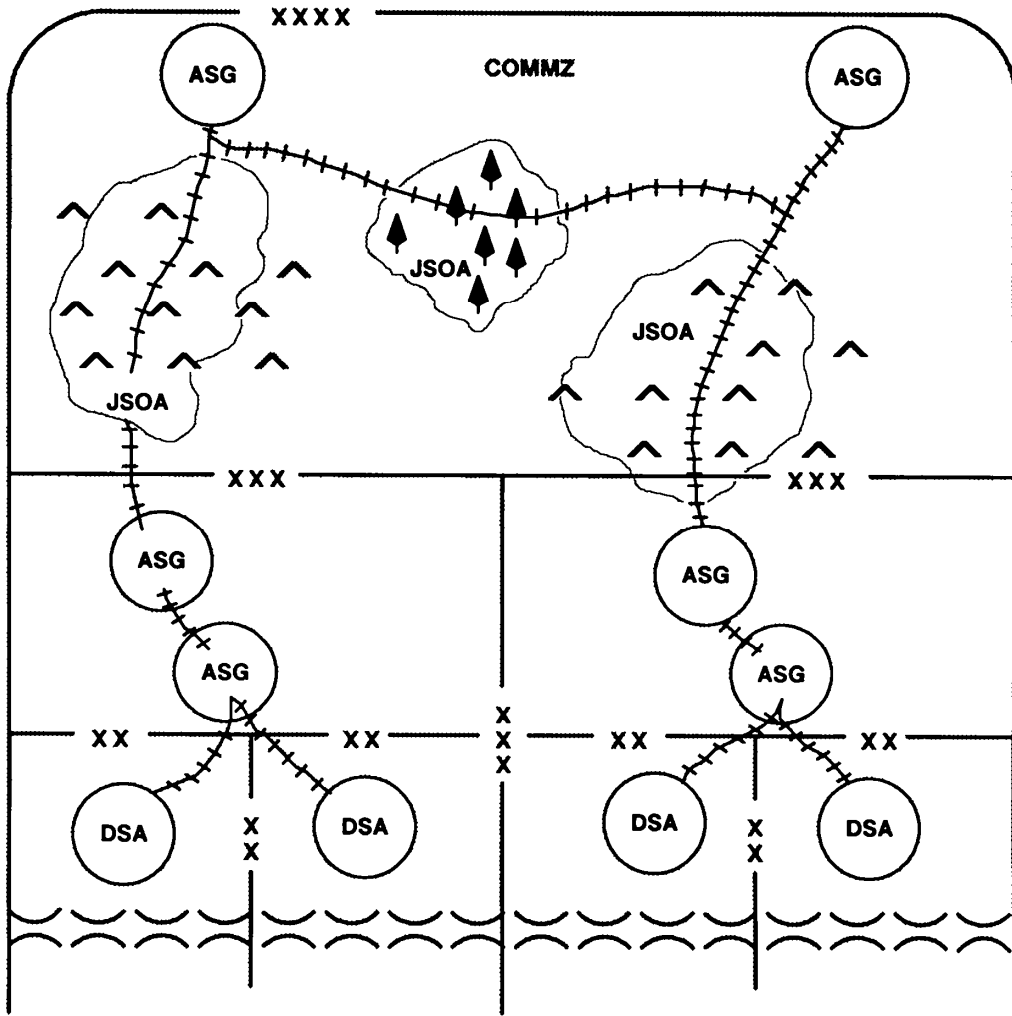
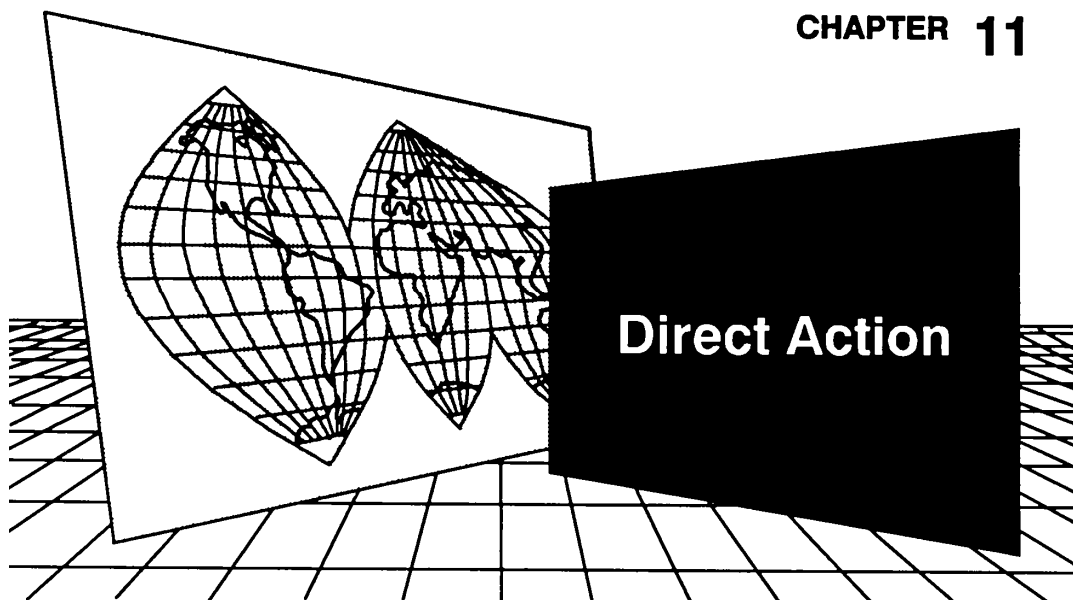

Figure 10-4. SF Rear Operations.

CHAPTER 11



Unlike UW and FID, DA operations do not rely on the indirect application of military force through a foreign power. DA operations are directed and controlled by an SO headquarters. They are predominantly conducted by SOF. This chapter discusses the nature of DA operations. It provides employment considerations for DA operations. It also discusses CSAR as an SF collateral activity.

Nature of DA Operations

DA operations are combat operations conducted beyond the range of tactical weapons systems or the area of influence of conventional military forces. In the conduct of DA operations, SF teams may employ direct assault, raids, ambushes, or sniping. They may emplace mines and other munitions. They may provide terminal guidance for precision-guided munitions. They may also perform more subtle forms of DA such as independent clandestine sabotage.

SF can use conventional or special munitions to neutralize or destroy a designated high payoff target or to attack the critical nodes of a designated target system. The SF capability to employ special munitions expands delivery options and permits the pre-positioning of special munitions in denied areas.

In addition to target attack, SF teams also conduct recovery missions. SF teams can—

- Capture selected hostile personnel or obtain selected hostile items of materiel.
- Rescue US or allied PWs, political prisoners, or other selected personnel being detained by a hostile power.

- Locate, identify, and recover downed aircrews, political or military leaders seeking to come under US control, or other designated personnel not being detained by a hostile power.
- Locate, identify, and recover nuclear or chemical weapons, downed satellites, classified documents, or other sensitive items of materiel.

SF executes DA operations in four modes:

- Unilaterally, with pure SF teams.
- Unilaterally, with a mix of SF, other SOF, and conventional US forces.
- As a combined operation, with SF-led foreign teams.
- As a combined operation, with SF-trained and directed foreign teams.

UW and DA are interrelated activities, particularly when the DA mission involves the use of foreign

teams or clandestine sabotage techniques. Three criteria distinguish DA from UW:

- DA operations are controlled and directed by a SOF chain of command, not by an indigenous resistance organization with SOF advice and assistance.
- DA operations do not depend on the popular support of the indigenous population.
- DA operations are short-term, with specific and well-defined objectives.

The SF generic capability to conduct DA operations cuts across all operational environments. The target may be a high-level military headquarters, an industrial plant, an insurgent base camp, or a terrorist training facility.

The mission determines the size of the SF team, mode of employment, and tactics and techniques employed. DA operations can range from a two-man SF team performing a clandestine sabotage mission to a reinforced SF company performing an overt raid or ambush.

Command and Control of DA Operations

In situations short of war, the NCA directs the appropriate regional unified commander to plan and execute contingency DA operations. If the NCA desires more positive control, it may direct USCINCSOC to plan and direct the operation. The NCA may also direct USCINCSOC to establish a JSOTF reporting directly to the NCA or the CJCS.

During war, the theater CINC has the authority to conduct DA operations that support the theater campaign plan and the major operations of his conventional force commanders. He exercises this authority by providing the SOC commander a combination of—

- Mission-type orders.
- Specific mission taskings.
- Rules of engagement.
- Other mission guidance.

CSAR Operations

The SOC is responsible for CSAR within its assigned JSOAs. Operational requirements may dictate that

the SOC commander dedicate a number of SF teams to conduct time-sensitive CSAR missions. Even if no dedicated CSAR teams exist, the theater Joint Rescue Coordination Center may request SOC assistance in CSAR operations when—

- A CSAR incident occurs close to a SOF asset.

- Special circumstances make the use of conventional CSAR forces inappropriate or infeasible.
- CSAR requirements exceed the capability of the theater CSAR force.

If SF teams can be made available without jeopardizing their primary mission, the SOC commander will release them for CSAR mission execution. These SF teams can facilitate the contact, authentication, security, medical treatment,

movement, and exfiltration of distressed personnel. They can clandestinely recover evaders to safeguard the integrity of designated evasion areas.

SF teams can also perform precautionary CSAR. Their use is particularly appropriate during contingency operations short of war. The sensitivity of particular air missions may justify the deployment of SF teams to provide precautionary CSAR assistance along the flight routes.

CHAPTER 12

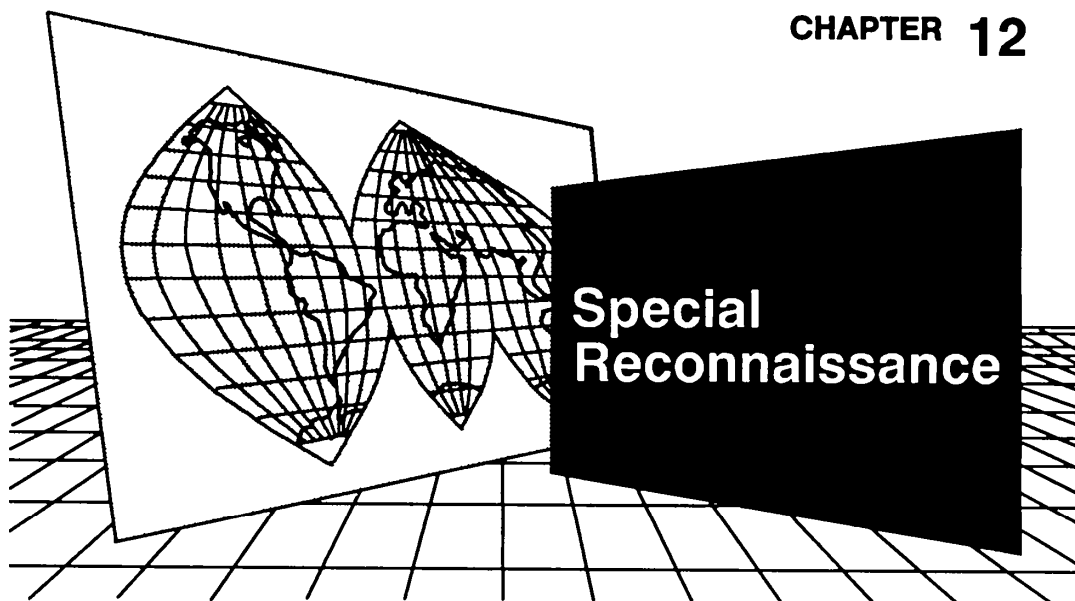

SR operations are similar to DA operations except for actions in the objective area. Like DA operations, they are normally unilateral in nature and limited in scope and duration. This chapter discusses the nature of SR operations. It also provides employment considerations for SR operations.

Nature of Special Reconnaissance

SR operations encompass a broad range of intelligence collection activities, to include reconnaissance, surveillance, and target acquisition. They may involve combined activities with foreign personnel. Long-term SR intelligence collection efforts are very similar to UW intelligence collection. As with DA, the difference between SR and UW lies in the direction and control of SR operations by the SOF chain of command. The SR collection effort emphasizes US unilateral (or alliance) intelligence requirements, not the requirements of an indigenous resistance organization. SR complements other

national and theater collection systems (such as high altitude imagery or SIGINT) that are more vulnerable to weather, terrain masking, and hostile countermeasures.

SR operations can be broken into two broad categories—battlefield reconnaissance and surveillance and clandestine collection. (See TC 31-29 and FM 34-60A for detailed discussions of procedures.) Battlefield reconnaissance and surveillance involves the use of standard patrolling tactics and techniques. Such missions are often for extended durations beyond or in the absence of conventional fire support and sustainment means. They may be conducted by personnel using clothing and equipment that cannot be traced.

Clandestine collection is complex and sensitive. Clandestine collection involves the use of SIGINT and HUMINT techniques normally reserved to the US intelligence community. SF teams may conduct unilateral clandestine collection missions in crisis situations, in support of national and theater CT forces, or in other conditions short of war. In wartime or as a special activity, SF teams may conduct unilateral clandestine collection missions in hostile areas where the threat precludes the use of other HUMINT means. Clandestine collection may require oversight, interagency coordination, and/or control of SF teams by the US intelligence community. Typical SR missions include—

- Initial contact with an indigenous resistance organization and assessment of resistance potential.
- Collection of strategic political, economic psychological, or military information.

- Collection of critical military OB information (for example, NBC capabilities and intentions, commitment of second-echelon forces, and location of high-level headquarters).
- Collection of technical military information.
- Target acquisition and surveillance of hostile C2 systems, troop concentrations, deep strike weapons, LOC, and other military targets of strategic or operational significance.
- Location and surveillance of hostage, PW, or political prisoner detention facilities.
- Poststrike reconnaissance.
- Meteorologic geographic, or hydrographic reconnaissance to support specific aerospace, land, or maritime operations.

As with DA operations, SF has a generic capability to conduct SR missions. The target may be a high-level headquarters, a chokepoint used by follow-on military forces, or an insurgent infiltration route.

Employment Considerations

A single SF team can usually accomplish the reconnaissance and surveillance of a fixed facility or other point target. However, collecting and reporting hostile troop movements and other OB data normally requires the coordinated effort of a significant number of SF teams. The controlling FOB must establish a network of named areas of interest arranged in depth to increase the reliability of the

effort and estimate movement rates. When tasked to perform this sort of SR mission, the FOB commander identifies the Possible hostile courses of action that concern the supported friendly commander. For each course of action, the ASPS determines where SF teams could reasonably observe those indicators and report the information in time for the supported commander to react to it. Based on this IPB, the S2 develops NAIs for target development. The tasked SF teams identify specific surveillance sites within the NAIs and plan the rest of their mission around these sites.

Communications Requirements

Communications requirements are particularly critical in SR operations. The SF team must be able to report near-real-time information directly to the

user of the information. Even more important, SF team members must know what specific information the user requires and in what priority. Using this knowledge, the team does not endanger itself unnecessarily by collecting and reporting the wrong information. The team must weigh the user's need for specific near-real-time information against the risk of compromise.

CHAPTER 13

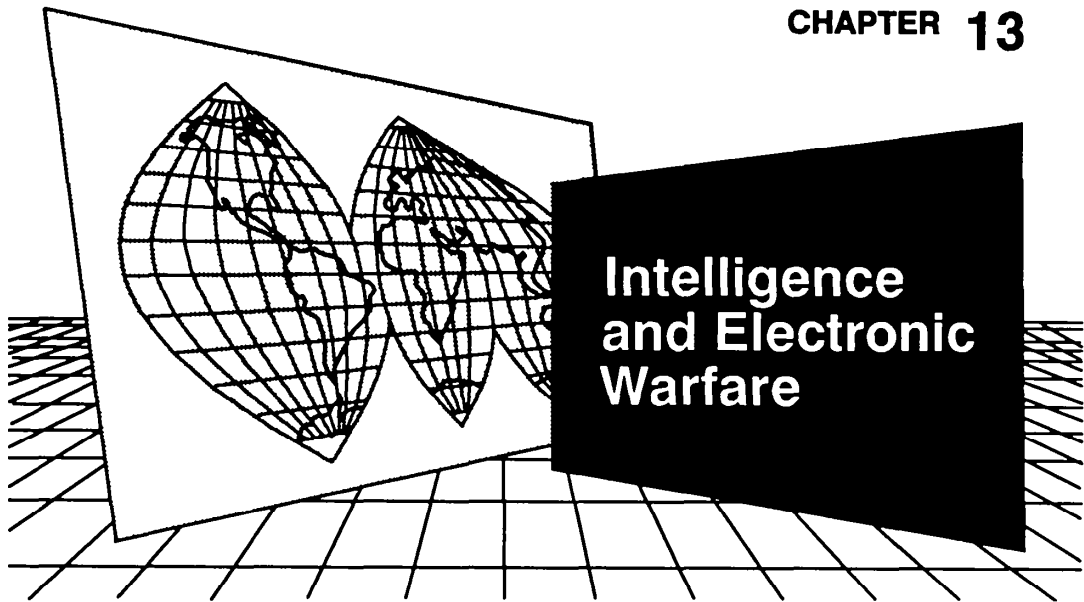

The SF group and battalion MI detachments provide dedicated IEW support to their respective bases. This chapter discusses the IEW support these detachments receive from the SOC and TASOSC. It then describes the detachments' employment in terms of four primary IEW missions: situation development, target development, electronic warfare, and counterintelligence.

IEW Support From Higher Headquarters

The SOC J2 is primarily concerned with in-theater IEW policy formulation, planning, and coordination. He ensures that sufficient intelligence support is available for each mission tasked by the SOC. He must rely on the theater service IEW organizations to collect, produce, and disseminate intelligence to meet SOF requirements. He coordinates joint SO intelligence collection operations and the production and dissemination of TIPs to support SO targeting (see Chapter 7). He tasks subordinate SOF units to collect and report information in support of SOF intelligence requirements. The SOC J6 coordinates to obtain secure SCI voice and data communications

among the headquarters of the SOC, its component commands, and the TASOSC.

The TASOSC Director of Intelligence (DOI) provides all-source IEW support to all in-theater ARSOF. He validates, consolidates, and prioritizes their standing and routine IR and other requests for information (RFI). He then forwards them to the TASOSC ISE collocated at the TA MI brigade's EACIC. Under the staff supervision of the TASOSC DOI, the ISE responds to RFIs by integrating them into the EACIC requirements list. The ISE then monitors RFI status until the appropriate collection assets respond. The ISE maintains an intelligence data base to support ARSOF requirements. It also supports the targeting process by producing TIPs (see Chapter 7).

Situation Development

Situation development is the collection and integration of intelligence and combat information into an all-source product that provides an estimate of the situation and a projection of hostile capabilities and intentions. The product must enable commanders to see and understand the operational environment in sufficient time and detail to employ their forces effectively.

The IPB process and the intelligence cycle are the principal tools of situation development. IPB uses a series of templates (overlays) to portray hostile capabilities, vulnerabilities, and intentions. (See FMs 34-1 and 34-3 for more detailed discussions on the IPB process.) It also shows the effects of weather, terrain, the population, and allied forces on friendly courses of action. The ASIC performs the IPB and continually updates it by processing information through the intelligence cycle. In the future, automation of the group's intelligence data base will provide near-real-time intelligence products to support both situation and target development.

Because their operational environment allows little margin for error, SF teams must have detailed information about the operational area before they deploy. SF area study is of three types: general area study, operational area intelligence, and area assessment.

General area study provides the broad background knowledge of an area, region, or country. Each

uncommitted SFOD periodically performs a general area study to orient its members on potential operational areas. With ASIC support, the group and battalion ASTs manage the unit area study program and assist the SFODs with their general area studies. Appendix I provides a sample outline for a general area study.

Operational area intelligence is the detailed intelligence of a designated JSOA. The group and battalion ASTs maintain libraries of approved SOMPFs. With ASIC support, they continually review and update TIPs to provide the latest operational area intelligence to SF teams. Once an SF team deploys, the supporting AST continues to search for intelligence of interest to the SF team. The AST also monitors RFI submitted by the deployed SF team, and ensures timely answers to the team's questions.

Area assessment is a continuous process that confirms, corrects, refutes, or adds to previous intelligence gained before infiltration. By conducting an area assessment, a deployed SF team continually adds to its knowledge of the JSOA. The SF team begins its area assessment as soon as it enters its operational area. The area assessment serves as the basis for the commander's estimate of the situation. He uses it to modify plans made during isolation. The SF team transmits the results of the area assessment to its operational base only when there is new intelligence that differs significantly from that received before infiltration. There is no rigid format for making an area assessment, but the area study outline at Appendix I provides an excellent guide.

Target Development

Target development depends on situation development. It provides targeting data and correlated

targeting information to support the SO targeting process described in Chapter 7. In addition to developing targets nominated by the theater CINC and his component commanders, SF group and battalion commanders also participate in the target nomination process. They use target development

to select targets and target sets for nomination through the SOC to the JTB.

The current deliberate targeting process emphasizes fixed targets. However, most wartime targets are mobile. They move frequently and disperse to avoid detection and to enhance survivability. The redundancy built into modern combat systems makes it difficult to identify critical nodes for attack. Only the cumulative effect of multiple attacks on such systems can achieve significant results.

Conventional targeteers approach this dilemma with the mind-set of a hunter. They seek out and acquire targets and then task weapon systems to attack them. SF teams do not have the mobility or responsiveness needed to use this approach against mobile targets. Instead, SF targeteers must approach their task with the mind-set of a trapper. They must —

- Identify what mobile targets they want to attack.
- Anticipate the movements of those targets.
- Determine where to place SF teams to create a network of traps with the greatest chance of success.

SF targeteers in the ASIC begin this process by analyzing hostile combat systems and developing generic target data that describe how to disrupt each system by attacking critical nodes or components. The targeteers use the IPB process (situation and event templating) to determine—

- **Where** these components are most likely to be.
- **When** the theater CINC is most likely to want each combat system disrupted.

The product of this process is not a series of individual targets but a network of box-lie JSOAs. This network provides the SOC commander with a menu of SF targeting options. The options represent branches or sequels of the SF group's basic OPLAN. The SOC commander determines which options to execute, and when to execute them, as the actual situation develops. During mission execution, SF teams deploy to planned JSOAs. Guided by the generic target data, near-real-time operational area intelligence, and JTB target priorities, deployed SF teams attack those critical mobile targets that actually enter their JSOAs. The cumulative effect of their tactical successes will have an operational impact at theater level.

Electronic Warfare

EW is a shared responsibility of the S2 S3, signal officer, and MI detachment commander. EW can be either defensive or offensive in nature.

Defensive EW, or ECCM, protect friendly C2 systems. ECCM include such passive procedures as emission control and terrain masking. They also include the immediate identification and reporting of meaconing, intrusion, jamming, and interference (MIJI) on a friendly command, control, and communications (C3) facility. The signal officer has staff responsibility for ECCM. However, ECCM are the responsibility of every soldier who uses or supervises the use of communications and noncommunications emitters.

Offensive EW exploits or disrupts hostile C2 systems. There are two types of offensive EIM electronic countermeasures (ECM) and electronic warfare support measures (ESM).

ECM systematically disrupt hostile C3 systems by jamming and deception. Jammers can also prevent hostile intercept of friendly communications by jamming known hostile SIGINT systems on the same frequency. The S3 has staff responsibility for ECM. The SF group has a very limited tactical jamming capability. It relies primarily on theater systems to provide ECM support for its operations. The S3 EW officer (normally an additional duty) plans and coordinates this support.

ESM intercept, identify, and locate hostile emitters. ESM provide information required for ECM, ECCM, targeting, and combat operations. The S2 has staff responsibility for ESM. The SOTs A of the

battalion MI detachment provide an organic SIGINT/ESM capability to the SF group. The SF group commander controls EW operations through the group MI detachment commander and the group TCAE. The group TCAE translates each EW mission tasking into a technical tasking and forwards it to the appropriate battalion TCAE. The battalion TCAE tasks a SOT A to execute the mission. If no deployed SOT A is capable of collecting the information, the battalion S3 commits and deploys a SOT A to perform the tasking.

Because of its small size, a SOT A is incapable of conducting independent operations in a hostile environment. The battalion commander normally attaches a committed SOT A to an SF team and

assigns responsibility for all but the technical aspects of the mission to the SF team commander. The SOT A may infiltrate to join a deployed SF team, or the SF team and its attached SOT A may isolate, prepare, and deploy as a single element. In either case, the SF team provides security, CSS, and other mission support to the SOT A. The SOT A leader provides technical advice to the SF team commander. The SOT A leader is responsible for the technical aspects of mission execution. The SOT A transmits its collected information to the battalion TCAE for decryption, processing, analysis, and dissemination. The TCAE forwards the information through the group TCAE to the group CM&D section and the TA TCAE.

Counterintelligence

CI detects, evaluates, counteracts, or prevents hostile intelligence collection, subversion, sabotage, or terrorism. The organic group and battalion CI sections primarily perform CI analysis in the ASIC. SF commanders normally receive their CI investigative, special operations, and technical (for example, technical support countermeasures and counter-SIGINT operations) support from the supporting CI unit of the TA MI brigade. (See FMs 34-60 and 34-60A for detailed discussions of CI investigative, operational, and technical support.)

The CI section is the CI analysis element (CIAE) of the ASIC. It conducts multidisciplinary analysis to support ASPS situation and target development. It also develops detailed assessments of hostile intelligence and security threats near SFOBs and in JSOAS. These hostile threat assessments are critical to the group's OPSEC, deception, and base defense programs. The CIAE compares its threat data base with the friendly force profiles provided by S3 OPSEC personnel to determine actual friendly vulnerabilities. The CIAE then recommends appropriate OPSEC measures to reduce these vulnerabilities. To the extent possible, the CIAE

evaluates the effectiveness of those measures that are implemented.

The CI section briefs deploying SF teams during mission preparation on the latest threat data. It also provides SF teams with technical advice and assistance to prepare them to establish and operate defensive source nets during long-term UW and FID missions.

The CI section supports SF deception operations by determining hostile vulnerabilities to deception. It provides the S3 with recommendations for deception measures and evaluates their effectiveness through CI analysis. It may also request that the supporting CI unit conduct offensive tactical CI operations to evaluate the hostile reaction to friendly deception operations.

When directed, the SF group's CI teams may participate in CI tactical agent operations. They may conduct CI investigations of suspected sabotage, subversion, and espionage activity directed against the SF group. They may also deploy with the group's interrogation teams to conduct CI interrogations and debriefings of line crossers, refugees, informants, and repatriated friendly personnel. These activities must be specifically authorized under the provisions of AR 381-20 and other applicable regulations and directives.

CHAPTER 14

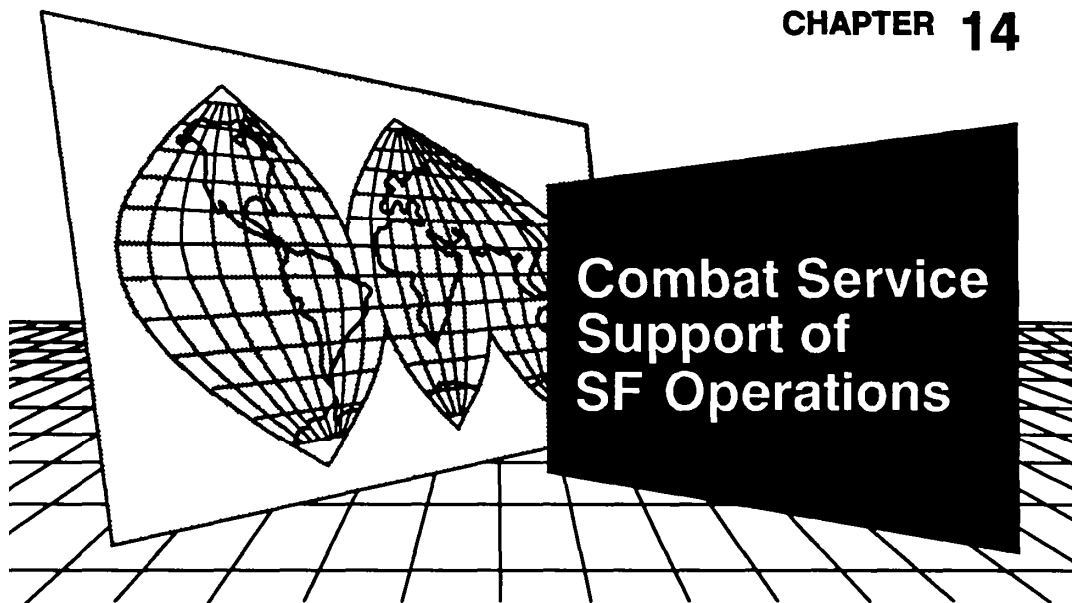

The SF group is part of the TA and depends on the TA CSS system to sustain its operations. In some theaters, an SF group or battalion may instead depend on the CSS system of another service. This chapter describes how the internal SF CSS system interacts with the TA CSS system to meet SF requirements. When being sustained by another service, the SF commander and his logisticians must modify Army doctrine to conform to the CSS procedures existing in the theater.

Theater Army

The TA is responsible for supporting assigned US Army forces and, if directed, other US services and allies in a theater. A theater is organized into a combat zone and a COMMZ. The combat zone begins at the rear boundary of the senior combat echelon in the theater (normally a corp or field army) and extends to the forward limit of the theater commander's area of operations. The COMMZ extends rearward from the combat zone rear boundary and includes the area necessary to support forces in the combat zone (Figure 14-1).

The TA has two types of support organizations in the COMMZ. TAACOMs provide CSS and designated CS on an area basis to forces passing through or located in the COMMZ. They have area responsibility for rear operations in the COMMZ. TA functional commands provide specialized support (such as personnel, engineer, transportation, and medical) to forces throughout the TA's AOR.

Two TA agencies are key to the command and control of these organizations. The TAMMC provides centralized management of most supply and maintenance operations. It serves as the primary TA link with the CONUS sustaining base. The theater

army movement control agency (TAMCA) provides theaterwide movement management and control of transportation assets.

The TASOSC is the TA functional command responsible for planning and coordinating CSS to theater ARSOF. The TASOSC and SF group staffs cooperate to identify and prioritize SF CSS requirements. The TASOSC staff then plans and coordinates with the other TA subordinate commands to meet those requirements by a combination of—

- Earmarking TA (or other service) resources for support of or attachment to SF groups or battalions.

- Arranging for foreign nation support.
- Submitting MTOE or TDA changes to augment the organic SF support companies.

MYTH: SF requires its own dedicated logistics system to meet its mission-peculiar requirements.

FACT: Normal Army CSS organizations and procedures are adequate for the bulk of SF requirements. Non-standard procedures are in place to handle the few requirements that are truly SF-peculiar.

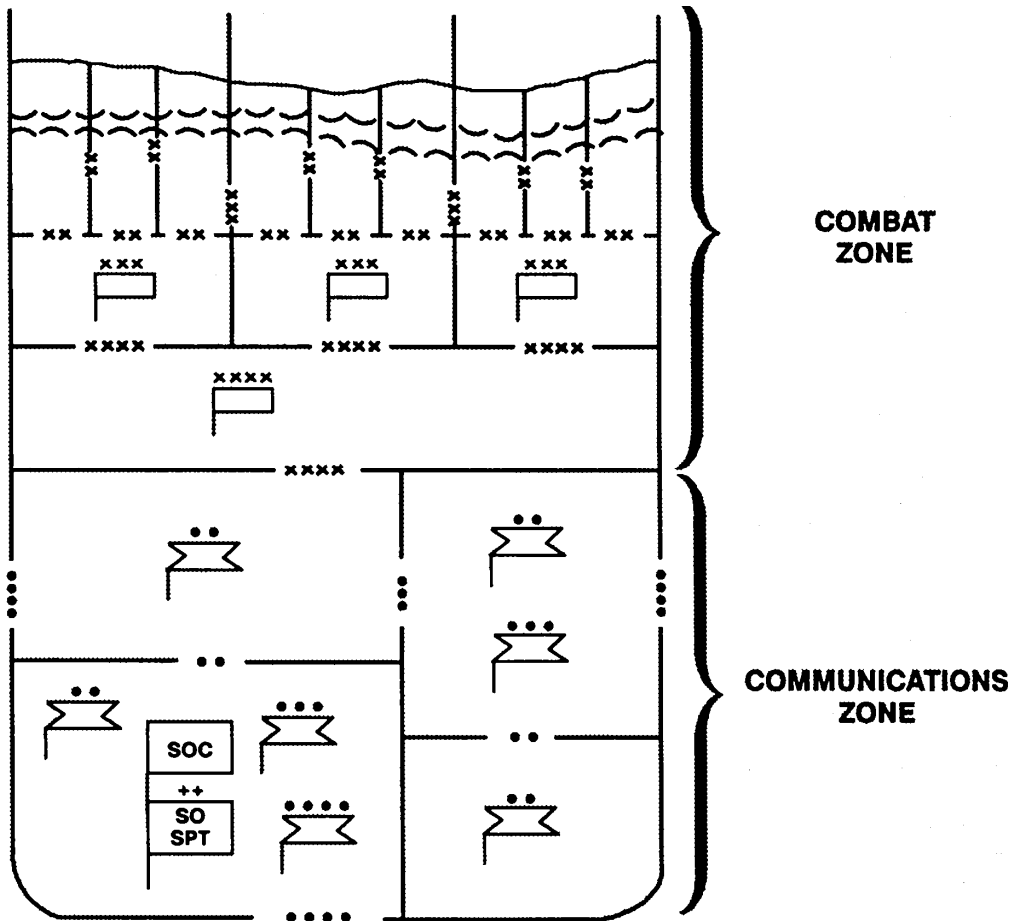

Figure 14-1. Type Theater Army Organization.

Combat Service Support at the SFOB and FOB

SF CSS planners and operators apply their knowledge of conventional CSS operations to meet the specific CSS requirements generated by SF units. The SF sustainment imperatives in Figure 14-2 apply to most SF operations. (FM 100-10 is the Army's capstone manual for CSS operations.)

The SFOB and FOB support centers provide or coordinate CSS on a unit-support basis for all elements assigned or attached to their respective bases. This CSS normally includes—

- Requisition, receipt, storage, and distribution of all classes of supply.
- Procurement of nonstandard supplies and items of materiel.
- Bath facilities, laundry, and clothing exchange.
- Graves registration (GRREG) service.
- Production and/or distribution of potable water.
- Unit and DS maintenance for all wheeled vehicles, power generation equipment, signal

equipment, diving and marine equipment, and small arms.

- Aviation unit maintenance (AVUM) and aviation intermediate maintenance (AVIM) for assigned aircraft.
- Limited GS maintenance for SF-peculiar materiel.
- Airdrop equipment rigging, supply, and repair.
- Salvage collection.
- Transportation service.
- Health service support.
- Personnel service support.

The SF group and battalion support companies may require MTOE or TDA augmentation to provide CSS support during sustained operations. This is especially true when—

- The SFOB and/or FOBs are established in undeveloped theaters in support of contingency operations.
- The SFOB and/or FOBs are not established at fixed facilities.
- A high percentage of SFODs are committed simultaneously.

- Maximize use of FNS, to include local and third country supplies, services, and other resources.
- Maximize use of existing fixed facilities.
- Limit CSS requirements to mission essentials.
- Minimize handling of supplies.
- Concentrate maintenance efforts on returning major end items to service.
- Rely on air lines of communication (ALOC) for rapid resupply.
- Maximize use of accompanying supplies, pre-positioned stocks, and preplanned resupply packages.
- Anticipate high attrition during resupply missions into denied territory.
- Identify to the TA as early as possible those low-density items that require operational readiness floats or other special logistical arrangements.

Figure 14-2. SF Sustainment Imperatives.

Sources of Supply

The SF group draws its supplies from a variety of sources. The relative importance of each source is theater-dependent. SF commanders must anticipate their logistical requirements. They must then coordinate with their supporting TASOSC to determine which source of supply can best meet their needs. Among these sources of supply are—

- Pre-positioning of materiel configured to unit sets (POMCUS).
- Operational project stocks.
- War reserve materiel stocks.
- Foreign nation support.

POMCUS

Some SF units have Department of the Army authorization to receive POMCUS equipment when they deploy from CONUS to their theaters of operation. The TA usually stores and maintains this equipment in the vicinity of the unit's proposed SFOB or FOB. Deploying units must determine existing POMCUS shortages before deployment and deploy with those items as well as with those items not authorized for pre-positioning. Units should update their deployment plans upon receipt of their annual POMCUS authorization document.

Operational Project Stocks

SF units use operational project stocks to obtain required supplies and equipment above their normal allowances (MTOE, supplemental TDA, levels authorized by AR 11-11, and special letters of authorization) to support contingency operations and war plans. These stocks include supplies and equipment for operations in extreme environments and for the sustainment of indigenous forces. They may also include supplies and equipment that SF units clandestinely cache in potential operational areas to support stay-behind operations.

The TASOSC establishes and maintains non-POMCUS operational project stocks to support ARSOF operations. The theater CINC may also establish and maintain operational project stocks to support joint SO. Operational project stocks are restricted to the minimum essential types and quantities of supplies and equipment required to successfully execute the total plan or a prescribed portion of the plan. Stocks normally include only standard items listed on the war reserve stockage list (WRSL). The SF group commander must justify the inclusion of nonstandard items in project stocks. (AR 710-1 delineates the procedures for requesting and establishing operational projects.)

War Reserve Materiel Stocks

The TASOSC commander, in coordination with the SF group commander, should attempt to obtain adequate pre-positioned war reserve materiel stocks (PWRMS) in the theater and fill shortages in existing war reserve materiel stocks (WRMS). Alternatives include—

- PWRMS afloat adjacent to the theater of operations.
- PWRMS in a third country support base (TCSB).
- WRMS in tailored packages for deployment with the SF group.

Foreign Nation support

FNS is the preferred means to meet unresourced CSS requirements, within acceptable risk limits. It can include almost every aspect of CSS. Foreign personnel and organizations can perform many CSS functions as well as or better than their US counterparts. The SF group commander, in coordination with the TMOSC commander, must determine the functional types and levels of FNS he can accept without unduly jeopardizing OPSEC and mission accomplishment. The TASOSC Director of Logistic (DOL) provides the SF group S5 with points of contact (POCs) of specific foreign nation agencies or organizations providing support in the theater.

Developed Theater Logistics

In a developed theater, the theater sustainment base is established. PWRMS and operational project stocks are in place. FNS agreements exist. The following paragraphs outline how a SPTCEN in a developed theater performs its four logistics functions: supply, field services, maintenance, and transportation.

Supply

The service detachment's supply and transportation section requests, receives, and stores standard Class

I, II, III, IV, VI, and VII supplies (Figure 14-3) from the supporting DS supply and service company in the TAACOM area support group (ASG). All these classes of supply (except bulk Class III) are demand items. The using unit submits a request through the service detachment to the direct support unit (DSU). The DSU either fills the request from its existing stocks or forwards the request to its supporting general support unit (GSU). The DSU uses a combination of supply point, unit, and throughput distribution. When fixed or mobile post exchanges are unavailable, the supply and transportation section requests and receives Class VI ration supplement sundry packages the same way it does Class I supplies.

SUPPLY CLASS



Subsistence items and gratuitous-issue health and welfare items.



Items of equipment, other than major end items, that are prescribed in authorization and allowance tables, such as individual equipment, military clothing, tools, tentage, and housekeeping supplies.



Petroleum fuels, oils, and lubricants.



Construction and barrier materials.



Ammunition, including chemical and nuclear ammunition.



Personal demand items that are normally sold through the exchange system.



Major end items that are ready (assembled) for intended use, such as vehicles, aircraft, and weapon systems.



Medical supplies and equipment.



Repair parts and components, including kits and assemblies.



Material required to support nonmilitary programs.



Items that do not fit into one of the ten classes above, such as water, maps, captured enemy materiel, and salvage material.

DESCRIPTION

Figure 14-3. Classes of Supply.

Bulk Class III is a scheduled item. Based on input from the battalions, the SF group S4 forecasts unit requirements through logistics channels to the TAMMC. Based upon fuel availability and unit priorities, the TA Deputy Chief of Staff for Logistics (DCSLOG) and TAMMC develop a distribution plan to allocate fuel to subordinate units.

The supply and transportation section requests and receives nonstandard SF-peculiar items through the TAMMC. The TAMMC fills the request from theater or TA operational project stocks or (in the case of certain non-DOD items) obtains the items through the SOC J4.

The supply and transportation section requests, draws, and stores conventional Class V supplies from the supporting ammunition supply point (ASP). The ASP is operated by an ordnance conventional ammunition company of the TA ammunition group. It uses supply point distribution. Class V supply is scheduled, not demanded. Based on input from the battalions, the SF group S3 must determine the group's operational requirements (primarily the UBL and required supply rate [RSR]) and submit them through operational channels for approval and allocation by the TA Deputy Chief of Staff for Operations and Plans (DCSOPS). Based on guidance from the TA DCSOPS, the TA DCSLOG and TAMMC allocate scarce Class V items by computing a controlled supply rate (CSR). Once the SF group commander receives his Class V allocation, he sub-allocates it among his subordinate elements. Based on these suballocations, the SF group and battalion S3s approve unit Class V requests before the S4s can fill them.

The group or battalion medical section requests and receives its normal Class VIII supplies from the supporting DS medical treatment facility (MTF) of the TA medical command (MEDCOM). The MTF uses a combination of unit and supply point distribution. Class VIII resupply is demanded. The using unit submits its request to the medical supply sergeant. He forwards the request through medical channels to the MTF. The MTF either fills the request from its existing stocks or forwards the request to its supporting medical logistics (MEDLOG) unit. For bulk issue of Class VIII supplies to fill SF operational requirements, the

MEDCOM normally authorizes direct requests from the MEDLOG unit.

The service detachment's mechanical maintenance section requests, receives, and stores Class IX supplies from the supporting DS maintenance company in the ASG. The DSU uses supply point distribution. Class IX resupply is demanded. The using unit submits its request to the mechanical maintenance section. It forwards the request to the DSU. The DSU either fills the request from its existing stocks or forwards the request to the TAMMC.

The supply and transportation section receives and stores Class X supplies from the CA brigade supporting the TAACOM. The CA brigade uses a combination of unit, supply point, and throughput distribution. The using unit submits its request through the base S5. He forwards the request through CA channels.

The supply and transportation section obtains potable and nonpotable water from local sources using organic equipment. When water requirements exceed the local supply, the section requests and draws water from a water supply point established by the supporting DS supply and service company. The DSU uses supply point distribution.

The supply and transportation section requests and receives unclassified maps from the supporting DS supply and service company. The DSU obtains its unclassified maps from the appropriate TA map depot. Using units submit their requests to the S2, who consolidates them and forwards the request through supply channels. The S2 requests and receives classified maps and other classified intelligence products through intelligence channels.

lb meet their operational requirements during the transition to active operations and during unanticipated breaks in normal resupply operations, SF units maintain UBLs of Class I, II, III, IV, V, VIII, and IX supply items. Commanders should review these UBLs at least annually to ensure they adequately address current operational requirements. Commanders should also inspect their UBLs periodically to ensure they are being properly maintained, rotated, and secured, and that replacement supplies and equipment have been requested.

Field Services

Field services include GRREG, airdrop, clothing exchange and bath, laundry, bread baking, textile and clothing renovation, and salvage. GRREG and airdrop are primary field services because they are essential to the sustainment of combat operations. All others are secondary field services.

Whenever possible, SF teams sustaining fatal casualties identify the human remains and place them in human remains pouches. They then evacuate the remains to the service detachment for further evacuation to the supporting GRREG collecting point. If the remains are contaminated, they and the pouches should be so marked. When an SF team cannot evacuate its dead, it conducts an emergency burial and reports the burial to the group or battalion. The group or battalion S4 submits a record of interment through GRREG channels. Whenever possible, a unit chaplain or the SF team commander conducts an appropriate service to honor the dead.

The group and battalion rigger-air delivery sections do not have the capability to conduct sustained airdrop support for SF operations. The TAACOM airdrop supply company augments the group's organic capabilities by providing the group and battalion service detachments with dedicated support teams or by providing GS on a mission basis.

The SFOB and FOBs may not have fixed facilities or civilian contractors to provide secondary field services. In this situation, the supporting DS supply and service company provides these services as soon as the situation permits.

Maintenance

The service detachment's mechanical maintenance section performs consolidated unit-level maintenance of wheeled vehicles and power generation equipment. It also performs vehicle recovery. The signal detachment's electronic maintenance section performs consolidated unit- and DS-level maintenance of signal equipment. It also performs limited GS maintenance on SF-peculiar signal equipment. Unit armorers perform decentralized or consolidated unit-level maintenance of small arms.

When the required maintenance on an item of equipment exceeds unit capabilities, the mechanical

maintenance section or, electronics maintenance section evacuates it to the supporting DS maintenance company or requests on-site repair by a mobile maintenance support team from that company. The DS maintenance company performs DS maintenance to return unserviceable equipment to the user. It evacuates to intermediate GS maintenance units those items it cannot repair. It also provides direct exchange service and maintains a limited operational readiness float (ORF).

There are exceptions to these procedures. The rigger-air delivery section evacuates unserviceable airdrop equipment to the TAACOM airdrop equipment repair and supply company. The medical section evacuates unserviceable medical equipment to the supporting DS MTF or MEDLOG unit. The group aviation platoon evacuates unserviceable aircraft and components to the TAACOM AVIM company.

For those items of SF-peculiar equipment that the Army maintenance system cannot repair, the SF group must rely on civilian specialists and technicians (US, HN, or third country) and on SF personnel who have attended civilian maintenance training. Such equipment may require evacuation to CONUS for repair at the manufacturer or other selected facility.

Transportation

The service detachment commander is primarily concerned with transportation mode operations (air, motor, rail, and water transport). The supply and transportation section provides the trucks to support supply point distribution and other normal CSS activities. However, it does not have dedicated drivers for these trucks. The base commander may organize a provisional transportation section by assigning dedicated drivers to these trucks. The TA transportation command (TRANSCOM) may attach appropriate motor and water transportation assets to the support company for abnormal CSS operations. Otherwise, TRANSCOM supports abnormal transportation requirements on a mission basis with its GS assets. The unit S4 coordinates for TRANSCOM support through the regional movement control team (RMCT). When the SFOB and FOB(s) are serviced by the same RMCT, the RMCT may require the group S4 to consolidate support requests.

Developed Theater Personnel Service Support

PSS consists of five related areas: personnel management, public affairs, legal services, finance services, and religious support. SF units plan and conduct most PSS using standard Army systems and procedures. SF group and battalion S1s deal directly with their supporting personnel service company (PSC). When the SFOB and FOB(s) are serviced by the same PSC, the PSC may require the group S1 to consolidate reports.

There are three critical military personnel activities that directly support SF operation strength management, casualty reporting, and replacement operations.

Strength management determines personnel replacement requirements and influences personnel cross-leveling and replacement distribution decisions. The group and battalion S1s use the deliberate Army personnel accounting and strength reporting system to maintain the unit's personnel data base. They forward their daily personnel summaries and personnel requirements reports to the supporting PSC. The battalion S1s provide copies of their reports to the group S1 so that he can prepare a consolidated report for the SF group commander and forward information copies to the SOC J1 and TASOSC Director of Personnel and Administration (DPA). The supporting PSCs use these reports to submit requests for individual replacements to the TA personnel command (PERSCOM).

The Army's casualty management system provides Headquarters, Department of the Army (HQDA), with information used to notify next of kin and support appropriate casualty and survivor assistance programs. By-name casualty accounting and reporting has far-reaching effects on the morale of the military and civilian populace and the image of the Army. Casualty reporting must be 100 percent accurate, even at the expense of speed of reporting. Nevertheless, reporting should be as rapid as the situation permits. The losing SF unit submits casualty feeder reports and, if required, witness statements to the battalion or group S1. The S1s consolidate

casualty reports and forward them to the supporting PSC. They manage open cases (for example, soldiers missing in action) until final disposition is made and prepare letters of sympathy for the appropriate commander. The PSC verifies and reconciles the information before initiating a formal individual casualty report. The battalion S1s provide information copies of all by-name casualty reports to the group S1.

SF replacement operations involve the receipt, processing, and allocation of individual and small unit (SFOD) replacements. The SF group obtains its individual replacements from the supporting PERSCOM using normal replacement procedures. The SOC commander coordinates with the TASOSC commander to establish priorities of personnel fill. The SPTCEN director receives, billets, and provides messing for replacements. The S1 and CSM distribute replacements based on the base commander's priorities. The appropriate AST isolates and orients replacements for deployed SFODs until the ISOFAC director certifies them as prepared for infiltration.

The SF group S3 requests small unit replacements (SFODs) through the TASOSC DPO. The TASOSC DPO arranges an intratheater transfer of SFODs or coordinates to obtain SFODs from CONUS. Once the SFODs arrive at the gaining operational base, they are assigned to the SPTCEN as uncommitted detachments until the SPTCEN director certifies them as operationally ready for a mission.

Postal operations move, deliver, and collect personal and official mail. A DS postal platoon normally collocates with the supporting PSC. The group and battalion S1s establish internal procedures to collect and deliver mail. These procedures must include provisions for redirecting the mail of deceased, missing, and evacuated personnel. The S1s must also make provisions for deployed SF personnel who cannot receive or send mail for operational reasons.

Finance operations provide normal finance support to SF personnel. They also provide the operational funds that SF teams may require to execute their missions. A finance support unit (FSU) normally collocates with the supporting PSC to provide the full range of finance services. These services normally include special mission fund accounts, intelligence

contingency fund accounts, foreign currency operations, and commercial accounts. The group budget officer, in coordination with the supporting FSU commander, establishes procedures for SF

teams to obtain and account for operational funds. Each SF officer entrusted with government funds must fully understand what payments are authorized and how to account for each transaction.

Developed Theater Health Service Support

Each SF group and battalion surgeon establishes and operates an SFOB or FOB dispensary capable of providing routine and emergency Level II medical and dental treatment to assigned and attached personnel. Medical section personnel in the dispensary also provide sustainment training for combat lifesaver personnel and SF medics.

NOTE: Class II medical treatment is routine and emergency care designed to return the patient to duty or prepare him for evacuation to the supporting MTF for resuscitative surgery (Class III) or to a hospital for definitive and restorative care (Class IV).

The SFOB and FOB dispensaries provide preventive medicine services. These services include pest control, water quality surveillance, immunization and drug prophylaxis activities, and the general surveillance of military environments to identify actual or potential health hazards. SF preventive medicine specialists train and provide technical supervision of

unit field sanitation teams. They can also participate in military civic action programs.

The SFOB and FOB dispensaries provide veterinary services. These services include food quality assurance inspections, dining facility sanitary inspections, and health services to military animals. SF veterinary specialists assist in the unit preventive medicine program. They can also participate in military civic action programs.

The TASOSC health service section, in coordination with the group surgeon, coordinates TA HSS for the SFOB and FOBs. The TA MEDCOM designates supporting MTFs and provides the SFOB and FOB dispensaries with-

- Medical evacuation capability.
- Additional preventive medicine, veterinary, and dental support.
- Medical laboratory services.
- Hospitalization.
- Medical intelligence.
- Medical supply and equipment maintenance.

Undeveloped Theater CSS

An undeveloped theater does not have a significant US theater sustainment base. PWRMS, in-theater operational project stocks, and FNS agreements are minimal or nonexistent. When an SF unit deploys

into an undeveloped theater, it must bring sufficient resources to survive and operate until the TA establishes a bare base support system and/or makes arrangements for HN and third country support. The bare base support system may function from CONUS, afloat (amphibious shipping or mobile sea bases), or at a TCSB. It will probably rely heavily on strategic airlift and/or sealift for resupply.

CCS Options

Deployed SF units in an undeveloped theater may have to bypass normal CSS echelons. They may maintain direct contact with their parent units in CONUS, or they may requisition directly from the CONUS wholesale logistics system. They may rely on TASOSC contracting and CA expertise to obtain FNS. In practice, the solution may be some combination of all three options.

Support Relationships

The TASOSC commander should arrange habitual support relationships between the SF group and the TA elements providing its support package. The support package should be provisionally organized as a composite support battalion or company, so that the group commander does not have to deal with a collection of teams, detachments, and companies without a parent control headquarters.

Supply

Normal basic loads are inadequate for SF operations in an undeveloped theater. For example, an SF unit may have to deploy with 30 days of supply (15-day order-ship time, 10-day operating level, 5-day safety level). Because this quantity of supplies exceeds the SF group's capacity to move and store them, the group and battalion S4s normally divide these loads into accompanying supplies and preplanned follow-on supplies. Accompanying supplies are normally limited to the unit's basic and prescribed loads, plus additional Class I, III, and V supplies critical to the operation. The group and battalion S3s must include accompanying supplies in all their predeployment load planning.

Supply procedures for most classes of supply vary in an undeveloped theater. Except for field rations, the SF group may rely heavily on local contract support for fresh Class I supplies and dining facility operation. To reduce demand on the CSS system, the SF unit may purchase Class II, III, IV, and VI supplies locally or from third party contractors. The SF unit normally receives Class V and IX supplies through the standard US system, but with greater reliance on ALOC. The SF unit may be authorized to stock low-density, high-dollar repair parts not normally authorized at unit maintenance level. Class VII

supplies may include a combination of military and commercial equipment from US and foreign sources. Replacement of unserviceable US military equipment depends upon the duration of the operation, theater GS repair capability, loss rates, and the availability of ORF or PWRMS. The SF unit may include water supply in an overall contract for custodial support of the SFOB and FOBs, or it may obtain water from local sources or from US water supply points.

Field Services

The SF group normally receives appropriate TA augmentation to perform the primary field services-GRREG and airdrop-until these capabilities become available in the COMMZ on an area basis. The SF group may contract for general custodial services, to include laundry, barber, and PX services. If laundry services are unavailable, the group S4 must arrange for clothing exchange through the standard US system.

Maintenance

The SF group commander must emphasize preventive maintenance checks and services in the extreme (tropical, arid, or arctic) environments that typically exist in undeveloped theaters. He may adjust the frequency of periodic services to assist in equipment readiness.

The SF group normally deploys with attached TA DS maintenance support teams. The group commander may contract for supplemental maintenance support of its Army and commercial equipment.

In an undeveloped theater, fixed repair facilities may not be available and the SF group may be authorized to perform repairs not normally performed at unit level. The SF group commander should review the MTOE to determine what additional tools; special tools; test, measurement, and diagnostic equipment items; and repair parts he needs to meet increased maintenance demands caused by dispersed operations in an undeveloped theater.

Transportation

Because undeveloped theaters typically have poor ground LOC, Army aviation units habitually deploy early to support CSS operations. If the SF group receives additional aviation assets in attachment, the group commander must ensure they include an

adequate maintenance support package. The SF group commander may contract for foreign transportation assets to meet his unresourced transportation requirements.

Personnel Service Support

PSS remains essentially unchanged in an undeveloped theater. The TASOSC DPA develops preplanned replacement packages to maintain SF

unit strength until normal replacement operations can begin.

Health Service Support

The SF group may have to deploy with an HSS package to provide dedicated support until normal TA health services are established. The group surgeon should consider the use of HN or third country medical facilities to augment the medical capabilities of the group and battalion medical sections.

Reconstitution

Reconstitution operations are specific actions taken to restore units that are not combat effective to the desired level of combat effectiveness. Reconstitution involves more than a surge in normal sustainment operations. The reconstitution decision is heavily influenced by unit and individual training, unit organization, and human factors that build cohesion and esprit. The commander two levels above the attrited unit makes the reconstitution decision. For example, the SOC commander, in consultation with the TASOSC commander, decides how to reconstitute an attrited FOB. The SFOB or FOB commander decides how to reconstitute an attrited SFOD.

Commanders have two reconstitution options: reorganization and regeneration. A commander can execute them separately, but most often executes them in combination.

Reorganization is the measures taken within an attrited unit to restore its own combat effectiveness. These measures include reestablishing command and control, cross-leveling resources between subunits, matching surviving weapons systems with surviving crew, and combining two or more attrited subunits to form a composite combat-effective subunit. The senior surviving member of an attrited unit assumes command and immediately begins

reorganization pending the reconstitution decision of higher headquarters.

Regeneration rebuilds an attrited unit through the large-scale replacement of personnel and materiel and the conduct of mission-essential training. Replacement personnel and materiel may come from redistributed resources reserves, or the resources of higher or supporting echelons.

When a commander determines that he cannot obtain the resources to restore an attrited unit to combat effectiveness, he may resort to redistribution as an alternative to reconstitution. Redistribution reduces an attrited unit to zero strength and transfers its remaining resources to other units. Redistribution is the least desirable option.

If the SOC commander decides that he cannot immediately restore the operational effectiveness of an SFOB or FOB, he must assign its mission to another SFOB or FOB until the TASOSC commander can regenerate the base or obtain a replacement unit from CONUS. Surviving assets of the attrited base may move to that base to augment existing SFOB or FOB assets. If the SF group commander decides that he cannot immediately restore the combat effectiveness of an attrited SFOD, he normally commits another SFOD to assume the mission. He may attach surviving members of the attrited SFOD to the new SFOD, particularly if the SFOD was operating in denied territory.

Resupply of SF Teams in the JSOA

An SF team, in coordination with the SFOB or FOB staff, determines the quantity and types of equipment and supplies with which it will infiltrate. The following factors influence the decision on accompanying supplies:

- Assigned mission and scope and duration of operations.
- Resistance force size, capabilities, logistical needs, and responsiveness to US control.
- Hostile capabilities.
- Availability of resources in the operational area.
- Method of infiltration.
- Operational posture (low-visibility or clandestine).
- Difficulty of repairing or replacing critical items in the operational area.

Based on the same considerations, the SFOB or FOB staff establishes supply levels for each class of supply in the JSOA and determines the sequence, method, and timing of delivery. Once deployed, the SF commander may recommend changes to the resupply schedule.

The SFOB or FOB schedules three types of resupply missions: automatic, emergency, and on-call. The SPTCEN service detachment requisitions and receives the supplies and equipment for these missions from theater or TA operational project stocks or war reserve stocks.

An automatic resupply replaces lost or damaged equipment and provides additional items that could not accompany the SF team during infiltration. Automatic resupply provides essential subsistence, training, and operational supplies to the SF team and its indigenous force on a prearranged schedule. It is preplanned as to delivery time, location, contents, and identification marking system and authentication. The SFOB or FOB delivers it automatically unless the deployed SF team cancels, modifies, or reschedules the delivery.

An emergency resupply contains mission-essential equipment and supplies to restore operational capability and survivability to the SF team and its indigenous force. An emergency resupply is preplanned like an automatic resupply. The SFOB or FOB delivers an emergency resupply when either of the following conditions exist:

- Radio contact has not been established between the deployed SF team and the SFOB or FOB within a predesignated time after infiltration.
- The deployed SF team fails to make a predetermined consecutive number of scheduled radio contacts.

An on-call resupply provides the deployed SF team with equipment and supplies to meet operational requirements that cannot be predicted or scheduled during mission preparation. On-call supplies are held in readiness at TAACOM depots or the SPTCEN for immediate delivery when the SF team requests them.

To ease handling and transportation within the JSOA, the SPTCEN service detachment normally rigs equipment and supplies in appropriate delivery containers weighing 500 pounds or less. The contents of each container are—

- Packaged in waterproofed and man-portable (50 pounds or less) loads.
- Marked with a prearranged code to identify contents.
- Fitted with carrying straps or mounted on packboards for easy transport.

SF uses the Catalog Supply System (a brevity code system) to expedite on-call resupply requests, ensure accurate identification of supply items, and minimize message length. The Catalog Supply System catalog lists equipment and supplies by class of supply. It groups associated equipment and supplies into convenient unit sets. It then assigns code words to each catalog item and set. The SOC J4, in coordination with the TNOSC DOL, prepares the theater supply catalog and configures operational project stocks into unit sets. The SOC J6 or TASOSC signal officer reproduces the catalog as an SOI item.

CHAPTER 15

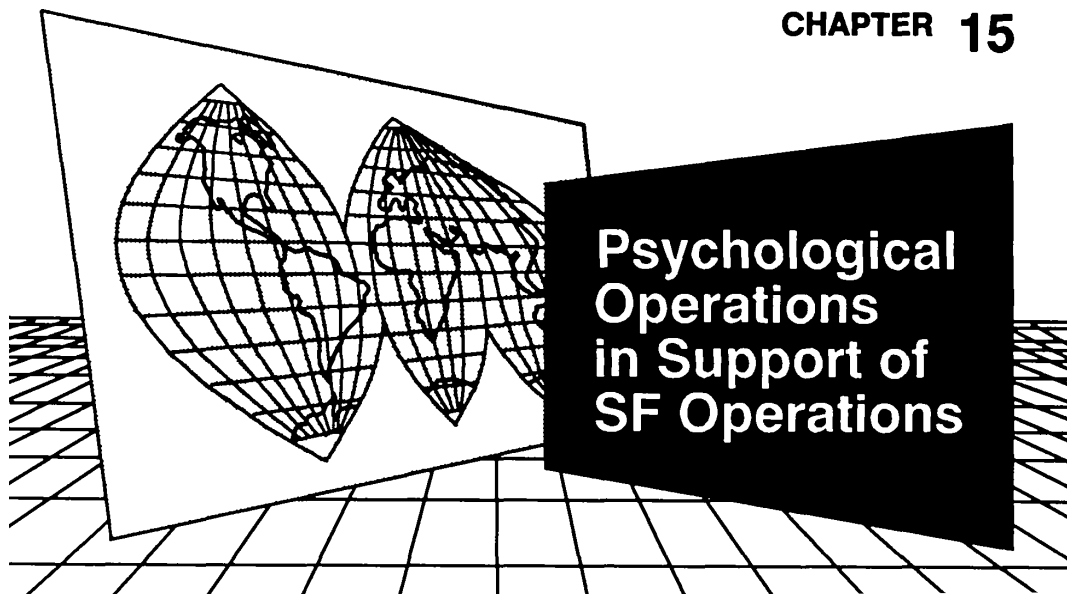

PSYOP are an integral part of all SF activities. The mere presence of SF has a psychological impact on the attitudes and behavior of foreign military forces and civilian populations. To develop desirable attitudes, official activities must be wisely conceived, and individual conduct must be sensible. This chapter focuses on PSYOP strategies that can achieve such attitudes and benefit SF operations. It also discusses PSYOP planning and employment considerations for SF missions.

PSYOP in a Conflict Environment

PSYOP are planned operations to convey selected information and indicators to foreign audiences to influence their emotions, motives, objective reasoning, and ultimately the behavior of foreign governments, organizations, groups, and individuals. The purpose of PSYOP is to induce or reinforce foreign attitudes and behaviors favorable to the originator's objectives. (See FM 33-1 for a detailed discussion of PSYOP.)

In a conflict environment, PSYOP take on an added significance. Modern conflict encompasses all spheres of national activity political, military, economic, social, and cultural. Noncombat activities can be as decisive in conflict as combat operations are in conventional warfare. Failure to engage properly on the noncombat fronts can mean defeat, regardless of the outcome of military operations.

Modern conflict is frequently a protracted politico-military struggle between political systems. All military, economic, psychological, and social activities are effective only insofar as they support the political

objectives. PSYOP serve as a major weapon in this politico-military struggle by—

- Building and sustaining belief and support for the friendly power's political system, including its ideology, infrastructure, and political programs.
- Attacking the legitimacy and credibility of the hostile power's political system.
- Mobilizing popular support for military, paramilitary, security, and intelligence operations.
- Mobilizing popular support for political, social, and economic programs.

- Publicizing anticipated reforms and programs to benefit the populace once the hostile power is defeated.
- Shifting the loyalty of hostile forces and their supporters to the friendly power.

In a conflict environment, the initial and primary PSYOP operator is the individual SF soldier. He must understand that there is more to PSYOP than loudspeakers and leaflets. He must be able to use individual and group motivation, perception management, cross-cultural communications, and similar PSYOP techniques to influence foreign audiences in his daily face-to-face-contacts.

PSYOP Planning

PSYOP are particularly important to SF. SF units often cannot accomplish their mission without the support of foreign military or paramilitary forces and the indigenous population. The earlier PSYOP personnel advise and assist SF units in mission planning, the greater the chances of success. PSYOP personnel advise and assist SF units in obtaining and sustaining the support of the neutral and uncommitted segments of a foreign power. They develop and execute PSYOP that support SF objectives and exploit hostile vulnerabilities in the operational area. They design PSYOP for deployed SF teams to execute. They recommend and plan such actions as civil disobedience, rallies, and demonstrations that degrade or neutralize hostile influences on the target audiences. They also review SF plans to identify potentially adverse effects on target audiences that could affect mission accomplishment. PSYOP personnel train SF soldiers in the customs they must honor in the operational area to avoid offending the indigenous population. They identify influential population segments (clans, tribes, and sects, for example) that may

affect the mission. They also provide basic and special PSYOP assessments that add to the overall intelligence effort in the operational area.

PSYOP planners also advise SF commanders and their staffs on the psychological impact of military operations on target audiences within the operational area. For example, PSYOP personnel can advise an SF team in a denied area where the local populace may turn the team into the authorities because of reprisals or economic disruptions. During target assessments of bridges, electric grids, and similar targets of economic or social significance, PSYOP personnel can assist in determining the impact on local support.

An SF commander can make an operation more effective if he determines its probable psychological impact in advance and then exploits it during the operation. Any operation has the potential to produce a negative psychological impact on the population. PSYOP advisors should evaluate past combat operations (conducted by US forces, SOF-trained forces, or allied forces) that have created a negative psychological impact to determine what factors were at fault so they can be avoided in future operations. Other operations, such as civic action programs, have a positive psychological impact.

These operations create goodwill with the local populace that can be exploited in future operations. SF planners should consider the psychological impact of the following four factors:

- Impact of noncombatant casualties.

- Permanent presence of hostile security forces in populated areas.
- Relationship between hostile security forces and civilian populace.
- Effects of combat operations on morale of friendly and hostile forces.

PSYOP Organization for Special Operations

The SOC integrates all PSYOP support of joint SO. PSYOP elements that support a SOC may function under varied C2 arrangements. The exact organizational structure is determined by the mission, the resources available, and the prerogatives of the SOC commander. The SOC commander normally decentralizes his PSYOP assets to subordinate SO elements (Figure 15-1).

At SF group level, a tailored PSYOP detachment normally supports SF requirements under the staff supervision of the organic PSYOP staff officer. The group PSYOP detachment comes from the theater PSYOP force, normally the EAC PSYOP group assigned to TA. It normally includes capabilities for target analysis, propaganda development, and limited media production. The group PSYOP detachment does not normally have its own strategic dissemination means. When conducting battlefield or consolidation PSYOP, it may have its own tactical dissemination means. The detachment forwards requirements beyond its organic capabilities through the SOC PSYOP staff element to the theater PSYOP force. The theater PSYOP force provides GS capabilities that include—

- The PSYOP group's research and analysis company (target analysis and propaganda development) and strategic dissemination company (radio, print, TV).

- The PSYOP battalion's operational support company (target analysis, propaganda development, counterpropaganda, interrogation and debriefing, print, audiovisual, loudspeaker).

Tailored DS PSYOP elements may also support SF requirements at SF battalion level and below. The PSYOP element commander serves as PSYOP staff officer to the supported SF commander. The element may range in size from a small two-man team supporting a deployed SF team, to a three- to eight-man PSYOP assessment team, to a fully operational support detachment similar to that normally found at SF group level. These PSYOP elements, whatever their size, have access to the support capabilities of a larger PSYOP unit. For example, a two-man PSYOP team deployed with an SF team can send requests back to its parent PSYOP unit for assistance in developing themes, messages, and media products for use in the operational area. The parent PSYOP unit can also integrate these themes and messages into strategic PSYOP such as radio or TV broadcasts into the operational area.

During mission preparation, the SF commander should request a PSYOP assessment team to determine what PSYOP assets are necessary to support the mission. The SF commander may have to limit the size of the team. The supporting PSYOP unit commander then organizes the team with the correct mix of PSYOP personnel, subject to personnel constraints.

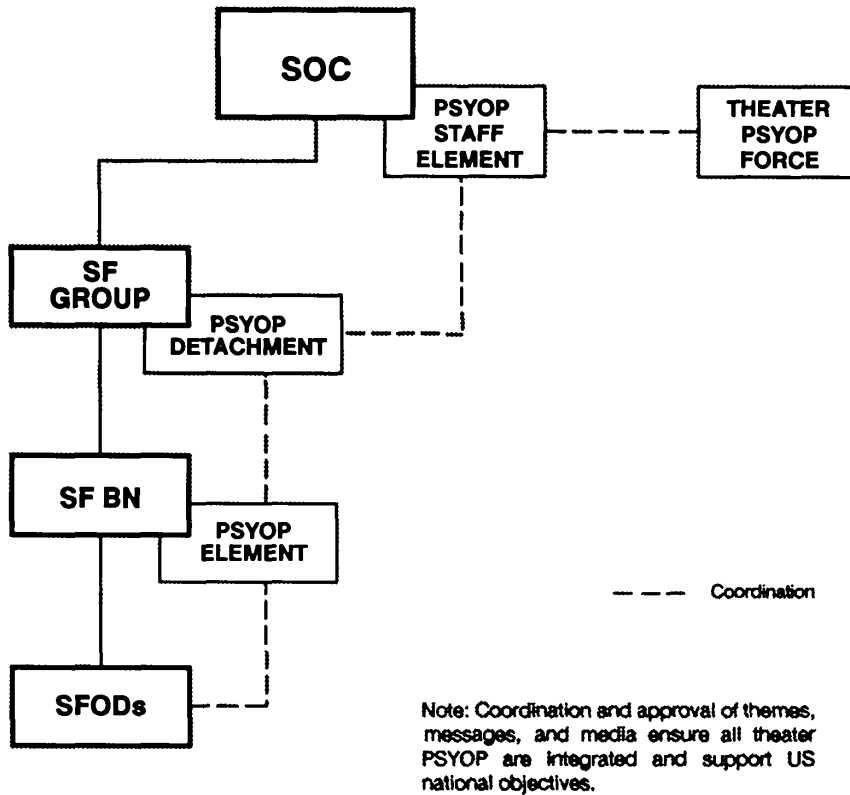

Figure 15-1. A Type Organization for PSYOP Support of SF Operations.

PSYOP Area Assessment

Committed SF teams should request a PSYOP assessment of their operational area. At a minimum, this assessment will include information about all major target audiences. Deploying SF teams

should also request a copy of the current basic PSYOP study concerning their operational area. A basic PSYOP study addresses in detail the political, military, economic, and social situation in a given area. PSYOP units can also develop special PSYOP studies for specific situations or operational areas. These PSYOP assessments and studies are also useful for general area study and IPB.

PSYOP in Support of UW

A resistance organization plans and conducts PSYOP in support of its own needs and objectives. The SF team and its PSYOP advisors must convince the resistance leadership to support US national PSYOP objectives in the region. They must also persuade the leadership to support themes and messages developed at the supporting operational base. In addition, the SF team must convince the resistance leaders to conduct PSYOP that create popular support for the resistance organization, both in and out of the JSOA.

By their presence in a particular country, SF teams serve as tangible evidence of US interest and support. Through daily face-to-face meetings with local leaders, SF soldiers strengthen mutual respect, confidence, and trust. They gain valuable insights into the problems of the resistance organization. They also improve rapport by sharing the same living and fighting conditions. These shared associations and mutual respect promote a favorable climate to conduct UW operations. However, SF soldiers must avoid identifying so closely with the resistance organization that they ignore US interests and objectives.

Deployed SF teams and their PSYOP advisors train, advise, and assist the resistance organization in target analysis, media selection, and propaganda development. Conventional PSYOP techniques are equally applicable during UW operations. However, PSYOP personnel must be aware of those UW employment considerations that differ significantly from conventional PSYOP employment (Appendix J). There are normally four major UW target audiences that PSYOP must address: the uncommitted, hostile sympathizers, hostile military forces, and resistance sympathizers.

The general population may initially be neutral or actively oppose the resistance organization because of fear or uncertainty about its aims or the likelihood of its success. PSYOP support must therefore stress that—

- The resistance organization shares the political, economic, and social goals of the population.

- The United States and its allies, in supporting the resistance organization, support these same goals.
- The resistance organization will be successful.

Hostile sympathizers include willing collaborators, unwilling collaborators who collaborate under duress, and passive hostile sympathizers. PSYOP seek to instill doubt and fear in this target audience. PSYOP may be conducted in conjunction with positive political action programs that identify and discredit hostile collaborators or weaken their belief in the strength and cause of the hostile power. Punitive action against such collaborators may result in hostile reprisals and a loss of broad civilian support for the resistance organization. However, hostile overreaction can be exploited to build popular support for the resistance organization.

Hostile military forces may be of the same nationality as the population, or they may represent an occupying power or one assisting the hostile government. PSYOP focus on the hostile soldier's frustrations to lower his morale, reduce his effectiveness, and create feelings of inadequacy, insecurity, and fear. These feelings increase his susceptibility to PSYOP and make him more vulnerable to persuasion to surrender, malingering, show disaffection, or desert. PSYOP directed against this audience seek to make the members feel—

- Isolated.
- Improperly supported.
- Doubtful of the outcome of the struggle.
- Distrustful of each other.
- Doubtful of the morality of their cause.

Resistance sympathizers are sympathetic to the goals of the resistance organization but are not active members of it. PSYOP directed at this target audience stress appeals to provide active (though generally clandestine) support or to cooperate passively with the resistance organization. Inherent in these appeals is enforcement of a rigid personal code of conduct by resistance members. The resistance leadership must ensure strict respect for the people, their sensitivities, culture, customs, and needs. The words and deeds of the resistance organization must assure the people that it will help protect them from the hostile power and that it is the instrument of political, social, and economic progress.

PSYOP in Support of FID

PSYOP elements normally deploy in support of SF units as part of a SAF. PSYOP objectives in FID include—

- Assisting the HN in gaining or retaining the support of its people.
- Assisting the HN in defeating the insurgents.
- Establishing a favorable US image in the HN.
- Favorably presenting US actions and intentions to neutral groups and the international community.
- Assisting the HN in supporting defector rehabilitation programs.
- Providing close and continuous PSYOP support to increase the effect of CA operations.

Deployed SF units and their PSYOP advisors train, advise, and assist the HN in target analysis, media selection, and propaganda development. Conventional PSYOP techniques are equally applicable during FID operations. There are normally five major PSYOP target audiences in FID: insurgents, civilian population, HN and allied forces, neutral groups, and external hostile powers.

PSYOP seek to discredit insurgents and to isolate them from the population; to create disruption, dissonance, and low morale; and to cause defection

within insurgent ranks. PSYOP should emphasize national programs that attempt to win the insurgents over to the government side and, most important, to maintain their continued support.

Since popular support is essential, PSYOP seek to gain, preserve, and strengthen civilian support for the government, its leaders, and its programs. PSYOP personnel should also make a significant effort to win popular support for the presence of US and allied forces in the HN.

PSYOP seek to build and sustain the morale of HN and allied forces. The loyalty, discipline, and motivation of these forces are key factors in accomplishing the FID mission.

PSYOP seek to gain the support or at least the continued neutrality of neutral groups inside and outside the HN. PSYOP programs are normally positive and constructive, stressing the tangible accomplishments of the HN government. The PSYOP communications effort, in part, should discourage public apathy and all activities that assist the insurgents.

PSYOP seek to convince external hostile powers supporting the insurgents that—

- It is not in their best interests to continue their support.
- The insurgents will fail.
- They should redirect their support to the HN.

PSYOP in Support of Other SF Operations

SR, DA and CT missions normally involve minimal contact between SF soldiers and the indigenous population. However, when contact is required, or when chance contacts do occur, SF soldiers must apply their PSYOP skills to accomplish their mission.

Ongoing strategic PSYOP may make the indigenous population more supportive in the event of chance contact.

These SF operations, like those in FID and UW, also have psychological impact. In particular, DA and CT operations should be planned and executed to maximize their negative impact on hostile target audiences.

CHAPTER 16



Successful SF operations depend upon the support of the civilian population. Without popular support, a UW or FID mission will fail. SF teams must therefore help their supported indigenous forces to mobilize the civilian population to support their mission. They must also consider the impact of all their activities on the civilian population. This chapter discusses how civil-military operations support SF operations. (See FM 41-10 for a more detailed discussion of CA support of SO.)

Command Support Operations

Elements of a CA battalion (FID/UW) normally support each committed SF unit assigned a UW or FID mission. These CA elements conduct the following activities in support of SF commanders:

- Train and advise members of the supported SF unit in CMO and the political, economic, social, and cultural factors that influence SF operations.
- Identify and acquire foreign resources to assist the SF unit in accomplishing its mission.
- Coordinate with other agencies to minimize civilian interference with SF operations.
- Assist the SF commander in meeting legal and moral obligations to the local population, families of supported indigenous forces, and persons displaced by SF operations.
- Supplement the intelligence effort by collecting information during CMO.
- Act as staff focal point for cultural considerations that affect SF operations.
- Coordinate and integrate CA activities with PSYOP activities.
- Provide technical advice and assistance on civil assistance, military civic action, and humanitarian assistance programs.

Role of CA in UW

The supporting CA element trains, advises, and assists deploying SF teams in CMO. The element also advises the teams on the political, economic, social, and cultural factors they must understand before deploying into the JSOA. CA planning and training for UW must consider the following factors:

- The theater CINC's politico-military mission (for example, restore the government-in-exile) and its effect on the resistance organization during and after hostilities.
- The strengths, weaknesses vulnerabilities, and likely intentions of the hostile political organization.
- Likely hostile countermeasures to isolate the resistance organization physically or psychologically from the population.
- Resistance activities that the hostile power can exploit to neutralize US support or mobilize world opinion against the resistance.
- Organization and potential development of the resistance organization.
- The political, social, economic, and security needs of the various segments of the population.

Once the SF team deploys into the JSOA, the CA element at the operational base provides CA advice and assistance as required. It may also assist in the administration of refugee camps that serve as recruiting and/or training bases for the resistance organization.

Selected CA members or teams may accompany deploying SF teams when the mission requires their immediate presence in the JSOA. Normally, however, CA teams do not infiltrate into the JSOA until the resistance organization develops and

establishes relatively secure base areas under resistance control. Deployed CA teams advise and assist the area command and the SF team by—

- Expanding the influence of the resistance organization into areas not under its control.
- Developing the area command structure, resistance political organization, and effective administration of resistance-controlled territory.
- Developing the auxiliary to support and sustain sufficient combat forces.
- Providing CA input to operational planning of the area command.
- Assisting in the transition and consolidation of power in the JSOA after the end of hostilities (for example, transition of the shadow government into an actual government or its merger with a government-in-exile).
- Demobilizing the resistance force.

Deployed CA teams assist the supported SF team by assuming responsibility for advising and assisting the auxiliary. Specific functions include development of—

- Means and procedures to finance, pay, and account for locally procured resources.
- Production facilities and supply distribution systems.
- PRC measures within resistance-controlled territory.

Deployed CA teams also provide operational advice and assistance to the area command and the SF team. Specific areas of concern include advising on—

- The impact of resistance tactical operations and likely hostile countermeasures (for example, reprisals, forced relocations, confiscation of resources) on the civilian population.
- Appropriate standards of conduct and behavior for resistance forces.

Role of CA in FID

The primary objective of CA in FID is to help HN forces mobilize the people and other resources in

support of the HN government. CA support may range from staff advice and assistance to the commitment of CA units. Activities may include—

- Coordinating SF operations with appropriate HN, US Mission, and international agencies.

- Minimizing civilian interference with SF operations.
- Providing civil assistance to HN government agencies.
- Serving as the SF unit's focal point for community relations.
- Advising and assisting SF units conducting military civic action or humanitarian assistance programs.
- Advising and assisting SF units in planning and implementing a civil defense program.
- Supplementing the SF intelligence collection effort.
- Supporting displaced person operations, to include advising or assisting the HN government in the establishment and operation of camps.
- Advising and assisting HN government agencies in the implementation of PRC programs.

Civil assistance programs improve the capabilities of HN civil authorities to deal with the political, economic, and social aspects of IDAD. Civil assistance may be temporary or it may involve activities of a more permanent nature.

SF units participate in military civic action projects that enhance HN economic and social development and gain the active support of the population. Such participation should always emphasize the HN role.

Role of CA in DA and CT

The primary role of CA in these activities is to provide CA input during pre-mission planning and preparation. If the situation indicates that there

will be a civilian presence in the objective area that could interfere with the SF operation, a CA element may accompany the SF team. This CA element establishes and operates collecting points for displaced civilians, rescued hostages, or non-combatant evacuees.

APPENDIX A

Operating Systems

This appendix introduces the concept of function-oriented operating systems as a means of describing how SF commanders accomplish the vertical and horizontal integration of their activities. It begins by providing a combined arms perspective that is much broader than the traditional focus on combat arms maneuver at the tactical level. The appendix then describes the Army's conventional operating systems. Finally, it applies the BOS to SF capabilities in a manner that is useful to SF commanders during mission planning and execution.

The combined arms concept has existed for centuries, but the nature of the combination and the organizational level at which it occurs has varied greatly among armies over time. In World War I, the US Army's square division stressed the tactics of **supplementary** or **reinforcing** combined arms. Artillery, engineers, and tanks were used to increase the effectiveness of infantry in close combat. In World War II, the US Army shifted its level of combined arms organization to the regimental combat team and armored combat command (the brigade in today's terminology). The Army also changed its tactics to emphasize **complementary** combined arms. The strengths of each arm compensated for the weaknesses of the others to create a synergistic effect.

Combined Arms

The combined arms concept stresses the use of different arms and services in combination to maximize their survival and combat effectiveness.

Since World War II, the growing complexity of modern conventional warfare has led to greater specialization within the combat arms. Combined arms commanders now recognize that all CS and CSS elements are equally important. They can no longer simply concentrate their combat forces on the battlefield. To be successful in sustained combat operations today, they must synchronize the effects of their total force.

Army Operating Systems

To further refine the combined arms concept, the Army has adopted a *Blueprint of the Battlefield* for each level of war. Each blueprint defines a number of operating systems that integrate all combat, CS, and CSS activities by function, rather than by mission, branch, or unit (Figure A-1). This approach represents a new methodology for *how to think* about war and other military operations. This methodology demands that commanders and their staffs think in terms of integrated systems, rather than orienting on the units that compose those systems.

Each operating system represents a hierarchy of functions (Figure A-2). By design, each function appears in only one operating system and the definition of each operating system clearly distinguishes its modular functions. together, the

operating systems provide a framework for analysis and integration.

The application of these blueprints and their operating systems depends upon the stated purpose of the analysis or integration effort. Among the purposes of the blueprints are—

- Mission area analysis, to identify capabilities issues.
- Concepts and doctrine development, to identify functional interdependencies and eliminate duplication of effort.
- Force analysis and integration, to identify mission essential tasks and the capabilities of units to execute them.
- Training development, to provide a systematic combined arms perspective for the development and evaluation of unit training programs.
- Mission planning and execution, to ensure that the capabilities of the total force are addressed and fully integrated.

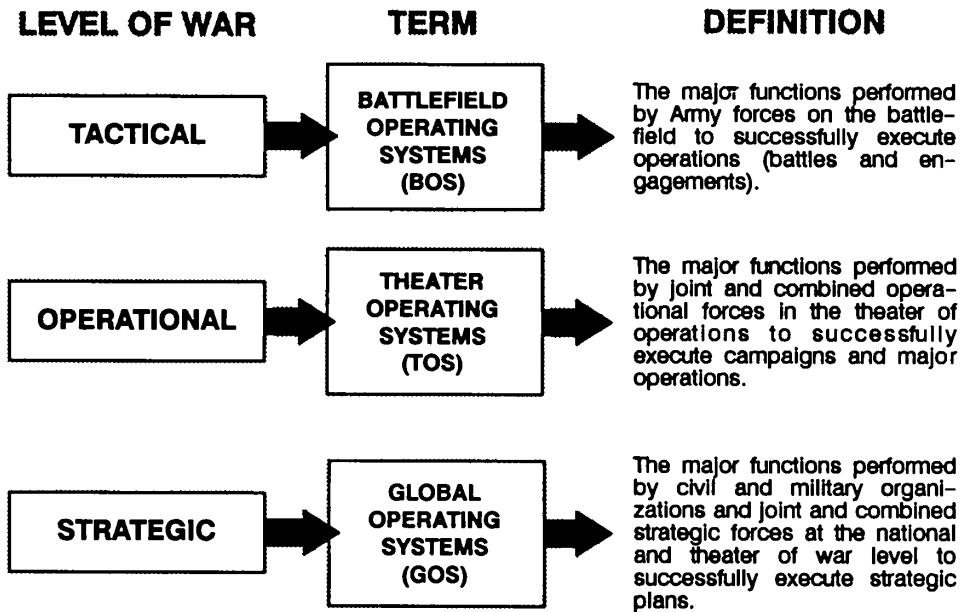

Figure A-1. Operating Systems Terminology.

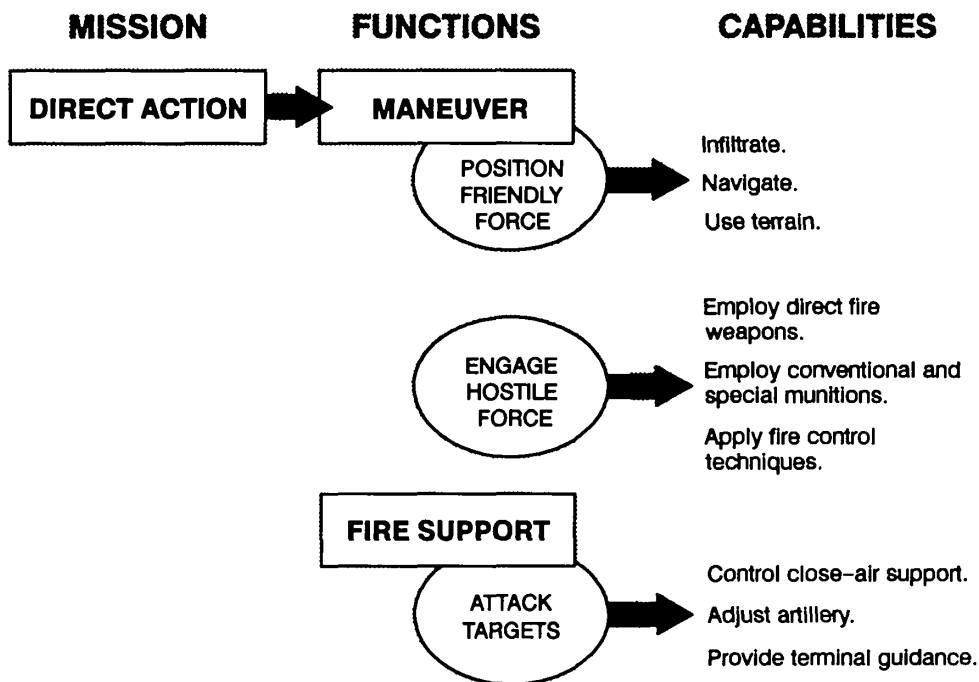

Figure A-2. Sample Hierarchy of Functions.

Application Of BOS

The tactical-level BOS and operational-level theater operating systems (TOS) are shown in Figures A-3 and A-4. (The strategic-level global operating systems [GOS] are still under development.) The BOS focus on Army units at corps level and below and on battlefield functions performed in a combat zone by Army units at corps level and below. The TOS more closely approximate SF functions because the TOS focus on functions performed in a theater of

operations by joint and combined forces at EAC. However, the TOS do not have the degree of detail required to analyze or integrate SF operations at the tactical level of execution. Additionally, the Army has integrated the BOS into its tactical doctrine, but has not yet included the TOS in its EAC doctrine. Therefore, SF commanders must apply the BOS differently to (Figure A-5)—

- Portray SF functions in terms that are useful to them.
- Provide linkages that permit combat developers, doctrine developers, and training developers to portray SF functions in terms that are understandable to the conventional Army.

FUNCTION	BOS
MANEUVER	Employment of forces on the battlefield through movement in combination with fire or fire potential, to achieve a position of advantage with respect to the hostile force. Includes engagement of the hostile force with direct fire or in close combat.
FIRE SUPPORT	Employment of target acquisition data, indirect-fire weapons, armed aircraft (less attack helicopters), and other lethal and nonlethal means against ground targets in support of maneuver force operations. Includes artillery, mortars, naval gunfire, close-air support, smoke, PSYOP, and electronic countermeasures. Does <i>NOT</i> include target acquisition.
AIR DEFENSE	Employment of all lethal and nonlethal measures designed to nullify or reduce the effectiveness of hostile air attacks.
COMMAND AND CONTROL	Exercise of authority and direction by a commander over assigned forces in the accomplishment of the mission. Includes planning and communication functions.
INTELLIGENCE	Collection, processing, and dissemination of information concerning the hostile force's capabilities, intentions, vulnerabilities, and the operational environment. Includes target acquisition.
MOBILITY AND SURVIVABILITY	Enhancement of the friendly force's freedom of movement relative to the hostile force. Protection of the friendly force from the effects of hostile weapon systems and natural occurrences. This includes countermobility, OPSEC, and deception.
COMBAT SERVICE SUPPORT	Sustainment of the friendly force, primarily in the fields of logistics, personnel services, and health services. This includes civil-military operations..

Figure A-3. Battlefield Operating Systems.

FUNCTION	TOS
OPERATIONAL MANEUVER	Disposition of forces to create a decisive impact on the conduct of a campaign or major operation by either securing the operational advantages of position before battle occurs or exploiting tactical success to achieve operational or strategic success. Includes provision of operational mobility to friendly operational formations. Also includes operational counter-mobility to delay or otherwise hinder the movement of hostile operational formations.
OPERATIONAL FIRES	Attack of land, air (other than air defense), and sea targets to achieve an operationally significant objective. Operational fires are not fire support, and an operational maneuver does not necessarily depend on such fires.
OPERATIONAL PROTECTION	Protection of the friendly force from hostile operational maneuvers, hostile operational fires, and natural occurrences. This includes operational air defense, OPSEC, deception, and the safeguarding of operational formations.
OPERATIONAL COMMAND AND CONTROL	Exercise of authority and direction by a properly designated commander over assigned operational forces in the accomplishment of the mission.
OPERATIONAL INTELLIGENCE	Collection, processing, and dissemination of information concerning operationally significant military and nonmilitary factors.
OPERATIONAL SUPPORT	Sustainment of the friendly force in campaigns and major operations. This includes civil-military operations.

Figure A-4. Theater Operating Systems.

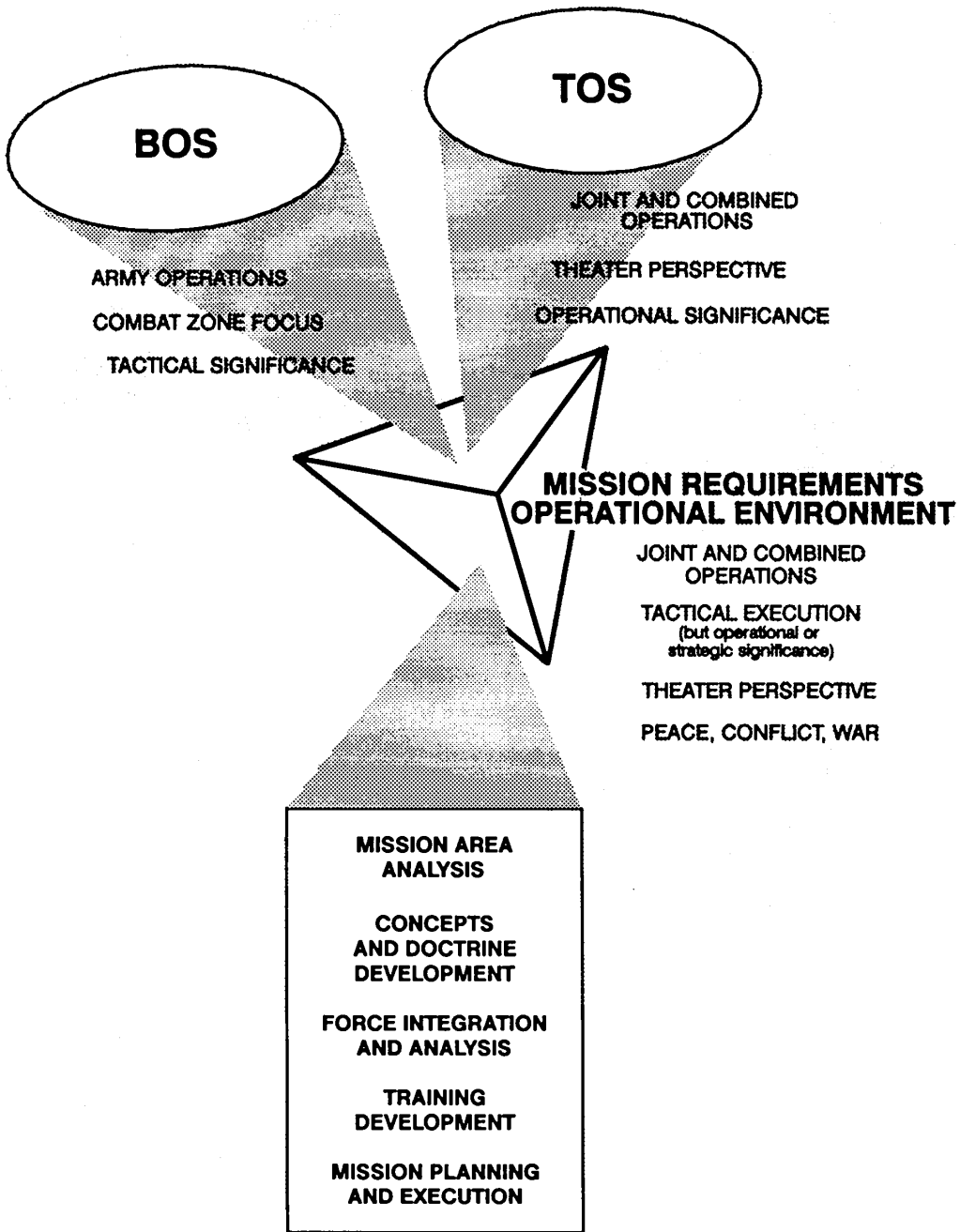

Figure A-5. Application of BOS.

NOTE: For ease of use, the BOS are presented below in the same order that they would be addressed in an OPLAN or OPORD.

Intelligence

The SF intelligence system performs the same functions as conventional intelligence systems. (See Chapter 13.) It includes the—

- Planners and coordinators in the group and battalion S2 sections.
- Producers and collectors in the group and battalion MI detachments.
- SFOD members who are involved in the collection, processing, and dissemination of information.

SF commanders rely heavily on theater and national intelligence systems. SF operations often require the dissemination of near-real-time strategic intelligence down to the tactical level of execution. This requirement places unique demands on the intelligence system.

Maneuver

The SF maneuver system includes the SFODs and, when applicable, their indigenous combat forces. These forces move, navigate, engage hostile forces with direct fire, control terrain, and influence the population.

The SF group and battalion commanders employ the maneuver system by directing and synchronizing the activities of independently deployed SF teams. These teams infiltrate their operational areas to gain positional advantage in the operational or strategic rear of a hostile power. There they conduct SF operations unilaterally or by recruiting, organizing, training, equipping, advising, and/or leading indigenous combat forces. There are normally no adjacent friendly forces capable of providing mutual support.

Army, Air Force, and Navy infiltration and exfiltration means provide mobility to the SF maneuver system. Once deployed in its operational area, an SF team usually depends on indigenous transportation for movement, although it may have organic tactical mobility (for example, the desert vehicle mobility system or over-snow vehicles).

Fire Support

The primary SF fire support system is the terminal guidance capability of the SFODs. SF teams do not normally have organic fire support means (except light mortars). They often operate beyond the range of field artillery and close air support. As a result, SF commanders must often coordinate with higher headquarters for operational fires to obtain the SF equivalent of fire support. During FID operations and certain DA missions SF teams may receive fire support from armed helicopter field artillery, naval gunfire, and/or close air support aircraft (to include AC-130 gunships). In other SF operations, organic fire support means may be provided to the indigenous combat forces of the SF maneuver system.

The BOS categorize PSYOP as nonlethal fire support. All SF operations have psychological implications. For this reason, PSYOP support is as vital to most SF operations as artillery support is to conventional military operations. SF units routinely employ PSYOP against hostile, neutral, and friendly target audiences. (See Chapter 15.) Therefore, SF considers PSYOP a major subsystem of the fire support BOS. The SF PSYOP subsystem includes the—

- Planners and coordinators in the group and battalion PSYOP staff elements.
- Producers and disseminator in attached and supporting PSYOP units.
- All SFOD members.

SF commanders rely on organic or attached PSYOP staff elements to ensure the total integration of PSYOP, from the earliest phase of mission planning until mission completion. The TA's PSYOP group and other theater PSYOP assets employ strategic dissemination means to support SF operations. When appropriate, but particularly during FID operations, tactical PSYOP units may be attached to SF down to company or even SFOD level.

Because SF teams attack hostile air targets offensively as well as defensively, SF defines the offensive counterair function as a function within the fire support BOS. This definition eases vertical integration with the TOS operational fires system.

Air Defense

By TOE, SF units do not have an organic air defense system. They mainly employ passive air defense

measures to protect their elements. They rely on conventional theater air defense systems to provide active protection of their operational bases. Selected SF elements organize and train MANPAD teams to provide point air defense. If required, SF commanders must coordinate with higher headquarters for additional air defense protection. This protection may include provision of an organic air defense capability to the indigenous combat forces of the SF maneuver system.

Mobility and Survivability

This BOS includes two major subsystems engineer and NBC. It also includes those measures that enhance force protection.

SF commanders do not have a separate engineer subsystem to perform mobility functions. The SF maneuver system performs mobility functions on a nondedicated basis as part of its normal operations. SF commanders must coordinate with higher headquarters for dedicated engineer support to augment organic capabilities when required. This support may include provision of an organic engineer capability to the indigenous combat forces of the SF maneuver system.

SF units rely on the same measures as conventional units for their survivability. (See Chapter 7.) These measures include—

- Stationing the bulk of their C2 and support elements deep within the COMMZ.
- Employing OPSEC, deception operations, and counterintelligence activities to conceal true SF capabilities and intentions.
- Maintaining standard defensive NBC capabilities.
- Providing physical security to SF operational bases.

Combat Service Support

The SF CSS system performs the same functions as conventional CSS systems. (See Chapter 14.) It includes the—

- Planners and coordinators in the group and battalion S1 and S4 sections.
- Operators in the group and battalion support companies.
- SFOD members who are involved in CSS.

The SF commanders rely heavily on the TA CSS system. The organic CSS capabilities of the SF group and battalion are similar to the unit-level capabilities found in a conventional combat arms brigade. The TA CSS system normally provides all DS-level CSS support to SF units on an area basis by nondedicated CSS units. When area support is inappropriate or infeasible, the TA provides CSS on a unit basis by dedicated CSS units. This nonstandard arrangement is most likely to occur in undeveloped theaters or during contingency operations.

The BOS categorize CMO as a subsystem of CSS. However, CMO pervade every aspect of UW and FID operations. (See Chapter 16.) As a result, CMO become operationally significant to an extent only rarely found in conventional military operations. Therefore, SF considers CMO as a major subsystem of the CSS BOS. The SF CMO subsystem includes the—

- Planners and coordinators in the group and battalion S5 sections.
- Operators in attached and supporting CA units.
- All SF members engaged in combined activities.

All SFOD members must be area-oriented and language qualified to function effectively. The full-time CA planners, coordinators, and operators normally support SF efforts with technical advice, training, and assistance. When appropriate, CA teams may be attached to deployed SF teams to take over some of their noncombat CMO functions.

Command and Control

The SF C2 system performs the same functions as conventional military C2 systems. (See Chapters 5, 6, and 7.) It consists of the—

- SF group battle staff.
- SF operational bases at group, battalion, and company level.
- SF command and control elements collocated with supported conventional headquarters at corps or higher level.
- SFOD command groups.
- Communications systems that connect all C2 nodes.

The SFOD command group is the only element of the SF C2 system that integrates all seven BOS to conduct its operations. All other SF C2 elements direct or support the SFOD and integrate its activities with those of appropriate friendly TOS and BOS.

APPENDIX B

NOTE: In this and subsequent appendixes, the following acronyms apply:

SACATLDEFCON-Supreme Allied Commander, Alantis Defense Command
 ATLDEFCON-Alantis Defense Command
 CINCUSATL-Commander-in-Chief, US Alantis Command
 USATLCON-US Alantis Command
 COMSOCATL-Commander, Special Operations Command Alantis
 SOCATL-Special Operations Command Alantis

Sample Group Operation Plan

<hr/> (CLASSIFICATION)	
COPY OF _____ COPIES 9TH SFG(A), 1ST SF FORT BRAGG, NC 28307-5000 27 MAY 1988	
9TH SFG(A) OPLAN 2640	
BASIC OPLAN FOR SPECIAL OPERATIONS IN THE USATLCON AOR (U)	
() REFERENCES.	
a. () Maps and Charts. Annex I (Mapping, Charting, and Geodesy).	
b. () JSCP Annex E (Special Operations) (U).	
c. () SACATLDEFCON OPLAN 2640, ATLDEFCON Combined Theater Campaign Plan (U).	
d. () CINCUSATL OPLAN 2640, USATLCON Subordinate Campaign Plan (U).	
<hr/> (CLASSIFICATION)	

Figure B-1. Group Operation Plan.

(CLASSIFICATION)

e. () COMSOCATL OPLAN 2640, SOCATL Subordinate Campaign Plan for Special Operations in the USATLCOM AOR (U).

f. () 9th SFG(A) Readiness SOP, dtd 18 Dec 87.

g. () 9th SFG(A) Field SOP, dtd 15 Jan 88.

() TASK ORGANIZATION.

9th SFG(A) (-)

A/3/9th
 2 SFOD A, B/3/9th SFG(A)
 Hq, C/2/9th SFG(A)
 Hq, B/3/9th SFG(A)
 HHC
 Spt Co
 Op Spt Co, 2d PSYOP BN
 99th CA Bn (FID/UW) (-)
 1118TH MP Co (-)
 5589th Cml Det (-)
 USAF SO Wea Tm
 Ln Tm, 7th SOW
 Ln Tm, NSWTG FOUR

2/9th SFG(A)

A/551st Engr Cbt Bn (Hv)
 B/99th CA Bn (FID/UW)
 DS Tm and Civic Action Tm,
 C/99th CA Bn
 865th Med Co
 2/1118th MP Co
 Tm/2d PSYOP Bn
 Decon Tm, 5589th Cml Det
 USAF SO Wea Tm

1/9th SFG(A)

A/99th CA Bn (FID/UW)
 1/1118th MP Co
 Tm/2d PSYOP Bn
 Decon Tm, 5589th Cml Det
 USAF SO Wea Tm
 Ln Tm, 7th SOW
 Ln Tm, NSWTG FOUR

3/9th SFG(A) (-)

C/99th CA Bn (FID/UW)
 3/1118th MP Co
 Tm/2d PSYOP Bn
 Decon Tm, 5589th Cml Det
 USAF SO Wea Tm

1. () SITUATION.

a. () General.

(1) () This OPLAN provides for the deployment, employment, and sustainment of the 9th SFG(A) in the USATLCOM AOR during a regional crisis or conflict that threatens US national interests or in a global crisis or conflict between the US and the USSR.

(2) () The USSR has a significant capability to project its power and influence into the AOR from two client states, the PDRA

(CLASSIFICATION)

Figure B-1. Group Operation Plan (Continued).

(CLASSIFICATION)

and the SRN. Through the Blazing Torch Movement, the PDRA actively supports terrorism and insurgency in Nuevo Basque, Camargo, and Costa Oro. The PDRA and SRN both actively support the FLN insurgency in southern Nubia. The PDRA also has international drug trafficking ties with the Brotherhood crime syndicate in Agricola.

(3) () The US national security strategy seeks to promote collective security and protect US interests in the region. Specific regional US military strategic objectives in a regional or global crisis or confrontation are to--

(a) () Deter and, if necessary, successfully oppose PDRA and SRN attempts to achieve geopolitical gains by aggression and coercion.

(b) () Deny the USSR opportunities to expand its presence and influence.

(c) () Preserve and protect US and allied access to Atlantis oil resources.

(4) () Three variables complicate the attainment of these objectives:

(a) () In the event of regional crisis or conflict, will the crisis or conflict be confined to the Atlantis continent, or will it be before, concurrent with, or subsequent to crisis or conflict in other theaters?

(b) () In the event of regional or global crisis or conflict, will the USSR commit major forces in the theater?

(c) () Will the NCA consider it feasible to commit major forces in the theater, or will the USATLCOM AOR be a secondary, economy-of-force theater?

(5) () The SACATLDEFCON combined theater campaign plan and USATLCOM subordinate campaign plan envision a three-phased approach to military operations in the AOR.

(a) () In the ongoing Phase I (Minimum Force), USCINCATL employs 1/9th SFG(A) and other forward deployed forces to plan, conduct, and support SA and other military operations in the AOR.

(CLASSIFICATION)

Figure B-1. Group Operation Plan (Continued).

(CLASSIFICATION)

(b) () In Phase II (Deterrence), the NCA allocates additional forces to USATLCOM to credibly convey the US intent to successfully oppose any aggression by the PDRA or SRN against an allied or friendly nation. During this phase, the entire 9th SFG(A) deploys into the AOR. COMSOCATL expands Phase I activities. On order, he initiates SO to provide early warning of hostile aggression and disrupt hostile preparations for attack. In the event that deterrence fails and open hostilities commence, COMSOCATL conducts SO against hostile forces to support the combined defense of key oil facilities in the region. COMSOCATL priorities are to interdict LOC, disrupt the movement of second-echelon forces from PDRA and/or SRN into the oil-rich Aciete Triangle area, and divert as many hostile forces as possible to rear area security missions.

(c) () In Phase III (Warfighting), major US forces deploy into the AOR to successfully oppose an attack by the PDRA to achieve geopolitical gains and/or disrupt US and allied access to Atlantis oil resources. During this phase, COMSOCATL conducts SO to support conventional military operations and pursue conflict termination on terms favorable to US and allied interests.

b. () Hostile. Annex A (Intelligence). In the event of PDRA and SRN aggression in the region, their objective would probably be to secure the Aciete Triangle oil resources and/or to obtain bases in western Atlantis from which to threaten the North American East Coast and the LOC to NATO. Specific strategic military objectives would probably include the defeat of the Atlantica Pact military forces and control of the Sargasso Sea between Atlantis and North America.

c. () Friendly.

(1) () SOCATL.

(a) () In the ongoing Phase I, COMSOCATL operates and maintains a joint FOB at San Sebastian, Nuevo Basque, and conducts joint and combined SO to--

1. () Deter PDRA and SRN aggression and coercion.
2. () Assist friendly Atlantica Pact governments to defend themselves against insurgency.
3. () Combat terrorism in the region.

(CLASSIFICATION)

Figure B-1. Group Operation Plan (Continued).

(CLASSIFICATION)

4. () Support selected resistance movements that enhance US interests in the region.

5. () Support regional activities to interdict and eliminate drug trafficking.

(b) () On order, COMSOCATL conducts SO to neutralize threats to US regional interests from the PDRA, SRN, and any other source. In the event of regional or global hostilities, COMSOCATL intent is to harass and disrupt hostile exploitation of the region's resources or geopolitical position, divert as many hostile combat forces as possible to rear area security, and cause the PDRA and/or SRN to rely on force to impose and maintain control over any occupied territory.

(2) () 6th TASOSC. Provides support and sustainment for all assigned ARSOF in the AOR.

(3) () 7th SOW (AFSOCATL). Deploys into AOR from home station at Hurlburt Field, FL; establishes AFSOB at Sargasso AFB, Camargo, and AFSOD at New London, Camargo; assumes command of forward deployed AFSOF at AFSOD, San Sebastian, Nuevo Basque; and conducts and supports SO as directed.

(4) () NAVSPECWARTASKGROUP FOUR (NAVSOFATL). Deploys into AOR from home station at Little Creek, VA; establishes operating base at Norden Point, Camargo; assumes command of forward deployed NSWU at San Sebastian, Nuevo Basque; and conducts and supports SO as directed.

d. () Assumptions.

(1) () 9th SFG(A) (-) will deploy into the AOR in time to conduct prehostilities SO.

(2) () NCA will grant border-crossing authority for prehostilities SO and the Altantica Pact will permit COMSOCATL to conduct these SO from bases in their territory.

(3) () FNS will be available as described in Annex D of this plan.

(4) () Military airlift and sealift will be available to support 9th SFG(A) deployment, employment, and sustainment.

(CLASSIFICATION)

Figure B-1. Group Operation Plan (Continued).

 (CLASSIFICATION)

(5) () PWRMS and operational project stocks will be available to sustain 9th SFG(A) operations.

e. () Legal Considerations.

(1) () Executive Order 12333 requires presidential approval of all special activities except during war declared by Congress or during any period covered by a report from the President to the Congress under the War Powers Resolution.

(2) () Rules of Engagement. Appendix 8 (Rules of Engagement) to Annex B (Operations).

2. () MISSION. Continue ongoing SO in the AOR. When directed, deploy the remainder of the group to designated locations in the AOR. On order, conduct SO in the USATLCOM AOR.

3. () EXECUTION.

a. () Concept of Operations.

(1) () General. (See Appendix 1, [Group Operations Overlay] to Annex B [Operations]). In the ongoing Phase I, 1/9th SFG(A) and other forward-deployed elements of the group conduct joint/combined SO to support US national interests and objectives in the AOR. On order, the 9th SFG(A) conducts SO to neutralize threats to US regional interests from the PDRA, SRN, and any other source. In the event of regional or global crisis or conflict, the intent of Cdr, 9th SFG(A) provides CINCUSATL with intelligence concerning hostile capabilities and intentions in the AOR; harasses and disrupts any hostile attack against friendly nations in the region; diverts as many hostile combat forces as possible to rear area security; and causes the PDRA and/or SRN to rely on force to impose and maintain control over any occupied territory.

(2) () Deployment.

(a) () 1/9th SFG(A) establishes FOB1 at San Sebastian, Nuevo Basque, in 24 hours (N+1). Prepares to execute preplanned SO missions commencing N+4. Fully commits all operational elements NLT N+10.

(b) () Remainder of group deploys advance party in 24 hours (N+1), 3/9th SFG(A) in 48 hours (N+2), and 9th SFG(A) (-) in

 (CLASSIFICATION)

Figure B-1. Group Operation Plan (Continued).

(CLASSIFICATION)

72 hours (N+3). Establishes SFOB and FOB3 collocated at Atlantica, Camargo, and FOB2 at New London, Camargo, NLT N+5. Prepares to execute preplanned SO missions from FOB3 commencing N+7 and from SFOB and FOB2 commencing N+8. Fully commits all operational elements NLT N+14.

(3) () Employment. In the ongoing Phase I, Cdr, 9th SFG(A), augments 1/9th SFG(A) as required to conduct peacetime joint and/or combined SO in the AOR. Upon the earliest possible strategic warning, 9th SFG(A) (-) deploys into the AOR. Initial prehostilities SO provide early warning and other critical intelligence to CINCUSATL, disrupt hostile preparations for attack, and convey US intent to successfully oppose aggression against the Atlantica Pact nations. If deterrence fails, the 9th SFG(A) conducts SO to support conventional military operations in the AOR and pursue conflict termination on terms favorable to US and allied interests. Main effort is 1/9th SFG(A) in Phase I, shifting to 3/9th SFG(A) (-) upon its deployment into the AOR. On order, priority shifts to A/3/9th SFG(A) for specific missions.

b. () Tasks.

(1) () 1/9th SFG(A):

(a) () Conduct SA operations in Nuevo Basque and Camargo IAW CINCUSATL OPLANS 2642 and 2643.

(b) () Provide in-theater CT response force IAW CINCUSATL OPLAN 2646.

(c) () Support regional CN IAW CINCUSATL OPLAN 2647.

(d) () Support UNITN resistance IAW CINCUSATL OPLAN 2648.

(e) () Establish caches and train Basque stay-behind forces to support UW in occupied Basque in the event that nation is overrun and occupied.

(f) () When directed, establish FOB1 at San Sebastian. Accept attachment of PSYOP team, CA company, and MP platoon. On order, displace FOB1 to La Cruz, Agricola.

(g) () When directed, conduct FID operations to assist Nuevo Basque in defending itself against insurgency.

(CLASSIFICATION)

Figure B-1. Group Operation Plan (Continued).

(CLASSIFICATION)

(h) () When directed, conduct SO in response to actual or threatened PDRA and/or SRN aggression against Nuevo Basque. Give planning priorities, in order, to the following missions:

1. () Continue FID operations in Nuevo Basque.
2. () Conduct SR in the SRN to provide early warning of hostile attack.
3. () Conduct DA operations in the SRN to disrupt hostile preparations for attack and convey US intent to successfully oppose aggression against Nuevo Basque.
4. () Conduct SR and DA operations in support of conventional military operations. Give planning priority to battlefield surveillance, target acquisition, and interdiction of hostile LOC from PDRA to Aciete Triangle and from SRN to San Sebastian, in that order.

(i) () When directed, conduct stay-behind UW operations in Nuevo Basque and/or UW operations with UNITN resistance elements in the SRN.

(2) () 2/9th SFG(A):

(a) () Provide forces on a rotational basis to conduct SA operations in Camargo under OPCON of SAO Camargo.

(b) () When directed, deploy to New London, Camargo, and establish FOB2. Accept attachment of engineer company, PSYOP team, CA company, medical company, and MP platoon.

(c) () When directed, conduct FID operations to assist Camargo in defending itself against insurgency.

(d) () Upon commitment of 21st Abn Corps into the AOR, release Co C Hq to serve as SOCCE at 21st Abn Corps Hq under OPCON of Cdr, 9th SFG(A).

(CLASSIFICATION)

Figure B-1. Group Operation Plan (Continued).

 (CLASSIFICATION)

(e) () When directed, conduct SO in response to actual or threatened PDRA aggression against Camargo. Give planning priorities, in order, to the following missions:

1. () Advise, assist, and support Camargan armed forces when they make the transition to conventional military operations.

2. () When relieved by conventional advisory assistance teams, release engineer company and medical company to 21st Abn Corps. Conduct SO in support of conventional military operations. Give planning priority to battlefield surveillance, target acquisition, and interdiction of hostile LOC from PDRA to Atlantica and from PDRA to Sargasso AFB, in that order.

(3) () 3/9th SFG(A):

(a) () Provide forces on a rotational basis to conduct SA operations in Camargo under OPCON of SAO Camargo.

(b) () When directed, deploy to Atlantica, Camargo, and establish FOB3 collocated with the SFOB. Accept attachment of PSYOP team, CA company, and MP platoon.

(c) () On order, release Co A and two SFODs from Co B for employment under OPCON of Cdr, 9th SFG(A).

(d) () On order, release Co B Hq to establish and operate group ISOFAC under OPCON of Cdr, 9th SFG(A).

(e) () When directed, conduct SO in response to actual or threatened PDRA aggression against Nuevo Basque or Camargo. Give planning priorities, in order, to the following missions:

1. () Conduct SR in the PDRA to provide early warning of hostile attack.

2. () Conduct DA operations in the PDRA to disrupt hostile preparations for attack and convey US intent to successfully oppose aggression in the region.

 (CLASSIFICATION)

Figure B-1. Group Operation Plan (Continued).

(CLASSIFICATION)

3. () Conduct SR and DA operations in support of conventional military operations. Give planning priority to battlefield surveillance, target acquisition, and interdiction of hostile LOC from the PDRA to Aciete Triangle and from the PDRA to Atlantica, in that order.

(f) () When directed, conduct UW operations with selected resistance elements in the PDRA.

(4) () A/3/9th SFG(A).

(a) () When directed, accept attachment of two SFODs from B/3/9th SFG(A) and deploy to SFOB for employment under OPCON of Cdr, 9th SFG(A).

(b) () When directed, conduct SO in response to actual or threatened PDRA and/or SRN aggression against Nuevo Basque or Camargo. Give planning priorities, in order, to the following missions:

1. () Support E&E activities in the PDRA, to include preparation and servicing of safe areas.

2. () Conduct or support special infiltration and recovery operations as directed by COMSOCATL.

3. () Conduct special activities as directed by COMSOCATL.

4. () Assess resistance potential in the PDRA.

(5) () Spt Co, GS SFOB. Accept attachment of 5589th Cml Det(-).

(6) () Op Spt Co, 2d PSYOP Bn.

(a) () Co (-): GS SFOB.

(b) () Detach one team each to 1/9th SFG(A), 2/9th SFG(A), and 3/9th SFG(A).

(c) () Appendix 4 (PSYOP) to Annex B (Operations).

(CLASSIFICATION)

Figure B-1. Group Operation Plan (Continued).

 (CLASSIFICATION)

(7) () 99th CA Bn.

(a) () Bn (-): GS SFOB.

(b) () Detach one company to 1/9th SFG(A), one company (+) to 2/9th SFG(A), and one company (-) to 3/9th SFG(A).

(c) () Detach one DS team each to SOCATL and 6th TASOSC.

(d) () Annex F (Civil Affairs).

(8) () 1118th MP Co.

(a) Co (-): GS SFOB with company Hq and one platoon.

(b) Detach one platoon each to 1/9th SFG(A), 2/9th SFG(A), and 3/9th SFG(A).

c. () Coordinating Instructions.

(1) () Time zone used: ZULU.

(2) () Conduct operations IAW 9th SFG(A) Readiness SOP and Field SOP.

(3) () NBC. Prepare for operations in an NBC environment. Appendix 2 (NBC) to Annex B (Operations).

(4) () Electronic Warfare. Appendix 3 (EW) to Annex B (Operations).

(5) () PSYOP. Appendix 4 (PSYOP) to Annex B (Operations).

(6) () Deception. Appendix 7 (Deception) to Annex B (Operations).

(7) () OPSEC. Annex K (OPSEC).

(8) () This plan effective for planning upon receipt. Submit supporting plans to Cdr, 9th SFG(A), within 60 days of receipt.

 (CLASSIFICATION)

Figure B-1. Group Operation Plan (Continued).

(CLASSIFICATION)

4. () SERVICE SUPPORT.

a. () Concept of Sustainment. The 9th SFG(A) obtains its service support from designated area support groups. FOB1 maintains 15 days of supplies; continues to receive its support from the Joint Support Activity, San Sebastian. The SFOB and FOB3 deploy with 30 days of supplies; receive their support from the 48th ASG, Atlantica, commencing D+20. FOB2 deploys with 25 days of supplies; receives its support from the Naval Support Activity, New London, commencing D+14.

b. () Logistics. Annex C (Logistics).

c. () Personnel. Annex D (Personnel).

d. () Public Affairs. Annex E (Public Affairs).

e. () Civil Affairs. Annex F (Civil Affairs).

5. () COMMAND AND CONTROL.

a. () Command Relationships.

(1) () COMSOCATL exercises OPCON of all SOF deployed into the AOR, less those elements under the OPCON of an in-country SAO.

(2) () In Phase III, most USATLCOM forces pass to the OPCON of SACATLDEFCON, but SFCATL and its assigned SOF remain under the OPCON of CINCUSATL. COMSOCATL exchanges liaison officers with allied SOF to effect mutual coordination of SO in the region.

(3) () The Cdr, 9th Army, exercises command less OPCON of all ARSOF deployed into the AOR.

b. () Command Posts.

(1) () Main CP is SFOB, Atlantica.

(2) () Alternate CP is FOB2, New London.

(CLASSIFICATION)

Figure B-1. Group Operation Plan (Continued).

(CLASSIFICATION)

c. () Succession of Command. 9th SFG(A) Field SOP.

d. () SIGNAL. Annex G (Signal).

BANK
Col, SF
Commander

Annexes:

- A INTELLIGENCE
- B OPERATIONS
- C LOGISTICS
- D PERSONNEL
- E PUBLIC AFFAIRS
- F CIVIL AFFAIRS
- G SIGNAL
- H OPERATIONS SECURITY
- I MAPPING, CHARTING, AND GEODESY
- J EXECUTION CHECKLIST

DISTRIBUTION: Per SOP

OFFICIAL:
MEADOWS
MAJ, SF
S3

(CLASSIFICATION)

Figure B-1. Group Operation Plan (Continued).

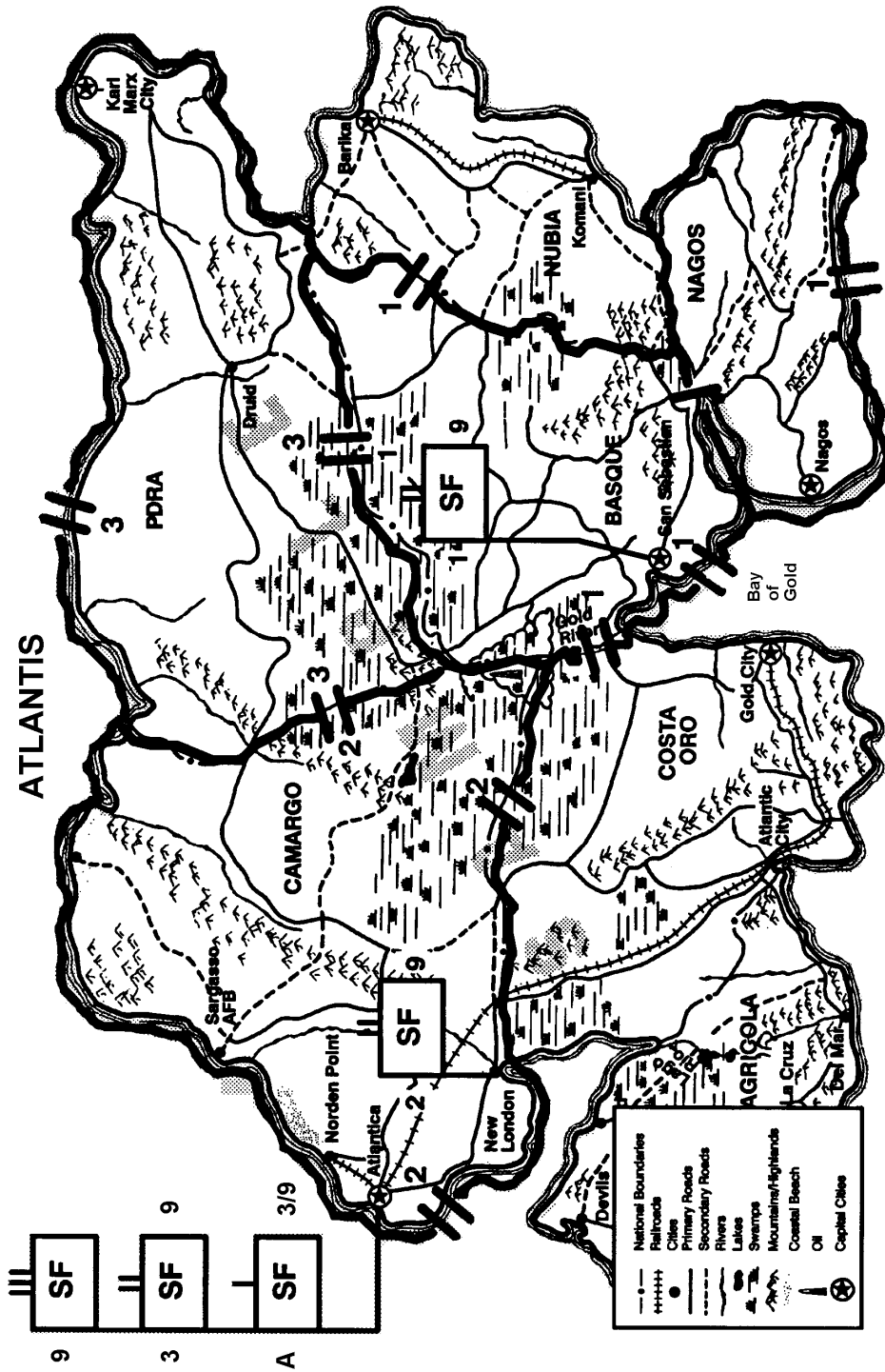

Scale: 3" is 100 miles

Appendix 1: (Group Overlay) to Annex B (Operations)

Figure B-1. Group Operation Plan (Continued).

APPENDIX C

Sample Battalion Operation Plan

<p>_____ (CLASSIFICATION)</p>	<p>COPY _____ OF _____ COPIES 2D BN, 9TH SFG(A), 1ST SF FORT BRAGG, NC 28307-5000 27 MAY 1988</p>
<p>2D BN, 9TH SFG(A) OPLAN 2640</p>	
<p>BASIC OPLAN FOR SPECIAL OPERATIONS IN THE USATLCOM AOR ()</p>	
<p>() REFERENCES.</p>	
<p>a. () Maps and Charts. Annex I (Mapping, Charting, and Geodesy).</p>	
<p>b. () SOCATL OPLAN 2640, Subordinate Campaign Plan for Special Operations in the USATLCOM AOR (U).</p>	
<p>c. () 9th SFG(A) OPLAN 2640, Operation Plan for Special Operations in the USATLCOM AOR (U).</p>	
<p>d. () 9th SFG(A) Readiness SOP, dtd 18 Dec 87.</p>	
<p>e. () 9th SFG(A) Field SOP, dtd 15 Jan 88.</p>	
<p>_____ (CLASSIFICATION)</p>	

Figure C-1. Battalion Operation Plan.

(CLASSIFICATION)

() TASK ORGANIZATION.

2/9th SFG(A) (-)	B/2/9th SFG(A)
A/551st Engr Cbt Bn(Hv)	SFOD A, C/2/9th SFG(A)
B/99th CA Bn (-)	SOT A, Spt Co, 2/9th SFG(A)
Civic Action Tm, C/99th CA Bn	2 DS Tms, A/99th CA Bn
865th Med Co	DS Tm, C/99th CA Bn
2/1118th MP Co	
Tm/2d PSYOP Bn (-)	
Decon Tm, 5589th Cml Det	
USAF SO Wea Tm	

A/2/9th SFG(A)	C/2/9th SFG(A)
SFOD A, C/2/9th SFG(A)	DS Tm, A/99th CA Bn
2 SOTs A, Spt Co, 2/9th SFG(A)	
DS Tm, A/99th CA Bn	
DS Tm, C/99th CA Bn	

1. () SITUATION.

- a. () General.*****
- b. () Hostile. Annex A (Intelligence).*****
- c. () Friendly.

(1) () 9th SFG(A). In the ongoing Phase I, 1/9th SFG(A) and other forward-deployed elements of the group conduct joint and combined SO to support US national interests and objectives in the AOR. On order, 9th SFG(A) conducts SO to neutralize threats to US regional interests from the PDRA, SRN, and any other source. In the event of regional or global crisis or conflict, the intent of Cdr, 9th SFG(A), is to provide CINCUSATL with intelligence concerning hostile capabilities and intentions in the AOR; harass and disrupt any hostile attack against friendly nations in the region; divert as many hostile combat forces as possible to rear area security; and cause the PDRA and/or SRN to rely on force to impose and maintain control over any occupied territory.

(2) () 1st Bn, 9th SFG(A). Continues ongoing SO in the AOR. On order, establishes FOB1 at San Sebastian, Nuevo Basque, and conducts SO in Nuevo Basque and the SRN.

(3) () 3d Bn, 9th SFG(A). On order, deploys to Atlantica, Camargo, and establishes FOB3 collocated with the SFOB. When directed, conducts SO in the PDRA.

(4) () 7th SOW (AFSOCATL).*****

(CLASSIFICATION)

Figure C-1. Battalion Operation Plan (Continued).

(CLASSIFICATION)

(5) () NAVSPECWARTASKGROUP FOUR (NAVSOFATL).*****

d. () Assumptions.*****

e. () Legal Considerations.*****

2. () MISSION. The 2d Bn, 9th SFG(A), continues to support ongoing SO in the AOR. When directed, deploys to establish and operate FOB2 at New London, Camargo. On order, conducts SO in its assigned JSOA.

3. () EXECUTION.*****

a. () Concept of Operations.

(1) () General. (See Appendix 1[Battalion Operation Overlay] to Annex B [Operations]). When directed, 2d Bn, 9th SFG(A), advises, assists, and supports the Camargan armed forces to defeat the PDRA-sponsored insurgency and establish a level of internal security that permits balanced internal development. In event of a regional or global crisis or confrontation, 2d Bn, 9th SFG(A), continues to advise, assist, and support the Camargan armed forces when they shift to conventional military operations. When properly relieved, Bn operational elements regroup for recommitment to SO in support of conventional military operations in Camargo and conflict termination on terms favorable to US and allied interests.

(2) () Deployment. 2/9th SFG(A) deploys advance party in 24 hours (N+1) and main body in 60 hours (N+3) to establish FOB2 at New London, Camargo, NLT N+5. Prepares to execute preplanned SO missions commencing N+8. Fully commits all operational elements NLT N+14.

(3) () Employment. In the ongoing Phase I, Cdr, 2d Bn, 9th SFG(A), augments 1/9th SFG(A) as required to conduct peacetime joint and combined SO in the AOR. When directed, 2d Bn, 9th SFG(A), deploys into the AOR and conducts FID operations to assist Camargo in defending itself against insurgency. Upon the earliest possible strategic warning of a regional or global crisis or confrontation, 2d Bn, 9th SFG(A), deploys into the AOR. Initial prehostilities SO focus on advising, assisting, and supporting Camargan armed forces. If deterrence fails, the 2d Bn, 9th SFG(A), continues to advise, assist, and support Camargan armed forces engaged in conventional military operations and SO. As conventional advisory assistance teams become available to relieve committed SFODs, Bn consolidates at FOB2 and prepares to support conventional military operations. The main effort is the forward deployed elements in Phase I, shifting to Co A upon its deployment into the AOR. On order, priority shifts to Co B.

(CLASSIFICATION)

Figure C-1. Battalion Operation Plan (Continued).

(CLASSIFICATION)

b. () Tasks.

(1) () Co A:

(a) () Provide forces on a rotational basis to conduct SA operations in Camargo under OPCON of SAO Camargo.

(b) () When directed, deploy to New London, Camargo, and prepare operational elements for commitment under OPCON of Cdr, 2d Bn, 9th SFG(A). Accept attachment of two SOTs A from Spt Co.

(c) () When directed, accept attachment of two CA DS teams and one SFOD from Co C and conduct FID operations in south central and southeastern Camargo (5th, 7th, and 8th Military Regions) to assist Camargo in defending itself against insurgency. Give priority of effort to the 7th Military Region.

(d) () When directed, conduct SO in response to actual or threatened PDRA aggression against Camargo. Give planning priorities, in order, to the following missions:

1. () Continue FID operations in south central and southeastern Camargo.

2. () Conduct DA and SR operations in support of conventional military operations. Give planning priority to battlefield surveillance, target acquisition, and interdiction of hostile LOC in south central and southeastern Camargo from PDRA to Atlantica.

(2) () Co B:

(a) () Provide forces on a rotational basis to conduct SA operations in Camargo under OPCON of SAO Camargo.

(b) () When directed, deploy to New London, Camargo, and prepare operational elements for commitment under OPCON of Cdr, 2d Bn, 9th SFG(A). Accept attachment of three DS CA teams and one SOT A from Spt Co.

(c) () When directed, accept attachment of one SFOD from Co C and conduct FID operations in northeastern and north central Camargo (4th, 9th, and 10th Military Regions) to assist Camargo in defending itself against insurgency. Give priority of effort to the 9th Military Region.

(CLASSIFICATION)

Figure C-1. Battalion Operation Plan (Continued).

 (CLASSIFICATION)

(d) () When directed, conduct SO in response to actual or threatened PDRA aggression against Camargo. Give planning priorities, in order, to the following missions:

1. () Continue FID operations in north central and northeastern Camargo.

2. () Conduct DA and SR operations in support of conventional military operations. Give planning priority to battlefield surveillance, target acquisition, and interdiction of hostile LOC in north central and northeastern Camargo from PDRA to Atlantica and from PDRA to Sargasso AFB, in that order.

(3) () Co C:

(a) () Provide forces on a rotational basis to conduct SA operations in Camargo under OPCON of SAO Camargo.

(b) () When directed, deploy to New London, Camargo, and prepare operational elements for commitment under OPCON of Cdr, 2d Bn, 9th SFG(A).

(c) () When directed, detach one SFOD each to Co A and Co B, accept attachment of one DS CA team, and conduct FID operations in western Camargo (1st, 2d, 3d, and 6th Military Regions) to assist Camargo in defending itself against insurgency. Give priority of effort to Camargan SOF in 1st Military Region.

(d) () Upon commitment of 21st Abn Corps into the AOR, release Co C Hq to serve as SOCCE at 21st Abn Corps Hq under OPCON of Cdr, 9th SFG(A). Pass OPCON of operational elements to Cdr, 2d Bn, 9th SFG(A).

(e) () When directed, conduct SO in response to actual or threatened PDRA aggression against Camargo. Give planning priorities, in order, to the following missions:

1. () Advise, assist, and support Camargan SOF in the conduct of SO in support of conventional military operations. Give planning priority to battlefield surveillance, target acquisition, and interdiction of hostile LOC from PDRA to Atlantica and from PDRA to Sargasso AFB, in that order.

2. () Continue FID operations in western Camargo.

(4) () Spt Co. GS. Accept attachment of one MP platoon from 1118th MP Co and one decon team from 5589th Cml Det.

 (CLASSIFICATION)

Figure C-1. Battalion Operation Plan (Continued).

(CLASSIFICATION)

- (5) () Engr Co. GS. Priority of support to main effort.
- (6) () PSYOP Tm. GS. Provide PSYOP staff element to S3, 2d Bn.
- (7) () CA Co (-). GS. Give priority of support to main effort.
- (8) () Med Co. GS. Give priority of support to main effort.

c. () Coordinating Instructions.

- (1) () Time zone used: ZULU.
- (2) () Conduct operations IAW 9th SFG(A) Readiness SOP and Field SOP.
- (3) () NBC. Prepare for operations in an NBC environment. Appendix 2 (NBC) to Annex B (Operations).
- (4) () Electronic warfare. Appendix 3 (EW) to Annex B (Operations).
- (5) () PSYOP. Appendix 4 (PSYOP) to Annex B (Operations).
- (6) () Deception. Appendix 7 (Deception) to Annex B (Operations).
- (7) () OPSEC. Annex H (OPSEC).
- (8) () This plan effective for planning upon receipt.

4. () SERVICE SUPPORT

a. () Concept of Sustainment. The 2d Bn, 9th SFG(A), deploys with 25 days of supplies. It receives its support from Naval Support Activity, New London, commencing D+14. It coordinates with 6th TASOSC to obtain support and sustainment unavailable from Naval Support Activity, New London, or FNS.

- b. () Logistics. Annex C (Logistics).
- c. () Personnel. Annex D (Personnel).
- d. () Public Affairs. Annex E (Public Affairs).
- e. () Civil Affairs. Annex F (Civil Affairs).

(CLASSIFICATION)

Figure C-1. Battalion Operation Plan (Continued).

(CLASSIFICATION)

5. () COMMAND AND CONTROL.

a. () Command Relationships.

(1) () COMSOCATL exercises OPCON of all SOF deployed into the AOR, less those elements under the OPCON of an in-country SAO.

(2) () In Phase III, most USATLCOM forces pass to the OPCON of SACATLDEFCON, but SOCATL and its assigned SOF remain under the OPCON of CINCUSATL. COMSOCATL exchanges liaison officers with allied SOF to effect mutual coordination of SO in the region.

(3) () The Cdr, 9th Army, exercises command less OPCON of 9th SFG(A).

b. () Command Posts.

(1) () Main CP is FOB2, New London.

(2) () Alternate CP is FOB3, Atlantica.

(3) () FOB2 is alternate SFOB.

c. () Succession of Command. 9th SFG(A) Field SOP.

d. () Signal. Annex G (Signal).

Healy
LTC, SF
Commander

Annexes: A INTELLIGENCE
B OPERATIONS
C LOGISTICS
D PERSONNEL
E PUBLIC AFFAIRS
F CIVIL AFFAIRS
G SIGNAL
H OPERATIONS SECURITY
I MAPPING, CHARTING, AND GEODESY
J EXECUTION CHECKLIST

DISTRIBUTION: Per SOP

OFFICIAL:
NORTON
MAJ, SF
S3

(CLASSIFICATION)

Figure C-1. Battalion Operation Plan (Continued).

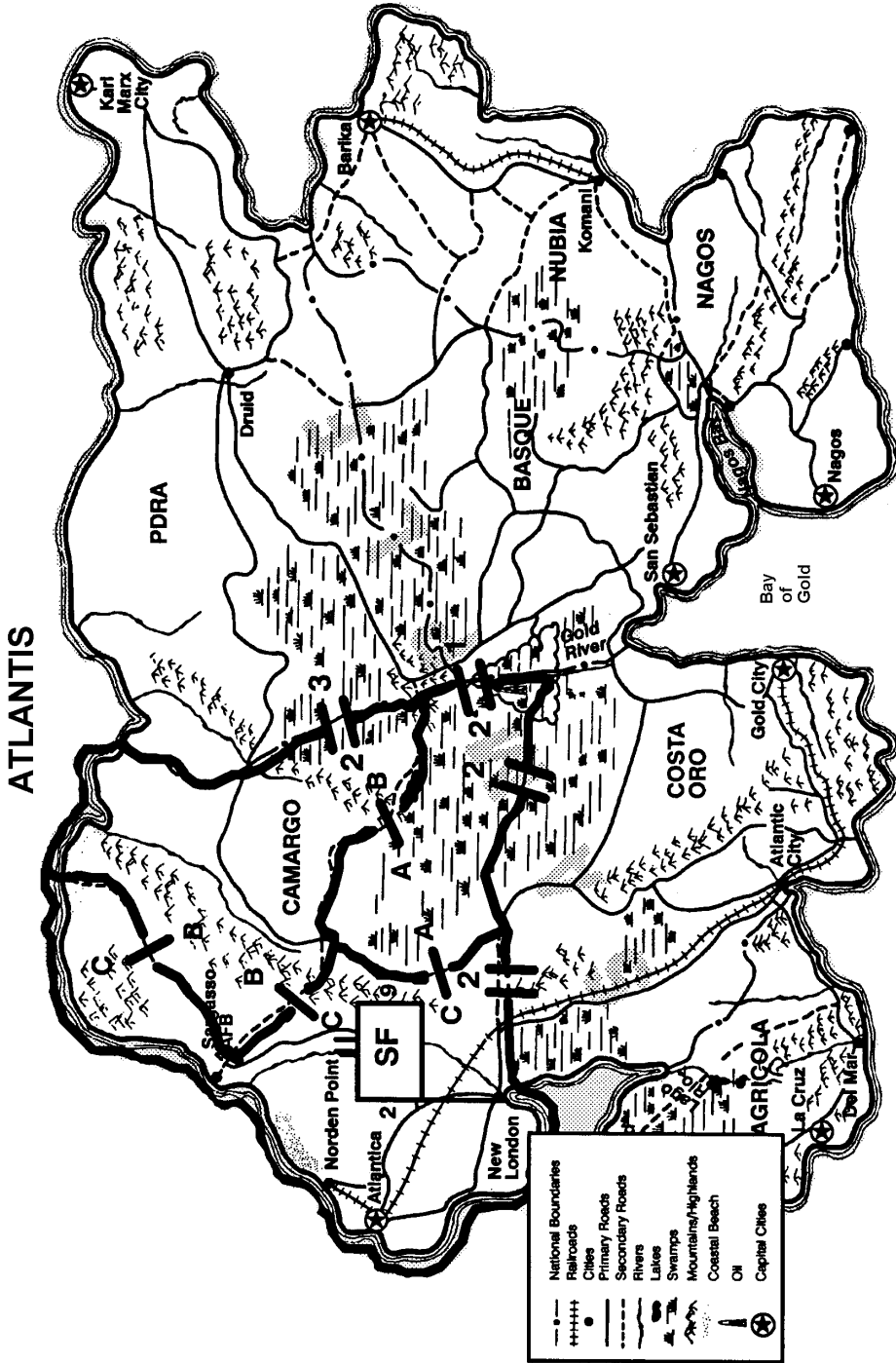

Appendix 1: (Group Overlay) to Annex B (Operations)

Figure C-1. Battalion Operation Plan (Continued).

APPENDIX D

Preliminary Assessment Format

(CLASSIFICATION)

COPY _____ OF _____ COPIES
SFG (A) 1ST SF
LOCATION _____
DATE _____

PRELIMINARY ASSESSMENT OF JSOA _____

SECTION I: MISSION

State the assigned or implied mission and purpose. List any intermediate tasks, prescribed or implied, that the supported commander considers necessary to accomplish the mission. Multiple missions must be stated in priority and intermediate tasks must be listed.

SECTION II: SITUATION AND COURSES OF ACTION (COAs)

This section is the foundation of the assessment. Discuss in each paragraph those conditions that impact on the capability of SOF to effectively accomplish the mission. Be concise but complete.

(CLASSIFICATION)

Figure D-1. Preliminary Assessment Format.

(CLASSIFICATION)

1. **Assumptions.** *Include any assumptions required as a basis for initiating planning. An assumption, while not fact, must have a basis in fact. Assumptions must be valid and essential to a solution to the problem.*

2. **Facts Affecting All Possible Courses of Action.** *Determine those facts of the situation that will influence friendly and hostile actions. This section is not meant to be the same as Part II (TIP) of the SOMPF and should reflect only those facts that are salient to the situation. Analyze each fact and deduce the probable effect on other facts and on hostile and friendly actions. Include the following, as appropriate (some categories may not be applicable or foreseeable during planning in peacetime):*

a. **Characteristics of the JSOA.** *Include analyses of the effects of pertinent characteristics of the JSOA.*

(1) **Weather.** *Analyze the effects of weather and light data on mission feasibility.*

(2) **Terrain.** *Analyze effects of terrain on hostile and friendly operations. Identify key terrain features and avenues of approach.*

(3) **Psychological.** *Analyze the psychological effect on friendly, hostile, and neutral nations as well as the support of the American public.*

(4) **Other pertinent factors.** *Identify political, economic, sociological, psychological, and other factors such as hydrography, environment, communications, science, technology, materiel, transportation, and manpower. Analyze their effects on friendly and hostile operations.*

b. **Hostile Situation.**

(1) **Dispositions.** *Identify locations of hostile forces, including fire support elements. Note differences between normal, alert, and deployed dispositions.*

(2) **Composition.** *Identify name, organization, and major equipment of hostile forces, including police, paramilitary, and internal security forces.*

(3) **Strength.** *State in the following terms:*

(a) **Committed forces.** *Note number and size of hostile units committed against friendly forces.*

(b) **Location of reinforcements and estimated reaction-times.**

(c) **NBC capabilities.**

(4) **Significant hostile activity.** *Summarize recent and current activities of hostile forces that may affect mission accomplishment. Consider such items as hostile employment of new or unconventional weapons, tactics, techniques, materiel, or troops.*

(CLASSIFICATION)

Figure D-1. Preliminary Assessment Format (Continued).

(CLASSIFICATION)

(5) Peculiarities and weaknesses. *Indicate hostile peculiarities and weaknesses that will favorably influence the mission.*

(6) Vulnerability to deception. *Indicate vulnerability of hostile forces to tactical and strategic deception (to include PSYOP).*

c. Friendly Situation. *Identify and analyze the same considerations as those included in b. above. State recent and present significant activities, peculiarities, and weaknesses and include such items as morale, training, personnel, and logistics. The information is usually in abbreviated form because it may be a repetition of what is generally known. Friendly dispositions are significant, however, and must be described in sufficient detail to determine how they influence the choice of a COA.*

3. Hostile Capabilities. *Identify and analyze COAs that hostile forces can physically perform and that could influence the accomplishment of the mission. Include exploitable hostile vulnerabilities.*

SECTION III: FRIENDLY COURSES OF ACTION

1. *The mission tasking packet may direct consideration of several COAs. Develop additional COAs as required. Formulate COAs using the following criteria as a guide:*

a. *Is the COA feasible?*

b. *Will the COA accomplish the mission without undue casualties?*

c. *Are the COAs outlined in sufficient detail to be distinguishable from each other for purposes of analysis?*

2. *State the COAs in broad terms initially. During analysis, add details, make revisions, and fully develop each COA. Include sufficient detail to distinguish one COA from another for subsequent analysis and comparison.*

SECTION IV: RISK VERSUS PROBABILITY OF SUCCESS (ANALYSIS OF COAs)

Analyze each of the postulated COAs to determine its advantages and disadvantages in terms of risk versus probability of success.

a. *The first part of the analysis should identify those hostile capabilities that must be considered when determining the best COA. Pay particular attention to those capabilities the hostile force is most likely to implement and those capabilities with the greatest adverse impact on mission success.*

(CLASSIFICATION)

Figure D-1. Preliminary Assessment Format (Continued).

(CLASSIFICATION)

b. *The second part of the analysis must analyze each possible friendly COA against each of the selected hostile capabilities to determine likely outcomes. Compare all candidate COAs. For each COA use one of two methods to list the advantages and disadvantages that emerged during analysis. The first method is to list each COA with all advantages and disadvantages. A second method of comparison is to isolate certain significant factors (such as terrain, time, and own force dispositions) and discuss all COAs under each significant factor. Conclude which COA offers the best prospect of success. Bear in mind, the completed TIP may confirm the COA chosen or indicate an alternate COA as a more desirable option.*

SECTION V: INTELLIGENCE REQUIREMENTS

List and prioritize essential intelligence (beyond that provided in the MTP) required to develop a POE.

SECTION VI: CRITICAL REQUIRED EQUIPMENT

List nonorganic equipment that is essential to mission success.

SECTION VII: INDIGENOUS SUPPORT

Indicate indigenous support that would increase probability of success.

SECTION VIII: COMMANDER'S ASSESSMENT

The MPA commander provides his assessment of the mission, to include specific answers to the following questions:

- a. *Is this a valid SOF mission?*
- b. *Is this mission within the MPA's current capability?*
- c. *Can this mission be accomplished within an acceptable degree of risk?*

(CLASSIFICATION)

Figure D-1. Preliminary Assessment Format (Continued).

APPENDIX E

Sample SOC Mission Letter

(CLASSIFICATION)

SPECIAL OPERATIONS COMMAND ATLANTIS
ATLANTICA, REPUBLIC OF CAMARGO
APO NEW YORK 99990

SOCATL 29 February 1988

MEMORANDUM FOR: Commander, 9th Special Forces Group (Airborne),
Fort Bragg, North Carolina 28307-5000

SUBJECT: SOCATL Mission Planning Guidance (U).

1. () References:

- a. () JSCP Annex E (Special Operations) (U).
- b. () SACATLDEFCON OPLAN 2640, ATLDEFCON Combined Theater Campaign Plan (U).
- c. () CINCUSATL OPLAN 2640, USATLCON Subordinate Campaign Plan (U).

(CLASSIFICATION)

Figure E-1. SOC Mission Letter.

(CLASSIFICATION)

d. () CINCUSATL CONPLAN 2641, USATLCOM Plan for Peacetime Contingency Operations (U).

e. () CINCUSATL OPLAN 2642, USATLCOM Plan for Military Operations in the Republic of Nuevo Bravo (U).

f. () CINCUSATL OPLAN 2643, USATLCOM Plan for Military Operations in the Republic of Camargo (U).

g. () CINCUSATL CONPLAN 2644, USATLCOM Plan for Military Operations in the People's Democratic Republic of Atlantis (PDRA) (U).

h. () CINCUSATL CONPLAN 2645, USATLCOM Noncombatant Evacuation Plan (U).

i. () CINCUSATL OPLAN 2646, USATLCOM Plan for Combatting Terrorism (U).

j. () CINCUSATL OPLAN 2647, USATLCOM Plan for Support of Drug Interdiction Activities (U).

k. () CINCUSATL OPLAN 2648, USATLCOM Plan for Support of Resistance in the Socialist Republic of Nagos (SRN) (U).

l. () COMSOCATL OPLAN 2640, SOCATL Subordinate Campaign Plan for Special Operations in the USATLCOM Area of Responsibility (AOR) (U).

2. () General.

a. () This memorandum provides the SOCATL concept for the employment of your group in the USATLCOM AOR. It specifies your responsibilities for deployment, employment, and sustainment. It identifies the high priority tasks for which you must train. (See Enclosure 1.)

b. () The SOCATL concept envisions the continued employment of your group to provide SA, support UNITN resistance, and support CN in the AOR. It assigns contingency missions for your group's commitment to perform FID and contingency operations. It provides options for your employment in a regional crisis or conflict that threatens US national interests and in a global crisis or conflict between the US and the USSR.

(CLASSIFICATION)

Figure E-1. SOC Mission Letter (Continued).

(CLASSIFICATION)

c. () The USSR has a significant capability to project its power and influence into the AOR from two client states, the PDRA and the SRN. Through the Blazing Torch Movement, the PDRA actively supports terrorism and insurgency in Nuevo Basque, Camargo, and Costa Oro. The PDRA and SRN both actively support the FLN insurgency in southern Nubia. The PDRA also has international drug trafficking ties with the Brotherhood crime syndicate in Agricola.

d. () The US national security strategy promotes collective security and protects US interests in the region. Specific US military strategic objectives are to--

(1) () Deter and, if necessary, successfully oppose PDRA and SRN attempts to achieve geopolitical gains by aggression and coercion.

(2) () Deny the USSR opportunities to expand its presence and influence.

(3) () Preserve and protect US and allied access to Atlantis oil resources.

(4) () Assist friendly governments to defend themselves against antidemocratic insurgencies.

(5) () Support selected resistance movements that enhance US interests.

(6) () Combat terrorism.

(7) () Support activities to interdict and eliminate drug trafficking.

e. () Three variables complicate the attainment of these objectives. These variables are the following:

(1) () In the event of regional crisis or conflict, will the crisis or conflict be confined to the Atlantis continent, or will it be before, concurrent with, or subsequent to crisis or conflict in other theaters?

(2) () In the event of regional or global crisis or conflict, will the USSR commit major forces in the theater?

(CLASSIFICATION)

Figure E-1. SOC Mission Letter (Continued).

 (CLASSIFICATION)

(3) () Will the NCA consider it feasible to commit major forces in the theater, or will the USATLCOM AOR be a secondary, economy-of-force theater?

f. () The ATLDEFCON campaign plan and USATLCOM subordinate campaign plan accommodate these three variables with their three-phased approach to military operations in the AOR. Your group is employed in all three phases.

(1) () In the ongoing Phase I (Minimum Force), CINCUSATL employs 1/9th SFG(A) and other forward deployed forces to plan, conduct, and support SA and other military operations in the AOR.

(2) () In Phase II (Deterrence), the NCA allocate additional forces to USATLCOM to credibly convey the US intent to successfully oppose any aggression by the PDRA or SRN against an allied or friendly nation. During this phase, the entire 9th SFG(A) deploys into the AOR. COMSOCATL expands Phase I activities. On order, he initiates SO to provide early warning of hostile aggression. In the event that deterrence fails and hostilities commence, COMSOCATL conducts SO against hostile forces to support the combined defense of key oil facilities in the region. COMSOCATL priorities are to interdict LOC, disrupt the movement of second-echelon forces from PDRA and/or SRN into the oil-rich Aciete Triangle area, and divert as many hostile forces as possible to rear area security missions.

(3) () In Phase III (Warfighting), major US forces deploy into the AOR to successfully oppose an attack by the PDRA to achieve geopolitical gains and/or disrupt US and allied access to Atlantis oil resources. During this phase, COMSOCATL conducts SO to support conventional military operations and pursue conflict termination on terms favorable to US and allied interests.

g. () In addition to preparing for the threats specified above, the entire 9th SFG(A) must prepare to respond to a wide range of unspecified threats in a "no plan" crisis. Actual crisis requirements may include SO, but your preparation priorities are--

(1) () CT operations.

(2) () SR operations.

 (CLASSIFICATION)

Figure E-1. SOC Mission Letter (Continued).

(CLASSIFICATION)

(3) () DA operations.

(4) () Disaster relief, noncombatant evacuation, SAR, and other HA operations.

3. () SOCATL Concept of Operations.

a. () Phase I is ongoing. COMSOCATL operates and maintains a joint FOB at San Sebastian, Nuevo Basque, to conduct joint and combined SO to--

(1) () Deter PDRA and SRN aggression and coercion.

(2) () Assist friendly Atlantica Pact governments to defend themselves against insurgency.

(3) () Combat terrorism in the region.

(4) () Support selected resistance movements that enhance US interests in the region.

(5) () Support regional activities to interdict and eliminate drug trafficking.

b. () On order, COMSOCATL conducts UW, DA, SR, and other SO to neutralize threats to US regional interests from the PDRA, SRN, and any other source. In the event of regional or global hostilities, COMSOCATL conducts SO in coordination with friendly regional forces and indigenous resistance movements to--

(1) Harass and disrupt USSR exploitation of the region's resources or geopolitical position.

(2) Divert as many hostile combat forces as possible to rear area security.

(3) Cause the PDRA and SRN to rely on force to impose and maintain control over any occupied territory.

4. () General Group Mission. Continue ongoing SO in the AOR. When directed, deploy the remainder of the group to designated locations in the AOR. On order, conduct SO in the USATLCOM AOR.

(CLASSIFICATION)

Figure E-1. SOC Mission Letter (Continued).

(CLASSIFICATION)

5. () Specific Mission Guidance.

a. () Force Operating Locations.

(1) () Phase I: One FOB at San Sebastian, Nuevo Basque.

(2) () Phase II: SFOB and one FOB collocated at Atlantica, Camargo. One FOB at New London, Camargo. One FOB at San Sebastian, Nuevo Basque.

(3) () Phase III: Same as Phase II. Be prepared to displace FOB at San Sebastian to La Cruz, Agricola.

b. () Readiness Standards.

(1) () Prepare forward deployed battalion to establish FOB at peacetime location in 24 hours (N+1), execute preplanned SO missions commencing N+4, and fully commit all operational elements NLT N+10.

(2) () Prepare remainder of group to deploy advance party in 24 hours (N+1) and main body in 72 hours (N+3), establish SFOB and two additional FOBs NLT N+5, execute preplanned SO missions commencing N+8, and fully commit all operational elements NLT N+14.

c. () Specified Operational Tasks.

(1) () Conduct SA operations in Nuevo Basque and Camargo IAW CINCUSATL OPLANS 2642 and 2643.

(2) () Provide in-theater CT response force IAW CINCUSATL OPLAN 2646.

(3) () Support regional CN IAW CINCUSATL OPLAN 2647.

(4) () Support UNITN resistance IAW CINCUSATL OPLAN 2648.

(5) () Establish caches and train Basque stay-behind forces to support UW in occupied Basque in the event that nation is overrun and occupied.

(CLASSIFICATION)

Figure E-1. SOC Mission Letter (Continued).

 (CLASSIFICATION)

d. () Specified Planning and Preparation Tasks.

(1) () Prepare to conduct FID operations to assist Nuevo Basque and Camargo in defending themselves against insurgency.

(2) () Prepare to conduct SO in response to actual or threatened PDRA and/or SRN aggression against Nuevo Basque and Camargo. Give planning priority, in order, to the following missions:

(a) () Continue to assist HN in internal defense.

(b) () Conduct SR in the PDRA and SRN to provide early warning of hostile attack.

(c) () Conduct DA operations in the PDRA and SRN to disrupt hostile preparations for attack and convey US intent to successfully oppose aggression in the region.

(d) () Conduct DA and SR operations in support of conventional military operations. Give planning priority to battlefield surveillance, target acquisition, and interdiction of hostile LOC from PDRA to Aciete Triangle, PDRA to Atlantica, and SRN to San Sebastian, in that order.

(e) () Support E&E activities, to include the preparation and servicing of safe areas.

(f) () Conduct special infiltration and recovery operations as directed by COMSOCATL.

(g) () Conduct special activities as directed by COMSOCATL.

(3) () Prepare to conduct or support UW operations with selected resistance elements in the PDRA to oppose PDRA attempts to achieve geopolitical gains by coercion.

(4) () Prepare for operations in (2) and (3) above in an NBC environment.

e. () Specified Area and Mission Orientations.

 (CLASSIFICATION)

Figure E-1. SOC Mission Letter (Continued).

 (CLASSIFICATION)

(1) () Primarily orient two companies of the forward deployed battalion to conduct SO in Nuevo Basque. Mission orientation is FID, SR, DA, UW, in that order. One company will be designated the theater CT response force IAW Ref j. Primarily orient the third forward-deployed company to conduct SO in the SRN. Mission orientation is UW, SR, DA, in that order. Each company will have at least one SFOD A with MFF capability and one SFOD A with combat diving capability. Each SFOD will have at least four personnel with / language proficiency in Spanish or Portuguese, as appropriate. All SOT A personnel will have / language proficiency. Remaining operational personnel will have / language proficiency.

(2) () Primarily orient one CONUS battalion to conduct SO in Camargo. Mission orientation is FID, SR, DA, UW, in that order. At least three SFODs A will have MFF capability. At least three SFODs A will have combat diving capability. Each SFOD will have at least four personnel with / language proficiency in Spanish. All SOT A personnel will possess / language proficiency. Remaining operational personnel will possess / language proficiency.

(3) () Primarily orient one CONUS battalion to conduct SO in the PDRA. Mission orientation is SR, DA, UW, in that order. At least five SFODs A will have MFF capability. At least five SFODs A will have combat diving capabilities. Each SFOD will have at least four personnel with / language proficiency in Celtic. All SOT A personnel will have / language proficiency. Remaining operational personnel will have / language proficiency.

6. () Sustainment.

a. () Minimize personnel turbulence and maintain unit integrity at the SFOD level to facilitate area orientation, language proficiency, and OPSEC.

b. () Coordinate directly with the Cdr, 6th TASOSC, to obtain the sustainment you require to accomplish your assigned tasks.

7. () Command and Control.

a. () COMSOCATL exercises OPCON of all SOF deployed into the AOR, less those elements under the OPCON of an in-country SAO.

 (CLASSIFICATION)

Figure E-1. SOC Mission Letter (Continued).

(CLASSIFICATION)

b. () In Phase III, most USATLCOM forces pass to the OPCON of the combined theater commander, SACATLDEFCON, but SOCATL and its assigned SOF remain under the OPCON of CINCUSATL. COMSOCATL exchanges liaison officers with allied SOF to effect mutual coordination of SO in the region.

c. () The Cdr, 9th Army, exercises direct command less OPCON of all ARSOF deployed into the AOR. Direct coordination between you and Cdr, 6th TASOSC, is authorized and required to ensure you monitor the readiness of 1/9th SFG(A).

d. () When deployed, your SFOB will retain direct OPCON of sufficient SFODs to execute SPECAT missions listed in paragraphs 6d(2)(e), 6d(2)(f), and 6d(2)(g).

8. () Other Responsibilities.

a. () Advise and assist COMSOCATL and his staff in their efforts to observe training and operations, develop exercises, and implement other programs he deems necessary to maintain and enhance the readiness of your command.

b. () Submit a supporting OPLAN for COMSOCATL OPLANS to COMSOCATL for approval within 90 days of notification that CINCUSATL has approved a new COMSOCATL OPLAN.

c. () Advise COMSOCATL of any shortfalls in your ability to meet your assigned tasks.

Encl

VOLCKMANN
Brigadier General, USA
Commander

(CLASSIFICATION)

Figure E-1. SOC Mission Letter (Continued).

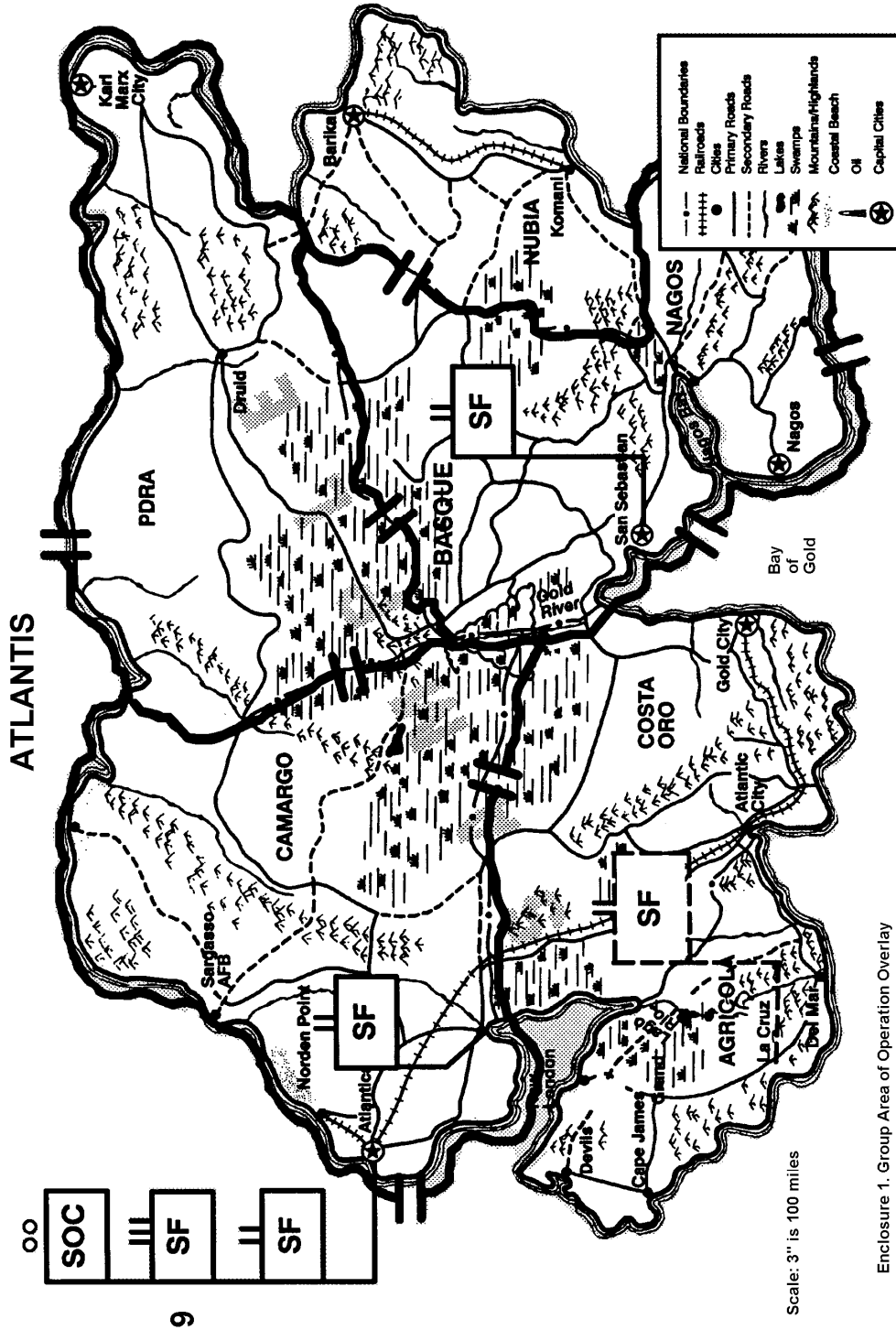

Figure E-1. SOC Mission Letter (Continued).

Enclosure 1. Group Area of Operation Overlay

APPENDIX F

Sample Group Mission Letter

(CLASSIFICATION)

DEPARTMENT OF THE ARMY
HEADQUARTERS, 9TH SPECIAL FORCES GROUP (AIRBORNE)
1ST SPECIAL FORCES
FORT BRAGG, NORTH CAROLINA 28307-5000

AANS-SC 23 June 1988

MEMORANDUM FOR Commander, 3d Battalion, 9th Special Forces Group
(Airborne), Fort Bragg, North Carolina 28307-5000

SUBJECT: 3d Battalion Mission Planning Guidance (U)

1. () References.

a. () COMSOCATL OFLAN 2640, SOCATL Subordinate Campaign Plan for
Special Operations in the USATLCOM AOR (U).

b. () SOCATE Memorandum, Subj: 9th SFG(A) Mission Planning
Guidance (U), dtd 29 Feb 88.

(CLASSIFICATION)

Figure F-1. Group Mission Letter.

(CLASSIFICATION)

c. () 9th SFG(A) OPLAN 2640, Major Operations Plan for Special Operations in the USATLCOM AOR (U).

d. () 9th SFG(A) Field Readiness SOP, dtd 18 Dec 87.

e. () 9th SFG(A) Field SOP, dtd 15 Jan 88.

f. () 9th SFG(A) LOI, Subj: Area Study and Mission Planning Program, dtd 15 Jul 87.

2. () General.

a. () This memorandum provides specific guidance regarding the planning, training, and preparation of your SFODs for employment in the USATLCOM AOR. It identifies SFOD special skills and missions, area orientations, and high priority tasks.

b. () This mission letter assumes that your battalion remains at authorized level of organization (ALO) 1 and that all assigned personnel and equipment are available for employment. You will coordinate with the group cdr to modify mission priorities if this assumption becomes invalid.

3. () Mission. Continue to support SO in the AOR. Prepare assigned elements for employment IAW 9th SFG(A) OPLAN 2640. When directed, deploy to Atlantica, Camargo; establish and operate FOB3 collocated with the SFOB; and conduct SO in your assigned JSOA.

4. () Execution.

a. () Concept of the Operation. See Ref c.

(1) () Primarily orient your battalion to conduct SO in the PDRA (see Enclosure 1 for specific JSOA). Mission orientation is SR, DA, UW, in that order. Co A will maintain two SFODs with combat diving capability. Co B will maintain two SFODs with MFF capability. Co C will maintain two SFODs with combat diving capability. Spt Co will maintain three SOTs A, one with MFF capability. Each SFOD in the battalion will have at least four personnel with / language proficiency in Celtic. All SOT A personnel will have at least /

(CLASSIFICATION)

Figure F-1. Group Mission Letter (Continued).

(CLASSIFICATION)

language proficiency. Remaining battalion operational personnel will have language proficiency.

(2) () Prepare to deploy the battalion advance party in 24 hours (N+1) and main body in 48 hours (N+2), establish FOB3 NLT N+4, execute preplanned SO missions commencing N+7, and fully commit all operational elements NLT N+14.

b. () Specified Tasks.

(1) () Provide one SFOD B and four SFODs A on a rotational basis to conduct SA operations in Camargo.

(2) () Prepare, IAW Ref e, to conduct SO in response to actual or threatened PDRA aggression against Nuevo Basque or Camargo. Give planning priorities, in order, to the following missions:

(a) () Conduct SR in the PDRA to provide early warning of hostile attack.

(b) () Conduct DA operations in the PDRA to disrupt hostile preparations for attack and convey US intent to successfully oppose aggression against Camargo.

(c) () Conduct DA and SR operations in support of conventional military operations. Give planning priority to battlefield surveillance, target acquisition, and interdiction of hostile LOC from the PDRA to Aciete Triangle and from the PDRA to Atlantica, in that order.

(3) () Prepare to conduct or support UW operations with selected resistance elements in the PDRA to oppose PDRA attempts to achieve geopolitical gains by coercion.

(4) () Prepare for operations in (2) and (3) above in an NBC environment.

(5) () On order, release Co A and two SFODs A from Co B for employment under OPCON of Cdr, 9th SFG(A), to execute SPECAT missions listed in Ref c.

(CLASSIFICATION)

Figure F-1. Group Mission Letter (Continued).

(CLASSIFICATION)

(6) () On order, release Co B Hq to establish and operate group ISOFAC under OPCON of Cdr, 9th SFG(A).

c. () Coordinating Instructions.

(1) () Ensure each SFOD has at least four current jumpmasters. Each MFF-capable SFOD must have at least two current MFF jumpmasters. Each combat-diving-capable SFOD must have at least two diving supervisors and one diving medical technician.

(2) () Maintain trained battalion and company air movement control teams IAW Ref d.

(3) () Establish and sustain a battalion area study and mission planning program IAW Ref e.

(4) () Review this mission letter at least annually and recommend changes to the group S3.

(5) () Perform a battalion mission analysis at least annually and provide the group S3 with an updated battalion METL.

(6) () Advise the Cdr, 9th SFG(A), of any shortfalls in your ability to meet your assigned tasks.

5. () Training Guidance. Focus your training to establish and maintain SFOD readiness. Conduct consolidated battalion or company training only when absolutely necessary. Ensure SFOD training is realistic and oriented on the priority missions identified above. Each SFOD will participate in at least one live fire exercise and one field training exercise each quarter. Each SFOD and SOT A will perform at least one week of area study and mission planning semiannually.

Encl

BANK
Col, SF
Commander

(CLASSIFICATION)

Figure F-1. Group Mission Letter (Continued).

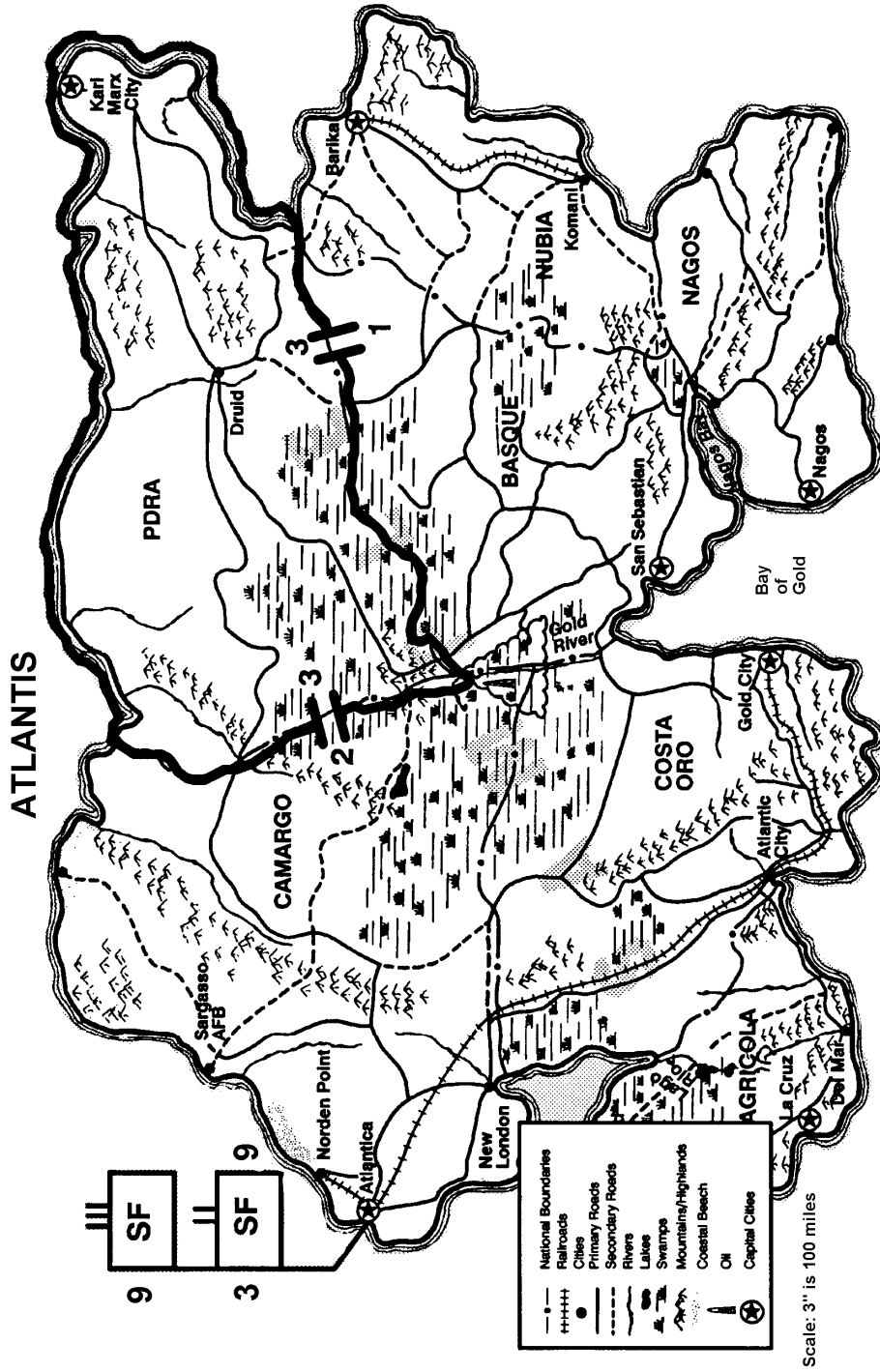

Enclosure 1. Battalion Area of Operation Overlay.

Figure F-1. Group Mission Letter (Continued).

APPENDIX G

Sample Battalion Mission Letter

(CLASSIFICATION)

DEPARTMENT OF THE ARMY
HEADQUARTERS, 1ST BATTALION
9TH SPECIAL FORCES GROUP (AIRBORNE)
1ST SPECIAL FORCES
APO NEW YORK 99999

AANS-C-SC 6 July 1988

MEMORANDUM FOR Commander, Company A, 1st Battalion, 9th Special
Forces Group (Airborne), APO New York 99999

SUBJECT: Company A Mission Planning Guidance (U)

1. () References.

a. () COMSOCATL OPLAN 2640, SOCATL Subordinate Campaign Plan for
Special Operations in the USATLCOM AOR (U).

b. () SOCATL Memorandum, Subj: 1st Bn, 9th SFG(A), Mission Plan-
ning Guidance (U), dtd 29 Feb 88.

(CLASSIFICATION)

Figure G-1. Battalion Mission Letter.

(CLASSIFICATION)

c. () 9th SFG(A) OPLAN 2640, Major Operations Plan for Special Operations in the USATLCOM AOR (U).

d. () 9th SFG(A) Readiness SOP, dtd 18 Dec 87.

e. () 9th SFG(A) Field SOP, dtd 15 Jan 88.

f. () 9th SFG(A) LOI, Subj: Area Study and Mission Planning Program, dtd 15 Jul 87.

2. () General.

a. () This memorandum provides specific guidance regarding the planning, training, and preparation of your SFODs for employment in the USATLCOM AOR. It identifies SFOD special skills and missions, area orientations, and high priority tasks.

b. () This mission letter assumes that your company remains at ALO 1 and that all assigned personnel and equipment are available for employment. You will coordinate with the battalion cdr to modify mission priorities if this assumption becomes invalid.

3. () Mission. Continue ongoing SO in the AOR. Prepare assigned elements for employment IAW 9th SFG(A) OPLAN 2640. When directed, conduct SO in your assigned sectors.

4. () Execution.

a. () Concept of the Operation. See Ref c.

(1) () Primarily orient your company to conduct SO in the SRN (see Enclosure 1 for specific sectors). Mission orientation is UW, SR, DA, in that order. Maintain one SFOD with MFF capability and one SFOD with combat diving capability. Each SFOD in the company will have at least four personnel with __/__ language proficiency in Portuguese. Remaining company operational personnel will have __/__ language proficiency.

(2) () Prepare to execute preplanned SO missions commencing N+4, and fully commit all operational elements NLT N+10.

(CLASSIFICATION)

Figure G-1. Battalion Mission Letter (Continued).

(CLASSIFICATION)

b. () Specified Tasks.

(1) () Provide one SFOD B and two SFODs A to conduct a special activity in support of the UNITN resistance by operating a UW training center in Nuevo Basque.

(2) () Prepare IAW Ref c to conduct SO in response to actual or threatened SRN aggression against Nuevo Basque. Give planning priorities, in order, to the following missions:

(a) () Conduct SR in the SRN to provide early warning of hostile attack.

(b) () Conduct DA operations in the SRN to disrupt hostile preparations for attack and convey US intent to successfully oppose aggression against Nuevo Basque.

(c) () Conduct DA and SR operations in support of conventional military operations. Give planning priority in support of UW operations, battlefield surveillance, target acquisition, and interdiction of hostile LOC sustaining an SRN attack toward San Sebastian.

(3) () Prepare for operations in (2) above in an NBC environment.

c. () Detachment Missions.

(1) () SFOD B11. Prepare to advise, assist, and support the UNITN area command in central SRN and to command and control the UW activities of up to four SFODs and two SOTs A. Plan to conduct this mission as a clandestine operation.

(2) () SFOD A111. Prepare to conduct low-visibility or clandestine UW operations in northeastern SRN, either independently or under the OPCON of SFOD B11.

(3) () SFOD A112. Prepare to conduct low-visibility or clandestine UW operations in southeastern SRN, either independently or under the OPCON of SFOD B11.

(CLASSIFICATION)

Figure G-1. Battalion Mission Letter (Continued).

(CLASSIFICATION)

(4) () SFOD A113. Prepare to conduct clandestine UW operations in western SRN, either independently or under the OPCON of SFOD B11.

(5) () SFOD A114. Prepare to conduct clandestine UW operations in the vicinity of the capitol of Nagos, either independently or under the OPCON of SFOD B11.

(6) () SFOD A115. Prepare to conduct clandestine SR and DA operations in western and central SRN. Maintain combat diving capability.

(7) () SFOD A116. Prepare to conduct clandestine SR and DA operations in western and central SRN. Maintain MFF capability.

d. () Coordinating Instructions.

(1) () Ensure each SFOD has at least four current jumpmasters. SFOD A116 must have at least two current MFF jumpmasters. SFOD A115 must have at least two diving supervisors and one diving medical technician.

(2) () Maintain a trained company air movement control team IAW Ref d.

(3) () Establish and sustain a company area study and mission planning program IAW Ref e.

(4) () Specific SFOD and SOT A tasks and mission priorities can be found in the battalion METL and in applicable SOMPFs maintained by the battalion AST.

(5) () Review this mission letter at least annually and recommend changes to the battalion S3.

(6) () Perform a company mission analysis at least annually and provide the battalion S3 with an updated METL.

(7) () Advise the Cdr, 1st Bn, 9th SFG(A), of any shortfalls in your ability to meet your assigned tasks.

(CLASSIFICATION)

Figure G-1. Battalion Mission Letter (Continued).

(CLASSIFICATION)

5. () Training Guidance. Focus your training to establish and maintain SFOD readiness. Conduct consolidated company training only when absolutely necessary. Ensure SFOD training is realistic and oriented on the priority missions identified above. Each SFOD will participate in at least one live fire exercise and one field training exercise each quarter. Each SFOD will perform at least one week of area study and mission planning semiannually.

Encl

KING
LTC, SF
Commander

SAMPLE

(CLASSIFICATION)

Figure G-1. Battalion Mission Letter (Continued).

ATLANTIS

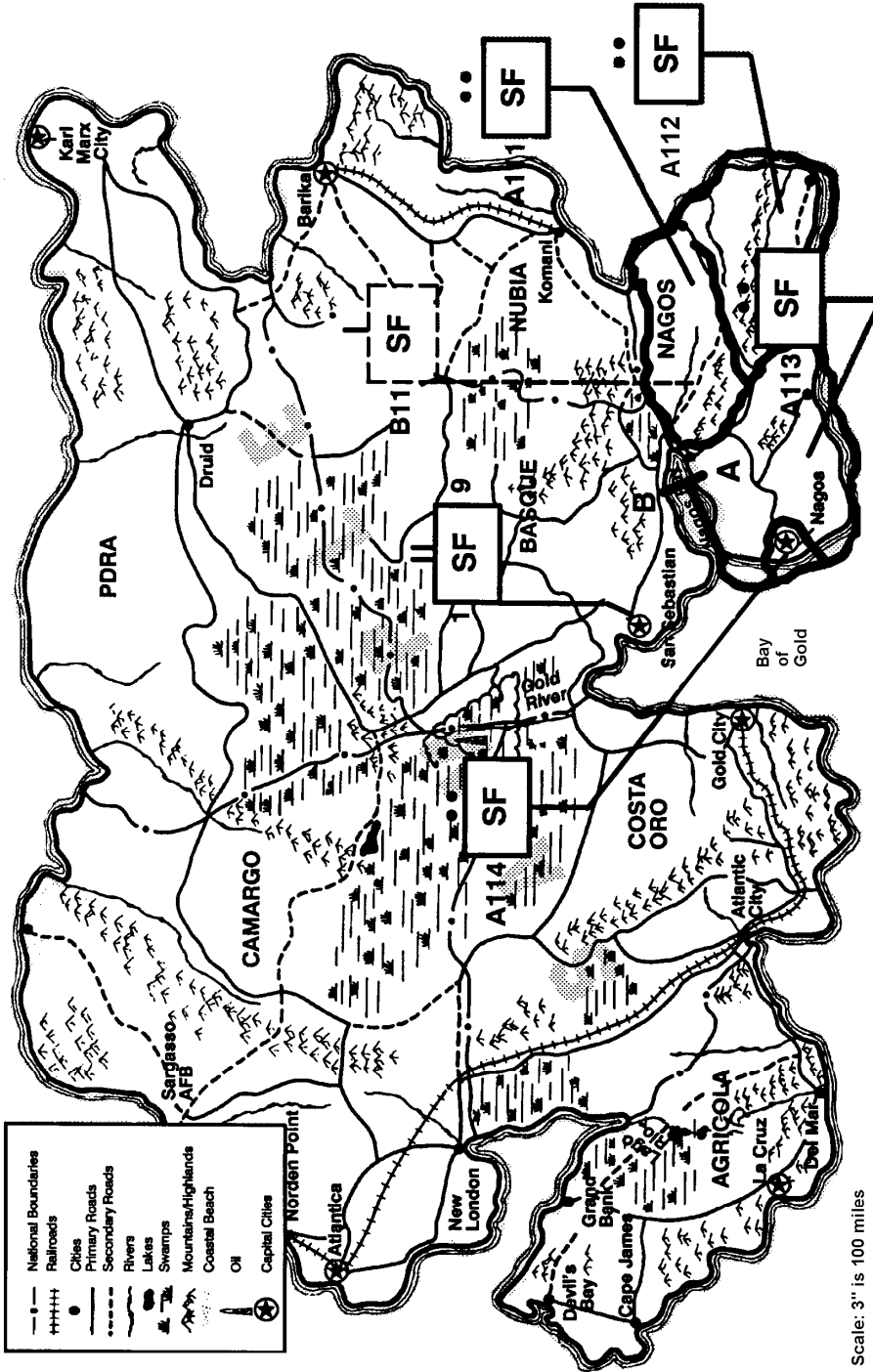

Enclosure 1. Company Area of Operations Overlay.

Figure G-1. Battalion Mission Letter (Continued).

APPENDIX H

Special Forces Mission Briefback Format

This appendix provides an outline format for an SF mission briefback. It can also be used by a group or battalion staff to prepare an initial mission briefing. It is a systematic means for presenting

information about a specific SF mission. The basic outline is general but is flexible enough to be used for any doctrinal SF mission. The user must modify the outline by deleting portions that do not apply.

<p>Commander</p>	<ul style="list-style-type: none"> • Purpose of Briefing. • Mission as Stated in the OPORD. • Politico-Military Implications of Mission. • Higher Commander's Intent. • Detachment Commander's Intent. • Organization of Team's Chain of Command and Assigned Responsibility. • Attachments and Detachments.
<p>S2 or Intelligence Sergeant</p>	<ul style="list-style-type: none"> • Description of the JSOA. • Intelligence Preparation of the Battlefield. <ul style="list-style-type: none"> - Threat evaluation. <ul style="list-style-type: none"> • Threat identification. • Additions to the initial threat data base.

Figure H-1. Sample SF Mission Briefback.

<p>S2 or Intelligence Sergeant</p> <p>(continued)</p>	<ul style="list-style-type: none"> • Determination of current order of battle (overlay). • Disposition, composition, and strength of committed forces and reinforcements (identify each unit by category). • Hostile force capabilities, intentions, and activities (air, ground, water, NBC). • Hostile populace and resource control measures. <ul style="list-style-type: none"> - Civilian population. - Capabilities, vulnerabilities, intentions, and activities of supported indigenous force. - The effects of terrain and weather on both friendly and hostile forces in the JSOA. (Use terrain overlays as appropriate.) - Threat integration and probable course of hostile action. <ul style="list-style-type: none"> • PIR and IR. • EEFI. • Team Intelligence Activities in the JSOA (Include Defensive CI Activities).
---	--

<p>S3 or Operations Sergeant</p>	<ul style="list-style-type: none"> • Command and Support Relationships in the JSOA. • Concept of Operations. • Rules of Engagement. • Infiltration Plan. <ul style="list-style-type: none"> - Point of no return (PONR). - Contingency plan. <ul style="list-style-type: none"> • In-flight abort plan (include recall procedures). • Crash and/or forced landing before PONR. • Crash and/or forced landing after PONR. - Primary and alternate points of entry. - Contingency plan at entry points. - Assembly plan. <ul style="list-style-type: none"> • On primary and alternate points of entry. • Disposition of excess items (for example scuba and air items).
---	---

Figure H-1. Sample SF Mission Briefback (Continued).

<p>S3 or Operations Sergeant</p> <p>(continued)</p>	<ul style="list-style-type: none"> - Contact plans. <ul style="list-style-type: none"> • Primary. • Alternate. • Contingency. - Movement plans. <ul style="list-style-type: none"> • From points of entry to contact site (if needed). • From contact site to operational area. - Security plans. - Specific duties of contact team, bundle recovery team, and other specialized teams. • Training Plan. <ul style="list-style-type: none"> - Tentative plan to train indigenous force. - Program of instruction. <ul style="list-style-type: none"> • Individual. • Collective. • Leader. • Combat Operations (Only if Preplanned Targets Are Included). <ul style="list-style-type: none"> - Concept of the operation. - Routes to and from the target. - Security plan. - Actions at the objective (overall concept). If a demolition target, the demolition sergeant briefs; if a raid and/or ambush, the weapons sergeant briefs. - Withdrawal. • Linkup or Exfiltration Plan. <ul style="list-style-type: none"> - Primary. - Alternate. - Contingency. • Demobilization Plan. <ul style="list-style-type: none"> - PSYOP. - Deception. - OPSEC.
---	--

Figure H-1. Sample SF Mission Briefback (Continued).

<p>S1 or Detachment Technician</p> <p>(continued)</p>	<ul style="list-style-type: none"> ● Personnel Status. <ul style="list-style-type: none"> - Assigned strength. - Shortage by MOS. - Cross-trained personnel. ● Discipline, Law, and Order. <ul style="list-style-type: none"> - Court martial and Article 15 jurisdiction if an exception to SOP. - Known indigenous force policy concerning discipline and law and order. - Legal status of team in the JSOA. ● Disposition of PWs in the JSOA. ● Graves Registration. <ul style="list-style-type: none"> - US personnel. - Indigenous personnel (state or local customs). ● Morale and Personnel Services (if Other Than SOP). <ul style="list-style-type: none"> - Personnel records check. - Mail handling. - Promotions. - Comfort items. - Replacements and augmentations. - Pay and allowances. ● Operational Fund. ● Indigenous Force Strength. ● Indigenous Force Discipline and Law and Order. ● Processing of the Indigenous Force. <ul style="list-style-type: none"> - Oath of allegiance. - Records to be kept. <ul style="list-style-type: none"> • Pay. • Training. • Miscellaneous. - Identification photographs.
---	---

Figure H-1. Sample SF Mission Briefback (Continued).

<p>S4 or Supply Sergeant</p>	<ul style="list-style-type: none"> ● Supplies and Equipment. <ul style="list-style-type: none"> – Disposition of equipment and personal items not accompanying the team. – Special mission equipment issued to the team. – Cross-load plan (overall). ● Resupply Plans. <ul style="list-style-type: none"> – Automatic resupply. <ul style="list-style-type: none"> • Schedule. • Drop zone data and/or delivery means. • Recovery plan. – On-call resupply. <ul style="list-style-type: none"> • Schedule. • Drop zone data and/or delivery means. • Recovery plan. – Emergency resupply and conditions for implementation. – Existing logistical nets in the JSOA. – Indigenous logistics plan.
<p>S5 or Civil Affairs NCO</p>	<ul style="list-style-type: none"> ● Status of Local Government in the JSOA. ● Status of Shadow Resistance Government in the JSOA. ● Requirements for Interagency Coordination in the JSOA. ● Plans to Minimize Civilian Interference with the Mission. ● Plans to Protect Cultural Properties in the JSOA. ● Plans to Develop the Auxiliary in the JSOA. ● Plans to Develop Civil Defense Groups in the JSOA. ● Humanitarian and Civil Assistance Plans. ● Military Civic Action Plans.
<p>PSYOP Officer or NCO</p>	<ul style="list-style-type: none"> ● Target Audiences. <ul style="list-style-type: none"> – Uncommitted. – Hostile sympathizers. – Hostile military forces. – Resistance sympathizers. ● Approved Themes and Messages for Each Target Audience. ● Themes and Messages To Be Avoided. ● Media Production and Dissemination Means Available in the JSOA. ● PYSOP Materiel To Accompany Team.

Figure H-1. Sample SF Mission Briefback (Continued).

<p>Communications Sergeant</p>	<ul style="list-style-type: none"> ● Signal Equipment and Supplies To Accompany Detachment. <ul style="list-style-type: none"> - Status of equipment. - Cross-load plan. ● Communications Plan and Procedures. <ul style="list-style-type: none"> - Scheduled contacts. - Mandatory reports to the SFOB or the FOB. - Alternate encryption system. - Emergency communications system and procedures. - Security. <ul style="list-style-type: none"> • Site security. • Transmission security. • Cryptographic security. - Internal team communications. ● Communications Training Plan. ● Existing Communications in the JSOA.
<p>Medical Sergeant</p>	<ul style="list-style-type: none"> ● Health Status of Team. ● Medical Supplies and Equipment To Accompany Team. <ul style="list-style-type: none"> - Cross-load plan. - Individual medical equipment and supplies. ● Estimate of the Medical Situation in the JSOA. <ul style="list-style-type: none"> - Indigenous force health. - Preventive medicine. - Health hazards in the JSOA. - Food and nutrition in the JSOA. - Indigenous medical personnel and facilities. ● Medical Logistical Plan. ● Medical Training Plan. <ul style="list-style-type: none"> - Indigenous individual soldiers. - Indigenous medics. - Clandestine treatment center personnel.

Figure H-1. Sample SF Mission Briefback (Continued).

<p>Engineer Sergeant</p>	<ul style="list-style-type: none"> ● Engineer Equipment and Supplies To Accompany Team. <ul style="list-style-type: none"> - Status of equipment. - Cross-load plan. ● Estimate of Area Potential To Support Demolitions and Engineer Requirements. ● Mission Planning Folder (CARVER Overlay). ● CARVER Analysis of Potential Targets. ● Availability of Supplies in the JSOA. ● Engineer Training Plan. <ul style="list-style-type: none"> - Individual. - Collective. - Leader.
<p>Weapons Sergeant</p>	<ul style="list-style-type: none"> ● Weapons and Tactical Equipment To Accompany Team. <ul style="list-style-type: none"> - Status of weapons and tactical equipment. - Basic load of ammunition. - Cross-load plan. ● Estimate of Area Potential To Provide Additional Weapons, Ammunition, and Tactical Equipment. ● Security. <ul style="list-style-type: none"> - Assembly area (if not in SOP). - Contact areas (if not in SOP). - Tentative base camp security plans. ● Weapons and Tactics Training Plan. <ul style="list-style-type: none"> - Individual. - Collective. - Leader.
<p>Commander</p>	<ul style="list-style-type: none"> ● Closing Statement. <ul style="list-style-type: none"> - Readiness posture of team. - Unresolved issues or concerns (if none, so state). ● Questions.

Figure H-1. Sample SF Mission Briefback (Continued).

APPENDIX I

Area Study Outline Format

This appendix provides an outline format for an area study. This format provides a systematic means for compiling and retaining essential information to support SF operations. Although the basic outline is general, it is flexible enough to permit detailed

coverage of a given operational area. As time is made available for further study, various subjects should be subdivided and assigned to selected detachment members to produce a more detailed analysis of specified areas of interest.

<p>_____ (CLASSIFICATION)</p>	<p>COPY _____ OF _____ COPIES SFG(A) 1ST SF LOCATION DATE</p>
<p>AREA STUDY OF JSOA _____</p>	
<p>1. PURPOSE AND LIMITING FACTORS.</p>	
<p>a. Purpose. <i>Delineate the area being studied.</i></p>	
<p>b. Mission. <i>State the mission the area study supports.</i></p>	
<p>c. Limiting factors. <i>Identify factors that limit the completeness or accuracy of the area study.</i></p>	
<p>_____ (CLASSIFICATION)</p>	

Figure I-1. Outline for a General Area Study.

(CLASSIFICATION)

2. GEOGRAPHY, HYDROGRAPHY, AND CLIMATE. *Divide the operational area into its various definable subdivisions and analyze each subdivision using the subdivisions shown below.*

a. Areas and Dimensions.

b. Strategic Locations.

(1) Neighboring countries and boundaries.

(2) Natural defenses including frontiers.

(3) Points of entry and strategic routes.

c. Climate. *Note variations from the norm and the months in which they occur. Note any extremes in climate that would affect operations.*

(1) Temperature.

(2) Rainfall and snow.

(3) Wind and visibility.

(4) Light data. *Include beginning morning nautical twilight (BMNT), ending evening nautical twilight (EENT), sunrise, sunset, moonrise, and moonset.*

(5) Seasonal effect of the weather on terrain and visibility.

d. Relief.

(1) General direction of mountain ranges or ridge lines and whether hills and ridges are dissected.

(2) General degree of slope.

(3) Characteristics of valleys and plains.

(4) Natural routes for and natural obstacles to cross-country movement.

(5) Location of area suitable for guerrilla bases, units, and other installations.

(6) Potential landing and drop zones and other reception sites.

(CLASSIFICATION)

Figure I-1. Outline for a General Area Study (Continued).

 (CLASSIFICATION)

 e. Land Use. *Note any peculiarities especially in the following.*

(1) Former heavily forested areas subjected to widespread cutting or dissected bypaths and roads. *Also note the reverse, pastureland or wasteland that has been reforested.*

(2) Former wasteland or pastureland that has been resettled and cultivated and is now being farmed. *Also note the reverse, former rural countryside that has been depopulated and allowed to return to wasteland.*

(3) Former swampland or marshland that has been drained; former desert or wasteland now irrigated and cultivated; and lakes created by dams.

f. Drainage (General Pattern).

(1) Main rivers, direction of flow.

(2) Characteristics of rivers and streams. *Include widths, currents, banks, depths, kinds of bottoms, and obstacles.*

(3) Seasonal variations. *Note dry beds, flash floods.*

(4) Large lakes or areas with many ponds or swamps. *Include potential LZs for amphibious aircraft.*

 g. Coast. *Examine primarily for infiltration, exfiltration, and resupply points.*

(1) Tides and waves. *Include winds and current.*

(2) Beach footing and covered exit routes.

(3) Quiet coves and shallow inlets or estuaries.

h. Geological Basics. *Identify types of soil and rock formations. Include areas for potential LZs for light aircraft.*

i. Forests and Other Vegetation.

(1) Natural or cultivated.

(2) Types, characteristics, and significant variations from the norm at different elevations.

(3) Cover and concealment. *Include density and seasonal variations.*

 (CLASSIFICATION)

Figure I-1. Outline for a General Area Study (Continued).

(CLASSIFICATION)

j. Water. *Note ground, surface, seasonal, potability.*

k. Subsistence.

- (1) Seasonal or year round.
- (2) Cultivated. *Include vegetables, grains, fruits, and nuts.*
- (3) Natural. *Include berries, fruits, nuts, and herbs.*
- (4) Wildlife. *Include animals, fish, and fowl.*

3. POLITICAL CHARACTERISTICS. *Identify friendly and hostile political powers and analyze their capabilities, intentions, and activities that influence mission execution.*

a. Hostile Power.

- (1) Number and status of nonnational personnel.
- (2) Influence, organization, and mechanisms of control.

b. National Government (indigenous).

(1) Government, international political orientation, and degree of popular support.

(2) Identifiable segments of the population with varying attitudes and probable behavior toward the United States, its allies, and the hostile power.

(3) National historical background.

(4) Foreign dependence or alliances.

(5) National capital and significant political, military, and economic concentrations.

c. Political Parties.

- (1) Leadership and organizational structure.

(CLASSIFICATION)

Figure I-1. Outline for a General Area Study (Continued).

(CLASSIFICATION)

(2) Nationalistic origin and foreign ties (if a single dominant party exists).

(3) Major legal parties with their policies and goals.

(4) Illegal or underground parties and their policies and goals.

(5) Violent opposition factions within major political organizations.

d. Control and Restrictions.

(1) Documentation.

(2) Rationing.

(3) Travel and movement restrictions.

(4) Blackouts and curfews.

(5) Political restrictions.

(6) Religious restrictions.

4. ECONOMIC CHARACTERISTICS. *Identify those economic factors that influence mission execution.*

a. Technological Standards.

b. Natural Resources and Degree of Self-Sufficiency.

c. Financial Structure and Dependence on Foreign Aid.

d. Monetary System.

(1) Value of money, rate of inflation.

(2) Wage scales.

(3) Currency controls.

e. Black Market Activities. *Note the extent and effect of those activities.*

f. Agriculture and Domestic Food Supply.

(CLASSIFICATION)

Figure I-1. Outline for a General Area Study (Continued).

(CLASSIFICATION)

- g. Industry and Level of Production.
 - h. Manufacture and Demand for Consumer Goods.
 - i. Foreign and Domestic Trade and Facilities.
 - j. Fuels and Power.
 - k. Telecommunications and Radio Systems.
 - l. Transportation Adequacy by US Standards.
 - (1) Railroads.
 - (2) Highways.
 - (3) Waterways.
 - (4) Commercial air installations.
 - m. Industry, Utilities, Agriculture, and Transportation. *Note the control and operation of each.*
5. CIVIL POPULACE. *Pay particular attention to those inhabitants in the operational area who have peculiarities and who vary considerably from the normal national way of life.*
- a. Total and Density.
 - b. Basic Racial Stock and Physical Characteristics.
 - (1) Types, features, dress, and habits.
 - (2) Significant variations from the norm.
 - c. Ethnic and/or Religious Groups. *Analyze these groups to determine if they are of sufficient size, cohesion, and power to constitute a dissident minority of some consequence.*
 - (1) Location or concentration.
 - (2) Basis for discontent and motivation for change.
 - (3) Opposition to the majority or the political regime.
 - (4) Any external or foreign ties of significance.

(CLASSIFICATION)

Figure I-1. Outline for a General Area Study (Continued).

(CLASSIFICATION)

d. Attitudes. *Determine the attitudes of the populace toward the existing regime or hostile power, the resistance movement, and the United States and its allies.*

e. Division Between Urban, Rural, or Nomadic Groups.

(1) Large cities and population centers.

(2) Rural settlement patterns.

(3) Areas and movement patterns of nomads.

f. Standard of Living and Cultural (Educational) Levels.

(1) Extremes away from the national average.

(2) Class structure. *Identify degree of established social stratification and percentage of populace in each class.*

g. Health and Medical Standards.

(1) General health and well-being.

(2) Common diseases.

(3) Standard of public health.

(4) Medical facilities and personnel.

(5) Potable water supply.

(6) Sufficiency of medical supplies and equipment.

h. Tradition and Customs (Particularly Taboos). *Note wherever traditions and customs are so strong and established that they may influence an individual's actions or attitude even during a war situation.*

6. MILITARY AND PARAMILITARY FORCES. *Identify friendly and hostile conventional military forces (army, navy, and air force) and internal security forces (including border guards) that can influence mission execution. Analyze nonnational or hostile forces as well as national (indigenous) forces using the subdivisions shown below.*

a. Morale, Discipline, and Political Reliability.

b. Personnel Strength.

(CLASSIFICATION)

Figure I-1. Outline for a General Area Study (Continued).

(CLASSIFICATION)

- c. Organization and Basic Deployment.
- d. Uniforms and Unit Designations.
- e. Ordinary and Special Insignia.
- f. Overall Control Mechanism.
- g. Chain of Command and Communication.
- h. Leadership. *Note officer and noncommissioned officer corps.*
- i. Nonnational Surveillance and Control Over Indigenous Security Forces.
- j. Training and Doctrine.
- k. Tactics. *Note seasonal and terrain variations.*
- l. Equipment, Transportation, and Degree of Mobility.
- m. Logistics.
- n. Effectiveness. *Note any unusual capabilities or weaknesses.*
- o. Vulnerabilities in the Internal Security System.
- p. Past and Current Reprisal Actions.
- q. Use and Effectiveness of Informers.
- r. Influence on and Relations with the Local Populace.
- s. Psychological Vulnerabilities.
- t. Recent and Current Unit Activities.
- u. Counterinsurgency Activities and Capabilities. *Pay particular attention to reconnaissance units, special troops (airborne, mountain, ranger), rotary-wing or vertical-lift aviation units, counterintelligence units, and units having a mass NBC delivery capability.*
- v. Guard Posts and Wartime Security Coverage. *Note the location of all known guard posts or expected wartime security coverage for all types of installations. Pay*

(CLASSIFICATION)

Figure I-1. Outline for a General Area Study (Continued).

(CLASSIFICATION)

particular attention to security coverage along the main LOC (railroads, highways, and telecommunications lines) and along electrical power and POL lines.

w. **Forced Labor and/or Detention Camps.** *Note exact location and description of the physical arrangement (particularly the security arrangements).*

x. **Populace and Resources Control Measures.** *Note locations, types, and effectiveness of internal security controls. Include checkpoints, identification cards, passports, and travel permits.*

7. RESISTANCE ORGANIZATION. *Identify the organizational elements and key personalities of the resistance organization. Note each group's attitude toward the United States, the hostile power, various elements of the civilian populace, and friendly political groups.*

a. **Guerrillas.**

- (1) Disposition, strength, and composition.
- (2) Organization, armament, and equipment.
- (3) Status of training, morale, and combat effectiveness.
- (4) Operations to date.
- (5) Cooperation and coordination between various existing groups.
- (6) Motivation of the various groups and their receptivity.
- (7) Quality of senior and subordinate leadership.
- (8) General health.

b. **Auxiliaries and the Underground.**

- (1) Disposition, strength, and degree of organization.
- (2) General effectiveness and type of support.

(CLASSIFICATION)

Figure I-1. Outline for a General Area Study (Continued).

(CLASSIFICATION)

(3) Responsiveness to guerrilla or resistance leaders.

c. Logistics Capability.

(1) Availability of food stocks and water. *Include any restrictions for reasons of health.*

(2) Agricultural capability.

(3) Type and availability of transportation of all categories.

(4) Types and location of civilian services available for manufacture and repair of equipment and clothing.

(5) Medical facilities to include personnel, medical supplies, and equipment.

(6) Enemy supply sources accessible to the resistance.

8. TARGETS. *(The objective in target selection is to inflict maximum damage on the hostile power with minimum expenditures of men and material. Initially, a guerrilla force may have limited operational capabilities to interdict or destroy hostile targets.) Study the target area. Identify and analyze points of attack. List targets in order of priority by system and IAW mission requirements. As appropriate, address both fixed and mobile (generic) targets.*

9. EFFECTS OF CHARACTERISTICS. *State conclusions reached through analysis of the facts developed in the previous paragraphs.*

a. Effects on Hostile Courses of Action.

b. Effects on Friendly Courses of Action.

(CLASSIFICATION)

Figure I-1. Outline for a General Area Study (Continued).

APPENDIX J

PSYOP Support of a US-Sponsored Resistance Force

PHASES	CHARACTERISTICS	PSYOP ACTIVITIES
<p>I</p> <p>Psychological Preparation</p>	<p>Inhabitants of the area are prepared psychologically to receive US forces.</p>	<p>PSYOP are planned and executed to prepare the inhabitants of the proposed operational area(s) for the presence of US forces.</p> <p>PSYOP are planned at the highest levels of a government preparing to support a resistance movement. Citizens-in-exile; other popular, respected, and influential people; and key in-country sympathizers are used.</p>
<p>II</p> <p>Initial Contact</p>	<p>US nonmilitary agencies (in coordination with the allied government-in-exile) have verified that the populace is willing to accept sponsorship for their resistance efforts. SF teams make initial contact with the resistance force whose leader requested assistance and sponsorship. The SFOB has been established and is fully operational. SF teams are in isolation receiving extensive briefings and conducting studies.</p>	<p>The emphasis of PSYOP is changed to support planned resistance force operations. With the assistance of indigenous assets, PSYOP elements develop PSYOP plans for the JSOA. PSYOP elements must develop themes, symbols, and PSYOP actions to support each phase of resistance force operations, from infiltration to demobilization.</p> <p>PSYOP elements must provide SF teams and area specialist teams with an understanding and appreciation of the PSYOP plans for each operational area.</p> <p>They must also provide PSYOP training to SF teams and indigenous assets.</p>

Figure J-1. PSYOP in the Seven Phases of Development of a US-Sponsored Resistance Force.

PHASES	CHARACTERISTICS	PSYOP ACTIVITIES
<p>III</p> <p>Infiltration</p>	<p>SF teams have been briefed on PSYOP. Infiltration is complete and contact has been made with resistance leaders.</p> <p>Operational elements establish rapport with resistance leaders.</p>	<p>PSYOP elements brief SF teams before infiltration.</p> <p>The SF team begins the area assessment and a PSYOP program through face-to-face communication.</p> <p>PSYOP elements support US and resistance force contact by publicizing tangible evidence of sponsor support in the form of weapons, ammunition, medical supplies, and money.</p>
<p>IV</p> <p>Organization</p>	<p>The SF team has succeeded in establishing rapport with resistance leaders. The resistance organization is developed and training begins. Small-scale combat operations may be conducted.</p>	<p>The PSYOP effort is expanded to assist in increasing and developing the resistance force.</p> <p>Resistance leaders help formulate PSYOP objectives and are persuaded <i>NOT</i> to take any action that contradicts or interferes with the accomplishment of these objectives.</p> <p>PSYOP elements begin motivational campaigns targeting the resistance force. They cover –</p> <ul style="list-style-type: none"> ● History of the country. ● History of the hostile power and its objectives. <p>PSYOP indoctrination programs cover –</p> <ul style="list-style-type: none"> ● Political, economic, and social objectives of the resistance movement. ● Ideological indoctrination of the resistance cadre. ● The practical impact of tactical operations on the population. ● The significance of and need for proper personal conduct of the resistance force toward the civilian population.

Figure J-1. PSYOP in the Seven Phases of Development of a US-Sponsored Resistance Force (Continued).

PHASES	CHARACTERISTICS	PSYOP ACTIVITIES
<p>V</p> <p>Buildup</p>	<p>Small-scale combat operations increase local support and attract recruits for the resistance force.</p> <p>SF teams increase their activities to establish rapport, to promote cooperation and unified action, to provide tangible proof of support, and to motivate the resistance force.</p>	<p>PSYOP (propaganda and actions) are conducted to support the expansion and full development of the resistance force.</p> <p>PSYOP programs must—</p> <ul style="list-style-type: none"> ● Encourage and win general civilian support for the resistance movement. ● Encourage and win general civilian support for the resistance movement. ● Emphasize the rules of engagement. ● Identify targets whose destruction would impact adversely on the civilian population. ● Continue to stress and assure the success of the resistance force and allied operations. ● Impress on resistance leaders that producing favorable reactions among the populace is vital. Such programs must stress proper individual and official conduct toward the population. They must also point out the need for stringent disciplinary action against offenders.
<p>VI</p> <p>Combat Employment</p>	<p>Successful small-scale combat operations have attracted many recruits. The resistance force is now fully developed and full combat operations are planned. Due to hostile power propaganda, disruption of daily life, and destruction of property, the populace does not understand the reason for the resistance force's operations. The hostile power is actively engaged in reprisals and counter guerrilla operations.</p> <hr/> <p>NOTE: PSYOP are offensive; they are not defensively reactive to the hostile power's reprisals or actions designed to discredit the resistance force.</p> <hr/> <p>This phase continues until linkup with conventional forces or until cessation of hostilities.</p>	<p>PSYOP must support and exploit the combat capability of the resistance force.</p> <p>PSYOP elements continue current propaganda efforts. Themes and symbols are directed at specific target audiences as follows:</p> <ul style="list-style-type: none"> ● <i>Populace.</i> The major themes are nationalism and the support of the resistance movement. ● <i>Resistance force.</i> Propaganda stresses assurance of success over the hostile power and the inevitability of complete victory. PSYOP elements increase motivational and indoctrination campaigns. Propaganda stresses the ability of the resistance force to defeat the hostile power and exploits the frustration in resistance force operations. ● <i>Hostile force.</i> Propaganda emphasizes the inevitability of the hostile force's defeat by the resistance force. The fact that the hostile force is not safe in any area is stressed.

Figure J-1. PSYOP in the Seven Phases of Development of a US-Sponsored Resistance Force (Continued).

PHASES CHARACTERISTICS PSYOP ACTIVITIES

PHASES	CHARACTERISTICS	PSYOP ACTIVITIES
<p>VII</p> <p>Linkup and Demobilization</p>	<p>Conventional forces have moved into range of designated JSOAs and linkup operations are imminent. A SOCCE has been attached to the conventional force headquarters with plans for PSYOP to support the linkup and demobilization of the resistance force. The SOCCE prepares and coordinates linkup plans with the conventional tactical ground commander. Because of their extreme sensitivity and importance, plans for demobilization must begin in the early phases of operations and must be continuous.</p> <p>When the resistance force is no longer needed, higher headquarters will order its disposition, to include demobilization. The practical problems of nationalization (for example, political, economic, social, ethnic, racial, religious, and military) are surfaced.</p>	<p>PSYOP propaganda and actions support the linkup and the subsequent demobilization.</p> <p>Linkup: PSYOP in the JSOA prepare the populace to cooperate fully with the conventional tactical forces. The populace is urged to remain in place and not to hinder operations that will bring hostilities to a successful end.</p> <p>PSYOP elements brief resistance leaders on the importance of close cooperation with tactical force commanders.</p> <p>PSYOP elements psychologically prepare the resistance force to be incorporated into the national army or to be demobilized.</p> <p>PSYOP elements psychologically prepare resistance leaders to accept leadership from the conventional force on linkup.</p> <p>The troop commander and staff officer inform the troops of the importance of proper individual and unit conduct.</p> <p>Demobilization: PSYOP are implemented to explain the demobilization process. These operations provide for the orderly transition of the resistance force to peaceful civilian life, preventing the formation of quasi-military or political groups in conflict with the objectives and policies of the recognized government. Loyalty to the post hostilities government is stressed.</p>

Figure J-1. PSYOP in the Seven Phases of Development of a US-Sponsored Resistance Force (Continued).

Glossary

Part I. Acronyms

ACC	area coordination center	BDE	brigade
ADCON	administrative control	BDOC	base defense operations center
ADMIN	administrative	BMNT	beginning morning nautical twilight
AFFOR	Air Force forces	BN	battalion
AFNORTH	Allied Forces, Northern Europe	BOS	battlefield operating systems
AFSOC	Air Force Special Operations Command		
ALB	AirLand battle	C2	command and control
ALOC	air lines of communication	C3	command, control, and communication
AM	amplitude modulated	C3I	command, control, communications, and intelligence
AOB	advanced operational base	CA	civil affairs
AOR	area of responsibility	CARVER	criticality, accessibility, recuperability, vulnerability, effect, recognizability
AR	Army Regulation	CDA	close defense area
ARFOR	Army forces	CDR	commander
ARSOF	Army special operations forces	CEP	controlled entry point
ARSOTF	Army special operations task force	CHEM	chemical
ARTEP	Army Training and Evaluation Program	CI	counterintelligence
ASG	area support group	CIA	Central Intelligence Agency
ASIC	all-source intelligence center	CIAE	counterintelligence analysis element
ASO	area specialist officer	CINC	commander in chief
ASP	ammunition supply point	CJCS	Chairman, Joint Chiefs of Staff
ASPS	all-source production section	CM&D	collection management and dissemination
ASST	assistant	CMD	command
AST	area specialist team	CMO	civil-military operations
AVIM	aviation intermediate maintenance		
AVN	aviation		
AVUM	aviation unit maintenance		

CN	counternarcotics	EAC	echelons above corps
CO	company	EACIC	echelons above corps intelligence center
COA	course of action	EAF	emergency action facility
COCOM	combatant command	EAP	emergency action program
COM	chief of the US diplomatic mission	ECCM	electronic counter-countermeasures
COMDT	commandant	ECM	electronic countermeasures
COMM	communication	EEFI	essential elements of friendly information
COMMCEN	communications center	EENT	ending evening nautical twilight
COMMZ	communications zone	ELECT	electronic
COMSEC	communications security	ENGR	engineer
CONUS	continental United States	EOB	electronic order of battle
CS	combat support	ESM	electronic warfare support measures
CSAR	combat search and rescue	EW	electronic warfare
CSM	command sergeant major		
CSR	controlled supply rate		
CSS	combat service support		
CT	counterterrorism		
CTEP	counterterrorism enhancement program		
CW	continuous wave		
DA	direct action	FC	field circular
DCS	defense communications system	FID	foreign internal defense
DCSLOG	Deputy Chief of Staff for Logistics	FLOT	forward line of own troops
DCSOPS	Deputy Chief of Staff for Operations and Plans	FM	frequency modulated
DEA	Drug Enforcement Administration	FNS	foreign nation support
DET	detachment	FOB	forward operational base
DIA	Defense Intelligence Agency	FORSCOM	United States Army Forces Command
DIAM	Defense Intelligence Agency Manual	FSU	finance support unit
DOD	Department of Defense		
DOI	Director of Intelligence	GOS	global operating systems
DOJ	Department of Justice	GP	group
DOL	Director of Logistics	GRREG	graves registration
DOS	Department of State	GS	general support
DPA	Director of Personnel and Administration	GSU	general support unit
DPO	Director of Plans and Operations	GW	guerrilla warfare
DS	direct support		
DSA	division support area	HA	humanitarian assistance
DSAA	Defense Security Assistance Agency	HF	high frequency
DSU	direct support unit	HHC	headquarters and headquarters company
DZ	drop zone	HN	host nation
		HQ	headquarters
		HQDA	Headquarters, Department of the Army
E&E	evasion and escape	HSS	health service support
EA	emergency action	HUMINT	human intelligence

IDAD——internal defense and development
 IEW——intelligence and electronic warfare
 INTEL——intelligence
 INTG——interrogation
 IPA——intelligence production agencies
 IPB——intelligence preparation of the
 battlefield
 IR——intelligence requirements
 ISB——intermediate staging base
 ISE——intelligence support element
 ISOFAC——isolation facility

J1——Personnel Directorate
 J4——Logistics Directorate
 J6——Communications-Electronics
 Directorate
 JCS——Joint Chiefs of Staff
 JCSE——joint communications support
 element
 JIC——joint intelligence center
 JOC——joint operations center
 JOPS——Joint Operations Planning System
 JSCP——Joint Strategic Capabilities Plan
 JSOA——joint special operations area
 JSOTF——joint special operations task force
 JTB——joint target board

LIC——low-intensity conflict
 LOC——lines of communication
 LRSU——long-range surveillance unit
 LZ——landing zone

MAINT——maintenance
 MANPAD——man-portable air defense
 MDA——main defense area
 MECH——mechanical
 MED——medical
 MEDCOM——medical command
 MEDLOG——medical logistics
 METL——mission-essential task list
 METT-T——mission, enemy, terrain, troops
 and time available
 MFF——military free-fall
 MI——military intelligence
 MICON——mission concept
 MIJI——meaconing, intrusion, jamming,
 and interference

MILPO——military personnel office
 MOS——military occupational specialty
 MP——military police
 MPA——mission planning agent
 MSS——mission support site
 MTF——medical treatment facility
 MTOE——modification table of organization
 and equipment
 MTP——mission tasking package
 MTT——mobile training team

NAI——named areas of interest
 NATO——North Atlantic Treaty
 Organization
 NAVFOR——Navy forces
 NBC——nuclear, biological, and chemical
 NCA——National Command Authorities
 NCO——noncommissioned officer
 NSC——National Security Council
 NSD——national security directive
 NSWTG——Naval Special Warfare Task Group

OB——order of battle
 OCONUS——outside continental United States
 OP——operation
 OPCEN——operations center
 OPCON——operational control
 OPLAN——operation plan
 OPORD——operation order
 OPSEC——operations security
 ORF——operational readiness float

PA——preliminary assessment
 PAC——personnel administration center
 PERS——personnel
 PERSCOM——personnel command
 PIR——priority intelligence requirements
 PLL——prescribed load list
 POC——point of contact
 POD——port of debarkation
 POE——plan of execution
 POL——petroleum, oils, and lubricants
 POMCUS——pre-positioning of materiel con-
 figured in unit sets
 PONR——point of no return
 PRC——populace and resources control
 PSC——personnel service company

PSS _____ personnel service support
 PSYOP _____ psychological operations
 PW _____ prisoner of war
 PWRMS _____ pre-positioned war reserve
 materiel stocks

RATT _____ radio teletypewriter
 REGT _____ regiment
 REMAB _____ remote marshaling base
 RFI _____ request for information
 RMCT _____ regional movement control
 team
 ROE _____ rules of engagement
 RQMT _____ requirement
 RSR _____ required supply rate

S1 _____ adjutant
 S2 _____ intelligence officer
 S3 _____ operations and training officer
 S4 _____ supply officer
 S5 _____ civil affairs officer
 SA _____ security assistance
 SAF _____ security assistance force
 SAO _____ security assistance organization
 SAR _____ search and rescue
 SAT _____ security assistance team
 SATCOM _____ satellite communications
 SCI _____ sensitive compartmented
 information
 SCIF _____ sensitive compartmented
 information facility
 scuba _____ self-contained underwater
 breathing apparatus
 SEC _____ section
 SF _____ Special Forces
 SFG(A) _____ Special Forces group (airborne)
 SFOB _____ Special Forces operational base
 SFOD _____ Special Forces operational
 detachment or A detachment
 SHF _____ super high frequency
 SIG _____ signal
 SIGCEN _____ signal center
 SIGINT _____ signal intelligence
 SJA _____ staff judge advocate
 SO _____ special operations
 SOAVNTF _____ special operations aviation
 task force
 SOC _____ special operations command

SOCCE _____ special operations command and
 control element
 SOF _____ special operations forces
 SOI _____ signal operation instructions
 SOMPF _____ special operations mission
 planning folder
 SOP _____ standing operating procedure
 SOR _____ statement of requirements
 SOSE _____ special operations staff element
 SOT _____ special operations team
 SOTF _____ special operations task force
 SPECAT _____ special category
 SPT _____ support
 SPTCEN _____ support center
 SPT CO _____ support company
 SR _____ special reconnaissance
 SSCE _____ signal support coordination
 element
 SSO _____ special security office
 SSR _____ special security representative
 STANAG _____ Standardization Agreement
 SUP _____ supply
 SVC _____ service

TA _____ theater army
 TAACOM _____ theater army area command
 TACON _____ tactical control
 TACSAT _____ tactical satellite
 TACSATCOM _____ tactical satellite communications
 TAFT _____ training assistance field team
 TAG _____ target assessment group
 TAMCA _____ theater army movement
 control agency
 TAMMC _____ theater army materiel
 management center
 TASOSC _____ theater army special operations
 support command
 TC _____ training circular
 TCAE _____ technical control analysis element
 TCIS _____ tactical command information
 systems
 TCS _____ theater communications system
 TCSB _____ third country support base
 TDA _____ tables of distribution and
 allowances
 TDI _____ target data inventory
 TECH _____ technician
 TF _____ task force
 TIP _____ target intelligence package

TM———team
 TMO———transportation movement office
 TOC———tactical operations center
 TOE———table of organization and equipment
 TOS———theater operating systems
 TRADOC——United States Army Training and Doctrine Command
 TRANS———transport
 TRANSCOM——transportation command
 TTP———tactics, techniques, and procedures

UBL———unit basic load
 UHF———ultra high frequency
 UMT———unit ministry team
 US———United States
 USAF———United States Air Force
 USAJFKSWCS—US Army John F. Kennedy Special Warfare Center and School
 USASOC——United States Army Special Operations Command

USCINCSOC—United States Commander in Chief, Special Operations Command
 USDR———United States defense representative
 USSOCOM——US Special Operations Command
 UTM———universal transverse mercator (grid)
 UW———unconventional warfare

VHF———very high frequency

WPNS———weapons
 WRMS———war reserve materiel stocks
 WRSL———war reserve stockage list

XO———executive officer

Part II. Definitions

antiterrorism - Defensive measures used to reduce the vulnerability of individuals and property to terrorism. Also called AT. (JCS Pub 1-02) (See also combatting counterterrorism and terrorism.)

area assessment - In unconventional warfare, the collection of specific information prescribed by the commander to commence immediately after infiltration. It is a continuous operation, and it confirms, corrects, refutes, or adds to intelligence acquired from area studies and other sources prior to infiltration.

area command - In unconventional warfare, the organizational structure established within a joint special operations area to command and control resistance forces. It consists of the area commander, his staff, and representatives of the resistance element, to include Special Forces after infiltration.

asset (intelligence) - (DOD, IADB) Any resource—person, group, relationship, instrument, installation, or supply—at the disposition of an intelligence organization for use in an operational or support role. Often used with a qualifying term such as agent asset or propaganda asset. (JCS Pub 1-02)

auxiliary -In unconventional warfare, that element of the resistance force established to provide the organized civilian support of the resistance movement. (AR 310-25)

chemical warfare - (DOD) All aspects of military operations involving the employment of lethal and incapacitating munitions/agents and the warning and protective measures associated with such offensive operations. Since riot control agents and herbicides are not considered to be chemical warfare agents, those two items will be referred to separately or under the broader term *chemical*, which will be used to include all types of chemical munitions/agents collectively. The term *chemical warfare weapons* may be used when it is desired to reflect both lethal

and incapacitating munitions/agents of either chemical or biological origin. (JCS Pub 1-02)

civil affairs - (DOD, IADB) Those phases of the activities of a commander which embrace the relationship between the military forces and civil authorities and people in a friendly country or area or occupied country or area when military forces are present. Civil affairs include, inter alia: a. matters concerning the relationship between military forces located in a country or area and the civil authorities and people of that country or area usually involving performance by the military forces of certain functions or the exercise of certain authority normally the responsibility of the local government. This relationship may occur prior to, during, or subsequent to military action in time of hostilities or other emergency and is normally covered by a treaty or other agreement, expressed or implied; and b. military government: the form of administration by which an occupying power exercises executive, legislative, and judicial authority over occupied territory. (JCS Pub 1-02)

civil-military operations - The complex of activities in support of military operations embracing the interaction between the military force and civilian authorities fostering the development of favorable emotions, attitudes, and behavior in neutral, friendly, or hostile groups. (FM 41-10)

clandestine operation - (DOD, I, IADB) An activity to accomplish intelligence, counterintelligence, and other similar activities sponsored or conducted by governmental departments or agencies, in such way as to assure secrecy or concealment. (JCS Pub 1-02)

collateral mission activities - The inherent capabilities of all military forces may periodically be applied to accomplish missions other than those for which the forces are principally organized, trained, and equipped. Collateral activities in which special operations forces, by virtue of inherent capabilities, may be tasked to participate include humanitarian assistance, security assistance, search and rescue, counternarcotics, antiterrorism and other security activities, and special activities. (USCINCSOC)

combatant command - The authority to perform those functions of command involving organizing and

employing commands and forces, assigning tasks, designating objectives and giving authoritative direction necessary to accomplish the mission. COCOM includes directive authority over all aspects of military operations joint training, and logistics. COCOM should be exercised through the commanders of assigned normal organizational units or through the commanders of subordinate commands and forces. COCOM provides full authority to organize and employ forces as the CINC deems necessary to accomplish assigned missions and to retain or delegate operational control or tactical control as necessary. COCOM does not, of itself, include such matters as administration, discipline, internal organization, and unit training. COCOM is exercised solely by the commanders of unified and specified commands. (JCS Pub O-2)

combatting terrorism - Actions, including antiterrorism (defensive measures taken to reduce vulnerability to terrorist acts) and counterterrorism (offensive measures taken to prevent, deter, and respond to terrorism), taken to oppose terrorism throughout the entire threat spectrum. (JCS Pub 1-02)

compartmentation - (DOD) Establishment and management of an intelligence organization so that information about the personnel, organization, or activities of one component is made available to any other component only to the extent required for the performance of assigned duties. (JCS Pub 1-02)

1. In unconventional warfare, the division of an organization or activity into functional segments or cells to restrict communication between them and prevent knowledge of the identity or activities of other segments except on a need-to-know basis.
2. Restricting the use of specific cryptovariables to specific users for the purpose of limiting access to the information protected by these cryptovariables and limiting the adverse impact of a compromise of these variables. (AR 310-25)

consolidation - The combining or merging of elements to perform a common or related function. (JCS Pub 1-02)

counterinsurgency - (DOD) Those military, paramilitary, political, economic, psychological, and civic actions taken by a government to defeat insurgency. (JCS Pub 1-02)

counterintelligence - Information gathered and activities conducted to protect against espionage, other intelligence activities, sabotage, or assassinations conducted for or on behalf of foreign powers, organizations, or persons or international terrorist activities, but not including personnel, physical, document, or communications security programs. (DOD Directive 5240.1)

counterterrorism - Offensive measures taken by civilian and military agencies of the government to prevent, deter, and respond to terrorism. The primary mission of special operations forces in this interagency activity is to apply specialized capabilities to preclude, preempt, and resolve terrorist incidents abroad. Also called CT. See also antiterrorism, terrorism, terrorism counteraction. (USCINCSOC)

Country Team - Senior members of US government agencies assigned to a US diplomatic mission overseas and subject to the direction and supervision of the Chief, US Mission (ambassador). Normally, such members meet regularly (weekly) to coordinate US government political, economic, and military activities and policies in the host country.

deconflict - To reconcile or resolve a conflict in interests as in targeting.

direct action - In special operations, a specified act involving operations of an overt, clandestine, or low visibility nature conducted primarily by special operations forces in hostile or denied areas. (JCS Pub 1-02)

direct action operations - Short-duration strikes and other small-scale offensive actions by special operations forces to seize, destroy, or inflict damage on a specified target; or to destroy, capture, or recover designated personnel or material. In the conduct of these operations, special operations forces may employ raid, ambush, or direct assault tactics; emplace mines and other munitions; conduct standoff attacks by fire from air, ground, or maritime platforms; provide terminal guidance for precision guided munitions; and conduct independent sabotage. (USCINCSOC)

diversion - (DOD, NATO) The act of drawing the attention and forces of an enemy from the point of

the principal operation; an attack, alarm, or feint that diverts attention. (JCS Pub 1-02)

electronic counter—countermeasures - That division of electronic warfare involving actions taken to ensure friendly effective use of the electromagnetic spectrum despite the enemy's use of electronic warfare. (JCS Pub 1-02)

electronic countermeasures - That division of electronic warfare involving actions taken to prevent or reduce an enemy's effective use of the electromagnetic spectrum. Also called ECM. (JCS Pub 1-02)

electronic warfare - (IADB) Military action involving the use of electromagnetic energy to determine, exploit, reduce, or prevent hostile use of the electromagnetic spectrum and action which retains friendly use of the electromagnetic spectrum. (JCS Pub 1-02)

evasion and escape - (DOD, I, NATO, IADB) The procedures and operations whereby military personnel and other selected individuals are enabled to emerge from an enemy-held or hostile area to areas under friendly control. (JCS Pub 1-02)

evasion and escape net - (DOD, IADB) The organization within enemy-held or hostile areas that operates to receive, move, and exfiltrate military personnel or selected individuals to friendly control. (JCS Pub 1-02)

executive order - Order issued by the President by virtue of the authority vested in him by the Constitution or by an act of Congress. It has the force of law. (AR 310-25)

exfiltration - (DOD) The removal of personnel or units from areas under enemy control. (JCS Pub 1-02)

foreign intelligence - Information relating to the capabilities, intentions, and activities of foreign powers, organizations, or persons, but not including counterintelligence, except for information on international terrorist activities. (DOD Directive 5240.1)

foreign internal defense - (DOD) Participation by civilian and military agencies of a government in any of the action programs taken by another

government to free and protect its society from subversion, lawlessness, and insurgency. (JCS Pub 1-02)

foreign nation support - Civil resources identification, negotiation, and procurement from available resources within a foreign nation in support of the US military mission during wartime, preparation for war, or peacetime.

foreign power - Any foreign government (regardless of whether recognized by the United States), foreign-based political party (or faction thereof), foreign military force, foreign-based terrorist group, or any organization composed, in major part, of any such entity or entities. (AR 381-10) Foreign powers may be classified as friendly, neutral, or hostile.

guerrilla warfare - (DOD, I, NATO, IADB) Military and paramilitary operations conducted in enemy-held or hostile territory by irregular, predominantly indigenous forces. (JCS Pub 1-02)

host nation - A nation in which representatives or organizations of another state are present because of government invitation or international agreement. The term particularly refers to a nation receiving assistance relevant to its national security.

hostile power - See foreign power.

human intelligence - (DOD, NATO) A category of intelligence derived from information collected and provided by human sources. (JCS Pub 1-02)

infiltration - (DOD, NATO, IADB) **1.** The movement through or into an area or territory occupied by either friendly or enemy troops or organizations. The movement is made either by small groups or by individuals at extended or irregular intervals. When used in connection with the enemy, it infers that contact is avoided. **2.** In intelligence usage, placing an agent or other person in a target area in hostile territory. Usually involves crossing a frontier or other guarded line. Methods of infiltration are black (clandestine), grey (through legal crossing point but under false documentation), white (legal). **3.** A technique and process in which a force moves as individuals or small groups over, through, or around enemy positions without detection. (JCS Pub 1-02)

information - (DOD) In intelligence usage, un-evaluated material of every description that may be used in the production of intelligence. (NATO) In intelligence usage, unprocessed data of every description which may be used in the production of intelligence. (JCS Pub 1-02)

insurgency - (DOD, I, NATO, IADB) An organized movement aimed at the overthrow of a constituted government through use of subversion and armed conflict. (JCS Pub 1-02)

insurgent war - A struggle between a constituted government and organized insurgents frequently supported from without, but acting violently from within, against the political, social, economic military, and civil vulnerabilities of the regime to bring about its internal destruction or overthrow. Such wars are distinguished from lesser insurgencies by the gravity of the threat to government and the insurgent object or eventual regional or national control. (AR 310-25)

intelligence reporting - (DOD, IADB) The preparation and conveyance of information by any means. More commonly, the term is restricted to reports as they are prepared by the collector and as they are transmitted by him to his headquarters and by this component of the intelligence structure to one or more intelligence-producing components. Thus, even in this limited sense, reporting embraces both collection and dissemination. The term is applied to normal and specialist intelligence reports. (JCS Pub 1-02)

internal security - (DOD, I, IADB) **1.** The state of law and order prevailing within a nation. (JCS Pub 1-02) **2.** The prevention of action against United States resources, industries, and institution and the protection of life and property in the event of a domestic emergency by the employment of all measures, in peace or war, other than military defense. **3.** Condition resulting from the measures taken within a command to safeguard defense information coming under its cognizance, including physical security of documents and materials. (AR 310-25)

international narcotics activities - Refers to activities outside the United States to produce, transfer, or sell narcotics or other substances controlled in

accordance with Title 21, United States Code, Sections 811 and 812. (AR 381-10)

international terrorist activities - Activities undertaken by or in support of terrorists or terrorist organizations that occur totally outside the United States, or that transcend national boundaries in terms of the means by which they are accomplished, the persons they appear intended to coerce or intimidate, or the locale in which the perpetrators operate or seek asylum. (AR 381-10)

joint doctrine - (DOD) Fundamental principles that guide the employment of forces of two or more Services of the same nation in coordinated action toward a common objective. It is ratified by all four Services and may be promulgated by the Joint Chiefs of Staff. (JCS Pub 1-02)

joint operations - Operations carried on by two or more of the Armed Forces of the United States (Army, Navy, Air Force). (AR 310-25)

joint special operations area - That area of land, sea, and airspace assigned to a joint special operations command to conduct SO.

limited war - (DOD, IADB) Armed conflict short of general war, exclusive of incidents, involving the overt engagement of military forces of two or more nations. (JCS Pub 1-02)

low intensity conflict - (DOD) A limited politico-military struggle to achieve political, social, economic, or psychological objectives. It is often protracted and ranges from diplomatic, economic, and psychosocial pressures through terrorism and insurgency. Low-intensity conflict is generally confined to a geographic area and is often characterized by constraints on the weaponry, tactics, and the level of violence. Also called LIC. (JCS Pub 1-02)

low visibility operations - (DOD) Sensitive operations wherein the political/military restrictions inherent in covert and clandestine operations are either not necessary or not feasible; actions are taken as required to limit exposure of those involved and/or their activities. (JCS Pub 1-02)

military civic action - (DOD, I, IADB) The use of preponderantly indigenous military forces on projects

useful to the local population at all levels in such fields as education, training, public works, agriculture, transportation, communications health, sanitation, and others contributing to economic and social development which would also serve to improve the standing of the military forces with the population. (DOD, I) (US forces may at times advise or engage in military civic action in overseas areas.) (JCS Pub 1-02)

mobile training team - (DOD, IADB) A mobile training team consists of one or more US personnel drawn from Service resources and sent on temporary duty to a foreign nation to give instruction. The mission of the team is to provide, by training-instructor personnel, a military service of the foreign nation with a self-training capability in a particular skill. (JCS Pub 1-02) Trains foreign personnel to operate, maintain, and employ weapons systems and support equipment or teach other special skills and/or procedures related to military training procedures.

National Command Authorities - (DOD) The President and the Secretary of Defense or their duly deputized alternates or successors. (JCS Pub 1-02)

national intelligence - (DOD, IADB) Integrated departmental intelligence that covers the broad aspects of national policy and national security, is of concern to more than one department or agency, and transcends the exclusive competence of a single department or agency. (JCS Pub 1-02)

national objectives - (DOD, IADB) Those fundamental aims, goals, or purposes of a nation—as opposed to the means for seeking these ends—toward which a policy is directed and efforts and resources of the nation are applied. (JCS Pub 1-02)

national policy - (DOD, IADB) A broad course of action or statements of guidance adopted by the government at the national level in pursuit of national objectives. (JCS Pub 1-02)

national security - (DOD) A collective term encompassing both national defense and foreign relations of the United States. Specifically, the condition provided by: **a.** a military or defense advantage over any foreign nation or group of nations, or **b.** a favorable

foreign relations position, or c. a defense posture capable of successfully resisting hostile or destructive action from within or without, overt or covert. (JCS Pub 1-02)

national strategy - (DOD, IADB) The art and science of developing and using the political, economic, and psychological powers of a nation, together with its armed forces, during peace and war, to secure national objectives. (JCS Pub 1-02)

overt operation - (DOD, IADB) The collection of intelligence openly, without concealment. (JCS Pub 1-02)

paramilitary forces - (DOD, I, IADB) Forces or groups which are distinct from the regular armed forces of any country, but resembling them in organization, equipment, training, or mission. (JCS Pub 1-02)

psychological operations - (DOD) Planned operations to convey selected information and indicators to foreign audiences to influence their emotions, motives, objective reasoning, and ultimately the behavior of foreign governments, organizations, groups, and individuals. The purpose of psychological operations is to induce or reinforce foreign attitudes and behavior favorable to the originator's objectives. (JCS Pub 1-02)

psychological warfare - (DOD, IADB) The planned use of propaganda and other psychological actions having the primary purpose of influencing the opinions, emotions, attitudes, and behavior of hostile foreign groups in such a way as to support the achievement of national objectives. (JCS Pub 1-02)

real time - (DOD) The absence of delay, except for the time required for the transmission by electromagnetic energy, between the occurrence of an event or the transmission of data and the knowledge of the event or reception of the data at some other location. (JCS Pub 1-02) The absence of delay in acquisition, transmission, and reception of data. (AR 310-25)

refugee - (DOD, IADB) A civilian who by reason of real or imagined danger has left home to seek safety elsewhere. (JCS Pub 1-02)

resistance movement - (DOD, IADB) An organized effort by some portion of the civil population of a country to resist the legally established government or an occupying power and to disrupt civil order and stability. (JCS Pub 1-02)

sabotage - (DOD, IADB) An act or acts with intent to injure, interfere with, or obstruct the national defense of a country by willfully injuring or destroying, or attempting to injure or destroy, any national defense or war material, premises, or utilities, to include human and natural resources, (JCS Pub 1-02)

safe area - (DOD, IADB) A designated area in hostile territory that offers the evader or escapee a reasonable chance of avoiding capture and of surviving until he can be evacuated. (JCS Pub 1-02)

sector - That portion of a JSOA assigned by a joint SO commander to a subordinate SO commander for the conduct of a specific SO mission.

security assistance - (DOD) Group of programs authorized by the Foreign Assistance Act of 1961, as amended, and the Arms Export Control Act of 1976, as amended, or other related statutes by which the United States provides defense articles, military training, and other defense-related services, by grant, credit, or cash sales, in furtherance of national policies and objectives. (JCS Pub 1-02)

security assistance organizations - SAOs encompass all DOD elements located in foreign countries with assigned security assistance responsibilities. They may be known as joint US military advisory groups, joint US military groups, US military missions, US military advisory groups, US military assistance advisory groups, or US military groups. Security assistance organizations also include defense liaison offices or groups, defense field offices, offices of defense cooperation, and defense attache offices with personnel designated to perform security assistance functions. The specific title of an SAO is dependent on the number of persons assigned, the functions performed, or the desires of the host nation. (See FC 100-20 and DOD 5105.38-M.)

special activities - Activities conducted in support of national foreign policy objectives abroad, which are

planned and executed so that the role of the US government is not apparent or acknowledged publicly, and functions in support of such activities, but which are not intended to influence US political processes, public opinion, policies, or media, and do not include diplomatic activities or the collection and production of intelligence or related support functions. (DOD Directive 5240.1)

special operations - (DOD) Operations conducted by specially trained, equipped, and organized DOD forces against strategic or tactical targets in pursuit of national military, political, economic, or psychological objectives. These operations may be conducted during periods of peace or hostilities. They may support conventional operations, or they may be prosecuted independently when the use of conventional forces is either inappropriate or infeasible. (JCS Pub 1-02)

special operations - Actions conducted by specially organized, trained and equipped military and paramilitary forces to achieve military, political, economic, or psychological objectives by non-conventional military means in hostile, denied, or politically sensitive areas. They are conducted in peace, conflict, and war, independently or in coordination with operations of conventional forces. Politico-military considerations frequently shape special operations, requiring clandestine, covert, or low visibility techniques, and oversight at the national level. Special operations differ from conventional operations in degree of risk, operational techniques, mode of employment, independence from friendly support, and dependence on detailed operational intelligence and indigenous assets. (USCINCSOC)

special reconnaissance - SR operations are reconnaissance and surveillance actions conducted by special operations forces to obtain or verify, by visual observation or other collection methods, information concerning the capabilities, intentions, and activities of an actual or potential enemy or to secure data concerning the meteorological, hydrographic, or geographic characteristics of a particular area. It includes target acquisition, area assessment, and post-strike reconnaissance. (USCINCSOC)

strategic intelligence - (DOD) Intelligence that is required for the formation of policy and military plans at national and international levels. Strategic

intelligence and tactical intelligence differ primarily in level of application but may also vary in terms of scope and detail. (JCS Pub 1-02)

strategic psychological activities - (DOD, NATO) Planned psychological activities in peace and war which normally pursue objectives to gain the support and cooperation of friendly and neutral countries and to reduce the will and the capacity of hostile or potentially hostile countries to wage war. (JCS Pub 1-02)

technical control - The executive authority to regulate and supervise technical activities by providing specialized or professional guidance and direction.

terrorism - (DOD) The unlawful use or threatened use of force or violence against individuals or property to coerce or intimidate governments or societies, often to achieve political, religious, or ideological objectives. (JCS Pub 1-02) The calculated use of violence or the threat of violence to attain goals, political, religious, or ideological in nature. This is done through intimidation, coercion, or instilling fear. Terrorism involves a criminal act that is often symbolic in nature and intended to influence an audience beyond the immediate victims. (AR 190-52)

terrorism counteraction - See combatting terrorism.

third world - Refers to those countries with underdeveloped but growing economies, often with colonial pasts, and low per capita incomes.

threat - The ability of an enemy to limit, neutralize, or destroy the effectiveness of a current or projected mission organization or item of equipment. (TRADOC Reg 381-1)

unconventional warfare - A broad spectrum of military and paramilitary operations conducted in enemy-held, enemy-controlled, or politically sensitive territory. Unconventional warfare includes, but is not limited to, the interrelated fields of guerrilla warfare, evasion and escape, subversion, sabotage, and other operations of a low visibility, covert or clandestine nature. These interrelated aspects of unconventional warfare may be prosecuted singly or collectively by predominantly indigenous personnel, usually supported and directed in varying degrees by (an) external sources(s) during all conditions of war or peace. (JCS Pub 1-02)

unconventional warfare - A broad spectrum of military and paramilitary operations, normally of long duration, predominantly conducted by indigenous or surrogate forces who are organized, trained, equipped, supported, and directed in varying degrees by an external source. It includes guerrilla warfare and other direct offensive, low visibility, covert or clandestine operations, as well as the indirect activities of subversion, sabotage, intelligence collection, and evasion and escape. (USCINCSOC)

underground - A covert unconventional warfare organization established to operate in areas denied to the guerrilla forces or conduct operations not suitable for guerrilla forces. (AR 310-25)

US Country Team - The senior, in-country, United States coordinating and supervising body, headed by the chief of the US diplomatic mission, usually an ambassador, and composed of the senior member of each represented United States department or agency. (See also Country Team.)

References

Required Publications

Required publications are sources that users must read to understand or to comply with this publication.

Field Manuals

- FM 21-78——(C) Resistance and
Escape (U), 15 June 89
- FM 25-100——Training the Force, 15 Nov 88
- FM 100-5——Operations, 5 May 86
- FM 100-20——Low Intensity Conflict,
16 Jan 81

- FM 101-5——Staff Organization and
Operations, 25 May 84

Joint Publications

- JCS Pub 0-2——Unified Action Armed Forces
(UNAAF), 1 Dec 86
- JCS Pub 1-02——Department of Defense Dic-
tionary of Military and
Associated Terms, 1 Jun 87
- JCS Pub 3-05——(S) Joint Special Operations
Policy, Concepts and Proce-
dures (U), 30 Jun 78
- JCS Pub 3-05.1——(S) Joint Unconventional
Warfare Operational Pro-
cedures (U), 30 May 83

Related Publications

Related publications are sources of additional information. They are not required to understand this publication.

Army Regulations

- AR 11-11——(C) War Reserves (U),
1 Jun 85
- AR 12-1——Security Assistance - Policy,
Objectives, and Responsi-
bilities, 7 Oct 88

- | | | | |
|------------|--|---------------|--|
| AR 12-15 | Joint Security Assistance Training (JSAT) Regulation, 1 Oct 85 | FM 24-33 | Communications Techniques: Electronic Counter-Countermeasures, 22 Mar 85 |
| AR 37-103 | Disbursing Operations for Finance and Accounting Offices, 4 Dec 87 | FM 25-3 | Training in Units, 12 Dec 84 |
| AR 310-25 | Dictionary of United States Army Terms, 15 Oct 83 | FM 27-10 | Law of Land Warfare, 18 Jul 56 |
| AR 310-50 | Authorized Abbreviations and Brevity Codes, 15 Nov 85 | FM 30-18 | (S) Intelligence Collection Operations (U), 30 Nov 73 |
| AR 381-10 | US Army Intelligence Activities, 1 Jul 84 | FM 33-1 | Psychological Operations, 31 Jul 87 |
| AR 381-20 | US Army Counterintelligence Activities, 26 Sep 86 | FM 34-1 | Intelligence and Electronic Warfare Operations, 2 Jul 87 |
| AR 530-1 | Operations Security (OPSEC), 15 Oct 85 | FM 34-3 | Intelligence Analysis, 13 Jan 86 |
| AR 614-200 | Selection of Enlisted Soldiers for Training and Assignment, 5 Jul 84 | FM 34-60 | Counterintelligence, 14 Aug 85 |
| AR 710-1 | Centralized Inventory Management of the Army Supply System, 1 Feb 88 | FM 34-60A | (S) Counterintelligence Operations (U), 6 Jun 89 |
| | | FM 41-10 | Civil Affairs Operations, 17 Dec 85 |
| | | FM 90-3 | Desert Operations (How to Fight), 19 Aug 77 |
| | | FM 90-4 | Air Assault Operations, 16 Mar 87 |
| | | FM 90-5 | Jungle Operations (How to Fight), 16 Aug 82 |
| | | FM 90-6 | Mountain Operations, 30 Jun 80 |
| | | FM 90-8 | Counterinsurgency Operations, 29 Aug 86 |
| | | FM 90-14 | Rear Battle, 10 Jun 85 |
| | | FM 100-10 | Combat Service Support, 18 Feb 88 |
| | | FM 100-27 | US Army/US Air Force Doctrine for Joint Airborne and Tactical Airlift Operations, 31 Jan 85 |
| | | FM 101-5-1 | Operational Terms and Symbols, 21 Oct 85 |
| | | FM 101-10-1/2 | Staff Officers' Field Manual-Organizational, Technical, and Logistical Data Planning Factors, 7 Oct 87 |

Field Manuals

- | | |
|-----------|---|
| FM 3-3 | NBC Contamination Avoidance, 30 Sep 86 |
| FM 3-4 | NBC Protection, 21 Oct 85 |
| FM 3-5 | NBC Decontamination, 24 Jun 85 |
| FM 3-100 | NBC Operations, 17 Sep 85 |
| FM 7-7 | The Mechanized Infantry Platoon and Squad (APC), 15 Mar 85 |
| FM 12-15 | Wartime Casualty Reporting, 8 Dec 83 |
| FM 21-76 | Survival, 26 Mar 86 |
| FM 21-77A | (S) Joint Worldwide Evasion and Escape Manual (U), 1 Aug 67 |

Training Circulars

- TC 31-19——Special Forces Military Free-Fall Parachuting, 9 Sep 88
- TC 31-24——Special Forces Air Operations, 9 Sep 88
- TC 31-25——Special Forces Waterborne Operations, 3 Oct 88
- TC 31-29——Special Forces Operational Techniques, 9 Sep 88
- TC 31-29A——(C) Special Forces Operational Techniques (U), 9 Sep 88
- TC 57-1——The Jumpmaster, 28 Sep 79

Army Training and Evaluation Program

- ARTEP 31-807-30-MTP——Mission Training Plan for the Special Forces Company: Unconventional Warfare, 28 Sep 88
- ARTEP 31-807-31-MTP——Mission Training Plan for the Special Forces Company: Special Reconnaissance, 1 Feb 89
- ARTEP 31-807-32-MTP——Mission Training Plan for the Special Forces Company: Direct Action, 23 Oct 89

Army Publications

US Army Communications Command-Intermediate Distance Skywave Propagation Charts

NATO Standardization Agreements

STANAGs are available, upon request, from Naval Publications and Forms Center, 5801 Tabor Avenue, Philadelphia, PA 19120

- STANAG 1034——Allied Spotting Procedures for Naval Gunfire Support, ATP-4
- STANAG 1075——Allied Manual of Submarine Operations, ATP-18(A)
- STANAG 1149——Doctrine for Amphibious Operations, ATP-8
- STANAG 1180——Amphibious Operations – Ship to Shore Movement, ATP-36
- STANAG 2022——Intelligence Reports
- STANAG 2029——Methods of Describing Ground Locations, Areas, and Boundaries
- STANAG 2044——Procedures for Dealing with Prisoners of War (PW)
- STANAG 2068——Emergency War Surgery
- STANAG 2070——Emergency War Burial Procedures
- STANAG 2084——Handling and Reporting of Captured Enemy Equipment and Documents
- STANAG 2099——Fire Co-ordination in Support of Land Forces
- STANAG 2101——Establishing Liaison
- STANAG 2103——Reporting Nuclear Detonations, Biological and Chemical Attacks, and Predicting and Warning of Associated Hazards and Hazard Areas
- STANAG 2104——Friendly Nuclear Strike Warning
- STANAG 2111——Target Analysis – Nuclear Weapons
- STANAG 2113——Denial of Military Equipment and Supplies to an Enemy
- STANAG 2122——Medical Training in First-Aid, Basic Hygiene and Emergency Care
- STANAG 2126——First-Aid Kits and Emergency Medical Care Kits
- STANAG 2129——Recognition and Identification of Forces on the Battlefield

- | | | | |
|-------------|--|-------------|---|
| STANAG 2132 | Documentation Relative to Medical Evacuation, Treatment and Cause of Death of Patients | STANAG 2271 | Urban Areas |
| STANAG 2149 | Intelligence Request | STANAG 2844 | Counterintelligence Procedures |
| STANAG 2253 | Roads and Road Structures | STANAG 2867 | Radiotelephone Procedures for the Conduct of Artillery Fire |
| STANAG 2254 | Navigable Inland Waterways | STANAG 2868 | Land Force Tactical Doctrine, ATP-35(A) |
| STANAG 2255 | Ports | STANAG 3204 | Aeromedical Evacuation |
| STANAG 2256 | Inland Hydrography | STANAG 3465 | Safety, Emergency and Signalling Procedures for Military Air Movement-Fixed Wing Aircraft |
| STANAG 2257 | Railways | STANAG 3570 | Drop Zones and Extraction Zones-Criteria and Markings |
| STANAG 2259 | Terrain | STANAG 3700 | NATO Tactical Air Doctrine, ATP-33(B) |
| STANAG 2260 | Electric Power | | |
| STANAG 2263 | Coastal Areas and Landing Beaches | | |
| STANAG 2269 | Engineer Resources | | |

Projected Publications

Projected publications are sources of additional information that are scheduled for printing but are not yet available. Upon print, they will be distributed automatically via pinpoint distribution. They may be obtained from the USAAG Publications Center until indexed in DA Pamphlet 25-30.

- | | | | |
|----------------|---|---------------------|--|
| JCS Pub 3-0 | Doctrine for Joint Operations | JCS Pub 5-02.21 | (S) JOPS Vol II, OPLAN Format and Guidance (Secret Supplement) (U) |
| JCS Pub 3-07 | Doctrine for Joint Operations in Low-Intensity Conflict | JCS Pub 5-05.5 | Joint Special Operations Targeting and Mission Planning Procedures |
| JCS Pub 5-02 | Joint Operational Planning System | FM 100-25 | Doctrine for Army Special Operations Forces (SF, Rangers, CA, PSYOP, SOA) |
| JCS Pub 5-02.1 | JOPS Vol I, Deliberate Planning Procedures | ARTEP 31-802-MTP | Special Forces Group and Battalion Command and Control |
| JCS Pub 5-02.2 | JOPS Vol II, OPLAN Format and Guidance | ARTEP 31-807-33-MTP | Mission Training Plan for the Special Forces Company: Foreign Internal Defense |
| | | ARTEP 31-807-34-MTP | (S-NF) Selective Special Forces Company Tasks (U) |

Index

-
- A detachment(s) (see Special Forces operational detachment[s] [SFOD])**
A detachment staff 4-15
adaptive (time-sensitive) targeting 7-6
advanced operational base (AOB)
 4-11, 5-9, 5-10, 6-12, 6-14
advisors 10-5
advisory assistance 10-2
Air Force Special Operations Command (AFSOC)
 6-9
AirLand battle 1-5
all-source intelligence center (ASIC)
 6-6, 13-2 *through* 13-4
all-source production section (ASPS) 6-6, 12-2
alternate bases 6-14
antiterrorism 3-5
area assessment 7-9, 13-2, 15-4
area command 4-11, 5-18, 9-7
area commander 9-13, 9-14
area coordination center (ACC) 10-9
area of responsibility (AOR) 5-2
area specialist team (AST)
 6-8, 6-9, 6-14, 7-11, 13-2, 14-8
area study 4-14, 13-2, 15-4, I-1
Army special operations forces (ARSOF)
 1-12, 13-1
Army special operations task force (ARSOTF)
 4-1, 5-2
assessment team (see also pilot team)
 7-9, 9-7, 15-3
asset 9-7
automatic resupply 14-12
auxiliary 9-4, 9-9, 16-2
aviation platoon 4-7, 14-7

barter 9-15
B detachment (see Special Forces company headquarters)
base communications support 6-12
base defense 6-14
base defense operations center (BDOC)
 4-5, 6-15
base location 6-1
base organization 6-2
basing considerations 6-1
battalion commander 4-8
battle staff 5-8
battlefield operating systems (BOS) 1-13, A-3
battlefield reconnaissance 12-1
BDOC commander 6-15
border operations (see operations)
briefback 7-16, H-1
budget officer 4-4
buildup 9-9

- CA battalion (FID/UW)——6-9, 16-1
- CA operations (*see operations*)
- casualty management——14-8
- casualty reporting——6-10
- Catalog Supply System——14-12
- chaplain——4-5
- chemical officer——4-5
- CI analysis element (CIAE)——13-4
- civic action——16-3
- civil affairs (CA)
——1-4, 4-4, 4-9, 6-9, 9-11, 10-4, 16-1, 16-2
- civil assistance——16-3
- civil-military operations (CMO)
——4-4, 16-1, A-8
- close defense area (CDA)——6-15
- close operations (*see operations*)
- collateral activities——3-5
- collection management and dissemination (CM&D)
——6-6
section——13-4
- combat diving——4-13
- combat search and rescue (CSAR)——3-6, 11-2, 11-3
- combat service support (CSS) (*see also operations*)
——14-1, A-1, A-8
- combined arms concept——A-1
- command and control (C2)——5-1, 5-7,
5-8, 5-10, 5-19, 10-8, 12-2, 13-3, 15-3
- capabilities——4-11, 5-10
- elements——4-1, 4-11
- Special Forces
——4-1, 4-7, 4-8, 4-11, 5-1, 5-10, 8-4, A-8
- command relationships——5-8, 5-16
- command sergeant major (CSM)——4-5, 4-9, 5-6
- committed SF team——7-11
- communications——2-2, 4-4,
4-7, 4-11, 4-13, 4-15, 5-9, 5-20, 5-22, 6-7, 12-2
- communications zone (COMMZ)——5-10, 6-1, 14-1
- composite teams——7-9
- confiscation——9-15
- conflict——1-3, 1-4, 2-3, 2-4, 3-4, 4-1, 4-7
environment——15-1
short of war——1-3, 1-16, 3-2
situations (*see also role of SF in*)——1-16, 9-10
- consolidation activities (*see also operations*)——9-4
- contingency operations (*see operations*)
- counterinsurgency——3-3, 10-1
- counterintelligence (CI)——4-4, 7-18, 13-1, 13-4
operations (*see operations*)
section——6-6, 13-4
- counternarcotics——3-6
- counterterrorism (CT) (*see also operations*)
——1-4, 1-16, 3-4, 15-6
role of CA in——16-3
role of SF in——1-16
- counterterrorist enhancement program (CTEP)
——3-5
- Country Team——10-2
- crisis action procedures——7-6
- critical-cell strategy (*see strategy*)
- deception (*see also operations*)——7-19, 13-4
- deep operations (*see operations*)
- defense communications system (DCS)——6-12
- defensive EW (*see also electronic counter-countermeasures*)——13-3
- deliberate mission planning (*see mission planning and preparation*)
- deliberate targeting process (*see targeting*)
- demobilization——9-10
- demonstrations——3-7
- deployment C2——5-16
- deputy commander——4-3
- deterrence——1-2
- direct action (DA) (*see also operations*)
1-4, 1-16, 3-3, 3-7, 4-13, 5-10, 11-1, 16-3
role of CA in——16-3
role of SF in——1-16, 3-3, 3-7
- disaster relief——3-5
- discipline——9-13
- displaced civilians——16-3
- Drug Enforcement Administration (DEA)——3-6
- dynamics of military power——1-6
- echelons above corps intelligence center (EACIC)
——5-7, 13-1
- electronic counter-countermeasures (ECCM)
(*see also defensive EW*)——4-4, 13-3
- electronic countermeasures (ECM)——13-3
- electronic maintenance section——6-12
- electronic support measures (ESM)——13-3
- electronic warfare (EW)——2-2, 4-4, 6-7, 13-3
- emergency resupply——14-12
- en route E&E plan——8-4

- engineer—4-4
 engineer section—6-9
 essential elements of friendly information (EEFI)—7-18
 evasion and escape (E&E)—3-2, 9-10
 executive officer—4-4, 4-8
 exfiltration—2-1, 2-3, 4-1, 4-7, 4-13, 8-1, 8-5
 air—2-2, 4-1, 4-13, 8-5
 land—2-2, 4-1, 4-13
 sea—2-2, 4-1, 4-13
 water—8-5
- FID operations (*see operations*)
 field services—14-7, 14-10
 finance operations—14-8
 fire support system—A-7
 flight surgeon—4-5, 4-9
 follow-on missions (*see missions*)
 food service section—6-11
 foreign internal defense (FID)
 (*see also operations*)—1-4, 1-15, 3-1, 4-13, 4-15, 5-10, 10-1, 15-6, 16-2
 role of CA in—16-2
 role of SF in—1-15, 3-2, 10-1
 foreign nation support (FNS)—14-3, 14-4, 14-9
 forward operational base(s) (FOB)
 —4-1, 4-8, 4-11, 4-16, 5-7, 5-8, 6-1, 6-12, 10-7, 12-2, 14-3, 14-9
 independent—5-8, 5-10
 OPCEN—6-2, 6-12
 SIGCEN—6-2, 6-12
 SPTCEN—6-2, 6-10
 subordinate—5-8
- general area study (*see also area study*)—13-2
 general war—2-1
 global operating systems (GOS)—A-3
 group
 battle staff—5-8
 chemical detachment—4-16
 commander—4-3
 headquarters—4-2
 headquarters and headquarters company—4-2
 PSYOP detachment—15-3
 guerrilla
 force—9-4, 9-9
 warfare (GW)—3-1, 3-2, 9-4
- headquarters and headquarters company—4-2, 4-3
 headquarters commandant—6-15
 headquarters detachment (SFOD C)
 (*see Special Forces battalion*)
 health service support (HSS)
 (*see also resistance HSS*)—4-7, 14-3, 14-9, 14-11
 hostile
 EW capabilities—2-2 through 2-4
 NBC capabilities—2-2 through 2-4
 rear area security—2-2 through 2-4
 human intelligence (HUMINT)—6-6, 12-2
 humanitarian assistance (HA)—3-5, 16-3
- independent FOB (*see forward operating base[s]*)
 infiltration—2-1, 4-1, 4-7, 4-13, 8-2, 8-3
 air—2-2, 4-1, 4-7, 4-13, 8-1
 land—2-2, 4-1, 4-7, 4-13, 8-1, 8-3
 sea—2-2, 4-1, 4-7, 4-13
 water—8-1, 8-3
 initial contact—9-7
 insurgency—2-4, 9-1 through 9-4, 9-10, 10-1, 10-8
 rural-based—9-4
 urban-based—9-4
 intelligence and electronic warfare (IEW)
 —4-10, 13-1
 intelligence collection—3-1, 9-4, 9-10, 13-1
 intelligence operations (*see operations*)
 intelligence preparation of the battlefield (IPB)
 —6-6, 13-2
 intelligence production agency (IPA)—7-3
 intelligence support element (ISE)—5-7
 intermediate staging base (ISB)—5-9
 internal defense and development (IDAD)
 —10-1, 10-3
 interrogation teams—6-7
 IPB process (*see intelligence preparation of the battlefield*)
 isolation facility (ISOFAC)—4-11, 5-8, 6-8, 6-9, 6-11, 6-14, 7-11, 9-6, 14-8

joint environment	5-1	missions (<i>see also</i> SF missions)	7-6
joint intelligence center (JIC)	5-7	follow-on	3-7
joint operations center (JOC)	5-2	multiple	3-7
Joint Operations Planning System (JOPS)	7-6	mission support base	5-9
Joint Rescue Coordination Center	11-2	mission support plans	7-6
joint SO targeting process (<i>see also</i> targeting)	7-1	mission support site(s) (MSS)	9-8
joint special operations area (JSOA)	3-7, 5-17, 7-6, 7-10, 9-10, 11-2, 13-2, 15-5, 16-2	mission tasking package (MTP)	7-3, 7-10
joint special operations task force (JSOTF)	4-1, 4-8, 5-18, 11-2	mobile training assistance	3-5
Joint Strategic Capabilities Plan (JSCP)	1-2	mobile training teams (MTTs)	3-5
joint target board (JTB)	7-1, 13-3		
judge advocate	4-5	named areas of interest (NAIs)	3-4, 12-2
		National Command Authorities (NCA)	1-5, 5-17, 11-2
launch and recovery site	5-9	national interests	1-1
level of operations	1-13 <i>through</i> 1-15, 3-4	national military strategic objectives	1-2
operational	1-13, 3-4	national military strategy	1-2
strategic	1-13, 3-4	National Security Council	1-2
tactical	1-13, 3-4	national security objectives	1-2
levy system	9-15	national security strategy	1-2
liaison		Naval Special Warfare Task Group (NSWTG)	6-9
officers	6-9	noncombatant	
section	6-9	evacuation	3-5
limited war	1-13, 2-3	evacuees	16-3
lines of communication (LOC)	1-13, 10-5, 12-2	nonpermissive environments	4-1
linkup (<i>see also</i> operations)	5-21, 9-10	nuclear, biological, and chemical (NBC)	1-2, 4-16, A-8
long-range surveillance units (LRSUs)	3-4	capabilities	2-2 <i>through</i> 2-4, 12-2, A-8
main defense area (MDA)	6-15	environment	6-16, 7-19
maintenance	6-11, 14-7, 14-10	threat	7-19
maneuver system	A-7	nuclear risk	2-2
mass-oriented strategy (<i>see</i> strategy)			
mechanical maintenance section (<i>see</i> maintenance)		on-call resupply	14-12
medical section	4-7, 14-6, 14-9, 14-11	operating systems	A-1
MI detachment(s)	4-5, 4-11, 6-6, 7-1, 13-1	operation plan (OPLAN)	5-8, 5-9, B-1, C-1
MI detachment commander	6-6	operational area intelligence	13-2
military free-fall (MFF)	4-13	operational base(s)	6-1, 6-14, 6-15
military police (MP)	1-15, 10-8	operational continuum	1-3, 1-4, 1-17
mission concept (MICON)	7-3, 7-16	operational project stocks	14-4, 14-9, 14-12
mission-essential task lists (METLs)	7-11	operations	
mission letter(s)	7-6, 7-11, E-1, F-1, G-1	border	10-5
mission planning agent (MPA)	7-3, 7-6	CA	10-3
mission planning and preparation	7-1	CI	4-11, 13-4
adaptive	7-6	civil-military	16-1
deliberate	7-6, 7-10, 7-16	close	1-13
time-sensitive	7-6, 7-16		

consolidation	10-4	Special Forces company headquarters (SFOD B)	4-11
contingency	1-17, 14-4	Special Forces operational detachment (SFOD A)	4-13
CSS	14-3	support company, SF battalion	4-10
CT	15-6	support company, SF group	4-5
DA	3-3, 4-13, 11-2, 15-6	terrorist	2-4
deception	3-6, 13-4		
deep	1-13, 1-15, 10-8	peace (<i>see also</i> role of SF in)	4-7
FID	4-13, 10-2, 15-6, A-7	peacetime operations (<i>see</i> operations)	
linkup	10-6	personnel accountability	6-10
peacetime	1-18	personnel administration center (PAC)	4-9
postal	14-8	personnel section	4-7
rear	1-13, 10-8	personnel service support (PSS)	14-8, 14-11
reconstitution	14-11	photo section	6-12
remote area	10-5	physical security	7-18
replacement	6-10, 14-8	pilot team (<i>see also</i> assessment team)	4-11, 7-9
search and rescue (SAR) (<i>see also</i> combat search and rescue [CSAR])	3-5 through 3-7, 11-2	plan of execution (POE)	7-3
SF	1-15, 4-2, 4-7, 4-8, 4-13, 16-1, A-7	planning considerations	7-16, 8-1
SR	3-4, 4-13, 12-2	politico-military	2-5, 3-1, 4-4, 15-1, 16-2
strategic	1-15	populace and resource control (PRC)	10-4, 16-3
strike	10-5	port of debarkation (POD)	5-16
tactical	1-15, 10-4	Posse Comitatus Act	3-6
Third World contingency	10-8	postal operations (<i>see</i> operations)	
urban area	10-6	preliminary assessment (PA)	6-7, 7-3, 7-6, D-1
UW	3-1, 4-13, 15-5, 15-6, A-8	pre-positioned war reserve materiel stocks (PWRMS)	14-5, 14-10
operations center (OPCEN)	4-3, 6-5 through 6-10, 6-12	pre-positioning of materiel configured in units sets (POMCUS)	14-4
director	6-5	principles of	
FOB	6-1, 6-2	NBC defense	7-20
SFOB	4-3, 6-1	special operations	1-5
operations security (OPSEC)	3-6, 6-1, 7-18, 8-4, 9-4, 13-4, 14-4, A-8	war	1-6
organization		priority intelligence requirements (PIR)	3-4
area basis	5-9	psychological impact	7-19
base	6-2	psychological operations (PSYOP)	1-4, 7-19, 9-10 through 9-12, 10-3, 10-4, 15-1
FOB	5-9	area assessment	15-4
functional basis	5-9	element	6-10, 15-3
group	4-1	in the seven phases of US-sponsored UW	9-5, J-1
guerrilla	9-9	organization	15-3
headquarters and headquarters company, SF group	4-2	planning	15-2
headquarters detachment, SF battalion	4-8	staff officer	15-3
PSYOP	15-3	psychological preparation	9-5
resistance	7-8, 9-4 through 9-16, 15-5, 16-2		
Special Forces battalion	4-7		
Special Forces company	4-11		

- radio relay site 5-9
- rangers 3-3
- rear operations (*see operations*)
- reconstitution (*see operations*)
- regeneration 14-11
- remote area operations (*see operations*)
- remote marshaling base (REMAB) 5-17
- reorganization 14-11
- replacement operations (*see operations*)
- resistance
 - health service support 9-15
 - leadership 9-2, 9-7, 9-13
 - logistics 9-14
 - movement(s) 9-2, 9-5
 - organization—7-8, 9-4 *through* 9-15, 15-5, 16-2
 - potential 9-5
- rigger-air delivery section(s) 6-11, 14-7
- role of CA in
 - CT 16-3
 - DA 16-3
 - FID 16-2
 - UW 16-2
- role of Special Forces in
 - conflict 1-16
 - CT 1-16
 - DA 1-16
 - FID 1-17
 - peace 1-18
 - SR 1-17
 - UW 1-17
 - war 1-13
- rural-based insurgency (*see insurgency*)

- S1 4-4, 4-9, 5-8, 6-10, 6-12, 14-8
- S2 4-4, 4-9, 5-8, 6-6, 6-9, 7-19, 12-2, 13-3
- S3 4-4, 4-9
5-8, 6-7, 6-9, 6-11, 7-10, 7-19, 13-3, 14-8
- S4 4-4, 4-9, 5-8, 6-9 *through* 6-12, 14-7, 14-10
- S5 4-4, 4-9, 5-8, 6-9, 14-4
- sabotage 2-3, 3-3, 9-2, 9-10, 11-2
- search and rescue (SAR) (*see operations*)
- security 3-5
- security activities 3-5
- security assistance (SA) 3-5, 5-10, 5-14
- security assistance force (SAF) 10-6, 10-9, 15-6
- security assistance organization (SAO)
..... 4-2, 4-8, 5-13 *through* 5-16, 10-2, 10-6
- security assistance team (SAT) 5-13
- security forces 6-14
- sensitive compartmented information facility (SCIF)
..... 6-6
- service detachment 4-7, 4-11, 6-11, 14-5, 14-7
- seven phases of US-sponsored UW
(*see also psychological operations*) 9-5, J-1
- SF command and control (*see command
and control [C2]*)
- SF deep operations (*see operations*)
- SF missions (*see counterterrorism, direct action,
foreign internal defense, special reconnais-
sance, unconventional warfare*)
- SF teams(s) 1-13, 2-1, 3-3, 4-1, 5-8, 6-6, 7-1,
8-1, 9-5, 10-1, 11-1, 12-2, 13-2, 14-7, 15-2, 16-1
- shows of force 3-7
- signal center (SIGCEN) 4-4, 6-2, 6-12
FOB 4-11, 6-12
SFOB 4-4, 6-12
- signal detachment 4-7, 4-11
- signal intelligence (SIGINT) 6-7, 12-1, 13-4
- signal officer 4-4, 4-9, 5-8, 6-12, 13-3
- signal section 6-9
- signal security 7-18
- site
 - launch and recovery 5-9
 - radio relay 5-9
- situation development 13-2
- special activities 3-6
- special category (SPECAT) 5-8
- Special Forces (SF) 1-12
- Special Forces battalion 4-7, 4-8, 4-11
- Special Operations command and control
element (SOCCE) 4-1, 5-18
- Special Forces company 4-11, 4-13
- Special Forces company headquarters
(SFOD B) 4-11
- Special Forces group (airborne) 4-1, 4-2, 4-5
- Special Forces operational base (SFOB)
..... 4-1, 4-3, 5-7, 6-2, 10-7, 14-9
command and control (*see command
and control [C2]*)
OPCEN 4-3, 6-2, 6-12
organization (*see organization*)
SIGCEN 4-4, 6-2, 6-12
SPTCEN 4-5, 6-12

- Special Forces operational detachment(s) (SFOD)
 _____1-12, 4-11, 6-2, 6-9, 7-6, 7-8, A-8
 (SFOD A) _____4-11, 4-15, 5-18, 7-9
 (SFOD B) _____4-11, 5-9, 5-18, 6-8, 7-9
- special operations (SO)
 imperatives _____1-9
 principles _____1-5
- special operations command (SOC)
 _____5-2, 5-17, 7-1, 13-3, 15-3
 commander _____5-19,
 6-10, 7-1, 7-3, 7-6, 11-2, 13-3, 14-11
 J6 _____14-12
 target panel _____7-3
- special operations forces (SOF) _____1-4, 10-9
- special operations mission planning
 folder (SOMPF) _____7-3, 13-2
- special operations team(s) A (SOT A)
 _____4-11, 6-7, 13-3
- special reconnaissance (SR) (*see also* operations)
 _____1-4, 1-15, 3-4, 3-7, 4-13, 12-1, 12-2, 15-6
- special security office (SSO) _____6-6, 6-7, 6-9
- special security representative (SSR) _____4-9
- split teams _____7-9
- statement of requirements (SOR) _____7-10
- stay-behind operations _____8-5
- strategic
 environment _____1-1
 operations (*see* operations)
 reconnaissance _____1-4
 role of SF _____1-13
- strategy
 critical-cell _____2-4, 9-5
 mass-oriented _____2-4, 9-5
 subversive _____2-4
 traditional _____2-4
 terrorist _____2-4
- strength management _____6-10, 14-8
- strike operations (*see* operations)
- subversion _____3-2, 9-2
- subversive
 activities _____9-2, 9-9
 strategy (*see* strategy)
- supply and transportation _____6-11, 14-5, 14-6
- support center (SPTCEN) (*see also* FOB
 and SFOB) _____4-5, 6-10, 14-3
 director _____6-10, 6-14
 service detachment _____14-12
- support company _____4-5, 4-10
- support of US combat forces _____10-6
- support relationship _____14-10
- surveillance and clandestine collection _____12-1
- sustainment _____14-4
- tactical EAF _____6-7
- tactical operations center (TOC) _____4-5
- tactical operations (*see* operations)
- tactical SSO _____6-6
- tailoring _____7-9
- target development (*see* targeting)
- target intelligence package (TIP) (*see* targeting)
- targeting _____7-1, 7-3, 13-1, 13-2
- task organization _____7-9
- task organize _____1-13
- team selection _____7-6
- technical control analysis element (TCAE)
 _____6-6, 13-4
- terrain team _____6-7
- terrorism _____3-4, 3-5
- theater army (TA) _____14-1
- theater army area command (TAACOM)
 _____10-8, 14-1, 14-6
- theater army materiel management
 center (TAMMC) _____14-1, 14-6
- theater army movement control
 agency (TAMCA) _____14-2
- theater army special operations support
 command (TASOSC) _____5-5, 5-16, 5-20,
 7-1, 7-18, 14-2, 14-4, 14-8, 14-9, 14-11
 plans and operations director _____7-10
 signal officer _____14-12
- theater CINC _____5-2,
 5-19, 7-9, 9-10, 10-8, 11-2, 13-2, 16-2
- theater communications system (TCS) _____6-12
- theater operating systems (TOS) _____A-3
- theater search and rescue (*see also* combat
 search and rescue) _____1-5
- theater special operations command (*see* special
 operations command)
- Third World
 contingency operations (*see* operations)
 nuclear proliferation _____2-3
- threats _____1-2, 2-1, 2-3, 2-4
- time-sensitive mission planning (*see* mission
 planning and preparation)
- traditional strategy _____2-4

training teams	3-5	urban-based insurgency (<i>see</i> insurgency)	
transportation	14-7, 14-10	USAF weather officer	6-6
		US defense representative (USDR)	5-14
uncommitted SFODs	6-11		
unconventional warfare (UW) (<i>see also</i> operations)		war (<i>see also</i> role of SF in)	1-4, 1-13, 4-7, 9-4
	1-4, 3-1, 3-7, 4-13,	general	9-4
	4-15, 5-10, 9-1, 11-1, 12-1, 13-4, 15-5	limited	9-4
role of CA in	16-2	war reserve materiel stocks (WRMS)	14-4
role of SF in	3-1, 3-7	war reserve stocks	14-12
underground	9-4	weapons proliferation	2-2
urban area operations (<i>see</i> operations)			

By Order of the Secretary of the Army:

CARL E. VUONO
General, United States Army
Chief of Staff

Official:

WILLIAM J. MEEHAN II
Brigadier General, United States Army
The Adjutant General

DISTRIBUTION:

Active Army, USAR, and ARNG: To be distributed in accordance with DA Form 12-11E, requirements for FM 31-20, Special Forces Operations (Qty rqr block no. 531).