

THE MECHATRONICS HANDBOOK

Editor-in-Chief
Robert H. Bishop

*The University of Texas at Austin
Austin, Texas*



**ISA—The Instrumentation, Systems,
and Automation Society**



CRC PRESS

Boca Raton London New York Washington, D.C.

This reference text is published in cooperation with ISA Press, the publishing division of ISA–The Instrumentation, Systems, and Automation Society. ISA is an international, nonprofit, technical organization that fosters advancement in the theory, design, manufacture, and use of sensors, instruments, computers, and systems for measurement and control in a wide variety of applications. For more information, visit www.isa.org or call (919) 549-8411.

Library of Congress Cataloging-in-Publication Data

Catalog record is available from the Library of Congress

This book contains information obtained from authentic and highly regarded sources. Reprinted material is quoted with permission, and sources are indicated. A wide variety of references are listed. Reasonable efforts have been made to publish reliable data and information, but the authors and the publisher cannot assume responsibility for the validity of all materials or for the consequences of their use.

Neither this book nor any part may be reproduced or transmitted in any form or by any means, electronic or mechanical, including photocopying, microfilming, and recording, or by any information storage or retrieval system, without prior permission in writing from the publisher.

All rights reserved. Authorization to photocopy items for internal or personal use, or the personal or internal use of specific clients, may be granted by CRC Press LLC, provided that \$1.50 per page photocopied is paid directly to Copyright Clearance Center, 222 Rosewood Drive, Danvers, MA 01923 USA The fee code for users of the Transactional Reporting Service is ISBN 0-8493-0066-5/02/\$0.00+\$1.50. The fee is subject to change without notice. For organizations that have been granted a photocopy license by the CCC, a separate system of payment has been arranged.

The consent of CRC Press LLC does not extend to copying for general distribution, for promotion, for creating new works, or for resale. Specific permission must be obtained in writing from CRC Press LLC for such copying.

Direct all inquiries to CRC Press LLC, 2000 N.W. Corporate Blvd., Boca Raton, Florida 33431.

Trademark Notice: Product or corporate names may be trademarks or registered trademarks, and are used only for identification and explanation, without intent to infringe.

Visit the CRC Press Web site at www.crcpress.com

© 2002 by CRC Press LLC

No claim to original U.S. Government works
International Standard Book Number 0-8493-0066-5
Printed in the United States of America 1 2 3 4 5 6 7 8 9 0
Printed on acid-free paper

Preface

According to the original definition of mechatronics proposed by the Yasakawa Electric Company and the definitions that have appeared since, many of the engineering products designed and manufactured in the last 25 years integrating mechanical and electrical systems can be classified as *mechatronic systems*. Yet many of the engineers and researchers responsible for those products were never formally trained in mechatronics *per se*. The *Mechatronics Handbook* can serve as a reference resource for those very same design engineers to help connect their everyday experience in design with the vibrant field of mechatronics. More generally, this handbook is intended for use in research and development departments in academia, government, and industry, and as a reference source in university libraries. It can also be used as a resource for scholars interested in understanding and explaining the engineering design process. As the historical divisions between the various branches of engineering and computer science become less clearly defined, we may well find that the mechatronics specialty provides a roadmap for nontraditional engineering students studying within the traditional structure of most engineering colleges. It is evident that there is an expansion of mechatronics laboratories and classes in the university environment worldwide. This fact is reflected in the list of contributors to this handbook, including an international group of 88 academicians and engineers representing 13 countries. It is hoped that the *Mechatronics Handbook* can serve the world community as the definitive reference source in mechatronics.

Organization

The *Mechatronics Handbook* is a collection of 50 chapters covering the key elements of mechatronics:

- a. Physical Systems Modeling
- b. Sensors and Actuators
- c. Signals and Systems
- d. Computers and Logic Systems
- e. Software and Data Acquisition

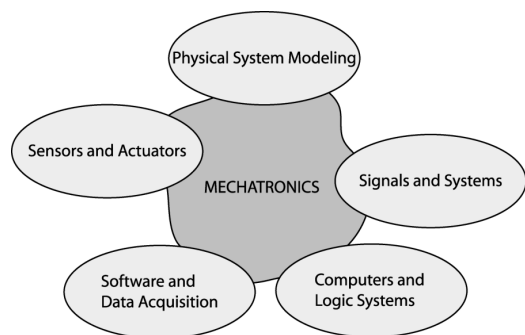

Section One – Overview of Mechatronics

In the opening section, the general subject of mechatronics is defined and organized. The chapters are overview in nature and are intended to provide an introduction to the key elements of mechatronics. For readers interested in education issues related to mechatronics, this first section concludes with a discussion on new directions in the mechatronics engineering curriculum. The chapters, listed in order of appearance, are:

1. [What is Mechatronics?](#)
2. [Mechatronic Design Approach](#)

3. System Interfacing, Instrumentation and Control Systems
4. Microprocessor-Based Controllers and Microelectronics
5. An Introduction to Micro- and Nanotechnology
6. Mechatronics: New Directions in Nano-, Micro-, and Mini-Scale Electromechanical Systems Design, and Engineering Curriculum Development

Section Two – Physical System Modeling

The underlying mechanical and electrical mathematical models comprising most mechatronic systems are presented in this section. The discussion is intended to provide a detailed description of the process of physical system modeling, including topics on structures and materials, fluid systems, electrical systems, thermodynamic systems, rotational and translational systems, modeling issues associated with MEMS, and the physical basis of analogies in system models. The chapters, listed in order of appearance, are:

7. Modeling Electromechanical Systems
8. Structures and Materials
9. Modeling of Mechanical Systems for Mechatronics Applications
10. Fluid Power Systems
11. Electrical Engineering
12. Engineering Thermodynamics
13. Modeling and Simulation for MEMS
14. Rotational and Translational Microelectromechanical Systems: MEMS Synthesis, Microfabrication, Analysis, and Optimization
15. The Physical Basis of Analogies in Physical System Models

Section Three – Sensors and Actuators

The basics of sensors and actuators are introduced in the third section. This section begins with chapters on the important subject of time and frequency and on the subject of sensor and actuator characteristics. The remainder of the section is subdivided into two categories: sensors and actuators. The chapters include both the fundamental physical relationships and mathematical models associated with the sensor and actuator technologies. The chapters, listed in order of appearance, are:

16. Introduction to Sensors and Actuators
17. Fundamentals of Time and Frequency
18. Sensor and Actuator Characteristics
19. Sensors
 - 19.1 Linear and Rotational Sensors
 - 19.2 Acceleration Sensors
 - 19.3 Force Measurement
 - 19.4 Torque and Power Measurement
 - 19.5 Flow Measurement
 - 19.6 Temperature Measurements
 - 19.7 Distance Measuring and Proximity Sensors
 - 19.8 Light Detection, Image, and Vision Systems
 - 19.9 Integrated Micro-sensors

20. Actuators

- 20.1 Electro-mechanical Actuators
- 20.2 Electrical Machines
- 20.3 Piezoelectric Actuators
- 20.4 Hydraulic and Pneumatic Actuation Systems
- 20.5 MEMS: Microtransducers Analysis, Design and Fabrication

Section Four – Systems and Controls

An overview of signals and systems is presented in this fourth section. Since there is a significant body of readily-available material to the reader on the general subject of signals and systems, there is not an overriding need to repeat that material here. Instead, the goal of this section is to present the relevant aspects of signals and systems of special importance to the study of mechatronics. The section begins with articles on the role of control in mechatronics and on the role of modeling in mechatronic design. These chapters set the stage for the more fundamental discussions on signals and systems comprising the bulk of the material in this section. Modern aspects of control design using optimization techniques from H^2 theory, adaptive and nonlinear control, neural networks and fuzzy systems are also included as they play an important role in modern engineering system design. The section concludes with a chapter on design optimization for mechatronic systems. The chapters, listed in order of appearance, are:

- 21. The Role of Controls in Mechatronics
- 22. The Role of Modeling in Mechatronics Design
- 23. Signals and Systems
 - 23.1 Continuous- and Discrete-time Signals
 - 23.2 Z Transforms and Digital Systems
 - 23.3 Continuous- and Discrete-time State-space Models
 - 23.4 Transfer Functions and Laplace Transforms
- 24. State Space Analysis and System Properties
- 25. Response of Dynamic Systems
- 26. Root Locus Method
- 27. Frequency Response Methods
- 28. Kalman Filters as Dynamic System State Observers
- 29. Digital Signal Processing for Mechatronic Applications
- 30. Control System Design Via H^2 Optimization
- 31. Adaptive and Nonlinear Control Design
- 32. Neural Networks and Fuzzy Systems
- 33. Advanced Control of an Electrohydraulic Axis
- 34. Design Optimization of Mechatronic Systems

Section Five – Computers and Logic Systems

The development of the computer, and then the microcomputer, embedded computers, and associated information technologies and software advances, has impacted the world in a profound manner. This is especially true in mechatronics where the integration of computers with electromechanical systems has led to a new generation of smart products. The future is filled with promise of better and more intelligent products resulting from continued improvements in computer technology and software engineering. The last two sections of the *Mechatronics Handbook* are devoted to the topics of computers and software. In

this fifth section, the focus is on computer hardware and associated issues of logic, communication, networking, architecture, fault analysis, embedded computers, and programmable logic controllers. The chapters, listed in order of appearance, are:

35. Introduction to Computers and Logic Systems
36. Logic Concepts and Design
37. System Interfaces
38. Communication and Computer Networks
39. Fault Analysis in Mechatronic Systems
40. Logic System Design
41. Synchronous and Asynchronous Sequential Systems
42. Architecture
43. Control with Embedded Computers and Programmable Logic Controllers

Section Six – Software and Data Acquisition

Given that computers play a central role in modern mechatronics products, it is very important to understand how data is acquired and how it makes its way into the computer for processing and logging. The final section of the *Mechatronics Handbook* is devoted to the issues surrounding computer software and data acquisition. The chapters, listed in order of appearance, are:

44. Introduction to Data Acquisition
45. Measurement Techniques: Sensors and Transducers
46. A/D and D/A Conversion
47. Signal Conditioning
48. Computer-Based Instrumentation Systems
49. Software Design and Development
50. Data Recording and Logging

Acknowledgments

I wish to express my heartfelt thanks to all the contributing authors. Taking time in otherwise busy and hectic schedules to author the excellent articles appearing in the *Mechatronics Handbook* is much appreciated. I also wish to thank my Advisory Board for their help in the early stages of planning the topics in the handbook.

This handbook is a result of a collaborative effort expertly managed by CRC Press. My thanks to the editorial and production staff:

Nora Konopka, Acquisitions Editor
Michael Buso, Project Coordinator
Susan Fox, Project Editor

Thanks to my friend and collaborator Professor Richard C. Dorf for his continued support and guidance. And finally, a special thanks to Lynda Bishop for managing the incoming and outgoing draft manuscripts. Her organizational skills were invaluable to this project.

Robert H. Bishop
Editor-in-Chief

Editor-in-Chief



Robert H. Bishop is a Professor of Aerospace Engineering and Engineering Mechanics at The University of Texas at Austin and holds the Myron L. Begeman Fellowship in Engineering. He received his B.S. and M.S. degrees from Texas A&M University in Aerospace Engineering, and his Ph.D. from Rice University in Electrical and Computer Engineering. Prior to coming to The University of Texas at Austin, he was a member of the technical staff at the MIT Charles Stark Draper Laboratory. Dr. Bishop is a specialist in the area of planetary explo-

ration with an emphasis on spacecraft guidance, navigation, and control. He is currently working with NASA Johnson Space Center and the Jet Propulsion Laboratory on techniques for achieving precision landing on Mars. He is an active researcher authoring and co-authoring over 50 journal and conference papers. He was twice selected as a Faculty Fellow at the NASA Jet Propulsion Laboratory and a Welliver Faculty Fellow by The Boeing Company. Dr. Bishop co-authored *Modern Control Systems* with Prof. R. C. Dorf, and he has authored two other books entitled *Learning with LabView* and *Modern Control System Design and Analysis Using Matlab and Simulink*. He recently received the John Leland Atwood Award from the American Society of Engineering Educators and the American Institute of Aeronautics and Astronautics that is given periodically to “a leader who has made lasting and significant contributions to aerospace engineering education.”

Contributors

Maruthi R. Akella

University of Texas at Austin
Austin, Texas

Sami A. Al-Arian

University of South Florida
Tampa, Florida

M. Anjanappa

University of Maryland
Baltimore, Maryland

Dragos Arotaritei

Aalborg University Esbjerg
Esbjerg, Denmark

Ramutis Bansevicius

Kaunas University of Technology
Kaunas, Lithuania

Eric J. Barth

Vanderbilt University
Nashville, Tennessee

Peter Breedveld

University of Twente
Enschede, The Netherlands

Tomas Brezina

Technical University of Brno
Brno, Czech Republic

George T.-C. Chiu

Purdue University
West Lafayette, Indiana

George I. Cohn

California State University
Fullerton, California

Daniel A. Connors

University of Colorado
Boulder, Colorado

Kevin C. Craig

Rensselaer Polytechnic Institute
Troy, New York

Timothy P. Crain II

NASA Johnson Space Center
Houston, Texas

Jace Curtis

National Instruments, Inc.
Austin, Texas

K. Datta

University of Maryland
Baltimore, Maryland

Raymond de Callafon

University of California
La Jolla, California

Santosh Devasia

University of Washington
Seattle, Washington

Ivan Dolezal

Technical University of Liberec
Liberec, Czech Republic

C. Nelson Dorny

University of Pennsylvania
Philadelphia, Pennsylvania

Stephen A. Dyer

Kansas State University
Manhattan, Kansas

M.A. Elbestawi

McMaster University
Hamilton, Ontario, Canada

Eniko T. Enikov

University of Arizona
Tucson, Arizona

Halit Eren

Curtin University of Technology
Bentley, Australia

H. R. (Bart) Everett

Space and Naval Warfare Systems
Center
San Diego, California

Jorge Fernando Figueroa

NASA Stennis Space Center
New Orleans, Louisiana

C. J. Fraser

University of Abertay Dundee
Dundee, Scotland

Kris Fuller

National Instruments, Inc.
Austin, Texas

Ivan J. Garshelis

Magnova, Inc.
Pittsfield, Massachusetts

Carroll E. Goering

University of Illinois
Urbana, Illinois

Michael Goldfarb

Vanderbilt University
Nashville, Tennessee

Margaret H. Hamilton

Hamilton Technologies, Inc.
Cambridge, Massachusetts

Cecil Harrison

University of Southern Mississippi
Hattiesburg, Mississippi

Bonnie S. Heck

Georgia Institute of Technology
Atlanta, Georgia

Neville Hogan

Massachusetts Institute of
Technology
Cambridge, Massachusetts

Rick Homkes

Purdue University
Kokomo, Indiana

Bouvard Hosticka

University of Virginia
Charlottesville, Virginia

Wen-Mei W. Hwu

University of Illinois
Urbana, Illinois

Mohammad Ilyas

Florida Atlantic University
Boca Raton, Florida

Florin Ionescu

University of Applied Sciences
Konstanz, Germany

Stanley S. Ipson

University of Bradford
Bradford, West Yorkshire, England

Rolf Isermann

Darmstadt University of Technology
Darmstadt, Germany

Hugh Jack

Grand Valley State University
Grand Rapids, Michigan

Jeffrey A. Jalkio

University of St. Thomas
St. Paul, Minnesota

Rolf Johansson

Lund Institute of Technology
Lund, Sweden

J. Katupitiya

The University of New South Wales
Sydney, Australia

Ctirad Kratochvil

Technical University of Brno
Brno, Czech Republic

Thomas R. Kurfess

Georgia Institute of Technology
Atlanta, Georgia

Kam Leang

University of Washington
Seattle, Washington

Chang Liu

University of Illinois
Urbana, Illinois

Michael A. Lombardi

National Institute of Standards and
Technology
Boulder, Colorado

Raul G. Longoria

University of Texas at Austin
Austin, Texas

Kevin M. Lynch

Northwestern University
Evanston, Illinois

Sergey Edward Lyshevski

Indiana University-Purdue
University Indianapolis
Indianapolis, Indiana

Tom Magruder

National Instruments, Inc.
Austin, Texas

Francis C. Moon

Cornell University
Ithaca, New York

Thomas N. Moore

Queen's University
Kingston, Ontario, Canada

Michael J. Moran

The Ohio State University
Columbus, Ohio

Pamela M. Norris

University of Virginia
Charlottesville, Virginia

Leila Notash

Queen's University
Kingston, Ontario, Canada

Ondrej Novak

Technical University of Liberec
Liberec, Czech Republic

Cestmir Ondrusek

Technical University of Brno
Brno, Czech Republic

Hitay Özbay

The Ohio State University
Columbus, Ohio

Joey Parker

University of Alabama
Tuscaloosa, Alabama

Stefano Pastorelli

Politecnico di Torino
Torino, Italy

Michael A. Peshkin

Northwestern University
Evanston, Illinois

Carla Purdy

University of Cincinnati
Cincinnati, Ohio

M. K. Ramasubramanian

North Carolina State University
Raleigh, North Carolina

Giorgio Rizzoni

The Ohio State University
Columbus, Ohio

Armando A. Rodriguez

Arizona State University
Tempe, Arizona

Momoh-Jimoh Eyiomika Salami

International Islamic University of
Malaysia
Kuala Lumpur, Malaysia

Mario E. Salgado

Universidad Tecnica Federico Santa
Maria
Valparaiso, Chile

Jyh-Jong Sheen

National Taiwan Ocean University
Keelung, Taiwan

T. Song

University of Maryland
Baltimore, Maryland

Massimo Sorli

Politecnico di Torino
Torino, Italy

Andrew Sterian

Grand Valley State University
Grand Rapids, Michigan

Alvin Strauss

Vanderbilt University
Nashville, Tennessee

Fred Stolfi

Rensselaer Polytechnic Institute
Troy, New York

Richard Thorn

University of Derby
Derby, England

Rymantas Tadas Tolocka

Kaunas University of Technology
Kaunas, Lithuania

M. J. Tordon

The University of New South Wales
Sydney, Australia

Mike Tyler

National Instruments, Inc.
Austin, Texas

Crina Vlad

Politehnica University of Bucharest
Bucharest, Romania

Bogdan M. Wilamowski

University of Wyoming
Laramie, Wyoming

Juan I. Yuz

Universidad Tecnica Federico Santa
Maria
Vina del Mar, Chile

Qin Zhang

University of Illinois
Urbana, Illinois

Qingze Zou

University of Washington
Seattle, Washington

Job van Amerongen

University of Twente
Enschede, The Netherlands

Contents

SECTION I Overview of Mechatronics

- 1 What is Mechatronics? *Robert H. Bishop and M. K. Ramasubramanian*
- 2 Mechatronic Design Approach *Rolf Isermann*
- 3 System Interfacing, Instrumentation, and Control Systems
Rick Homkes
- 4 Microprocessor-Based Controllers and Microelectronics
Ondrej Novak and Ivan Dolezal
- 5 An Introduction to Micro- and Nanotechnology *Michael Goldfarb, Alvin Strauss and Eric J. Barth*
- 6 Mechatronics: New Directions in Nano-, Micro-, and Mini-Scale Electromechanical Systems Design, and Engineering Curriculum Development *Sergey Edward Lyshevski*

SECTION II Physical System Modeling

- 7 Modeling Electromechanical Systems *Francis C. Moon*
- 8 Structures and Materials *Eniko T. Enikov*
- 9 Modeling of Mechanical Systems for Mechatronics Applications
Raul G. Longoria

- 10 Fluid Power Systems *Qin Zhang and Carroll E. Goering*
- 11 Electrical Engineering *Giorgio Rizzoni*
- 12 Engineering Thermodynamics *Michael J. Moran*
- 13 Modeling and Simulation for MEMS *Carla Purdy*
- 14 Rotational and Translational Microelectromechanical Systems: MEMS Synthesis, Microfabrication, Analysis, and Optimization
Sergey Edward Lyshevski
- 15 The Physical Basis of Analogies in Physical System Models
Neville Hogan and Peter C. Breedveld

SECTION III Sensors and Actuators

- 16 Introduction to Sensors and Actuators *M. Anjanappa, K. Datta and T. Song*
- 17 Fundamentals of Time and Frequency *Michael A. Lombardi*
- 18 Sensor and Actuator Characteristics *Joey Parker*
- 19 Sensors
 - 19.1 Linear and Rotational Sensors *Kevin Lynch and Michael Peshkin*
 - 19.2 Acceleration Sensors *Halit Eren*
 - 19.3 Force Measurement *M. A. Elbestawi*
 - 19.4 Torque and Power Measurement *Ivan Garshelis*
 - 19.5 Flow Measurement *Richard Thorn*
 - 19.6 Temperature Measurements *Pamela Norris and Bouvard Hosticka*
 - 19.7 Distance Measuring and Proximity Sensors *J. Fernando Figueroa*
 - 19.8 Light Detection, Image, and Vision Systems *Stanley Ipson*
 - 19.9 Integrated Microsensors *Chang Liu*
- 20 Actuators
 - 20.1 Electromechanical Actuators *George T.-C. Chiu*
 - 20.2 Electrical Machines *Charles Fraser*
 - 20.3 Piezoelectric Actuators *Habil Ramutis Bansevicius and Rymanta Tadas Tolocka*

- 20.4 Hydraulic and Pneumatic Actuation Systems *Massimo Sorli and Stefano Pastorelli*
20.5 MEMS: Microtransducers Analysis, Design, and Fabrication *Sergey Lyshevski*

SECTION IV Systems and Controls

- 21 The Role of Controls in Mechatronics *Job van Amerongen*
- 22 The Role of Modeling in Mechatronics Design *Jeffrey A. Jalkio*
- 23 Signals and Systems
- 23.1 Continuous- and Discrete-Time Signals *Momoh Jimoh Salami*
 - 23.2 z Transform and Digital Systems *Rolf Johansson*
 - 23.3 Continuous- and Discrete-Time State-Space Models
Kam Leang, Qingze Zou, and Santosh Devasia
 - 23.4 Transfer Functions and Laplace Transforms *C. Nelson Dorny*
- 24 State Space Analysis and System Properties *Mario E. Salgado and Juan I. Yuz*
- 25 Response of Dynamic Systems *Raymond de Callafon*
- 26 The Root Locus Method *Hitay Özbay*
- 27 Frequency Response Methods *Jyh-Jong Sheen*
- 28 Kalman Filters as Dynamic System State Observers
Timothy P. Crain II
- 29 Digital Signal Processing for Mechatronic Applications *Bonnie S. Heck and Thomas R. Kurfess*
- 30 Control System Design Via \mathcal{H}^2 Optimization
Armando A. Rodriguez
- 31 Adaptive and Nonlinear Control Design *Maruthi R. Akella*
- 32 Neural Networks and Fuzzy Systems *Bogdan M. Wilamowski*

- 33 **Advanced Control of an Electrohydraulic Axis** *Florin Ionescu, Crina Vlad and Dragos Arotaritei*
- 34 **Design Optimization of Mechatronic Systems** *Tomas Brezina, Ctirad Kratochvil, and Cestmir Ondrusek*

SECTION V Computers and Logic Systems

- 35 **Introduction to Computers and Logic Systems** *Kevin Craig and Fred Stolfi*
- 36 **Digital Logic Concepts and Combinational Logic Design**
George I. Cohn
- 37 **System Interfaces** *M.J. Tordon and J. Katupitiya*
- 38 **Communications and Computer Networks** *Mohammad Ilyas*
- 39 **Fault Analysis in Mechatronic Systems** *Leila Notash and Thomas N. Moore*
- 40 **Logic System Design** *M. K. Ramasubramanian*
- 41 **Synchronous and Asynchronous Sequential Systems**
Sami A. Al-Arian
- 42 **Architecture** *Daniel A. Connors and Wen-mei W. Hwu*
- 43 **Control with Embedded Computers and Programmable Logic Controllers** *Hugh Jack and Andrew Sterian*

SECTION VI Software and Data Acquisition

- 44 **Introduction to Data Acquisition** *Jace Curtis*
- 45 **Measurement Techniques: Sensors and Transducers**
Cecil Harrison

- 46 A/D and D/A Conversion *Mike Tyler*
- 47 Signal Conditioning *Stephen A. Dyer*
- 48 Computer-Based Instrumentation Systems *Kris Fuller*
- 49 Software Design and Development *Margaret H. Hamilton*
- 50 Data Recording and Logging *Tom Magruder*



Overview of Mechatronics

- 1 What is Mechatronics?** *Robert H. Bishop and M. K. Ramasubramanian*
Basic Definitions • Key Elements of Mechatronics • Historical Perspective •
The Development of the Automobile as a Mechatronic System • What is
Mechatronics? And What's Next?
- 2 Mechatronic Design Approach** *Rolf Isermann*
Historical Development and Definition of Mechatronic Systems • Functions of
Mechatronic Systems • Ways of Integration • Information Processing Systems
(Basic Architecture and HW/SW Trade-offs) • Concurrent Design
Procedure for Mechatronic Systems
- 3 System Interfacing, Instrumentation, and Control Systems** *Rick Homkes*
Introduction • Input Signals of a Mechatronic System • Output Signals of a
Mechatronic System • Signal Conditioning • Microprocessor Control •
Microprocessor Numerical Control • Microprocessor Input–Output Control •
Software Control • Testing and Instrumentation • Summary
- 4 Microprocessor-Based Controllers and Microelectronics** *Ondrej Novak
and Ivan Dolezal*
Introduction to Microelectronics • Digital Logic • Overview of Control Computers •
Microprocessors and Microcontrollers • Programmable Logic Controllers • Digital
Communications
- 5 An Introduction to Micro- and Nanotechnology** *Michael Goldfarb,
Alvin Strauss, and Eric J. Barth*
Introduction • Microactuators • Microsensors • Nanomachines
- 6 Mechatronics: New Directions in Nano-, Micro-, and Mini-Scale
Electromechanical Systems Design, and Engineering Curriculum
Development** *Sergey Edward Lyshevski*
Introduction • Nano-, Micro-, and Mini-Scale Electromechanical Systems and
Mechatronic Curriculum • Mechatronics and Modern Engineering • Design
of Mechatronic Systems • Mechatronic System Components • Systems
Synthesis, Mechatronics Software, and Simulation • Mechatronic Curriculum •
Introductory Mechatronic Course • Books in Mechatronics • Mechatronic
Curriculum Developments • Conclusions: Mechatronics Perspectives

1

What is Mechatronics?

Robert H. Bishop

The University of Texas at Austin

M. K. Ramasubramanian

North Carolina State University

- 1.1 Basic Definitions
- 1.2 Key Elements of Mechatronics
- 1.3 Historical Perspective
- 1.4 The Development of the Automobile as a Mechatronic System
- 1.5 What is Mechatronics? And What's Next?

Mechatronics is a natural stage in the evolutionary process of modern engineering design. The development of the computer, and then the microcomputer, embedded computers, and associated information technologies and software advances, made mechatronics an imperative in the latter part of the twentieth century. Standing at the threshold of the twenty-first century, with expected advances in integrated bio-electro-mechanical systems, quantum computers, nano- and pico-systems, and other unforeseen developments, the future of mechatronics is full of potential and bright possibilities.

1.1 Basic Definitions

The definition of mechatronics has evolved since the original definition by the Yasakawa Electric Company. In trademark application documents, Yasakawa defined mechatronics in this way [1,2]:

The word, mechatronics, is composed of “mecha” from mechanism and the “tronics” from electronics. In other words, technologies and developed products will be incorporating electronics more and more into mechanisms, intimately and organically, and making it impossible to tell where one ends and the other begins.

The definition of mechatronics continued to evolve after Yasakawa suggested the original definition. One oft quoted definition of mechatronics was presented by Harashima, Tomizuka, and Fukada in 1996 [3]. In their words, mechatronics is defined as

the synergistic integration of mechanical engineering, with electronics and intelligent computer control in the design and manufacturing of industrial products and processes.

That same year, another definition was suggested by Auslander and Kempf [4]:

Mechatronics is the application of complex decision making to the operation of physical systems.

Yet another definition due to Shetty and Kolk appeared in 1997 [5]:

Mechatronics is a methodology used for the optimal design of electromechanical products.

More recently, we find the suggestion by W. Bolton [6]:

A mechatronic system is not just a marriage of electrical and mechanical systems and is more than just a control system; it is a complete integration of all of them.

All of these definitions and statements about mechatronics are accurate and informative, yet each one in and of itself fails to capture the totality of mechatronics. Despite continuing efforts to define mechatronics, to classify mechatronic products, and to develop a standard mechatronics curriculum, a consensus opinion on an all-encompassing description of “what is mechatronics” eludes us. This lack of consensus is a healthy sign. It says that the field is alive, that it is a youthful subject. Even without an unarguably definitive description of mechatronics, engineers understand from the definitions given above and from their own personal experiences the essence of the *philosophy* of mechatronics.

For many practicing engineers on the front line of engineering design, mechatronics is nothing new. Many engineering products of the last 25 years integrated mechanical, electrical, and computer systems, yet were designed by engineers that were never formally trained in mechatronics *per se*. It appears that modern concurrent engineering design practices, now formally viewed as part of the mechatronics specialty, are natural design processes. What is evident is that the study of mechatronics provides a mechanism for scholars interested in understanding and explaining the engineering design process to define, classify, organize, and integrate many aspects of product design into a coherent package. As the historical divisions between mechanical, electrical, aerospace, chemical, civil, and computer engineering become less clearly defined, we should take comfort in the existence of mechatronics as a field of study in academia. The mechatronics specialty provides an educational path, that is, a roadmap, for engineering students studying within the traditional structure of most engineering colleges. Mechatronics is generally recognized worldwide as a vibrant area of study. Undergraduate and graduate programs in mechatronic engineering are now offered in many universities. Refereed journals are being published and dedicated conferences are being organized and are generally highly attended.

It should be understood that mechatronics is not just a convenient structure for investigative studies by academicians; it is a way of life in modern engineering practice. The introduction of the microprocessor in the early 1980s and the ever increasing desired performance to cost ratio revolutionized the paradigm of engineering design. The number of new products being developed at the intersection of traditional disciplines of engineering, computer science, and the natural sciences is ever increasing. New developments in these traditional disciplines are being absorbed into mechatronics design at an ever increasing pace. The ongoing information technology revolution, advances in wireless communication, smart sensors design (enabled by MEMS technology), and embedded systems engineering ensures that the engineering design paradigm will continue to evolve in the early twenty-first century.

1.2 Key Elements of Mechatronics

The study of mechatronic systems can be divided into the following areas of specialty:

1. Physical Systems Modeling
2. Sensors and Actuators
3. Signals and Systems
4. Computers and Logic Systems
5. Software and Data Acquisition

The key elements of mechatronics are illustrated in [Fig. 1.1](#). As the field of mechatronics continues to mature, the list of relevant topics associated with the area will most certainly expand and evolve.

1.3 Historical Perspective

Attempts to construct automated mechanical systems has an interesting history. Actually, the term “automation” was not popularized until the 1940s when it was coined by the Ford Motor Company to denote a process in which a machine transferred a sub-assembly item from one station to another and then positioned the item precisely for additional assembly operations. But successful development of automated mechanical systems occurred long before then. For example, early applications of automatic control

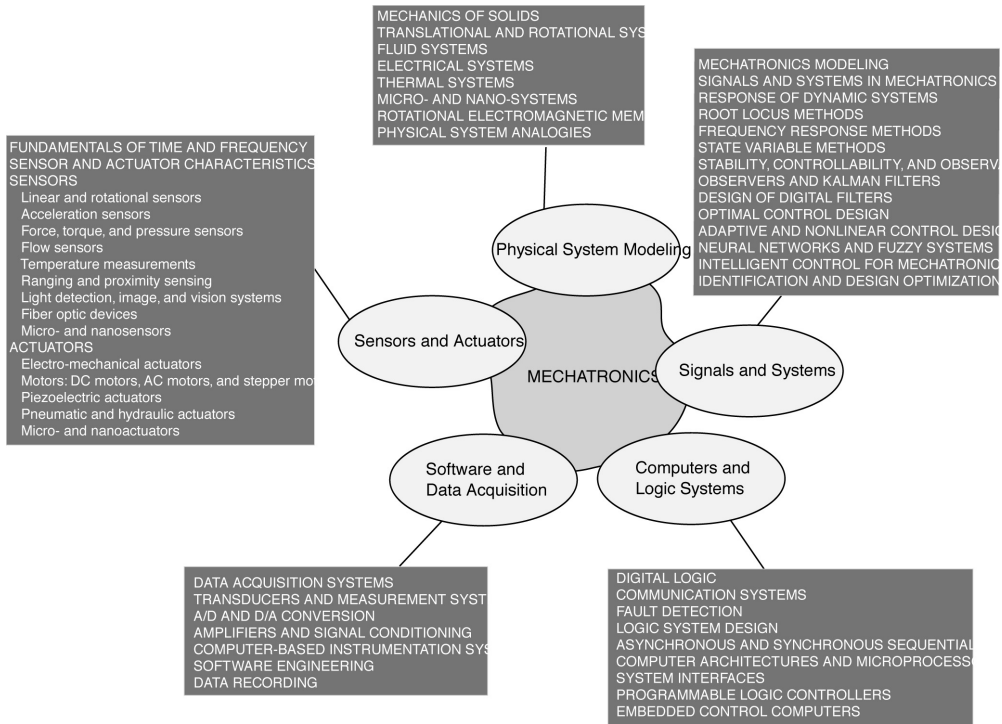

FIGURE 1.1 The key elements of mechatronics.

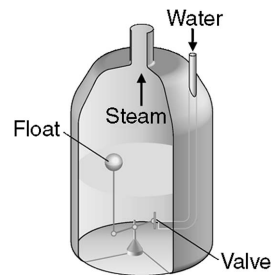

FIGURE 1.2 Water-level float regulator. (From *Modern Control Systems*, 9th ed., R. C. Dorf and R. H. Bishop, Prentice-Hall, 2001. Used with permission.)

systems appeared in Greece from 300 to 1 B.C. with the development of float regulator mechanisms [7]. Two important examples include the water clock of Ktesibios that used a float regulator, and an oil lamp devised by Philon, which also used a float regulator to maintain a constant level of fuel oil. Later, in the first century, Heron of Alexandria published a book entitled *Pneumatica* that described different types of water-level mechanisms using float regulators.

In Europe and Russia, between seventeenth and nineteenth centuries, many important devices were invented that would eventually contribute to mechatronics. Cornelis Drebbel (1572–1633) of Holland devised the temperature regulator representing one of the first feedback systems of that era. Subsequently, Dennis Papin (1647–1712) invented a pressure safety regulator for steam boilers in 1681. Papin’s pressure regulator is similar to a modern-day pressure-cooker valve. The first mechanical calculating machine was invented by Pascal in 1642 [8]. The first historical feedback system claimed by Russia was developed by Polzunov in 1765 [9]. Polzunov’s water-level float regulator, illustrated in Fig. 1.2, employs a float that rises and lowers in relation to the water level, thereby controlling the valve that covers the water inlet in the boiler.

Further evolution in automation was enabled by advancements in control theory traced back to the Watt flyball governor of 1769. The flyball governor, illustrated in Fig. 1.3, was used to control the speed

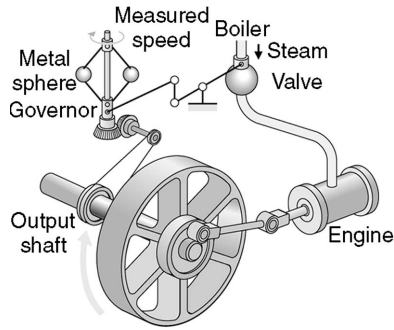

FIGURE 1.3 Watt’s flyball governor. (From *Modern Control Systems*, 9th ed., R. C. Dorf and R. H. Bishop, Prentice-Hall, 2001. Used with permission.)

of a steam engine [10]. Employing a measurement of the speed of the output shaft and utilizing the motion of the flyball to control the valve, the amount of steam entering the engine is controlled. As the speed of the engine increases, the metal spheres on the governor apparatus rise and extend away from the shaft axis, thereby closing the valve. This is an example of a feedback control system where the feedback signal and the control actuation are completely coupled in the mechanical hardware.

These early successful automation developments were achieved through intuition, application of practical skills, and persistence. The next step in the evolution of automation required a *theory* of automatic control. The precursor to the numerically controlled (NC) machines for automated manufacturing (to be developed in the 1950s and 60s at MIT) appeared in the early 1800s with the invention of feed-forward control of weaving looms by Joseph Jacquard of France. In the late 1800s, the subject now known as control theory was initiated by J. C. Maxwell through analysis of the set of differential equations describing the flyball governor [11]. Maxwell investigated the effect various system parameters had on the system performance. At about the same time, Vyshnegradskii formulated a mathematical theory of regulators [12]. In the 1830s, Michael Faraday described the law of induction that would form the basis of the electric motor and the electric dynamo. Subsequently, in the late 1880s, Nikola Tesla invented the alternating-current induction motor. The basic idea of controlling a mechanical system automatically was firmly established by the end of 1800s. The evolution of automation would accelerate significantly in the twentieth century.

The development of pneumatic control elements in the 1930s matured to a point of finding applications in the process industries. However, prior to 1940, the design of control systems remained an art generally characterized by trial-and-error methods. During the 1940s, continued advances in mathematical and analytical methods solidified the notion of control engineering as an independent engineering discipline. In the United States, the development of the telephone system and electronic feedback amplifiers spurred the use of feedback by Bode, Nyquist, and Black at Bell Telephone Laboratories [13–17]. The operation of the feedback amplifiers was described in the frequency domain and the ensuing design and analysis practices are now generally classified as “classical control.” During the same time period, control theory was also developing in Russia and eastern Europe. Mathematicians and applied mechanics in the former Soviet Union dominated the field of controls and concentrated on time domain formulations and differential equation models of systems. Further developments of time domain formulations using state variable system representations occurred in the 1960s and led to design and analysis practices now generally classified as “modern control.”

The World War II war effort led to further advances in the theory and practice of automatic control in an effort to design and construct automatic airplane pilots, gun-positioning systems, radar antenna control systems, and other military systems. The complexity and expected performance of these military systems necessitated an extension of the available control techniques and fostered interest in control systems and the development of new insights and methods. Frequency domain techniques continued to dominate the field of controls following World War II, with the increased use of the Laplace transform, and the use of the so-called *s*-plane methods, such as designing control systems using root locus.

On the commercial side, driven by cost savings achieved through mass production, automation of the production process was a high priority beginning in the 1940s. During the 1950s, the invention of the cam, linkages, and chain drives became the major enabling technologies for the invention of new products and high-speed precision manufacturing and assembly. Examples include textile and printing machines, paper converting machinery, and sewing machines. High-volume precision manufacturing became a reality during this period. The automated paperboard container-manufacturing machine employs a sheet-fed process wherein the paperboard is cut into a fan shape to form the tapered sidewall, and wrapped around a mandrel. The seam is then heat sealed and held until cured. Another sheet-fed source of paperboard is used to cut out the plate to form the bottom of the paperboard container, formed into a shallow dish through scoring and creasing operations in a die, and assembled to the cup shell. The lower edge of the cup shell is bent inwards over the edge of the bottom plate sidewall, and heat-sealed under high pressure to prevent leaks and provide a precisely level edge for standup. The brim is formed on the top to provide a ring-on-shell structure to provide the stiffness needed for its functionality. All of these operations are carried out while the work piece undergoes a precision transfer from one turret to another and is then ejected. The production rate of a typical machine averages over 200 cups per minute. The automated paperboard container manufacturing did not involve any non-mechanical system except an electric motor for driving the line shaft. These machines are typical of paper converting and textile machinery and represent automated systems significantly more complex than their predecessors.

The development of the microprocessor in the late 1960s led to early forms of computer control in process and product design. Examples include numerically controlled (NC) machines and aircraft control systems. Yet the manufacturing processes were still entirely mechanical in nature and the automation and control systems were implemented only as an afterthought. The launch of Sputnik and the advent of the space age provided yet another impetus to the continued development of controlled mechanical systems. Missiles and space probes necessitated the development of complex, highly accurate control systems. Furthermore, the need to minimize satellite mass (that is, to minimize the amount of fuel required for the mission) while providing accurate control encouraged advancements in the important field of optimal control. Time domain methods developed by Liapunov, Minorsky, and others, as well as the theories of optimal control developed by L. S. Pontryagin in the former Soviet Union and R. Bellman in the United States, were well matched with the increasing availability of high-speed computers and new programming languages for scientific use.

Advancements in semiconductor and integrated circuits manufacturing led to the development of a new class of products that incorporated mechanical and electronics in the system and required the two together for their functionality. The term mechatronics was introduced by Yasakawa Electric in 1969 to represent such systems. Yasakawa was granted a trademark in 1972, but after widespread usage of the term, released its trademark rights in 1982 [1–3]. Initially, mechatronics referred to systems with only mechanical systems and electrical components—no computation was involved. Examples of such systems include the automatic sliding door, vending machines, and garage door openers.

In the late 1970s, the Japan Society for the Promotion of Machine Industry (JSPMI) classified mechatronics products into four categories [1]:

1. *Class I:* Primarily mechanical products with electronics incorporated to enhance functionality. Examples include numerically controlled machine tools and variable speed drives in manufacturing machines.
2. *Class II:* Traditional mechanical systems with significantly updated internal devices incorporating electronics. The external user interfaces are unaltered. Examples include the modern sewing machine and automated manufacturing systems.
3. *Class III:* Systems that retain the functionality of the traditional mechanical system, but the internal mechanisms are replaced by electronics. An example is the digital watch.
4. *Class IV:* Products designed with mechanical and electronic technologies through synergistic integration. Examples include photocopiers, intelligent washers and dryers, rice cookers, and automatic ovens.

The enabling technologies for each mechatronic product class illustrate the progression of electromechanical products in stride with developments in control theory, computation technologies, and microprocessors. Class I products were enabled by servo technology, power electronics, and control theory. Class II products were enabled by the availability of early computational and memory devices and custom circuit design capabilities. Class III products relied heavily on the microprocessor and integrated circuits to replace mechanical systems. Finally, Class IV products marked the beginning of true mechatronic systems, through integration of mechanical systems and electronics. It was not until the 1970s with the development of the microprocessor by the Intel Corporation that integration of computational systems with mechanical systems became practical.

The divide between classical control and modern control was significantly reduced in the 1980s with the advent of “robust control” theory. It is now generally accepted that control engineering must consider both the time domain and the frequency domain approaches simultaneously in the analysis and design of control systems. Also, during the 1980s, the utilization of digital computers as integral components of control systems became routine. There are literally hundreds of thousands of digital process control computers installed worldwide [18,19]. Whatever definition of mechatronics one chooses to adopt, it is evident that modern mechatronics involves computation as the central element. In fact, the incorporation of the microprocessor to precisely modulate mechanical power and to adapt to changes in environment are the essence of modern mechatronics and smart products.

1.4 The Development of the Automobile as a Mechatronic System

The evolution of modern mechatronics can be illustrated with the example of the automobile. Until the 1960s, the radio was the only significant electronics in an automobile. All other functions were entirely mechanical or electrical, such as the starter motor and the battery charging systems. There were no “intelligent safety systems,” except augmenting the bumper and structural members to protect occupants in case of accidents. Seat belts, introduced in the early 1960s, were aimed at improving occupant safety and were completely mechanically actuated. All engine systems were controlled by the driver and/or other mechanical control systems. For instance, before the introduction of sensors and microcontrollers, a mechanical distributor was used to select the specific spark plug to fire when the fuel–air mixture was compressed. The timing of the ignition was the control variable. The mechanically controlled combustion process was not optimal in terms of fuel efficiency. Modeling of the combustion process showed that, for increased fuel efficiency, there existed an optimal time when the fuel should be ignited. The timing depends on load, speed, and other measurable quantities. The electronic ignition system was one of the first mechatronic systems to be introduced in the automobile in the late 1970s. The electronic ignition system consists of a crankshaft position sensor, camshaft position sensor, airflow rate, throttle position, rate of throttle position change sensors, and a dedicated microcontroller determining the timing of the spark plug firings. Early implementations involved only a Hall effect sensor to sense the position of the rotor in the distributor accurately. Subsequent implementations eliminated the distributor completely and directly controlled the firings utilizing a microprocessor.

The Antilock Brake System (ABS) was also introduced in the late 1970s in automobiles [20]. The ABS works by sensing lockup of any of the wheels and then modulating the hydraulic pressure as needed to minimize or eliminate sliding. The Traction Control System (TCS) was introduced in automobiles in the mid-1990s. The TCS works by sensing slippage during acceleration and then modulating the power to the slipping wheel. This process ensures that the vehicle is accelerating at the maximum possible rate under given road and vehicle conditions. The Vehicle Dynamics Control (VDC) system was introduced in automobiles in the late 1990s. The VDC works similar to the TCS with the addition of a yaw rate sensor and a lateral accelerometer. The driver intention is determined by the steering wheel position and then compared with the actual direction of motion. The TCS system is then activated to control the

power to the wheels and to control the vehicle velocity and minimize the difference between the steering wheel direction and the direction of the vehicle motion [20,21]. In some cases, the ABS is used to slow down the vehicle to achieve desired control. In automobiles today, typically, 8, 16, or 32-bit CPUs are used for implementation of the various control systems. The microcontroller has onboard memory (EEPROM/EPROM), digital and analog inputs, A/D converters, pulse width modulation (PWM), timer functions, such as event counting and pulse width measurement, prioritized inputs, and in some cases digital signal processing. The 32-bit processor is used for engine management, transmission control, and airbags; the 16-bit processor is used for the ABS, TCS, VDC, instrument cluster, and air conditioning systems; the 8-bit processor is used for seat, mirror control, and window lift systems. Today, there are about 30–60 microcontrollers in a car. This is expected to increase with the drive towards developing modular systems for plug-n-ply mechatronics subsystems.

Mechatronics has become a necessity for product differentiation in automobiles. Since the basics of internal combustion engine were worked out almost a century ago, differences in the engine design among the various automobiles are no longer useful as a product differentiator. In the 1970s, the Japanese automakers succeeded in establishing a foothold in the U.S. automobile market by offering unsurpassed quality and fuel-efficient small automobiles. The quality of the vehicle was the product differentiator through the 1980s. In the 1990s, consumers came to expect quality and reliability in automobiles from all manufacturers. Today, *mechatronic features* have become the product differentiator in these traditionally mechanical systems. This is further accelerated by higher performance price ratio in electronics, market demand for innovative products with smart features, and the drive to reduce cost of manufacturing of existing products through redesign incorporating mechatronics elements. With the prospects of low single digit (2–3%) growth, automotive makers will be searching for high-tech features that will differentiate their vehicles from others [22]. The automotive electronics market in North America, now at about \$20 billion, is expected to reach \$28 billion by 2004 [22]. New applications of mechatronic systems in the automotive world include semi-autonomous to fully autonomous automobiles, safety enhancements, emission reduction, and other features including intelligent cruise control, and brake by wire systems eliminating the hydraulics [23]. Another significant growth area that would benefit from a mechatronics design approach is wireless networking of automobiles to ground stations and vehicle-to-vehicle communication. Telematics, which combines audio, hands-free cell phone, navigation, Internet connectivity, e-mail, and voice recognition, is perhaps the largest potential automotive growth area. In fact, the use of electronics in automobiles is expected to increase at an annual rate of 6% per year over the next five years, and the electronics functionality will double over the next five years [24].

Micro Electromechanical Systems (MEMS) is an enabling technology for the cost-effective development of sensors and actuators for mechatronics applications. Already, several MEMS devices are in use in automobiles, including sensors and actuators for airbag deployment and pressure sensors for manifold pressure measurement. Integrating MEMS devices with CMOS signal conditioning circuits on the same silicon chip is another example of development of enabling technologies that will improve mechatronic products, such as the automobile.

Millimeter wave radar technology has recently found applications in automobiles. The millimeter wave radar detects the location of objects (other vehicles) in the scenery and the distance to the obstacle and the velocity in real-time. A detailed description of a working system is given by Suzuki et al. [25]. [Figure 1.4](#) shows an illustration of the vehicle-sensing capability with a millimeter-waver radar. This technology provides the capability to control the distance between the vehicle and an obstacle (or another vehicle) by integrating the sensor with the cruise control and ABS systems. The driver is able to set the speed and the desired distance between the cars ahead of him. The ABS system and the cruise control system are coupled together to safely achieve this remarkable capability. One logical extension of the obstacle avoidance capability is slow speed semi-autonomous driving where the vehicle maintains a constant distance from the vehicle ahead in traffic jam conditions. Fully autonomous vehicles are well within the scope of mechatronics development within the next 20 years. Supporting investigations are underway in many research centers on development of semi-autonomous cars with reactive path planning using GPS-based continuous traffic model updates and stop-and-go automation. A proposed sensing and control

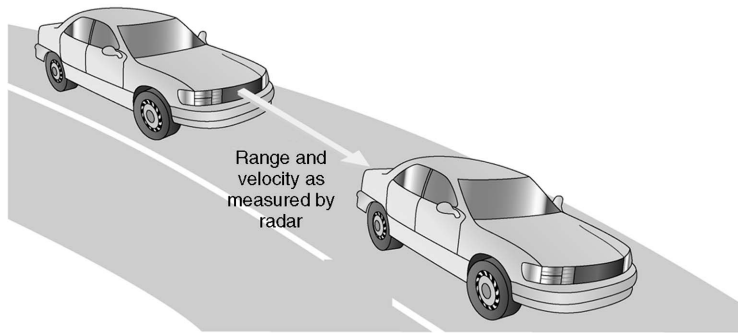
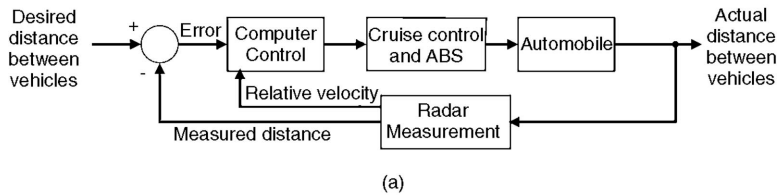

FIGURE 1.4 Using a radar to measure distance and velocity to autonomously maintain desired distance between vehicles. (Adapted from *Modern Control Systems*, 9th ed., R. C. Dorf and R. H. Bishop, Prentice-Hall, 2001. Used with permission.)

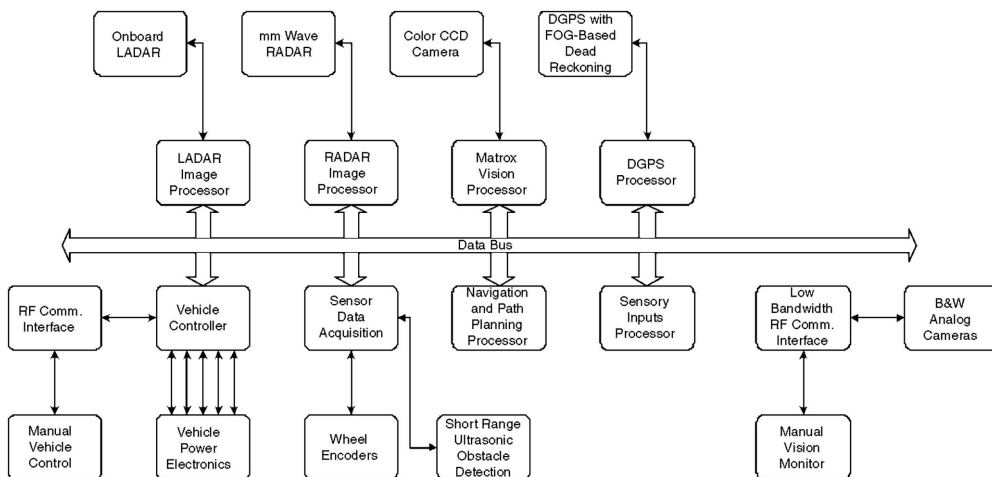

FIGURE 1.5 Autonomous vehicle system design with sensors and actuators.

system for such a vehicle, shown in Fig. 1.5, involves differential global positioning systems (DGPS), real-time image processing, and dynamic path planning [26].

Future mechatronic systems on automobiles may include a fog-free windshield based on humidity and temperature sensing and climate control, self-parallel parking, rear parking aid, lane change assistance, fluidless electronic brake-by-wire, and replacement of hydraulic systems with electromechanical servo systems. As the number of automobiles in the world increases, stricter emission standards are inevitable. Mechatronic products will in all likelihood contribute to meet the challenges in emission control and engine efficiency by providing substantial reduction in CO, NO, and HC emissions and increase in vehicle

efficiency [23]. Clearly, an automobile with 30–60 microcontrollers, up to 100 electric motors, about 200 pounds of wiring, a multitude of sensors, and thousands of lines of software code can hardly be classified as a strictly mechanical system. The automobile is being transformed into a comprehensive mechatronic system.

1.5 What is Mechatronics? And What's Next?

Mechatronics, the term coined in Japan in the 1970s, has evolved over the past 25 years and has led to a special breed of intelligent products. What is mechatronics? It is a natural stage in the evolutionary process of modern engineering design. For some engineers, mechatronics is nothing new, and, for others, it is a philosophical approach to design that serves as a guide for their activities. Certainly, mechatronics is an evolutionary process, not a revolutionary one. It is clear that an all-encompassing definition of mechatronics does not exist, but in reality, one is not needed. It is understood that mechatronics is about the synergistic integration of mechanical, electrical, and computer systems. One can understand the extent that mechatronics reaches into various disciplines by characterizing the constituent components comprising mechatronics, which include (i) physical systems modeling, (ii) sensors and actuators, (iii) signals and systems, (iv) computers and logic systems, and (v) software and data acquisition. Engineers and scientists from all walks of life and fields of study can contribute to mechatronics. As engineering and science boundaries become less well defined, more students will seek a multi-disciplinary education with a strong design component. Academia should be moving towards a curriculum, which includes coverage of mechatronic systems.

In the future, growth in mechatronic systems will be fueled by the growth in the constituent areas. Advancements in traditional disciplines fuel the growth of mechatronics systems by providing “enabling technologies.” For example, the invention of the microprocessor had a profound effect on the redesign of mechanical systems and design of new mechatronics systems. We should expect continued advancements in cost-effective microprocessors and microcontrollers, sensor and actuator development enabled by advancements in applications of MEMS, adaptive control methodologies and real-time programming methods, networking and wireless technologies, mature CAE technologies for advanced system modeling, virtual prototyping, and testing. The continued rapid development in these areas will only accelerate the pace of smart product development. The Internet is a technology that, when utilized in combination with wireless technology, may also lead to new mechatronic products. While developments in automotives provide vivid examples of mechatronics development, there are numerous examples of intelligent systems in all walks of life, including smart home appliances such as dishwashers, vacuum cleaners, microwaves, and wireless network enabled devices. In the area of “human-friendly machines” (a term used by H. Kobayashi [27]), we can expect advances in robot-assisted surgery, and implantable sensors and actuators. Other areas that will benefit from mechatronic advances may include robotics, manufacturing, space technology, and transportation. The future of mechatronics is wide open.

References

1. Kyura, N. and Oho, H., “Mechatronics—an industrial perspective,” *IEEE/ASME Transactions on Mechatronics*, Vol. 1, No. 1, 1996, pp. 10–15.
2. Mori, T., “Mechatronics,” Yasakawa Internal Trademark Application Memo 21.131.01, July 12, 1969.
3. Harshama, F., Tomizuka, M., and Fukuda, T., “Mechatronics—What is it, why, and how?—an editorial,” *IEEE/ASME Transactions on Mechatronics*, Vol. 1, No. 1, 1996, pp. 1–4.
4. Auslander, D. M. and Kempf, C. J., *Mechatronics: Mechanical System Interfacing*, Prentice-Hall, Upper Saddle River, NJ, 1996.
5. Shetty, D. and Kolk, R. A., *Mechatronic System Design*, PWS Publishing Company, Boston, MA, 1997.
6. Bolton, W., *Mechatronics: Electrical Control Systems in Mechanical and Electrical Engineering, 2nd Ed.*, Addison-Wesley Longman, Harlow, England, 1999.
7. Mayr, I. O., *The Origins of Feedback Control*, MIT Press, Cambridge, MA, 1970.

8. Tomkinson, D. and Horne, J., *Mechatronics Engineering*, McGraw-Hill, New York, 1996.
9. Popov, E. P., *The Dynamics of Automatic Control Systems*; Gostekhizdat, Moscow, 1956; Addison-Wesley, Reading, MA, 1962.
10. Dorf, R. C. and Bishop, R. H., *Modern Control Systems, 9th Ed.*, Prentice-Hall, Upper Saddle River, NJ, 2000.
11. Maxwell, J. C., "On governors," *Proc. Royal Soc. London*, 16, 1868; in *Selected Papers on Mathematical Trends in Control Theory*, Dover, New York, 1964, pp. 270–283.
12. Vyshnegradskii, I. A., "On controllers of direct action," *Izv. SPB Tekhnolog. Inst.*, 1877.
13. Bode, H. W., "Feedback—the history of an idea," in *Selected Papers on Mathematical Trends in Control Theory*, Dover, New York, 1964, pp. 106–123.
14. Black, H. S., "Inventing the Negative Feedback Amplifier," *IEEE Spectrum*, December 1977, pp. 55–60.
15. Brittain, J. E., *Turning Points in American Electrical History*, IEEE Press, New York, 1977.
16. Fagen, M. D., *A History of Engineering and Science on the Bell Systems*, Bell Telephone Laboratories, 1978.
17. Newton, G., Gould, L., and Kaiser, J., *Analytical Design of Linear Feedback Control*, John Wiley & Sons, New York, 1957.
18. Dorf, R. C. and Kusiak, A., *Handbook of Automation and Manufacturing*, John Wiley & Sons, New York, 1994.
19. Dorf, R. C., *The Encyclopedia of Robotics*, John Wiley & Sons, New York, 1988.
20. Asami, K., Nomura, Y., and Naganawa, T., "Traction Control (TRC) System for 1987 Toyota Crown, 1989," *ABS-TCS-VDC Where Will the Technology Lead Us?* J. Mack, ed., Society of Automotive Engineers, Warrendale PA, 1996.
21. Pastor, S. et al., "Brake Control System," United States Patent # 5,720,533, Feb. 24, 1998 (see <http://www.uspto.gov/> for more information).
22. Jorgensen, B., "Shifting gears," *Auto Electronics, Electronic Business*, Feb. 2001.
23. Barron, M. B. and Powers, W. F., "The role of electronic controls for future automotive mechatronic systems," *IEEE/ASME Transactions on Mechatronics*, Vol. 1, No. 1, 1996, pp. 80–88.
24. Kobe, G., "Electronics: What's driving the growth?" *Automotive Industries*, August 2000.
25. Suzuki, H., Hiroshi, M. Shono, and Isaji, O., "Radar Apparatus for Detecting a Distance/Velocity," United States Patent # 5,677,695, Oct 14, 1997 (see <http://www.uspto.gov/> for more information).
26. Ramasubramanian, M. K., "Mechatronics—the future of mechanical engineering—past, present, and a vision for the future," (Invited paper), *Proc. SPIE*, Vol. 4334-34, March 2001.
27. Kobayashi, H. (Guest Editorial), *IEEE/ASME Transactions on Mechatronics*, Vol. 2, No. 4, 1997, p. 217.

2

Mechatronic Design Approach

- 2.1 Historical Development and Definition of Mechatronic Systems
- 2.2 Functions of Mechatronic Systems
Division of Functions Between Mechanics and Electronics • Improvement of Operating Properties • Addition of New Functions
- 2.3 Ways of Integration
Integration of Components (Hardware) • Integration of Information Processing (Software)
- 2.4 Information Processing Systems (Basic Architecture and HW/SW Trade-offs)
Multilevel Control Architecture • Special Signal Processing • Model-based and Adaptive Control Systems • Supervision and Fault Detection • Intelligent Systems (Basic Tasks)
- 2.5 Concurrent Design Procedure for Mechatronic Systems
Design Steps • Required CAD/CAE Tools • Modeling Procedure • Real-Time Simulation • Hardware-in-the-Loop Simulation • Control Prototyping

Rolf Isermann

Darmstadt University of Technology

2.1 Historical Development and Definition of Mechatronic Systems

In several technical areas the integration of products or processes and electronics can be observed. This is especially true for mechanical systems which developed since about 1980. These systems changed from electro-mechanical systems with discrete electrical and mechanical parts to integrated electronic-mechanical systems with sensors, actuators, and digital microelectronics. These integrated systems, as seen in [Table 2.1](#), are called *mechatronic systems*, with the connection of MECHANics and elecTRONICS.

The word “mechatronics” was probably first created by a Japanese engineer in 1969 [1], with earlier definitions given by [2] and [3]. In [4], a preliminary definition is given: “Mechatronics is the synergetic integration of mechanical engineering with electronics and intelligent computer control in the design and manufacturing of industrial products and processes” [5].

All these definitions agree that mechatronics is an *interdisciplinary field*, in which the following disciplines act together (see [Fig. 2.1](#)):

- *mechanical systems* (mechanical elements, machines, precision mechanics);
- *electronic systems* (microelectronics, power electronics, sensor and actuator technology); and
- *information technology* (systems theory, automation, software engineering, artificial intelligence).

TABLE 2.1 Historical Development of Mechanical, Electrical, and Electronic Systems

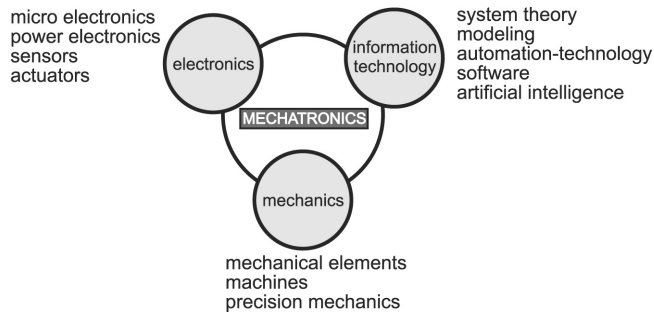
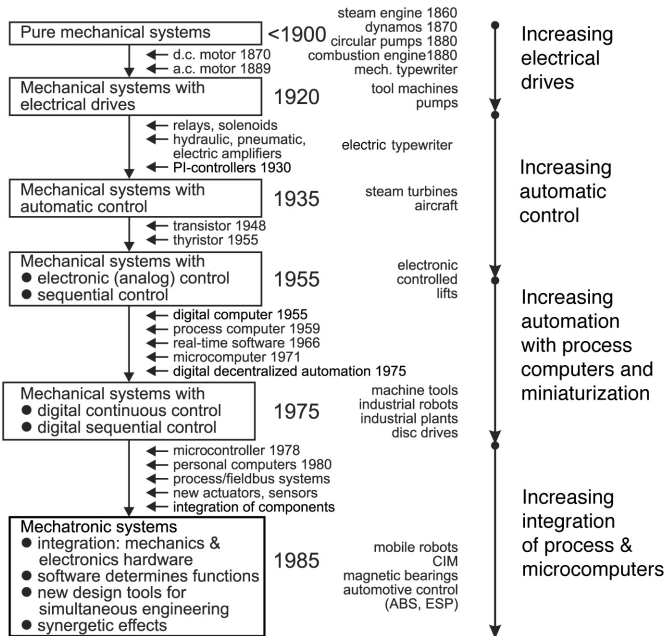

FIGURE 2.1 Mechatronics: synergetic integration of different disciplines.

Some survey contributions describe the development of mechatronics; see [5–8]. An insight into general aspects are given in the journals [4,9,10]; first conference proceedings in [11–15]; and the books [16–19].

Figure 2.2 shows a general scheme of a modern mechanical process like a power producing or a power generating machine. A primary *energy flows* into the machine and is then either directly used for the energy consumer in the case of an energy transformer, or converted into another energy form in the case of an energy converter. The form of energy can be electrical, mechanical (potential or kinetic, hydraulic, pneumatic), chemical, or thermal. Machines are mostly characterized by a continuous or periodic (repetitive) energy flow. For other mechanical processes, such as mechanical elements or precision mechanical devices, piecewise or intermittent energy flows are typical.

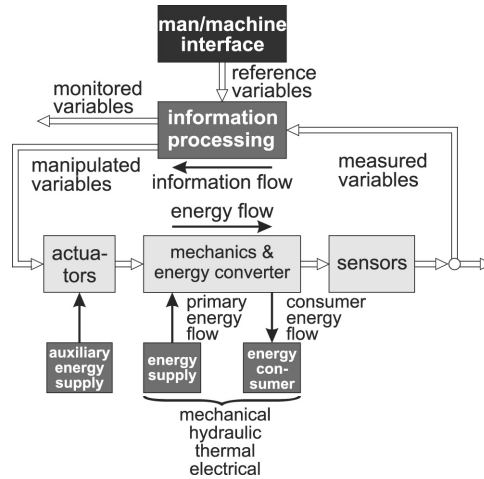

FIGURE 2.2 Mechanical process and information processing develop towards mechatronic systems.

The energy flow is generally a product of a generalized flow and a potential (effort). Information on the state of the mechanical process can be obtained by measured generalized flows (speed, volume, or mass flow) or electrical current or potentials (force, pressure, temperature, or voltage). Together with reference variables, the measured variables are the inputs for an *information flow* through the digital electronics resulting in manipulated variables for the actuators or in monitored variables on a display.

The addition and integration of feedback information flow to a feedforward energy flow in a basically mechanical system is one characteristic of many mechatronic systems. This development presently influences the design of mechanical systems. Mechatronic systems can be subdivided into:

- mechatronic systems
- mechatronic machines
- mechatronic vehicles
- precision mechatronics
- micro mechatronics

This shows that the integration with electronics comprises many classes of technical systems. In several cases, the mechanical part of the process is coupled with an electrical, thermal, thermodynamic, chemical, or information processing part. This holds especially true for energy converters as machines where, in addition to the mechanical energy, other kinds of energy appear. Therefore, *mechatronic systems in a wider sense* comprise mechanical and also non-mechanical processes. However, the mechanical part normally dominates the system.

Because an auxiliary energy is required to change the fixed properties of formerly passive mechanical systems by feedforward or feedback control, these systems are sometimes also called *active mechanical systems*.

2.2 Functions of Mechatronic Systems

Mechatronic systems permit many improved and new functions. This will be discussed by considering some examples.

Division of Functions between Mechanics and Electronics

For designing mechatronic systems, the interplay for the realization of functions in the mechanical and electronic part is crucial. Compared to pure mechanical realizations, the use of amplifiers and actuators with electrical auxiliary energy led to considerable simplifications in devices, as can be seen from watches,

electrical typewriters, and cameras. A further considerable *simplification in the mechanics* resulted from introducing microcomputers in connection with decentralized electrical drives, as can be seen from electronic typewriters, sewing machines, multi-axis handling systems, and automatic gears.

The design of lightweight constructions leads to elastic systems which are weakly damped through the material. An *electronic damping* through position, speed, or vibration sensors and electronic feedback can be realized with the additional advantage of an adjustable damping through the algorithms. Examples are elastic drive chains of vehicles with damping algorithms in the engine electronics, elastic robots, hydraulic systems, far reaching cranes, and space constructions (with, for example, flywheels).

The addition of closed loop control for position, speed, or force not only results in a precise tracking of reference variables, but also an approximate linear behavior, even though the mechanical systems show nonlinear behavior. By *omitting the constraint of linearization* on the mechanical side, the effort for construction and manufacturing may be reduced. Examples are simple mechanical pneumatic and electro-mechanical actuators and flow valves with electronic control.

With the aid of freely *programmable reference variable generation* the adaptation of nonlinear mechanical systems to the operator can be improved. This is already used for the driving pedal characteristics within the engine electronics for automobiles, telemanipulation of vehicles and aircraft, in development of hydraulic actuated excavators, and electric power steering.

With an increasing number of sensors, actuators, switches, and control units, the cable and electrical connections increase such that reliability, cost, weight, and the required space are major concerns. Therefore, the development of suitable bus systems, plug systems, and redundant and reconfigurable electronic systems are challenges for the designer.

Improvement of Operating Properties

By applying active feedback control, precision is obtained not only through the high mechanical precision of a passively feedforward controlled mechanical element, but by comparison of a programmed reference variable and a measured control variable. Therefore, the mechanical precision in design and manufacturing may be reduced somewhat and more simple constructions for bearings or slideways can be used. An important aspect is the compensation of a larger and time variant friction by *adaptive friction compensation* [13,20]. Also, a larger friction on cost of backlash may be intended (such as gears with pretension), because it is usually easier to compensate for friction than for backlash.

Model-based and *adaptive control* allow for a wide range of operation, compared to fixed control with unsatisfactory performance (danger of instability or sluggish behavior). A combination of robust and adaptive control allows a wide range of operation for flow-, force-, or speed-control, and for processes like engines, vehicles, or aircraft. A better control performance allows the reference variables to move closer to the constraints with an improvement in efficiencies and yields (e.g., higher temperatures, pressures for combustion engines and turbines, compressors at stalling limits, higher tensions and higher speed for paper machines and steel mills).

Addition of New Functions

Mechatronic systems allow functions to occur that could not be performed without digital electronics. First, *nonmeasurable quantities* can be calculated on the basis of measured signals and influenced by feedforward or feedback control. Examples are time-dependent variables such as slip for tyres, internal tensions, temperatures, slip angle and ground speed for steering control of vehicles, or parameters like damping, stiffness coefficients, and resistances. The *adaptation of parameters* such as damping and stiffness for oscillating systems (based on measurements of displacements or accelerations) is another example. Integrated *supervision and fault diagnosis* becomes more and more important with increasing automatic functions, increasing complexity, and higher demands on reliability and safety. Then, the triggering of redundant components, system reconfiguration, maintenance-on-request, and any kind of *teleservice* make the system more “intelligent.” [Table 2.2](#) summarizes some properties of mechatronic systems compared to conventional electro-mechanical systems.

TABLE 2.2 Properties of Conventional and Mechatronic Design Systems

| Conventional Design | Mechatronic Design |
|--|--|
| Added components | Integration of components (hardware) |
| 1 Bulky | Compact |
| 2 Complex mechanisms | Simple mechanisms |
| 3 Cable problems | Bus or wireless communication |
| 4 Connected components | Autonomous units |
| Simple control | Integration by information processing (software) |
| 5 Stiff construction | Elastic construction with damping by electronic feedback |
| 6 Feedforward control, linear (analog) control | Programmable feedback (nonlinear) digital control |
| 7 Precision through narrow tolerances | Precision through measurement and feedback control |
| 8 Nonmeasurable quantities change arbitrarily | Control of nonmeasurable estimated quantities |
| 9 Simple monitoring | Supervision with fault diagnosis |
| 10 Fixed abilities | Learning abilities |

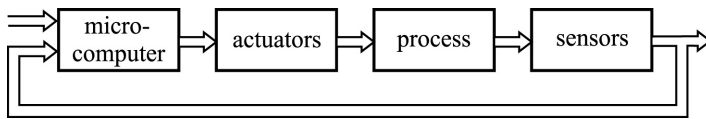

FIGURE 2.3 General scheme of a (classical) mechanical-electronic system.

2.3 Ways of Integration

Figure 2.3 shows a general scheme of a classical mechanical-electronic system. Such systems resulted from adding available sensors, actuators, and analog or digital controllers to mechanical components. The limits of this approach were given by the lack of suitable sensors and actuators, the unsatisfactory life time under rough operating conditions (acceleration, temperature, contamination), the large space requirements, the required cables, and relatively slow data processing. With increasing improvements in miniaturization, robustness, and computing power of microelectronic components, one can now put more emphasis on electronics in the design of a mechatronic system. More autonomous systems can be envisioned, such as capsuled units with touchless signal transfer or bus connections, and robust microelectronics.

The integration within a mechatronic system can be performed through the integration of components and through the integration of information processing.

Integration of Components (Hardware)

The integration of components (hardware integration) results from designing the mechatronic system as an overall system and imbedding the sensors, actuators, and microcomputers into the mechanical process, as seen in Fig. 2.4. This spatial integration may be limited to the process and sensor, or to the process and actuator. Microcomputers can be integrated with the actuator, the process or sensor, or can be arranged at several places.

Integrated sensors and microcomputers lead to *smart sensors*, and integrated actuators and microcomputers lead to *smart actuators*. For larger systems, bus connections will replace cables. Hence, there are several possibilities to build up an integrated overall system by proper integration of the hardware.

Integration of Information Processing (Software)

The integration of information processing (software integration) is mostly based on advanced control functions. Besides a basic feedforward and feedback control, an additional influence may take place through the process knowledge and corresponding online information processing, as seen in Fig. 2.4. This means a processing of available signals at higher levels, including the solution of tasks like supervision

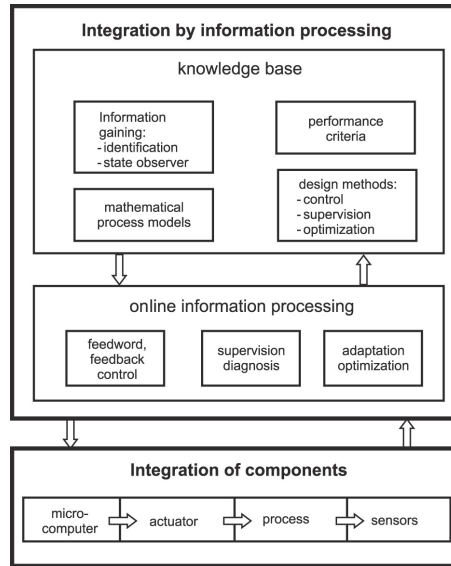

FIGURE 2.4 Ways of integration within mechatronic systems.

with fault diagnosis, optimization, and general process management. The respective problem solutions result in real-time algorithms which must be adapted to the mechanical process properties, expressed by mathematical models in the form of static characteristics, or differential equations. Therefore, a *knowledge base* is required, comprising methods for design and information gaining, process models, and performance criteria. In this way, the mechanical parts are governed in various ways through higher level information processing with intelligent properties, possibly including learning, thus forming an integration by process-adapted software.

2.4 Information Processing Systems (Basic Architecture and HW/SW Trade-offs)

The governing of mechanical systems is usually performed through actuators for the changing of positions, speeds, flows, forces, torques, and voltages. The directly measurable output quantities are frequently positions, speeds, accelerations, forces, and currents.

Multilevel Control Architecture

The information processing of *direct measurable input and output signals* can be organized in several levels, as compared in Fig. 2.5.

- level 1: low level control (feedforward, feedback for damping, stabilization, linearization)
- level 2: high level control (advanced feedback control strategies)
- level 3: supervision, including fault diagnosis
- level 4: optimization, coordination (of processes)
- level 5: general process management

Recent approaches to mechatronic systems use signal processing in the lower levels, such as damping, control of motions, or simple supervision. Digital information processing, however, allows for the solution of many tasks, like adaptive control, learning control, supervision with fault diagnosis, decisions

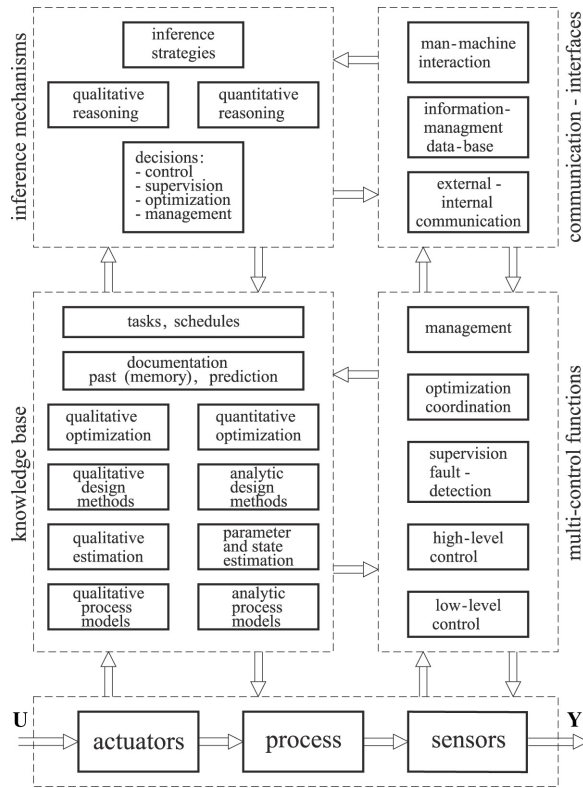

FIGURE 2.5 Advanced intelligent automatic system with multi-control levels, knowledge base, inference mechanisms, and interfaces.

for maintenance or even redundancy actions, economic optimization, and coordination. The tasks of the higher levels are sometimes summarized as “process management.”

Special Signal Processing

The described methods are partially applicable for *nonmeasurable quantities* that are reconstructed from mathematical process models. In this way, it is possible to control damping ratios, material and heat stress, and slip, or to supervise quantities like resistances, capacitances, temperatures within components, or parameters of wear and contamination. This signal processing may require *special filters* to determine amplitudes or frequencies of vibrations, to determine derivated or integrated quantities, or *state variable observers*.

Model-based and Adaptive Control Systems

The information processing is, at least in the lower levels, performed by simple algorithms or software-modules under real-time conditions. These algorithms contain free adjustable parameters, which have to be adapted to the static and dynamic behavior of the process. In contrast to manual tuning by trial and error, the use of mathematical models allows precise and fast automatic adaptation.

The mathematical models can be obtained by identification and parameter estimation, which use the measured and sampled input and output signals. These methods are not restricted to linear models, but also allow for several classes of nonlinear systems. If the parameter estimation methods are combined with appropriate control algorithm design methods, adaptive control systems result. They can be used for permanent precise controller tuning or only for commissioning [20].

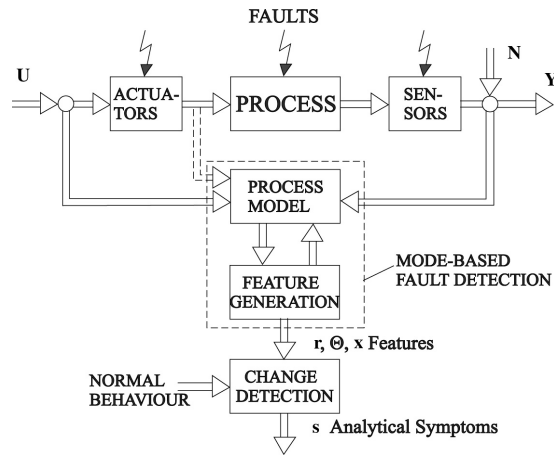

FIGURE 2.6 Scheme for a model-based fault detection.

Supervision and Fault Detection

With an increasing number of automatic functions (autonomy), including electronic components, sensors and actuators, increasing complexity, and increasing demands on reliability and safety, an integrated supervision with fault diagnosis becomes more and more important. This is a significant natural feature of an intelligent mechatronic system. Figure 2.6 shows a process influenced by faults. These faults indicate unpermitted deviations from normal states and can be generated either externally or internally. External faults can be caused by the power supply, contamination, or collision, internal faults by wear, missing lubrication, or actuator or sensor faults. The classical way for fault detection is the limit value checking of some few measurable variables. However, incipient and intermittent faults can not usually be detected, and an in-depth fault diagnosis is not possible by this simple approach. *Model-based fault detection and diagnosis methods* were developed in recent years, allowing for early detection of small faults with normally measured signals, also in closed loops [21]. Based on measured input signals, $U(t)$, and output signals, $Y(t)$, and process models, features are generated by parameter estimation, state and output observers, and parity equations, as seen in Fig. 2.6.

These residuals are then compared with the residuals for normal behavior and with change detection methods analytical symptoms are obtained. Then, a fault diagnosis is performed via methods of classification or reasoning. For further details see [22,23].

A considerable advantage is if the same process model can be used for both the (adaptive) *controller design and the fault detection*. In general, continuous time models are preferred if fault detection is based on parameter estimation or parity equations. For fault detection with state estimation or parity equations, discrete-time models can be used.

Advanced supervision and fault diagnosis is a basis for improving reliability and safety, state dependent maintenance, triggering of redundancies, and reconfiguration.

Intelligent Systems (Basic Tasks)

The information processing within mechatronic systems may range between simple control functions and intelligent control. Various definitions of intelligent control systems do exist, see [24–30]. An intelligent control system may be organized as an *online expert system*, according to Fig. 2.5, and comprises

- multi-control functions (executive functions),
- a knowledge base,
- inference mechanisms, and
- communication interfaces.

The online *control functions* are usually organized in multilevels, as already described. The *knowledge base* contains quantitative and qualitative knowledge. The quantitative part operates with analytic (mathematical) process models, parameter and state estimation methods, analytic design methods (e.g., for control and fault detection), and quantitative optimization methods. Similar modules hold for the qualitative knowledge (e.g., in the form of rules for fuzzy and soft computing). Further knowledge is the past history in the memory and the possibility to predict the behavior. Finally, tasks or schedules may be included.

The *inference mechanism* draws conclusions either by quantitative reasoning (e.g., Boolean methods) or by qualitative reasoning (e.g., possibilistic methods) and takes decisions for the executive functions.

Communication between the different modules, an information management database, and the man-machine interaction has to be organized.

Based on these functions of an online expert system, an intelligent system can be built up, with the ability “to model, reason and learn the process and its automatic functions within a given frame and to govern it towards a certain goal.” Hence, intelligent mechatronic systems can be developed, ranging from “low-degree intelligent” [13], such as intelligent actuators, to “fairly intelligent systems,” such as self-navigating automatic guided vehicles.

An *intelligent mechatronic system* adapts the controller to the mostly nonlinear behavior (adaptation), and stores its controller parameters in dependence on the position and load (learning), supervises all relevant elements, and performs a fault diagnosis (supervision) to request maintenance or, if a failure occurs, to request a fail safe action (decisions on actions). In the case of multiple components, supervision may help to switch off the faulty component and to perform a reconfiguration of the controlled process.

2.5 Concurrent Design Procedure for Mechatronic Systems

The design of mechatronic systems requires a systematic development and use of modern design tools.

Design Steps

Table 2.3 shows five important development steps for mechatronic systems, starting from a purely mechanical system and resulting in a fully integrated mechatronic system. Depending on the kind of mechanical system, the intensity of the single development steps is different. For precision mechanical devices, fairly integrated mechatronic systems do exist. The influence of the electronics on *mechanical elements* may be considerable, as shown by adaptive dampers, anti-lock system brakes, and automatic gears. However, complete *machines* and *vehicles* show first a mechatronic design of their elements, and then slowly a redesign of parts of the overall structure as can be observed in the development of machine tools, robots, and vehicle bodies.





















Required CAD/CAE Tools



The computer aided development of mechatronic systems comprises:

1. constructive specification in the engineering development stage using CAD and CAE tools,
2. model building for obtaining static and dynamic process models,
3. transformation into computer codes for system simulation, and
4. programming and implementation of the final mechatronic software.

Some software tools are described in [31]. A broad range of CAD/CAE tools is available for 2D- and 3D-mechanical design, such as Auto CAD with a direct link to CAM (computer-aided manufacturing), and PADS, for multilayer, printed-circuit board layout. However, the state of computer-aided modeling is not as advanced. Object-oriented languages such as DYMOLA and MOBILE for modeling of large combined systems are described in [31–33]. These packages are based on specified ordinary differential

TABLE 2.3 Steps in the Design of Mechatronic Systems

| | Precision Mechanics | Mechanical Elements | Machines |
|--|---|---|--|
| Pure mechanical system |  |  |  |
| 1. Addition of sensors, actuators, microelectronics, control functions |  |  |  |
| 2. Integration of components (hardware integration) |  |  |  |
| 3. Integration by information processing (software integration) |  |  |  |
| 4. Redesign of mechanical system |  |  |  |
| 5. Creation of synergetic effects |  |  |  |
| Fully integrated mechatronic systems |  |  |  |
| Examples | Sensors actuators disc-storages cameras | Suspensions dampers clutches gears brakes | Electric drives combustion engines mach. tools robots |

The size of a circle indicates the present intensity of the respective mechatronic development step:  large,  medium,  little.

equations, algebraic equations, and discontinuities. A recent description of the state of computer-aided control system design can be found in [34]. For system simulation (and controller design), a variety of program systems exist, like ACSL, SIMPACK, MATLAB/SIMULINK, and MATRIX-X. These simulation techniques are valuable tools for design, as they allow the designer to study the interaction of components and the variations of design parameters before manufacturing. They are, in general, not suitable for real-time simulation.

Modeling Procedure

Mathematical process models for static and dynamic behavior are required for various steps in the design of mechatronic systems, such as simulation, control design, and reconstruction of variables. Two ways to obtain these models are *theoretical modeling* based on first (physical) principles and *experimental modeling (identification)* with measured input and output variables. A basic problem of theoretical modeling of mechatronic systems is that the components originate from different domains. There exists a well-developed domain specific knowledge for the modeling of electrical circuits, multibody mechanical systems, or hydraulic systems, and corresponding software packages. However, a computer-assisted general methodology for the modeling and simulation of components from different domains is still missing [35].

The basic principles of theoretical modeling for system with energy flow are known and can be unified for components from different domains as electrical, mechanical, and thermal (see [36–41]). The modeling methodology becomes more involved if material flows are incorporated as for fluidics, thermodynamics, and chemical processes.

A general procedure for theoretical modeling of lumped parameter processes can be sketched as follows [19].

1. Definition of flows
 - energy flow (electrical, mechanical, thermal conductance)
 - energy and material flow (fluidic, thermal transfer, thermodynamic, chemical)
2. Definition of process elements: flow diagrams
 - sources, sinks (dissipative)
 - storages, transformers, converters
3. Graphical representation of the process model
 - multi-port diagrams (terminals, flows, and potentials, or across and through variables)
 - block diagrams for signal flow
 - bond graphs for energy flow
4. Statement of equations for all process elements
 - (i) Balance equations for storage (mass, energy, momentum)
 - (ii) Constitutive equations for process elements (sources, transformers, converters)
 - (iii) Phenomenological laws for irreversible processes (dissipative systems: sinks)
5. Interconnection equations for the process elements
 - continuity equations for parallel connections (node law)
 - compatibility equations for serial connections (closed circuit law)
6. Overall process model calculation
 - establishment of input and output variables
 - state space representation
 - input/output models (differential equations, transfer functions)

An example of steps 1–3 is shown in [Fig. 2.7](#) for a drive-by-wire vehicle. A unified approach for processes with energy flow is known for electrical, mechanical, and hydraulic processes with incompressible fluids. [Table 2.4](#) defines generalized through and across variables.

In these cases, the product of the through and across variable is power. This unification enabled the formulation of the standard *bond graph modeling* [39]. Also, for hydraulic processes with compressible fluids and thermal processes, these variables can be defined to result in powers, as seen in [Table 2.4](#). However, using mass flows and heat flows is not engineering practice. If these variables are used, so-called pseudo bond graphs with special laws result, leaving the simplicity of standard bond graphs. Bond graphs lead to a high-level abstraction, have less flexibility, and need additional effort to generate simulation algorithms. Therefore, they are not the ideal tool for mechatronic systems [35]. Also, the tedious work needed to establish *block diagrams* with an early definition of causal input/output blocks is not suitable.

Development towards object-oriented modeling is on the way, where objects with terminals (cuts) are defined without assuming a causality in this basic state. Then, object diagrams are graphically represented, retaining an intuitive understanding of the original physical components [43,44]. Hence, theoretical modeling of mechatronic systems with a unified, transparent, and flexible procedure (from the basic components of different domains to simulation) are a challenge for further development. Many components show nonlinear behavior and nonlinearities (friction and backlash). For more complex process parts, multidimensional mappings (e.g., combustion engines, tire behavior) must be integrated.

For verification of theoretical models, several well-known identification methods can be used, such as correlation analysis and frequency response measurement, or Fourier- and spectral analysis. Since some parameters are unknown or changed with time, parameter estimation methods can be applied, both, for models with continuous time or discrete time (especially if the models are linear in the parameters) [42,45,46]. For the identification and approximation of nonlinear, multi-dimensional characteristics,

TABLE 2.4 Generalized Through and Across Variables for Processes with Energy Flow

| System | Through Variables | | Across Variables | |
|---------------|-------------------|-----------|------------------|----------|
| Electrical | Electric current | I | Electric voltage | U |
| Magnetic | Magnetic Flow | F | Magnetic force | Q |
| Mechanical | | | | |
| • translation | Force | F | Velocity | w |
| • rotation | Torque | M | Rotational speed | ω |
| Hydraulic | Volume flow | \dot{V} | Pressure | p |
| Thermodynamic | Entropy flow | | Temperature | T |

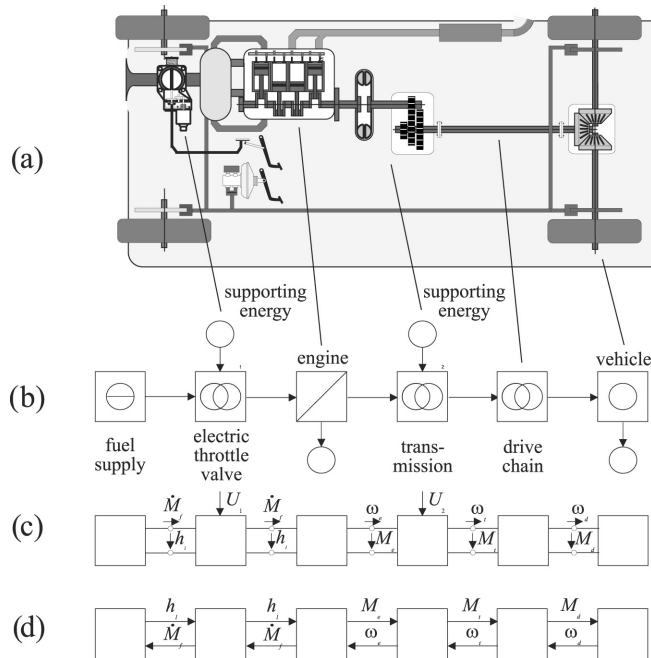

FIGURE 2.7 Different schemes for an automobile (as required for drive-by-wire-longitudinal control): (a) scheme of the components (construction map), (b) energy flow diagram (simplified), (c) multi-port diagram with flows and potentials, (d) signal flow diagram for multi-ports.

artificial neural networks (multilayer perceptrons or radial-basis-functions) can be expanded for non-linear dynamic processes [47].

Real-Time Simulation

Increasingly, real-time simulation is applied to the design of mechatronic systems. This is especially true if the process, the hardware, and the software are developed simultaneously in order to minimize iterative development cycles and to meet short time-to-market schedules. With regard to the required speed of computation *simulation methods*, it can be subdivided into

1. simulation without (hard) time limitation,
2. real-time simulation, and
3. simulation faster than real-time.

Some application examples are given in Fig. 2.8. Herewith, *real-time simulation* means that the simulation of a component is performed such that the input and output signals show the same time-dependent

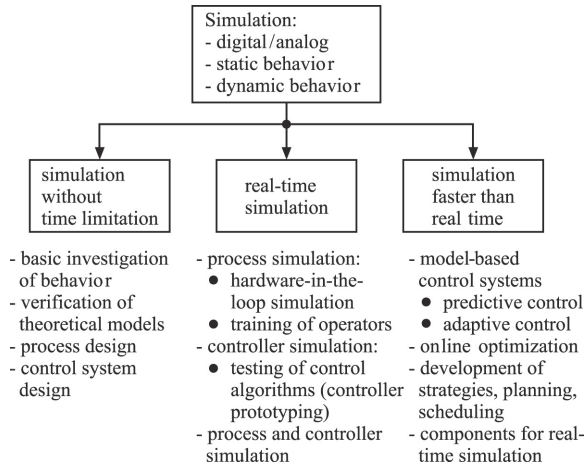

FIGURE 2.8 Classification of simulation methods with regard to speed and application examples.

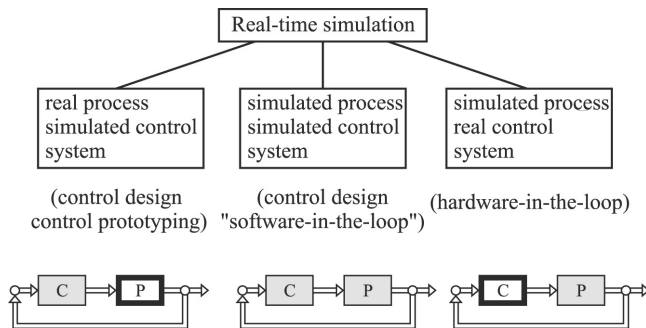

FIGURE 2.9 Classification of real-time simulation.

values as the real, dynamically operating component. This becomes a computational problem for processes which have fast dynamics compared to the required algorithms and calculation speed.

Different kinds of real-time simulation methods are shown in Fig. 2.9. The reason for the real-time requirement is mostly that one part of the investigated system is not simulated but real. Three cases can be distinguished:

1. The *real process* can be operated together with the *simulated control* by using hardware other than the final hardware. This is also called “control prototyping.”
2. The *simulated process* can be operated with the *real control hardware*, which is called “hardware-in-the-loop simulation.”
3. The *simulated process* is run with the *simulated control* in real time. This may be required if the final hardware is not available or if a design step before the hardware-in-the-loop simulation is considered.

Hardware-in-the-Loop Simulation

The *hardware-in-the-loop* simulation (HIL) is characterized by operating real components in connection with real-time simulated components. Usually, the control system hardware and software is the real system, as used for series production. The controlled process (consisting of actuators, physical processes, and sensors) can either comprise simulated components or real components, as seen in Fig. 2.10(a). In general, mixtures of the shown cases are realized. Frequently, some actuators are real and the process

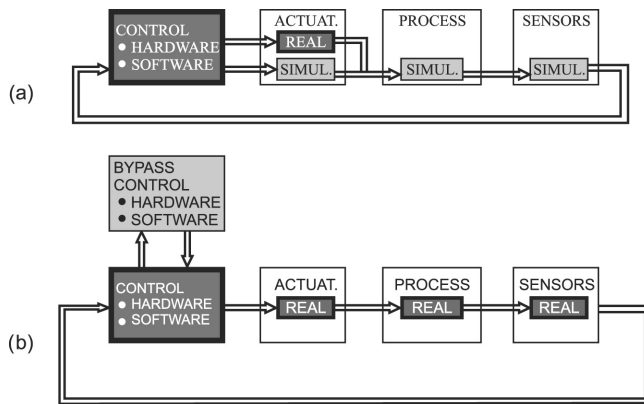

FIGURE 2.10 Real-time simulation: hybrid structures. (a) Hardware-in-the-loop simulation. (b) Control prototyping.

and the sensors are simulated. The reason is that actuators and the control hardware very often form one integrated subsystem or that actuators are difficult to model precisely and to simulate in real time. (The use of real sensors together with a simulated process may require considerable realization efforts, because the physical sensor input does not exist and must be generated artificially.) In order to change or redesign some functions of the control hardware or software, a bypass unit can be connected to the basic control hardware. Hence, hardware-in-the-loop simulators may also contain partially simulated (emulated) control functions.

The advantages of the hardware-in-the-loop simulation are generally:

- design and testing of the control hardware and software without operating a real process (“moving the process field into the laboratory”);
- testing of the control hardware and software under extreme environmental conditions in the laboratory (e.g., high/low temperature, high accelerations and mechanical shocks, aggressive media, electro-magnetic compatibility);
- testing of the effects of faults and failures of actuators, sensors, and computers on the overall system;
- operating and testing of extreme and dangerous operating conditions;
- reproducible experiments, frequently repeatable;
- easy operation with different man-machine interfaces (cockpit-design and training of operators); and
- saving of cost and development time.

Control Prototyping

For the design and testing of complex control systems and their algorithms under real-time constraints, a real-time controller simulation (emulation) with hardware (e.g., off-the-shelf signal processor) other than the final series production hardware (e.g., special ASICs) may be performed. The process, the actuators, and sensors can then be real. This is called *control prototyping* (Fig. 2.10(b)). However, parts of the process or actuators may be simulated, resulting in a mixture of HIL-simulation and control prototyping. The advantages are mainly:

- early development of signal processing methods, process models, and control system structure, including algorithms with high level software and high performance off-the-shelf hardware;
- testing of signal processing and control systems, together with other design of actuators, process parts, and sensor technology, in order to create synergetic effects;

- reduction of models and algorithms to meet the requirements of cheaper mass production hardware; and
- defining the specifications for final hardware and software.

Some of the advantages of HIL-simulation also hold for control prototyping. Some references for real-time simulation are [48,49].

References

1. Kyura, N. and Oho, H., Mechatronics—an industrial perspective. *IEEE/ASME Transactions on Mechatronics*, 1(1):10–15.
2. Schweitzer, G., Mechatronik-Aufgaben und Lösungen. VDI-Berichte Nr. 787. VDI-Verlag, Düsseldorf, 1989.
3. Ovaska, S. J., Electronics and information technology in high range elevator systems. *Mechatronics*, 2(1):89–99, 1992.
4. *IEEE/ASME Transactions on Mechatronics*, 1996.
5. Harashima, F., Tomizuka, M., and Fukuda, T., Mechatronics—“What is it, why and how?” An editorial. *IEEE/ASME Transactions on Mechatronics*, 1(1):1–4, 1996.
6. Schweitzer, G., Mechatronics—a concept with examples in active magnetic bearings. *Mechatronics*, 2(1):65–74, 1992.
7. Gausemeier, J., Brexel, D., Frank, Th., and Humpert, A., Integrated product development. In *Third Conf. Mechatronics and Robotics*, Paderborn, Germany, Okt. 4–6, 1995. Teubner, Stuttgart, 1995.
8. Isermann, R., Modeling and design methodology for mechatronic systems. *IEEE/ASME Transactions on Mechatronics*, 1(1):16–28, 1996.
9. *Mechatronics: An International Journal. Aims and Scope*. Pergamon Press, Oxford, 1991.
10. *Mechatronics Systems Engineering: International Journal on Design and Application of Integrated Electromechanical Systems*. Kluwer Academic Publishers, Nethol, 1993.
11. IEE, Mechatronics: Designing intelligent machines. In *Proc. IEE-Int. Conf.* 12–13 Sep., Univ. of Cambridge, 1990.
12. Hiller, M. (ed.), *Second Conf. Mechatronics and Robotics*. September 27–29, Duisburg/Moers, Germany, 1993. Moers, IMECH, 1993.
13. Isermann, R. (ed.), Integrierte mechanisch elektronische Systeme. March 2–3, Darmstadt, Germany, 1993. Fortschr.-Ber. VDI Reihe 12 Nr. 179. VDI-Verlag, Düsseldorf, 1993.
14. Lückel, J. (ed.), *Third Conf. Mechatronics and Robotics*, Paderborn, Germany, Oct. 4–6, 1995. Teubner, Stuttgart, 1995.
15. Kaynak, O., Özkan, M., Bekiroglu, N., and Tunay, I. (eds.), Recent advances in mechatronics. In *Proc. Int. Conf. Recent Advances in Mechatronics*, August 14–16, 1995, Istanbul, Turkey.
16. Kitaura, K., Industrial mechatronics. New East Business Ltd., in Japanese, 1991.
17. Bradley, D. A., Dawson, D., Burd, D., and Loader, A. J., *Mechatronics-Electronics in Products and Processes*. Chapman and Hall, London, 1991.
18. McConaill, P. A., Drews, P., and Robrock, K. H., *Mechatronics and Robotics I*. IOS-Press, Amsterdam, 1991.
19. Isermann, R., *Mechatronische Systeme*. Springer, Berlin, 1999.
20. Isermann, R., Lachmann, K. H., and Matko, D., *Adaptive Control Systems*, Prentice-Hall, London, 1992.
21. Isermann, R., Supervision, fault detection and fault diagnosis methods—advanced methods and applications. In *Proc. XIV IMEKO World Congress*, Vol. 1, pp. 1–28, Tampere, Finland, 1997.
22. Isermann, R., Supervision, fault detection and fault diagnosis methods—an introduction, special section on supervision, fault detection and diagnosis. *Control Engineering Practice*, 5(5):639–652, 1997.
23. Isermann, R. (ed.), Special section on supervision, fault detection and diagnosis. *Control Engineering Practice*, 5(5):1997.

24. Saridis, G. N., *Self Organizing Control of Stochastic Systems*. Marcel Dekker, New York, 1977.
25. Saridis, G. N. and Valavanis, K. P., Analytical design of intelligent machines. *Automatica*, 24:123–133, 1988.
26. Åström, K. J., Intelligent control. In *Proc. European Control Conf.*, Grenoble, 1991.
27. White, D. A. and Sofge, D. A. (eds.), *Handbook of Intelligent Control*. Van Norstrad, Reinhold, New York, 1992.
28. Antaklis, P., Defining intelligent control. *IEEE Control Systems*, Vol. June: 4–66, 1994.
29. Gupta, M. M. and Sinha, N. K., *Intelligent Control Systems*. IEEE-Press, New York, 1996.
30. Harris, C. J. (ed.), *Advances in Intelligent Control*. Taylor & Francis, London, 1994.
31. Otter, M. and Gruebel, G., Direct physical modeling and automatic code generation for mechatronics simulation. In *Proc. 2nd Conf. Mechatronics and Robotics*, Duisburg, Sep. 27–29, IMECH, Moers, 1993.
32. Elmquist, H., Object-oriented modeling and automatic formula manipulation in Dymola, Scand. Simul. Society SIMS, June, Kongsberg, 1993.
33. Hiller, M., Modelling, simulation and control design for large and heavy manipulators. In *Proc. Int. Conf. Recent Advances in Mechatronics*. 1:78–85, Istanbul, Turkey, 1995.
34. James, J., Cellier, F., Pang, G., Gray, J., and Mattson, S. E., The state of computer-aided control system design (CACSD). *IEEE Transactions on Control Systems*, Special Issue, April 6–7 (1995).
35. Otter, M. and Elmquist, H., Energy flow modeling of mechatronic systems via object diagrams. In *Proc. 2nd MATHMOD*, Vienna, 705–710, 1997.
36. Paynter, H. M., *Analysis and Design of Engineering Systems*. MIT Press, Cambridge, 1961.
37. MacFarlane, A. G. J., *Engineering Systems Analysis*. G. G. Harrop, Cambridge, 1964.
38. Wellstead, P. E., *Introduction to Physical System Modelling*. Academic Press, London, 1979.
39. Karnopp, D. C., Margolis, D. L., and Rosenberg, R. C., *System Dynamics. A Unified Approach*. J. Wiley, New York, 1990.
40. Cellier, F. E., *Continuous System Modelling*. Springer, Berlin, 1991.
41. Gawthrop, F. E. and Smith, L., *Metamodelling: Bond Graphs and Dynamic Systems*. Prentice-Hall, London, 1996.
42. Eykhoff, P., *System Identification*. John Wiley & Sons, London, 1974.
43. Elmquist, H., A structured model language for large continuous systems. Ph.D. Dissertation, Report CODEN: LUTFD2/(TFRT-1015) Dept. of Aut. Control, Lund Institute of Technology, Sweden, 1978.
44. Elmquist, H. and Mattson, S. E., Simulator for dynamical systems using graphics and equations for modeling. *IEEE Control Systems Magazine*, 9(1):53–58, 1989.
45. Isermann, R., *Identifikation dynamischer Systeme*. 2nd Ed., Vol. 1 and 2. Springer, Berlin, 1992.
46. Ljung, L., *System Identification: Theory for the User*. Prentice-Hall, Englewood Cliffs, NJ, 1987.
47. Isermann, R., Ernst, S., and Nelles, O., Identification with dynamic neural networks—architectures, comparisons, applications—Plenary. In *Proc. IFAC Symp. System Identification (SYSID'97)*, Vol. 3, pp. 997–1022, Fukuoka, Japan, 1997.
48. Hanselmann, H., Hardware-in-the-loop simulation as a standard approach for development, customization, and production test, SAE 930207, 1993.
49. Isermann, R., Schaffnit, J., and Sinsel, S., Hardware-in-the-loop simulation for the design and testing of engine control systems. *Control Engineering Practice*, 7(7):643–653, 1999.

3

System Interfacing, Instrumentation, and Control Systems

- 3.1 Introduction
 - The Mechatronic System • A Home/Office Example
 - An Automotive Example
- 3.2 Input Signals of a Mechatronic System
 - Transducer/Sensor Input • Analog-to-Digital Converters
- 3.3 Output Signals of a Mechatronic System
 - Digital-to-Analog Converters • Actuator Output
- 3.4 Signal Conditioning
 - Sampling Rate • Filtering • Data Acquisition Boards
- 3.5 Microprocessor Control
 - PID Control • Programmable Logic Controllers • Microprocessors
- 3.6 Microprocessor Numerical Control
 - Fixed-Point Mathematics • Calibrations
- 3.7 Microprocessor Input–Output Control
 - Polling and Interrupts • Input and Output Transmission • HC12 Microcontroller Input–Output Subsystems • Microcontroller Network Systems
- 3.8 Software Control
 - Systems Engineering • Software Engineering • Software Design
- 3.9 Testing and Instrumentation
 - Verification and Validation • Debuggers • Logic Analyzer
- 3.10 Summary

Rick Homkes
Purdue University

3.1 Introduction

The purpose of this chapter is to introduce a number of topics dealing with a mechatronic system. This starts with an overview of mechatronic systems and a look at the input and output signals of a mechatronic system. The special features of microprocessor input and output are next. Software, an often-neglected portion of a mechatronic system, is briefly covered with an emphasis on software engineering concepts. The chapter concludes with a short discussion of testing and instrumentation.

The Mechatronic System

Figure 3.1 shows a typical mechatronic system with mechanical, electrical, and computer components. The process of system data acquisition begins with the measurement of a physical value by a sensor. The sensor is able to generate some form of signal, generally an analog signal in the form of a voltage level or waveform. This analog signal is sent to an analog-to-digital converter (ADC). Commonly using a process of successive approximation, the ADC maps the analog input signal to a digital output. This digital value is composed of a set of binary values called bits (often represented by 0s and 1s). The set of bits represents a decimal or hexadecimal number that can be used by the microcontroller. The microcontroller consists of a microprocessor plus memory and other attached devices. The program in the microprocessor uses this digital value along with other inputs and preloaded values called calibrations to determine output commands. Like the input to the microprocessor, these outputs are in digital form and can be represented by a set of bits. A digital-to-analog converter (DAC) is then often used to convert the digital value into an analog signal. The analog signal is used by an actuator to control a physical device or affect the physical environment. The sensor then takes new measurements and the process repeated, thus completing a feedback control loop. Timing for this entire operation is synchronized by the use of a clock.

A Home/Office Example

An example of a mechatronic system is the common heating/cooling system for homes and offices. Simple systems use a bimetal thermostat with contact points controlling a mercury switch that turns on and off the furnace or air conditioner. A modern environmental control system uses these same basic components along with other components and computer program control. A temperature sensor monitors the physical environment and produces a voltage level as demonstrated in Fig. 3.2 (though generally not nearly such a smooth function). After conversion by the ADC, the microcontroller uses the digitized temperature

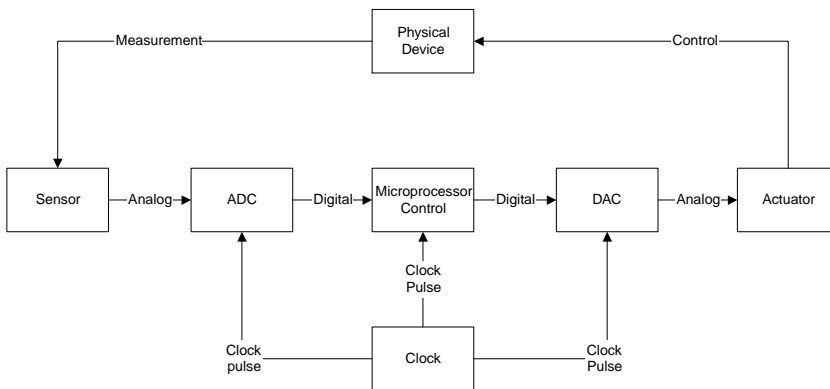

FIGURE 3.1 Microprocessor control system.

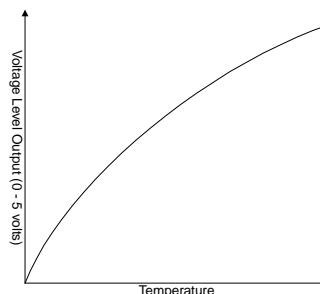

FIGURE 3.2 Voltage levels.

data along with a 24-hour clock and the user requested temperatures to produce a digital control signal. This signal directs the actuator, usually a simple electrical switch in this example. The switch, in turn, controls a motor to turn the heating or cooling unit on or off. New measurements are then taken and the cycle is repeated. While not a mechatronic product on the order of a camcorder, it is a mechatronic system because of its combination of mechanical, electrical, and computer components. This system may also incorporate some additional features. If the temperature being sensed is quite high, say 80°C, it is possible that a fire exists. It is then not a good idea to turn on the blower fan and feed the fire more oxygen. Instead the system should set off an alarm or use a data communication device to alert the fire department. Because of this type of computer control, the system is “smart,” at least relative to the older mercury-switch controlled systems.

An Automotive Example

A second example is the Antilock Braking System (ABS) found in many vehicles. The entire purpose of this type of system is to prevent a wheel from locking up and thus having the driver lose directional control of the vehicle due to skidding. In this case, sensors attached to each wheel determine the rotational speed of the wheels. These data, probably in a waveform or time-varied electrical voltage, is sent to the microcontroller along with the data from sensors reporting inputs such as brake pedal position, vehicle speed, and yaw. After conversion by the ADC or input capture routine into a digital value, the program in the microprocessor then determines the necessary action. This is where the aspect of human computer interface (HCI) or human machine interface (HMI) comes into play by taking account of the “feel” of the system to the user. System calibration can adjust the response to the driver while, of course, stopping the vehicle by controlling the brakes with the actuators. There are two important things to note in this example. The first is that, in the end, the vehicle is being stopped because of hydraulic forces pressing the brake pad against a drum or rotor—a purely mechanical function. The other is that the ABS, while an “intelligent product,” is not a stand-alone device. It is part of a larger system, the vehicle, with multiple microcontrollers working together through the data network of the vehicle.

3.2 Input Signals of a Mechatronic System

Transducer/Sensor Input

All inputs to mechatronic systems come from either some form of sensory apparatus or communications from other systems. Sensors were first introduced in the previous section and will be discussed in much more depth in [Chapter 19](#). Transducers, devices that convert energy from one form to another, are often used synonymously with sensors. Transducers and their properties will be explained fully in [Chapter 45](#). Sensors can be divided into two general classifications, active or passive. Active sensors emit a signal in order to estimate an attribute of the environment or device being measured. Passive sensors do not. A military example of this difference would be a strike aircraft “painting” a target using either active laser radar (LADAR) or a passive forward looking infrared (FLIR) sensor.

As stated in the Introduction section, the output of a sensor is usually an analog signal. The simplest type of analog signal is a voltage level with a direct (though not necessarily linear) correlation to the input condition. A second type is a pulse width modulated (PWM) signal, which will be explained further in a later section of this chapter when discussing microcontroller outputs. A third type is a waveform, as shown in [Fig. 3.3](#). This type of signal is modulated either in its amplitude ([Fig. 3.4](#)) or its frequency ([Fig. 3.5](#)) or, in some cases, both. These changes reflect the changes in the condition being monitored.

There are sensors that do not produce an analog signal. Some of these sensors produce a square wave as in [Fig. 3.6](#) that is input to the microcontroller using the EIA 232 communications standard. The square wave represents the binary values of 0 and 1. In this case the ADC is probably on-board the sensor itself, adding to the cost of the sensor. Some sensors/recorders can even create mail or TCP/IP packets as output. An example of this type of unit is the MV100 MobileCorder from Yokogawa Corporation of America.

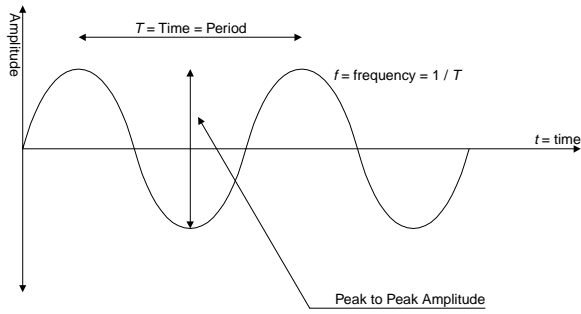

FIGURE 3.3 Sine wave.

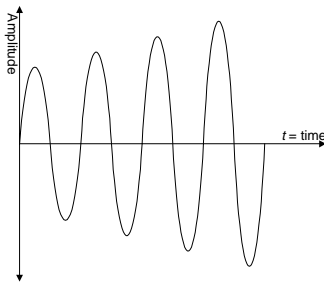

FIGURE 3.4 Amplitude modulation.

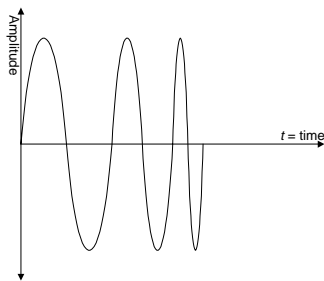

FIGURE 3.5 Frequency modulation.

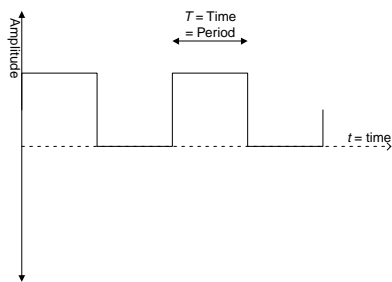

FIGURE 3.6 Square wave.

Analog-to-Digital Converters

The ADC can basically be typed by two parameters: the analog input range and the digital output range. As an example, consider an ADC that is converting a voltage level ranging 0–12 V into a single byte of 8 bits. In this example, each binary count increment reflects an increase in analog voltage of $1/256$ of the maximum 12 V. There is an unusual twist to this conversion, however. Since a zero value represents 0 V, and a 128 value represents half of the maximum value, 6 V in this example, the maximum decimal value of 255 represents $255/256$ of the maximum voltage value, or 11.953125 V. A table of the equivalent values is shown below:

| Binary | Decimal | Voltage |
|-----------|---------|------------|
| 0000 0000 | 0 | 0.0 |
| 0000 0001 | 1 | 0.00390625 |
| 1000 0000 | 128 | 6.0 |
| 1111 1111 | 255 | 11.953125 |

An ADC that is implemented in the Motorola HC12 microcontroller produces 10 bits. While not fitting so nicely into a single byte of data, this 10-bit ADC does give additional resolution. Using an input range from 0 to 5 V, the decimal resolution per least significant bit is 4.88 mV. If the ADC had 8 bits of output, the resolution per bit would be 19.5 mV, a fourfold difference. Larger voltages, e.g., from 0 to 12 V, can be scaled with a voltage divider to fit the 0–5 V range. Smaller voltages can be amplified to span the entire range. A process known as successive approximation (using the Successive Approximation Register or SAR in the Motorola chip) is used to determine the correct digital value.

3.3 Output Signals of a Mechatronic System

Digital-to-Analog Converters

The output command from the microcontroller is a binary value in bit, byte (8 bits), or word (16 bits) form. This digital signal is converted to analog using a digital-to-analog converter, or DAC. Let us examine converting an 8-bit value into a voltage level between 0 and 12 V. The most significant bit in the binary value to be converted (decimal 128) creates an analog value equal to half of the maximum output, or 6 V. The next digit produces an additional one fourth, or 3 V, the next an additional one eighth, and so forth. The sum of all these weighted output values represents the appropriate analog voltage. As was mentioned in a previous section, the maximum voltage value in the range is not obtainable, as the largest value generated is $255/256$ of 12 V, or 11.953125 V. The smoothness of the signal representation depends on the number of bits accepted by the DAC and the range of the output required. Figure 3.7 demonstrates a simplified step function using a one-byte binary input and 12-V analog output.

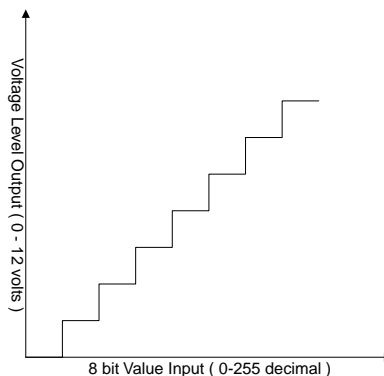

FIGURE 3.7 DAC stepped output.

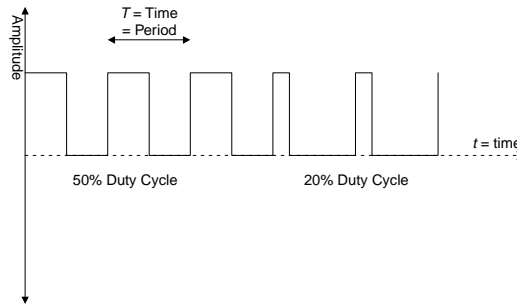

FIGURE 3.8 Pulse width modulation.

Actuator Output

Like sensors, actuators were first introduced in a previous section and will be described in detail in a later chapter of this handbook. The three common actuators that this section will review are switches, solenoids, and motors. Switches are simple state devices that control some activity, like turning on and off the furnace in a house. Types of switches include relays and solid-state devices. Solid-state devices include diodes, thyristors, bipolar transistors, field-effect transistors (FETs), and metal-oxide field-effect transistors (MOSFETs). A switch can also be used with a sensor, thus turning on or off the entire sensor, or a particular feature of a sensor.

Solenoids are devices containing a movable iron core that is activated by a current flow. The movement of this core can then control some form of hydraulic or pneumatic flow. Applications are many, including braking systems and industrial production of fluids. More information on solenoid actuators can be found in a later chapter. Motors are the last type of actuator that will be summarized here. There are three main types: direct current (DC), alternating current (AC), and stepper motors. DC motors may be controlled by a fixed DC voltage or by pulse width modulation (PWM). In a PWM signal, such as shown in Fig. 3.8, a voltage is alternately turned on and off while changing (modulating) the width of the on-time signal, or duty cycle. AC motors are generally cheaper than DC motors, but require variable frequency drive to control the rotational speed. Stepper motors move by rotating a certain number of degrees in response to an input pulse.

3.4 Signal Conditioning

Signal conditioning is the modification of a signal to make it more useful to a system. Two important types of signal conditioning are, of course, the conversion between analog and digital, as described in the previous two sections. Other types of signal conditioning are briefly covered below, with a full coverage reserved for [Chapters 46](#) and [47](#).

Sampling Rate

The rate at which data samples are taken obviously affects the speed at which the mechatronic system can detect a change in situation. There are several things to consider, however. For example, the response of a sensor may be limited in time or range. There is also the time required to convert the signal into a form usable by the microprocessor, the A to D conversion time. A third is the frequency of the signal being sampled. For voice digitalization, there is a very well-known sampling rate of 8000 samples per second. This is a result of the Nyquist theorem, which states that the sampling rate, to be accurate, must be at least twice the maximum frequency being measured. The 8000 samples per second rate thus works well for converting human voice over an analog telephone system where the highest frequency is approximately 3400 Hz. Lastly, the clock speed of the microprocessor must also be considered. If the ADC and DAC are

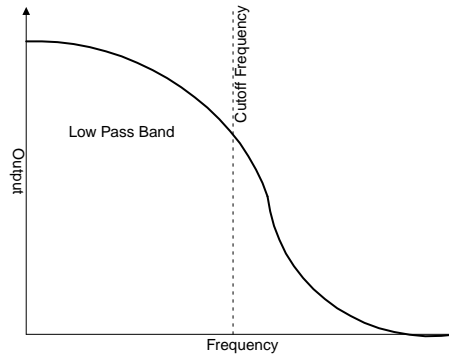

FIGURE 3.9 Low-pass filter.

on the same board as the microprocessor, they will often share a common clock. The microprocessor clock, however, may be too fast for the ADC and DAC. In this case, a prescaler is used to divide the clock frequency to a level usable by the ADC and DAC.

Filtering

Filtering is the attenuation (lessening) of certain frequencies from a signal. This process can remove noise from a signal and condition the line for better data transmission. Filters can be divided into analog and digital types, the analog filters being further divided into passive and active types. Analog passive filters use resistors, capacitors, and inductors. Analog active filters typically use operational amplifiers with resistors and capacitors. Digital filters may be implemented with software and/or hardware. The software component gives digital filters the feature of being easier to change. Digital filters are explained fully in [Chapter 29](#).

Filters may also be differentiated by the type of frequencies they affect.

1. Low-pass filters allow lower set of frequencies to pass through, while high frequencies are attenuated. A simplistic example of this is shown in [Fig. 3.9](#).
2. High-pass filters, the opposite of low-pass, filter a lower frequency band while allowing higher frequencies to pass.
3. Band-pass filters allow a particular range of frequencies to pass; all others are attenuated.
4. Band-stop filters stop a particular range of frequencies while all others are allowed to pass.

There are many types and applications of filters. For example, William Ribbens in his book *Understanding Automotive Electronics* (Newnes 1998) described a software low-pass filter (sometimes also called a lag filter) that averages the last 60 fuel tank level samples taken at 1 s intervals. The filtered data are then displayed on the vehicle instrument cluster. This type of filtering reduces large and quick fluctuations in the fuel gauge due to sloshing in the tank, and thus displays a more accurate value.

Data Acquisition Boards

There is a special type of board that plugs into a slot in a desktop personal computer that can be used for many of the tasks above. It is called a data acquisition board, or DAQ board. This type of board can generate analog input and multiplex multiple input signals onto a single bus for transmission to the PC. It can also come with signal conditioning hardware/software and an ADC. Some units have direct memory access (DMA), where the device writes the data directly into computer memory without using the microprocessor. While desktop PCs are not usually considered as part of a mechatronic system, the DAQ board can be very useful for instrumentation.

3.5 Microprocessor Control

PID Control

A closed loop control system is one that determines a difference in the desired and actual condition (the error) and creates a correction control command to remove this error. PID control demonstrates three ways of looking at this error and correcting it. The first way is the P of PID, the proportional term. This term represents the control action made by the microcontroller in proportion to the error. In other words, the bigger the error, the bigger the correction. The I in PID is for the integral of the error over time. The integral term produces a correction that considers the time the error has been present. Stated in other words, the longer the error continues, the bigger the correction. Lastly, the D in PID stands for derivative. In the derivative term, the corrective action is related to the derivative or change of the error with respect to time. Stated in other words, the faster the error is changing, the bigger the correction. Control systems can use P, PI, PD, or PID in creating corrective actions. The problem generally is “tuning” the system by selecting the proper values in the terms. For more information on control design, see [Chapter 31](#).

Programmable Logic Controllers

Any discussion of control systems and microprocessor control should start with the first type of “mechanical” control, the programmable logic controller or PLC. A PLC is a simpler, more rugged microcontroller designed for environments like a factory floor. Input is usually from switches such as push buttons controlled by machine operators or position sensors. Timers can also be programmed in the PLC to run a particular process for a set amount of time. Outputs include lamps, solenoid valves, and motors, with the input–output interfacing done within the controller. A simple programming language used with a PLC is called ladder logic or ladder programming. Ladder logic is a graphical language showing logic as a combination of series (and’s) and parallel (or’s) blocks. Additional information can be found in [Chapter 43](#) and in the book *Programmable Logic Controllers* by W. Bolton (Newnes 1996).

Microprocessors

A full explanation of a microprocessor is found in section 5.8. For this discussion of microprocessors and control, we need only know a few of the component parts of computer architecture. RAM, or random access memory, is the set of memory locations the computer uses for fast temporary storage. The radio station presets selected by the driver (or passenger) in the car radio are stored in RAM. A small electrical current maintains these stored frequencies, so disconnection of the radio from the battery will result in their loss. ROM, or read only memory, is the static memory that contains the program to run the microcontroller. Thus the radio’s embedded program will not be lost when the battery is disconnected. There are several types of ROM, including erasable programmable ROM (EPROM), electrically erasable programmable ROM (EEPROM), and flash memory (a newer type of EEPROM). These types will be explained later in this handbook. There are also special memory areas in a microprocessor called registers. Registers are very fast memory locations that temporarily store the address of the program instruction being executed, intermediate values needed to complete a calculation, data needed for comparison, and data that need to be input or output. Addresses and data are moved from one point to another in RAM, ROM, and registers using a bus, a set of lines transmitting data multiple bits simultaneously.

3.6 Microprocessor Numerical Control

Fixed-Point Mathematics

The microprocessors in an embedded controller are generally quite small in comparison to a personal computer or computer workstation. Adding processing power in the form of a floating-point processor and additional RAM or ROM is not always an option. This means that sometimes the complex mathematical

functions needed in a control system are not available. However, sometimes the values being sensed and computed, though real numbers, are of a reasonable range. Because of this situation there exists a special type of arithmetic whereby microcontrollers use integers in place of floating-point numbers to compute non-whole number (pseudo real) values.

There are several forms of fixed-point mathematics currently in use. The simplest form is based upon powers of 2, just like normal integers in binary. However, a virtual binary point is inserted into the integer to allow an approximation of real values to be stored as integers. A standard 8-bit unsigned integer is shown below along with its equivalent decimal value.

$$0001\ 0100 = (1 * 2^4) + (1 * 2^2) = (1 * 16) + (1 * 4) = 20$$

Suppose a virtual binary point is inserted between the two nibbles in the byte. There are now four bits left of the binary point with the standard positive powers of 2, and 4 bits right of the binary point with negative powers of 2. The same number now represents a real number in decimal.

$$0001\ 0100 = (1 * 2^0) + (1 * 2^{-2}) = (1 * 1) + (1 * 0.25) = 1.25$$

Obviously this method has shortcomings. The resolution of any fixed point number is limited to the power of 2 attached to the least significant bit on the right of the number, in this case 2^{-4} or 1/16 or 0.0625. Rounding is sometimes necessary. There is also a tradeoff in complexity, as the position of this virtual binary point must constantly be maintained when performing calculations. The savings in memory usage and processing time, however, often overcome these tradeoffs; so fixed-point mathematics can be very useful.

Calibrations

The area of calibrating a system can sometimes take on an importance not foreseen when designing a mechatronic system. The use of calibrations, numerical and logical values kept in EEPROM or ROM, allow flexibility in system tuning and implementation. For example, if different microprocessor crystal speeds may be used in a mechatronic system, but real-time values are needed, a stored calibration constant of clock cycles per microsecond will allow this calculation to be affected. Thus, calibrations are often used as a gain, the value multiplied by some input in order to produce a scaled output.

Also, as mentioned above, calibrations are often used in the testing of a mechatronic system in order to change the “feel” of the product. A transmission control unit can use a set of calibrations on engine RPM, engine load, and vehicle speed to determine when to shift gears. This is often done with hysteresis, as the shift points moving from second gear to third gear as from third gear to second gear may differ.

3.7 Microprocessor Input–Output Control

Polling and Interrupts

There are two basic methods for the microprocessor to control input and output. These are polling and interrupts. Polling is just that, the microprocessor periodically checking various peripheral devices to determine if input or output is waiting. If a peripheral device has some input or output that should be processed, a flag will be set. The problem is that a lot of processing time is wasted checking for inputs when they are not changing.

Servicing an interrupt is an alternative method to control inputs and outputs. In this method, a register in the microprocessor must have set an interrupt enable (IE) bit for a particular peripheral device. When an interrupt is initiated by the peripheral, a flag is set for the microprocessor. The interrupt request (IRQ) line will go active, and the microprocessor will service the interrupt. Servicing an interrupt means that the normal processing of the microprocessor is halted (i.e., interrupted) while the input/output is completed. In order to resume normal processing, the microprocessor needs to store the contents of its registers before the interrupt is serviced. This process includes saving all active register contents to a stack, a part

of RAM designated for this purpose, in a process known as a push. After a push, the microprocessor can then load the address of the Interrupt Service Routine and complete the input/output. When that portion of code is complete, the contents of the stack are reloaded to the registers in an operation known as a Pop (or Pull) and normal processing resumes.

Input and Output Transmission

Once the input or output is ready for transmission, there are several modes that can be used. First, data can be moved in either parallel or serial mode. Parallel mode means that multiple bits (e.g., 16 bits) move in parallel down a multiple pathway or bus from source to destination. Serial mode means that the bits move one at a time, in a series, down a single pathway. Parallel mode traffic is faster in that multiple bits are moving together, but the number of pathways is a limiting factor. For this reason parallel mode is usually used for components located close to one another while serial transmission is used if any distance is involved.

Serial data transmission can also be differentiated by being asynchronous or synchronous. Asynchronous data transmission uses separate clocks between the sender and receiver of data. Since these clocks are not synchronized, additional bits called start and stop bits are required to designate the boundaries of the bytes being sent. Synchronous data transmission uses a common or synchronized timing source. Start and stop bits are thus not needed, and overall throughput is increased.

A third way of differentiating data transmission is by direction. A simplex line is a one direction only pathway. Data from a sensor to the microcontroller may use simplex mode. Half-duplex mode allows two-way traffic, but only one direction at a time. This requires a form of flow control to avoid data transmission errors. Full-duplex mode allows two-way simultaneous transmission of data.

The agreement between sending and receiving units regarding the parameters of data transmission (including transmission speed) is known as handshaking.

HC12 Microcontroller Input–Output Subsystems

There are four input–output subsystems on the Motorola HC12 microcontroller that can be used to exemplify the data transmission section above.

The serial communications interface (SCI) is an asynchronous serial device available on the HC12. It can be either polled or interrupt driven and is intended for communication between remote devices. Related to SCI is the serial peripheral interface (SPI). SPI is a synchronous serial interface. It is intended for communication between units that support SPI like a network of multiple microcontrollers. Because of the synchronization of timing that is required, SPI uses a system of master/slave relationships between microcontrollers.

The pulse width modulation (PWM) subsystem is often used for motor and solenoid control. Using registers that are mapped to both the PWM unit and the microprocessor, a PWM output can be commanded by setting values for the period and duty cycle in the proper registers. This will result in a particular on-time and off-time voltage command.

Last, the serial in-circuit debugger (SDI) allows the microcontroller to connect to a PC for checking and modifying embedded software.

Microcontroller Network Systems

There is one last topic that should be mentioned in this section on inputs and outputs. Mechatronic systems often work with other systems in a network. Data and commands are thus transmitted from one system to another. While there are many different protocols, both open and proprietary, that could be mentioned about this networking, two will serve our purposes. The first is the manufacturing automation protocol (MAP) that was developed by General Motors Corporation. This system is based on the ISO Open Systems Interconnection (OSI) model and is especially designed for computer integrated manufacturing (CIM) and multiple PLCs. The second is the controller area network (CAN). This standard for serial communications was developed by Robert Bosch GmbH for use among embedded systems in a car.

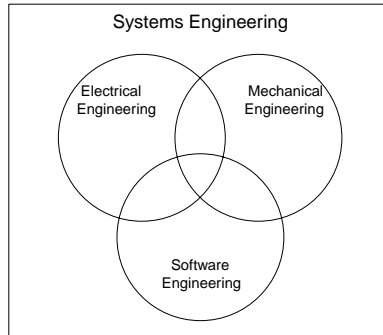

FIGURE 3.10 Mechatronics engineering disciplines.

3.8 Software Control

Systems Engineering

Systems engineering is the systems approach to the design and development of products and systems. As shown in Fig. 3.10, a drawing that shows the relationships of the major engineering competencies with mechatronics, the systems engineering competency encompasses the mechanical, electrical, and software competencies. There are several important tasks for the systems engineers to perform, starting with requirements gathering and continuing through final product and system verification and validation. After requirements gathering and analysis, the systems engineers should partition requirements functionality between mechanical, electrical, and software components, in consultation with the three competencies involved. This is part of the implementation of concurrent engineering. As also shown by the figure, software is an equal partner in the development of a mechatronic system. It is not an add-on to the system and it is not free, the two opinions that were sometimes held in the past by engineering management. While the phrase “Hardware adds cost, software adds value” is not entirely true either, sometimes software engineers felt that their competency was not given equal weight with the traditional engineering disciplines. And one last comment—many mechatronic systems are safety related, such as an air bag system in a car. It is as important for the software to be as fault tolerant as the hardware.

Software Engineering

Software engineering is concerned with both the final mechatronic “product” and the mechatronic development process. Two basic approaches are used with process, with many variations upon these approaches. One is called the “waterfall” method, where the process moves (falls) from one phase to another (e.g., analysis to design) with checkpoints along the way. The other method, the “spiral” approach, is often used when the requirements are not as well fixed. In this method there is prototyping, where the customers and/or systems engineers refine requirements as more information about the system becomes known. In either approach, once the requirements for the software portion of the mechatronic system are documented, the software engineers should further partition functionality as part of software design. Metrics as to development time, development cost, memory usage, and throughput should also be projected and recorded. Here is where the Software Engineering Institute’s Capability Maturity Model (SEI CMM) levels can be used for guidance. It is a truism that software is almost never developed as easily as estimated, and that a system can remain at the “90% complete” level for most of the development life cycle. The first solution attempted to solve this problem is often assigning more software engineers onto the project. This does not always work, however, because of the learning curve of the new people, as stated by Frederick Brooks in his important book *The Mythical Man Month* (Addison-Wesley 1995).

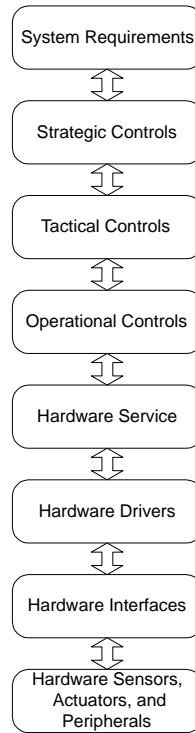

FIGURE 3.11 Mechatronic software layering.

Software Design

Perhaps the most important part of the software design for a mechatronic system can be seen from the hierarchy in Fig. 3.11. Ranging from requirements at the top to hardware at the bottom, this layering serves several purposes. The most important is that it separates mechatronic functionality from implementation. Quite simply, an upper layer should not be concerned with how a lower layer is actually performing a task. Each layer instead is directed by the layer above and receives a service or status from a layer below it. To cross more than one layer boundary is bad technique and can cause problems later in the process. Remember that this process abstraction is quite useful, for a mechatronic system has mechanical, electrical, and software parts all in concurrent development. A change in a sensor or actuator interface should only require a change at the layer immediately above, the driver layer. There is one last reason for using a hierarchical model such as this. In the current business climate, it is unlikely that the people working at the various layers will be collocated. Instead, it is not uncommon for development to be taking place in multiple locations in multiple countries. Without a crisp division of these layers, chaos can result.

For more information on these and many other topics in software engineering such as coupling, cohesion, and software reuse, please refer to Chapter 49 of this handbook, Roger Pressman’s book *Software Engineering: A Practitioner’s Approach 5th Edition* (McGraw Hill 2000), and Steve McConnell’s book *Code Complete* (Microsoft Press 1993).

3.9 Testing and Instrumentation

Verification and Validation

Verification and validation are related tasks that should be completed throughout the life cycle of the mechatronic product or system. Boehm in his book *Software Engineering Economics* (Prentice-Hall 1988) describes verification as “building the product right” while validation is “building the right product.” In other words, verification is the testing of the software and product to make sure that it is built to the design. Validation, on the other hand, is to make sure the software or product is built to the requirements

from the customer. As mentioned, verification and validation are life cycle tasks, not tasks completed just before the system is set for production. One of the simplest and most useful techniques is to hold hardware and software validation and verification reviews. Validation design reviews of hardware and software should include the systems engineers who have the best understanding of the customer requirements. Verification hardware design and software code reviews, or peer reviews, are an excellent means of finding errors upstream in the development process. Managers may have to decide whether to allocate resources upstream, when the errors are easier to fix, or downstream, when the ramifications can be much more drastic. Consider the difference between a code review finding a problem in code, and having the author change it and recompile, versus finding a problem after the product has been sold and in the field, where an expensive product recall may be required.

Debuggers

Edsger Dijkstra, a pioneer in the development of programming as a discipline, discouraged the terms “bug” and “debug,” and considered such terms harmful to the status of software engineering. They are, however, used commonly in the field. A debugger is a software program that allows a view of what is happening with the program code and data while the program is executing. Generally it runs on a PC that is connected to a special type of development microcontroller called an emulator. While debuggers can be quite useful in finding and correcting errors in code, they are not real-time, and so can actually create computer operating properly (COP) errors. However, if background debug mode (BDM) is available on the microprocessor, the debugger can be used to step through the algorithm of the program, making sure that the code is operating as expected. Intermediate and final variable values, especially those related to some analog input or output value, can be checked. Most debuggers allow multiple open windows, the setting of program execution break points in the code, and sometimes even the reflashing of the program into the microcontroller emulator. An example is the Noral debugger available for the Motorola HC12.

The software in the microcontroller can also check itself and its hardware. By programming in a checksum, or total, of designated portions of ROM and/or EEPROM, the software can check to make sure that program and data are correct. By alternately writing and reading 0x55 and 0xAA to RAM (the “checkerboard test”), the program can verify that RAM and the bus are operating properly. These startup tasks should be done with every product operation cycle.

Logic Analyzer

A logic analyzer is a device for nonintrusive monitoring and testing of the microcontroller. It is usually connected to both the microcontroller and a simulator. While the microcontroller is running its program and processing data, the simulator is simulating inputs and displaying outputs of the system. A “trigger word” can be entered into the logic analyzer. This is a bit pattern that will be on one of the buses monitored by the logic analyzer. With this trigger, the bus traffic around that point of interest can be captured and stored in the memory of the analyzer. An inverse assembler in the analyzer allows the machine code on the bus to be seen and analyzed in the form of the assembly level commands of the program. The analyzer can also capture the analog outputs of the microcontroller. This could be used to verify that the correct PWM duty cycle is being commanded. The simulator can introduce shorts or opens into the system, then the analyzer is used to see if the software correctly responds to the faults. The logic analyzer can also monitor the master loop of the system, making sure that the system completes all of its tasks within a designated time, e.g., 15 ms. An example of a logic analyzer is the Hewlett Packard HP54620.

3.10 Summary

This chapter introduced a number of topics regarding a mechatronic system. These topics included not just mechatronic input, output, and processing, but also design, development, and testing. Future chapters will cover all of this material in much greater detail.

4

Microprocessor-Based Controllers and Microelectronics

Ondrej Novak

Technical University Liberec

Ivan Dolezal

Technical University Liberec

- 4.1 Introduction to Microelectronics
- 4.2 Digital Logic
- 4.3 Overview of Control Computers
- 4.4 Microprocessors and Microcontrollers
- 4.5 Programmable Logic Controllers
- 4.6 Digital Communications

4.1 Introduction to Microelectronics

The field of microelectronics has changed dramatically during the last two decades and digital technology has governed most of the application fields in electronics. The design of digital systems is supported by thousands of different integrated circuits supplied by many manufacturers across the world. This makes both the design and the production of electronic products much easier and cost effective. The permanent growth of integrated circuit speed, scale of integration, and reduction of costs have resulted in digital circuits being used instead of classical analog solutions of controllers, filters, and (de)modulators.

The growth in computational power can be demonstrated with the following example. One single-chip microcontroller has the computational power equal to that of one 1992 vintage computer notebook. This single-chip microcontroller has the computational power equal to four 1981 vintage IBM personal computers, or to two 1972 vintage IBM 370 mainframe computers.

Digital integrated circuits are designed to be universal and are produced in large numbers. Modern integrated circuits have many upgraded features from earlier designs, which allow for “user-friendlier” access and control. As the parameters of Integrated circuits (ICs) influence not only the individually designed IC, but all the circuits that must cooperate with it, a roadmap of the future development of IC technology is updated every year. From this roadmap we can estimate future parameters of the ICs, and adapt our designs to future demands. The relative growth of the number of integrated transistors on a chip is relatively stable. In the case of memory elements, it is equal to approximately 1.5 times the current amount. In the case of other digital ICs, it is equal to approximately 1.35 times the current amount.

In digital electronics, we use quantities called logical values instead of the analog quantities of voltage and current. Logical variables usually correspond to the voltage of the signal, but they have only two values: $\log.1$ and $\log.0$. If a digital circuit processes a logical variable, a correct value is recognized because between the logical value voltages there is a gap (see Fig. 4.1). We can arbitrarily improve the resolution of signals by simply using more bits.

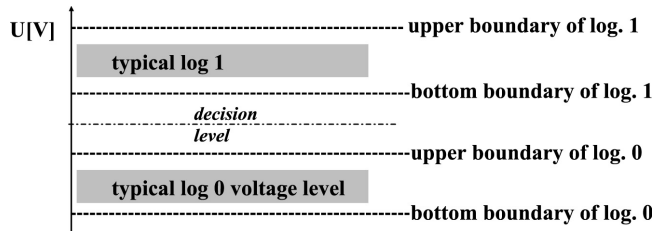

FIGURE 4.1 Voltage levels and logical values correspondence.

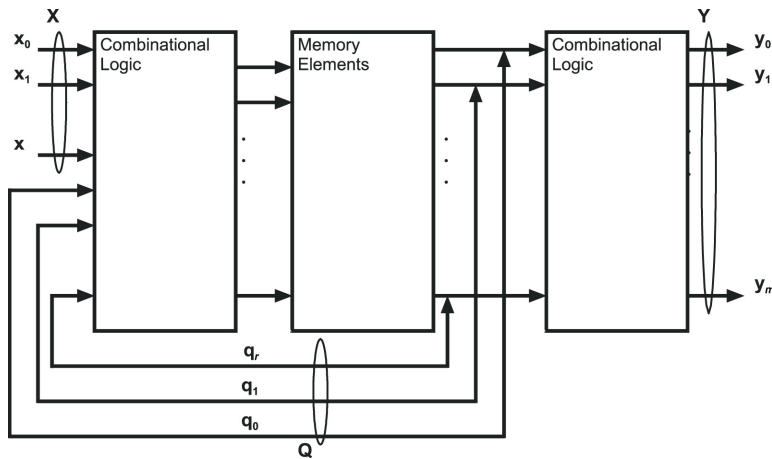

FIGURE 4.2 A finite state automaton: X —input binary vector, Y —output binary vector, Q —internal state vector.

4.2 Digital Logic

Digital circuits are composed of logic gates, such as elementary electronic circuits operating in only two states. These gates operate in such a way that the resulting logical value corresponds to the resulting value of the Boolean algebra statements. This means that with the help of gates we can realize every logical and arithmetical operation. These operations are performed in combinational circuits for which the resulting value is dependent only on the actual state of the inputs variables. Of course, logic gates are not enough for automata construction. For creating an automaton, we also need some memory elements in which we capture the responses of the arithmetical and logical blocks.

A typical scheme of a digital finite state automaton is given in Fig. 4.2. The automata can be constructed from standard ICs containing logic gates, more complex combinational logic blocks and registers, counters, memories, and other standard sequential ICs assembled on a printed circuit board. Another possibility is to use application specific integrated circuits (ASIC), either programmable or full custom, for a more advanced design. This approach is suitable for designs where fast hardware solutions are preferred. Another possibility is to use microcontrollers that are designed to serve as universal automata, which function can be specified by memory programming.

4.3 Overview of Control Computers

Huge, complex, and power-consuming single-room mainframe computers and, later, single-case mini-computers were primarily used for scientific and technical computing (e.g., in FORTRAN, ALGOL) and for database applications (e.g., in COBOL). The invention in 1971 of a universal central processing unit (CPU) in a single chip microprocessor caused a revolution in the computer technology. Beginning in



FIGURE 4.3 Example of a small mechatronic system: The ALAMBETA device for measurement of thermal properties of fabrics and plastic foils (manufactured by SENSORA, Czech Republic). It employs a unique measuring method using extra thin heat flow sensors, sample thickness measurement incorporated into a head drive, micro-processor control, and connection with a PC.

1981, multi-boxes (desktop or tower case, monitor, keyboard, mouse) or single-box (notebook) micro-computers became a daily-used personal tool for word processing, spreadsheet calculation, game playing, drawing, multimedia processing, and presentations. When connected in a local area network (LAN) or over the Internet, these “personal computers (PCs)” are able to exchange data and to browse the World Wide Web (WWW).

Besides these “visible” computers, many embedded microcomputers are hidden in products such as machines, vehicles, measuring instruments, telecommunication devices, home appliances, consumer electronic products (cameras, hi-fi systems, televisions, video recorders, mobile phones, music instruments, toys, air-conditioning). They are connected with sensors, user interfaces (buttons and displays), and actuators. Programmability of such controllers brings flexibility to the devices (function program choice), some kind of intelligence (fuzzy logic), and user-friendly action. It ensures higher reliability and easier maintenance, repairs, (auto)calibration, (auto)diagnostics, and introduces the possibility of their interconnection—mutual communication or hierarchical control in a whole plant or in a smart house. A photograph of an electrically operated instrument is given in [Fig. 4.3](#).

Embedded microcomputers are based on the Harvard architecture where code and data memories are split. Firmware (program code) is cross-compiled on a development system and then resides in a non-volatile memory. In this way, a single main program can run immediately after a supply is switched on. Relatively expensive and shock sensitive mechanical memory devices (hard disks) and vacuum tube monitors have been replaced with memory cards or solid state disks (if an archive memory is essential) and LED segment displays or LCDs. A PC-like keyboard can be replaced by a device/function specifically labeled key set and/or common keys (arrows, Enter, Escape) completed with numeric keys, if necessary. Such key sets, auxiliary switches, large buttons, the main switch, and display can be located in water and dust resistant operator panels.

Progress in circuit integration caused fast development of microcontrollers in the last two decades. Code memory, data memory, clock generator, and a diverse set of peripheral circuits are integrated with the CPU ([Fig. 4.4](#)) to insert such complete single-chip microcomputers into an application specific PCB.

Digital signal processors (DSPs) are specialized embedded microprocessors with some on-chip peripherals but with external ADC/DAC, which represent the most important input/output channel. DSPs have a parallel computing architecture and a fixed point or floating point instruction set optimized for typical signal processing operations such as discrete transformations, filtering, convolution, and coding. We can find DSPs in applications like sound processing/generation, sensor (e.g., vibration) signal analysis,

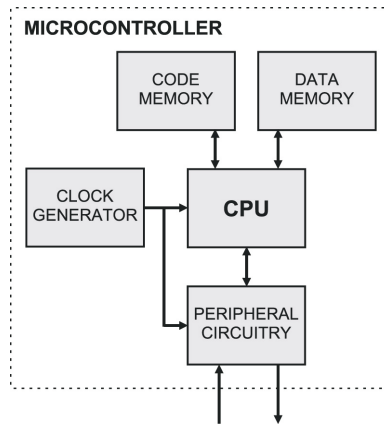

FIGURE 4.4 Block diagram of a microcontroller.

telecommunications (e.g., bandpass filter and digital modulation/demodulation in mobile phones, communication transceivers, modems), and vector control of AC motors.

Mass production (i.e., low cost), wide-spread knowledge of operation, comprehensive access to software development and debugging tools, and millions of ready-to-use code lines make PCs useful for computing-intensive measurement and control applications, although their architecture and operating systems are not well suited for this purpose.

As a result of computer expansion, there exists a broad spectrum of computing/processing means from powerful workstations, top-end PCs and VXI systems (64/32 bits, over 1000 MFLOPS/MIPS, 1000 MB of memory, input power over 100 W, cost about \$10,000), downwards to PC-based computer cards/modules (32 bits, 100–300 MFLOPS/MIPS, 10–100 MB, cost less than \$1000). Microprocessor cards/modules (16/8 bits, 10–30 MIPS, 1 MB, cost about \$100), complex microcontroller chips (16/8 bits, 10–30 MIPS, 10–100 KB, cost about \$10), and simple 8-pin microcontrollers (8 bits, 1–5 MIPS, 1 KB, 10 mW, cost about \$1) are also available for very little money.

4.4 Microprocessors and Microcontrollers

There is no strict border between microprocessors and microcontrollers because certain chips can access external code and/or data memory (microprocessor mode) and are equipped with particular peripheral components.

Some microcontrollers have an internal RC oscillator and do not need an external component. However, an external quartz or ceramic resonator or RC network is frequently connected to the built-in, active element of the clock generator. Clock frequency varies from 32 kHz (extra low power) up to 75 MHz. Another auxiliary circuit generates the reset signal for an appropriate period after a supply is turned on. Watchdog circuits generate chip reset when a periodic retriggering signal does not come in time due to a program problem. There are several modes of consumption reduction activated by program instructions.

Complexity and structure of the interrupt system (total number of sources and their priority level selection), settings of level/edge sensitivity of external sources and events in internal (i.e., peripheral) sources, and handling of simultaneous interrupt events appear as some of the most important criteria of microcontroller taxonomy.

Although 16- and 32-bit microcontrollers are engaged in special, demanding applications (servo-unit control), most applications employ 8-bit chips. Some microcontrollers can internally operate with a 16-bit or even 32-bit data only in fixed-point range—microcontrollers are not provided with floating point unit (FPU). New microcontroller families are built on RISC (Reduced Instruction Set) core executing due to pipelining one instruction per few clock cycles or even per each cycle.

One can find further differences in addressing modes, number of direct accessible registers, and type of code memory (ranging from 1 to 128 KB) that are important from the view of firmware development. Flash memory enables quick and even in-system programming (ISP) using 3–5 wires, whereas classical EPROM makes chips more expensive due to windowed ceramic packaging. Some microcontrollers have built-in boot and debug capability to load code from a PC into the flash memory using UART (Universal Asynchronous Receiver/Transmitter) and RS-232C serial line. OTP (One Time Programmable) EPROM or ROM appear effective for large production series. Data EEPROM (from 64 B to 4 KB) for calibration constants, parameter tables, status storage, and passwords that can be written by firmware stand beside the standard SRAM (from 32 B to 4 KB).

The range of peripheral components is very wide. Every chip has bidirectional I/O (input/output) pins associated in 8-bit ports, but they often have an alternate function. Certain chips can set an input decision level (TTL, MOS, or Schmitt trigger) and pull-up or pull-down current sources. Output drivers vary in open collector or tri-state circuitry and maximal currents.

At least one 8-bit timer/counter (usually provided with a prescaler) counts either external events (optional pulses from an incremental position sensor) or internal clocks, to measure time intervals, and periodically generates an interrupt or variable baud rate for serial communication. General purpose 16-bit counters and appropriate registers form either capture units to store the time of input transients or compare units that generate output transients as a stepper motor drive status or PWM (pulse width modulation) signal. A real-time counter (RTC) represents a special kind of counter that runs even in sleep mode. One or two asynchronous and optionally synchronous serial interfaces (UART/USART) communicate with a master computer while other serial interfaces like SPI, CAN, and I²C control other specific chips employed in the device or system.

Almost every microcontroller family has members that are provided with an A/D converter and a multiplexer of single-ended inputs. Input range is usually unipolar and equal to supply voltage or rarely to the on-chip voltage reference. The conversion time is given by the successive approximation principle of ADC, and the effective number of bits (ENOB) usually does not reach the nominal resolution 8, 10, or 12 bits.

There are other special interface circuits, such as field programmable gate array (FPGA), that can be configured as an arbitrary digital circuit.

Microcontroller firmware is usually programmed in an assembly language or in C language. Many software tools, including chip simulators, are available on websites of chip manufacturers or third-party companies free of charge. A professional integrated development environment and debugging hardware (in-circuit emulator) is more expensive (thousands of dollars). However, smart use of an inexpensive ROM simulator in a microprocessor system or a step-by-step development cycle using an ISP programmer of flash microcontroller can develop fairly complex applications.

4.5 Programmable Logic Controllers

A programmable logic controller (PLC) is a microprocessor-based control unit designed for an industrial installation (housing, terminals, ambient resistance, fault tolerance) in a power switchboard to control machinery or an industrial process. It consists of a CPU with memories and an I/O interface housed either in a compact box or in modules plugged in a frame and connected with proprietary buses. The compact box starts with about 16 I/O interfaces, while the module design can have thousands of I/O interfaces. Isolated inputs usually recognize industrial logic, 24 V DC or main AC voltage, while outputs are provided either with isolated solid state switches (24 V for solenoid valves and contactors) or with relays. Screw terminal boards represent connection facilities, which are preferred in PLCs to wire them to the controlled systems. I/O logical levels can be indicated with LEDs near to terminals.

Since PLCs are typically utilized to replace relays, they execute Boolean (bit, logical) operations and timer/counter functions (a finite state automaton). Analog I/O, integer or even floating point arithmetic, PWM outputs, and RTC are implemented in up-to-date PLCs. A PLC works by continually scanning a program, such as machine code, that is interpreted by an embedded microprocessor (CPU). The scan time is the time it takes to check the input status, to execute all branches (all individual rungs of a ladder

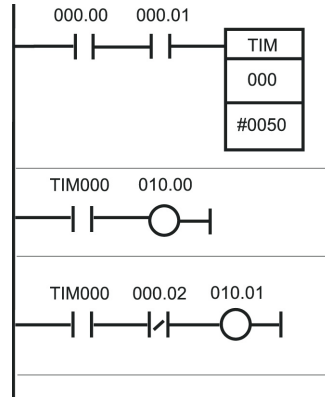

FIGURE 4.5 Example of PLC ladder diagram: 000.xx/010.xx—address group of inputs/outputs, TIM000—timer delays 5 s. 000.00—normally open input contact, 000.02—normally closed input contact.

diagram) of the program using internal (state) bit variables if any, and to update the output status. The scan time is dependent on the complexity of the program (milliseconds or tens of msec). The next scan operation either follows the previous one immediately (free running) or starts periodically.

Programming languages for PLCs are described in IEC-1131-3 nomenclature:

- LD—ladder diagram (see Fig. 4.5)
- IL—instruction list (an assembler)
- SFC—sequential function chart (usually called by the proprietary name GRAFCET)
- ST—structured text (similar to a high level language)
- FBD—function block diagram

PLCs are programmed using cross-compiling and debugging tools running on a PC or with programming terminals (usually using IL), both connected with a serial link. Remote operator panels can serve as a human-to-machine interface. A new alternate concept (called SoftPLC) consists of PLC-like I/O modules controlled by an industrial PC, built in a touch screen operator panel.

4.6 Digital Communications

Intercommunication among mechatronics subsystems plays a key role in their engagement of applications, both of fixed and flexible configuration (a car, a hi-fi system, a fixed manufacturing line versus a flexible plant, a wireless pico-net of computer peripheral devices). It is clear that digital communication depends on the designers demands for the amount of transferred data, the distance between the systems, and the requirements on the degree of data reliability and security.

The signal is represented by alterations of amplitude, frequency, or phase. This is accomplished by changes in voltage/current in metallic wires or by electromagnetic waves, both in radiotransmission and infrared optical transmission (either “wireless” for short distances or optical fibers over fairly long distances). Data rate or bandwidth varies from 300 b/s (teleprinter), 3.4 kHz (phone), 144 kb/s (ISDN) to tens of Mb/s (ADSL) on a metallic wire (subscriber line), up to 100 Mb/s on a twisted pair (LAN), about 30–100 MHz on a microwave channel, 1 GHz on a coaxial cable (trunk cable network, cable TV), and up to tens of Gb/s on an optical cable (backbone network).

Data transmission employs complex methods of digital modulation, data compression, and data protection against loss due to noise interference, signal distortion, and dropouts. Multilayer standard protocols (ISO/OSI 7-layer reference model or Internet 4-layer group of protocols including well-known TCP/IP), “partly hardware, partly software realized,” facilitate an understanding between communication systems. They not only establish connection on a utilizable speed, check data transfer, format and compress data, but can make communication transparent for an application. For example, no difference can be seen between local and remote data sources. An example of a multilayer communication concept is depicted in Fig. 4.6.

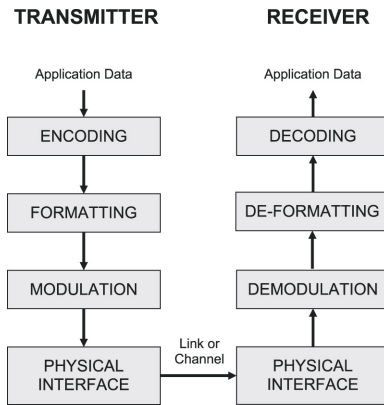

FIGURE 4.6 Example of multilayer communication.

Depending on the number of users, the communication is done either point-to-point (RS-232C from PC COM port to an instrument), point-to-multipoint (buses, networks), or even as a broadcasting (radio). Data are transferred using either switched connection (telephone network) or packet switching (computer networks, ATM). Bidirectional transmission can be full duplex (phone, RS-232C) or semi-duplex (most of digital networks). Concerning the link topology, a star connection or a tree connection employs a device (“master”) mastering communication in the main node(s). A ring connection usually requires Token Passing method and a bus communication is controlled with various methods such as Master-Slave pooling, with or without Token Passing, or by using an indeterministic access (CSMA/CD in Ethernet).

An LPT PC port, SCSI for computer peripherals, and GPIB (IEEE-488) for instrumentation serve as examples of parallel (usually 8-bit) communication available for shorter distances (meters). RS-232C, RS-485, I²C, SPI, USB, and Firewire (IEEE-1394) represent serial communication, some of which can bridge long distance (up to 1 km). Serial communication can be done either asynchronously using start and stop bits within transfer frame or synchronously using included synchronization bit patterns, if necessary. Both unipolar and bipolar voltage levels are used to drive either unbalanced lines (LPT, GPIB vs. RS-232C) or balanced twisted-pair lines (CAN vs. RS-422, RS-485).

5

An Introduction to Micro- and Nanotechnology

Michael Goldfarb

Vanderbilt University

Alvin Strauss

Vanderbilt University

Eric J. Barth

Vanderbilt University

5.1 Introduction

The Physics of Scaling • General Mechanisms of
Electromechanical Transduction • Sensor and Actuator
Transduction Characteristics

5.2 Microactuators

Electrostatic Actuation • Electromagnetic Actuation

5.3 Microsensors

Strain • Pressure • Acceleration • Force • Angular Rate
Sensing (Gyroscopes)

5.4 Nanomachines

5.1 Introduction

Originally arising from the development of processes for fabricating microelectronics, micro-scale devices are typically classified according not only to their dimensional scale, but their composition and manufacture. Nanotechnology is generally considered as ranging from the smallest of these micro-scale devices down to the assembly of individual molecules to form molecular devices. These two distinct yet overlapping fields of microelectromechanical systems (MEMS) and nanosystems or nanotechnology share a common set of engineering design considerations unique from other more typical engineering systems. Two major factors distinguish the existence, effectiveness, and development of micro-scale and nano-scale transducers from those of conventional scale. The first is the physics of scaling and the second is the suitability of manufacturing techniques and processes. The former is governed by the laws of physics and is thus a fundamental factor, while the latter is related to the development of manufacturing technology, which is a significant, though not fundamental, factor. Due to the combination of these factors, effective micro-scale transducers can often not be constructed as geometrically scaled-down versions of conventional-scale transducers.

The Physics of Scaling

The dominant forces that influence micro-scale devices are different from those that influence their conventional-scale counterparts. This is because the size of a physical system bears a significant influence on the physical phenomena that dictate the dynamic behavior of that system. For example, larger-scale systems are influenced by inertial effects to a much greater extent than smaller-scale systems, while smaller systems are influenced more by surface effects. As an example, consider small insects that can stand on the surface of still water, supported only by surface tension. The same surface tension is present when

humans come into contact with water, but on a human scale the associated forces are typically insignificant. The world in which humans live is governed by the same forces as the world in which these insects live, but the forces are present in very different proportions. This is due in general to the fact that inertial forces typically act in proportion to volume, and surface forces typically in proportion to surface area. Since volume varies with the third power of length and area with the second, geometrically similar but smaller objects have proportionally more area than larger objects.

Exact scaling relations for various types of forces can be obtained by incorporating dimensional analysis techniques [1–5]. Inertial forces, for example, can be dimensionally represented as $F_i = \rho L^3 \ddot{x}$, where F_i is a generalized inertia force, ρ is the density of an object, L is a generalized length, and x is a displacement. This relationship forms a single dimensionless group, given by

$$\Pi = \frac{F_i}{\rho L^3 \ddot{x}}$$

Scaling with geometric and kinematic similarity can be expressed as

$$\frac{L_s}{L_o} = \frac{x_s}{x_o} = N, \quad \frac{t_s}{t_o} = 1$$

where L represents the length scale, x the kinematic scale, t the time scale, the subscript o the original system, and the s represents the scaled system. Since physical similarity requires that the dimensionless group (Π) remain invariant between scales, the force relationship is given by $F_s/F_o = N^4$, assuming that the intensive property (density) remains invariant (i.e., $\rho_s = \rho_o$). An inertial force thus scales as N^4 , where N is the geometric scaling factor. Alternately stated, for an inertial system that is geometrically smaller by a factor of N , the force required to produce an equivalent acceleration is smaller by a factor of N^4 . A similar analysis shows that viscous forces, dimensionally represented by $F_v = \mu L \dot{x}$, scale as N^2 , assuming the viscosity μ remains invariant, and elastic forces, dimensionally represented by $F_e = ELx$, scale as N^2 , assuming the elastic modulus E remains invariant. Thus, for a geometrically similar but smaller system, inertial forces will become considerably less significant with respect to viscous and elastic forces.

General Mechanisms of Electromechanical Transduction

The fundamental mechanism for both sensing and actuation is energy transduction. The primary forms of physical electromechanical transduction can be grouped into two categories. The first is multicomponent transduction, which utilizes “action at a distance” behavior between multiple bodies, and the second is deformation-based or solid-state transduction, which utilizes mechanics-of-material phenomena such as crystalline phase changes or molecular dipole alignment. The former category includes electromagnetic transduction, which is typically based upon the Lorentz equation and Faraday’s law, and electrostatic interaction, which is typically based upon Coulomb’s law. The latter category includes piezoelectric effects, shape memory alloys, and magnetostrictive, electrostrictive, and photostrictive materials. Although materials exhibiting these properties are beginning to be seen in a limited number of research applications, the development of micro-scale systems is currently dominated by the exploitation of electrostatic and electromagnetic interactions. Due to their importance, electrostatic and electromagnetic transduction is treated separately in the sections that follow.

Sensor and Actuator Transduction Characteristics

Characteristics of concern for both microactuator and microsensor technology are repeatability, the ability to fabricate at a small scale, immunity to extraneous influences, sufficient bandwidth, and if possible, linearity. Characteristics typically of concern specifically for microactuators are achievable force, displacement, power, bandwidth (or speed of response), and efficiency. Characteristics typically of concern specifically for microsensors are high resolution and the absence of drift and hysteresis.

5.2 Microactuators

Electrostatic Actuation

The most widely utilized multicomponent microactuators are those based upon electrostatic transduction. These actuators can also be regarded as a variable capacitance type, since they operate in an analogous mode to variable reluctance type electromagnetic actuators (e.g., variable reluctance stepper motors). Electrostatic actuators have been developed in both linear and rotary forms. The two most common configurations of the linear type of electrostatic actuators are the normal-drive and tangential or comb-drive types, which are illustrated in Figs. 5.1 and 5.2, respectively. Note that both actuators are suspended by flexures, and thus the output force is equal to the electrostatic actuation force minus the elastic force required to deflect the flexure suspension. The normal-drive type of electrostatic microactuator operates in a similar fashion to a condenser microphone. In this type of drive configuration, the actuation force is given by

$$F_x = \frac{\epsilon A v^2}{2x^2}$$

where A is the total area of the parallel plates, ϵ is the permittivity of air, v is the voltage across the plates, and x is the plate separation. The actuation force of the comb-drive configuration is given by

$$F_x = \frac{\epsilon w v^2}{2d}$$

where w is the width of the plates, ϵ is the permittivity of air, v is the voltage across the plates, and d is the plate separation. Dimensional examination of both relations indicates that force is independent of geometric and kinematic scaling, that is, for an electrostatic actuator that is geometrically and kinematically reduced by a factor of N , the force produced by that actuator will be the same. Since forces associated with most other physical phenomena are significantly reduced at small scales, micro-scale electrostatic forces become significant relative to other forces. Such an observation is clearly demonstrated by the fact that all intermolecular forces are electrostatic in origin, and thus the strength of all materials is a result of electrostatic forces [6].

The maximum achievable force of multicomponent electrostatic actuators is limited by the dielectric breakdown of air, which occurs in dry air at about 0.8×10^6 V/m. Fearing [7] estimates that the upper limit for force generation in electrostatic actuation is approximately 10 N/cm^2 . Since electrostatic drives

FIGURE 5.1 Schematic of a normal-drive electrostatic actuator.

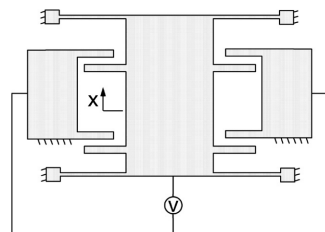
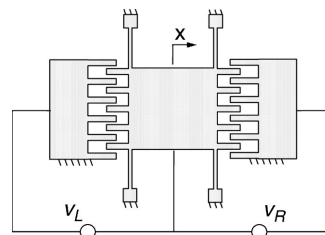

FIGURE 5.2 Comb-drive electrostatic actuator. Energizing an electrode provides motion toward that electrode.



do not have any significant actuation dynamics, and since the inertia of the moving member is usually small, the actuator bandwidth is typically quite large, on the order of a kilohertz.

The maximum achievable stroke for normal configuration actuators is limited by the elastic region of the flexure suspension and additionally by the dependence of actuation force on plate separation, as given by the above stated equations. According to Fearing, a typical stroke for a surface micromachined normal configuration actuator is on the order of a couple of microns. The achievable displacement can be increased by forming a stack of normal-configuration electrostatic actuators in series, as proposed by Bobbio et al. [8,9].

The typical stroke of a surface micromachined comb actuator is on the order of a few microns, though sometimes less. The maximum achievable stroke in a comb drive is limited primarily by the mechanics of the flexure suspension. The suspension should be compliant along the direction of actuation to enable increased displacement, but must be stiff orthogonal to this direction to avoid parallel plate contact due to misalignment. These modes of behavior are unfortunately coupled, so that increased compliance along the direction of motion entails a corresponding increase in the orthogonal direction. The net effect is that increased displacement requires increased plate separation, which results in decreased overall force.

The most common configurations of rotary electrostatic actuators are the variable capacitance motor and the wobble or harmonic drive motor, which are illustrated in Figs. 5.3 and 5.4, respectively. Both motors operate in a similar manner to the comb-drive linear actuator. The variable capacitance motor is characterized by high-speed low-torque operation. Useful levels of torque for most applications therefore require some form of significant micromechanical transmission, which do not presently exist. The rotor of the wobble motor operates by rolling along the stator, which provides an inherent harmonic-drive-type transmission and thus a significant transmission ratio (on the order of several hundred times). Note that the rotor must be well insulated to roll along the stator without electrical contact. The drawback to this approach is that the rotor motion is not concentric with respect to the stator, which makes the already difficult problem of coupling a load to a micro-shaft even more difficult.

Examples of normal type linear electrostatic actuators are those by Bobbio et al. [8,9] and Yamaguchi et al. [10]. Examples of comb-drive electrostatic actuators are those by Kim et al. [11] and Matsubara et al. [12], and a larger-scale variation by Niino et al. [13]. Examples of variable capacitance rotary electrostatic motors are those by Huang et al. [14], Mehragany et al. [15], and Trimmer and Gabriel [16].

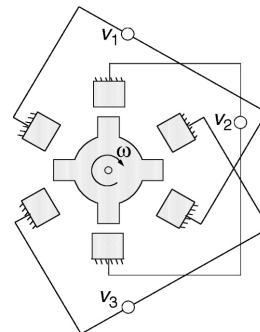

FIGURE 5.3 Variable capacitance type electrostatic motor. Opposing pairs of electrodes are energized sequentially to rotate the rotor.

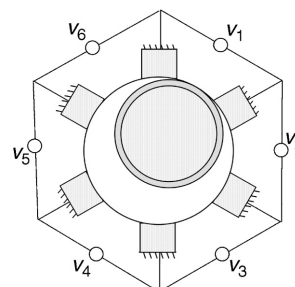

FIGURE 5.4 Harmonic drive type electrostatic motor. Adjacent electrodes are energized sequentially to roll the (insulated) rotor around the stator.

Examples of harmonic-drive motors are those by Mehragany et al. [17,18], Price et al. [19], Trimmer and Jebens [20,21], and Furuhashi et al. [22]. Electrostatic microactuators remain a subject of research interest and development, and as such are not yet available on the general commercial market.

Electromagnetic Actuation

Electromagnetic actuation is not as omnipresent at the micro-scale as at the conventional-scale. This probably is due in part to early skepticism regarding the scaling of magnetic forces, and in part to the fabrication difficulty in replicating conventional-scale designs. Most electromagnetic transduction is based upon a current carrying conductor in a magnetic field, which is described by the Lorentz equation:

$$dF = Idl \times B$$

where F is the force on the conductor, I is the current in the conductor, l is the length of the conductor, and B is the magnetic flux density. In this relation, the magnetic flux density is an intensive variable and thus (for a given material) does not change with scale. Scaling of current, however, is not as simple. The resistance of wire is given by

$$R = \frac{\rho l}{A}$$

where ρ is the resistivity of the wire (an intensive variable), l is the length, and A the cross-sectional area. If a wire is geometrically decreased in size by a factor of N , its resistance will increase by a factor of N . Since the power dissipated in the wire is I^2R , assuming the current remains constant implies that the power dissipated in the geometrically smaller wire will increase by a factor of N . Assuming the maximum power dissipation for a given wire is determined by the surface area of the wire, a wire that is smaller by a factor of N will be able to dissipate a factor of N^2 less power. Constant current is therefore a poor assumption. A better assumption is that maximum current is limited by maximum power dissipation, which is assumed to depend upon surface area of the wire. Since a wire smaller by a factor of N can dissipate a factor of N^2 less power, the current in the smaller conductor would have to be reduced by a factor of $N^{3/2}$. Incorporating this into the scaling of the Lorentz equation, an electromagnetic actuator that is geometrically smaller by a factor of N would exert a force that is smaller by a factor of $N^{5/2}$. Trimmer and Jebens have conducted a similar analysis, and demonstrated that electromagnetic forces scale as N^2 when assuming constant temperature rise in the wire, $N^{5/2}$ when assuming constant heat (power) flow (as previously described), and N^3 when assuming constant current density [23,24]. In any of these cases, the scaling of electromagnetic forces is not nearly as favorable as the scaling of electrostatic forces. Despite this, electromagnetic actuation still offers utility in microactuation, and most likely scales more favorably than does inertial or gravitational forces.

Lorentz-type approaches to microactuation utilize surface micromachined micro-coils, such as the one illustrated in Fig. 5.5. One configuration of this approach is represented by the actuator of Inoue et al. [25],

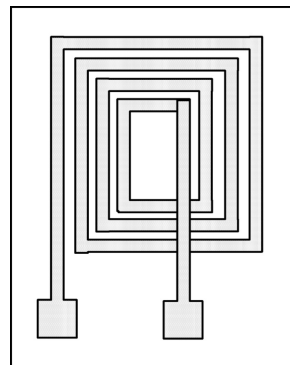

FIGURE 5.5 Schematic of surface micromachined microcoil for electromagnetic actuation.

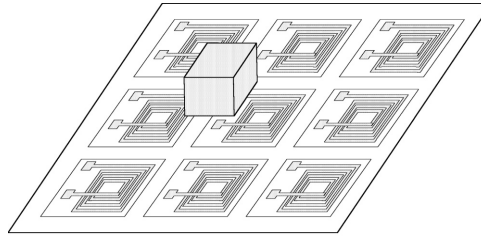

FIGURE 5.6 Microcoil array for planar positioning of a permanent micromagnet, as described by Inoue et al. [25]. Each coil produces a field, which can either attract or repel the permanent magnet, as determined by the direction of current. The magnet does not levitate, but rather slides on the insulated surface.

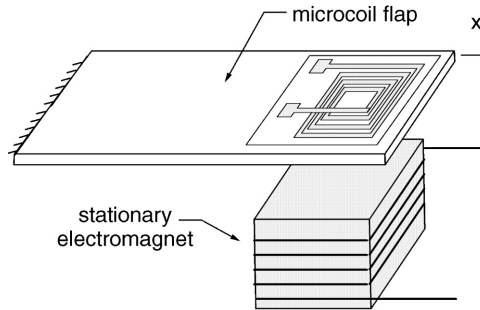

FIGURE 5.7 Cantilevered microcoil flap as described by Liu et al. [26]. The interaction between the energized coil and the stationary electromagnet deflects the flap upward or downward, depending on the direction of current through the microcoil.

which utilizes current control in an array of microcoils to position a permanent micro-magnet in a plane, as illustrated in Fig. 5.6. Another Lorentz-type approach is illustrated by the actuator of Liu et al. [26], which utilizes current control of a cantilevered microcoil flap in a fixed external magnetic field to effect deflection of the flap, as shown in Fig. 5.7. Liu reported deflections up to $500\ \mu\text{m}$ and a bandwidth of approximately $1000\ \text{Hz}$ [26]. Other examples of Lorentz-type nonrotary actuators are those by Shinozawa et al. [27], Wagner and Benecke [28], and Yanagisawa et al. [29]. A purely magnetic approach (i.e., not fundamentally electromagnetic) is the work of Judy et al. [30], which in essence manipulates a flexure-suspended permanent micromagnet by controlling an external magnetic field.

Ahn et al. [31] and Guckel et al. [32] have both demonstrated planar rotary variable-reluctance type electromagnetic micromotors. A variable reluctance approach is advantageous because the rotor does not require commutation and need not be magnetic. The motor of Ahn et al. incorporates a 12-pole stator and 10-pole rotor, while the motor of Guckel et al. utilizes a 6-pole stator and 4-pole rotor. Both incorporate rotors of approximately $500\ \mu\text{m}$ diameter. Guckel reports (no load) rotor speeds above $30,000\ \text{rev/min}$, and Ahn estimates maximum stall torque at $1.2\ \mu\text{N}\cdot\text{m}$. As with electrostatic microactuators, microfabricated electromagnetic actuators likewise remain a subject of research interest and development and as such are not yet available on the general commercial market.

5.3 Microsensors

Since microsensors do not transmit power, the scaling of force is not typically significant. As with conventional-scale sensing, the qualities of interest are high resolution, absence of drift and hysteresis, achieving a sufficient bandwidth, and immunity to extraneous effects not being measured.

Microsensors are typically based on either measurement of mechanical strain, measurement of mechanical displacement, or on frequency measurement of a structural resonance. The former two types

are in essence analog measurements, while the latter is in essence a binary-type measurement, since the sensed quantity is typically the frequency of vibration. Since the resonant-type sensors measure frequency instead of amplitude, they are generally less susceptible to noise and thus typically provide a higher resolution measurement. According to Guckel et al., resonant sensors provide as much as one hundred times the resolution of analog sensors [33]. They are also, however, more complex and are typically more difficult to fabricate.

The primary form of strain-based measurement is piezoresistive, while the primary means of displacement measurement is capacitive. The resonant sensors require both a means of structural excitation as well as a means of resonant frequency detection. Many combinations of transduction are utilized for these purposes, including electrostatic excitation, capacitive detection, magnetic excitation and detection, thermal excitation, and optical detection.

Strain

Many microsensors are based upon strain measurement. The primary means of measuring strain is via piezoresistive strain gages, which is an analog form of measurement. Piezoresistive strain gages, also known as semiconductor gages, change resistance in response to a mechanical strain. Note that piezoelectric materials can also be utilized to measure strain. Recall that mechanical strain will induce an electrical charge in a piezoelectric ceramic. The primary problem with using a piezoelectric material, however, is that since measurement circuitry has limited impedance, the charge generated from a mechanical strain will gradually leak through the measurement impedance. A piezoelectric material therefore cannot provide reliable steady-state signal measurement. In contrast, the change in resistance of a piezoresistive material is stable and easily measurable for steady-state signals. One problem with piezoresistive materials, however, is that they exhibit a strong strain-temperature dependence, and so must typically be thermally compensated.

An interesting variation on the silicon piezoresistor is the resonant strain gage proposed by Ikeda et al., which provides a frequency-based form of measurement that is less susceptible to noise [34]. The resonant strain gage is a beam that is suspended slightly above the strain member and attached to it at both ends. The strain gage beam is magnetically excited with pulses, and the frequency of vibration is detected by a magnetic detection circuit. As the beam is stretched by mechanical strain, the frequency of vibration increases. These sensors provide higher resolution than typical piezoresistors and have a lower temperature coefficient. The resonant sensors, however, require a complex three-dimensional fabrication technique, unlike the typical piezoresistors which require only planar techniques.

Pressure

One of the most commercially successful microsensor technologies is the pressure sensor. Silicon micro-machined pressure sensors are available that measure pressure ranges from around one to several thousand kPa, with resolutions as fine as one part in ten thousand. These sensors incorporate a silicon micromachined diaphragm that is subjected to fluid (i.e., liquid or gas) pressure, which causes dilation of the diaphragm. The simplest of these utilize piezoresistors mounted on the back of the diaphragm to measure deformation, which is a function of the pressure. Examples of these devices are those by Fujii et al. [35] and Mallon et al. [36]. A variation of this configuration is the device by Ikeda et al. Instead of a piezoresistor to measure strain, an electromagnetically driven and sensed resonant strain gage, as discussed in the previous section, is utilized [37]. Still another variation on the same theme is the capacitive measurement approach, which measures the capacitance between the diaphragm and an electrode that is rigidly mounted and parallel to the diaphragm. An example of this approach is by Nagata et al. [38]. A more complex approach to pressure measurement is that by Stemme and Stemme, which utilizes resonance of the diaphragm to detect pressure [39]. In this device, the diaphragm is capacitively excited and optically detected. The pressure imposes a mechanical load on the diaphragm, which increases the stiffness and, in turn, the resonant frequency.

Acceleration

Another commercially successful microsensor is the silicon microfabricated accelerometer, which in various forms can measure acceleration ranges from well below one to around a thousand meters per square second (i.e., sub- g to several hundred g 's), with resolutions of one part in 10,000. These sensors incorporate a micromachined suspended proof mass that is subjected to an inertial force in response to an acceleration, which causes deflection of the supporting flexures. One means of measuring the deflection is by utilizing piezoresistive strain gages mounted on the flexures. The primary disadvantage to this approach is the temperature sensitivity of the piezoresistive gages. An alternative to measuring the deflection of the proof mass is via capacitive sensing. In these devices, the capacitance is measured between the proof mass and an electrode that is rigidly mounted and parallel. Examples of this approach are those by Boxenhorn and Greiff [40], Leuthold and Rudolf [41], and Seidel et al. [42]. Still another means of measuring the inertial force on the proof mass is by measuring the resonant frequency of the supporting flexures. The inertial force due to acceleration will load the flexure, which will alter its resonant frequency. The frequency of vibration is therefore a measure of the acceleration. These types of devices utilize some form of transduction to excite the structural resonance of the supporting flexures, and then utilize some other measurement technique to detect the frequency of vibration. Examples of this type of device are those by Chang et al. [43], which utilize electrostatic excitation and capacitive detection, and by Satchell and Greenwood [44], which utilize thermal excitation and piezoresistive detection. These types of accelerometers entail additional complexity, but typically offer improved measurement resolution. Still another variation of the micro-accelerometer is the force-balanced type. This type of device measures position of the proof mass (typically by capacitive means) and utilizes a feedback loop and electrostatic or electromagnetic actuation to maintain zero deflection of the mass. The acceleration is then a function of the actuation effort. These devices are characterized by a wide bandwidth and high sensitivity, but are typically more complex and more expensive than other types. Examples of force-balanced devices are those by Chau et al. [45], and Kuehnel and Sherman [46], both of which utilize capacitive sensing and electrostatic actuation.

Force

Silicon microfabricated force sensors incorporate measurement approaches much like the microfabricated pressure sensors and accelerometers. Various forms of these force sensors can measure forces ranging on the order of millinewtons to newtons, with resolutions of one part in 10,000. Mechanical sensing typically utilizes a beam or a flexure support which is elastically deflected by an applied force, thereby transforming force measurement into measurement of strain or displacement, which can be accomplished by piezoresistive or capacitive means. An example of this type of device is that of Despont et al., which utilizes capacitive measurement [47]. Higher resolution devices are typically of the resonating beam type, in which the applied force loads a resonating beam in tension. Increasing the applied tensile load results in an increase in resonant frequency. An example of this type of device is that of Blom et al. [48].

Angular Rate Sensing (Gyroscopes)

A conventional-scale gyroscope utilizes the spatial coupling of the angular momentum-based gyroscopic effect to measure angular rate. In these devices, a disk is spun at a constant high rate about its primary axis, so that when the disk is rotated about an axis not colinear with the primary (or spin) axis, a torque results in an orthogonal direction that is proportional to the angular velocity. These devices are typically mounted in gimbals with low-friction bearings, incorporate motors that maintain the spin velocity, and utilize strain gages to measure the gyroscopic torque (and thus angular velocity). Such a design would not be appropriate for a microsensor due to several factors, some of which include the diminishing effect of inertia (and thus momentum) at small scales, the lack of adequate bearings, the lack of appropriate micromotors, and the lack of an adequate three-dimensional microfabrication processes. Instead, micro-scale angular rate sensors are of the vibratory type, which incorporate Coriolis-type effects rather than

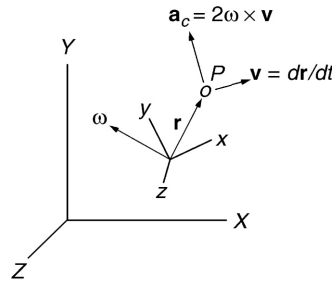

FIGURE 5.8 Illustration of Coriolis acceleration, which results from translation within a reference frame that is rotating with respect to an inertial reference frame.

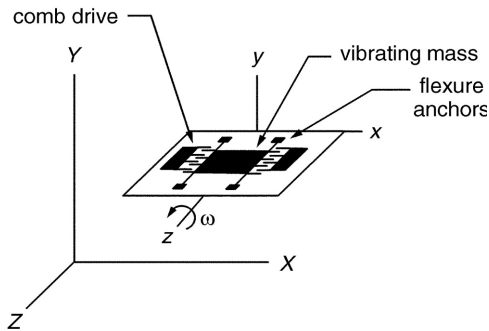

FIGURE 5.9 Schematic of a vibratory gyroscope.

the angular momentum-based gyroscopic mechanics of conventional-scale devices. A Coriolis acceleration results from linear translation within a coordinate frame that is rotating with respect to an inertial reference frame. In particular, if the particle in Fig. 5.8 is moving with a velocity v within the frame xyz , and if the frame xyz is rotating with an angular velocity of ω with respect to the inertial reference frame XYZ , then a Coriolis acceleration will result equal to $\mathbf{a}_c = 2\omega \times v$. If the object has a mass m , a Coriolis inertial force will result equal to $\mathbf{F}_c = -2m\omega \times v$ (minus sign because direction is opposite \mathbf{a}_c). A vibratory gyroscope utilizes this effect as illustrated in Fig. 5.9. A flexure-suspended inertial mass is vibrated in the x -direction, typically with an electrostatic comb drive. An angular velocity about the z -axis will generate a Coriolis acceleration, and thus force, in the y -direction. If the “external” angular velocity is constant and the velocity in the x -direction is sinusoidal, then the resulting Coriolis force will be sinusoidal, and the suspended inertial mass will vibrate in the y -direction with an amplitude proportional to the angular velocity. The motion in the y -direction, which is typically measured capacitively, is thus a measure of the angular rate. Examples of these types of devices are those by Bernstein et al. [49] and Oh et al. [50]. Note that though vibration is an essential component of these devices, they are not technically resonant sensors, since they measure amplitude of vibration rather than frequency.

5.4 Nanomachines

Nanomachines are devices that range in size from the smallest of MEMS devices down to devices assembled from individual molecules [51]. This section briefly introduces energy sources, structural hierarchy, and the projected future of the assembly of nanomachines. Built from molecular components performing individual mechanical functions, the candidates for energy sources to actuate nanomachines are limited to those that act on a molecular scale. Regarding manufacture, the assembly of nanomachines is by nature a one-molecule-at-a-time operation. Although microscopy techniques are currently used for the assembly of nanostructures, self-assembly is seen as a viable means of mass production.

In a molecular device a discrete number of molecular components are combined into a supramolecular structure where each discrete molecular component performs a single function. The combined action of these individual molecules causes the device to operate and perform its various functions. Molecular devices require an energy source to operate. This energy must ultimately be used to activate the component molecules in the device, and so the energy must be chemical in nature. The chemical energy can be obtained by adding hydrogen ions, oxidants, etc., by inducing chemical reactions by the impingement of light, or by the actions of electrical current. The latter two means of energy activation, photochemical and electrochemical energy sources, are preferred since they not only provide energy for the operation of the device, but they can also be used to locate and control the device. Additionally, such energy transduction can be used to transmit data to report on the performance and status of the device. Another reason for the preference for photochemical- and electrochemical-based molecular devices is that, as these devices are required to operate in a cyclic manner, the chemical reactions that drive the system must be reversible. Since photochemical and electrochemical processes do not lead to the accumulation of products of reaction, they readily lend themselves to application in nanodevices.

Molecular devices have recently been designed that are capable of motion and control by photochemical methods. One device is a molecular plug and socket system, and another is a piston-cylinder system [51]. The construction of such supramolecular devices belongs to the realm of the chemist who is adept at manipulating molecules.

As one proceeds upwards in size to the next level of nanomachines, one arrives at devices assembled from (or with) single-walled carbon nanotubes (SWNTs) and/or multi-walled carbon nanotubes (MWNTs) that are a few nanometers in diameter. We will restrict our discussion to carbon nanotubes (CNTs) even though there is an expanding database on nanotubes made from other materials, especially bismuth. The strength and versatility of CNTs make them superior tools for the nanomachine design engineer. They have high electrical conductivity with current carrying capacity of a billion amperes per square centimeter. They are excellent field emitters at low operating voltages. Moreover, CNTs emit light coherently and this provides for an entire new area of holographic applications. The elastic modulus of CNTs is the highest of all materials known today [52]. These electrical properties and extremely high mechanical strength make MWNTs the ultimate atomic force microscope probe tips. CNTs have the potential to be used as efficient molecular assembly devices for manufacturing nanomachines one atom at a time.

Two obvious nanotechnological applications of CNTs are nanobearings and nanosprings. Zettl and Cumings [53] have created MWNT-based linear bearings and constant force nanosprings. CNTs may potentially form the ultimate set of nanometer-sized building blocks, out of which nanomachines of all kinds can be built. These nanomachines can be used in the assembly of nanomachines, which can then be used to construct machines of all types and sizes. These machines can be competitive with, or perhaps surpass existing devices of all kinds.

SWNTs can also be used as electromechanical actuators. Baughman et al. [54] have demonstrated that sheets of SWNTs generate larger forces than natural muscle and larger strains than high-modulus ferroelectrics. They have predicted that actuators using optimized SWNT sheets may provide substantially higher work densities per cycle than any other known actuator. Kim and Lieber [55] have built SWNT and MWNT nanotweezers. These nanoscale electromechanical devices were used to manipulate and interrogate nanostructures. Electrically conducting CNTs were attached to electrodes on pulled glass micropipettes. Voltages applied to the electrodes opened and closed the free ends of the CNTs. Kim and Lieber demonstrated the capability of the nanotweezers by grabbing and manipulating submicron clusters and nanowires. This device could be used to manipulate biological cells or even manipulate organelles and clusters within human cells. Perhaps, more importantly, these tweezers can potentially be used to assemble other nanomachines.

A wide variety of nanoscale manipulators have been proposed [56] including pneumatic manipulators that can be configured to make tentacle, snake, or multi-chambered devices. Drexler has proposed telescoping nanomanipulators for precision molecular positioning and assembly work. His manipulator has a cylindrical shape with a diameter of 35 nm and an extensible length of 100 nm. A number of six

degree of freedom Stewart platforms have been proposed [56], including one that allows strut lengths to be moved in 0.10 nm increments across a 100 nm work envelope. A number of other nanodevices including box-spring accelerometers, displacement accelerometers, pivoted gyroscopic accelerometers, and gimbaled nanogyroscopes have been proposed and designed [56].

Currently, much thought is being devoted to molecular assembly and self-replicating devices (self-replicating nanorobots). Self-assembly is arguably the only way for nanotechnology to advance in an engineering or technological sense. Assembling a billion or trillion atom device—one atom at a time—would be a great accomplishment. It would take a huge investment in equipment, labor, and time. Freitas [56] describes the infrastructure needed to construct a simple medical nanorobot: a 1- μm spherical respirocyte consisting of about 18 billion atoms. He estimates that a factory production line deploying a coordinated system of 100 macroscale scanning probe microscope (SPM) assemblers, where each assembler is capable of depositing one atom per second on a convergently-assembled workpiece, would result in a manufacturing throughput of two nanorobots per decade. If one conjectures about enormous increases in assembler manufacturing rates even to the extent of an output of one nanorobot per minute, it would take two million years to build the first cubic centimeter therapeutic dosage of nanorobots. Thus, it is clear that the future of medical nanotechnology and nanoengineering lies in the direction of self-assembly and self-replication.

References

1. Bridgman, P. W., *Dimensional Analysis*, 2nd Ed., Yale University Press, 1931.
2. Buckingham, E., "On physically similar systems: illustrations of the use of dimensional equations," *Physical Review*, 4(4):345–376, 1914.
3. Huntley, H. E., *Dimensional Analysis*, Dover Publications, 1967.
4. Langhaar, H. L., *Dimensional Analysis and Theory of Models*, John Wiley and Sons, 1951.
5. Taylor, E. S., *Dimensional Analysis for Engineers*, Oxford University Press, 1974.
6. Israelachvili, J. N., *Intermolecular and Surface Forces*, Academic Press, 1985, pp. 9–10.
7. Fearing, R. S., "Microactuators for microrobots: electric and magnetic," *Workshop on Micromechanics, IEEE International Conference on Robotics and Automation*, 1997.
8. Bobbio, S. M., Keelam, M. D., Dudley, B. W., Goodwin-Hohansson, S., Jones, S. K., Jacobson, J. D., Tranjan, F. M., Dubois, T. D., "Integrated force arrays," *Proceedings of the IEEE Micro Electro Mechanical Systems*, 149–154, 1993.
9. Jacobson, J. D., Goodwin-Johansson, S. H., Bobbio, S. M., Bartlett, C. A., Yadon, L. N., "Integrated force arrays: theory and modeling of static operation," *Journal of Microelectromechanical Systems*, 4(3):139–150, 1995.
10. Yamaguchi, M., Kawamura, S., Minami, K., Esashi, M., "Distributed electrostatic micro actuators," *Proceedings of the IEEE Micro Electro Mechanical Systems*, 18–23, 1993.
11. Kim, C. J., Pisano, A. P., Muller, R. S., "Silicon-processed overhanging microgripper," *Journal of Microelectromechanical Systems*, 1(1):31–36, 1992.
12. Matsubara, T., Yamaguchi, M., Minami, K., Esashi, M., "Stepping electrostatic microactuator," *International Conference on Solid-State Sensor and Actuators*, 50–53, 1991.
13. Niino, T., Egawa, S., Kimura, H., Higuchi, T., "Electrostatic artificial muscle: compact, high-power linear actuators with multiple-layer structures," *Proceedings of the IEEE Conference on Micro Electro Mechanical Systems*, 130–135, 1994.
14. Huang, J. B., Mao, P. S., Tong, Q. Y., Zhang, R. Q., "Study on silicon electrostatic and electroquasi-static micromotors," *Sensors and Actuators*, 35:171–174, 1993.
15. Mehragany, M., Bart, S. F., Tavrow, L. S., Lang, J. H., Senturia, S. D., Schlecht, M. F., "A study of three microfabricated variable-capacitance motors," *Sensors and Actuators*, 173–179, 1990.
16. Trimmer, W., Gabriel, K., "Design considerations for a practical electrostatic micromotor," *Sensors and Actuators*, 11:189–206, 1987.

17. Mehregany, M., Nagarkar, P., Senturia, S. D., Lang, J. H., "Operation of microfabricated harmonic and ordinary side-drive motors," *Proceeding of the IEEE Conference on Micro Electro Mechanical Systems*, 1–8, 1990.
18. Dhuler, V. R., Mehregany, M., Phillips, S. M., "A comparative study of bearing designs and operational environments for harmonic side-drive micromotors," *IEEE Transactions on Electron Devices*, 40(11):1985–1989, 1993.
19. Price, R. H., Wood, J. E., Jacobsen, S. C., "Modeling considerations for electrostatic forces in electrostatic microactuators," *Sensors and Actuators*, 20:107–114, 1989.
20. Trimmer, W., Jebens, R., "An operational harmonic electrostatic motor," *Proceeding of the IEEE Conference on Micro Electro Mechanical Systems*, 13–16, 1989.
21. Trimmer, W., Jebens, R., "Harmonic electrostatic motors," *Sensors and Actuators*, 20:17–24, 1989.
22. Furuhashi, T., Hirano, T., Lane, L. H., Fontana, R. E., Fan, L. S., Fujita, H., "Outer rotor surface micromachined wobble micromotor," *Proceeding of the IEEE Conference on Micro Electro Mechanical Systems*, 161–166, 1993.
23. Trimmer, W., Jebens, R., "Actuators for microrobots," *IEEE Conference on Robotics and Automation*, 1547–1552, 1989.
24. Trimmer, W., "Microrobots and micromechanical systems," *Sensors and Actuators*, 19:267–287, 1989.
25. Inoue, T., Hamasaki, Y., Shimoyama, I., Miura, H., "Micromanipulation using a microcoil array," *Proceedings of the IEEE International Conference on Robotics and Automation*, 2208–2213, 1996.
26. Liu, C., Tsao, T., Tai, Y., Ho, C., "Surface micromachined magnetic actuators," *Proceedings of the IEEE Conference on Micro Electro Mechanical Systems*, 57–62, 1994.
27. Shinozawa, Y., Abe, T., Kondo, T., "A proportional microvalve using a bi-stable magnetic actuator," *Proceedings of the IEEE Conference on Micro Electro Mechanical Systems*, 233–237, 1997.
28. Wagner, B., Benecke, W., "Microfabricated actuator with moving permanent magnet," *Proceedings of the IEEE Conference on Micro Electro Mechanical Systems*, 27–32, 1991.
29. Yanagisawa, K., Tago, A., Ohkubo, T., Kuwano, H., "Magnetic microactuator," *Proceedings of the IEEE Conference on Micro Electro Mechanical Systems*, 120–124, 1991.
30. Judy, J., Muller, R. S., Zappe, H. H., "Magnetic microactuation of polysilicon flexure structures," *Journal of Microelectromechanical Systems*, 4(4):162–169, 1995.
31. Ahn, C. H., Kim, Y. J., Allen, M. G., "A planar variable reluctance magnetic micromotor with fully integrated stator and wrapped coils," *Proceedings of the IEEE Conference on Micro Electro Mechanical Systems*, 1–6, 1993.
32. Guckel, H., Christenson, T. R., Skrobis, K. J., Jung, T. S., Klein, J., Hartojo, K. V., Widjaja, I., "A first functional current excited planar rotational magnetic micromotor," *Proceedings of the IEEE Conference on Micro Electro Mechanical Systems*, 7–11, 1993.
33. Guckel, H., Sneigowski, J. J., Christenson, T. R., Raissi, F., "The application of fine grained, tensile polysilicon to mechanically resonant transducers," *Sensors and Actuators*, A21–A23:346–351, 1990.
34. Ikeda, K., Kuwayama, H., Kobayashi, T., Watanabe, T., Nishikawa, T., Yoshida, T., Harada, K., "Silicon pressure sensor integrates resonant strain gauge on diaphragm," *Sensors and Actuators*, A21–A23:146–150, 1990.
35. Fujii, T., Gotoh, Y., Kuroyanagi, S., "Fabrication of microdiaphragm pressure sensor utilizing micromachining," *Sensors and Actuators*, A34:217–224, 1992.
36. Mallon, J., Pourahmadi, F., Petersen, K., Barth, P., Vermeulen, T., Bryzek, J., "Low-pressure sensors employing bossed diaphragms and precision etch-stopping," *Sensors and Actuators*, A21–23:89–95, 1990.
37. Ikeda, K., Kuwayama, H., Kobayashi, T., Watanabe, T., Nishikawa, T., Yoshida, T., Harada, K., "Three-dimensional micromachining of silicon pressure sensor integrating resonant strain gauge on diaphragm," *Sensors and Actuators*, A21–A23:1007–1009, 1990.

38. Nagata, T., Terabe, H., Kuwahara, S., Sakurai, S., Tabata, O., Sugiyama, S., Esashi, M., "Digital compensated capacitive pressure sensor using cmos technology for low-pressure measurements," *Sensors and Actuators*, A34:173–177, 1992.
39. Stemme, E., Stemme, G., "A balanced resonant pressure sensor," *Sensors and Actuators*, A21–A23: 336–341, 1990.
40. Boxenhorn, B., Greiff, P., "Monolithic silicon accelerometer," *Sensors and Actuators*, A21–A23:273–277, 1990.
41. Leuthold, H., Rudolf, F., "An ASIC for high-resolution capacitive microaccelerometers," *Sensors and Actuators*, A21–A23:278–281, 1990.
42. Seidel, H., Riedel, H., Kolbeck, R., Muck, G., Kupke, W., Koniger, M., "Capacitive silicon accelerometer with highly symmetrical design," *Sensors and Actuators*, A21–A23:312–315, 1990.
43. Chang, S. C., Putty, M. W., Hicks, D. B., Li, C. H., Howe, R. T., "Resonant-bridge two-axis micro-accelerometer," *Sensors and Actuators*, A21–A23:342–345, 1990.
44. Satchell, D. W., Greenwood, J. C., "A thermally-excited silicon accelerometer," *Sensors and Actuators*, A17:241–245, 1989.
45. Chau, K. H. L., Lewis, S. R., Zhao, Y., Howe, R. T., Bart, S. F., Marchesilli, R. G., "An integrated force- balanced capacitive accelerometer for low-g applications," *Sensors and Actuators*, A54:472–476, 1996.
46. Kuehnel, W., Sherman, S., "A surface micromachined silicon accelerometer with on-chip detection circuitry," *Sensors and Actuators*, A45:7–16, 1994.
47. Despont, Racine, G. A., Renaud, P., de Rooij, N. F., "New design of micromachined capacitive force sensor," *Journal of Micromechanics and Microengineering*, 3:239–242, 1993.
48. Blom, F. R., Bouwstra, S., Fluitman, J. H. J., Elwenspoek, M., "Resonating silicon beam force sensor," *Sensors and Actuators*, 17:513–519, 1989.
49. Bernstein, J., Cho, S., King, A. T., Kourepenis, A., Maciel, P., Weinberg, M., "A micromachined comb-drive tuning fork rate gyroscope," *IEEE Conference on Micro Electro Mechanical Systems*, 143–148, 1993.
50. Oh, Y., Lee, B., Baek, S., Kim, H., Kim, J., Kang, S., Song, C., "A surface-micromachined tunable vibratory gyroscope," *IEEE Conference on Micro Electro Mechanical Systems*, 272–277, 1997.
51. Venturi, M., Credi, A., Balzani, V., "Devices and machines at the molecular level," *Electronic Properties of Novel Materials, AIP Conf. Proc.*, 544:489–494, 2000.
52. Ajayan, P. M., Charlier, J. C., Rinzler, A. G., "PNAS," 96:14199–14200, 1999.
53. Zettl, A., Cumings, J., "Sharpened nanotubes, nanobearings and nanosprings," *Electronic Properties of Novel Materials, AIP Conf. Proc.*, 544:526–531, 2000.
54. Baughman, R. H., et al., "Carbon nanotube actuators," *Science*, 284:1340–1344, 1999.
55. Kim, P., Lieber, C. M., "Nanotube nanotweezers," *Science*, 286:2148–2150, 1999.
56. Freitas, R. A., "Nanomedicine," Vol. 1, *Landes Bioscience*, Austin, 1999.

6

Mechatronics: New Directions in Nano-, Micro-, and Mini-Scale Electromechanical Systems Design, and Engineering Curriculum Development

- 6.1 Introduction
- 6.2 Nano-, Micro-, and Mini-Scale Electromechanical Systems and Mechatronic Curriculum
- 6.3 Mechatronics and Modern Engineering
- 6.4 Design of Mechatronic Systems
- 6.5 Mechatronic System Components
- 6.6 Systems Synthesis, Mechatronics Software, and Simulation
- 6.7 Mechatronic Curriculum
- 6.8 Introductory Mechatronic Course
- 6.9 Books in Mechatronics
- 6.10 Mechatronic Curriculum Developments
- 6.11 Conclusions: Mechatronics Perspectives

Sergey Edward Lyshevski
Purdue University Indianapolis

6.1 Introduction

Modern engineering encompasses diverse multidisciplinary areas. Therefore, there is a critical need to identify new directions in research and engineering education addressing, pursuing, and implementing new meaningful and pioneering research initiatives and designing the engineering curriculum. By integrating various disciplines and tools, mechatronics provides multidisciplinary leadership and supports the current gradual changes in academia and industry. There is a strong need for an advanced research in mechatronics and a curriculum reform for undergraduate and graduate programs. Recent research developments and drastic technological advances in electromechanical motion devices, power electronics, solid-state devices, microelectronics, micro- and nanoelectromechanical systems (MEMS and NEMS), materials and packaging, computers, informatics, system intelligence, microprocessors and

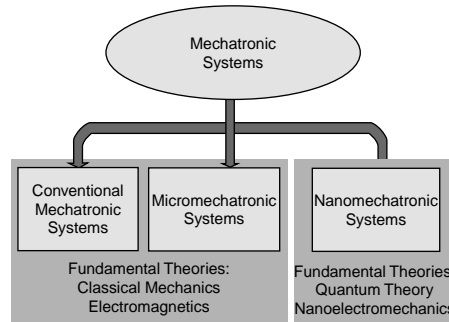

FIGURE 6.1 Classification and fundamental theories applied in mechatronic systems.

DSPs, signal and optical processing, computer-aided-design tools, and simulation environments have brought new challenges to the academia. As a result, many scientists are engaged in research in the area of mechatronics, and engineering schools have revised their curricula to offer the relevant courses in mechatronics.

Mechatronic systems are classified as:

1. conventional mechatronic systems,
2. microelectromechanical-micromechatronic systems (MEMS), and
3. nanoelectromechanical-nanomechatronic systems (NEMS).

The operational principles and basic foundations of conventional mechatronic systems and MEMS are the same, while NEMS can be studied using different concepts and theories. In particular, the designer applies the classical mechanics and electromagnetics to study conventional mechatronic systems and MEMS. Quantum theory and nanoelectromechanics are applied for NEMS, see Fig. 6.1.

One weakness of the computer, electrical, and mechanical engineering curricula is the well-known difficulties to achieving sufficient background, knowledge, depth, and breadth in integrative electromechanical systems areas to solve complex multidisciplinary engineering problems. Mechatronics introduces the subject matter, multidisciplinary areas, and disciplines (e.g., electrical, mechanical, and computer engineering) from unified perspectives through the electromechanical theory fundamentals (research) and designed sequence of mechatronic courses within an electromechanical systems (mechatronic) track or program (curriculum). This course sequence can be designed based upon the program objectives, strength, and goals. For different engineering programs (e.g., electrical, mechanical, computer, aerospace, material), the number of mechatronic courses, contents, and coverage are different because mechatronic courses complement the basic curriculum. However, the ultimate goal is the same: educate and prepare a new generation of students and engineers to solve a wide spectrum of engineering problems.

Mechatronics is an important part of modern confluent engineering due to integration, interaction, interpretation, relevance, and systematization features. Efficient and effective means to assess the current trends in modern engineering with assessments analysis and outcome prediction can be approached through the mechatronic paradigm. The multidisciplinary mechatronic research and educational activities, combined with the variety of active student learning processes and synergetic teaching styles, will produce a level of overall student accomplishments that is greater than the achievements which can be produced by refining the conventional electrical, computer, and mechanical engineering curricula. The multidisciplinary mechatronic paradigm serves very important purposes because it brings new depth to engineering areas, advances students' knowledge and background, provides students with the basic problem-solving skills that are needed to cope with advanced electromechanical systems controlled by microprocessors or DSPs, covers state-of-the-art hardware, and emphasizes and applies

modern software environments. Through the mechatronic curriculum, important program objectives and goals can be achieved. The integration of mechatronic courses into the engineering curriculum is reported in this chapter. Our ultimate goal is to identify the role, examine the existing courses, refine and enhance mechatronic curriculum in order to improve the structure and content of engineering programs, recruit and motivate students, increase teaching effectiveness and improve material delivery, as well as assess and evaluate the desired engineering program outcomes. The primary emphasis is placed on enhancement and improvement in student knowledge, learning, critical thinking, depth, breadth, results interpretation, integration and application of knowledge, motivation, commitment, creativity, enthusiasm, and confidence. These can be achieved through the mechatronic curriculum development and implementation. This chapter reports the development of a mechatronic curriculum. The role of mechatronics in modern engineering is discussed and documented.

6.2 Nano-, Micro-, and Mini-Scale Electromechanical Systems and Mechatronic Curriculum

Conventional, mini- and micro-scale electromechanical systems are studied from a unified perspective because operating features, basic phenomena, and dominant effects are based upon classical electromagnetics and mechanics (electromechanics). Electromechanical systems integrate subsystems and components. No matter how well an individual subsystem or component (electric motor, sensor, power amplifier, or DSP) performs, the overall performance can be degraded if the designer fails to integrate and optimize the electromechanical system. While electric machines, sensors, power electronics, microcontrollers, and DSPs should be emphasized, analyzed, designed, and optimized, the main focus is centered on integrated issues. The designer sometimes fails to grasp and understand the global picture because this requires extensive experience, background, knowledge, and capabilities to attain detailed assessment analysis with outcome prediction and overall performance evaluation. While the component-based *divide-and-solve* approach is valuable and applicable in the preliminary design phase, it is very important that the design and analysis of integrated electromechanical systems be accomplished in the context of global optimization with proper objectives, specifications, requirements, and bounds imposed. Novel electromechanical and VLSI technologies, computer-aided-design software, software-hardware co-design tools, high-performance software environments, and robust computational algorithms must be applied to design electromechanical systems. The main objective of the mechatronic curriculum development is to satisfy academia–industry–government demands as well as to help students develop in-depth fundamental, analytic, and experimental skills in analysis, design, optimization, control, and implementation of advanced integrated electromechanical systems. It is not possible to cover the full spectrum of mechatronics issues in a single course. Therefore, the mechatronic curriculum must be developed assuming that students already have sufficient fundamentals in calculus, physics, circuits, electromechanical devices, sensors, and controls.

The engineering curriculum usually integrates general education, science, and engineering courses. The incorporation of multidisciplinary engineering science and engineering design courses represents a major departure from the conventional curriculum. Usually, even electrical engineering students have some deficiencies in advanced electromagnetics, electric machinery, power electronics, ICs, microcontrollers, and DSPs because several of these courses are elective. Mechanical engineering students, while advancing electrical engineering students in mechanics and thermodynamics, have limited access to electromagnetics, electric machines, power electronics, microelectronics, and DSP courses. In addition, there are deficiencies in computer science and engineering mathematics for both electrical and mechanical engineering students because these courses are usually required only for computer engineering students. The need for engineering mathematics, electromagnetics, power electronics, and electromechanical motion devices (electric machines, actuators, and sensors) has not diminished, rather strengthened. In addition, radically new advanced hardware has been developed using enabling

fabrication technologies to fabricate nano- and micro-scale sensors, actuators, ICs, and antennas. Efficient software has emerged. To overcome the difficulties encountered, the mechatronic courses which cover the multidisciplinary areas must be introduced to the engineering curriculum. Mechatronics has been enthusiastically explored and supported by undergraduate and graduate, educational and research-oriented universities, high-technology industry, and government laboratories. However, there is a need to develop the long-term strategy in mechatronic research and education, define the role, as well as implement, commercialize, and market the mechatronic and electromechanics programs.

6.3 Mechatronics and Modern Engineering

Many engineering problems can be formulated, attacked, and solved using the mechatronic paradigm. Mechatronics deals with benchmarking and emerging problems in integrated electrical–mechanical–computer engineering, science, and technologies. Many of these problems have not been attacked and solved; and sometimes, the existing solutions cannot be treated as the optimal one. This reflects obvious trends in fundamental, applied, and experimental research as well as curriculum changes in response to long-standing unsolved problems, engineering and technological enterprise, and entreaties of steady evolutionary demands.

Mechatronics is the integrated design, analysis, optimization, and virtual prototyping of intelligent and high-performance electromechanical systems, system intelligence, learning, adaptation, decision making, and control through the use of advanced hardware (actuators, sensors, microprocessors, DSPs, power electronics, and ICs) and leading-edge software.

Integrated multidisciplinary features approach quickly, as documented in Fig. 6.2. The mechatronic paradigm, which integrates electrical, mechanical, and computer engineering, takes place.

The structural complexity of mechatronic systems has increased drastically due to hardware and software advancements, as well as stringent *achievable* performance requirements. Answering the demands of rising electromechanical system complexity, performance specifications, and intelligence, the mechatronic paradigm was introduced. In addition to the proper choice of electromechanical system components and subsystems, there are other issues which must be addressed in view of the constantly evolving nature of the electromechanical systems theory (e.g., analysis, design, modeling, optimization, complexity, intelligence, decision making, diagnostics, packaging). Competitive *optimum-performance* electromechanical systems must be designed within the advanced hardware and software concepts.

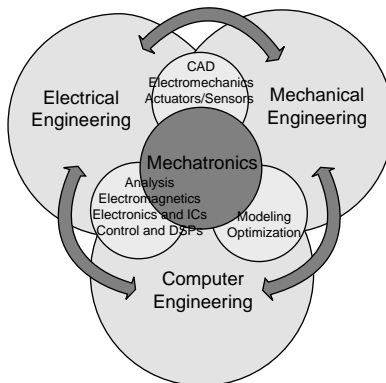

FIGURE 6.2 Mechatronics integrates electrical, mechanical, and computer engineering.

6.4 Design of Mechatronic Systems

One of the most challenging problems in mechatronic systems design is the system architecture synthesis, system integration, optimization, as well as selection of hardware (actuators, sensors, power electronics, ICs, microcontrollers, and DSPs) and software (environments, tools, computation algorithms to perform control, sensing, execution, emulation, information flow, data acquisition, simulation, visualization, virtual prototyping, and evaluation). Attempts to design state-of-the-art high-performance mechatronic systems and to guarantee the integrated design can be pursued through analysis of complex patterns and paradigms of evolutionary developed biological systems. Recent trends in engineering have increased the emphasis on integrated analysis, design, and control of advanced electromechanical systems. The scope of mechatronic systems has continued to expand, and, in addition to actuators, sensors, power electronics, ICs, antennas, microprocessors, DSPs, as well as input/output devices, many other subsystems must be integrated. The design process is evolutionary in nature. It starts with a given set of requirements and specifications. High-level functional design is performed first in order to produce detailed design at the subsystem and component level. Using the advanced subsystems and components, the initial design is performed, and the closed-loop electromechanical system performance is tested against the requirements. If requirements and specifications are not met, the designer revises or refines the system architecture, and other solutions are sought. At each level of the design hierarchy, the system performance in the behavioral domain is used to evaluate and refine the design process and solution devised. Each level of the design hierarchy corresponds to a particular abstraction level and has the specified set of activities and design tools that support the design at this level. For example, different criteria are used to design actuators and ICs due to different behavior, physical properties, operational principles, and performance criteria imposed for these components. It should be emphasized that the level of hierarchy must be defined, e.g., there is no need to study the behavior of millions of transistors on each IC chip because mechatronic systems integrate hundreds of ICs, and the end-to-end behavior of ICs is usually evaluated (ICs are assumed to be optimized, and these ICs are used as ready-to-use components). The design flow is illustrated in Fig. 6.3.

Automated synthesis can be attained to implement this design flow. The design of mechatronic systems is a process that starts from the specification of requirements and progressively proceeds to perform a functional design and optimization that is gradually refined through a sequence of steps. Specifications typically include the performance requirements derived from systems functionality, operating envelope, affordability, and other requirements. Both *top-down* and *bottom-up* approaches should be combined to design high-performance mechatronic systems augmenting hierarchy, integrity, regularity, modularity, compliance, and completeness in the synthesis process. Even though the

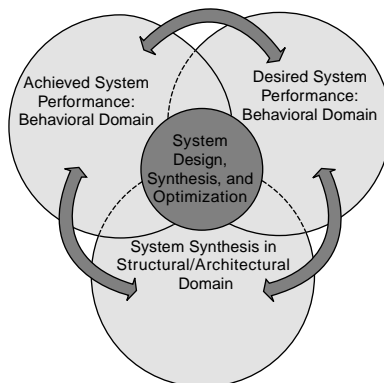

FIGURE 6.3 Design flow in synthesis of mechatronic systems.

basic foundations have been developed, some urgent areas have been downgraded, less emphasized, and researched. The mechatronic systems synthesis reported guarantees an eventual consensus between behavioral and structural domains, as well as ensures descriptive and integrative features in the design. These were achieved applying the mechatronic paradigm which allows one to extend and augment the results of classical mechanics, electromagnetics, electric machinery, power electronics, microelectronics, informatics, and control theories, as well as to apply advanced integrated hardware and software.

To acquire and expand the engineering core, there is the need to augment interdisciplinary areas as well as to link and place the multidisciplinary perspectives integrating actuators–sensors–power electronics–ICs–DSPs to attain actuation, sensing, control, decision making, intelligence, signal processing, and data acquisition. New developments are needed. The theory and engineering practice of high-performance electromechanical systems should be considered as the unified cornerstone of the engineering curriculum through mechatronics. The unified analysis of actuators and sensors (e.g., electromechanical motion devices), power electronics and ICs, microprocessors and DSPs, and advanced hardware and software, have barely been introduced into the engineering curriculum. Mechatronics, as the breakthrough concept in the design and analysis of conventional-, mini-, micro- and nano-scale electro-mechanical systems, was introduced to attack, integrate, and solve a great variety of emerging problems.

6.5 Mechatronic System Components

Mechatronics integrates electromechanical systems design, modeling, simulation, analysis, software-hardware developments and co-design, intelligence, decision making, advanced control (including self-adaptive, robust, and intelligent motion control), signal/image processing, and virtual prototyping. The mechatronic paradigm utilizes the fundamentals of electrical, mechanical, and computer engineering with the ultimate objective to guarantee the synergistic combination of precision engineering, electronic control, and intelligence in the design, analysis, and optimization of electromechanical systems. Electromechanical systems (robots, electric drives, servomechanisms, pointing systems, assemblers) are highly nonlinear systems, and their accurate actuation, sensing, and control are very challenging problems. Actuators and sensors must be designed and integrated with the corresponding power electronic subsystems. The principles of matching and compliance are general design principles, which require that the electromechanical system architectures should be synthesized integrating all subsystems and components. The matching conditions have to be determined and guaranteed, and actuators–sensors–power electronics compliance must be satisfied. Electromechanical systems must be controlled, and controllers should be designed. Robust, adaptive, and intelligent control laws must be designed, examined, verified, and implemented. The research in control of electromechanical systems aims to find methods for devising intelligent and motion controllers, system architecture synthesis, deriving feedback maps, and obtaining gains. To implement these controllers, microprocessors and DSPs with ICs (input-output devices, A/D and D/A converters, optocouplers, transistor drivers) must be used. Other problems are to design, optimize, and verify the analysis, control, execution, emulation, and evaluation software.

It was emphasized that the design of high-performance mechatronic systems implies the subsystems and components developments. One of the major components of mechatronic systems are electric machines used as actuators and sensors. The following problems are usually emphasized: characterization of electric machines, actuators, and sensors according to their applications and overall systems requirements by means of specific computer-aided-design software; design of high-performance electric machines, actuators, and sensors for specific applications; integration of electric motors and actuators with sensors, power electronics, and ICs; control and diagnostic of electric machines, actuators, and sensors using microprocessors and DSPs.

6.6 Systems Synthesis, Mechatronics Software, and Simulation

Modeling, simulation, and synthesis are complementary activities performed in the design of mechatronic systems. Simulation starts with the model developments, while synthesis starts with the specifications imposed on the behavior and analysis of the system performance through analysis using modeling, simulation, and experimental results. The designer mimics, studies, analyzes, and evaluates the mechatronic system's behavior using state, performance, control, events, disturbance, and other variables. The synthesis process was described in section 6.4. Modeling, simulation, analysis, virtual prototyping, and visualization are critical and urgently important aspects for developing and prototyping of advanced electromechanical systems. As a flexible high-performance modeling and design environment, MATLAB has become a standard, cost-effective tool. Competition has prompted cost and product cycle reductions. To speed up analysis and design with assessment analysis, facilitate enormous gains in productivity and creativity, integrate control and signal processing using advanced microprocessors and DSPs, accelerate prototyping features, generate real-time C code and visualize the results, perform data acquisition and data intensive analysis, the MATLAB^R environment is used. In MATLAB, the following commonly used toolboxes can be applied: SIMULINK^R, Real-Time WorkshopTM, Control System, Nonlinear Control Design, Optimization, Robust Control, Signal Processing, Symbolic Math, System Identification, Partial Differential Equations, Neural Networks, as well as other application-specific toolboxes (see the MATLAB demo typing demo in the Command Window). MATLAB capabilities should be demonstrated by attacking important practical examples in order to increase students' productivity and creativity by demonstrating how to use the advanced software in electromechanical system applications. The MATLAB environment offers a rich set of capabilities to efficiently solve a variety of complex analysis, modeling, simulation, control, and optimization problems encountered in undergraduate and graduate mechatronic courses. A wide array of mechatronic systems can be modeled, simulated, analyzed, and optimized. The electromechanical systems examples, integrated within mechatronic courses, will provide the practice and educate students with the highest degree of comprehensiveness and coverage.

6.7 Mechatronic Curriculum

The ultimate objective of the mechatronic curriculum is to educate a new generation of students and engineers, as well as to assist industry and government in the development of high-performance electromechanical systems augmenting conventional engineering curriculum with an ever-expanding electromechanics core. The emphasis should be focused on advancing the overall mission of the engineering curriculum, because through mechatronics it is possible to further define, refine, and expand the objectives into three fundamental areas, which are research, education, and service. Using the mechatronic paradigm, academia will perform world-class fundamental and applied research by

- integrating electromagnetics, electromechanics, power electronics, ICs, and control;
- devising advanced design, analysis, and optimization simulation and analytic tools and capabilities through development of specialized computer-aided-design software;
- developing actuation-sensing-control hardware;
- devising advanced paradigms, concepts, and technologies;
- supporting research, internship, and cooperative multidisciplinary education programs for undergraduate and graduate students;
- supporting, sustaining, and assisting faculty in emerging new areas.

Mechatronic curriculum design includes development of goals and objectives, programs of study and curriculum guides, courses, laboratories, textbooks, instructional materials, manuals, experiments,

instructional sequences, material delivery techniques, visualization and demonstration approaches, and other supplemental materials to accomplish a wide range of educational and research goals. There is an increase in the number of students whose good programming skills and theoretical background match with complete inability to solve simple engineering problems. The fundamental goal of mechatronic courses is to demonstrate the application of theoretical, applied, and experimental results in analysis, design, and deployment of complex electromechanical systems (including NEMS and MEMS), to cover emerging hardware and software, to introduce and deliver the rigorous theory of electromechanics, to help students develop strong problem-solving skills, as well as to provide the needed engineering practice. The courses in mechatronics are intended to develop a thorough understanding of integrated perspectives in analysis, modeling, simulation, optimization, design, and implementation of complex electromechanical systems. By means of practical, worked-out examples, students will be prepared and trained to use the results in engineering practice, research, and developments. Advanced hardware and software of engineering importance (electromechanical motion devices, actuators, sensors, solid-state devices, power electronics, ICs, microprocessors, and DSPs) must be comprehensively covered in detail from multidisciplinary integrated perspectives.

At Purdue University Indianapolis, in the Department of Electrical and Computer Engineering, the following undergraduate courses are required in the Electrical Engineering plan of study: *Linear Circuit Analysis I and II*, *Signals and Systems*, *Semiconductor Devices*, *Electric and Magnetic Fields*, *Microprocessor Systems and Interfacing*, and *Feedback Systems Analysis and Design*. The following elective undergraduate courses assist the mechatronic area: *Electromechanical Motion Devices*, *Computer Architecture*, *Digital Signal Processing*, and *Multimedia Systems*. In addition to this set of core Electrical and Computer Engineering courses, there is a critical need to teach the courses in mechatronics.

The mechatronic curriculum should emphasize and augment traditional engineering topics and the latest enabling technologies and developments to integrate and stimulate new advances in the analysis and design of advanced state-of-the-art mechatronic systems. For example, the following courses should be developed and offered: *Mechatronic Systems*, *Smart Structures*, *Micromechatronics (Microelectromechanical Systems)*, and *Nanomechatronics (Nanoelectromechanical Systems)*.

The major goal is to ensure a deep understanding of the engineering underpinnings, integrate engineering–science–technology, and develop the modern picture of electromechanical engineering by using the bedrock fundamentals of mechatronics. It is recognized by academia, industry, and government that the most urgent areas of modern mechatronics needing development are MEMS and NEMS. Therefore, current developments should be concentrated to perform fundamental, applied, and experimental research in these emerging fields.

6.8 Introductory Mechatronic Course

At Purdue University Indianapolis, in the Electrical and Computer Engineering and Mechanical Engineering departments, an Electrical/Mechanical Engineering senior-level undergraduate–junior graduate mechatronic course was developed and offered. The topics covered are given in [Table 6.1](#).

This course is developed to bridge the engineering–science–technology gap by bonding innovative multi-disciplinary developments, focusing on state-of-the-art hardware, and centering on high-performance software. The developed course dramatically reduces the time students need to establish basic skills for high-technology employability. The objective of this course is twofold: to bring recent developments of modern electromechanics and to integrate an interactive studio-based method of instruction and delivery. During the past decade, there has been a shift in engineering education from an instructor-centered lectures environment to a student-centered learning environment. We have developed a mechatronics studio that combines lectures, simulation exercises, and experiments in a single classroom in order to implement new teaching and delivery methods through an active learning environment, activity-based strategies, interactive multimedia, networked computer-based learning, multisynchronous delivery of supporting materials, and effective demonstration. Simulation-based assignments can be used to illustrate problems that cannot be easily studied and assessed using classical paper-and-pencil analytic solutions.

TABLE 6.1 Mechatronic Course Contents

| No. | Topic | Class |
|-----|--|-------|
| 1 | Introduction to electromechanical systems and mechatronics | 1 |
| 2 | Electromagnetics and mechanics in mechatronic systems: Newtonian mechanics, the Lagrange equations of motion, and Kirchhoff's laws | 2 |
| 3 | Energy conversion and electromechanical analogies | 2 |
| 4 | Dynamics of mechatronic system | 2 |
| 5 | The MATLAB environment in nonlinear analysis and modeling of mechatronic systems | 2 |
| 6 | Permanent-magnet direct-current and synchronous servo-motors | 4 |
| 7 | Transducers and smart structures: actuators and sensors | 2 |
| 8 | Power electronics, driving circuitry, power converters and amplifiers | 4 |
| 9 | Motion control of electromechanical systems and smart structures | 3 |
| 10 | Microprocessors and DSPs in control and data acquisition of mechatronic systems | 2 |
| 11 | Mechatronic systems: case-studies, modeling, analysis, control, and laboratory experiments | 3 |
| 12 | Advanced project | 1 |

Although simulation-based assignments provide much insight to practical problems, there is nothing that can take the place of hands-on experiments. The mechatronics is introduced through synergy of comprehensive systems design, high-fidelity modeling, simulation, hardware demonstration, and case studies.

The assessment performed demonstrates that this course guarantees comprehensive, balanced coverage, satisfies the program objectives, and fulfills the goals. While students are familiar with some topics of advanced engineering and science (calculus and physics), it is clear that they do not have sufficient background in nonlinear dynamics and control, electric machinery, power electronics, solid-state devices, ICs, microprocessors, and DSPs. Therefore, the material is presented in sufficient details, and basic theory needed to fully understand, appreciate, and apply mechatronics is covered. In this course, most efficient and straightforward analysis, modeling, simulation, and synthesis methods are presented and demonstrated with ultimate objectives to address and solve the analysis, design, control, optimization, and virtual prototyping problems. A wide range of worked-out examples and qualitative illustrations, which are treated in-depth, bridge the gap between the theory, practical problems, and engineering practice. Step-by-step, the mechatronic course guides students from rigorous theoretical foundation to advanced applications and implementation. In addition to achieving a good balance between theory and application, state-of-the-art hardware and software are emphasized and demonstrated. In this course, mechatronic systems are thoroughly covered, and students can easily apply the results to attack real engineering problems.

6.9 Books in Mechatronics

The demand for educational books in mechatronics far exceeds what was previously anticipated by academia and industry. Excellent textbooks in electric machinery [1–8], power electronics [9–11], microelectronics and ICs [12], and sensors [13,14] were published. Educational examples in analysis and design of linear electromechanical systems are available from control books [15–21]. *Control Systems Theory With Engineering Applications* [18], shown in Fig. 6.4, has a number of illustrative examples in modeling, simulation, and control of complex nonlinear electromechanical systems. In particular, analysis and control of nonlinear transducers, permanent-magnet DC and synchronous motors, squirrel-cage induction motors, servomechanisms, and power converters are thoroughly covered.

The need for a comprehensive treatment of nonlinear electromechanical systems using the mechatronic paradigm is evident. Excellent books in conventional electromechanical motion devices [3,4,22], and textbooks for mechanical engineering students in mechatronics [23–27] have been used in Electrical and Mechanical Engineering departments, respectively. However, there is a critical need for modern books in mechatronics that are comprehensive in their coverage and global in their perspective for engineering departments. The time has come to target new frontiers using the developed engineering enterprise,

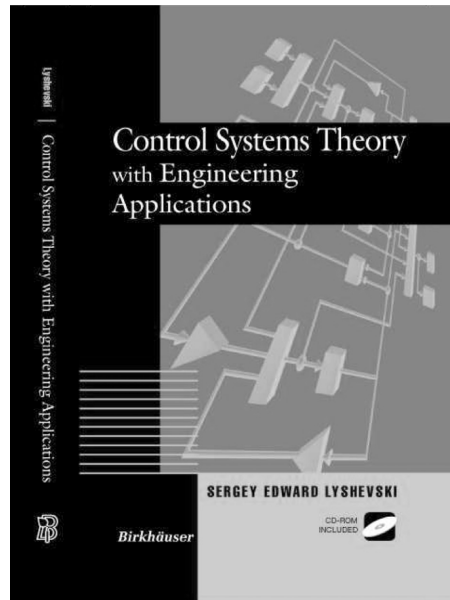
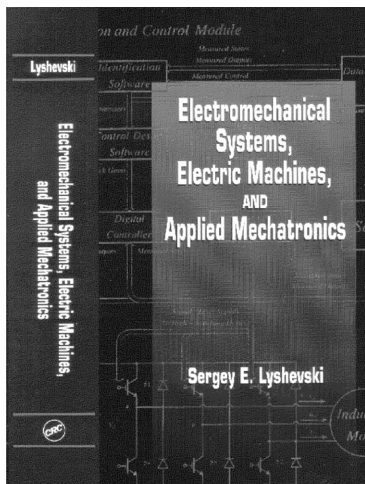
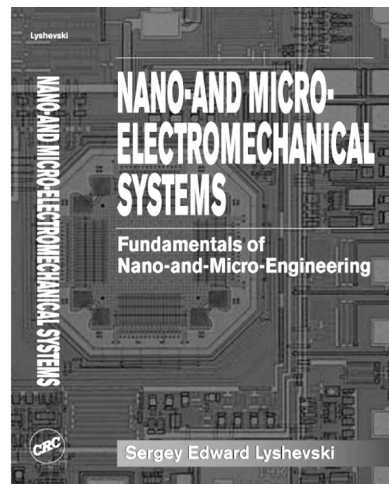

FIGURE 6.4 Control book with coverage in analysis and control of electromechanical systems. <http://www.birkhauser.com/cgi-win/ISBN/0-8176-4203-X>.



<http://www.crcpress.com/us/product.asp?sku=2275&dept%5Fid=1>



<http://www.crcpress.com/us/product.asp?sku=0916&dept%5Fid=1>

FIGURE 6.5 Books in electromechanical and mechatronic systems.

emerging technologies, advanced hardware, and state-of-the-art software. The book *Electromechanical Systems, Electric Machines, and Applied Mechatronics* [28] was written by taking advantage of the modern engineering curriculum, see Fig. 6.5. In this book, the fundamental theory of electromechanics, new enabling technologies, basic engineering principles, system integration, modeling, analysis, simulation, control, as well as a spectrum of emerging engineering problems, were comprehensively covered. For NEMS and MEMS, the book *Nano- and Micro-Electromechanical Systems: Fundamentals of Nano- and Micro-Engineering* [29] can be effectively used. A wide number of demonstrations and examples of electromechanical systems are covered.

6.10 Mechatronic Curriculum Developments

The current mechatronic curriculum leaves much to be desired, and the following strategy, which can be modified and expanded, should be pursued by academia to integrate the mechatronic courses in the undergraduate and graduate curricula:

- commercialize and market mechatronic program;
- expand the mechatronic horizon to conventional and mini-scale mechatronic systems, as well as to MEMS and NEMS which are emerging areas in engineering;
- revise the engineering curriculum. In particular, Electromagnetics, Electromechanical Motion Devices, Power Electronics, Control, Microelectronics, and DSP courses should be offered as the required core courses, and as prerequisites for advanced mechatronic courses;
- emphasize mechatronics as the center of the undergraduate and graduate electromechanical engineering curriculum rather than at the periphery;
- cover moderately complex electromechanical systems and case studies in the undergraduate mechatronic courses and relocate highly specialized topics to the graduate program;
- develop an intellectually demanding, progressive, well-balanced mechatronic curriculum and mechatronic courses with laboratories;
- fully integrate computer-aided-design tools and advanced high-performance simulation software;
- extend mechatronics to the undergraduate senior design projects;
- write and publish comprehensive books, textbooks, and handbooks in mechatronics; and
- widely and timely disseminate the results.

Manageable collaboration between engineering disciplines and departments can be achieved within the mechatronic program. The following basic courses sequence can be applied:

- Electromechanical Motion Devices,
- Power Electronics and Microelectronics,
- Microprocessors and Interfacing,
- Digital Signal Processing,
- Electromechanical Systems,
- Introduction to Mechatronics,
- Control Systems Theory and Control of Mechatronic Systems,
- Mechatronic Systems and Smart Structures,
- Microelectromechanical Systems,
- Nanoelectromechanical Systems.

Due to the differences in the electrical and computer, mechanical, and aerospace engineering plans of study and the limited number of elective engineering courses counted towards the degree, the mechatronic courses sequence can be different. For example, for electrical engineering students, the coursework plan of study can be designed using fundamental electrical engineering and applied mechanical engineering; for mechanical engineering students, fundamental mechanical engineering and applied electrical engineering can be emphasized. The students will have fundamentals in one core area while accomplishing breadth and receiving applied knowledge in the other field.

6.11 Conclusions: Mechatronics Perspectives

Far-reaching fundamental and technological advances in electromechanical motion devices (actuators and sensors), power electronics, solid-state devices, ICs, MEMS and NEMS, materials and packaging, computers and informatics, microprocessors and DSPs, digital signal and optical processing, as well as computer-aided-design tools and simulation software, have brought new challenges to academia,

industry, and government. As a result, many engineering schools have revised their curricula in order to offer the relevant interdisciplinary courses such as Electromechanical Systems and Mechatronics. The basis of mechatronics is fundamental theory and engineering practice. The attempts to introduce mechatronics have been only partially successful due to the absence of a long-term strategy. Therefore, coordinated efforts are sought. Most engineering curricula provide a single elective course to introduce mechatronics to electrical, computer, mechanical, and aerospace engineering students. Due to the lack of time, it is impossible to comprehensively cover the material and thoroughly emphasize the cross-disciplinary nature of mechatronics in one introductory course. As a result, this undergraduate or dual-level course might not adequately serve the students' professional needs and goals, and does not satisfy growing academia, industrial, and government demands. A set of core mechatronic courses should be integrated into the engineering curriculum, and laboratory- and project-oriented courses should be developed to teach and demonstrate advanced hardware and software with application to complex electromechanical systems. The relevance of fundamental theory, applied results, and experiments is very important and must be emphasized. The great power and versatility of mechatronics, not to mention the prime importance of the results it approaches in all areas of engineering, make it worthwhile for all engineers to be acquainted with the basic theory and engineering practice. There is no end to the application of mechatronics and to the further contribution to this interdisciplinary concept. We have just skimmed the surface of mechatronics application to advanced electromechanical systems. New trends will be researched and applied in the near future because mechatronics is an engineering–science–technology frontier. For example, novel phenomena and operating principles in NEMS and MEMS can be devised, studied, analyzed, and verified using nanomechatronics and nanoelectromechanics.

References

1. Chapman, S. J., *Electric Machinery Fundamentals*, McGraw-Hill, New York, 1999.
2. Fitzgerald, A. E., Kingsley, C., and Umans, S. D., *Electric Machinery*, McGraw-Hill, New York, 1990.
3. Krause, P. C., and Wasynczuk, O., *Electromechanical Motion Devices*, McGraw-Hill, New York, 1989.
4. Krause, P. C., Wasynczuk, O., and Sudhoff, S. D., *Analysis of Electric Machinery*, IEEE Press, New York, 1995.
5. Leonhard, W., *Control of Electrical Drives*, Springer, Berlin, 1996.
6. Ong, C. M., *Dynamic Simulation of Electric Machines*, Prentice-Hall, Upper Saddle River, NJ, 1998.
7. Novotny, D. W., and Lipo, T. A., *Vector Control and Dynamics of AC Drives*, Clarendon Press, Oxford, 1996.
8. Slemon, G. R., *Electric Machines and Drives*, Addison-Wesley Publishing Company, Reading, MA, 1992.
9. Hart, D. W., *Introduction to Power Electronics*, Prentice-Hall, Upper Saddle River, NJ, 1997.
10. Kassakian, J. G., Schlecht, M. F., and Verghese, G. C., *Principles of Power Electronics*, Addison-Wesley Publishing Company, Reading, MA, 1991.
11. Mohan, N. T., Undeland, M., and Robbins, W. P., *Power Electronics: Converters, Applications, and Design*, John Wiley and Sons, New York, 1995.
12. Sedra, A. S., and Smith, K. C., *Microelectronic Circuits*, Oxford University Press, New York, 1997.
13. Fraden, J., *Handbook of Modern Sensors: Physics, Design, and Applications*, AIP Press, Woodbury, NY, 1997.
14. Kovacs, G. T. A., *Micromachined Transducers Sourcebook*, McGraw-Hill, New York, 1998.
15. Dorf, R. C., and Bishop, R. H., *Modern Control Systems*, Addison-Wesley Publishing Company, Reading, MA, 1995.
16. Franklin, J. F., Powell, J. D., and Emami-Naeini, A., *Feedback Control of Dynamic Systems*, Addison-Wesley Publishing Company, Reading, MA, 1994.
17. Kuo, B. C., *Automatic Control Systems*, Prentice-Hall, Englewood Cliffs, NJ, 1995.
18. Lyshevski, S. E., *Control Systems Theory With Engineering Applications*, Birkhäuser, Boston, MA, 2001. <http://www.birkhauser.com/cgi-win/ISBN/0-8176-4203-X>

19. Ogata, K., *Discrete-Time Control Systems*, Prentice-Hall, Upper Saddle River, NJ, 1995.
20. Ogata, K., *Modern Control Engineering*, Prentice-Hall, Upper Saddle River, NJ, 1997.
21. Phillips, C. L., and Harbor, R. D., *Feedback Control Systems*, Prentice-Hall, Englewood Cliffs, NJ, 1996.
22. White, D. C., and Woodson, H. H., *Electromechanical Energy Conversion*, Wiley, New York, 1959.
23. Auslander, D. M., and Kempf, C. J., *Mechatronics: Mechanical System Interfacing*, Prentice-Hall, Upper Saddle River, NJ, 1996.
24. Bolton, W., *Mechatronics: Electronic Control Systems in Mechanical Engineering*, Addison-Wesley Logman Publishing, New York, 1999.
25. Bradley, D. A., Dawson, D., Burd, N. C., and Loader, A. J., *Mechatronics*, Chapman and Hall, New York, 1996.
26. Fraser, C., and Milne, J., *Electro-Mechanical Engineering*, IEEE Press, New York, 1994.
27. Shetty, D., and Kolk, R. A., *Mechatronics System Design*, PWS Publishing Company, New York, 1997.
28. Lyshevski, S. E., *Electromechanical Systems, Electric Machines, and Applied Mechatronics*, CRC Press, Boca Raton, FL, 1999. <http://www.crcpress.com/us/product.asp?sku=2275&dept%5Fid=1>
29. Lyshevski, S. E., *Nano- and Microelectromechanical Systems: Fundamentals of Nano- and Microengineering*, CRC Press, Boca Raton, FL, 2000. <http://www.crcpress.com/us/product.asp?sku=0916&dept%5Fid=1>

II

Physical System Modeling

- 7 Modeling Electromechanical Systems** *Francis C. Moon*
Introduction • Models for Electromechanical Systems • Rigid Body Models • Basic Equations of Dynamics of Rigid Bodies • Simple Dynamic Models • Elastic System Modeling • Electromagnetic Forces • Dynamic Principles for Electric and Magnetic Circuits • Earnshaw's Theorem and Electromechanical Stability
- 8 Structures and Materials** *Eniko T. Enikov*
Fundamental Laws of Mechanics • Common Structures in Mechatronic Systems • Vibration and Modal Analysis • Buckling Analysis • Transducers • Future Trends
- 9 Modeling of Mechanical Systems for Mechatronics Applications**
Raul G. Longoria
Introduction • Mechanical System Modeling in Mechatronic Systems • Descriptions of Basic Mechanical Model Components • Physical Laws for Model Formulation • Energy Methods for Mechanical System Model Formulation • Rigid Body Multidimensional Dynamics • Lagrange's Equations
- 10 Fluid Power Systems** *Qin Zhang and Carroll E. Goering*
Introduction • Hydraulic Fluids • Hydraulic Control Valves • Hydraulic Pumps • Hydraulic Cylinders • Fluid Power Systems Control • Programmable Electrohydraulic Valves
- 11 Electrical Engineering** *Giorgio Rizzoni*
Introduction • Fundamentals of Electric Circuits • Resistive Network Analysis • AC Network Analysis
- 12 Engineering Thermodynamics** *Michael J. Moran*
Fundamentals • Extensive Property Balances • Property Relations and Data • Vapor and Gas Power Cycles

- 13 Modeling and Simulation for MEMS** *Carla Purdy*
Introduction • The Digital Circuit Development Process: Modeling and Simulating Systems with Micro- (or Nano-) Scale Feature Sizes • Analog and Mixed-Signal Circuit Development: Modeling and Simulating Systems with Micro- (or Nano-) Scale Feature Sizes and Mixed Digital (Discrete) and Analog (Continuous) Input, Output, and Signals • Basic Techniques and Available Tools for MEMS Modeling and Simulation • Modeling and Simulating MEMS, i.e., Systems with Micro- (or Nano-) Scale Feature Sizes, Mixed Digital (Discrete) and Analog (Continuous) Input, Output, and Signals, Two- and Three-Dimensional Phenomena, and Inclusion and Interaction of Multiple Domains and Technologies • A “Recipe” for Successful MEMS Simulation • Conclusion: Continuing Progress in MEMS Modeling and Simulation
- 14 Rotational and Translational Microelectromechanical Systems: MEMS Synthesis, Microfabrication, Analysis, and Optimization**
Sergey Edward Lyshevski
Introduction • MEMS Motion Microdevice Classifier and Structural Synthesis • MEMS Fabrication • MEMS Electromagnetic Fundamentals and Modeling • MEMS Mathematical Models • Control of MEMS • Conclusions
- 15 The Physical Basis of Analogies in Physical System Models** *Neville Hogan and Peter C. Breedveld*
Introduction • History • The Force-Current Analogy: Across and Through Variables • Maxwell’s Force-Voltage Analogy: Effort and Flow Variables • A Thermodynamic Basis for Analogies • Graphical Representations • Concluding Remarks

7

Modeling Electro- mechanical Systems

- 7.1 Introduction
- 7.2 Models for Electromechanical Systems
- 7.3 Rigid Body Models
 - Kinematics of Rigid Bodies • Constraints and Generalized Coordinates • Kinematic versus Dynamic Problems
- 7.4 Basic Equations of Dynamics of Rigid Bodies
 - Newton–Euler Equation • Multibody Dynamics
- 7.5 Simple Dynamic Models
 - Compound Pendulum • Gyroscopic Motions
- 7.6 Elastic System Modeling
 - Piezoelectric Beam
- 7.7 Electromagnetic Forces
- 7.8 Dynamic Principles for Electric and Magnetic Circuits
 - Lagrange’s Equations of Motion for Electromechanical Systems
- 7.9 Earnshaw’s Theorem and Electromechanical Stability

Francis C. Moon
Cornell University

7.1 Introduction

Mechatronics describes the integration of mechanical, electromagnetic, and computer elements to produce devices and systems that monitor and control machine and structural systems. Examples include familiar consumer machines such as VCRs, automatic cameras, automobile air bags, and cruise control devices. A distinguishing feature of modern mechatronic devices compared to earlier controlled machines is the miniaturization of electronic information processing equipment. Increasingly computer and electronic sensors and actuators can be embedded in the structures and machines. This has led to the need for integration of mechanical and electrical design. This is true not only for sensing and signal processing but also for actuator design. In human size devices, more powerful magnetic materials and superconductors have led to the replacement of hydraulic and pneumatic actuators with servo motors, linear motors, and other electromagnetic actuators. At the material scale and in microelectromechanical systems (MEMS), electric charge force actuators, piezoelectric actuators, and ferroelectric actuators have made great strides.

While the materials used in electromechanical design are often new, the basic dynamic principles of Newton and Maxwell still apply. In spatially extended systems one must solve continuum problems using the theory of elasticity and the partial differential equations of electromagnetic field theory. For many applications, however, it is sufficient to use lumped parameter modeling based on i) rigid body dynamics

for inertial components, ii) Kirchhoff circuit laws for current-charge components, and iii) magnet circuit laws for magnetic flux devices.

In this chapter we will examine the basic modeling assumptions for inertial, electric, and magnetic circuits, which are typical of mechatronic systems, and will summarize the dynamic principles and interactions between the mechanical motion, circuit, and magnetic state variables. We will also illustrate these principles with a few examples as well as provide some bibliography to more advanced references in electromechanics.

7.2 Models for Electromechanical Systems

The fundamental equations of motion for physical continua are partial differential equations (PDEs), which describe dynamic behavior in both time and space. For example, the motions of strings, elastic beams and plates, fluid flow around and through bodies, as well as magnetic and electric fields require both spatial and temporal information. These equations include those of elasticity, elastodynamics, the Navier–Stokes equations of fluid mechanics, and the Maxwell–Faraday equations of electromagnetics. Electromagnetic field problems may be found in Jackson (1968). Coupled field problems in electric fields and fluids may be found in Melcher (1980) and problems in magnetic fields and elastic structures may be found in the monograph by Moon (1984). This short article will only treat solid systems.

Many practical electromechanical devices can be modeled by lumped physical elements such as mass or inductance. The equations of motion are then integral forms of the basic PDEs and result in coupled ordinary differential equations (ODEs). This methodology will be explored in this chapter. Where physical problems have spatial distributions, one can often separate the problem into spatial and temporal parts called *separation of variables*. The spatial description is represented by a finite number of spatial or eigenmodes each of which has its modal amplitude. This method again results in a set of ODEs. Often these coupled equations can be understood in the context of simple lumped mechanical masses and electric and magnetic circuits.

7.3 Rigid Body Models

Kinematics of Rigid Bodies

Kinematics is the description of motion in terms of position vectors \mathbf{r} , velocities \mathbf{v} , acceleration \mathbf{a} , rotation rate vector $\boldsymbol{\omega}$, and generalized coordinates $\{q_k(t)\}$ such as relative angular positions of one part to another in a machine (Fig. 7.1). In a rigid body one generally specifies the position vector of one point, such as the center of mass \mathbf{r}_c , and the velocity of that point, say \mathbf{v}_c . The angular position of a rigid body is specified by angle sets call Euler angles. For example, in vehicles there are pitch, roll, and yaw angles (see, e.g., Moon, 1999). The angular velocity vector of a rigid body is denoted by $\boldsymbol{\omega}$. The velocity of a point in a rigid body other than the center of mass, $\mathbf{r}_p = \mathbf{r}_c + \boldsymbol{\rho}$, is given by

$$\mathbf{v}_p = \mathbf{v}_c + \boldsymbol{\omega} \times \boldsymbol{\rho} \quad (7.1)$$

where the second term is a vector cross product. The angular velocity vector $\boldsymbol{\omega}$ is a property of the entire rigid body. In general a rigid body, such as a satellite, has six degrees of freedom. But when machine elements are modeled as a rigid body, kinematic constraints often limit the number of degrees of freedom.

Constraints and Generalized Coordinates

Machines are often collections of rigid body elements in which each component is constrained to have one degree of freedom relative to each of its neighbors. For example, in a multi-link robot arm shown in Fig. 7.2, each rigid link has a revolute degree of freedom. The degrees of freedom of each rigid link are constrained by bearings, guides, and gearing to have one type of relative motion. Thus, it is convenient

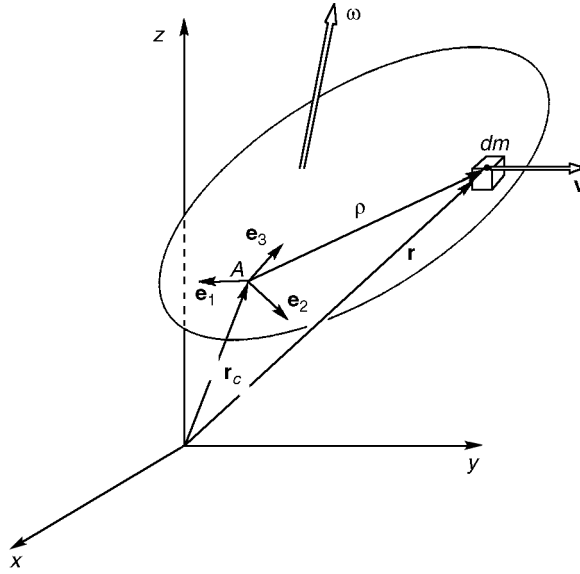

FIGURE 7.1 Sketch of a rigid body with position vector, velocity, and angular velocity vectors.

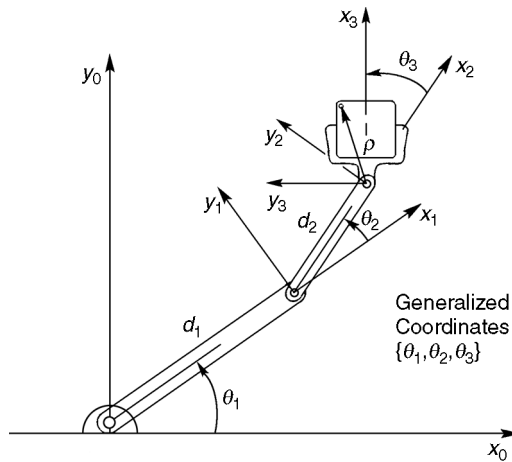

FIGURE 7.2 Multiple link robot manipulator arm.

to use these generalized motions $\{q_k: k = 1, \dots, K\}$ to describe the dynamics. It is sometimes useful to define a vector or matrix, $\mathbf{J}(q_k)$, called a *Jacobian*, that relates velocities of physical points in the machine to the generalized velocities $\{\dot{q}_k\}$. If the position vector to some point in the machine is $\mathbf{r}_p(q_k)$ and is determined by geometric constraints indicated by the functional dependence on the $\{q_k(t)\}$, then the velocity of that point is given by

$$\mathbf{v}_p = \sum \frac{\partial \mathbf{r}_p}{\partial q_r} \dot{q}_r = \mathbf{J} \cdot \dot{\mathbf{q}} \quad (7.2)$$

where the sum is on the number of generalized degrees of freedom K . The three-by- K matrix \mathbf{J} is called a *Jacobian* and $\dot{\mathbf{q}}$ is a $K \times 1$ vector of generalized coordinates. This expression can be used to calculate

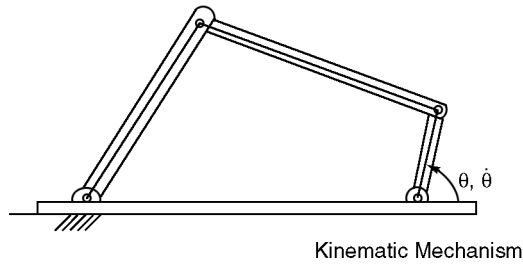

FIGURE 7.3 Example of a kinematic mechanism.

the kinetic energy of the constrained machine elements, and using Lagrange’s equations discussed below, derive the equations of motion (see also Moon, 1999).

Kinematic versus Dynamic Problems

Some machines are constructed in a closed kinematic chain so that the motion of one link determines the motion of the rest of the rigid bodies in the chain, as in the four-bar linkage shown in Fig. 7.3. In these problems the designer does not have to solve differential equations of motion. Newton’s laws are used to determine forces in the machine, but the motions are *kinematic*, determined through the geometric constraints.

In open link problems, such as robotic devices (Fig. 7.2), the motion of one link does not determine the dynamics of the rest. The motions of these devices are inherently *dynamic*. The engineer must use both the kinematic constraints (7.2) as well as the Newton–Euler differential equation of motion or equivalent forms such as Lagrange’s equation discussed below.

7.4 Basic Equations of Dynamics of Rigid Bodies

In this section we review the equations of motion for the mechanical plant in a mechatronics system. This plant could be a system of rigid bodies such as in a serial robot manipulator arm (Fig. 7.2) or a magnetically levitated vehicle (Fig. 7.4), or flexible structures in a MEMS accelerometer. The dynamics of flexible structural systems are described by PDEs of motion. The equation for rigid bodies involves Newton’s law for the motion of the center of mass and Euler’s extension of Newton’s laws to the angular momentum of the rigid body. These equations can be formulated in many ways (see Moon, 1999):

1. Newton–Euler equation (vector method)
2. Lagrange’s equation (scalar-energy method)
3. D’Alembert’s principle (virtual work method)
4. Virtual power principle (Kane’s equation, or Jourdan’s principle)

Newton–Euler Equation

Consider the rigid body in Fig. 7.1 whose center of mass is measured by the vector \mathbf{r}_c in some fixed coordinate system. The velocity and acceleration of the center of mass are given by

$$\dot{\mathbf{r}}_c = \mathbf{v}_c, \quad \ddot{\mathbf{r}}_c = \mathbf{a}_c \tag{7.3}$$

The “over dot” represents a total derivative with respect to time. We represent the total sum of vector forces on the body from both mechanical and electromagnetic sources by \mathbf{F} . Newton’s law for the motion



FIGURE 7.4 Magnetically levitated rigid body (HSST MagLev prototype vehicle, 1998, Nagoya, Japan).

of the center of mass of a body with mass m is given by

$$m\dot{\mathbf{v}}_c = \mathbf{F} \quad (7.4)$$

If \mathbf{r} is a vector to some point in the rigid body, we define a local position vector $\boldsymbol{\rho}$ by $\mathbf{r}_p = \mathbf{r}_c + \boldsymbol{\rho}$. If a force \mathbf{F}_i acts at a point \mathbf{r}_i in a rigid body, then we define the moment of the force \mathbf{M} about the fixed origin by

$$\mathbf{M}_i = \mathbf{r}_i \times \mathbf{F}_i \quad (7.5)$$

The total force moment is then given by the sum over all the applied forces as the body

$$\mathbf{M} = \sum \mathbf{r}_i \times \mathbf{F}_i = \mathbf{r}_c \times \mathbf{F} + \mathbf{M}_c \quad \text{where} \quad \mathbf{M}_c = \sum \boldsymbol{\rho}_i \times \mathbf{F}_i \quad (7.6)$$

We also define the *angular momentum* of the rigid body by the product of a symmetric matrix of second moments of mass called the *inertia matrix* \mathbf{I}_c . The angular momentum vector about the center of mass is defined by

$$\mathbf{H}_c = \mathbf{I}_c \cdot \boldsymbol{\omega} \quad (7.7)$$

Since \mathbf{I}_c is a symmetric matrix, it can be diagonalized with principal inertias (or eigenvalues) $\{I_{ic}\}$ about principal directions (eigenvectors) $\{\mathbf{e}_1, \mathbf{e}_2, \mathbf{e}_3\}$. In these coordinates, which are attached to the body, the angular momentum about the center of mass becomes

$$\mathbf{H}_c = I_{1c}\omega_1\mathbf{e}_1 + I_{2c}\omega_2\mathbf{e}_2 + I_{3c}\omega_3\mathbf{e}_3 \quad (7.8)$$

where the angular velocity vector is written in terms of principal eigenvectors $\{\mathbf{e}_1, \mathbf{e}_2, \mathbf{e}_3\}$ attached to the rigid body.

Euler's extension of Newton's law for a rigid body is then given by

$$\dot{\mathbf{H}}_c = \mathbf{M}_c \quad (7.9)$$

This equation says that the change in the angular momentum about the center of mass is equal to the total moment of all the forces about the center of mass. The equation can also be applied about a fixed point of rotation, which is not necessarily the center of mass, as in the example of the compound pendulum given below.

Equations (7.4) and (7.9) are known as the Newton–Euler equations of motion. Without constraints, they represent six coupled second order differential equations for the position of the center of mass and for the angular orientation of the rigid body.

Multibody Dynamics

In a serial link robot arm, as shown in Fig. 7.2, we have a set of connected rigid bodies. Each body is subject to both applied and constraint forces and moments. The dynamical equations of motion involve the solution of the Newton–Euler equations for each rigid link subject to the geometric or kinematics constraints between each of the bodies as in (7.2). The forces on each body will have applied terms \mathbf{F}^a , from actuators or external mechanical sources, and internal constraint forces \mathbf{F}^c . When friction is absent, the work done by these constraint forces is zero. This property can be used to write equations of motion in terms of scalar energy functions, known as Lagrange’s equations (see below).

Whatever the method used to derive the equation of motions, the dynamical equations of motion for multibody systems in terms of generalized coordinates $\{q_k(t)\}$ have the form

$$\sum m_{ij}\ddot{q}_j + \sum \sum \mu_{ijk}\dot{q}_j\dot{q}_k = Q_i \quad (7.10)$$

The first term on the left involves a generalized symmetric mass matrix $m_{ij} = m_{ji}$. The second term includes Coriolis and centripetal acceleration. The right-hand side includes all the force and control terms. This equation has a quadratic nonlinearity in the generalized velocities. These quadratic terms usually drop out for rigid body problems with a single axis of rotation. However, the nonlinear inertia terms generally appear in problems with simultaneous rotation about two or three axes as in multi-link robot arms (Fig. 7.2), gyroscope problems, and slewing momentum wheels in satellites.

In modern dynamic simulation software, called multibody codes, these equations are automatically derived and integrated once the user specifies the geometry, forces, and controls. Some of these codes are called ADAMS, DADS, Working Model, and NEWEUL. However, the designer must use caution as these codes are sometimes poor at modeling friction and impacts between bodies.

7.5 Simple Dynamic Models

Two simple examples of the application of the angular momentum law are now given. The first is for rigid body rotation about a single axis and the second has two axes of rotation.

Compound Pendulum

When a body is constrained to a single rotary degree of freedom and is acted on by the force of gravity as in Fig. 7.5, the equation of motion takes the form, where θ is the angle from the vertical,

$$I\ddot{\theta} - (m_1L_1 - m_2L_2)g \sin \theta = T(t) \quad (7.11)$$

where $T(t)$ is the applied torque, $I = m_1L_1^2 + m_2L_2^2$ is the moment of inertia (properly called the second moment of mass). The above equation is nonlinear in the sine function of the angle. In the case of small motions about $\theta = 0$, the equation becomes a linear differential equation and one can look for solutions of the form $\theta = A \cos \omega t$, when $T(t) = 0$. For this case the pendulum exhibits sinusoidal motion with

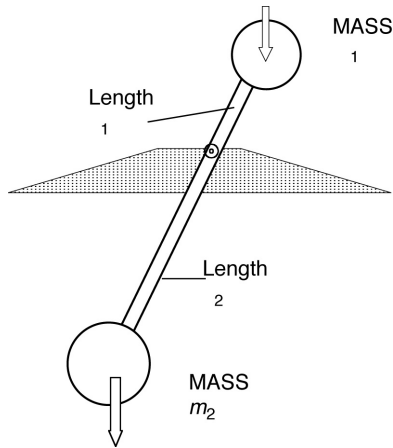

FIGURE 7.5 Sketch of a compound pendulum under gravity torques.

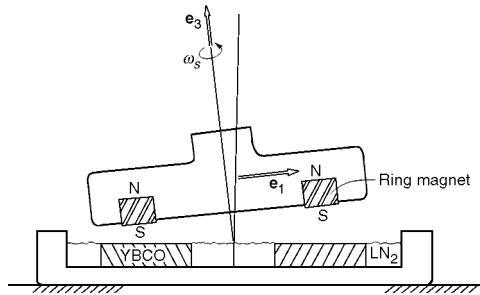

FIGURE 7.6 Sketch of a magnetically levitated flywheel on high-temperature superconducting bearings.

natural frequency

$$\omega = [g(m_2L_2 - m_1L_1)/I]^{1/2} \quad (7.12)$$

For the simple pendulum $m_1 = 0$, and we have the classic pendulum relation in which the natural frequency depends inversely on the square root of the length:

$$\omega = (g/L_2)^{1/2} \quad (7.13)$$

Gyroscopic Motions

Spinning devices such as high speed motors in robot arms or turbines in aircraft engines or magnetically levitated flywheels (Fig. 7.6) carry angular momentum, devoted by the vector \mathbf{H} . Euler's extension of Newton's laws says that a change in angular momentum must be accompanied by a force moment \mathbf{M} ,

$$\mathbf{M} = \dot{\mathbf{H}} \quad (7.14)$$

In three-dimensional problems one can often have components of angular momentum about two different axes. This leads to a Coriolis acceleration that produces a gyroscopic moment even when the two angular motions are steady. Consider the spinning motor with spin ϕ about an axis with unit vector \mathbf{e}_1 and

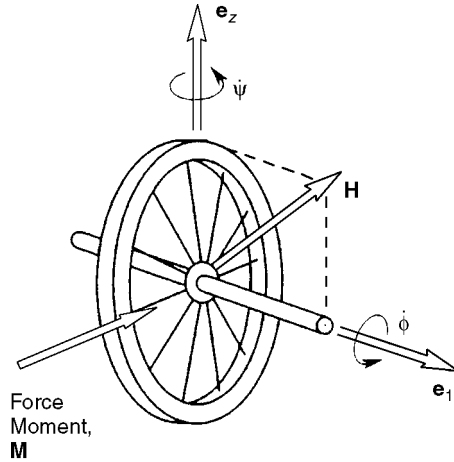

FIGURE 7.7 Gyroscopic moment on a precessing, spinning rigid body.

let us imagine an angular motion of the \mathbf{e}_1 axis, ψ about a perpendicular axis \mathbf{e}_z called the precession axis in gyroscope parlance. Then one can show that the angular momentum is given by

$$\mathbf{H} = I_1 \dot{\phi} \mathbf{e}_1 + I_z \dot{\psi} \mathbf{e}_z \quad (7.15)$$

and the rate of change of angular momentum for constant spin and precession rates is given by

$$\dot{\mathbf{H}} = \dot{\psi} \mathbf{e}_z \times \mathbf{H} \quad (7.16)$$

There must then exist a gyroscopic moment, often produced by forces on the bearings of the axel (Fig. 7.7). This moment is perpendicular to the plane formed by \mathbf{e}_1 and \mathbf{e}_z , and is proportional to the product of the rotation rates:

$$\mathbf{M} = I_1 \dot{\phi} \dot{\psi} \mathbf{e}_z \times \mathbf{e}_1 \quad (7.17)$$

This has the same form as Eq. (7.10), when the generalized force Q is identified with the moment \mathbf{M} , i.e., the moment is the product of generalized velocities when the second derivative acceleration terms are zero.

7.6 Elastic System Modeling

Elastic structures take the form of cables, beams, plates, shells, and frames. For linear problems one can use the method of eigenmodes to represent the dynamics with a finite set of modal amplitudes for generalized degrees of freedom. These eigenmodes are found as solutions to the PDEs of the elastic structure (see, e.g., Yu, 1996).

The simplest elastic structure after the cable is a one-dimensional beam shown in Fig. 7.8. For small motions we assume only transverse displacements $w(x, t)$, where x is a spatial coordinate along the beam. One usually assumes that the stresses on the beam cross section can be integrated to obtain stress vector resultants of shear V , bending moment M , and axial load T . The beam can be loaded with point or concentrated forces, end forces or moment or distributed forces as in the case of gravity, fluid forces, or electromagnetic forces. For a distributed transverse load $f(x, t)$, the equation of motion is given by

$$D \frac{\partial^4 w}{\partial x^4} - T \frac{\partial^2 w}{\partial x^2} + \rho A \frac{\partial^2 w}{\partial t^2} = f(x, t) \quad (7.18)$$

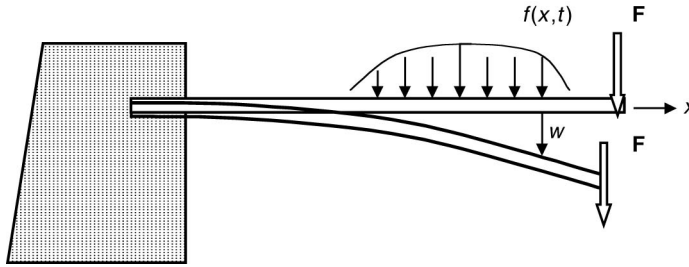

FIGURE 7.8 Sketch of an elastic cantilevered beam.

where D is the bending stiffness, A is the cross-sectional area of the beam, and ρ is the density. For a beam with Young's modulus Y , rectangular cross section of width b , and height h , $D = Ybh^3/12$. For $D = 0$, one has a cable or string under tension T , and the equation takes the form of the usual wave equation. For a beam with tension T , the natural frequencies are increased by the addition of the second term in the equation. For $T = -P$, i.e., a compressive load on the end of the beam, the curvature term leads to a decrease of natural frequency with increase of the compressive force P . If the lowest natural frequency goes to zero with increasing load P , the straight configuration of the beam becomes unstable or undergoes *buckling*. The use of T or $(-P)$ to stiffen or destiffen a beam structure can be used in design of sensors to create a sensor with variable resonance. This idea has been used in a MEMS accelerometer design (see below).

Another feature of the beam structure dynamics is the fact that unlike the string or cable, the frequencies of the natural modes are not commensurate due to the presence of the fourth-order derivative term in the equation. In wave type problems this is known as *wave dispersion*. This means that waves of different wavelengths travel at different speeds so that wave pulse shapes change their form as the wave moves through the structure.

In order to solve dynamic problems in finite length beam structures, one must specify boundary conditions at the ends. Examples of boundary conditions include

$$\begin{aligned}
 \text{clamped end} \quad w = 0, \quad \frac{\partial w}{\partial x} = 0 \\
 \text{pinned end} \quad w = 0, \quad \frac{\partial^2 w}{\partial x^2} = 0 \text{ (zero moment)} \\
 \text{free end} \quad \frac{\partial^2 w}{\partial x^2} = 0, \quad \frac{\partial^3 w}{\partial x^3} = 0 \text{ (zero shear)}
 \end{aligned} \tag{7.19}$$

Piezoelastic Beam

Piezoelastic materials exhibit a coupling between strain and electric polarization or voltage. Thus, these materials can be used for sensors or actuators. They have been used for active vibration suppression in elastic structures. They have also been explored for active optics space applications. Many natural materials exhibit piezoelasticity such as quartz as well as manufactured materials such as barium titanate, lead zirconate titanate (PZT), and polyvinylidene fluoride (PVDF). Unlike forces on charges and currents (see below), the electric effect takes place through a change in shape of the material. The modeling of these devices can be done by modifying the equations for elastic structures.

The following work on piezo-benders is based on the work of Lee and Moon (1989) as summarized in Miu (1993). One of the popular configurations of a piezo actuator-sensor is the piezo-bender shown in Fig. 7.9. The elastic beam is of rectangular cross section as is the piezo element. The piezo element

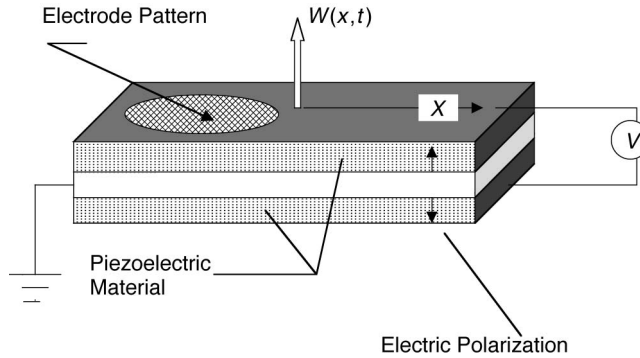

FIGURE 7.9 Elastic beam with two piezoelectric layers (Lee and Moon, 1989).

can be cemented on one or both sides of the beam either partially or totally covering the surface of the non-piezo substructure.

In general the local electric dipole polarization depends on the six independent strain components produced by normal and shear stresses. However, we will assume that the transverse voltage or polarization is coupled to the axial strain in the plate-shaped piezo layers. The constitutive relations between axial stress and strain, T , S , electric field and electric displacement, E_3 , D_3 (not to be confused with the bending stiffness D), are given by

$$T_1 = c_{11}S_1 - e_{31}E_3, \quad D_3 = e_{31}S_1 + \epsilon_3E_3 \quad (7.20)$$

The constants c_{11} , e_{31} , ϵ_3 , are the elastic stiffness modulus, piezoelectric coupling constant, and the electric permittivity, respectively.

If the piezo layers are polled in the opposite directions, as shown in the Fig. 7.9, an applied voltage will produce a strain extension in one layer and a strain contraction in the other layer, which has the effect of an applied moment on the beam. The electrodes applied to the top and bottom layers of the piezo layers can also be shaped so that there can be a gradient in the average voltage across the beam width. For this case the equation of motion of the composite beam can be written in the form

$$D \frac{\partial^4 w}{\partial x^4} + \rho A \frac{\partial^2 w}{\partial t^2} = -2e_{31}z_o \frac{\partial^2 V_3}{\partial x^2} \quad (7.21)$$

where $z_o = (h_s + h_p)/2$.

The z term is the average of piezo plate and substructure thicknesses. When the voltage is uniform, then the right-hand term results in an applied moment at the end of the beam proportional to the transverse voltage.

7.7 Electromagnetic Forces

One of the keys to modeling mechatronic systems is the identification of the electric and magnetic forces. Electric forces act on charges and electric polarization (electric dipoles). Magnetic forces act on electric currents and magnetic polarization. Electric charge and current can experience a force in a uniform electric or magnetic field; however, electric and magnetic dipoles will only produce a force in an electric or magnetic field gradient.

Electric and magnetic forces can also be calculated using both direct vector methods as well as from energy principles. One of the more popular methods is *Lagrange's equation* for electromechanical systems described below.

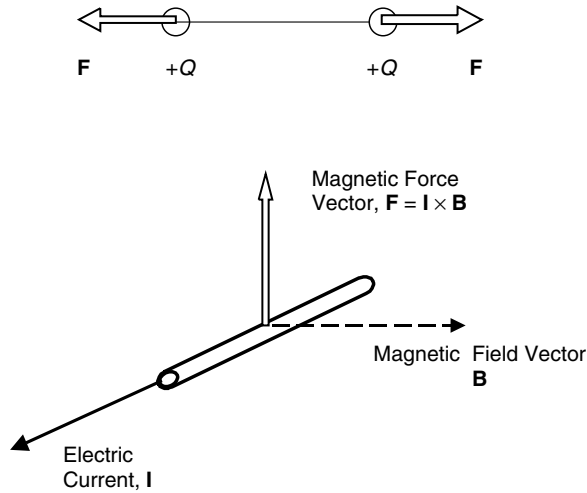

FIGURE 7.10 Electric forces on two charges (top). Magnetic force on a current carrying wire element (bottom).

Electromagnetic systems can be modeled as either distributed field quantities, such as electric field \mathbf{E} or magnetic flux density \mathbf{B} or as lumped element electric and magnetic circuits. The force on a point charge Q is given by the vector equation (Fig. 7.10):

$$\mathbf{F} = Q\mathbf{E} \quad (7.22)$$

When \mathbf{E} is generated by a single charge, the force between charges Q_1 and Q_2 is given by

$$F = \frac{Q_1 Q_2}{4\pi\epsilon_0 r^2} \quad (7.23)$$

and is directed along the line connecting the two charges. Like charges repel and opposite charges attract one another.

The magnetic force per unit length on a current element \mathbf{I} is given by the cross product

$$\mathbf{F} = \mathbf{I} \times \mathbf{B} \quad (7.24)$$

where the magnetic force is perpendicular to the plane of the current element and the magnetic field vector. The total force on a closed circuit in a uniform field can be shown to be zero. Net forces on closed circuits are produced by field gradients due to other current circuits or field sources.

Forces produced by field distributions around a volume containing electric charge or current can be calculated using the field quantities of \mathbf{E} , \mathbf{B} directly using the concept of magnetic and electric stresses, which was developed by Faraday and Maxwell. These electromagnetic stresses must be integrated over an area surrounding the charge or current distribution. For example, a solid containing a current distribution can experience a *magnetic pressure*, $P = B_t^2/2\mu_0$, on the surface element and a *magnetic tension*, $t_n = B_n^2/2\mu_0$, where the magnetic field components are written in terms of values tangential and normal to the surface. Thus, a one-tesla magnetic field outside of a solid will experience 40 N/cm^2 pressure if the field is tangential to the surface.

In general there are four principal methods to calculate electric and magnetic forces:

- direct force vectors and moments between electric charges, currents, and dipoles;
- electric field-charge and magnetic field-current force vectors;

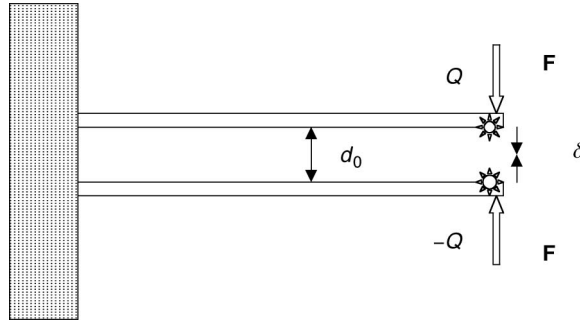

FIGURE 7.11 Two elastic beams with electric charges at the ends.

- electromagnetic tensor, integration of electric tension, magnetic pressure over the surface of a material body; and
- energy methods based on gradients of magnetic and electric energy.

Examples of the direct method and stress tensor method are given below. The energy method is described in the section on Lagrange's equations.

Example 1. Charge–Charge Forces

Suppose two elastic beams in a MEMS device have electric charges Q_1, Q_2 coulombs each concentrated at their tips (Fig. 7.11). The electric force between the charges is given by the vector

$$\mathbf{F} = \frac{Q_1 Q_2 \mathbf{r}}{4\pi\epsilon_0 r^3} \quad (\text{newtons}) \quad (7.25)$$

where $1/4\pi\epsilon_0 = 8.99 \times 10^9 \text{ Nm}^2/\text{C}^2$.

If the initial separation between the beams is d_0 , we seek the new separation under the electric force. For simplicity, we let $Q_1 = -Q_2 = Q$, where opposite charges create an attractive force between the beam tips. The deflection of the cantilevers is given by

$$\delta = \frac{FL^3}{3YI} = \frac{1}{k}F \quad (7.26)$$

where L is the length, Y the Young's modulus, I the second moment of area, and k the effective spring constant.

Under the electric force, the new separation is $d = d_0 - 2\delta$,

$$k\delta = \frac{Q^2}{4\pi\epsilon_0(d_0 - 2\delta)^2} \quad (7.27)$$

For $\delta \ll d_0$ to first order we have

$$\delta = \frac{Q^2/4\pi\epsilon_0 d_0^2 k}{1 - (1/d_0^3)(Q^2/k\pi\epsilon_0)} \quad (7.28)$$

This problem shows the potential for electric field buckling because as the beam tips move closer together, the attractive force between them increases. The nondimensional expression in the denominator

$$\frac{Q^2}{\pi\epsilon_0 d_0^3 k} \quad (7.29)$$

is the ratio of the negative electric stiffness to the elastic stiffness k of the beams.

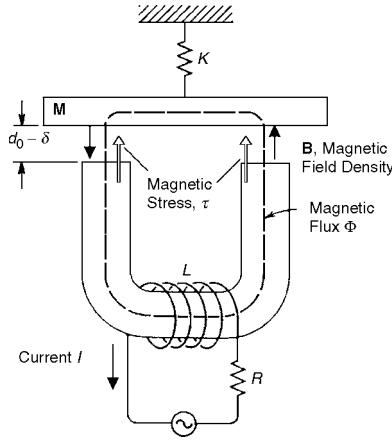

FIGURE 7.12 Force on a ferromagnetic bar near an electromagnet.

Example 2. Magnetic Force on an Electromagnet

Imagine a ferromagnetic keeper on an elastic restraint of stiffness k , as shown in Fig. 7.12. Under the soft magnetic keeper, we place an electromagnet which produces N turns of current I around a soft ferromagnetic core. The current is produced by a voltage in a circuit with resistance R .

The magnetic force will be calculated using the *magnetic stress tensor* developed by Maxwell and Faraday (see, e.g., Moon, 1984, 1994). Outside a ferromagnetic body, the stress tensor is given by \mathbf{t} and the stress vector on the surface defined by normal \mathbf{n} is given by $\boldsymbol{\tau} = \mathbf{t} \cdot \mathbf{n}$:

$$\boldsymbol{\tau} = \frac{1}{\mu_0} \left(\frac{1}{2} [B_n^2 - B_t^2], B_n B_t \right) = (\tau_n, \tau_t) \quad (7.30)$$

For high magnetic permeability as in a ferromagnetic body, the tangential component of the magnetic field outside the surface is near zero. Thus the force is approximately normal to the surface and is found from the integral of the magnetic tension over the surface:

$$\mathbf{F} = \frac{1}{2\mu_0} \int B_n^2 \mathbf{n} \, dA \quad (7.31)$$

and $B_n^2/2\mu_0$ represents a magnetic tensile stress. Thus, if the area of the pole pieces of the electromagnet is A (neglecting fringing of the field), the force is

$$F = B_g^2 A / \mu_0 \quad (7.32)$$

where B_g is the gap field. The gap field is determined from Amperes law

$$NI = \widehat{R} \Phi, \quad \Phi = B_g A \quad (7.33)$$

where the *reluctance* is approximately given by

$$\widehat{R} = \frac{2(d_0 - \delta)}{\mu_0 A} \quad (7.34)$$

The balance of magnetic and elastic forces is then given by

$$F = \frac{1}{\mu_0 A} \Phi^2 = \frac{1}{\mu_0 A} \left(\frac{NI}{R} \right)^2 = k\delta \quad (7.35)$$

or

$$\frac{(NI)^2}{4(d_0 - \delta)^2} \mu_0 A = k\delta, \quad \frac{\mu_0 N^2 I^2 A}{4(d_0 - \delta)^2} = k\delta$$

(Note that the expression $\mu_0 N^2 I^2$ has units of force.) Again as the current is increased, the total elastic and electric stiffness goes to zero and one has the potential for buckling.

7.8 Dynamic Principles for Electric and Magnetic Circuits

The fundamental equations of electromagnetics stem from the work of nineteenth century scientists such as Faraday, Henry, and Maxwell. They take the form of partial differential equations in terms of the field quantities of electric field \mathbf{E} and magnetic flux density \mathbf{B} , and also involve volumetric measures of charge density q and current density \mathbf{J} (see, e.g., Jackson, 1968). Most practical devices, however, can be modeled with lumped electric and magnetic circuits. The standard resistor, capacitor, inductor circuit shown in Fig. 7.13 uses electric current I (amperes), charge Q (coulombs), magnetic flux Φ (webers), and voltage V (volts) as dynamic variables. The voltage is the integral of the electric field along a path:

$$V_{21} = \int_1^2 \mathbf{E} \cdot d\mathbf{l} \quad (7.36)$$

The charge Q is the integral of charge density q over a volume, and electric current I is the integral of normal component of \mathbf{J} across an area. The magnetic flux Φ is given as another surface integral of magnetic flux.

$$\Phi = \int \mathbf{B} \cdot d\mathbf{A} \quad (7.37)$$

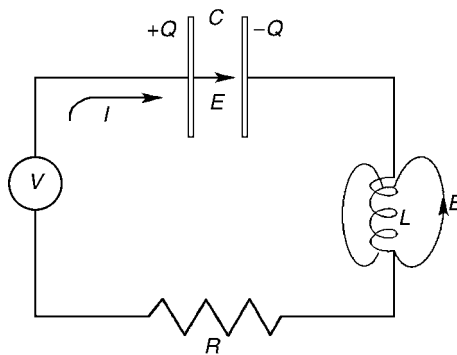

FIGURE 7.13 Electric circuit with lumped parameter capacitance, inductance, and resistance.

When there are no mechanical elements in the system, the dynamical equations take the form of conservation of charge and the Faraday–Henry law of flux change.

$$\frac{dQ}{dt} = I \quad (\text{Conservation of charge}) \quad (7.38)$$

$$\frac{d\phi}{dt} = V \quad (\text{Law of flux change}) \quad (7.39)$$

where $\phi = N\Phi$ is called the number of flux linkages, and N is an integer. In electromagnetic circuits the analog of mechanical constitutive properties is inductance L and capacitance C . The magnetic flux in an inductor, for example, often depends on the current I .

$$\phi = f(I) \quad (7.40)$$

For a linear inductor we have a definition of inductance L , i.e., $\phi = LI$. If the system has a mechanical state variable such as displacement x , as in a magnetic solenoid actuator, then L may be a function of x .

In charge storage circuit elements, the capacitance C is defined as

$$Q = CV \quad (7.41)$$

In MEMS devices and in microphones, the capacitance may also be a function of some generalized mechanical displacement variable.

The voltages across the different circuit elements can be active or passive. A pure voltage source can maintain a given voltage, but the current depends on the passive voltages across the different circuit elements as summarized in the Kirchhoff circuit law:

$$\frac{d}{dt} L(x)I + \frac{Q}{C(x)} + RI = V(t) \quad (7.42)$$

Lagrange's Equations of Motion for Electromechanical Systems

It is well known that the Newton–Euler equations of motion for mechanical systems can be derived using an energy principle called Lagrange's equation. In this method one identifies generalized coordinates $\{q_k\}$, not to be confused with electric charges, and writes the kinetic energy of the system T in terms of generalized velocities and coordinates, $T(\dot{q}_k, q_k)$. Next the mechanical forces are split into so-called conservative forces, which can be derived from a potential energy function $W(q_k)$ and the rest of the forces, which are represented by a generalized force Q_k corresponding to the work done by the k th generalized coordinate. Lagrange's equations for mechanical systems then take the form:

$$\frac{d}{dt} \frac{\partial T(\dot{q}_k, q_k)}{\partial \dot{q}_k} - \frac{\partial T}{\partial q_k} + \frac{\partial W(q_k)}{\partial q_k} = Q_k \quad (7.43)$$

For example, in a linear spring–mass–damper system, with mass m , spring constant k , viscous damping constant c , and one generalized coordinate $q_1 = x$, the equation of motion can be derived using, $T = \frac{1}{2} m\dot{x}^2$, $W = \frac{1}{2} kx^2$, $Q_1 = -c\dot{x}$, in Lagrange's equation above. What is remarkable about this formulation is that it can be extended to treat both electromagnetic circuits and coupled electromechanical problems.

As an example of the application of Lagrange's equations to a coupled electromechanical problem, consider the one-dimensional mechanical device, shown in Fig. 7.14, with a magnetic actuator and a capacitance actuator driven by a circuit with applied voltage $V(t)$. We can extend Lagrange's equation to

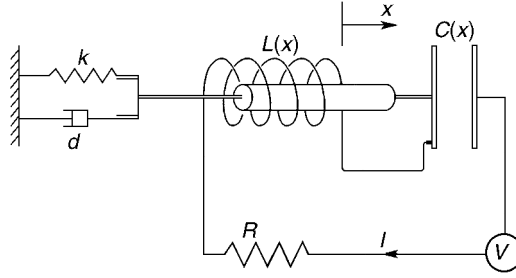

FIGURE 7.14 Coupled lumped parameter electromechanical system with single degree of freedom mechanical motion $x(t)$.

circuits by defining the charge on the capacitor, Q , as another generalized coordinate along with x , i.e., in Lagrange's formulation, $q_1 = x$, $q_2 = Q$. Then we add to the kinetic energy function a magnetic energy function $W_m(\dot{Q}, x)$, and add to the potential energy an electric field energy function $W_e(Q, x)$. The equations of both the mass and the circuit can then be derived from

$$\frac{d}{dt} \frac{\partial [T + W_m]}{\partial \dot{q}_k} - \frac{\partial [T + W_m]}{\partial q_k} + \frac{\partial [W + W_e]}{\partial q_k} = Q_k \quad (7.44)$$

The generalized force must also be modified to account for the energy dissipation in the resistor and the energy input of the applied voltage $V(t)$, i.e., $Q_1 = -c\dot{x}$, $Q_2 = -R\dot{Q} + V(t)$. In this example the magnetic energy is proportional to the inductance $L(x)$, and the electric energy function is inversely proportional to the capacitance $C(x)$. Applying Lagrange's equations automatically results in expressions for the magnetic and electric forces as derivatives of the magnetic and electric energy functions, respectively, i.e.,

$$W_m = \frac{1}{2}L(x)\dot{Q}^2 = \frac{1}{2}L\dot{I}^2, \quad W_e = \frac{1}{2C(x)}Q^2 \quad (7.45)$$

$$F_m = \frac{\partial W_m(x, \dot{Q})}{\partial x} = \frac{1}{2}\dot{I}^2 \frac{dL(x)}{dx}, \quad F_e = -\frac{\partial W_e(x, Q)}{\partial x} = -\frac{1}{2}Q^2 \frac{d}{dx} \left[\frac{1}{C(x)} \right] \quad (7.46)$$

These remarkable formulii are very useful in that one can calculate the electromagnetic forces by just knowing the dependence of the inductance and capacitance on the displacement x . These functions can often be found from electrical measurements of L and C .

Example: Electric Force on a Comb-Drive MEMS Actuator

Consider the motion of an elastically constrained plate between two grounded fixed plates as in a MEMS comb-drive actuator in Fig. 7.15. When the moveable plate has a voltage V applied, there is stored electric field energy in the two gaps given by

$$W_e^*(V, x) = \frac{1}{2}\epsilon_0 V^2 A \frac{d_0}{d_0^2 - x^2} \quad (7.47)$$

In this expression the electric energy function is written in terms of the voltage V instead of the charge on the plates Q as in Eqs. (7.45) and (7.46). Also the initial gap is d_0 , and the area of the plate is A .

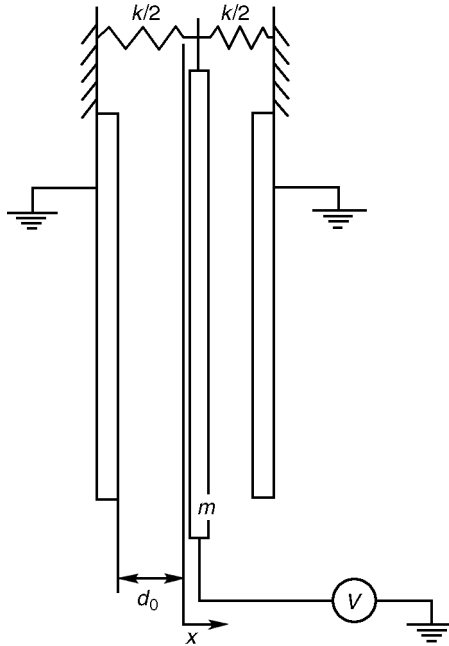

FIGURE 7.15 Example of electric force on the elements of a comb-drive actuator.

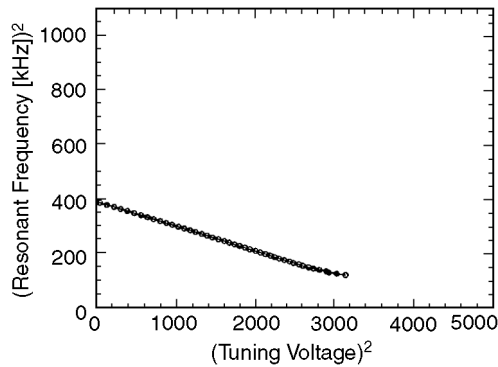

FIGURE 7.16 Decrease in natural frequency of a MEMS device with applied voltage as an example of negative electric stiffness [From Adams (1996)].

Using the force expressions derived from Lagrange's equations (7.44), the electric charge force on the plate is given by

$$F_e = \frac{\partial}{\partial x} W_e^*(V, x) = \frac{\epsilon_0 V^2 A}{d_0} \frac{x}{(1 - x^2/d^2)^2} \quad (7.48)$$

This expression shows that the electric stiffness is negative for small x , which means that the voltage will decrease the natural frequency of the plate. This idea has been applied to a MEMS comb-drive actuator by Adams (1996) in which the voltage could be used to tune the natural frequency of a MEMS accelerometer, as shown in Fig. 7.16.

7.9 Earnshaw's Theorem and Electromechanical Stability

It is not well known that electric and magnetic forces in mechanical systems can produce static instability, otherwise known as *elastic buckling* or *divergence*. This is a consequence of the inverse square nature of many electric and magnetic forces. It is well known that the electric and magnetic field potential Φ satisfies Laplace's equation, $\nabla^2\Phi = 0$. There is a basic theorem in potential theory about the impossibility of a relative maximum or minimum value of a potential $\Phi(\mathbf{r})$ for solutions of Laplace's equation except at a boundary. It was stated in a theorem by Earnshaw (1829) that it is impossible for a static set of charges, magnetic and electric dipoles, and steady currents to be in a stable state of equilibrium without mechanical or other feedback or dynamic forces (see, for example, Moon, 1984, 1994).

One example of Earnshaw's theorem is the instability of a magnetic dipole (e.g., a permanent magnet) near a ferromagnetic surface (Fig. 7.17). Levitated bearings based on ferromagnetic forces, for example, require feedback control. Earnshaw's theorem also implies that if there is one degree of freedom with stable restoring forces, there must be another degree of freedom that is unstable. Thus the equilibrium positions for a pure electric or magnetic system of charges and dipoles must be saddle points. The implication for the force potentials is that the matrix of second derivatives is not positive definite. For example, suppose there are three generalized position coordinates $\{s_i\}$ for a set of electric charges. Then if the generalized forces are proportional to the gradient of the potential, $\nabla\Phi$, then the generalized electric stiffness matrix \mathbf{K}_{ij} given by

$$\mathbf{K}_{ij} = \left[\frac{\partial^2\Phi}{\partial s_i \partial s_j} \right]$$

will not be positive definite. This means that at least one of the eigenvalues will have negative stiffness.

Another example of electric buckling is a beam in an electric field with charge induced by an electric field on two nearby stationary plates as in Fig. 7.15. The induced charge on the beam will be attracted to either of the two plates, but is resisted by the elastic stiffness of the beam. As the voltage is increased, the combined electric and elastic stiffnesses will decrease until the beam buckles to one or the other of the two sides. Before buckling, however, the natural frequency of the charged beam will decrease (Fig. 7.16). This property has been observed experimentally in a MEMS device. A similar magneto elastic buckling is observed for a thin ferromagnetic elastic beam in a static magnetic field (see Moon, 1984). Both electroelastic and magnetoelastic buckling are derived from the same principle of Earnshaw's theorem.

There are dramatic exceptions to Earnshaw's stability theorem. One of course is the levitation of 50-ton vehicles with magnetic fields, known as MagLev, or the suspension of gas pipeline rotors using feedback controlled magnetic bearings (see Moon, 1994). Here either the device uses feedback forces, i.e., the fields

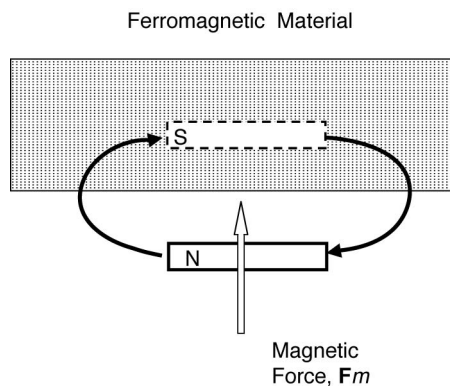

FIGURE 7.17 Magnetic force on a magnetic dipole magnet near a ferromagnetic half space with image dipole shown.

are not static, or the source of one of the magnetic fields is a superconductor. Diamagnetic forces are exceptions to Earnshaw's theorem, and superconducting materials have properties that behave like diamagnetic materials. Also new high-temperature superconductivity materials, such as YBaCuO, exhibit magnetic flux pinning forces that can be utilized for stable levitation in magnetic bearings without feedback (see Moon, 1994).

References

- Adams, S. G. (1996), *Design of Electrostatic Actuators to Tune the Effective Stiffness of Micro-Mechanical Systems*, Ph.D. Dissertation, Cornell University, Ithaca, New York.
- Goldstein, H. (1980), *Classical Mechanics*, Addison-Wesley, Reading, MA.
- Jackson, J. D. (1968), *Classical Electrodynamics*, J. Wiley & Sons, New York.
- Lee, C. K. and Moon, F. C. (1989), "Laminated piezopolymer plates for bending sensors and actuators," *J. Acoust. Soc. Am.*, **85**(6), June 1989.
- Melcher, J. R. (1981), *Continuum Electrodynamics*, MIT Press, Cambridge, MA.
- Miu, D. K. (1993), *Mechatronics*, Springer-Verlag, New York.
- Moon, F. C. (1984), *Magneto-Solid Mechanics*, J. Wiley & Sons, New York.
- Moon, F. C. (1994), *Superconducting Levitation*, J. Wiley & Sons, New York.
- Moon, F. C. (1999), *Applied Dynamics*, J. Wiley & Sons, New York.
- Yu, Y.-Y. (1996), *Vibrations of Elastic Plates*, Springer-Verlag, New York.

8

Structures and Materials

- 8.1 **Fundamental Laws of Mechanics**
Statics and Dynamics of Mechatronic Systems • Equations of Motion of Deformable Bodies • Electric Phenomena
- 8.2 **Common Structures in Mechatronic Systems**
Beams • Torsional Springs • Thin Plates
- 8.3 **Vibration and Modal Analysis**
- 8.4 **Buckling Analysis**
- 8.5 **Transducers**
Electrostatic Transducers • Electromagnetic Transducers • Thermal Actuators • Electroactive Polymer Actuators
- 8.6 **Future Trends**

Eniko T. Enikov
University of Arizona

The term mechatronics was first used by Japanese engineers to define a mechanical system with embedded electronics, capable of providing intelligence and control functions. Since then, the continued progress in integration has led to the development of microelectromechanical systems (MEMS) in which the mechanical structures themselves are part of the electrical subsystem. The development and design of such mechatronic systems requires interdisciplinary knowledge in several disciplines—electronics, mechanics, materials, and chemistry. This section contains an overview of the main mechanical structures, the materials they are built from, and the governing laws describing the interaction between electrical and mechanical processes. It is intended for use in the initial stage of the design, when quick estimates are necessary to validate or reject a particular concept. Special attention is devoted to the newly emerging smart materials—electroactive polymer actuators. Several tables of material constants are also provided for reference.

8.1 Fundamental Laws of Mechanics

Statics and Dynamics of Mechatronic Systems

The fundamental laws of mechanics are the balance of linear and angular momentum. For an idealized system consisting of a point mass m moving with velocity \mathbf{v} , the linear momentum is defined as the product of the mass and the velocity:

$$\mathbf{L} = m\mathbf{v} \quad (8.1)$$

The conservation of linear momentum for a single particle postulates that the rate of change of linear momentum is equal to the sum of all forces acting on the particle

$$\dot{\mathbf{L}} = m\dot{\mathbf{v}} = \sum \mathbf{F}_i \quad (8.2)$$

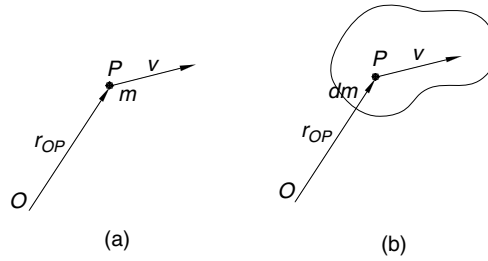

FIGURE 8.1 Definition of velocity and position vectors for single particle (a) and rigid body (b).

where we have assumed that the mass does not change over time. The angular momentum of a particle with respect to an arbitrary reference point O is defined as

$$\mathbf{H}_O = \mathbf{r}_{OP} \times (m\mathbf{v}) \quad (8.3)$$

where \mathbf{r}_{OP} is the position vector between points O and P (see Fig. 8.1(a)). The balance of angular momentum for a single infinitesimally small particle is automatically satisfied as a result of (8.1). In the case of multiple particles (a rigid body composed of infinite number of particles), the linear and angular momenta are defined as the sum (integral) of the momentum of individual particles (Fig. 8.1(b)):

$$\mathbf{L} = \int_V \mathbf{v} dm \quad \text{and} \quad \mathbf{H}_O = \int_V \mathbf{r}_{OP} \times \mathbf{v} dm \quad (8.4)$$

The second fundamental law of classical mechanics states that the rate of change of angular momentum is equal to the sum of all moments acting on the body:

$$\dot{\mathbf{H}}_O = \sum_i \mathbf{M}_i + \sum_i \mathbf{r}_i \times \mathbf{F}_i \quad (8.5)$$

where \mathbf{M}_i are the applied external force-couples in addition to the forces \mathbf{F}_i . If the reference point O is chosen to be the center of mass of the body G , the linear and angular momentum balance law take a simpler form:

$$m\dot{\mathbf{v}}_G = \sum_i \mathbf{F}_i \quad (8.6)$$

$$I_G \dot{\boldsymbol{\omega}} = \sum_j \mathbf{M}_j + \sum_i \mathbf{r}_i \times \mathbf{F}_i \quad (8.7)$$

where $\boldsymbol{\omega}$ is the instantaneous vector of angular velocity and I_G is the moment of inertia about the center of mass. Equations (8.6) and (8.7) are called equations of motion and play a central role in the dynamics of rigid bodies. If there is no motion (linear and angular velocities are zero), one is faced with a *statics problem*. Conversely, when the accelerations are large, we need to solve the complete system of Eqs. (8.6) and (8.7) including the inertial terms. In mechatronic systems the mechanical response is generally slower than the electrical one and therefore determines the overall response. If the response time is critical to the application, one needs to consider the inertial terms in Eqs. (8.6) and (8.7).

Equations of Motion of Deformable Bodies

Rigid bodies do not change shape or size during their motion, that is, the distance between the particles they are made of is constant. In reality, all objects deform to a certain extent when subjected to external forces. Whether a body can be treated as rigid or deformable is dictated by the particular application.

In this section we will review the fundamental equations describing the motion of deformable bodies. These equations also result from the balance of linear and angular momentum applied to an infinitesimally small portion of the material volume dV . Each element dV is subjected not only to external body force \mathbf{f} , but also to internal forces originating from the rest of the body. These internal forces are described by a second order tensor \mathbf{T} , called stress tensor. The balance of linear momentum can then be stated in integral form for an *arbitrary* portion of the body occupying volume V as

$$\frac{d}{dt} \int_V \rho \mathbf{v} dv = \int_{\partial V} \mathbf{T} \cdot \mathbf{n} dA + \int_V \mathbf{f} dv \quad (8.8)$$

where ρ is the mass density, \mathbf{v} is the velocity of the element dV , and \mathbf{f} is the force per unit volume acting upon dV . The above balance law states that the rate of change of linear momentum is equal to the sum of the internal force flux (stress) acting on the boundary of V and the external body force, distributed inside V . Applying the transport theorem to (8.8) along with the mass conservation law reduces the above to

$$\int_V \rho \dot{\mathbf{v}} dv = \int_V \nabla \cdot \mathbf{T} dv + \int_V \mathbf{f} dv \quad (8.9)$$

Since (8.9) is valid for an arbitrary volume, it follows that the integrands are also equal. Thus the local (differential) form of linear momentum balance is

$$\rho \dot{\mathbf{v}} = \nabla \cdot \mathbf{T} + \mathbf{f} \quad \text{or with index notation} \quad \rho \dot{v}_i = T_{ij,j} + f_i \quad (8.10)$$

Using analogous procedure, the balance of angular momentum can be shown to reduce to a simple symmetry condition of the stress tensor

$$T_{ij} = T_{ji} \quad (8.11)$$

which is valid for materials without external body couples. It should be mentioned that in certain anisotropic materials, the polarization or magnetization vectors can develop body couples, for example when $\mathbf{E} \times \mathbf{P} \neq \mathbf{0}$. In these cases the stress tensor is nonsymmetric and its vector invariant is equal to the body couple. Equations (8.10) are usually used in one of the three most common coordinate systems. For example, using rectangular coordinates we have

$$\begin{aligned} \frac{\partial T_{xx}}{\partial x} + \frac{\partial T_{xy}}{\partial y} + \frac{\partial T_{xz}}{\partial z} + f_x &= \rho a_x, & T_{xy} &= T_{yx} \\ \frac{\partial T_{yx}}{\partial x} + \frac{\partial T_{yy}}{\partial y} + \frac{\partial T_{yz}}{\partial z} + f_y &= \rho a_y, & T_{yz} &= T_{zy} \\ \frac{\partial T_{zx}}{\partial x} + \frac{\partial T_{zy}}{\partial y} + \frac{\partial T_{zz}}{\partial z} + f_z &= \rho a_z, & T_{xz} &= T_{zx} \end{aligned} \quad (8.12)$$

and in cylindrical coordinates

$$\begin{aligned} \frac{\partial T_{rr}}{\partial r} + \frac{T_{rr} - T_{\theta\theta}}{r} + \frac{1}{r} \frac{\partial T_{r\theta}}{\partial \theta} + \frac{\partial T_{rz}}{\partial z} + f_r &= \rho a_r, & T_{r\theta} &= T_{\theta r} \\ \frac{\partial T_{r\theta}}{\partial r} + \frac{2}{r} T_{r\theta} + \frac{1}{r} \frac{\partial T_{\theta\theta}}{\partial \theta} + \frac{\partial T_{\theta z}}{\partial z} + f_\theta &= \rho a_\theta, & T_{\theta z} &= T_{z\theta} \\ \frac{\partial T_{rz}}{\partial r} + \frac{1}{r} T_{rz} + \frac{1}{r} \frac{\partial T_{\theta z}}{\partial \theta} + \frac{\partial T_{zz}}{\partial z} + f_z &= \rho a_z, & T_{rz} &= T_{zr} \end{aligned} \quad (8.13)$$

where (x, y, z) and (r, θ, z) are the three coordinates, f 's are the corresponding body force densities, and a 's are the accelerations. In addition to Eqs. (8.12) or (8.13), a relation between the stress and the displacement is needed in order to determine the deformation. Since the rigid body translations and

rotations do not cause deformation of the body, they do not affect the internal stress field either. In fact, the latter is a function of the gradient of the displacement, called deformation gradient. When this gradient is small, a linear relationship between the displacements and strains can be used

$$\epsilon_x = \frac{\partial u_x}{\partial x}, \quad \epsilon_y = \frac{\partial u_y}{\partial y}, \quad \epsilon_z = \frac{\partial u_z}{\partial z}, \quad \epsilon_{xy} = \frac{\partial u_x}{\partial y} + \frac{\partial u_y}{\partial x}, \quad \epsilon_{xz} = \frac{\partial u_x}{\partial z} + \frac{\partial u_z}{\partial x}, \quad \epsilon_{zy} = \frac{\partial u_z}{\partial y} + \frac{\partial u_y}{\partial z} \quad (8.14)$$

The conservation of momentum and kinematic relations does not contain any information about the material. Constitutive laws provide this additional information. The most common such law describes a linear elastic material and can be conveniently expressed using a symmetric matrix c_{ij} called stiffness matrix:

$$\begin{bmatrix} T_{xx} \\ T_{yy} \\ T_{zz} \\ T_{yz} \\ T_{zx} \\ T_{xy} \end{bmatrix} = \begin{bmatrix} c_{11} & c_{12} & c_{13} & c_{14} & c_{15} & c_{16} \\ & c_{22} & c_{23} & c_{24} & c_{25} & c_{26} \\ & & c_{33} & c_{34} & c_{35} & c_{36} \\ & & & c_{44} & c_{45} & c_{46} \\ \text{symm.} & & & & c_{55} & c_{56} \\ & & & & & c_{66} \end{bmatrix} \cdot \begin{bmatrix} \epsilon_x \\ \epsilon_y \\ \epsilon_z \\ \epsilon_{yz} \\ \epsilon_{zx} \\ \epsilon_{xy} \end{bmatrix} \quad (8.15)$$

In the most general case, the matrix c_{ij} has 21 independent elements. When the material has a crystal symmetry, the number of independent constants is reduced. For example, single crystal Si is a common structural material in MEMS with a cubic symmetry. In this case there are only three independent constants:

$$\begin{bmatrix} T_{xx} \\ T_{yy} \\ T_{zz} \\ T_{yz} \\ T_{zx} \\ T_{xy} \end{bmatrix} = \begin{bmatrix} c_{11} & c_{12} & c_{12} & 0 & 0 & 0 \\ & c_{11} & c_{12} & 0 & 0 & 0 \\ & & c_{11} & 0 & 0 & 0 \\ & & & c_{44} & 0 & 0 \\ \text{symm.} & & & & c_{44} & 0 \\ & & & & & c_{44} \end{bmatrix} \cdot \begin{bmatrix} \epsilon_x \\ \epsilon_y \\ \epsilon_z \\ \epsilon_{yz} \\ \epsilon_{zx} \\ \epsilon_{xy} \end{bmatrix} \quad (8.16)$$

If the material is isotropic (amorphous or polycrystalline), the number of independent elastic constants is further reduced to two by the relation $c_{44} = (c_{11} - c_{12})/2$. The elastic constants of several most commonly used materials are listed in Table 8.1 (from [Kittel 1996]).

Additional information on other symmetry classes can be found in [Nye 1960].

TABLE 8.1 Elastic Constants of Several Common Cubic Crystals

| Crystal | Stiffness Constants at Room Temperature, 10^{11} N/m ² | | |
|---------|---|----------|----------|
| | c_{11} | c_{12} | c_{44} |
| W | 5.233 | 2.045 | 1.607 |
| Ta | 2.609 | 1.574 | 0.818 |
| Cu | 1.684 | 1.214 | 0.754 |
| Ag | 1.249 | 0.937 | 0.461 |
| Au | 1.923 | 1.631 | 0.420 |
| Al | 1.608 | 0.607 | 0.282 |
| K | 0.0370 | 0.0314 | 0.0188 |
| Pb | 0.495 | 0.423 | 0.149 |
| Ni | 2.508 | 1.500 | 1.235 |
| Pd | 2.271 | 1.761 | 0.17 |
| Si | 1.66 | 0.639 | 0.796 |

Electric Phenomena

In the previous section the laws governing the motion of rigid and deformable bodies were reviewed. The forces entering these equations are often of electromagnetic origin; thus one has to know the distribution of electric and magnetic fields. The electromagnetic field is governed by a set of four coupled equations known as Maxwell's equations. Similarly, to the momentum equations, these can also be postulated in integral form. Here we only give the local form

$$\begin{aligned}\dot{\mathbf{B}} + \nabla \times \mathbf{E} &= \mathbf{0} \\ \nabla \cdot \mathbf{D} &= q^f \\ \nabla \times \mathbf{H} - \dot{\mathbf{D}} &= \mathbf{i} \\ \nabla \cdot \mathbf{B} &= 0\end{aligned}\tag{8.17}$$

where \mathbf{E} is the electric field, \mathbf{D} is the electric displacement, \mathbf{B} is the magnetic induction, \mathbf{H} is the magnetic field strength, \mathbf{i} is the electric current density, and q^f is the free charge volume density. Equations (8.17) require constitutive laws specifying the current density, electric displacement, and magnetic field in terms of electric field and magnetic induction vectors. A linear form of these laws is given by

$$\mathbf{i} = \frac{\mathbf{E}}{\rho_e}, \quad \mathbf{D} = \varepsilon_0 \mathbf{E} + \mathbf{P}, \quad \mathbf{B} = \mu_0 \mathbf{H} + \mu_0 \mathbf{M} = \mu_0 \mu_r \mathbf{H}\tag{8.18}$$

where ρ_e is the electrical resistance. The coupling between electrical and mechanical fields can be linear or nonlinear. For example, piezoelectricity is a linear phenomenon describing the generation of electric field as a result of the application of mechanical stress. Electrostriction on the other hand is a second order effect, resulting in the generation of mechanical strain proportional to the square of the electric field. Other effects include piezoresistivity, i.e., a change of the electrical resistance due to mechanical stress. In addition to these material properties, electromechanical coupling can be achieved through direct use of electromagnetic forces (Lorentz force) as is commonly done in conventional electrical machines. Lorentz force per unit volume is given by

$$\mathbf{f}^L = q^f (\mathbf{E} + \mathbf{v} \times \mathbf{B})\tag{8.19}$$

where q^f is the volume charge density. Equation (8.19) accounts for the forces acting on free charge only. If the fields have strong gradients, the above expression should be modified to include the polarization and magnetization terms [Mauguin 1988].

$$\mathbf{f}^{\text{EM}} = q^f \mathbf{E} + \left(\mathbf{i} + \frac{\partial \mathbf{P}}{\partial t} \right) \times \mathbf{B} + \mathbf{P} \cdot \nabla \mathbf{E} + \nabla \mathbf{B} \cdot \mathbf{M}\tag{8.20}$$

Equation (8.19) or (8.20) can be used in the momentum equation (8.10) in place of the body force \mathbf{f} .

As mentioned earlier, piezoelectricity and piezoresistivity are the other commonly used effects in electromechanical systems. The piezoelectric effect occurs only in materials with certain crystal structure. Common examples include BaTiO₃ and lead zirconia titanate (PZT). In the quasi-electrostatic approximation (when the magnetic effects are neglected) there are four variables describing the electromechanical state of the body—electric field \mathbf{E} and displacement \mathbf{D} , mechanical stress \mathbf{T} and strain $\boldsymbol{\varepsilon}$. The constitutive laws of piezoelectricity are given as a set of two matrix equations between the four field variables, relating one mechanical and one electrical variable to the other two in the set

$$\boldsymbol{\varepsilon}_{ij} = s_{ijkl} T_{kl} + d_{ijk} E_k, \quad D_i = d_{ikl} T_{kl} + \varepsilon_0 \Xi_{ij} E_j\tag{8.21}$$

where s_{ijkl} is the elastic compliance tensor, d_{ijk} is the piezoelectric tensor, Ξ_{ij} is the electric permittivity tensor. If the electric field and the polarization vectors are co-linear, the stress and strain tensors are symmetric, and the number of independent coefficients in s_{ijkl} is reduced from 81 to 21 and for the piezoelectric tensor d_{ijk} from 27 to 18. If further, the piezoelectric is poled in one direction only (for example index 3),

the only nonzero elements are

$$d_{113}, d_{223}, d_{333}, d_{232} = d_{322}, d_{131} = d_{313}, d_{123} = d_{213}.$$

Numerical values for the coefficients in (8.22) for bulk BaTiO₃ crystals can be found in [Zgonik et al. 1994].

8.2 Common Structures in Mechatronic Systems

Microelectromechanical systems (MEMS) traditionally use technology developed for the manufacturing of integrated circuits. As a result, the employed mechanical structures are often planar devices—springs, coils, bridges, or cantilever beams, subjected to in-plane and out-of-plane bending and torsion. Using high aspect ratio reactive ion etching combined with fusion bonding of silicon, it is possible to realize true three-dimensional structures as well. For example Fig. 8.2 shows an SEM micrograph of a complex capacitive force sensor designed to accept glass fibers in an etched v-groove. In this section, we will review the fundamental relationships used in the initial designs of such electromechanical systems.

Beams

Microcantilevers are used in surface micromachined electrostatic switches, as “cantilever tip” for scanning probe microscopy (SPM) and in myriad of sensors, based on vibrating cantilevers. The majority of the surface micromachined beams fall into two cases—cantilever beams and bridges. Figure 8.3 illustrates a two-layer cantilever beam (Fig. 8.3(a)) and a bridge (Fig. 8.3(b)). The elastic force required to produce deflection d at the tip of the cantilever beam, or at the center of the bridge, is given by

$$F^{\text{elast}} = K_{\text{eff}} d \quad (8.22)$$

where

$$K_{\text{eff}} = \frac{24(EI)_{\text{eff}}}{(6l_e^3/5) + 6(l-l_e)l_e^2 + 12(l-l_e)^2l_e + 8(l-l_e)^3} \quad \text{and} \quad K_{\text{eff}} = \frac{360(EI)_{\text{eff}}}{30l^3 - 45ll_e^2 - 5(l_e^4/l) + 3l_e^3} \quad (8.23)$$

are the effective spring constants of the composite beams for cantilever and bridge beams, respectively. The effective stiffness of the beam in both cases can be calculated from

$$(EI)_{\text{eff}} = \frac{E_1 w t_1^3}{12} + \frac{E_2 w t_2^3}{12} + \frac{E_1 E_2 t_1 t_2 w (t_1 + t_2)^2}{4(E_1 t_1 + E_2 t_2)} \quad (8.24)$$

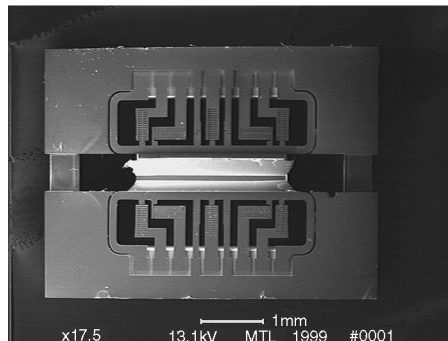

FIGURE 8.2 Capacitive force sensor using 3D micromachining.

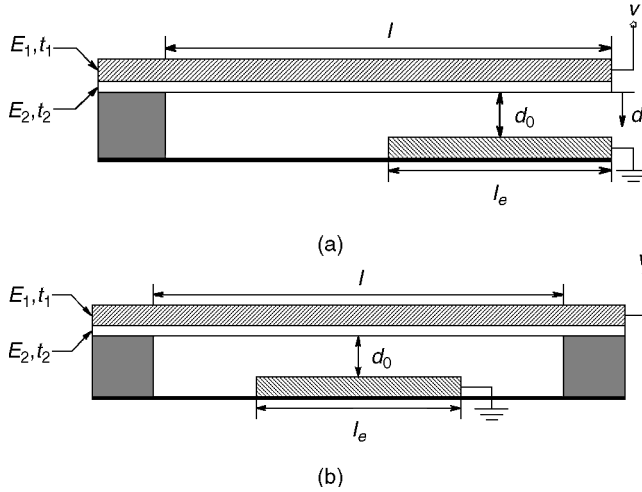

FIGURE 8.3 Surface micromachined beams: (a) Two-layer composite beam with electrostatic actuation; (b) two-layer composite bridge with electrostatic actuation.

where w is the width of the beam, t_1 the thickness of the top beam, t_2 the thickness of insulating layer (silicon oxide, silicon nitride), l the length of the beam, l_e the length of fixed electrode, E_1 the Young's modulus of the top layer, E_2 the Young's modulus of insulating layer.

Torsional Springs

Torsion of beams is used primarily in rotating structures such as micromirrors for optical scanning, or projection displays. The micromirror array developed by Texas Instruments for example uses polycrystalline silicon beams as hinges of the micromirror plate.

The torsion problems can be solved in a closed form for beams with elliptical or triangular cross sections [Mendleson 1968]. In the case of an elliptical cross section, the moment required to produce an angular twist (angle or rotation per unit length of the beam) α [rad/m] is equal to

$$M = \frac{\pi a^3 b^3}{a^2 + b^2} G \alpha \quad (8.25)$$

where G is the elastic shear modulus, and a and b are the lengths of the two semi-axes of the ellipse. The maximum shear stress in this case is

$$\tau^{\max} = \frac{2G\alpha a^2 b}{a^2 + b^2}, \quad a > b \quad (8.26)$$

The torsional stiffness of rectangular cross-section beams can be obtained in terms of infinite power series [Hopkins 1987]. If the cross-section has dimension $a \times b$, $b < a$, the first three term of this series result in an equation similar to (8.25)

$$M = 2KG\alpha, \quad \text{where } K = ab^3 \left[\frac{1}{3} - 0.21 \frac{b}{a} \left(1 - \frac{b^4}{12a^4} \right) \right]. \quad (8.27)$$

Thin Plates

Pressure sensors are one of the most popular electromechanical transducers. The basic structure used to convert mechanical pressure into electrical signal is a thin plate subjected to a pressure differential. Piezoresistive gauges are used to convert the strain in the membrane into change of resistance, which is

TABLE 8.2 Deflection and Bending Moments of Clamped Plate Under Uniform Load q
[Evans 1939]

| b/a | $W(x=0, y=0)$ | $M_x(x=a/2, y=0)$ | $M_y(x=0, y=b/2)$ | $M_x(x=0, y=0)$ | $M_y(x=0, y=0)$ |
|----------|-----------------|-------------------|-------------------|-----------------|-----------------|
| 1 | $0.00126qa^4/D$ | $-0.0513qa^2$ | $-0.0513qa^2$ | $0.0231qa^2$ | $0.0231qa^2$ |
| 1.5 | $0.00220qa^4/D$ | $-0.0757qa^2$ | $-0.0570qa^2$ | $0.0368qa^2$ | $0.0203qa^2$ |
| 2 | $0.00254qa^4/D$ | $-0.0829qa^2$ | $-0.0571qa^2$ | $0.0412qa^2$ | $0.0158qa^2$ |
| ∞ | $0.00260qa^4/D$ | $-0.0833qa^2$ | $-0.0571qa^2$ | $0.0417qa^2$ | $0.0125qa^2$ |

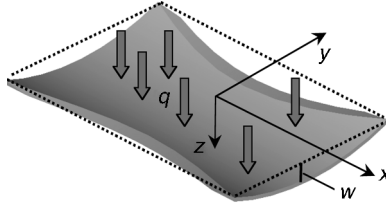

FIGURE 8.4 Thin plate subjected to positive pressure q .

read out using a conventional resistive bridge circuit. The initial pressure sensors were fabricated via anisotropic etching of silicon, which results in a rectangular diaphragm. Figure 8.4 shows a thin-plate, subjected to normal pressure q , resulting in out-of-plane displacement $w(x, y)$. The equilibrium condition for $w(x, y)$ is given by the thin plate theory [Timoshenko 1959]:

$$\frac{\partial^4 w}{\partial x^4} + 2 \frac{\partial^4 w}{\partial x^2 \partial y^2} + \frac{\partial^4 w}{\partial y^4} = \frac{q}{D}, \quad (8.28)$$

where $D = Eh^3/12(1 - \nu^2)$ is the flexural rigidity, E is the Young's modulus, ν is the Poisson ratio, and h is the thickness of the plate. The edge-moments (moments per unit length of the edge) and the small strains are

$$\begin{aligned} M_x(x, y) &= -D \left(\frac{\partial^2 w}{\partial x^2} - \nu \frac{\partial^2 w}{\partial y^2} \right), & \epsilon_{xx}(x, y, z) &= -z \frac{\partial^2 w}{\partial x^2} \\ M_y(x, y) &= -D \left(\frac{\partial^2 w}{\partial y^2} - \nu \frac{\partial^2 w}{\partial x^2} \right), & \epsilon_{yy}(x, y, z) &= -z \frac{\partial^2 w}{\partial y^2} \\ M_{xy}(x, y) &= D(1 - \nu) \frac{\partial^2 w}{\partial x \partial y}, & \epsilon_{xy}(x, y, z) &= -z \frac{\partial^2 w}{\partial x \partial y} \end{aligned} \quad (8.29)$$

Using (8.29), one can calculate the maximum strains occurring at the top and bottom faces of the plate in terms of the edge-moments:

$$\begin{aligned} \epsilon_{xx}^{\max}(x, y, z) &= \frac{12z}{Eh^3} (M_x - \nu M_y) \Big|_{z=h} = \frac{12}{Eh^2} (M_x - \nu M_y) \\ \epsilon_{yy}^{\max}(x, y, z) &= \frac{12z}{Eh^3} (M_y - \nu M_x) \Big|_{z=h} = \frac{12}{Eh^2} (M_y - \nu M_x) \end{aligned} \quad (8.30)$$

In the case of a pressure sensor with a diaphragm subjected to a uniform pressure, the boundary conditions are built-in edges: $w = 0, \partial w / \partial x = 0$ at $x = \pm a/2$ and $w = 0, \partial w / \partial y = 0$ at $y = \pm b/2$, where the diaphragm has lateral dimensions $a \times b$. The solution of this problem has been obtained by [Evans 1939], showing that the maximum strains are at the center of the edges. The values of the edge-moments and the displacement of the center of plate are listed in Table 8.2.

8.3 Vibration and Modal Analysis

As mentioned earlier, the time response of a continuum structure requires the solution of Eqs. (8.10) with the acceleration terms present. For linear systems this solution can be represented by an infinite superposition of characteristic functions (modes). Associated with each such mode is also a characteristic number (eigenvalue) determining the time response of the mode. The analysis of these modes is called modal analysis and has a central role in the design of resonant cantilever sensors, flapping wings for micro-air-vehicles (MAVs) and micromirrors, used in laser scanners and projection systems. In the case of a cantilever beam, the flexural displacements are described by a fourth-order differential equation

$$\frac{IE}{\rho A} \frac{\partial^4 w(x, t)}{\partial x^4} + \frac{\partial^2 w(x, t)}{\partial t^2} = 0 \quad (8.31)$$

where I is the moment of inertia, E is the Young's modulus, ρ is the density, and A is the area of the cross section. When the thickness of the cantilever is much smaller than the width, E should be replaced by the reduced Young's modulus $E_1 = E/(1 - \nu^2)$. For a rectangular cross section, (8.31) is reduced to

$$\frac{Eh^2}{12\rho} \frac{\partial^4 w(x, t)}{\partial x^4} + \frac{\partial^2 w(x, t)}{\partial t^2} = 0 \quad (8.32)$$

where h is the thickness of the beam. The solution of (8.32) can be written in terms of an infinite series of characteristic functions representing the individual vibration modes

$$w = \sum_{i=1}^{\infty} \Phi_i(x) \sin(\omega_i t + \delta_i) \quad (8.33)$$

where the characteristic functions Φ_i are expressed with the four Rayleigh functions S , T , U , and V :

$$\begin{aligned} \Phi_i &= a_i S(\lambda_i x) + b_i T(\lambda_i x) + c_i U(\lambda_i x) + d_i V(\lambda_i x) \\ S(x) &= \frac{1}{2}(\cosh x + \cos x), \quad T(x) = \frac{1}{2}(\sinh x + \sin x) \\ U(x) &= \frac{1}{2}(\cosh x - \cos x), \quad V(x) = \frac{1}{2}(\sinh x - \sin x), \quad \lambda_i^4 = \omega_i^2 \frac{\rho A}{IE} \end{aligned} \quad (8.34)$$

The coefficients a_i , b_i , c_i , d_i , ω_i , and δ_i are determined from the boundary and initial conditions of (8.34). For a cantilever beam with a fixed end at $x = 0$ and a free end at $x = L$, the boundary conditions are

$$\begin{aligned} w(0, t) &= 0, \quad \frac{\partial^2 w(L, t)}{\partial x^2} = 0 \\ \frac{\partial w(0, t)}{\partial x} &= 0, \quad \frac{\partial^3 w(L, t)}{\partial x^3} = 0 \end{aligned} \quad (8.35)$$

Since (8.35) are to be satisfied by each of the functions Φ_i , it follows that $a_i = 0$, $b_i = 0$ and

$$\cosh(\lambda_i L) \cos(\lambda_i L) = -1 \quad (8.36)$$

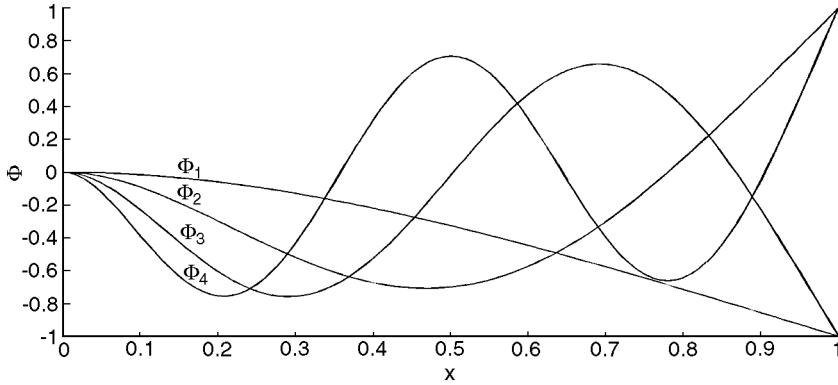

FIGURE 8.5 First four vibration modes of a cantilever beam.

From this transcendental equation the λ_i 's and the circular frequencies ω_i are determined [Butt et al. 1995].

$$\lambda_i L \cong \frac{(2i-1)\pi}{2}, \quad \omega_i = \frac{(2i-1)^2 \pi^2}{4L^2} \sqrt{\frac{IE}{\rho A}} = \frac{(2i-1)^2 \pi^2}{4L^2} \sqrt{\frac{Eh^2}{12\rho}} \quad (8.37)$$

Figure 8.5 shows the first four vibrational modes of the cantilever. An important result of the modal analysis is the calculation of the amplitude of thermal vibrations of cantilevers. As the size of the cantilevers is reduced to nanometer scale, the energy of random thermal excitations becomes comparable with the energy of the individual vibration modes. This effect leads to a thermal noise in nanocantilevers. Using the equipartition theorem [Butt et al. 1995] showed that the root mean square of the amplitude of the tip of such cantilever is

$$\sqrt{\langle z^2 \rangle} = \sqrt{\frac{kT}{K}} = \frac{0.64 \text{ \AA}}{\sqrt{K}}, \quad K = \frac{Ewh^3}{4L^2} \quad (8.38)$$

Similar analysis can be performed on vibrations of thin plates such as micromirrors. The free lateral vibrations of such a plate are described by

$$\frac{\partial^4 w(x, y, t)}{\partial x^4} + 2 \frac{\partial^4 w(x, y, t)}{\partial x^2 \partial y^2} + \frac{\partial^4 w(x, y, t)}{\partial y^4} = -\frac{\rho h}{D} \frac{\partial^2 w(x, y, t)}{\partial t^2} \quad (8.39)$$

The interested reader is referred to [Timoshenko 1959] for further details on vibrations of plates.

8.4 Buckling Analysis

Structural instability can occur due to material failure, e.g., plastic flow or fracture, or it can also occur due to large changes in the geometry of the structure (e.g., buckling, wrinkling, or collapse). The latter is the scope of this section. When short columns are subjected to a compressive load, the stress in the cross section is considered uniform. Thus for short columns, failure will occur when the plastic yield stress of the material is reached. In the case of long and slender beams under compression, due to manufacturing imperfections, the applied load or the column will have some eccentricity. As a result the force will develop a bending moment proportional to the eccentricity, resulting in additional lateral deflection. While for small loads the lateral displacement will reach equilibrium, above certain critical

TABLE 8.3 Critical Load Coefficients

| K coefficient | End Conditions | | |
|---------------|------------------------------|--------------------|-------------------------|
| | one end built-in, other free | both ends built-in | pin-joints at both ends |
| | 1/4 | 4 | 1 |

load, the beam will be unable to withstand the bending moment and will collapse. Consider the beam in Fig. 8.5, subjected to load F with eccentricity e , resulting in lateral displacement of the tip δ . According to the beam bending equation

$$EI \frac{\partial^2 w}{\partial x^2} = M = F(\delta + e + w) \quad (8.40)$$

where the boundary conditions are $w(0) = 0$, $\partial w / \partial x |_{x=0} = 0$. The corresponding solution is

$$w = (e + \delta)[1 - \cos(\sqrt{IE/F}x)] \quad (8.41)$$

From $w(L) = \delta$ one has $\delta = e(1/\cos kL - 1)$, where $k = \sqrt{IE/F}$. This solution loses stability when δ grows out of bound, i.e., when $\cos kL = 0$, or $kL = (2n + 1)\pi/2$. From this condition the smallest critical load is

$$F^{cr} = \pi^2 IE / 4L^2 \quad (8.42)$$

The above analysis and Eq. (8.42) were developed by Euler. Similar conditions can be derived for other types of beam supports. A general formula for the critical load can be written as

$$F^{cr} = K\pi^2 IE / L^2 \quad (8.43)$$

where several values of the coefficient K are given in Table 8.3.

8.5 Transducers

Transducers are devices capable of converting one type of energy into another. If the output energy is mechanical work the transducer is called an actuator. The rest of the transducers are called sensors, although in most cases, a mechanical transducer can also be a sensor and vice versa. For example the capacitive transducer can be used as an actuator or position sensor. In this section the most common actuators used in micromechanics are reviewed.

Electrostatic Transducers

The electrostatic transducers fall into two main categories—parallel plate electrodes and interdigitated comb electrodes. In applications where relatively large capacitance change or force is required, the parallel plate configuration is preferred. Conversely, larger displacements with linear force/displacement characteristics can be achieved with comb drives at the expense of reduced force. Parallel plate actuators are used in electrostatic micro-switches as illustrated in Fig. 8.1. In this case the electrodes form a parallel plate capacitor and the force is described by

$$F_{elec} = \frac{A \epsilon_0 \epsilon_r^2 V^2}{2[t_2 + \epsilon_r(d_0 - d)]^2} \quad (8.44)$$

where A is the area of overlap between the two electrodes; t_2 is the thickness of insulating layer (silicon dioxide, silicon nitride); l_e is the length of fixed electrode; ϵ_r is the relative permittivity of insulating layer; V is the applied voltage; d_0 is the initial separation between the capacitor plates; and d is downward

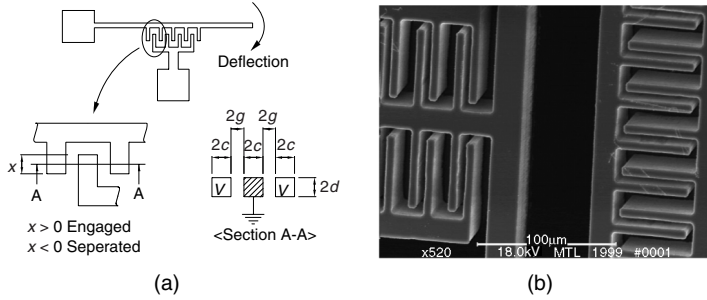

FIGURE 8.6 Lateral comb transducers: (a) Dimensions; (b) two orthogonal Si combs.

deflection of the beam. The minimum voltage required to close the gap of a cantilever actuator is known as the threshold voltage [Petersen 1978], and can be approximated as

$$V^{\text{th}} \approx \sqrt{\frac{18(IE)_{\text{eff}} d_0^3}{5 \epsilon_0 L^4 w}} \quad (8.45)$$

where $(IE)_{\text{eff}}$ is given by (8.24).

Comb drives also fall in two categories: symmetric and asymmetric. Symmetric comb drive is shown in Fig. 8.6(a). In this configuration the gaps between the individual fingers are equal. Figure 8.6(b) shows a pair of asymmetric comb capacitors, used in the force sensor shown in Fig. 8.2 [Enikov 2000a]. In any case, the force generated between the fingers is equal to the derivative of the total electrostatic energy with respect to the displacement

$$F^{\text{el}} = \frac{n \partial C}{2 \partial x} V^2 \quad (8.46)$$

where n is the number of fingers. Several authors have given approximate expressions for (8.46). One of the most accurate calculations of the force between the pair of fingers shown in Fig. 8.6(a) is given by [Johnson et al. 1995] using Schwartz transforms

$$F^{\text{el}} = \begin{cases} \frac{\epsilon_0 V^2}{\pi} \left\{ \ln \left[\left(\left(\frac{c}{g} + 1 \right)^2 - 1 \right) \left(1 + \frac{2g}{c} \right)^{1+c/g} \right] + \frac{\pi d}{g} - \frac{c+g}{x} \right\}, & x > \Delta_+ \text{ (engaged)} \\ -\frac{\epsilon_0 V^2}{\pi} \left\{ \frac{2(c+g)}{x} \right\}, & x < -\Delta_- \text{ (separated)} \end{cases} \quad (8.47)$$

In the transition region $x \in [-\Delta_-; \Delta_+]$, $\Delta_{+,-} \approx 2g$, the force can be approximated with a tangential line between the two branches described by (8.47).

Electromagnetic Transducers

Electromagnetic force has also been used extensively. It can be generated via planar coil as illustrated in Fig. 8.7. The cantilever and often the coils are made of soft ferromagnetic material. Using an equivalent magnetic circuit model, the magnetic force acting on the top cantilever can be estimated as

$$F_{\text{mag}} = \frac{2n^2 I^2 (2A_2 + A_1)}{\mu_0 A_1 A_2 (2R_1 + R_2)^2} \quad (8.48)$$

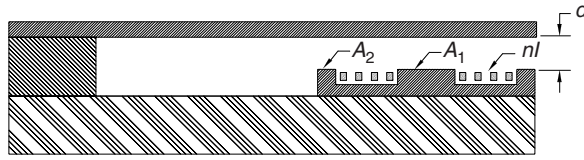

FIGURE 8.7 Electromagnetic actuation.

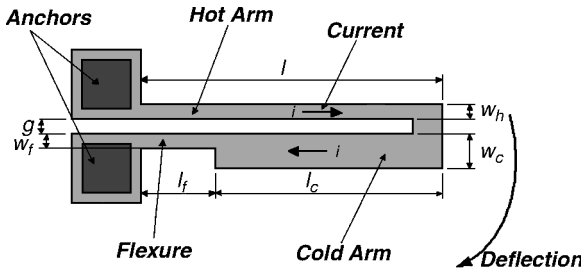

FIGURE 8.8 Lateral thermal actuator.

where

$$R_1 = \frac{d}{\mu_0 A_1} + \frac{h_1}{\mu_0 \mu_r A_1}, \quad R_2 = \frac{d}{\mu_0 A_2} + \frac{h_1}{\mu_0 \mu_r A_2} + \frac{h_2}{\mu_0 \mu_r A_b} \quad (8.49)$$

are the reluctances; h_1 and h_2 are the flux-path lengths inside the top and bottom permalloy layers.

Thermal Actuators

Thermal actuators have been investigated for positioning of micromirrors [Liew et al. 2000], and micro-switch actuation [Wood et al. 1998]. This actuator consists of two arms with different cross sections (see Fig. 8.8). When current is passed through the two arms, the higher current density occurs in the smaller cross-section beam and thus generates more heat per unit volume. The displacement is a result of the temperature differential induced in the two arms. For the actuator shown in Fig. 8.8, an approximate model for the deflection of the tip δ can be developed using the theory of thermal bimorphs [Faupel 1981]

$$\delta \approx \frac{3l^2(T^{\text{hot}}\alpha(T^{\text{hot}}) - T^{\text{cold}}\alpha(T^{\text{cold}}))}{4(w_h + w_f)} \quad (8.50)$$

where T^{hot} and T^{cold} are the average temperatures of the hot and cold arms and $\alpha(T)$ is the temperature dependent thermal expansion coefficient. A more detailed analysis including the temperature distribution in the arms can be found in [Huang et al. 1999].

Electroactive Polymer Actuators

Electroactive polymer-metal composites (EAPs) are promising multi-functional materials with extremely reach physics. Recent interest towards these materials is driven by their unique ability to undergo large deformations under very low driving voltages as well as their low mass and high fracture toughness. For comparison, Table 8.4 lists several characteristic properties of EAPs and other piezoelectric ceramics.

EAPs are being tested for use in flapping-wing micro-air-vehicles (MAVs) [Rohani 1999], underwater swimming robots [Laurent 2001], and biomedical applications [Oguro 2000]. An EAP actuator consists

TABLE 8.4 Comparative Properties of EAPs, Shape Memory Alloy, and Piezoceramic Actuators

| Characteristic Property | EAP | Shape Memory Alloy | Piezoelectric Ceramics |
|---|---------------|--------------------|------------------------|
| Achievable strain | more than 10% | up to 8% | up to 0.3% |
| Young's modulus (GPa) | 0.114 (wet) | 75 | 89 |
| Tensile strength (MPa) | 34 (wet) | 850 | 76 |
| Response time | msec–min | sec–min | μ sec–sec |
| Mass density (g/cm^3) | 2.0 | 6.5 | 7.5 |
| Actuation voltage | 1–10 V | N/A | 50–1000 V |

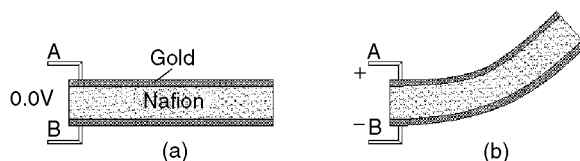

FIGURE 8.9 Polymer metal composite actuator.

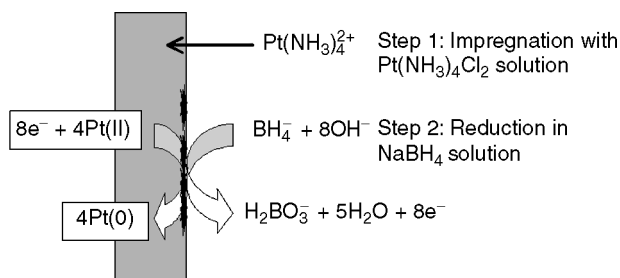
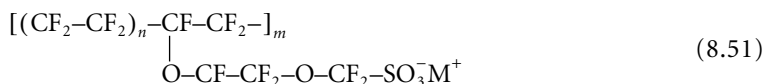

FIGURE 8.10 Two-step Pt plating process.

of an ion-exchange membrane covered with a conductive layer as illustrated in Fig. 8.9(a). Upon application of a potential difference at points A and B the composite bends towards the anodic side as shown in Fig. 8.9(b). Among the numerous ion-exchange polymers, perfluorinated sulfonic acid (Nafion Du Pont, USA) and perfluorinated carboxylic acid (Flemion, Asahi, Japan) are the most commonly used in actuator applications. The chemical formula of a unit chain of Nafion is



where M^+ is the counterion (H^+ , Na^+ , Li^+ , ...). The ionic clusters are attached to side chains, which according to transmission electron microscopy (TEM) studies, segregate in hydrophilic nano-clusters with diameters ranging from 10 to 50 Å [Xue 1989]. In 1982, Gierke proposed a structural model [Gierke 1982] according to which, the clusters are interconnected via narrow channels. The size and distribution of these channels determine the transport properties of the membrane and thus the mechanical response.

Metal-polymer composites can be produced by vapor or electrochemical deposition of metal over the surface of the membrane. The electrochemical platinization method [Fedkiw 1992], used by the author, is based on the ion-exchange properties of the Nafion. The method consists of two steps: step one—ion exchange of the protons H^+ with metal cations (e.g., Pt^{2+}); step two—chemical reduction of the Pt^{2+} ions in the membrane to metallic Pt using NaBH_4 solution. These steps are outlined in Fig. 8.10 and an SEM microphotograph of the resulting composite is shown in Fig. 8.11. The electrode surfaces are approximately 0.8 μm thick Pt deposits. Repeating the above steps several times results in dendritic growth of the electrodes into the polymer matrix [Oguro 1999] and has been shown to improve the actuation efficiency.

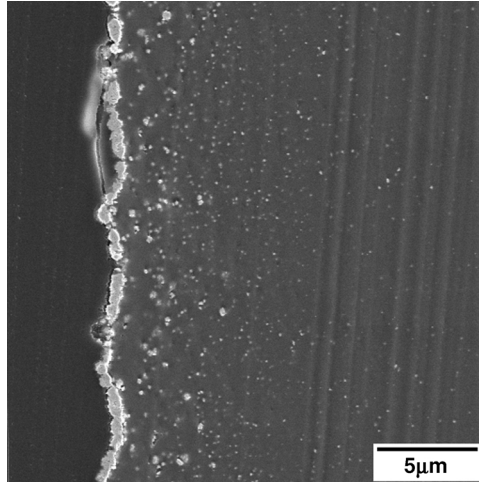

FIGURE 8.11 Nafion membrane with Pt electrode.

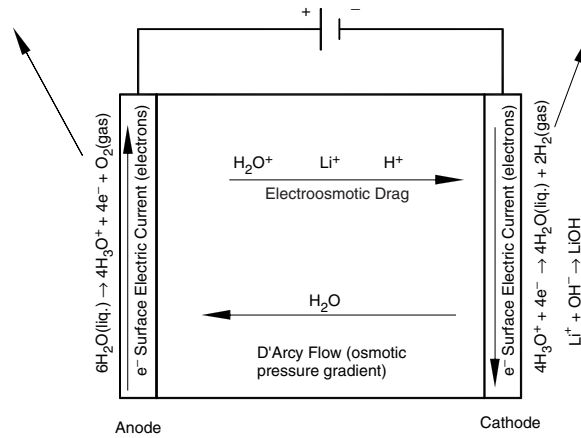

FIGURE 8.12 Ion transport in nafion.

The deformation of the polymer-metal composite can be attributed to several phenomena, the dominant one being differential swelling of the membrane due to internal osmotic pressure gradients [Eikerling 1998]. A schematic representation of the ionic processes taking place inside the polymer is shown in Fig. 8.12. Under the application of external electric field a flux of cations and hydroxonium ions is generated towards the cathode. At the cathode the ions pick up an electron and produce hydrogen and free water molecules. On the anodic side, the water molecules dissociate producing oxygen and hydroxonium ions. This redistribution of water within the membrane creates local expansion/contraction of the polymer matrix. Mathematically, the deformation can be described by introducing an additional strain (eigen strain) term in the expression of the total strain. Thus the total strain has two additive parts: elastic deformation of the polymer network due to external forces (mechanical, electrical) and chemical strain proportional to the compositional variables

$$\epsilon_{ij} = \epsilon_{ij}^{\text{elast}} + \rho_0 \sum_s \frac{\bar{V}^s}{3M^s} (c^s - c_0^s) \delta_{ij} \quad (8.52)$$

where c^s are the mass fractions, \bar{V}^s are the partial molar volumes, M^s are the molar masses, and the index 0 refers to the initial value of a variable. Complete mathematical description of the polymer actuator requires the solution of mass transport (diffusion) equation, momentum balance, and Poisson equation for potential distribution, the discussion of which is beyond the scope of this book. An interesting consequence of the addition of the chemical strain in (8.46) is the explicit appearance of the pressure term in the electrochemical potential driving the diffusion. The total mass diffusion flux will have a component proportional to the negative gradient of the pressure, which for the case of water, will result in a relaxation phenomena observed experimentally. The total flux of component s is then given by

$$\mathbf{J}^s = -\frac{\rho c^s W^s}{M^s} \nabla(\mu^{os}(T) + p\bar{V}^s + RT \ln(fc^s) + z^s \Phi) \quad (8.53)$$

where W^s is the mobility of component s , z^s is the valence of component s , p is the pressure, f^s is the activity coefficient, and Φ is the electric potential. We have omitted the cross-coupling terms that would appear in a fully coupled Onsager-type formulation. Interested readers are referred to [Enikov 2000b] and the references therein for further details.

8.6 Future Trends

The future MEMS are likely to be more heterogeneous in terms of materials and structures. Bio-MEMS for example, require use of nontoxic, noncorrosive materials, which is not a severe concern in standard IC components. Already departure from the traditional Si-based MEMS can be seen in the areas of optical MEMS using wide band-gap materials, nonlinear electro-optical polymers, and ceramics. As pointed earlier, the submicron size of the cantilever-based sensors brings the thermal noise issues in mechanical structures. Further reduction in size will require molecular statistic description of the interaction forces. For example, carbon nanotubes placed on highly oriented pyrolytic graphite (HOPG) experience increased adhesion force when aligned with the underlying graphite lattice [Falvo et al. 2000]. The future mechatronic systems are likely to become an interface between the macro and nano domains.

References

- Butt, H., Jaschke, M., "Calculation of thermal noise in atomic force microscopy," *Nanotechnology*, **6**, pp. 1–7, 1995.
- Eikerling, M., Kharkats, Y.I., Kornyshev, A.A., Volfkovich, Y.M., "Phenomenological theory of electro-osmotic effect and water management in polymer proton-conducting membranes," *Journal of the Electrochemical Society*, **145**(8), pp. 2684–2698, 1998.
- Evans, T.H., *Journal of Applied Mechanics*, **6**, p. A-7, 1939.
- Enikov, E.T., Nelson, B., "Three dimensional microfabrication for multi-degree of freedom capacitive force sensor using fiber chip coupling," *J. Micromech. Microeng.*, **10**, pp. 492–497, 2000.
- Enikov, E.T., Nelson, B.J., "Electrotransport and deformation model of ion exchange membrane based actuators," in *Smart Structures and Materials 2000*, Newport Beach, CA, SPIE vol. 3987, March, 2000.
- Falvo, M.R., Steele, J., Taylor, R.M., Superfine, R., "Gearlike rolling motion mediated by commensurate contact: carbon nanotubes on HOPG," *Physical Review B*, **62**(6), pp. 665–667, 2000.
- Faupel, J.H., Fisher, F.E., *Engineering Design: A Synthesis of Stress Analysis and Materials Engineering*, 2nd Ed., Wiley & Sons, New York, 1981.
- Liu, R., Her, W.H., Fedkiw, P.S., "In situ electrode formation on a nafion membrane by chemical platinization," *Journal of the Electrochemical Society*, **139**(1), pp. 15–23, 1990.
- Gierke, T.D., Hsu, W.S., "The cluster-network model of ion clustering in perfluorosulfonated membranes," in *Perfluorinated Ionomer Membranes*, A. Eisenberg and H.L. Yeager, Eds., vol. 180, American Chemical Society, 1982.

- Johnson et al., "Electrophysics of micromechanical comb actuators," *Journal of Microelectromechanical Systems*, **4**(1), pp. 49–59, 1995.
- Hopkins, *Design Analysis of Shafts and Beams*, 2nd Ed., Malabar, FL: RE Kreiger, 1987.
- Huang, Q.A., Lee, N.K.S., "Analysis and design of polysilicon thermal flexure actuator," *Journal of Micro-mechanics and Microengineering*, **9**, pp. 64–70, 1999.
- Kittel, Ch., *Introduction to Solid State Physics*, John Wiley & Sons, Inc., New York, 1996.
- Laurent, G., Piat, E., "High efficiency swimming microrobot using ionic polymer metal composite actuators," to appear in 2001.
- Liew, L. et al., "Modeling of thermal actuator in a bulk micromachined CMOS micromirror," *Microelectronics Journal*, **31**(9–10), pp. 791–790, 2000.
- Maugin, G., *Continuum Mechanics of Electromagnetic Solids*, Elsevier, Amsterdam, The Netherlands, 1988.
- Mendelson, *Plasticity: Theory and Application*, Macmillan, New York, 1968.
- Nye, J.F., *Physical Properties of Crystals*, Oxford University Press, London, 1960.
- Onishi, K., Sewa, Sh., Asaka, K., Fujiwara, N., Oguro, K., "Bending response of polymer electrolyte actuator," in *Smart Structures and Materials 2000*, Newport Beach, CA, SPIE vol. 3987, March, 2000.
- Peterson, "Dynamic micromechanics on silicon: techniques and devices," *IEEE*, 1978.
- Rohani, M.R., Hicks, G.R., "Multidisciplinary design and prototype of a micro air vehicle," *Journal of Aircraft*, **36**(1), p. 237, 1999.
- Timoshenko, S., Woinowsky-Krieger, S., *Theory of Plates and Shells*, McGraw-Hill, New York, 1959.
- Wood, R. et al., "MEMS microrelays," *Mechatronics*, **8**, pp. 535–547, 1998.
- Xue, T., Trent, Y.S., Osseo-Asare, K., "Characterization of nafion membranes by transmission electron microscopy," *Journal of Membrane Science*, **45**, p. 261, 1989.
- Zgonik et al., "Dielectric, elastic, piezoelectric, electro-optic and elasto-optic tensors of BaTiO₃ crystals," *Physical Review B*, **50**(9), p. 5841, 1994.

9

Modeling of Mechanical Systems for Mechatronics Applications

- 9.1 Introduction
- 9.2 Mechanical System Modeling
in Mechatronic Systems
Physical Variables and Power Bonds • Interconnection
of Components • Causality
- 9.3 Descriptions of Basic Mechanical Model
Components
Defining Mechanical Input and Output Model
Elements • Dissipative Effects in Mechanical
Systems • Potential Energy Storage Elements • Kinetic Energy
Storage • Coupling Mechanisms • Impedance Relationships
- 9.4 Physical Laws for Model Formulation.
Kinematic and Dynamic Laws • Identifying and Representing
Motion in a Bond Graph • Assigning and Using
Causality • Developing a Mathematical Model • Note
on Some Difficulties in Deriving Equations
- 9.5 Energy Methods for Mechanical System
Model Formulation
Multiport Models • Restrictions on Constitutive
Relations • Deriving Constitutive Relations
• Checking the Constitutive Relations
- 9.6 Rigid Body Multidimensional Dynamics
Kinematics of a Rigid Body • Dynamic Properties of a Rigid
Body • Rigid Body Dynamics
- 9.7 Lagrange's Equations
Classical Approach • Dealing with Nonconservative
Effects • Extensions for Nonholonomic Systems
• Mechanical Subsystem Models Using Lagrange Methods
• Methodology for Building Subsystem Model

Raul G. Longoria

The University of Texas at Austin

9.1 Introduction

Mechatronics applications are distinguished by controlled motion of mechanical systems coupled to actuators and sensors. Modeling plays a role in understanding how the properties and performance of mechanical components and systems affect the overall mechatronic system design. This chapter reviews methods for modeling systems of interconnected mechanical components, initially restricting the

application to basic translational and rotational elements, which characterize a wide class of mechatronic applications. The underlying basis of mechanical motion (kinematics) is presumed known and not reviewed here, with more discussion and emphasis placed on a system dynamics perspective. More advanced applications requiring two- or three-dimensional motion is presented in [section 9.6](#).

Mechanical systems can be conceptualized as rigid and/or elastic bodies that may move relative to one another, depending on how they are interconnected by components such as joints, dampers, and other passive devices. This chapter focuses on those systems that can be represented using lumped-parameter descriptions, wherein bodies are treated as rigid and no dependence on spatial extent need be considered in the elastic effects. The modeling of mechanical systems in general has reached a fairly high level of maturity, being based on classical methods rooted in the Newtonian laws of motion. One benefits from the extensive and overwhelming knowledge base developed to deal with problems ranging from basic mass-spring systems to complex multibody systems. While the underlying physics are well understood, there exist many different means and ways to arrive at an end result. This can be especially true when the need arises to model a multibody system, which requires a considerable investment in methods for formulating and solving equations of motion. Those applications are not within the scope of this chapter, and the immediate focus is on modeling basic and moderately complex systems that may be of primary interest to a mechatronic system designer/analyst.

9.2 Mechanical System Modeling in Mechatronic Systems

Initial steps in modeling any physical system include defining a system boundary, and identifying how basic components can be partitioned and then put back together. In mechanical systems, these analyses can often be facilitated by identifying points in a system that have a distinct velocity. For purposes of analysis, active forces and moments are “applied” at these points, which could represent energetic interactions at a system boundary. These forces and moments are typically applied by actuators but might represent other loads applied by the environment.

A mechanical component modeled as a point mass or rigid body is readily identified by its velocity, and depending on the number of bodies and complexity of motion there is a need to introduce a coordinate system to formally describe the kinematics (e.g., see [12] or [15]). Through a kinematic analysis, additional (relative) velocities can be identified that indicate the connection with and motion of additional mechanical components such as springs, dampers, and/or actuators. The interconnection of mechanical components can generally have a dependence on geometry. Indeed, it is dependence of mechanical systems on geometry that complicates analysis in many cases and requires special consideration, especially when handling complex systems.

A preliminary description of a mechanical system should also account for any constraints on the motional states, which may be functions of time or of the states themselves. The dynamics of mechanical systems depends, in many practical cases, on the effect of constraints. Quantifying and accounting for constraints is of paramount importance, especially in multibody dynamics, and there are different schools of thought on how to develop models. Ultimately, the decision on a particular approach depends on the application needs as well as on personal preference.

It turns out that a fairly large class of systems can be understood and modeled by first understanding basic one-dimensional translation and fixed-axis rotation. These systems can be modeled using methods consistent with those used to study other systems, such as those of an electric or hydraulic type. Furthermore, building interconnected mechatronic system models is facilitated, and it is usually easier for a system analyst to conceptualize and analyze these models.

In summary, once an understanding of (a) the system components and their interconnections (including dependence on geometry), (b) applied forces/torques, and (c) the role of constraints, is developed, dynamic equations fundamentally due to Newton can be formulated. The rest of this section introduces the selection of physical variables consistent with a power flow and energy-based approach to modeling basic mechanical translational and rotational systems. In doing so, a bond graph approach [28,3,17] is introduced for developing models of mechanical systems. This provides a basis for introducing the

concept of causality, which captures the input–output relationship between power-conveying variables in a system. The bond graph approach provides a way to understand and mathematically model basic as well as complex mechanical systems that is consistent with other energetic domains (electric, electromechanical, thermal, fluid, chemical, etc.).

Physical Variables and Power Bonds

Power and Energy Basis

One way to consistently partition and connect subsystem models is by using power and energy variables to quantify the system interaction, as illustrated for a mechanical system in Fig. 9.1(a). In this figure, one **port** is shown at which power flow is given by the product of force and velocity, $F \cdot V$, and another for which power is the product of torque and angular velocity, $T \cdot \omega$. These power-conjugate variables (i.e., those whose product yields power) along with those that would be used for electrical and hydraulic energy domains are summarized in Table 9.1. Similar effort (e) and flow (f) variables can be identified for other energy domains of interest (e.g., thermal, magnetic, chemical). This basis assures energetically correct models, and provides a consistent way to connect system elements together.

In modeling energetic systems, energy continuity serves as a basis to classify and to quantify systems. Paynter [28] shows how the energy continuity equation, together with a carefully defined port concept, provides a basis for a generalized modeling framework that eventually leads to a bond graph approach. Paynter’s reticulated equation of energy continuity,

$$-\sum_{i=1}^l P_i = \sum_{j=1}^m \frac{dE_j}{dt} + \sum_{k=1}^n (P_d)_k \tag{9.1}$$

concisely identifies the l distinct flows of power, P_p , m distinct stores of energy, E_p , and the n distinct dissipators of energy, P_d . Modeling seeks to refine the descriptions from this point. For example, in a simple mass–spring–damper system, the mass and spring store energy, a damper dissipates energy, and

TABLE 9.1 Power and Energy Variables for Mechanical Systems

| Energy Domain | Effort, e | Flow, f | Power, P |
|---------------|--------------------------------|---|-------------------------------|
| General | e | f | $e \cdot f$ [W] |
| Translational | Force, F [N] | Velocity, V [m/sec] | $F \cdot V$ [N m/sec, W] |
| Rotational | Torque, T or τ [N m] | Angular velocity, ω [rad/sec] | $T \cdot \omega$ [N m/sec, W] |
| Electrical | Voltage, v [V] | Current, i [A] | $v \cdot i$ [W] |
| Hydraulic | Pressure, P [Pa] | Volumetric flowrate, Q [m ³ /sec] | $P \cdot Q$ [W] |

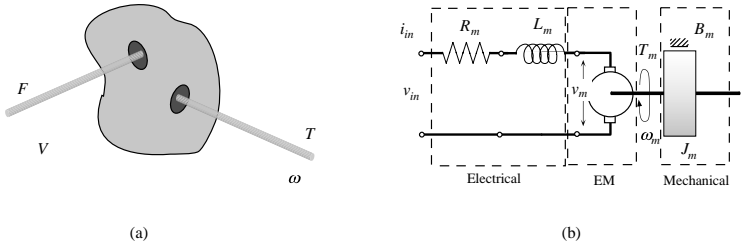

FIGURE 9.1 Basic interconnection of systems using power variables.

the interconnection of these elements would describe how power flows between them. Some of the details for accomplishing these modeling steps are presented in later sections.

One way to proceed is to define and categorize types of system elements based on the reticulated energy continuity Eq. (9.1). For example, consider a system made up only of rigid bodies as energy stores (in particular of kinetic energy) for which $P_d = 0$ (we can add these later), and in general there can be l ports that could bring energy into this purely (kinetic)energy-storing system which has m distinct ways to put energy into the rigid bodies. This is a very general concept, consistent with many other ways to model physical systems. However, it is this foundation that provides for a generalized way to model and integrate different types of energetic systems.

The schematic of a permanent-magnet dc (PMDC) motor shown in Fig. 9.1(b) illustrates how power variables would be used to identify interconnection points. This example also serves to identify the need for modeling mechanisms, such as the electromechanical (EM) interaction, that can represent the exchange of energy between two parts of a system. This model represents a simplified relationship between electrical power flow, $v \cdot i$, and mechanical power flow, $T \cdot \omega$, which forms the basis for a motor model. Further, this is an ideal power-conserving relationship that would only contain the power flows in the energy continuity equation; there are no stores or dissipators. Additional physical effects would be included later.

Power and Signal Flow

In a bond graph formulation of the PMDC motor, a **power bond** is used to identify flow of power. Power bonds quantify power flow via an effort-flow pair, which can label the bonds as shown in Fig. 9.2(a) (convention calls for the effort to take the position above for any orientation of bond). This is a **word bond graph** model, a form used to identify the essential components in a complex system model. At this stage in a model, only the interactions of multiport systems are captured in a general fashion. Adding half-arrows on power bonds defines a power flow direction between two systems (positive in the direction of the arrow). **Signal bonds**, used in control system diagrams, have full-arrows and can be used in bond graph models to indicate interactions that convey only information (or negligible power) between multiports. For example, the word bond graph in Fig. 9.2(b) shows a signal from the mechanical block to indicate an ideal measurement transferred to a controller as a pure signal. The controller has both signal and power flow signals, closing the loop with the electrical side of the model. These conceptual diagrams are useful for understanding and communicating the system interconnections but are not complete or adequate for quantifying system performance.

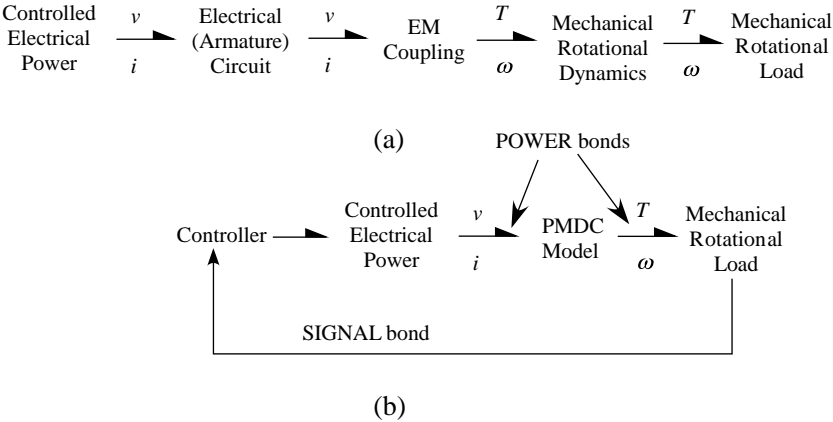

FIGURE 9.2 Power-based bond graph models: (a) PMDC motor word bond graph, (b) PMDC motor word bond graph with controller.

While it is convenient to use power and energy in formulating system models for mechanical systems, a **motional** basis is critical for identifying interconnections and when formulating quantifiable mathematical models. For many mechanical, translational, and rotational systems, it is sufficient to rely on basic one-dimensional motion and relative motion concepts to identify the interrelation between many types of practical components. Identifying network-like structure in these systems has been the basis for building electrical analogies for some time. These methods, as well as signal-flow analysis techniques, are not presented here but are the method of choice in some approaches to system dynamics [33]. Bond graph models are presented, and it will be shown in later sections how these are consistent even with more complex mechanical system formulations of three-dimensional dynamics as well as with the use of Lagrangian models.

Need for Motional Basis

In modeling mechanical translational or rotational systems, it is important to identify how the configuration changes, and a coordinate system should be defined and the effect of geometric changes identified. It is assumed that the reader is familiar with these basic concepts [12]. Usually a reference configuration is defined from which coordinates can be based. This is essential even for simple one-dimensional translation or fixed-axis rotation. The minimum number of geometrically independent coordinates required to describe the configuration of a system is traditionally defined as the **degrees of freedom**. Constraints should be identified and can be used to choose the most convenient set of coordinates for description of the system. We distinguish between degrees of freedom and the minimum number of **dynamic state variables** that might be required to describe a system. These may be related, but they are not necessarily the same variables or the same in number (e.g., a second-order system has two states but is also referred to as a single degree of freedom system).

An excellent illustration of the relevance of degrees of freedom, constraints, and the role these concepts play in modeling and realizing a practical system is shown in Fig. 9.3. This illustration (adapted from Matschinsky [22]) shows four different ways to configure a wheel suspension. Case (a), which also forms the basis for a 1/4-car model clearly has only one degree of freedom. The same is true for cases (b) and (c), although there are constraints that reduce the number of coordinates to just one in each of these designs. Finally, the rigid beam axle shows how this must have two degrees of freedom in vertical and rotational motion of the beam to achieve at least one degree of freedom at each wheel.

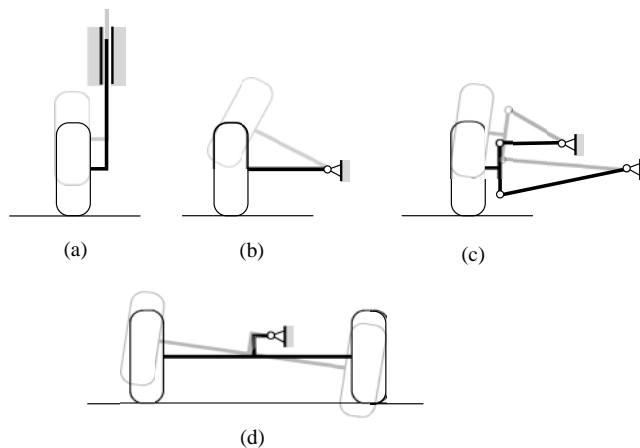

FIGURE 9.3 Wheel suspensions: (a) vertical travel only, 1 DOF; (b) swing-axle with vertical and lateral travel, 1 DOF; (c) four-bar linkage design, constrained motion, 1 DOF; (d) rigid beam axle, two wheels, vertical, and rotation travel, 2 DOF.

Interconnection of Components

In this chapter, we will use bond graphs to model mechanical systems. Like other graph representations used in system dynamics [33] and multibody system analysis [30,39], bond graphs require an understanding of basic model elements used to represent a system. However, once understood, graph methods provide a systematic method for representing the interconnection of multi-energetic system elements. In addition, bond graphs are unique in that they are not linear graph formulations: power bonds replace branches, multiports replace nodes [28]. In addition, they include a systematic approach for computational causality.

Recall that a single line represents power flow, and a half-arrow is used to designate positive power flow direction. Nodes in a linear graph represent across variables (e.g., velocity, voltage, flowrate); however, the multiport in a bond graph represents a system element that has a physical function defined by an energetic basis. System model elements that represent masses, springs, and other components are discussed in the next section. Two model elements that play a crucial role in describing how model elements are interconnected are the 1-junction and 0-junction. These are ideal (power-conserving) multiport elements that can represent specific physical relations in a system that are useful in interconnecting other model elements.

A point in a mechanical system that has a distinct velocity is represented by a 1-junction. When one or more model elements (e.g., a mass) have the same velocity as a given 1-junction, this is indicated by connecting them to the 1-junction with a power bond. Because the 1-junction is constrained to conserve power, it can be shown that efforts (forces, torques) on all the connected bonds must sum to zero; i.e., $\sum \hat{A}e_i = 0$. This is illustrated in Fig. 9.4(a). The 1-junction enforces kinematic compatibility and introduces a way to graphically express force summation! The example in Fig. 9.4(b) shows three systems (the blocks labeled 1, 2, and 3) connected to a point of common velocity. In the bond graph, the three systems would be connected by a 1-junction. Note that sign convention is incorporated into the sense of the power arrow.

For the purpose of analogy with electrical systems, the 1-junction can be thought of as a series electrical connection. In this way, elements connected to the 1-junction all have the same current (a flow variable) and the effort summation implied in the 1-junction conveys the Kirchhoff voltage law. In mechanical systems, 1-junctions may represent points in a system that represent the velocity of a mass, and the effort summation is a statement of Newton's law (in D'Alembert form), $\hat{A}F - \dot{p} = 0$.

Figure 9.4 illustrates how components with common velocity are interconnected. Many physical components may be interconnected by virtue of a common effort (i.e., force or torque) or 0-junction. For example, two springs connected serially deflect and their ends have distinct rates of compression/extension; however, they have the same force across their ends (ideal, massless springs). System components that have this type of relationship are graphically represented using a 0-junction. The basic 0-junction definition is shown in Fig. 9.5(a). Zero junctions are especially helpful in mechanical system modeling because they can also be used to model the connection of components having relative motion. For example, the device in Fig. 9.5(b), like a spring, has ends that move relative to one another, but the force

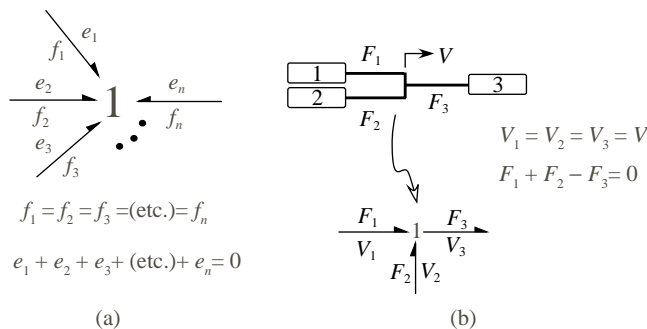

FIGURE 9.4 Mechanical 1-junction: (a) basic definition, (b) example use at a massless junction.

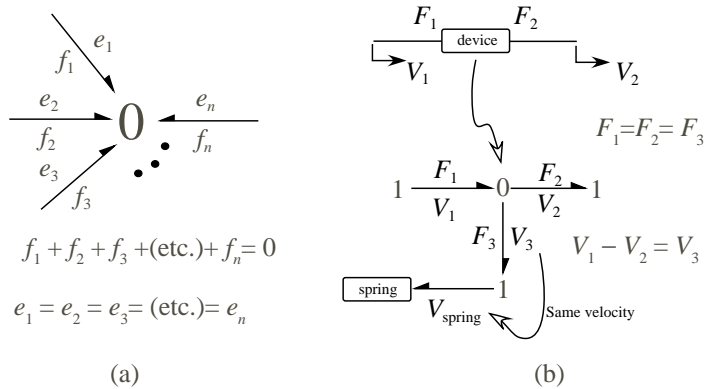

FIGURE 9.5 Mechanical 0-junction: (a) basic definition, (b) example use at a massless junction.

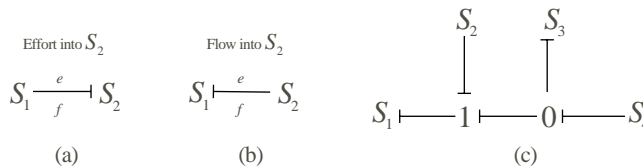

FIGURE 9.6 (a) Specifying effort from S_1 into S_2 . (b) Specifying flow from S_1 into S_2 . (c) A contrived example showing the constraint on causality assignment imposed by the physical definitions of 0- and 1-junctions.

on each end is the same (note this assumes there is negligible mass). The definition of the 0-junction implies that all the bonds have different velocities, so a flow difference can be formed to construct a relative velocity, V_3 . All the bonds have the same force, however, and this force would be applied at the 1-junctions that identify the three distinct velocities in this example. A spring, for example, would be connected on a bond connected to the V_3 junction, as shown in Fig. 9.5(b), and $V_{\text{spring}} = V_3$.

The 1- and 0-junction elements graphically represent algebraic structure in a model, with distinct physical attributes from compatibility of kinematics (1-junction) and force or torque (0-junction). The graph should reflect what can be understood about the interconnection of physical devices with a bond graph. There is an advantage in forming a bond graph, since causality can then be used to form mathematical models. See the text by Karnopp, Margolis, and Rosenberg [17] for examples. There is a relation to through and across variables, which are used in linear graph methods [33].

Causality

Bond graph modeling was conceived with a consistent and algorithmic methodology for assignment of causality (see Paynter [28], p. 126). In the context of bond graph modeling, causality refers to the input–output relationship between variables on a power bond, and it depends on the systems connected to each end of a bond. Paynter identified the need for this concept having been extensively involved in analog computing, where solutions rely on well-defined relationships between signals. For example, if system S_1 in Fig. 9.6(a) is a known source of effort, then when connected to a system S_2 , it must specify effort into S_2 , and S_2 in turn must return the flow variable, f , on the bond that connects the two systems. In a bond graph, this causal relationship is indicated by a vertical stroke drawn on the bond, as shown in Fig. 9.6(a). The vertical stroke at one end of a bond indicates that effort is specified into the multiport element connected at that end. In Fig. 9.6(b), the causality is reversed from that shown in (a).

The example in Fig. 9.6(c) illustrates how causality “propagates” through a bond graph of interconnected bonds and systems. Note that a 1-junction with multiple ports can only have one bond specifying flow at that junction, so the other bonds specify effort into the 1-junction. A 0-junction requires one bond to specify effort, while all others specify flow. Also note that a direction for positive power flow has not been assigned on these bonds. This is intentional to emphasize the fact that power sense and causality assignment on a bond are **independent** of each other.

Causality assignment in system models will be applied in examples that follow. An extensive discussion of the successive causality assignment procedure (sometimes referred to as SCAP) can be found in Rosenberg and Karnopp [32] or Karnopp, Margolis, and Rosenberg [17]. By using the defined bond graph elements, causality assignment is made systematically. The procedure has been programmed into several commercially available software packages that use bond graphs as formal descriptions of physical system models.

Because it reveals the input–output relationship of variables on all the bonds in a system model, causality can infer computational solvability of a bond graph model. The results are used to indicate the number of dynamic states required in a system, and the causal graph is helpful in actually deriving the mathematical model. Even if equations are not to be derived, causality can be used to derive physical insight into how a system works.

9.3 Descriptions of Basic Mechanical Model Components

Mechanical components in mechatronic systems make their presence known through motional response and by force and torque (or moment) reactions notably on support structures, actuators, and sensors. Understanding and predicting these response attributes, which arise due to combinations of frictional, elastic, and inertial effects, can be gained by identifying their inherent dissipative and energy storing nature. This emphasis on dissipation and energy storage leads to a systematic definition of constitutive relations for basic mechanical system modeling elements. These model elements form the basis for building complex nonlinear system models and for defining impedance relations useful in transfer function formulation. In the following, it is assumed that the system components can be well represented by lumped-parameter formulations.

It is presumed that a modeling decision is made so that dissipative and energy storing (kinetic and potential) elements can be identified to faithfully represent a system of interest. The reticulation is an essential part of the modeling process, but sometimes the definition and interconnection of the elements is not easy or intuitive. This section first reviews mechanical system input and output model elements, and then reviews passive dissipative elements and energy-storing elements. The section also discusses coupling elements used for modeling gears, levers, and other types of power-transforming elements. The chapter concludes by introducing impedance relationships for all of these elements.

Defining Mechanical Input and Output Model Elements

In dynamic system modeling, initial focus requires defining a **system boundary**, a concept borrowed from basic thermodynamics. In isolating mechanical systems, a system boundary identifies ports through which power and signal can pass. Each port is described either by a force–velocity or torque–angular velocity power conjugate pair. It is helpful, when focusing on the mechanical system modeling, to make a judgement on the causality at each port. For example, if a motor is to be attached to one port, it may be possible to define torque as the input variable and angular velocity as the output (back to the motor).

It is important to identify that these are model assumptions. We define specific elements as **sources** of effort or flow that can be attached at the boundary of a system of interest. These inputs might be known and or idealized, or they could simply be “placeholders” where we will later attach a model for an actuator or sensor. In this case, the causality specified at the port is fixed so that the (internal) system model will not change. If the causality changes, it will be necessary to reformulate a new model.

In bond graph terminology, the term **effort source** is used to define an element that specifies an effort, such as this force or torque. The symbol S_e or E can be used to represent the effort source on a bond graph.

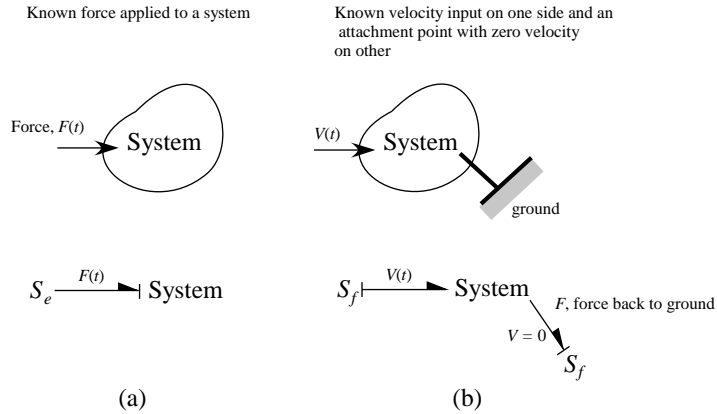

FIGURE 9.7 Two cases showing effort and flow sources on word bond graphs.

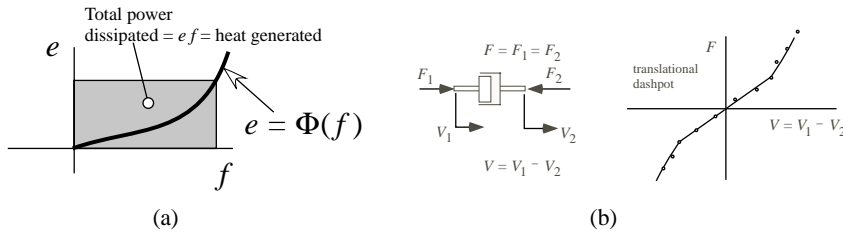

FIGURE 9.8 (a) Resistive constitutive relation. (b) Example dashpot resistive model.

A **flow source** is an element that specifies a flow on a bond, such as a translational velocity or angular or rotational velocity. The bond graph symbol is S_f or F . Two basic examples of sources are shown in Fig. 9.7. Note that each bond has a defined effort or flow, depending on the source type. The causality on these model elements is always known, as shown. Further, each bond carries both pieces of information: (1) the effort or flow variable specified by the source, and (2) the *back reaction* indicated by the causality. So, for example, at the ground connection in Fig. 9.7(b), the source specifies the zero velocity constraint into the system, and the system, in turn, specifies an effort *back* to the ground. The symbolic representation emphasizes the causal nature of bond graph models and emphasizes which variables are available for examination. In this case, the force back into the ground might be a critical output variable.

Dissipative Effects in Mechanical Systems

Mechanical systems will dissipate energy due to friction in sliding contacts, dampers (passive or active), and through interaction with different energy domains (e.g., fluid loading, eddy current damping). These irreversible effects are modeled by constitutive functions between force and velocity or torque and angular velocity. In each case, the product of the effort-flow variables represents power dissipated, $P_d = e \cdot f$, and the total energy dissipated is $E_d = \int P_d dt = \int (e \cdot f) dt$. This energy can be determined given knowledge of the constitutive function, $e = \Phi(f)$, shown graphically in Fig. 9.8(a). We identify this as a basic *resistive* constitutive relationship that must obey the restriction imposed by the second law of thermodynamics; namely that, $e \cdot f \geq 0$. A typical mechanical dashpot that follows a resistive-type model description is summarized in Fig. 9.8(b).

In a bond graph model, resistive elements are symbolized by an **R** element, and a generalized, multiport **R**-element model is shown in Fig. 9.9(a). Note that the **R** element is distinguished by its ability to represent entropy production in a system. On the **R** element, a *thermal port* and bond are shown, and the power direction is always positive *away* from the **R**. In thermal systems, temperature, T , is the effort variable

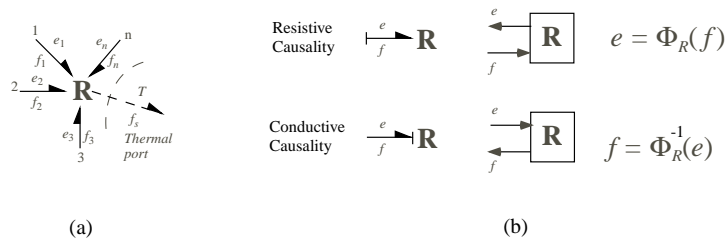

FIGURE 9.9 (a) Resistive bond graph element. (b) Resistive and conductive causality.

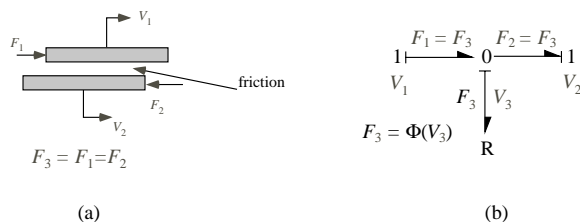

FIGURE 9.10 (a) Two sliding surfaces. (b) Bond graph model with causality implying velocities as known inputs.

and entropy flow rate, f_s is the flow variable. To compute heat generated by the \mathbf{R} element, compose the calculation as Q (heat in watts) = $T \cdot f_s = \sum_i e_i \cdot f_i$ over the n ports.

The system attached to a resistive element through a power bond will generally determine the causality on that bond, since resistive elements generally have no preferred causal form.¹ Two possible cases on a given \mathbf{R} -element port are shown in Fig. 9.9(b). A block diagram emphasizes the computational aspect of causality. For example, in a resistive case the flow (e.g., velocity) is a known input, so power dissipated is $P_d = e \cdot f = \Phi(f) \cdot f$. For the linear damper, $F = b \cdot V$, so $P_d = F \cdot V = bV^2$ (W).

In mechanical systems, many frictional effects are driven by relative motion. Hence, identifying how a dissipative effect is configured in a mechanical system requires identifying critical motion variables. Consider the example of two sliding surfaces with distinct velocities identified by 1-junctions, as shown in Fig. 9.10(a). Identifying one surface with velocity V_1 , and the other with V_2 , the simple construction shown in Fig. 9.10(b) shows how an \mathbf{R} element can be connected at a relative velocity, V_3 . Note the relevance of the causality as well. Two velocities join at the 0-junction to form a relative velocity, which is a causal input to the \mathbf{R} . The causal output is a force, F_3 , computed using the constitutive relation, $F = \Phi(V_3)$. The 1-junction formed to represent V_3 can be eliminated when there is only a single element attached as shown. In this case, the \mathbf{R} would replace the 1-junction.

When the effort-flow relationship is linear, the proportionality constant is a **resistance**, and in mechanical systems these quantities are typically referred to as **damping constants**. Linear damping may arise in cases where two surfaces separated by a fluid slide relative to one another and induce a viscous and strictly laminar flow. In this case, it can be shown that the force and relative velocity are linearly related, and the material and geometric properties of the problem quantify the linear damping constant. Table 9.2 summarizes both translational and rotational damping elements, including the linear cases. These components are referred to as dampers, and the type of damping described here leads to the term viscous friction in mechanical applications, which is useful in many applications involving lubricated surfaces. If the relative speed is relatively high, the flow may become turbulent and this leads to nonlinear damper behavior. The constitutive relation is then a nonlinear function, but the **structure** or interconnection of

¹This is true in most cases. Energy-storing elements, as will be shown later, have a causal form that facilitates equation formulation.

TABLE 9.2 Mechanical Dissipative Elements

| Physical System | Fundamental Relations | Bond Graph |
|---|--|--|
| Generalized Dissipative Element  <ul style="list-style-type: none"> Resistive element Resistance, R | Dissipation: $\mathbf{e} \cdot \mathbf{f} = \sum_i e_i f_i = T \cdot f_s$ Resistive law: $e = \Phi_R(f)$ Conductive law: $f = \Phi_R^{-1}(e)$ Content: $P_f = \int e \cdot df$ Co-content: $P_e = \int f \cdot de$ |  Generalized multiport R-element |
| Mechanical Translation damping, b  <ul style="list-style-type: none"> Damper damping, b | Constitutive: $F = \Phi(V)$ Content: $P_V = \int F \cdot dV$ Co-energy: $P_F = \int V \cdot dF$ Dissipation: $P_d = P_V + P_F$ |  Linear: $F = b \cdot V$ Dissipation: $P_d = bV^2$ |
| Mechanical Rotation damping, B  <ul style="list-style-type: none"> Torsional damper damping, B | Constitutive: $T = \Phi(\omega)$ Content: $P_\omega = \int T \cdot d\omega$ Co-energy: $P_T = \int \omega \cdot dT$ Dissipation: $P_d = P_\omega + P_T$ |  Linear: $T = B \cdot \omega$ Dissipation: $P_d = B\omega^2$ |

TABLE 9.3 Typical Coefficient of Friction Values. Note, Actual Values Will Vary Significantly Depending on Conditions

| Contacting Surfaces | Static, μ_s | Sliding or Kinetic, μ_k |
|---------------------------------------|-----------------|-----------------------------|
| Steel on steel (dry) | 0.6 | 0.4 |
| Steel on steel (greasy) | 0.1 | 0.05 |
| Teflon on steel | 0.04 | 0.04 |
| Teflon on teflon | 0.04 | — |
| Brass on steel (dry) | 0.5 | 0.4 |
| Brake lining on cast iron | 0.4 | 0.3 |
| Rubber on asphalt | — | 0.5 |
| Rubber on concrete | — | 0.6 |
| Rubber tires on smooth pavement (dry) | 0.9 | 0.8 |
| Wire rope on iron pulley (dry) | 0.2 | 0.15 |
| Hemp rope on metal | 0.3 | 0.2 |
| Metal on ice | — | 0.02 |

the model in the system does not change. Dampers are also constructed using a piston/fluid design and are common in shock absorbers, for example. In those cases, the force–velocity characteristics are often tailored to be nonlinear.

The viscous model will not effectively model friction between dry solid bodies, which is a much more complex process and leads to performance bounds especially at lower relative velocities. One way to capture this type of friction is with the classic Coulomb model, which depends on the normal load between surfaces and on a coefficient of friction, typically denoted μ (see Table 9.3). The Coulomb model quantifies the friction force as $F = \mu N$, where N is the normal force. This function is plotted in Fig. 9.11(a) to illustrate how it models the way the friction force always opposes motion. This model still qualifies as a resistive constitutive function relating the friction force and a relative velocity of the surfaces. In this case,

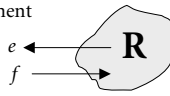
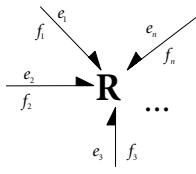
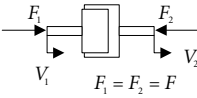
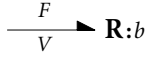
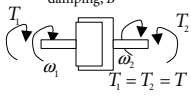
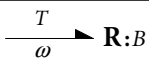
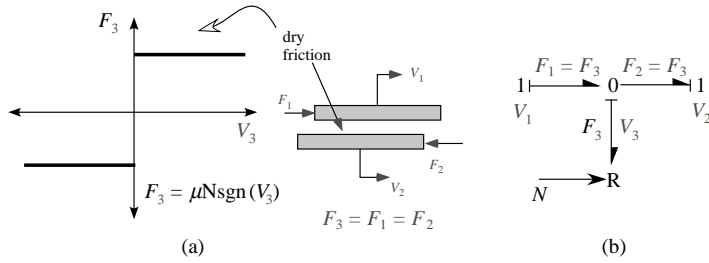

FIGURE 9.11 (a) Classic coulomb friction for sliding surfaces. (b) Bond graph showing effect of normal force as a modulation of the **R**-element law.

however, the velocity comes into effect only to determine the sign of the force; i.e., $F = \mu N \text{sgn}(V)$, where sgn is the signum function (value of 1 if $V > 0$ and -1 if $V < 0$).

This model requires a special condition when $V \rightarrow 0$. Dry friction can lead to a phenomenon referred to as stick-slip, particularly common when relative velocities between contacting surfaces approach low values. Stick-slip, or stiction, friction forces are distinguished by the way they vary as a result of other (modulating) variables, such as the normal force or other applied loads. Stick-slip is a type of system response that arises due to frictional effects. On a bond graph, a signal bond can be used to show that the normal force is determined by an external factor (e.g., weight, applied load, etc.). This is illustrated in Fig. 9.11(b). When the basic properties of a physical element are changed by signal bonds in this way, they are said to be **modulated**. This is a modeling technique that is very useful, but care should be taken so it is not applied in a way that violates basic energy principles.

Another difficulty with the standard dry friction model is that it has a preferred causality. In other words, if the causal input is velocity, then the constitutive relation computes a force. However, if the causal input is force then there is no unique velocity output. The function is not bi-unique. Difficulties of this sort usually indicate that additional underlying physical effects are not modeled. While the effort-flow constitutive relation is used, the form of the constitutive relation may need to be parameterized by other critical variables (temperature, humidity, etc.). More detailed models are beyond the scope of this chapter, but the reader is referred to Rabinowicz (1995) and Armstrong-Helouvy (1991) who present thorough discussions on modeling friction and its effects. Friction is usually a dominant source of uncertainty in many predictive modeling efforts (as is true in most energy domains).

Potential Energy Storage Elements

Part of the energy that goes into deforming any mechanical component can be associated with pure (lossless) storage of potential energy. Often the decision to model a mechanical component this way is identified through a basic constitutive relationship between an effort variable, e (force, torque), and a displacement variable, q (translational displacement, angular displacement). Such a relationship may be derived either from basic mechanics [29] or through direct measurement. An example is a translational spring in which a displacement of the ends, x , is related to an applied force, F , as $F = F(x)$.

In an energy-based lumped-parameter model, the generalized displacement variable, q , is used to define a state-determined potential energy function,



$$E = E(q) = U_q$$

This energy is related to the constitutive relationship, $e = F(q)$, by

$$U(q) = {}_qU = \int e dq = \int \Phi(q) dq$$

It is helpful to generalize in this way, and to identify that practical devices of interest will have at least one connection (or port) in which power can flow to store potential energy. At this port the displacement

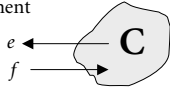
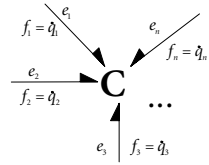
TABLE 9.4 Mechanical Potential Energy Storage Elements (Integral Form)

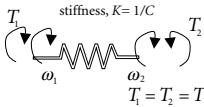
| Physical System | Fundamental Relations | Bond Graph |
|--|---|---|
| Generalized Potential Energy Storage Element  <ul style="list-style-type: none"> Capacitive element Capacitance, C | State: \mathbf{q} = displacement Rate: $\dot{\mathbf{q}} = \mathbf{f}$ Constitutive: $\mathbf{e} = \Phi(\mathbf{q})$ Energy: $U_{\mathbf{q}} = \int \mathbf{e} \cdot d\mathbf{q}$ Co-energy: $U_{\mathbf{e}} = \int \mathbf{q} \cdot d\mathbf{e}$ |  <p>Generalized multiport C-element</p> |
| Mechanical Translation  <ul style="list-style-type: none"> spring $V_1 - V_2 = V$ stiffness, k, compliance, C | State: x = displacement Rate: $\dot{x} = V$ Constitutive: $F = F(x)$ Energy: $U_x = \int F \cdot dx$ Co-energy: $U_F = \int x \cdot dF$ | $\frac{F}{\dot{x} = V} \text{ C} : 1/C = k$ Linear: $F = k \cdot x$ Energy: $U_x = \frac{1}{2} k x^2$ Co-energy: $U_F = F^2 / 2k$ |
| Mechanical Rotation  <ul style="list-style-type: none"> Torsional spring $\omega_1 - \omega_2 = \omega$ stiffness, K, compliance, C | State: θ = angle Rate: $\dot{\theta} = \omega$ Constitutive: $T = T(\theta)$ Energy: $U_{\theta} = \int T \cdot d\theta$ Co-energy: $U_T = \int \theta \cdot dT$ | $\frac{T}{\dot{\theta} = \omega} \text{ C} : 1/C = K$ Linear: $T = K \cdot \theta$ Energy: $U_{\theta} = \frac{1}{2} K \theta^2$ Co-energy: $U_T = T^2 / 2K$ |

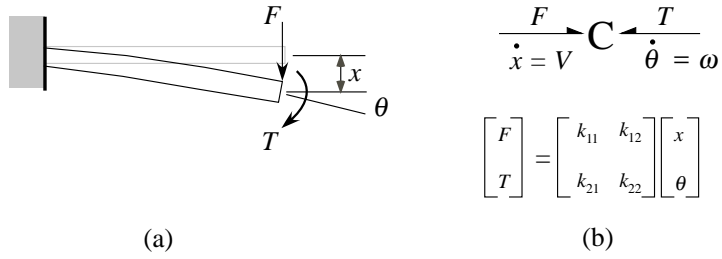

FIGURE 9.12 Example of two-port potential energy storing element: (a) cantilevered beam with translational and rotational end connections, (b) C-element, 2-port model.

variable of interest is either translational, x , or angular, θ , and the associated velocities are $V = \dot{x}$ and $\omega = \dot{\theta}$, respectively. A generalized potential energy storage element is summarized in Table 9.4, where examples are given for the translational and rotational one-port.

The linear translational spring is one in which $F = F(x) = kx = (1/C)x$, where k is the stiffness and $C \equiv 1/k$ is the compliance of the spring (compliance is a measure of “softness”). As shown in Table 9.4, the potential energy stored in a linear spring is $U_x = \int F dx = \int kx dx = \frac{1}{2} kx^2$, and the co-energy is $U_F = \int F dx = \int (F/k) dF = F^2/2k$. Since the spring is linear, you can show that $U_x = U_F$. If the spring is nonlinear due to, say, plastic deformation or work hardening, then this would not be true.

Elastic potential energy can be stored in a device through multiple ports and through different energy domains. A good example of this is the simple cantilevered beam having both tip force and moment (torque) inputs. The beam can store energy either by translational or rotational displacement of the tip. A constitutive relation for this 2-port C-element relates the force and torque to the linear and rotational displacements, as shown in Fig. 9.12. A stiffness (or compliance) matrix for small deflections is derived by linear superposition.

Kinetic Energy Storage

All components that constitute mechanical systems have mass, but in a system analysis, where the concern is dynamic performance, it is often sufficient to focus only on those components that may store relevant amounts of kinetic energy through their motion. This presumes that an energetic basis is used for modeling, and that the tracking of kinetic energy will provide insight into the system dynamics. This is the focus of this discussion, which is concerned for the moment with one-dimensional translation and fixed-axis rotation. Later it will be shown how the formulation presented here is helpful for understanding more complex systems.

The concept of mass and its use as a model element is facilitated by Newton's relationship between the rate of change of momentum of the mass to the net forces exerted on it, $F = \dot{p}$, where p is the momentum. The energy stored in a system due to translational motion with velocity V is the kinetic energy. Using the relation from Newton's law, $dp = Fdt$, this energy is $E(p) = T(p) = T_p = \int P dt = \int FV dt = \int V dp$. If the velocity is expressed solely as a function of the momentum, p , this system is a pure translational mass, $V = \Phi(p)$. If the velocity is linearly proportional to the momentum, then $V = p/m$, where m is the mass. Similar basic definitions are made for a body in rotation about a fixed axis, and these elements are summarized in Table 9.5.

For many applications of practical interest to engineering, the velocity–momentum relation, $V = V(p)$ (the constitutive relation), is linear. Only in relativistic cases might there be a nonlinear relationship in the constitutive law for a mass. Nevertheless, this points out that for the general case of kinetic energy storage a constitutive relation is formed between the flow variable and the momentum variable, $f = f(p)$. This should help build appreciation for analogies with other energy domains, particularly in electrical systems where inductors (the mass analog) can have nonlinear relationships between current (a flow) and flux linkage (momentum).

The rotational motion of a rigid body considered here is constrained thus far to the simple case of planar and fixed-axis rotation. The mass moment of inertia of a body about an axis is defined as the sum of the products of the mass-elements and the squares of their distance from the axis. For the discrete case, $I = \sum r^2 \Delta m$, which for continuous cases becomes, $I = \int r^2 dm$ (units of kg m^2). Some common shapes

TABLE 9.5 Mechanical Kinetic Energy Storage Elements (Integral Form)

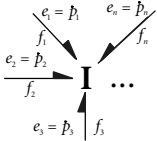
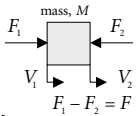
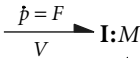
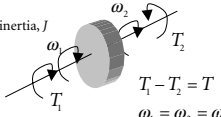
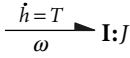
| Physical System | Fundamental Relations | Bond Graph |
|--|--|---|
| Generalized Kinetic Energy Storage Element  <ul style="list-style-type: none"> • Inertive element • Inertance, I | State: $\mathbf{p} = \text{momentum}$ Rate: $\dot{\mathbf{p}} = \mathbf{e}$ Constitutive: $\mathbf{f} = \Phi(\mathbf{p})$ Energy: $T_p = \int \mathbf{f} \cdot d\mathbf{p}$ Co-energy: $T_f = \int \mathbf{p} \cdot d\mathbf{f}$ |  Generalized multiport I-element |
| Mechanical Translation  <ul style="list-style-type: none"> • Mass • mass, m | State: $p = \text{momentum}$ Rate: $\dot{p} = F$ Constitutive: $V = V(p)$ Energy: $T_p = \int f \cdot dp$ Co-energy: $T_V = \int p \cdot dV$ |  Linear: $V = p/M$ Energy: $T_p = p^2/2M$ Co-energy: $T_V = \frac{1}{2} MV^2$ |
| Mechanical Rotation  <ul style="list-style-type: none"> • Rotational inertia • mass moment of inertia, J | State: $h = \text{angular momentum}$ Rate: $\dot{h} = T$ Constitutive: $\omega = \omega(h)$ Energy: $T_h = \int \omega \cdot dh$ Co-energy: $T_\omega = \int h \cdot d\omega$ |  Linear: $\omega = h/J$ Energy: $T_h = h^2/2J$ Co-energy: $T_\omega = \frac{1}{2} J \omega^2$ |

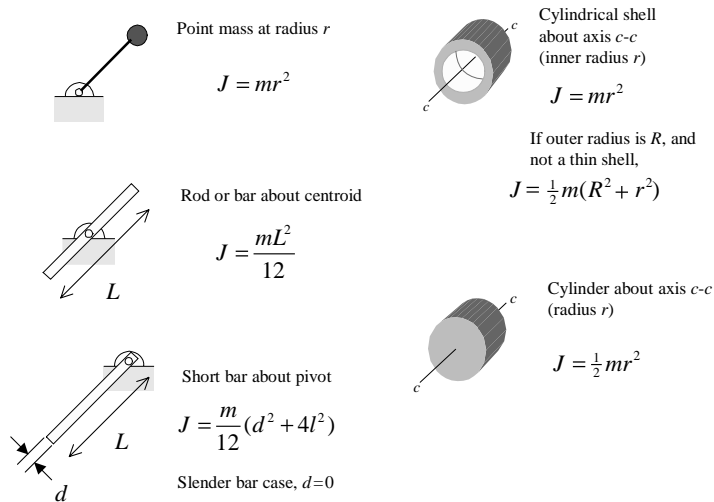

FIGURE 9.13 Mass moments of inertia for some common bodies.

and associated mass moments of inertia are given in Fig. 9.13. General rigid bodies are discussed in section “Inertia Properties.”

There are several useful concepts and theorems related to the properties of rigid bodies that can be helpful at this point. First, if the mass moment of inertia is known about an axis through its center of mass (I_G), then Steiner’s theorem (parallel axis theorem) relates this moment of inertia to that about another axis a distance d away by $I = I_G + md^2$, where m is the mass of the body. It is also possible to build a moment of inertia for composite bodies, in those situations where the individual motion of each body is negligible. A useful concept is the radius of gyration, k , which is the radius of an imaginary cylinder of infinitely small wall thickness having the same mass, m , and the same mass moment of inertia, I , as a body in question, and given by, $k = \sqrt{I/m}$. The radius of gyration can be used to find an equivalent mass for a rolling body, say, using $m_{eq} = I/k^2$.

Coupling Mechanisms

Numerous types of devices serve as couplers or power transforming mechanisms, with the most common being levers, gear trains, scotch yokes, block and tackle, and chain hoists. Ideally, these devices and their analogs in other energy domains are power conserving, and it is useful to represent them using a 2-port model. In such a model element, the power in is equal to the power out, or in terms of effort-flow pairs, $e_1 f_1 = e_2 f_2$. It turns out that there are two types of basic devices that can be represented this way, based on the relationship between the power variables on the two ports. For either type, a relationship between two of the variables can usually be identified from geometry or from basic physics of the device. By imposing the restriction that there is an ideal power-conserving transformation inherent in the device, a second relationship is derived. Once one relation is established the device can usually be classified as a **transformer** or **gyrator**. It is emphasized that these model elements are used to represent the ideal power-conserving aspects of a device. Losses or dynamic effects are added to model real devices.

A device can be modeled as a **transformer** when $e_1 = me_2$ and $mf_1 = f_2$. In this relation, m is a transformer **modulus** defined by the device physics to be constant or in some cases a function of states of the system. For example, in a simple gear train the angular velocities can be ideally related by the ratio of pitch radii, and in a slider crank there can be formed a relation between the slider motion and the crank angle. Consequently, the two torques can be related, so the gear train is a transformer. A device can be modeled as a **gyrator** if $e_1 = rf_2$ and $rf_1 = e_2$, where r is the gyrator modulus. Note that this model can represent

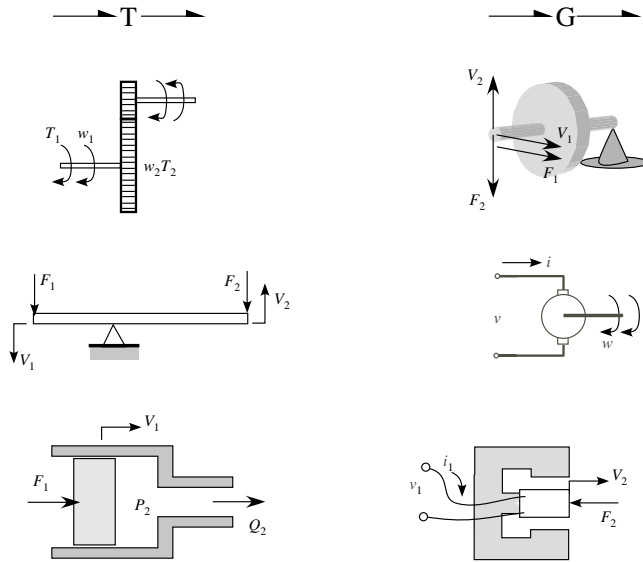

FIGURE 9.14 Common devices that can be modeled as transformers and gyrators in mechatronic systems.

the power-conserving transformation in devices for which a cross-relationship between power variables (i.e., effort related to flow) has been identified.²

Some examples of transformers and gyrators are shown in Fig. 9.14. In a bond graph model, the transformer can be represented by a TF or T, while a gyrator is represented by a GY or G (note, the two letter symbol is common). The devices shown in Fig. 9.14 indicate a modulus m or r , which may or may not be a constant value. Many devices may have power-conserving attributes; however, the relationship between the effort-flow variables may not be constant, so the relationship is said to be *modulated* when the modulus is a function of a dynamic variable (preferably a state of the system). On a bond graph, this can be indicated using a signal bond directed into the T or G modulus.

Examples of a modulated transformer and gyrator are given in Fig. 9.15. These examples highlight useful techniques in modeling of practical devices. In the slider crank, note that the modulation is due to a change in the angular position of the crank. We can get this information from a bond that is adjacent to the transformer in question; that is, if we integrate the angular velocity found on a neighboring bond, as shown in Fig. 9.15(a). For the field excited dc motor shown in Fig. 9.15(b), the torque–current relation in the motor depends on a flux generated by the field; however, this field is excited by a circuit that is powered *independent* of the armature circuit. The signal information for modulation does not come from a neighboring bond, as in the case for the slider crank. These two examples illustrate two ways that constraints are imposed in coupling mechanisms. The modulation in the slider crank might be said to represent a holonomic constraint, and along these same lines the field excitation in the motor imposes a non-holonomic constraint. We cannot relate torque and current in the latter case without solving for the dynamics of an independent system—the field circuit. In the slider crank, the angular position required for the modulation is obtained simply by integrating the velocity, since $\varphi = \omega$. Additional discussion on constraints can be found in section 9.7.

The system shown in Fig. 9.16(a) is part of an all-mechanical constant-speed drive. A mechanical feedback force, F_2 , will adjust the position of the middle rotor, x_2 . The effect is seen in the bond graph

²It turns out that the gyrator model element is essential in all types of systems. The need for such an element to represent gyroscopic effects in mechanical systems was first recognized by Thomson and Tait in the late 1900s. However, it was G. D. Birkhoff (1927) and B. D. H. Tellegen (1948) who independently identified the need for this element in analysis and synthesis of systems.

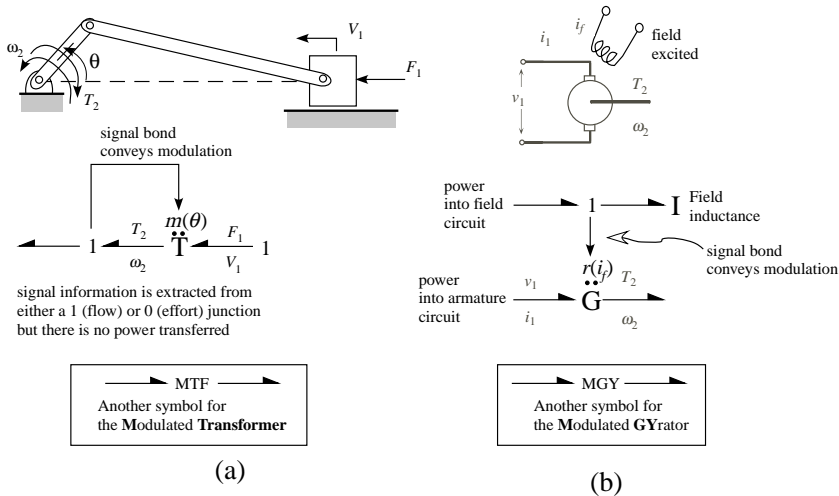

FIGURE 9.15 Concept of modulation in transformers and gyrators.

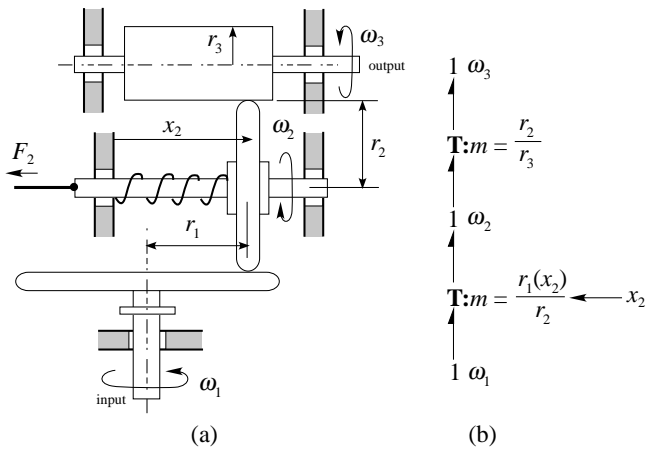

FIGURE 9.16 A nonholonomic constraint in a transformer model.

model of Fig. 9.16(b), which has two transformers to represent the speed ratio between the input (turntable) 1 and the mid-rotor 2, and the speed ratio between the mid-rotor and the output roller 3. The first transformer is a mechanical version of a nonholonomic transformation. Specifically, we would have to solve for the dynamics of the rotor position (x_2) in order to transform power between the input and output components of this device.

Impedance Relationships

The basic component descriptions presented so far are the basis for building basic models, and a very useful approach relies on impedance formulations. An impedance function, Z , is a ratio of effort to flow variables at a given system port of a physical device, and the most common application is for linear systems where $Z = Z(s)$, where s is the complex frequency variable (sometimes called the Laplace operator). An admittance is the inverse of the impedance, or $Y = 1/Z$. For each basic element defined, a linear impedance relation can be derived for use in model development. First, recall that the derivative operator can be represented by the s operator, so that dx/dt in s -domain is simply sx and $\int x dt$ is x/s , and so on.

TABLE 9.6 Basic Mechanical Impedance Elements

| System | Resistive, Z_R | Capacitive, Z_C | Inertive, Z_I |
|-------------|------------------|-------------------|-----------------|
| Translation | b | k/s | $m \cdot s$ |
| Rotation | B | K/s | $J \cdot s$ |

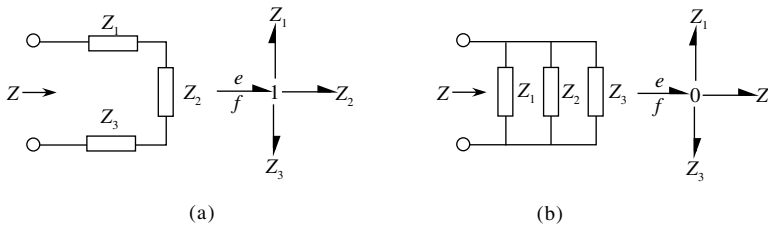

FIGURE 9.17 (a) Impedance of a series connection. (b) Admittance for a parallel combination.

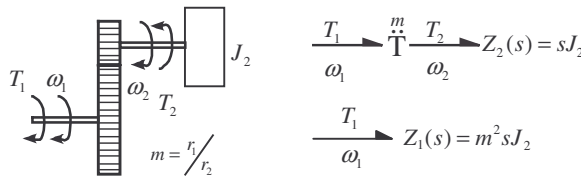

FIGURE 9.18 Rotational inertia attached to gear train, and corresponding model in impedance form. This example illustrates how a transformer can scale the gain of an impedance.

For the basic inertia element in rotation, for example, the basic rate law (see Table 9.5) is $\dot{h} = T$. In s -domain, $sh = T$. Using the linear constitutive relation, $h = J\omega$, so $sJ\omega = T$. We can observe that a rotation inertial impedance is defined by taking the ratio of effort to flow, or $T/\omega \equiv Z_I = sJ$. A similar exercise can be conducted for every basic element to construct Table 9.6.

Using the basic concept of a 0 junction and a 1 junction, which are the analogs of parallel and series circuit connections, respectively, basic impedance formulations can be derived for bond graphs in a way analogous to that done for circuits. Specifically, when impedances are connected in series, the total impedance is the sum, while admittances connected in parallel sum to give a total admittance. These basic relations are illustrated in Fig. 9.17, for which

$$Z = \underbrace{Z_1 + Z_2 + \dots + Z_n}_{n \text{ impedances in series sum to form a total impedance}}, \quad Y = \underbrace{Y_1 + Y_2 + \dots + Y_n}_{n \text{ admittances in parallel sum to form a total admittance}} \quad (9.2)$$

Impedance relations are useful when constructing transfer functions of a system, as these can be developed directly from a circuit analog or bond graph. The transformer and gyrator elements can also be introduced in these models. A device that can be modeled with a transformer and gyrator will exhibit impedance-scaling capabilities, with the moduli serving a principal role in adjusting how an impedance attached to one “side” of the device appears when “viewed” from the other side. For example, for a device having an impedance Z_2 attached on port 2, the impedance as viewed from port 1 is derived as

$$Z_1 = \frac{e_1}{f_1} = \begin{bmatrix} e_1 \\ e_2 \end{bmatrix} \begin{bmatrix} e_2 \\ f_2 \end{bmatrix} \begin{bmatrix} f_2 \\ f_1 \end{bmatrix} = [m][Z_2(s)][m] = m^2 Z_2(s) \quad (9.3)$$

This concept is illustrated by the gear-train system in Fig. 9.18. A rotational inertia is attached to the output shaft of the gear pair, which can be modeled as a transformer (losses, and other factors ignored here).

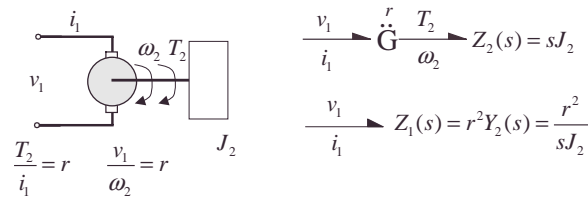

FIGURE 9.19 Rotational inertial attached to a basic rotational machine modeled as a simple gyrator. This example illustrates how a gyrator can scale the gain but also convert the impedance to an admittance form.

The impedance of the inertial is $Z_2 = sJ_2$, where J_2 is the mass moment of inertia. The gear train has an impedance-scaling capability, which can be designed through selection of the gear ratio, m .

The impedance change possible with a transformer is only in gain. The gyrator can affect gain and in addition can change the impedance into an admittance. Recall the basic gyrator relation, $e_1 = rf_2$ and $e_2 = rf_1$, then for a similar case as before,

$$\begin{bmatrix} 1 \\ 1 \end{bmatrix} = \begin{bmatrix} e_1 \\ f_2 \end{bmatrix} \begin{bmatrix} f_2 \\ e_2 \end{bmatrix} \begin{bmatrix} e_2 \\ f_1 \end{bmatrix} = [r][Y_2(s)][r] = r^2 Y_2(s) \quad (9.4)$$

This functional capability of gyrators helps identify basic motor-generator designs as integral parts of a flywheel battery system. A very simplified demonstration is shown in Fig. 9.19, where a flywheel (rotational inertia) is attached to the mechanical port of a basic electromechanical gyrator. When viewed from the electrical port, you can see that the gyrator makes the inertia “look” like a potential energy storing device, since the impedance goes as $1/(sC)$, like a capacitive element, although here C is a mechanical inertia.

9.4 Physical Laws for Model Formulation

This section will illustrate basic equation formulation for systems ranging in complexity from mass-spring-damper models to slightly more complex models, showing how to interface with nonmechanical models.

Previous sections of this chapter provide descriptions of basic elements useful in modeling mechanical systems, with an emphasis on a dynamic system approach. The power and energy basis of a bond graph approach makes these formulations consistent with models of systems from other energy domains. An additional benefit of using a bond graph approach is that a systematic method for causality assignment is available. Together with the physical laws, causal assignment provides insight into how to develop computational models. Even without formulating equations, causality turns out to be a useful tool.

Kinematic and Dynamic Laws

The use of basic kinematic and dynamic equations imposes a structure on the models we build to represent mechanical translation and rotation. Dynamic equations are derived from Newton’s laws, and we build free-body diagrams to understand how forces are imposed on mechanical systems. In addition, we must use geometric aspects of a system to develop kinematic equations, relying on properly defined coordinate systems. If the goal is to analyze a mechanical system alone, typically the classical application of conservation of momentum or energy methods and/or the use of kinematic analysis is required to arrive at solutions to a given problem. In a mechatronic system, it is implied that a mechanical system is coupled to other types of systems (hydraulics, electromechanical devices, etc.). Hence, we focus here on how to build models that will be easily integrated into overall system models. A detailed classical discussion of kinematics and dynamics from a fundamental perspective can be found in many introductory texts such as Meriam and Kraige [23] and Bedford and Fowler [5], or in more advanced treatments by Goldstein [11] and Greenwood [12].

When modeling simple translational systems or fixed-axis rotational systems, the basic set of laws summarized below are sufficient to build the necessary mathematical models.

| Basic Dynamic and Kinematic Laws | | |
|----------------------------------|--------------------|-------------------------|
| System | Dynamics | Kinematics |
| Translational | $\sum_i^N F_i = 0$ | $\sum_i^N V_i = 0$ |
| Rotational | $\sum_i^N T_i = 0$ | $\sum_i^N \omega_i = 0$ |
| Junction type | 1-junction | 0-junction |

There is a large class of mechanical systems that can be represented using these basic equations, and in this form it is possible to see how: (a) bond graph junction elements can be used to structure these models and (b) how these equations support circuit analog equations, since they are very similar to the Kirchhoff circuit laws for voltage and current. We present here the bond graph approach, which graphically communicates these physical laws through the 0- and 1-junction elements.

Identifying and Representing Motion in a Bond Graph

It is helpful when studying a mechanical system to focus on identifying points in the system that have distinct velocities (V or ω). One simply can associate a 1-junction with these points. Once this is done, it becomes easier to identify connection points for other mechanical components (masses, springs, dampers, etc.) as well as points for attaching actuators or sensors. Further, it is critical to identify and to define additional velocities associated with relative motion. These may not have clear, physically identifiable points in a system, but it is necessary to localize these in order to attach components that rely on relative motion to describe their operation (e.g., suspensions).

Figure 9.20 shows how identifying velocities of interest can help identify 1-junctions at which mechanical components can be attached. For the basic mass element in part (a), the underlying premise is that a component of a system under study is idealized as a pure translational mass for which momentum and velocity are related through a constitutive relation. What this implies is that the velocity of the mass is the same throughout this element, so a 1-junction is used to identify this distinct motion. A bond attached to this 1-junction represents how any power flowing into this junction can flow into a kinetic energy storing element, **I**, which represents the mass, m . Note that the force on the bond is equal to the rate of change of momentum, \dot{p} , where $p = mV$.

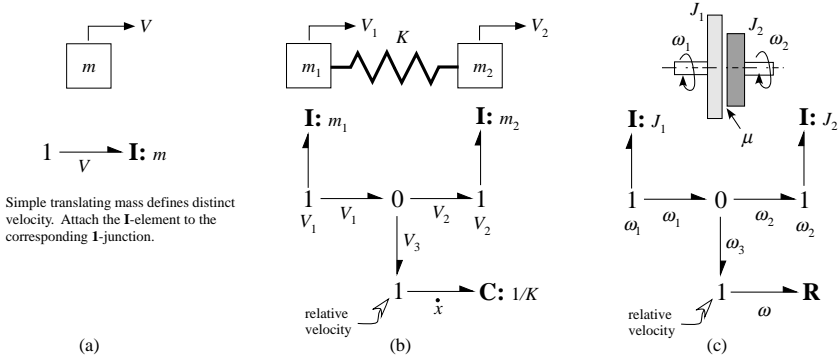

FIGURE 9.20 Identifying velocities in a mechanical system can help identify correct interconnection of components and devices: (a) basic translating mass, (b) basic two-degree of freedom system, (c) rotational frictional coupling between two rotational inertias.

The two examples in Figs. 9.20(b) and 9.20(c) demonstrate how a relative velocity can be formed. Two masses each identify the two distinct velocity points in these systems. Using a 0-junction allows construction of a *velocity difference*, and in each case this forms a relative velocity. In each case the relative velocity is represented by a 1-junction, and it is critical to identify that this 1-junction is essentially an attachment point for a basic mechanical modeling element.

Assigning and Using Causality

Bond graphs describe how modeling decisions have been made, and how model elements (R, C, etc.) are interconnected. A power bond represents power flow, and assigning power convention using a half-arrow is an essential part of making the graph useful for modeling. A sign convention is essential for expressing the algebraic summation of effort and flow variables at 0- and 1-junctions. Power is generally assigned positive sense flowing into passive elements (resistive, capacitive, inertive), and it is usually safe to always adopt this convention. Sign convention requires consistent and careful consideration of the reference conditions, and sometimes there may be some arbitrariness, not unlike the definition of reference directions in a free-body diagram.

Causality involves an augmentation of the bond graph, but is strictly independent of power flow convention. As discussed earlier, an assignment is made on each bond that indicates the input–output relationship of the effort-flow variables. The assignment of causality follows a very consistent set of rules. A system model that has been successfully assigned causality on all bonds essentially communicates solvability of the underlying mathematical equations. To understand where this comes from, we can begin by examining the contents of Tables 9.4 and 9.5. These tables refer to the *integral* form of the energy storage elements. An energy storage element is in integral form if it has been assigned integral causality. Integral causality implies that the causal input variable (effort or flow) leads to a condition in which the state of the energy stored in that element can be determined only by *integrating* the fundamental rate law. As shown in Table 9.7, integral causality for an I element implies effort is the input, whereas integral causality for the C element implies flow is the input.

TABLE 9.7 Table Summarizing Causality for Energy Storage Elements

| Integral Causality | Derivative Causality |
|--|--|
| <div style="display: flex; justify-content: space-between;"> <div style="width: 45%;">  </div> <div style="width: 45%;"> <p>CONSTITUTIVE $e = \Phi_C(q)$</p>  </div> </div> | <div style="display: flex; justify-content: space-between;"> <div style="width: 45%;">  </div> <div style="width: 45%;"> <p>INVERSE CONSTITUTIVE $q = \Phi_C^{-1}(e)$</p>  </div> </div> |
| <div style="display: flex; justify-content: space-between;"> <div style="width: 45%;">  </div> <div style="width: 45%;"> <p>CONSTITUTIVE $f = \Phi_I(p)$</p>  </div> </div> | <div style="display: flex; justify-content: space-between;"> <div style="width: 45%;">  </div> <div style="width: 45%;"> <p>INVERSE CONSTITUTIVE $p = \Phi_I^{-1}(f)$</p>  </div> </div> |

TABLE 9.8 Table of Causality Assignment Guidelines

| Sources | Junctions | Ideal Coupling Elements |
|------------------------|---|--|
| $E \xrightarrow{e(t)}$ |  |  |
| $F \xrightarrow{f(t)}$ |  |  |

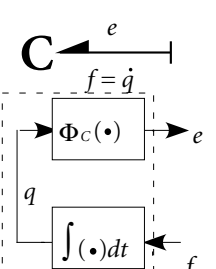
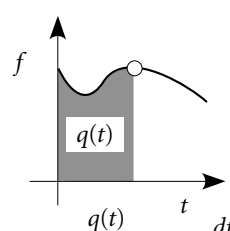
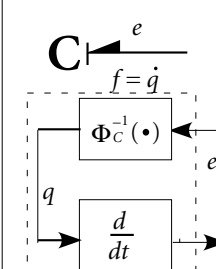
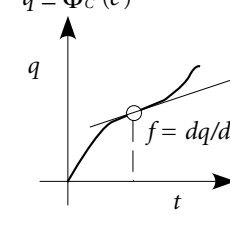
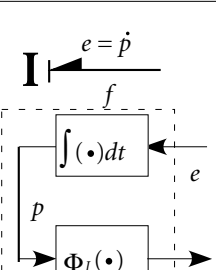
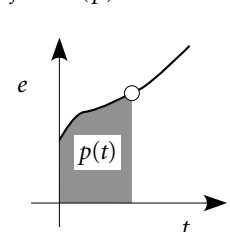
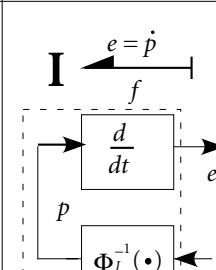
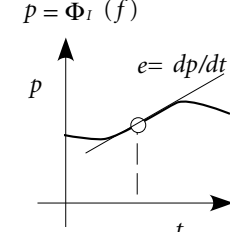
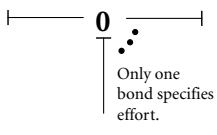
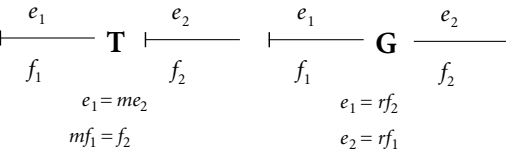
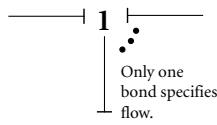
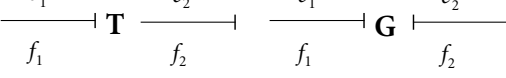
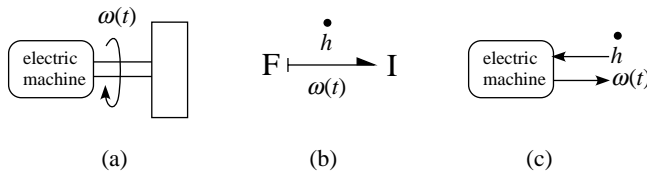

FIGURE 9.21 Driving a rotational inertia with a velocity source: (b) simple bond graph with causality, (c) explanation of back effect.

As shown in this table, the alternative causality for each element leads to *derivative causality*, a condition in which the state of the energy storage element is known instantaneously and as such is said to be *dependent* on the input variable, and is in a state of dependent causality. The implication is that energy storage elements in integral causality require one differential equation (the rate law) to be solved in order to determine the value of the *state variable* (p or q). Energy storage elements in derivative causality don't require a differential equation; however, they still make their presence known through the back reaction implied. For example, if an electric machine shown in Fig. 9.21(a) is assumed to drive a rotational inertia with a known velocity, ω , then the inertia is in derivative causality. There will also be losses, but the problem is simplified to demonstrate the causal implications. The energy is always known since, $h = J\omega$, so $T_h = h^2/2J$. However, the machine will feel an inertial back torque, \dot{h} , whenever a change is made to ω . This effect cannot be neglected.

Causality assignment on some of the other modeling elements is very specific, as shown in Table 9.8. For example, for sources of effort or flow, the causality is implied. On the two-port transformer and gyrator, there are two possible causality arrangements for each. Finally, for 0- and 1-junctions, the causality is also very specific since in each case only one bond can specify the effort or flow at each.

With all the guidelines established, a basic causality assignment procedure can be followed that will make sure all bonds are assigned causality (see also Rosenberg and Karnopp [32] and Karnopp, Margolis, and Rosenberg [17]).

1. For a given system, assign causality to any effort or flow sources, and for each one assign the causality as required through 0- and 1-junctions and transformer and gyrator elements. The causality should be spread through the model until a point is reached where no assignment is implied. Repeat this procedure until all sources have been assigned causality.
2. Assign causality to any C or I element, trying to assign integral causality if possible. For each assignment, propagate the causality through the system as required. Repeat this procedure until all storage elements are assigned causality.

3. Make any final assignments on **R** elements that have not had their causality assigned through steps 1 and 2, and again propagate causality as required. Any arbitrary assignment on an **R** element will indicate need for solving an algebraic equation.
4. Assign any remaining bonds arbitrarily, propagating each case as necessary.

Causality can provide information about system operation. In this sense, the bond graph provides a picture of how inputs to a system lead to certain outputs. The use of causality with a bond graph replaces ad hoc assignment of causal notions in a system. This type of information is also useful for understanding how a system can be split up into modules for simulation and/or it can confirm the actual physical boundaries of components.

Completing the assignment of causality on a bond graph will also reveal information about the solvability of the system model. The following are key results from causality assignment.

- Causality assignment will reveal the order of the system, which is equal to the number of independent energy storage elements (i.e., those with integral causality). The state variable (p or q) for any such element will be a state of the system, and one first-order differential equation will be required to describe how this state propagates through time.
- Any arbitrary assignment of causality on an **R** element indicates there is an algebraic loop. The number of arbitrary assignments can be related to the number of algebraic equations required in the model.

Developing a Mathematical Model

Mathematical models for lumped-parameter mechanical systems will take the form of coupled ordinary differential equations or, for a linear or linearized system, transfer functions between variables of interest and system inputs. The form of the mathematical model should match the application, and one can readily convert between the different forms. A classical approach to developing the mathematical model will involve applying Newton's second law directly to each body, taking account of the forces and torques. Commonly, the result is a second-order ordinary differential equation for each body in a system. An alternative is to use Lagrange's equations, and for multidimensional dynamics, where bodies may have combined translation and rotation, additional considerations are required as will be discussed in [Section 9.6](#). At this point, consider those systems where a given body is either under translation or rotation.

Mass-Spring-Damper: Classical Approach

A basic mechanical system that consists of a rigid body that can translate in the z -direction is shown in [Fig. 9.22\(a\)](#). The system is modeled using a mass, a spring, and a damper, and a force, $F(t)$, is applied

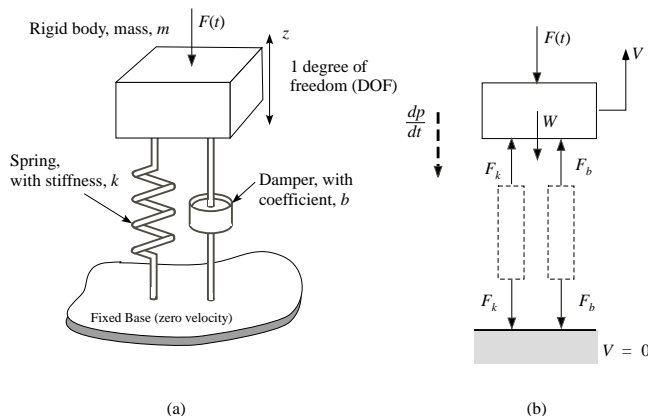

FIGURE 9.22 Basic mass-spring-damper system: (a) schematic, (b) free-body diagram.

directly to the mass. A free-body diagram in part (b) shows the forces exerted on the system. The spring and damper exert forces F_k and F_b on the mass, and these same forces are also exerted on the fixed base since the spring and damper are assumed to be massless. A component of the weight, W , resolved along the axis of motion is included. The sum of applied forces is then, $\sum F = F(t) + W - F_k - F_b$. The dashed arrow indicates the “inertial force” which is equal to the rate of change of the momentum in the z -direction, p_z , or, $dp_z/dt = \dot{p}_z = m\dot{V}_z$. This term is commonly used in a D’Alembert formulation, one can think of this force as opposing or resisting the effect of applied forces to accelerate the body. It is common to use the inertial force as an “applied force,” especially when performing basic analysis (e.g., see Chapter 3 or 6 of [23]).

Newton’s second law relates rate of change of momentum to applied forces, $\dot{p} = \sum F$, so, $\dot{p}_z = F(t) + W - F_k - F_b$. To derive a mathematical model, form a basic coordinate system with the z -axis positive upward. Recall the constitutive relations for each of the modeling elements, assumed here to be linear, $p_z = mV_z$, $F_k = k z_k$, and $F_b = bV_b$. In each of these elements, the associated velocity, V , or displacement, z , must be identified. The mass has a velocity, $V_z = \dot{z}$, relative to the inertial reference frame. The spring and damper have the same *relative* velocity since one end of each component is attached to the mass and the other to the base. The change in the spring length is z and the velocity is $\dot{z} - V_{\text{base}}$. However, $V_{\text{base}} = 0$ since the base is fixed, so putting this all together with Newton’s second law, $m\ddot{z} = F(t) + W - kz - b\dot{z}$. A second order ordinary differential equation (ODE) is derived for this single degree of freedom (DOF) system as

$$m\ddot{z} + b\dot{z} + kz = F(t) + W$$

In this particular example, if W is left off, z is the “oscillation” about a position established by static equilibrium, $z_{\text{static}} = W/k$.

If a transfer function is desired, a simple Laplace transform leads to (assuming zero initial conditions for motion about z_{static})

$$\frac{Z(s)}{F(s)} = \frac{1}{ms^2 + bs + k}$$

The simple mass-spring-damper example illustrates that models can be readily derived for mechanical systems with direct application of kinematics and Newton’s laws. As systems become more complex either due to number of bodies and geometry, or due to interaction between many types of systems (hydraulic, electromechanical, etc.), it is helpful to employ tools that have been developed to facilitate model development. In a subsequent section, multibody problems and methods of analysis are briefly discussed. It has often been argued that the utility of bond graphs can only be seen when a very complex, multi-energetic system is analyzed. This need not be true, since a system (or mechatronics) analyst can see that a consistent formulation and efficacy of causality are very helpful in analyzing many different types of physical systems. This should be kept in mind, as these basic bond graph methods are used to re-examine the simple mass-spring-damper system.

Mass-Spring-Damper: Bond Graph Approach

Figure 9.23 illustrates the development of a bond graph model for a mass-spring-damper system. In part (a), the distinct velocity points are identified and 1-junctions are used to represent them on a bond graph. Even though the base has zero velocity, and there will be no power flow into or out of that point, it is useful to identify it at this point. A relative velocity is formed using a 0-junction, and note that all bonds have sign convention applied, so at the 0-junction, $V_{\text{mass}} - V_{\text{relative}} - V_{\text{base}} = 0$, which gives, $V_{\text{relative}} = V_{\text{mass}} - V_{\text{base}}$ as required.

The model elements needed to represent the system are connected to the 1-junctions, as shown in Fig. 9.23(b). Two sources are required, one to represent the applied force (effort, S_e) due to weight, and a second to represent the fixed based velocity (a flow source, S_f). The flow source is directly attached to

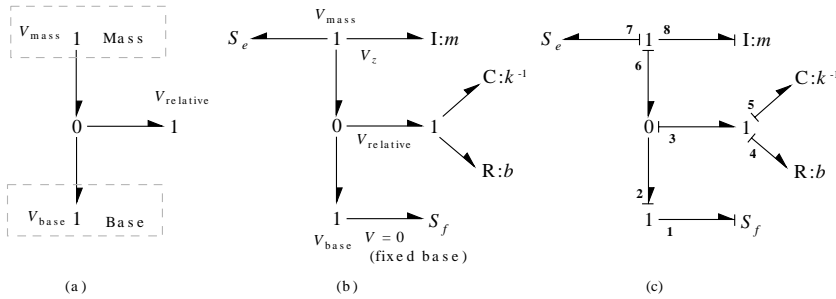
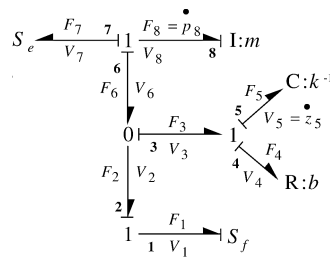

FIGURE 9.23 Basic mass-spring-damper system: (a) identifying velocity 1-junctions, (b) attaching model elements, (c) assignment of causality.



| | |
|-----------------|---|
| C_5 rate law: | $z_5 = V_5$ $V_5 = V_3$ $V_3 = V_6 - V_2$ $V_6 = V_8 = p_8/m_8^*$ $V_2 = V_1 = 0^*$ |
| I_8 rate law: | $\dot{p}_8 = -F_7 - F_6$ $F_7 = W^*$; $F_6 = F_3$ $F_3 = F_4 + F_5$ $F_4 = bV_4 = bV_3^{**}$ $F_5 = k_5 z_5^*$ |

FIGURE 9.24 Equation derivation for mass-spring-damper. The ‘*’ indicates these relations are reduced to functions of state or input. A ‘**’ shows an intermediate variable has been reached that has elsewhere been reduced to ‘*’.

the 1-junction (the extra bond could be eliminated). An **I** element represents mass, a **C** represents the spring, and an **R** represents the losses in the damper. Note how the mass and the source of effort are attached to the 1-junction representing the mass velocity (the weight is always applied at that velocity). The spring and damper are attached via a power bond to the relative velocity between the mass and base.

Finally, in Fig. 9.23(c) the eight bonds are labeled and causality is assigned. First, the fixed base source fixes the causality on bond 1, specifying the velocity at the 1-junction, and thus constraining the causality of bond 2 to have effort into the 1-junction. Since bond 2 did not specify effort into the 0-junction, causality assignment should proceed to other sources, and the effort source fixes causality on bond 7. This bond does not specify the flow at the adjoining 1-junction, so at this point we could look for other specified sources. Since there are none, we assign causality to any energy-storing elements which have a preferred integral causality. The bond 8 is assigned to give the **I** element integral causality (see Table 9.7), which then specifies the velocity at the 1-junction and thus constrains bond 6. At this point, bonds 6 and 2 both specify flow into the 0-junction, so the remaining bond 3 must specify the effort. This works out well because now bond 3 specifies flow into the remaining 1-junction (the relative velocity), which specifies velocity into the **C** and **R** elements. For the **C** element, this gives integral causality.

In summary, the causality is assigned and there are no causal conflicts (e.g., two bonds trying to specify velocity into a 1-junction). Both energy-storing elements have integral causality. This indicates that the states for the **I** (mass) and **C** (spring) will contribute to the state variables of the system. This procedure assures a minimum-size state vector, which in this case is of order 2 (a 2nd-order system). Figure 9.24 shows a fully annotated bond graph, with force-velocity variables labeling each bond. The state for an **I** element is a momentum, in this case the translational momentum of the mass, p_8 . For a **C** element, a

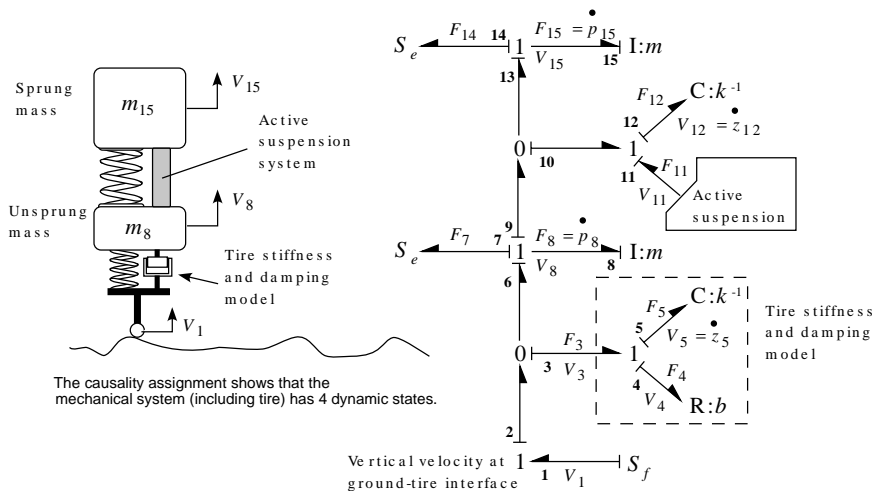

FIGURE 9.25 Example of model for vertical vibration in a quarter-car suspension model with an active suspension element. This example builds on the simple mass-spring-damper model, and shows how to integrate an actuator into a bond graph model structure.

displacement variable is the state z_5 , which here represents the change in length of the spring. The state vector is $\mathbf{x}^T = [p_8, z_5]$.

A mathematical model can be derived by referring to this bond graph, focusing on the independent energy storage elements. The **rate law** (see Tables 9.4 and 9.5) for each energy storage element in integral causality constitutes one first-order ordinary differential **state equation** for this system. In order to formulate these equations, the right-hand side of each rate law must be a function only of states or inputs to the system. The process is summarized in the table of Fig. 9.24. Note that the example assumes linear constitutive relations for the elements, but it is clear in this process that this is not necessary. Of course, in some cases nonlinearity complicates the analysis as well as the modeling process in other ways.

Quarter-car Active Suspension: Bond Graph Approach

The simple mass-spring-damper system forms a basis for building more complex models. A model for the vertical vibration of a quarter-car suspension is shown in Fig. 9.25. The bond graph model illustrates the use of the mass-spring-damper model, although there are some changes required. In this case, the base is now moving with a velocity equal to the vertical velocity of the ground-tire interface (this requires knowledge of the terrain height over distance traveled as well as the longitudinal velocity of the vehicle). The power direction has changed on many of the bonds, with many now showing positive power flowing from the ground up into the suspension system.

The active suspension system is isolated to further illustrate how bond graph modeling promotes a modular approach to the study of complex systems. Most relevant is that the model identifies the required causal relation at the interface with the active suspension, specifying that the relative velocity is a causal input, and force is a causal output of the active suspension system. The active force is exerted in an equal and opposite fashion onto the sprung and unsprung mass elements.

The causality assignment identifies four states (two momentum states and two spring displacement states). Four first-order state equations can be derived using the rate laws of each of the independent energy-storing elements (C_5, I_8, C_{12}, I_{15}). At this point, depending on the goals of the analysis, either the nonlinear equations could be derived (which might include an active suspension force that depends on the velocity input), or a linearized model could be developed and impedance methods applied to derive a transfer function directly.

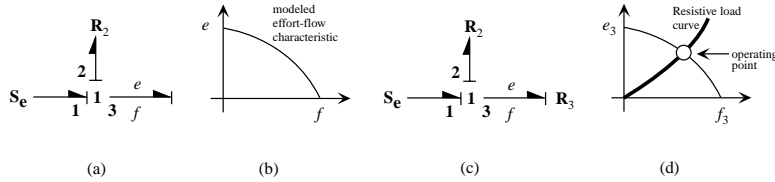

FIGURE 9.26 Algebraic loop in a simple source-load model.

Note on Some Difficulties in Deriving Equations

There are two common situations that can lead to difficulties in the mathematical model development. These issues will arise with any method, and is not specific to bond graphs. Both lead to a situation that may require additional algebraic manipulation in the equation derivation, and it may not be possible to accomplish this in closed form. There are also some ways to change the model in order to eliminate these problems, but this could introduce additional problems. The two issues are (1) derivative causality, and (2) algebraic loops. Both of these can be detected during causality assignment, so that a problem can be detected before too much time has been spent.

The occurrence of derivative causality can be described in bond graph terms using Table 9.7. The issue is one in which the state of an energy-storing element (**I** or **C**) is dependent on the system to which it is attached. This might not seem like a problem, particularly since this implies that no differential equation need be solved to find the state. It is necessary to see that there is still a need to compute the back-effect that the system will feel in forcing the element into a given state. For example, if a mass is to be driven by a velocity, V , then it is clear that we know the energy state, $p = mV$, so all is known. However, there is an inertial force computed as $\dot{p} = m\dot{V} = ma$. Many times, it is possible to resolve this problem by performing the algebraic manipulations required to include the effect of this element (difficulty depends on complexity of the system). Sometimes, these dependent states arise because the system is not modeled in sufficient detail, and by inserting a compliance between two gears, for example, the dependence is removed. This might solve the problem, costing only the introduction of an additional state. A more serious drawback to this approach would occur if the compliance was actually very small, so that numerical stiffness problems are introduced (with modern numerical solver routines, even this problem can be tolerated). Yet another way to resolve the problem of derivative causality in mechanical systems is to employ a Lagrangian approach for mechanical system modeling. This will be discussed in section 9.7.

Another difficulty that can arise in developing solvable systems of equations is the presence of an algebraic loop. Algebraic loops are relatively easy to generate, especially in a block diagram modeling environment. Indeed, it is often the case that algebraic loops arise because of modeling decisions, and in this way a bond graph's causality provides quick feedback regarding the system solvability. Algebraic loops imply that there is an arbitrary way to make computations in the model, and in this way they reveal themselves when an arbitrary decision must be made in assigning causality to an **R** element.³

As an example, consider the basic model of a Thevenin source in Fig. 9.26(a). This model uses an effort source and a resistive element to model an effort-flow (steady-state) characteristic curve, such as a motor or engine torque-speed curve or a force-velocity curve for a linear actuator. A typical characteristic is shown in Fig. 9.26(b). When a resistive load is attached to this source as shown in Fig. 9.26(c), the model is purely algebraic. When the causality is assigned, note that after applying the effort causality on bond 1, there are two resistive elements remaining. The assignment of causality is arbitrary. The solution

³The arbitrary assignment on an **R** element is not unlike the arbitrariness in assigning integral or derivative causality to energy-storing elements. An "arbitrary" decision to assign integral causality on an energy-storing element leads to a requirement that we solve a *differential* equation to find a state of interest. In the algebraic loop, a similar arbitrary decision to assign a given causality on an **R** element implies that at least one *algebraic* equation must be solved along with any other system equations. In other words, the system is described by differential algebraic equations (DAEs).

requires analytically solving algebraic relations for the operating point, or by using a graphical approach as shown in Fig. 9.26(d).

This is a simple example indicating how algebraic loops are detected with a bond graph, and how the solution requires solving algebraic relations. In complex systems, this might be difficult to achieve. Sometimes it is possible to introduce or eliminate elements that are “parasitic,” meaning they normally would be neglected due to their relatively small effect. However, such elements can relieve the causal bind. While this might resolve the problem, as in the case of derivative causality there are cases where such a course could introduce numerical stiffness problems. Sometimes a solution is reached by using energy methods to resolve some of these problems, as shown in the next section.

9.5 Energy Methods for Mechanical System Model Formulation

This section describes methods for using energy functions to describe basic energy-storing elements in mechanical systems, as well as a way to describe collections of energy-storing elements in multiport fields. Energy methods can be used to simplify model development, providing the means for deriving constitutive relations, and also as a basis for eliminating dependent energy storage (see last section). The introduction of these methods provides a basis for introducing the Lagrange equations in section 9.7 as a primary approach for system equation derivation or in combination with the bond graph formulation.

Multiport Models

The energy-storing and resistive models introduced in section 9.3 were summarized in Tables 9.2, 9.4, and 9.5 as multiport elements. In this section, we review how multiport elements can be used in modeling mechanical systems, and outline methods for deriving the constitutive relations. Naturally, these methods apply to the single-port elements as well.

An example of a C element with two-ports was shown in Fig. 9.12 as a model for a cantilevered beam that can have both translational and rotational deflections at its tip. A 2-port is required in this model because there are two independent ways to store potential energy in the beam. A distinguishing feature in this example is that the model is based on relationships between efforts and displacement variables (for this case of a capacitive element). Multiport model elements developed in this way are categorized as explicit fields to distinguish them from implicit fields [17]. Implicit fields are formed by assembling energy-storing 1-port elements with junction structure (i.e., 1, 0, and TF elements) to form multiport models.

Explicit fields are often derived using physical laws directly, relying on an understanding of how the geometric and material properties affect the basic constitutive relation between physical variables. Geometry and material properties always govern the parametric basis of all constitutive relations, and for some cases these properties may themselves be functions of state. Indeed, these cases require the multiport description, which finds extensive use in modeling of many practical devices, especially sensors and actuators. Multiport models should follow a strict energetic basis, as described in the following.

Restrictions on Constitutive Relations

Energy-storing multiports must follow two basic restrictions, which are also useful in guiding the derivation of energetically-correct constitutive relations. The definition of the energy-storing descriptions summarized in Tables 9.4 and 9.5 specifies that there exists an energy state function, $E = E(\mathbf{x})$, where \mathbf{x} is either a generalized displacement, \mathbf{q} , for capacitive (C) elements or a generalized momentum, \mathbf{p} , for inertive (I) elements. For the multiport energy-storing element, the specification requires the following specifications [2,3].

1. There exists a rate law, $\dot{x}_i = u_i$, where u_i as input specifies integral causality on port i .
2. The energy stored in a multiport is determined by

$$E(\mathbf{x}) = \int \sum_{i=1}^n y_i d\mathbf{x}_i \quad (9.5)$$

3. A first restriction on a multiport constitutive relation requires that the causal output at any port is given by

$$y_i = \Phi_{si}(\mathbf{x}) = \frac{\partial E(\mathbf{x})}{\partial x_i} \quad (9.6)$$

where $F_{si}(\cdot)$ is a single-valued function.

4. A second restriction on a multiport constitutive relation requires that the constitutive relations obey Maxwell reciprocity, or

$$\frac{\partial y_i}{\partial x_j} = \frac{\partial^2 E(\mathbf{x})}{\partial x_j \partial x_i} = \frac{\partial y_j}{\partial x_i} \quad (9.7)$$

Deriving Constitutive Relations

The first restriction on the constitutive relations, Eq. (9.6), establishes how constitutive relations can be derived for a multiport if an energy function can be formulated. This restriction forms the basis for a method used in many practical applications to find constitutive relationships from energy functions (e.g., strain-energy, electromechanics, etc.). In these methods, it is assumed that at least one of the constitutive relations for an energy-storing multiport is given. Then, the energy function is formed using Eq. (9.5) where, after interchanging the integral and sum,

$$\mathbf{x} = \sum_{i=1}^n \int y_i dx_i = \int y_1 dx_1 + \int y_n dx_n \quad (9.8)$$

Presume that y_1 is a known function of the states, $y_1 = \Phi_{s1}(\mathbf{x})$. Since the element is conservative, any energetic state can be reached via a convenient path where $dx_i = 0$ for all i except $i = 1$. This allows the determination of $E(\mathbf{x})$.

To illustrate, consider the simple case of a rack and pinion system, shown in Fig. 9.27. The pinion has rotational inertia, J , about its axis of rotation, and the rack has mass, m . The kinetic co-energy is easily formulated here, considering that the pinion angular velocity, ω , and the rack velocity, V , are constrained by the relationship $V = R\omega$, where R is the pinion base radius. If this basic subsystem is modeled directly, it will be found that one of the inertia elements (pinion, rack) will be in derivative causality. Say, it is desired to connect to this system through the rotational port, $T - \omega$. To form a single-port **I** element that includes the rack, form the kinetic co-energy as $T = T(\omega, V) = J\omega^2/2 + mV^2/2$. Use the constraint relation to write, $T = T(\omega) = (J + mR^2)\omega^2/2$. To find the constitutive relation for this 1-port rotational **I** element, let $h = \partial T(\omega)/\partial \omega = (J + mR^2)\omega$, where we can now define an equivalent rotational inertia as $J_{eq} = J + mR^2$.

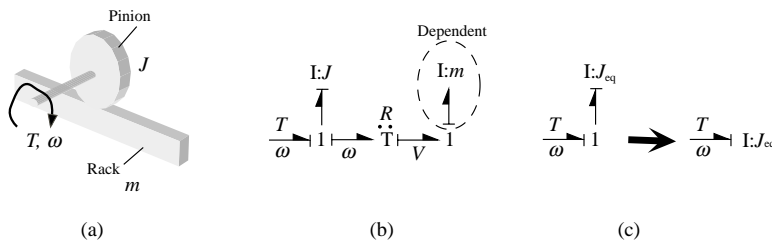

FIGURE 9.27 (a) Rack and pinion subsystem with torque input. (b) Direct model, showing dependent mass. (c) Equivalent model, derived using energy principles.

The rack and pinion example illustrates a basic method for relieving derivative causality, which can be used to build basic energy-storing element models. Some problems might arise when the kinetic co-energy depends on system configuration. In such a case, a more systematic method employing Lagrange's equations may be more suitable (see Section 9.7).

The approach described here for deriving constitutive relations is similar to Castigliano's theorem [6,9]. Castigliano's theorem relies on formulation of a strain-energy function in terms of the forces or moments, and as such employs a potential co-energy function. Specifically, the results lead to displacements (translational, rotational) as functions of efforts (forces, torques). As in the case above, these functions are found by taking partial derivatives of the co-energy with respect to force or moment. Castigliano's theorem is especially well-suited for finding force-displacement functions for curved and angled beam structures (see [6]).

Formulations using energy functions to derive constitutive relations are found in other application areas, and some references include Lyshevski [21] for electromechanics, and Karnopp, Margolis, and Rosenberg [17] for examples and applications in the context of bond graph modeling.

Checking the Constitutive Relations

The second restriction on the constitutive relations, Eq. (9.7), provides a basis for testing or checking if the relationships are correct. This is a reciprocity condition that provides a check for energy conservation in the energy-storing element model, and a quick check for linear mechanical systems shows that either the inertia or stiffness matrix must be symmetrical.

Recall the example of the 2-port cantilevered beam, shown again in Fig. 9.12. For small deflections, the total tip translational and angular deflections due to a tip force and torque can be added (using flexibility influence coefficients), which can be expressed in matrix form,

$$\begin{bmatrix} x \\ \theta \end{bmatrix} = \frac{1}{EI} \begin{bmatrix} \frac{1}{3} l^3 & \frac{1}{2} l^2 \\ \frac{1}{2} l^2 & l \end{bmatrix} \begin{bmatrix} F \\ T \end{bmatrix} = \mathbf{C} \begin{bmatrix} F \\ T \end{bmatrix} = \mathbf{K}^{-1} \begin{bmatrix} F \\ T \end{bmatrix}$$

where \mathbf{C} and \mathbf{K} are the compliance and stiffness matrices, respectively. This constitutive relation satisfies the Maxwell reciprocity since, $\partial x/\partial T = \partial \theta/\partial F$. This 2-port \mathbf{C} element is used to model the system shown in Fig. 9.28(a), which consists of a bar-bell rigidly attached to the tip of the beam. Under small deflection, a bond graph shown in Fig. 9.28(b) is assembled. Causality applied to this system reveals that each port of the 2-port \mathbf{C} element has integral causality. On a multiport energy storing element, each port is independently assigned causality following the same rules as for 1-ports. It is possible that a multiport could have a mixed causality, where some of the ports are in derivative causality. If a multiport has mixed causality, part of the state equations will have to be inverted. This algebraic difficulty is best avoided by trying to assign integral causality to all multiport elements in a system model if possible.

In the present example, causality assignment on the \mathbf{I} elements is also integral. In all, there are four independent energy-storing elements, so there are four state variables, $\mathbf{x} = [x, \theta, p, h]^T$. Four state equations can be derived using the rate laws indicated in Fig. 9.28.

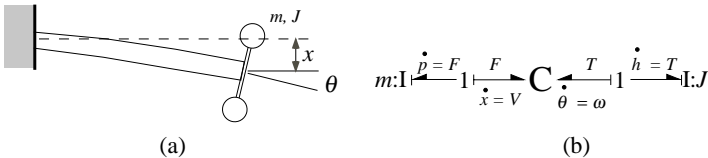

FIGURE 9.28 Model of beam rigidly supporting a bar- or dumb-bell: (a) schematic, (b) bond graph model using a 2-port \mathbf{C} to represent beam. Dumb-bell is represented by translational mass, m , and rotational inertia, J .

9.6 Rigid Body Multidimensional Dynamics

The modeling of bodies in mechanical systems presumes adoption of a “rigid body” that can involve rotation as well as translation, and in this case the dynamic properties are more complex than those for a point mass. In earlier sections of this chapter, a simple rigid body has already been introduced, and it is especially useful for a large class of problems with rotation about a single fixed axis.

In the rigid body, the distance between any two elements of mass within a body is a constant. In some cases, it is convenient to consider a continuous distribution of mass while in others a system of discrete mass particles rigidly fixed together helps conceptualize the problem. In the latter, the rigid body properties can be found by summing over all the discrete particles, while in the continuous mass concept an integral formulation is used. Either way, basic concepts can be formulated and relations derived for use in rigid body dynamic analysis. Finally, the modeling in most engineering systems is restricted to classical Newtonian mechanics, where the linear velocity–momentum relation holds (so energy and coenergy are equal).

Kinematics of a Rigid Body

In this section, a brief overview is given of three-dimensional motion calculations for a rigid body. The focus here is to present methods for analyzing rotation of a rigid body about a fixed axis and methods for analyzing relative motion of a rigid body using translating and rotating axes. These concepts introduce the basis for understanding more complex formulations. While vector descriptions (denoted using an arrow over the symbol, \vec{a}) are useful for understanding basic problems, more complex multibody systems usually adopt a matrix formulation. The presentation here is brief and included for reference. A more extensive discussion and examples can be found in introductory dynamics textbooks (e.g., [23]), where a separate discussion is usually given on the special case of plane motion.

Rotation of a Body About a Fixed Point

Basic concepts are introduced here in relation to rotation of a rigid body about a fixed point. This basic motion specifies that any point on the body lies on the surface of a sphere with a radius centered at the fixed point. The body can be said to have spherical motion.

Euler’s Theorem. Euler’s theorem states that any displacement of a body in spherical motion can be expressed as a rotation about a line that passes through the center of the spherical motion. This axis can be referred to as the orientational axis of rotation [26]. For example, two rotations about different axes passing through a fixed point of rotation are equivalent to a single resultant rotation about an axis passing through that point.

Finite Rotations. If the rotations used in Euler’s theorem are finite, the order of application is important because finite rotations do not obey the law of vector addition.

Infinitesimal Rotations. Infinitesimally small rotations can be added vectorially in any manner, and these are generally considered when defining rigid body motions.

Angular Velocity. A body subjected to rotation $d\vec{\theta}$ about a fixed point will have an angular velocity $\vec{\omega}$ defined by the time derivative $d\vec{\theta}/dt$, in a direction collinear with $d\vec{\theta}$. If the body is subjected to two component angular motions that define ω_1 and ω_2 , then the body has a resultant angular velocity, $\omega = \omega_1 + \omega_2$.

Angular Acceleration. A body’s angular acceleration is found from the time derivative of the angular velocity, $\vec{\alpha} = \dot{\vec{\omega}}$, and in general the acceleration is not collinear with velocity.

Motion of Points in the Body. Given ω , the velocity of a point on the body is $\vec{v} = \vec{\omega} \times \vec{r}$, where \vec{r} is a position vector to the point as measured relative to the fixed point of rotation. The acceleration of a point on the body is then, $\vec{a} = \vec{\alpha} \times \vec{r} + \vec{\omega} \times (\vec{\omega} \times \vec{r})$.

Relating Vector Time Derivatives in Coordinate Systems

It is often the case that we need to determine the time rate of change of a vector such as \vec{A} in Fig. 9.29 relative to different coordinate systems. Specifically, it may be easier to determine $\dot{\vec{A}}$ in x_a, y_a, z_a but we

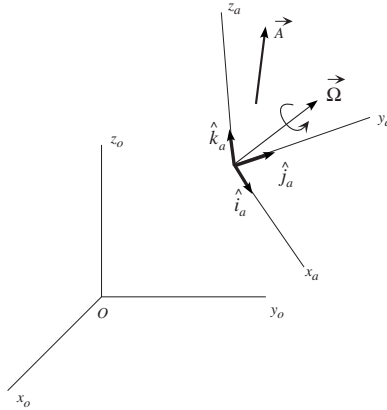

FIGURE 9.29 Often it is necessary to find the time derivative of vector \vec{A} relative to axes x_o, y_o, z_o , given its value in the translating-rotating system x_a, y_a, z_a .

need to find its value in x_o, y_o, z_o . The vector \vec{A} is expressed in the axes x_a, y_a, z_a using the unit vectors shown as

$$\vec{A} = A_x \hat{i}_a + A_y \hat{j}_a + A_z \hat{k}_a$$

To find the time rate of change, we identify that in the moving reference the time derivative of \vec{A} is

$$\left(\frac{d\vec{A}}{dt}\right)_a = \frac{dA_x}{dt} \hat{i}_a + \frac{dA_y}{dt} \hat{j}_a + \frac{dA_z}{dt} \hat{k}_a$$

Relative to the x_o, y_o, z_o axes, the direction of the unit vectors \hat{i}_a, \hat{j}_a , and \hat{k}_a change only due to rotation $\vec{\Omega}$, so,

$$\begin{aligned} \frac{d\vec{A}}{dt} &= \left(\frac{d\vec{A}}{dt}\right)_a + A_x \frac{d\hat{i}_a}{dt} + A_y \frac{d\hat{j}_a}{dt} + A_z \frac{d\hat{k}_a}{dt} \\ \frac{d\hat{i}_a}{dt} &= \vec{\Omega} \times \hat{i}_a, \quad \frac{d\hat{j}_a}{dt} = \vec{\Omega} \times \hat{j}_a, \quad \frac{d\hat{k}_a}{dt} = \vec{\Omega} \times \hat{k}_a \end{aligned}$$

then,

$$\frac{d\vec{A}}{dt} = \left(\frac{d\vec{A}}{dt}\right)_a + \vec{\Omega} \times \vec{A} \tag{9.9}$$

This relationship is very useful not only for calculating derivatives, as derived here, but also for formulating basic bond graph models. This is shown in the section titled “Rigid Body Dynamics.”

Motion of a Body Relative to a Coordinate System

Translating Coordinate Axes

The origin of a set of axes x_a, y_a, z_a is fixed in a rigid body at A as shown in Fig. 9.30(a), and translates without rotation relative to the axes x_o, y_o, z_o with known velocity and acceleration. The rigid body is subjected to angular velocity $\vec{\omega}$ and angular acceleration $\vec{\alpha}$ in three dimensions.

Motion of Point B Relative to A. The motion of point B relative to A is the same as motion about a fixed point, so $\vec{v}_{B/A} = \vec{\omega} \times \vec{r}_{B/A}$, and $\vec{a}_{B/A} = \vec{\alpha} \times \vec{r}_{B/A} + \vec{\omega} \times (\vec{\omega} \times \vec{r}_{B/A})$.

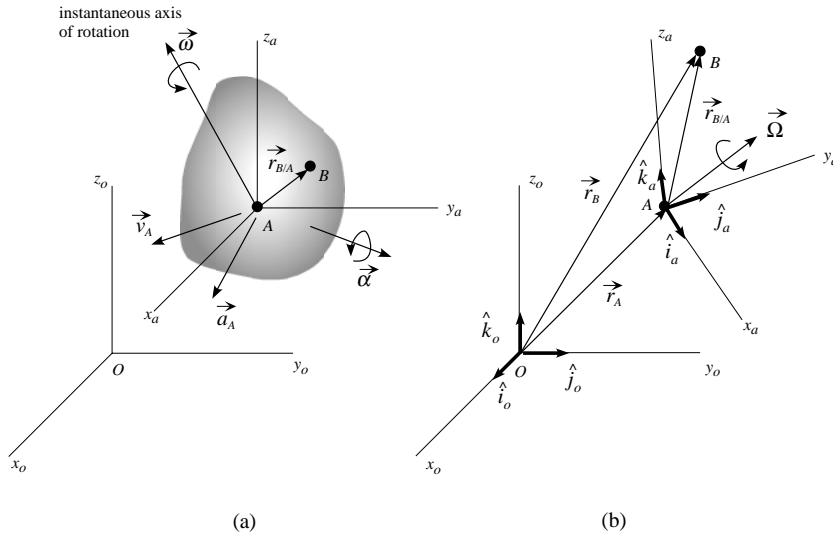

FIGURE 9.30 General rigid body motion: (a) rigid body with translating coordinate system, (b) translating and rotating coordinate system.

Motion of Point B Relative to O. For translating axes with no rotation, the velocity and acceleration of point B relative to system 0 is simply, $\vec{v}_B = \vec{v}_A + \vec{v}_{B/A}$ and $\vec{a}_B = \vec{a}_A + \vec{a}_{B/A}$ respectively, or,

$$\vec{v}_B = \vec{v}_A + \vec{\omega} \times \vec{r}_{B/A} \quad (9.10)$$

$$\vec{a}_B = \vec{a}_A + \vec{\alpha} \times \vec{r}_{B/A} + \vec{\omega} \times (\vec{\omega} \times \vec{r}_{B/A}) \quad (9.11)$$

Translating and Rotating Coordinate Axes

A general way of describing the three-dimensional motion of a rigid body uses a set of axes that can translate and rotate relative to a second set of axes, as illustrated in Fig. 9.30(b). Position vectors specify the locations of points A and B on the body relative to x_o, y_o, z_o , and the axes x_a, y_a, z_a have angular velocity $\vec{\Omega}$ and angular acceleration $\vec{\alpha}$. With the position of point B given by

$$\vec{r}_B = \vec{r}_A + \vec{r}_{B/A} \quad (9.12)$$

the velocity and acceleration are found by direct differentiation as

$$\dot{\vec{r}}_B = \dot{\vec{r}}_A + \vec{\Omega} \times \vec{r}_{B/A} + (v_{B/A})_a \quad (9.13)$$

and

$$\ddot{\vec{r}}_B = \ddot{\vec{r}}_A + \vec{\Omega} \times \dot{\vec{r}}_{B/A} + \dot{\vec{\Omega}} \times \vec{r}_{B/A} + 2\vec{\Omega} \times (v_{B/A})_a + (\ddot{a}_{B/A}) \quad (9.14)$$

where $(v_{B/A})_a$ and $(a_{B/A})_a$ are the velocity and acceleration, respectively, of B relative to A in the x_a, y_a, z_a coordinate frame.

These equations are applicable to plane motion of the rigid body for which the analysis is simplified since $\vec{\Omega}$ and $\dot{\vec{\Omega}}$ have a constant direction. Note that for the three-dimensional case, $\vec{\Omega}$ must be computed by using Eq. (9.9).

Matrix Formulation and Coordinate Transformations

A vector in three-dimensional space characterized by the right-handed reference frame x_a, y_a, z_a , $\vec{A} = A_x \hat{i}_a + A_y \hat{j}_a + A_z \hat{k}_a$, can be represented as an ordered triplet,

$$\vec{A} = \begin{bmatrix} A_x \\ A_y \\ A_z \end{bmatrix}_a = \begin{bmatrix} A_x & A_y & A_z \end{bmatrix}_a^T$$

where the elements of the column vector represent the vector projections on the unit axes. Let \underline{A}_a denote the column vector relative to the axes x_a, y_a, z_a . It can be shown that the vector \vec{A} can be expressed in another right-handed reference frame x_b, y_b, z_b by the transformation relation

$$\underline{A}_b = \bar{C}_{ab} \underline{A}_a \quad (9.15)$$

where \bar{C}_{ab} is a 3×3 matrix,

$$\bar{C}_{ab} = \begin{bmatrix} c x_a x_b & c x_a y_b & c x_a z_b \\ c y_a x_b & c y_a y_b & c y_a z_b \\ c z_a x_b & c z_a y_b & c z_a z_b \end{bmatrix} \quad (9.16)$$

The elements of this matrix are the cosines of the angles between the respective axes. For example, $c z_a y_b$ is the cosine of the angle between z_a and y_b . This is the rotational transformation matrix and it must be orthogonal, or

$$C_{ab}^{-1} = C_{ab}^T = C_{ba}$$

and for right-handed systems, let $C_{ab} = +1$.

Angle Representations of Rotation

The six degrees of freedom needed to describe general motion of a rigid body are characterized by three degrees of freedom each for translation and for rotation. The focus here is on methods for describing rotation.

Euler's theorem (11) confirms that only three parameters are needed to characterize rotation. Two parameters define an axis of rotation and another defines an angle about that axis. These parameters define three positional degrees of freedom for a rigid body. The three rotational parameters help construct a rotation matrix, \bar{C} . The following discussion describes how the rotation matrix, or direction cosine matrix, can be formulated.

General Rotation. Unit vectors for a system a , \hat{u}_a , are said to be carried into b , as $\hat{u}_b = \bar{C}_{ba} \hat{u}_a$. It can be shown that a direction cosine matrix can be formulated by [30]

$$\bar{C} = \underline{\lambda} \underline{\lambda}^T + (\bar{E} - \underline{\lambda} \underline{\lambda}^T) \cos \psi - \underline{\mathfrak{S}}(\underline{\lambda}) \sin \psi \quad (19.17)$$

where \bar{E} is the identity matrix, and $\underline{\lambda}$ represents a unit vector, $\underline{\lambda} = [\lambda_1, \lambda_2, \lambda_3]^T$, which is parallel to the axis of rotation, and ψ is the angle of rotation about that axis [30]. In this relation, $\underline{\mathfrak{S}}(\underline{\lambda})$ is a **skew-symmetric matrix**, which is defined by the form

$$\underline{\mathfrak{S}}(\underline{\lambda}) = \begin{bmatrix} 0 & -\lambda_3 & \lambda_2 \\ \lambda_3 & 0 & -\lambda_1 \\ -\lambda_2 & \lambda_1 & 0 \end{bmatrix}$$

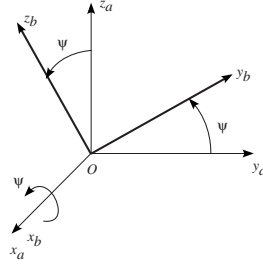

FIGURE 9.31 An elementary rotation by angle ϕ about axis x .

The matrix elements of $\underline{\bar{C}}$ can be found by expanding the relation given above, using $\underline{\bar{S}}(\lambda)$, to give

$$\underline{\bar{C}} = \begin{bmatrix} (1 - \cos \psi)\lambda_1^2 + \cos \psi & (1 - \cos \psi)\lambda_1\lambda_2 + \lambda_3 \sin \psi & (1 - \cos \psi)\lambda_1\lambda_3 + \lambda_2 \sin \psi \\ (1 - \cos \psi)\lambda_2\lambda_1 + \lambda_3 \sin \psi & (1 - \cos \psi)\lambda_2^2 + \cos \psi & (1 - \cos \psi)\lambda_2\lambda_3 + \lambda_1 \sin \psi \\ (1 - \cos \psi)\lambda_3\lambda_1 + \lambda_2 \sin \psi & (1 - \cos \psi)\lambda_3\lambda_2 + \lambda_1 \sin \psi & (1 - \cos \psi)\lambda_3^2 + \cos \psi \end{bmatrix} \quad (9.18)$$

The value of this formulation is in identifying that there are formally defined principle axes, characterized by the $\underline{\lambda}$, and angles of rotation, ψ , that taken together define the body orientation. These rotations describe classical angular variables formed by elementary (or principle) rotations, and it can be shown that there are two cases of particular and practical interest, formed by two different axis rotation sequences.

Elementary Rotations. Three elementary rotations are formed when the rotation axis (defined by the eigenvector) coincides with one of the base vectors of a defined coordinate system. For example, letting $\underline{\lambda} = [1, 0, 0]^T$ define an axis of rotation x , as in Fig. 9.31, with an elementary rotation of ϕ gives the rotation matrix,

$$\underline{\bar{C}}_{x,\phi} = \begin{bmatrix} 1 & 0 & 0 \\ 0 & \cos \phi & \sin \phi \\ 0 & -\sin \phi & \cos \phi \end{bmatrix}$$

The two elementary rotations about the other two axes, y and z , are

$$\underline{\bar{C}}_{y,\theta} = \begin{bmatrix} \cos \theta & 0 & -\sin \theta \\ 0 & 1 & 0 \\ \sin \theta & 0 & \cos \theta \end{bmatrix} \quad \text{and} \quad \underline{\bar{C}}_{z,\psi} = \begin{bmatrix} \cos \psi & \sin \psi & 0 \\ -\sin \psi & \cos \psi & 0 \\ 0 & 0 & 1 \end{bmatrix}$$

These three elementary rotation matrices can be used in sequence to define a direction cosine matrix, for example,

$$\underline{\bar{C}} = \underline{\bar{C}}_{z,\psi} \underline{\bar{C}}_{y,\theta} \underline{\bar{C}}_{x,\phi}$$

and the elementary rotations and the direction cosine matrix are all orthogonal; i.e.,

$$\underline{\bar{C}} \underline{\bar{C}}^T = \underline{\bar{C}}^T \underline{\bar{C}} = \underline{\bar{E}}$$

where $\underline{\bar{E}}$ is the identity matrix. Consequently, the inverse of the rotation or coordinate transformation matrix can be found by $\underline{\bar{C}}^{-1} = \underline{\bar{C}}^T$.

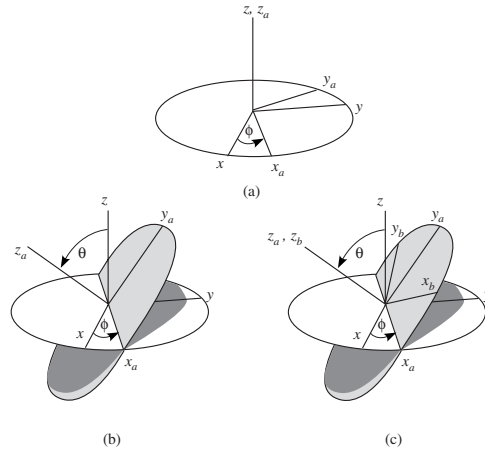

FIGURE 9.32 The rotations defining the Euler angles (adapted from Goldstein [11]).

It can be shown that there exist two sequences that have independent rotation sequences, and these lead to the well known Euler angle and Tait-Bryan or Cardan angle rotation descriptions [30].

Euler Angles. Euler angles are defined by a specific rotation sequence. Consider a right-handed axes system defined by the base vectors, x, y, z , as shown in Fig. 9.32(a). The rotation sequence of interest involves rotations about the axes in the following sequence: (1) ϕ about z , (2) θ about x_a , then (3) ψ about z_b . This set of rotation sequences is defined by the elementary rotation matrices,

$$\bar{C}_{z,\phi} = \begin{bmatrix} \cos \phi & \sin \phi & 0 \\ -\sin \phi & \cos \phi & 0 \\ 0 & 0 & 1 \end{bmatrix}, \quad \bar{C}_{x_a,\theta} = \begin{bmatrix} 1 & 0 & 0 \\ 0 & \cos \theta & \sin \theta \\ 0 & -\sin \theta & \cos \theta \end{bmatrix}, \quad \bar{C}_{z_b,\psi} = \begin{bmatrix} \cos \psi & \sin \psi & 0 \\ -\sin \psi & \cos \psi & 0 \\ 0 & 0 & 1 \end{bmatrix}$$

where the subscript on each \bar{C} denotes the axis and angle of rotation. Using these transformations relates the quantity \underline{A} in x, y, z to \underline{A}_b in x_b, y_b, z_b , or

$$\underline{A}_b = \bar{C}_{\text{Euler}} \underline{A} = \bar{C}_{z_b,\psi} \bar{C}_{x_a,\theta} \bar{C}_{z,\phi} \underline{A}$$

where \bar{C}_{Euler} is given by

$$\bar{C}_{\text{Euler}} = \begin{bmatrix} \cos \psi \cos \phi - \sin \psi \cos \theta \sin \phi & \cos \psi \sin \phi + \sin \psi \cos \theta \cos \phi & \sin \psi \sin \theta \\ -\sin \psi \cos \phi - \cos \psi \cos \theta \sin \phi & -\sin \psi \sin \phi + \cos \psi \cos \theta \cos \phi & \cos \psi \sin \theta \\ \sin \theta \sin \phi & -\sin \theta \cos \phi & \cos \theta \end{bmatrix} \quad (9.19)$$

Since \bar{C}_{Euler} is orthogonal, transforming between the two coordinate systems is relatively easy since the inverse can be found simply by the transpose of Eq. (9.19).

In some applications, it is desirable to derive the angles given the direction cosine matrix. So, if the (3,3) element of \bar{C}_{Euler} is given, then θ is easily found, but there can be difficulties in discerning small angles. Also, if θ goes to zero, there is a singularity in solving for ϕ and ψ , so determining body orientation becomes difficult. The problem also makes itself known when transforming angular velocities between the coordinate systems. If the problem at hand avoids this case (i.e., θ never approaches zero), then Euler angles are a viable solution. Many applications that cannot tolerate this problem adopt other representations, such as the Euler parameters to be discussed later.

In classical rigid body dynamics, ϕ is called the *precession angle*, θ is the *nutation angle*, and ψ is the *spin angle*. The relationship between the time derivative of the Euler angles, $\dot{\underline{\phi}} = [\dot{\phi}, \dot{\theta}, \dot{\psi}]^T$, and the body angular velocity, $\underline{\omega} = [\omega_x, \omega_y, \omega_z]_b^T$, is given by [11]

$$\underline{\omega}_b = \bar{T}(\underline{\phi})\dot{\underline{\phi}} \quad (9.20)$$

where the transformation matrix, $\bar{T}(\underline{\phi})$, is given by

$$\bar{T}(\underline{\phi}) = \begin{bmatrix} \sin \theta \sin \psi & \cos \psi & 0 \\ \sin \theta \cos \psi & -\sin \psi & 0 \\ \cos \theta & 0 & 1 \end{bmatrix}$$

Note here again that $\bar{T}(\underline{\phi})$ will become singular at $\theta = \pm\pi/2$.

Tait-Bryan or Cardan Angles. The Tait-Bryan or Cardan angles are formed when the three rotation sequences each occur about a different axis. This is the sequence preferred in flight and vehicle dynamics. Specifically, these angles are formed by the sequence: (1) ϕ about z (yaw), (2) θ about y_a (pitch), and (3) ϕ about the final x_b axis (roll), where a and b denote the second and third stage in a three-stage sequence or axes (as used in the Euler angle description). These rotations define a transformation,

$$\underline{A}_b = \bar{C} \underline{A} = \bar{C}_{x_b, \psi} \bar{C}_{y_a, \theta} \bar{C}_{z, \phi} \underline{A}$$

where

$$\bar{C}_{z, \phi} = \begin{bmatrix} \cos \phi & \sin \phi & 0 \\ -\sin \phi & \cos \phi & 0 \\ 0 & 0 & 1 \end{bmatrix}, \quad \bar{C}_{y_a, \theta} = \begin{bmatrix} \cos \theta & 0 & -\sin \theta \\ 0 & 1 & 0 \\ \sin \theta & 0 & \cos \theta \end{bmatrix}, \quad \bar{C}_{x_b, \psi} = \begin{bmatrix} 1 & 0 & 0 \\ 0 & \cos \psi & \sin \psi \\ 0 & -\sin \psi & \cos \psi \end{bmatrix}$$

and the final coordinate transformation matrix for Tait-Bryan angles is

$$\bar{C}_{\text{Tait-Bryan}} = \begin{bmatrix} \cos \theta \cos \phi & \cos \theta \sin \phi & -\sin \theta \\ \sin \psi \sin \theta \cos \phi - \cos \psi \sin \phi & \sin \psi \sin \theta \sin \phi + \cos \psi \cos \phi & \cos \theta \sin \psi \\ \cos \psi \sin \theta \cos \phi + \sin \psi \sin \phi & \cos \psi \sin \theta \sin \phi - \sin \psi \cos \phi & \cos \theta \cos \psi \end{bmatrix} \quad (9.21)$$

A linearized form of $\bar{C}_{\text{Tait-Bryan}}$ gives a form preferred to that derived for Euler angles, making it useful in some forms of analysis and control. There remains the problem of a singularity, in this case when θ approaches $\pm\pi/2$.

For the Tait-Bryan angles, the transformation matrix relating $\dot{\underline{\phi}}$ to $\underline{\omega}_b$ is given by

$$\bar{T}(\underline{\phi}) = \begin{bmatrix} -\sin \theta & 0 & 1 \\ \cos \theta \sin \psi & \cos \psi & 0 \\ \cos \theta \cos \psi & -\sin \psi & 0 \end{bmatrix}$$

which becomes singular at $\theta = 0, \pi$.

Euler Parameters and Quaternions

The degenerate conditions in coordinate transformations for Euler and Tait-Bryan angles can be avoided by using more than a minimal set of parameterizing variables (beyond the three angles). The most notable

set are referred to as Euler parameters, which are unit quaternions. There are many other possibilities, but this four-parameter method is used in many areas, including spacecraft/flight dynamics, robotics, and computational kinematics and dynamics. The term “quaternion” was coined by Hamilton in about 1840, but Euler himself had devised the use of Euler parameters 70 years before. Quaternions are discussed by Goldstein [11], and their use in rigid body dynamics and attitude control dates back to the late 1950s and early 1960s [13,24]. Application of quaternions is common in control applications in aerospace applications [38] as well as in ocean vehicles [10]. More recently (past 20 years or so), these methods have found their way into motion and control descriptions for robotics [34] and computational kinematics and dynamics [14,25,26]. An overview of quaternions and Euler parameters is given by Wehage [37]. Quaternions and rotational sequences and their role in a wide variety of applications areas, including sensing and graphics, are the subject of the book by Kuipers [19]. These are representative references that may guide the reader to an application area of interest where related studies can be found. In the following only a brief overview is given.

Quaternion. A quaternion is defined as the sum of a scalar, q_0 , and a vector, \vec{q} , or,

$$q = q_0 + \vec{q} = q_0 + q_1\hat{i} + q_2\hat{j} + q_3\hat{k}$$

A specific algebra and calculus exists to handle these types of mathematical objects [7,19,37]. The conjugate is defined as $q = q_0 - \vec{q}$.

Euler Parameters. Euler parameters are normalized (unit) quaternions, and thus share the same properties, algebra and calculus. A principal eigenvector of rotation has an eigenvalue of 1 and defines the Euler axis of rotation (see Euler’s theorem discussion and [11]), with angle of rotation α . Let this eigenvector be $\underline{e} = [e_1, e_2, e_3]^T$. Recall from Eq. (9.17), the direction cosine matrix is now

$$\underline{C} = \underline{e}\underline{e}^T + (I - \underline{e}\underline{e}^T) \cos \alpha - \underline{S}(\underline{e}) \sin \alpha$$

where $\underline{S}(\underline{e})$ is a skew-symmetric matrix. The Euler parameters are defined as

$$\underline{q} = \begin{bmatrix} q_0 \\ q_1 \\ q_2 \\ q_3 \end{bmatrix} = \begin{bmatrix} \cos(\alpha/2) \\ e_1 \sin(\alpha/2) \\ e_2 \sin(\alpha/2) \\ e_3 \sin(\alpha/2) \end{bmatrix}$$

where

$$q_0^2 + q_1^2 + q_2^2 + q_3^2 = 1$$

Relating Quaternions and the Coordinate Transformation Matrix. The direction cosine matrix in terms of Euler parameters is now

$$\underline{C}_q = (q_0^2 - \underline{q}\underline{q}^T) \underline{E} + 2\underline{q}\underline{q}^T - 2q_0\underline{S}(\underline{q})$$

where $\underline{q} = [q_1, q_2, q_3]^T$, and \underline{E} is the identity matrix. The direction cosine matrix is now written in terms of quaternions

$$\underline{C}_q = \begin{bmatrix} q_0^2 + q_1^2 - q_2^2 - q_3^2 & 2(q_1q_2 + q_3q_0) & 2(q_1q_3 - q_2q_0) \\ 2(q_1q_2 - q_3q_0) & q_0^2 - q_1^2 + q_2^2 - q_3^2 & 2(q_2q_3 + q_1q_0) \\ 2(q_1q_3 + q_2q_0) & 2(q_1q_2 + q_3q_0) & q_0^2 - q_1^2 - q_2^2 + q_3^2 \end{bmatrix}$$

It is possible to find the quaternions and the elements of the direction cosine matrix independently by integrating the angular rates about the principal axes of a body. Given the direction cosine matrix elements, we can find the quaternions, and vice versa. For a more extended discussion and application, the reader is referred to the listed references.

Dynamic Properties of a Rigid Body

Inertia Properties

The moments and products of inertia describe the distribution of mass for a body relative to a given coordinate system. This description relies on the specific orientation and reference frame. It is presumed that the reader is familiar with basic properties such as mass center, and the focus here is on those properties essential in understanding the general motion of rigid bodies, and particularly the rotational dynamics.

Moment of Inertia. For the rigid body shown in Fig. 9.33(a), the moment of inertia for a differential element, dm , about any of the three coordinate axes is defined as the product of the mass of the differential element and the square of the shortest distance from the axis to the element. As shown, $r_x = \sqrt{y^2 + z^2}$, so the contribution to the moment of inertia about the x -axis, I_{xx} , from dm is

$$dI_{xx} = r_x^2 = (y^2 + z^2) dm$$

The total I_{xx} , I_{yy} , and I_{zz} are found by integrating these expressions over the entire mass, m , of the body. In summary, the three moments of inertia about the x , y , and z axes are

$$\begin{aligned} I_{xx} &= \int_m r_x^2 dm = \int_m (y^2 + z^2) dm \\ I_{yy} &= \int_m r_y^2 dm = \int_m (x^2 + z^2) dm \\ I_{zz} &= \int_m r_z^2 dm = \int_m (x^2 + y^2) dm \end{aligned} \tag{9.22}$$

Note that the moments of inertia, by virtue of their definition using squared distances and finite mass elements, are always positive quantities.

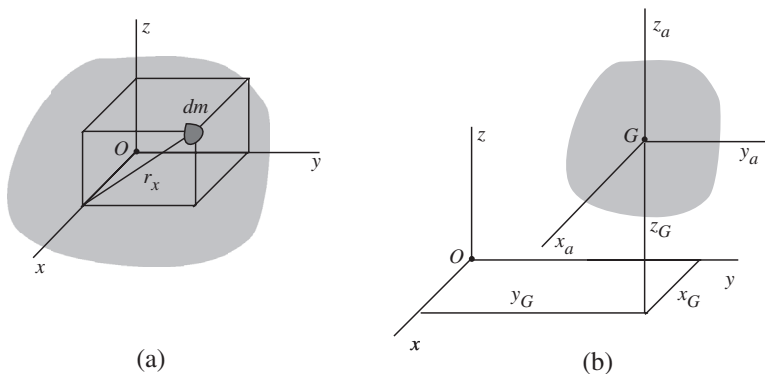

FIGURE 9.33 Rigid body properties are defined by how mass is distributed throughout the body relative to a specified coordinate system. (a) Rigid body used to describe moments and products of inertia. (b) Rigid body and axes used to describe parallel-axis and parallel-plane theorem.

Product of Inertia. The product of inertia for a differential element dm is defined with respect to a set of two orthogonal planes as the product of the mass of the element and the perpendicular (or shortest) distances from the planes to the element. So, with respect to the $y - z$ and $x - z$ planes (z common axis to these planes), the contribution from the differential element to I_{xy} is dI_{xy} and is given by $dI_{xy} = xy dm$.

As for the moments of inertia, by integrating over the entire mass of the body for each combination of planes, the products of inertia are

$$\begin{aligned} I_{xy} &= I_{yx} = \int_m xy \, dm \\ I_{yz} &= I_{zy} = \int_m yz \, dm \\ I_{xz} &= I_{zx} = \int_m xz \, dm \end{aligned} \quad (9.23)$$

The product of inertia can be positive, negative, or zero, depending on the sign of the coordinates used to define the quantity. If either one or both of the orthogonal planes are planes of symmetry for the body, the product of inertia with respect to those planes will be zero. Basically, the mass elements would appear as pairs on each side of these planes.

Parallel-Axis and Parallel-Plane Theorems. The parallel-axis theorem can be used to transfer the moment of inertia of a body from an axis passing through its mass center to a parallel axis passing through some other point (see also the section “Kinetic Energy Storage”). Often the moments of inertia are known for axes fixed in the body, as shown in Fig. 9.33(b). If the center of gravity is defined by the coordinates (x_G, y_G, z_G) in the x, y, z axes, the parallel-axis theorem can be used to find moments of inertia relative to the x, y, z axes, given values based on the body-fixed axes. The relations are

$$\begin{aligned} I_{xx} &= (I_{xx})_a + m(y_G^2 + z_G^2) \\ I_{yy} &= (I_{yy})_a + m(x_G^2 + z_G^2) \\ I_{zz} &= (I_{zz})_a + m(x_G^2 + y_G^2) \end{aligned}$$

where, for example, $(I_{xx})_a$ is the moment of inertia relative to the x_a axis, which passes through the center of gravity. Transferring the products of inertia requires use of the parallel-plane theorem, which provides the relations

$$\begin{aligned} I_{xy} &= (I_{xy})_a + mx_G y_G \\ I_{yz} &= (I_{yz})_a + my_G z_G \\ I_{zx} &= (I_{zx})_a + mz_G x_G \end{aligned}$$

Inertia Tensor. The rotational dynamics of a rigid body rely on knowledge of the inertial properties, which are completely characterized by nine terms of an inertia tensor, six of which are independent. The inertia tensor is

$$\bar{I} = \begin{bmatrix} I_{xx} & -I_{xy} & -I_{xz} \\ -I_{yx} & I_{yy} & -I_{yz} \\ -I_{zx} & -I_{zy} & I_{zz} \end{bmatrix}$$

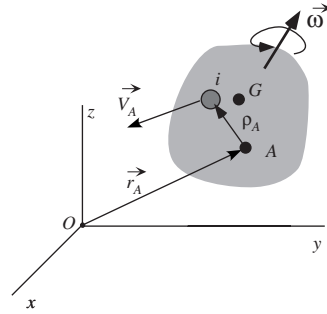

FIGURE 9.34 Rigid body in general motion relative to an inertial coordinate system, x, y, z .

and it relies on the specific location and orientation of coordinate axes in which it is defined. For a rigid body, an origin and axes orientation can be found for which the inertia tensor becomes diagonalized, or

$$\bar{I} = \begin{bmatrix} I_x & 0 & 0 \\ 0 & I_y & 0 \\ 0 & 0 & I_z \end{bmatrix}$$

The orientation for which this is true defines the principal axes of inertia, and the principal moments of inertia are now $I_x = I_{xx}$, $I_y = I_{yy}$, and $I_z = I_{zz}$ (one should be a maximum and another a minimum of the three). Sometimes this orientation can be determined by inspection. For example, if two of the three orthogonal planes are planes of symmetry, then all of the products of inertia are zero, so this would define principal axes of inertia.

The principal axes directions can be interpreted as an eigenvalue problem, and this allows you to find the orientation that will lead to principal directions, as well as define (transform) the inertia tensor into any orientation. For details on this method, see Crandall et al. [8].

Angular Momentum

For the rigid body shown in Fig. 9.34, conceptualized to be composed of particles, i , of mass, m_i , the angular momentum about the point A is defined as

$$(\vec{h}_A)_i = \vec{\rho}_A \times m_i \vec{V}_i$$

where \vec{V}_i is the velocity measured relative to the inertial frame. Since $\vec{V}_i = \vec{V}_A + \vec{\omega} \times \vec{\rho}_A$, then

$$(\vec{h}_A)_i = \vec{\rho}_A \times m_i \vec{V}_i = m_i \vec{\rho}_A \times \vec{V}_A + m_i \vec{\rho}_A \times (\vec{\omega} \times \vec{\rho}_A)$$

Integrating over the mass of the body, the total angular momentum of the body is

$$\vec{h}_A = \left(\int_m \vec{\rho}_A dm \right) \times \vec{V}_A + \int_m \vec{\rho}_A \times (\vec{\omega} \times \vec{\rho}_A) dm \quad (9.24)$$

This equation can be used to find the angular momentum about a point of interest by setting the point A : (1) fixed, (2) at the center of mass, and (3) an arbitrary point on the mass. A general form arises in cases 1 and 2 that take the form

$$\vec{h} = \int_m \vec{\rho} \times (\vec{\omega} \times \vec{\rho}) dm$$

When this form is expanded for either case into x, y, z components, then

$$\vec{h} = h_x \hat{i} + h_y \hat{j} + h_z \hat{k} = \int_m (x\hat{i} + y\hat{j} + z\hat{k}) \times [(\omega_x \hat{i} + \omega_y \hat{j} + \omega_z \hat{k}) \times (x\hat{i} + y\hat{j} + z\hat{k})] dm$$

which can be expanded to

$$\begin{aligned} h_x \hat{i} + h_y \hat{j} + h_z \hat{k} &= \left[\omega_x \int_m (y^2 + z^2) dm - \omega_y \int_m xy dm - \omega_z \int_m xz dm \right] \hat{i} \\ &= \left[-\omega_x \int_m xy dm + \omega_y \int_m (x^2 + z^2) dm - \omega_z \int_m yz dm \right] \hat{j} \\ &= \left[-\omega_x \int_m xy dm - \omega_y \int_m zy dm - \omega_z \int_m (x^2 + y^2) dm \right] \hat{k} \end{aligned}$$

The expression for moments and products of inertia can be identified here, and then this expression leads to the three angular momentum components, written in matrix form

$$\underline{h} = \begin{bmatrix} I_{xx} & -I_{xy} & -I_{xz} \\ -I_{yx} & I_{yy} & -I_{yz} \\ -I_{zx} & -I_{zy} & I_{zz} \end{bmatrix} \begin{bmatrix} \omega_x \\ \omega_y \\ \omega_z \end{bmatrix} = \underline{\tilde{I}} \underline{\omega} \quad (9.25)$$

Note that the case where principal axes are defined leads to the much simplified expression

$$\vec{h} = I_{xx} \omega_x \hat{i} + I_{yy} \omega_y \hat{j} + I_{zz} \omega_z \hat{k}$$

This shows that when the body rotates so that its axis of rotation is parallel to a principal axis, the angular momentum vector, \vec{h} , is parallel to the angular velocity vector. In general, this is not true (this is related to the discussion at the end of the section “Inertia Properties”).

The angular momentum about an arbitrary point, Case 3, is the resultant of the angular momentum about the mass center (a free vector) and the moment of the *translational momentum* through the mass center,

$$\vec{p} = mV_x \hat{i} + mV_y \hat{j} + mV_z \hat{k} = m\vec{V}$$

or

$$\vec{h} = \vec{h}_G + \vec{r} \times \vec{p}$$

where \vec{r} is the position vector from the arbitrary point of interest to the mass center, G . This form can also be expanded into its component forms, as in Eq. (9.25).

Kinetic Energy of a Rigid Body

Several forms of the kinetic energy of a rigid body are presented in this section. From the standpoint of a bond graph formulation, where kinetic energy storage is represented by an I element, Eq. (9.25) demonstrates that the rigid body has at least three ports for rotational energy storage. Adding the three translational degrees of freedom, a rigid body can have up to six independent energy storage “ports.”

A 3-port **I** element can be used to represent the rotational kinetic energy for the case of rotation about a fixed point (no translation). The constitutive relation is simply Eq. (9.25). The kinetic energy is then

$$T = \frac{1}{2} \vec{\omega} \cdot \vec{h}$$

where \vec{h} is the angular momentum with an inertia tensor defined about the fixed point. If the axes are aligned with principal axes, then

$$T = \frac{1}{2} I_x \omega_x^2 + \frac{1}{2} I_y \omega_y^2 + \frac{1}{2} I_z \omega_z^2$$

The total kinetic energy for a rigid body that can translate and rotate, with angular momentum defined with reference to the center of gravity, is given by

$$T = \frac{1}{2} m V_G^2 + \frac{1}{2} \vec{\omega} \cdot \vec{h}_G$$

where $V_G^2 = V_x^2 + V_y^2 + V_z^2$.

Rigid Body Dynamics

Given descriptions of inertial properties, translational and angular momentum, and kinetic energy of a rigid body, it is possible to describe the dynamics of a rigid body using the equations of motion using Newton's laws. The classical Euler equations are presented in this section, and these are used to show how a bond graph formulation can be used to integrate rigid body elements into a bond graph model.

Basic Equations of Motion

The translational momentum of the body in Fig. 9.30 is $\underline{p} = m\underline{V}$, where m is the mass, and \underline{V} is the velocity of the mass center with three components of velocity relative to the inertial reference frame x_o, y_o, z_o . In three-dimensional motion, the net force on the body is related to the rate of change of momentum by Newton's law, namely,

$$\underline{F} = \frac{d}{dt} \underline{p}$$

which can be expressed as (using Eq. (9.9)),

$$\underline{F} = \left. \frac{\partial \underline{p}}{\partial t} \right|_{\text{rel}} + \underline{\Omega} \times \underline{p}$$

with \underline{p} now relative to the moving frame x_a, y_a, z_a , and $\underline{\Omega}$ is the absolute angular velocity of the rotating axes.

A similar expression can be written for rate of change of the angular momentum, which is related to applied torques \underline{T} by

$$\underline{T} = \left. \frac{\partial \underline{h}}{\partial t} \right|_{\text{rel}} + \underline{\Omega} \times \underline{h}$$

where \underline{h} is relative to the moving frame x_a, y_a, z_a .

In order to use these relations effectively, the motion of the axes x_a, y_a, z_a , must be chosen to fit the problem at hand. This choice usually comes down to three cases described by how $\underline{\Omega}$ relates to the body angular velocity $\underline{\omega}$.

1. $\underline{\Omega} = 0$. If the body has general motion and the axes are chosen to translate with the center of mass, then this case will lead to a simple set of equations with $\Omega = 0$, although it will be necessary to describe the inertia properties of the body as functions of time.
2. $\underline{\Omega} \neq 0 \neq \underline{\omega}$. In this case, axes have an angular velocity different from that of the body, a form convenient for bodies that are symmetrical about their spinning axes. The moments and products of inertia will be constant relative to the rotating axes. The equations become

$$\begin{aligned}
 F_x &= m\dot{V}_x - mV_y\Omega_z + mV_z\Omega_y \\
 F_y &= m\dot{V}_y - mV_z\Omega_x + mV_x\Omega_z \\
 F_z &= m\dot{V}_z - mV_x\Omega_y + mV_y\Omega_x \\
 T_x &= I_x\dot{\omega}_x - I_y\omega_y\Omega_z + I_z\Omega_y\omega_z \\
 T_y &= I_y\dot{\omega}_y - I_z\omega_z\Omega_x + I_x\Omega_z\omega_x \\
 T_z &= I_z\dot{\omega}_z - I_x\omega_x\Omega_y + I_y\Omega_x\omega_y
 \end{aligned} \tag{9.26}$$

3. $\underline{\Omega} = \underline{\omega}$. Here the axes are fixed and moving with the body. The moments and products of inertia relative to the moving axes will be constant. A particularly convenient case arises if the axes are chosen to be the principal axes of inertia (see the section titled “Inertia Properties”), which leads to the *Euler equations*,⁴

$$\begin{aligned}
 F_x &= m\dot{V}_x - mV_y\omega_z + mV_z\omega_y \\
 F_y &= m\dot{V}_y - mV_z\omega_x + mV_x\omega_z \\
 F_z &= m\dot{V}_z - mV_x\omega_y + mV_y\omega_x \\
 T_x &= I_x\dot{\omega}_x - (I_y - I_z)\omega_y\omega_z \\
 T_y &= I_y\dot{\omega}_y - (I_z - I_x)\omega_z\omega_x \\
 T_z &= I_z\dot{\omega}_z - (I_x - I_y)\omega_x\omega_y
 \end{aligned} \tag{9.27}$$

These equations of motion can be used to determine the forces and torques, given motion of the body. Textbooks on dynamics [12,23] provide extensive examples on this type of analysis. Alternatively, these can be seen as six nonlinear, coupled ordinary differential equations (ODEs). Case 3 (the Euler equations) could be solved in such a case, since these can be rewritten as six first-order ODEs. A numerical solution may need to be implemented. Modern computational software packages will readily handle these equations, and some will feature a form of these equations in a form suitable for immediate use. Case 2 requires knowledge of the axes’ angular velocity, $\underline{\Omega}$.

If the rotational motion is coupled to the translational motion such that the forces and torques, say, are related, then a dynamic model is required. In some, it may be desirable to formulate the problem in a bond graph form, especially if there are actuators and sensors and other multienergetic systems to be incorporated.

⁴First developed by the Swiss mathematician L. Euler.

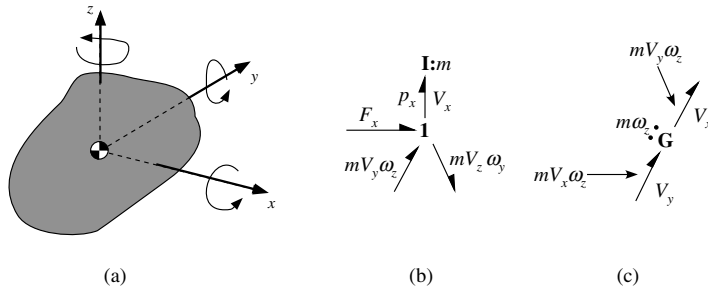

FIGURE 9.35 (a) Rigid body with angular velocity components about x, y, z axes. (b) x -direction translational dynamics in bond graph form. (c) Gyrator realization of coupling forces.

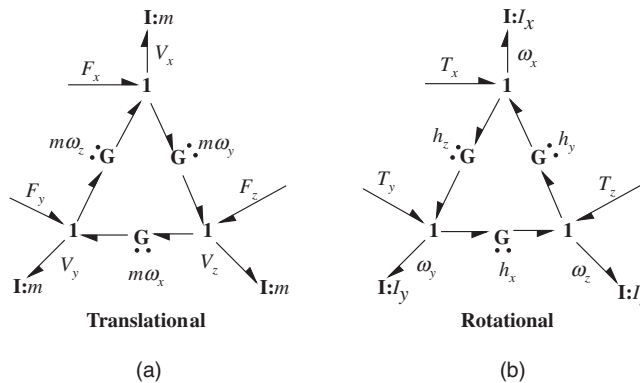

FIGURE 9.36 (a) Bond graph for rigid body translation. (b) Bond graph for rigid body rotation.

Rigid Body Bond Graph Formulation

Due to the body's rotation, there is an inherent coupling of the translational and rotational motion, which can be summarized in a bond graph form. Consider the case of Euler's equations, given in Eqs. (9.27). For the x -direction translational dynamics,

$$F_x = \dot{p}_x - mV_y\omega_z + mV_z\omega_y,$$

where $p_x = mV_x$, and F_x is the net "external" applied forces in the x -direction. This equation, a summation of forces (efforts) is represented in bond graph form in Fig. 9.35(b). All of these forces are applied at a common velocity, V_x , represented by the 1-junction. The I element represents the storage of kinetic energy in the body associated with motion in the x -direction. The force $mV_y\omega_z$ in Fig. 9.35(b) is induced by the y -direction velocity, V_y , and by the angular velocity component, ω_z . This physical effect is gyrational in nature, and can be captured by the gyrator, as shown in Fig. 9.35(c). Note that this is a modulated gyrator (could also be shown as **MGY**) with a gyrator modulus of $r = m\omega_z$ (verify that the units are force).

The six equations of motion, Eqs. (9.27), can be represented in bond graph form as shown in Fig. 9.36. Note that these two bond graph ring formations, first shown by Karnopp and Rosenberg [18], capture the Euler equations very efficiently and provide a graphical mnemonic for rigid body motion. Indeed, Euler's equations can now be "drawn" simply in the following steps: (1) lay down three 1-junctions representing angular velocity about x, y, z (counter clockwise labeling), with I elements attached, (2) between each 1-junction place a gyrator, modulated by the momentum about the axis represented by the

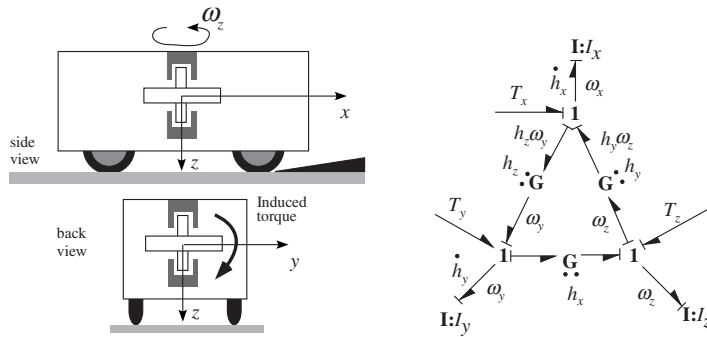

FIGURE 9.37 A cart with a rigid and internally mounted flywheel approaches a ramp.

1-junction directly opposite in the triangle, (3) draw power arrows in a counter clockwise direction. This sketch will provide the conventional Euler equations. The translational equations are also easily sketched.

These bond graph models illustrate the inherent coupling through the gyrator modulation. There are six **I** elements, and each can represent an independent energetic state in the form of the momenta $[p_x, p_y, p_z, h_x, h_y, h_z]$ or alternatively the analyst could focus on the associated velocities $[V_x, V_y, V_z, \omega_x, \omega_y, \omega_z]$.

If forces and torques are considered as inputs, through the indicated bonds representing $F_x, F_y, F_z, T_x, T_y, T_z$, then you can show that all the **I** elements are in integral causality, and the body will have six independent states described by six first-order nonlinear differential equations.

Example: Cart-Flywheel

A good example of how the rigid body bond graphs represent the basic mechanics inherent to Eqs. (9.27) and of how the graphical modeling can be used for “intuitive” gain is shown in Fig. 9.37. The flywheel is mounted in the cart, and spins in the direction shown. The body-fixed axes are mounted in the vehicle, with the convention that z is positive into the ground (common in vehicle dynamics). The cart approaches a ramp, and the questions which arise are whether any significant loads will be applied, what their sense will be, and on which parameters or variables they are dependent.

The bond graph for rotational motion of the flywheel (assume it dominates the problem for this example) is shown in Fig. 9.37. If the flywheel momentum is assumed very large, then we might just focus on its effect. At the 1-junction for ω_x , let $T_x = 0$, and since ω_z is spinning in a negative direction, you can see that the torque $h_z\omega_z$ is applied in a positive direction about the x -axis. This will tend to “roll” the vehicle to the right, and the wheels would feel an increased normal load. With the model shown, it would not be difficult to develop a full set of differential equations.

Need for Coordinate Transformations

In the cart-flywheel example, it is assumed that as the front wheels of the cart lift onto the ramp, the flywheel will react because of the direct induced motion at the bearings. Indeed, the flywheel-induced torque is also transmitted directly to the cart. The equations and basic bond graphs developed above are convenient if the forces and torques applied to the rigid body are moving with the rotating axes (assumed to be fixed to the body). The orientational changes, however, usually imply that there is a need to relate the body-fixed coordinate frames or axes to inertial coordinates. This is accomplished with a coordinate transformation, which relates the body orientation into a frame that makes it easier to interpret the motion, apply forces, understand and apply measurements, and apply feedback controls.

Example: Torquewhirl Dynamics

Figure 9.38(a) illustrates a cantilevered rotor that can exhibit torquewhirl. This is a good example for illustrating the need for coordinate transformations, and how Euler angles can be used in the modeling process. The whirling mode is conical and described by the angle θ . There is a drive torque, T_s , that is

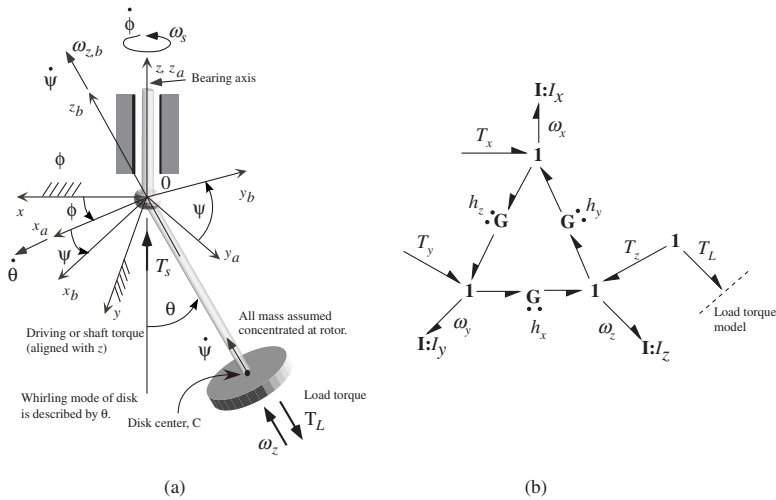

FIGURE 9.38 (a) Cantilevered rotor with flexible joint and rigid shaft (after Vance [36]). (b) Bond graph representing rigid body rotation of rotor.

aligned with the bearing axis, z , where x, y, z is the inertial coordinate frame. The bond graph in Fig. 9.38(b) captures the rigid body motion of the rotor, represented in body-fixed axes x_b, y_b, z_b , which represent principal axes of the rotor.

The first problem seen here is that while the bond graph leads to a very convenient model formulation, the applied torque, T_s , is given relative to the inertial frame x, y, z . Also, it would be nice to know how the rotor moves relative to the inertial frame, since it is that motion that is relevant. Other issues arise, including a stiffness of the rotor that is known relative to the angle θ . These problems motivate the use of Euler angles, which will relate the motion in the body fixed to the inertial frame, and provide three additional state equations for ϕ, θ , and ψ (which are needed to quantify the motion).

In this example, the rotation sequence is (1) x, y, z (inertial) to x_a, y_b, z_c , with ϕ about the z -axis, so note, $\dot{\phi} = \omega_s$, (2) x_a, y_a, z_a to x_b, y_b, z_b , with θ about x_a , (3) ψ rotation about z_b . Our main interest is in the overall transformation from x, y, z (inertia) to x_b, y_b, z_b (body-fixed). In this way, we relate the body angular velocities to inertial velocities using the relation from Eq. (9.20),

$$\begin{bmatrix} \omega_x \\ \omega_y \\ \omega_{z_b} \end{bmatrix} = \begin{bmatrix} \dot{\phi} \sin \theta \sin \psi + \dot{\theta} \cos \psi \\ \dot{\phi} \sin \theta \cos \psi - \dot{\theta} \sin \psi \\ \dot{\phi} \cos \theta + \dot{\psi} \end{bmatrix}$$

where the subscript b on the left-hand side denotes velocities relative to the x_b, y_b, z_b axes. A full and complete bond graph would include a representation of these transformations (e.g., see Karnopp, Margolis, and Rosenberg [17]). Explicit 1-junctions can be used to identify velocity junctions at which torques and forces are applied. For example, at a 1-junction for $\dot{\phi} = \omega_s$, the input torque T_s is properly applied. Once the bond graph is complete, causality is applied. The preferred assignment that will lead to integral causality on all the I elements is to have torques and forces applied as causal *inputs*. Note that in transforming the expression above which relates the angular velocities, a problem with Euler angles arises related to the singularity (here at $\theta = \pi/2$, for example).

An alternative way to proceed in the analysis is using a Lagrangian approach as in Section 9.7, as done by Vance [36] (see p. 292). Also, for advanced multibody systems, a multibond formulation can be more efficient and may provide insight into complex problems (see Breedveld [4] or Tiernego and Bos [35]).

9.7 Lagrange's Equations

The discussion on energy methods focuses on deriving constitutive relations for energy-storing multiports, and this can be very useful in some modeling exercises. For some cases where the constraint relationships between elements are primarily holonomic, and definitely scleronomic (not an explicit function of time), implicit multiport fields can be formulated (see Chapter 7 of [17]). The principal concern arises because of dependent energy storage, and the methods presented can be a solution in some practical cases. However, there are many mechanical systems in which geometric configuration complicates the matter. In this section, Lagrange's equations are introduced to facilitate analysis of those systems.

There are several ways to introduce, derive, and utilize the concepts and methods of Lagrange's equations. The summary presented below is provided in order to introduce fundamental concepts, and a thorough derivation can be found either in Lanczos [20] or Goldstein [11]. A derivation using energy and power flow is presented by Beaman, Paynter, and Longoria [3].

Lagrange's equations are also important because they provide a unified way to model systems from different energy domains, just like a bond graph approach. The use of scalar energy functions and minimal geometric reasoning is preferred by some analysts. It is shown in the following that the particular benefits of a Lagrange approach that make it especially useful for modeling mechanical systems enhance the bond graph approach. A combined approach exploits the benefits of both methods, and provides a methodology for treating complex mechatronic systems in a systematic fashion.

Classical Approach

A classical derivation of Lagrange's equations evolves from the concept of virtual displacement and virtual work developed for analyzing static systems (see Goldstein [11]). To begin with, the Lagrange equations can be derived for dynamic systems by using Hamilton's principle or D'Alembert's principle.

For example, for a system of particles, Newton's second law for the i mass, $\mathbf{F}_i = \dot{\mathbf{p}}_i$, is rewritten, $\mathbf{F}_i - \dot{\mathbf{p}}_i = 0$. The forces are classified as either applied or constraint, $\mathbf{F}_i = \mathbf{F}_i^{(a)} + \mathbf{f}_i$. The principle of virtual work is applied over the system, recognizing that constraint forces \mathbf{f}_i do no work and will drop out. This leads to the D'Alembert principle [11],

$$\sum_i (\mathbf{F}_i^{(a)} - \dot{\mathbf{p}}_i) \cdot \delta \mathbf{r}_i = 0 \quad (9.28)$$

The main point in presenting this relation is to show that: (a) the constraint forces do not appear in this formulative equation and (b) the need arises for transforming relationships between, in this case, the N coordinates of the particles, \mathbf{r}_i , and a set of n **generalized coordinates**, \mathbf{q} , which are independent of each other (for holonomic constraints), i.e.,

$$\mathbf{r}_i = \mathbf{r}_i(q_1, q_2, \dots, q_n, t) \quad (9.29)$$

By transforming to generalized coordinates, D'Alembert's principle becomes [11]

$$\sum_j \left[\left\{ \frac{d}{dt} \left(\frac{\partial T}{\partial \dot{q}_j} \right) - \frac{\partial T}{\partial q_j} \right\} - Q_j \right] \delta q_j = 0 \quad (9.30)$$

where T is the system kinetic energy, and the Q_j are components of the **generalized forces** given by

$$Q_j = \sum_i \mathbf{F}_i \cdot \frac{\partial \mathbf{r}_i}{\partial q_j}$$

If the transforming relations are restricted to be holonomic, the constraint conditions are implicit in the transforming relations, and independent coordinates are assured. Consequently, all the terms in Eq. (9.30) must vanish for independent virtual displacements, δq_j , resulting in the n equations:

$$\frac{d}{dt} \left(\frac{\partial T}{\partial \dot{q}_j} \right) - \frac{\partial T}{\partial q_j} = Q_j \quad (9.31)$$

These equations become Lagrange's equations through the following development. Restrict all the applied forces, Q_j , to be derivable from a scalar function, U , where in general, $U = U(q_j, \dot{q}_j)$, and

$$Q_j = -\frac{\partial U}{\partial q_j} + \frac{d}{dt} \left(\frac{\partial U}{\partial \dot{q}_j} \right)$$

The Lagrangian is defined as $L = T - U$, and substituted into Eq. (9.31) to yield the n Lagrange equations:

$$\frac{d}{dt} \left(\frac{\partial L}{\partial \dot{q}_j} \right) - \frac{\partial L}{\partial q_j} = Q_j \quad (9.32)$$

This formulation yields n second-order ODEs in the q_j .

Dealing with Nonconservative Effects

The derivation of Lagrange's equations assumes, to some extent, that the system is conservative, meaning that the total of kinetic and potential energy remains constant. This is not a limiting assumption because the process of reticulation provides a way to extract nonconservative effects (inputs, dissipation), and then to assemble the system later. It is necessary to recognize that the nonconservative effects can be integrated into a model based on Lagrange's equations using the Q_j 's. Associating these forces with the generalized coordinates implies work is done, and this is in accord with energy conservation principles (we account for total work done on system). The generalized force associated with a coordinate, q_j , and due to external forces is then derived from $Q_j = \delta W_j / \delta q_j$, where W_j is the work done on the system by all external forces during the displacement, δq_j .

Extensions for Nonholonomic Systems

In the case of nonholonomic constraints, the coordinates q_j are not independent. Assume you have m nonholonomic constraints ($m \leq n$). If the equations of constraint can be put in the form

$$\sum_k \frac{\partial a_l}{\partial \dot{q}_k} dq_k + \frac{\partial a_l}{\partial t} dt = \sum_k a_{lk} dq_k + a_{lt} dt = 0 \quad (9.33)$$

where l indexes up to m such constraints, then the Lagrange equations are formulated with Lagrange undetermined multipliers, λ_l . We maintain n coordinates, q_k , but the n Lagrange equations are now expressed [11] as

$$\frac{d}{dt} \left(\frac{\partial L}{\partial \dot{q}_k} \right) - \frac{\partial L}{\partial q_k} = \sum_l \lambda_l a_{lk}, \quad k = 1, 2, \dots, n \quad (9.34)$$

However, since there are now m unknown Lagrange multipliers, λ_l , it is necessary to solve an additional m equations:

$$\sum_k a_{lk} \dot{q}_k + a_{lt} = 0 \quad (9.35)$$

The terms $\sum_i \lambda_i a_{ik}$ can be interpreted as generalized forces of constraint. These are still workless constraints. The Lagrange equations for nonholonomic constraints can be used to study holonomic systems, and this analysis would provide a solution for the constraint forces through evaluation of the Lagrange multipliers. The use of Lagrange's equations with Lagrange multipliers is one way to model complex, constrained multibody systems, as discussed in Haug [14].

Mechanical Subsystem Models Using Lagrange Methods

The previous sections summarize a classical formulation and application of Lagrange's equations. When formulating models of mechanical systems, these methods are well proven. Lagrange's equations are recognized as an approach useful in handling systems with complex mechanical systems, including systems with constraints. The energy-basis also makes the method attractive from the standpoint of building multi-energetic system models, and Lagrange's equations have been used extensively in electromechanics modeling, for example. For conservative systems, it is possible to arrive at solutions sometimes without worrying about forces, especially since nonconservative effects can be handled "outside" the conservative dynamics. Developing transformation equations between the coordinates, say \mathbf{x} , used to describe the system and the independent coordinates, \mathbf{q} , helps assure a minimal formulation. However, it is possible sometimes to lose insight into cause and effect, which is more evident in other approaches. Also, the algebraic burden can become excessive. However, it is the analytical basis of the method that makes it especially attractive. Indeed, with computer-aided symbolic processing techniques, extensive algebra becomes a non-issue.

In this section, the advantages of the Lagrange approach are merged with those of a bond graph approach. The concepts and formulations are classical in nature; however, the graphical interpretation adds to the insight provided. Further, the use of bond graphs assures a consistent formulation with causality so that some insight is provided into how the conservative dynamics described by the energy functions depend on inputs, which typically arrive from the nonconservative dynamics. The latter are very effectively dealt with using bond graph methods, and the combined approach is systematic and yields first-order differential equations, rather than the second-order ODEs in the classical approach. Also, it will be shown that in some cases the combined approach makes it relatively easy to model certain systems that would be very troublesome for a direct approach by either method independently.

A Lagrange bond graph subsystem model will capture the elements summarized with a word bond graph in Fig. 9.39. The key elements are identified as follows: (a) conservative energy storage captured by kinetic and potential energy functions, (b) power-conserving transforming relations, and (c) coupling/interconnections with nonconservative and non-Lagrange system elements. Note that on the nonconservative side of the transforming relations, there are m coordinates that can be identified in the modeling, but these are not independent. The power-conserving transforming relations reduce the coordinates to a set of n independent coordinates, q_i . Associated with each independent coordinate or velocity, \dot{q}_i , there is an associated storage of kinetic and potential energy which can be represented by the coupled IC in Fig. 9.40(a) [16]. An alternative is the single C element used to capture all the coupled energy storage [3], where the gyrator has a modulus of 1 (this is called a symplectic gyrator). In either case, this structure shows that there will be one common flow junction associated with each independent coordinate. Recall the efforts at a 1-junction sum, and at this i th junction,

$$E_{q_i} = \dot{p}_i + e_{q_i} \quad (9.36)$$

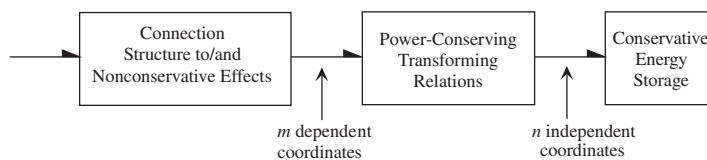

FIGURE 9.39 Block diagram illustrating the Lagrange subsystem model.

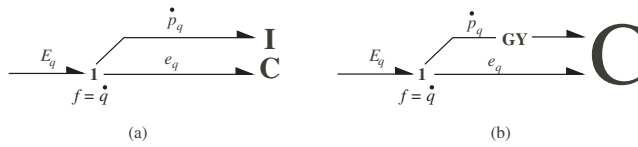

FIGURE 9.40 Elementary formulation of a flow junction in a Lagrange subsystem model. The efforts at the 1-junction for this i th independent flow variable, \dot{q}_i , represent Lagrange's equations.

where E_{q_i} is the net nonconservative effort at \dot{q}_i , e_{q_i} is a generalized conservative effort that will be determined by the Lagrange system, and the effort \dot{p}_i is a rate of change of an i th generalized momentum. These terms will be defined in the next section. However, note that this effort sum is simply Newton's laws derived by virtue of a Lagrange formulation. In fact, this equation is simply a restatement of the i th Lagrange equation, as will be shown in the following. These effort sum equations give n first-order ODEs by solving for \dot{p}_i . The other n equations will be for the displacement variables, q_i . The following methodology is adapted from Beaman, Paynter, and Longoria [3].

Methodology for Building Subsystem Model

Conduct Initial Modeling. Isolate the conservative parts of the system, and make sure that any constraints are holonomic. This reticulation will identify ports to the system under study, including points in the system (typically velocities) where forces and/or torques of interest can be applied (e.g., at flow junctions). These forces and torques are either nonconservative, or they are determined by a system external to the Lagrange-type subsystem. This is a modeling decision. For example, a force due to gravity could be included in a Lagrange subsystem (being conservative) or it could be shown explicitly at a velocity junction corresponding to motion modeled outside of the Lagrange subsystem. This will be illustrated in one of the examples that follow.

Define Generalized Displacement Variables. In a Lagrange approach, it is necessary to identify variables that define the configuration of a system. In mechanical system, these are translational and rotational displacements. Further, these variables are typically associated with the motion or relative motion of bodies. To facilitate a model with a minimum and independent set of coordinates, develop transforming relations between the m velocities or, more generally, flows $\dot{\mathbf{x}}$, and n independent flows, $\dot{\mathbf{q}}$. The form is [3],

$$\dot{\mathbf{x}} = \mathbf{T}(\mathbf{q})\dot{\mathbf{q}} \quad (9.37)$$

explicitly showing that the matrix $\mathbf{T}(\mathbf{q})$ can depend on \mathbf{q} . This can be interpreted, in bond graph modeling terms, as a modulated transformer relationship, where \mathbf{q} contains the modulating variables. The independent generalized displacements, \mathbf{q} , will form possible state variables of the Lagrange subsystem.

The transforming relationships are commonly derived from (holonomic) constraints, and from considerations of geometry and basic kinematics. The matrix \mathbf{T} is $m \times n$ and may not be invertible. The bond graph representation is shown in Fig. 9.41.

Formulate the Kinetic Energy Function. Given the transforming relationships, it is now possible to express the total kinetic energy of the Lagrange subsystem using the independent flow variables, $\dot{\mathbf{q}}$. First, the kinetic energy can be written using the $\dot{\mathbf{x}}$ (this is usually easier), or $\mathbf{T} = \mathbf{T}_{\dot{\mathbf{x}}}(\dot{\mathbf{x}})$. Then the relations in Eq. (9.37) are used to transform this kinetic energy function so it is expressed as a function of the \mathbf{q} and $\dot{\mathbf{q}}$ variables, $\mathbf{T}_{\dot{\mathbf{x}}}(\dot{\mathbf{x}}) \rightarrow \mathbf{T}_{\dot{\mathbf{q}}}(\dot{\mathbf{q}}, \mathbf{q})$. For brevity, this can be indicated in the subscript, or just $\mathbf{T}_{\dot{\mathbf{q}}}$. For example, a kinetic energy function that depends on x , θ , and $\dot{\theta}$ is referred to as $T_{\dot{\theta}x}$ (if the number of variables is very high, certainly such a convention would not be followed).

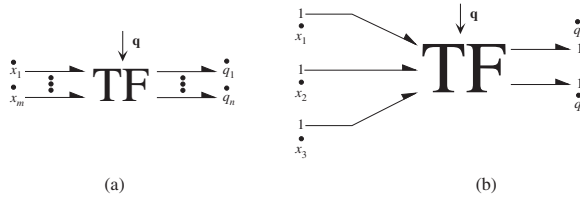

FIGURE 9.41 (a) Bond graph representation of the transforming relations. (b) Example for the case where $m = 3$ and $n = 2$.

Define Generalized Momentum Variables. With the kinetic energy function now in terms of the independent flows, \mathbf{q} , generalized momenta can be defined as [3,20],

$$\tilde{\mathbf{p}} = \frac{\partial T_{\dot{\mathbf{q}}\mathbf{q}}}{\partial \dot{\mathbf{q}}} \quad (9.38)$$

where the “tilde” ($\tilde{\mathbf{p}}$) notation is used to distinguish these momentum variables from momentum variables defined strictly through the principles summarized in Table 9.5. In particular note that these generalized momentum variables may be functions of flow as well as of displacement (i.e., they may be configuration dependent).

Formulate the Potential Energy Function. In general, a candidate system for study by a Lagrange approach will store potential energy, in addition to kinetic energy, and the potential energy function, U , should be expressed in terms of the dependent variables, \mathbf{x} . Using the transforming relations in Eq. (9.37), the expression is then a function of \mathbf{q} , or $U = U(\mathbf{q}) = U_{\mathbf{q}}$. In mechanical systems, this function is usually formed by considering energy stored in compliant members, or energy stored due to a gravitational potential. In these cases, it is usually possible to express the potential energy function in terms of the displacement variables, \mathbf{q} .

Derive Generalized Conservative Efforts. A conservative effort results and can be found from the expression

$$\tilde{\mathbf{e}}_{\mathbf{q}} = -\frac{\partial T_{\dot{\mathbf{q}}\mathbf{q}}}{\partial \mathbf{q}} + \frac{\partial U_{\mathbf{q}}}{\partial \mathbf{q}} \quad (9.39)$$

where the \mathbf{q} subscript is used to denote these as conservative efforts. The first term on the right-hand side represents an effect due to dependence of kinetic energy on displacement, and the second term will be recognized as the potential energy derived effort.

Identify and Express Net Power Flow into Lagrange Subsystem. At the input to the Lagrange subsystem on the “nonconservative” side, the power input can be expressed in terms of effort and flow products. Since the transforming relations are power-conserving, this power flow must equal the power flow on the “conservative” side. This fact is expressed by

$$P_x = \underbrace{\mathbf{e}_x}_{1 \times m} \underbrace{\dot{\mathbf{x}}}_{m \times 1} = \underbrace{\mathbf{e}_x}_{1 \times m} \underbrace{\mathbf{T}(\mathbf{q})}_{m \times n} \underbrace{\dot{\mathbf{q}}}_{n \times 1} = \underbrace{\mathbf{E}_q}_{1 \times n} \underbrace{\dot{\mathbf{q}}}_{n \times 1} \quad (9.40)$$

where the term \mathbf{E}_q is the nonconservative effort transformed into the \mathbf{q} coordinates. This term can be computed as shown by

$$\mathbf{E}_q = \mathbf{e}_x \mathbf{T}(\mathbf{q}) \quad (9.41)$$

Summary of the Method. In summary, all the terms for a Lagrange subsystem can be systematically derived. There are some difficulties that can arise. To begin with, the first step can require some geometric reasoning, and often this can be a problem in some cases, although not insurmountable. The n

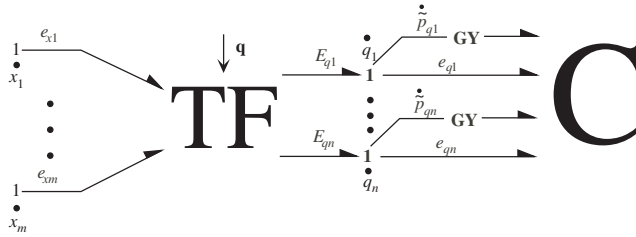

FIGURE 9.42 Lagrange subsystem model.

momentum state equations for this Lagrange subsystem are given by

$$\dot{\tilde{p}} = -e_i + E_i \quad (9.42)$$

and the state equations for the q_i must be found by inverting the generalized momentum equations, (9.38). In some cases, these n equations are coupled and must be solved simultaneously. In the end, there are $2n$ first-order state equations. In addition, the final bond graph element shown in Fig. 9.42 can be coupled to other systems to build a complex system model.

Note that in order to have the $2n$ equations in integral causality, efforts (forces and torques) should be specified as causal inputs to the transforming relations. Also, this subsystem model assumes that only holonomic constraints are applied. While this might seem restrictive, it turns out that, for many practical cases, the physical effects that lead to nonholonomic constraints can be dealt with “outside” of the Lagrange model, along with dissipative effects, actuators, and so on.

References

1. Arczewski, K. and Pietrucha, J., *Mathematical Modelling of Complex Mechanical Systems*, Ellis Horwood, New York, 1993.
2. Beaman, J.J. and Rosenberg, R.C., “Constitutive and modulation structure,” *Journal of Dynamic Systems, Measurement, and Control (ASME)*, Vol. 110, No. 4, pp. 395–402, 1988.
3. Beaman, J.J., Paynter, H.M., and Longoria, R.G., *Modeling of Physical Systems*, Cambridge University Press, in progress.
4. Breedveld, P.C., “Multibond graph elements in physical systems theory,” *Journal of the Franklin Institute*, Vol. 319, No. 1–2, pp. 1–36, 1985.
5. Bedford, A. and Fowler, W., *Engineering Mechanics. Dynamics*, 2nd edition, Addison Wesley Longman, Menlo Park, CA, 1999.
6. Burr, A.H., *Mechanical Analysis and Design*, Elsevier Science Publishing, Co., New York, 1981.
7. Chou, J.C.K., “Quaternion kinematic and dynamic differential equations,” *IEEE Transactions on Robotics and Automation*, Vol. 8, No. 1, February, 1992.
8. Crandall, S., Karnopp, D.C., Kurtz, E.F., and Pridmore-Brown, D.C., *Dynamics of Mechanical and Electromechanical Systems*, McGraw-Hill, New York, 1968 (Reprinted by Krieger Publishing Co., Malabar, FL, 1982).
9. Den Hartog, J.P., *Advanced Strength of Materials*, McGraw-Hill, New York, 1952.
10. Fjellstad, O. and Fossen, T.I., “Position and attitude tracking of AUVs: a quaternion feedback approach,” *IEEE Journal of Oceanic Engineering*, Vol. 19, No. 4, pp. 512–518, 1994.
11. Goldstein, D., *Classical Mechanics*, 2nd edition, Addison-Wesley, Reading, MA, 1980.
12. Greenwood, D.T., *Principles of Dynamics*, Prentice-Hall, Englewood Cliffs, NJ, 1965.
13. Harding, C.F., “Solution to Euler’s gyro-dynamics-I,” *Journal of Applied Mechanics*, Vol. 31, pp. 325–328, 1964.

14. Haug, E.J., *Computer Aided Kinematics and Dynamics of Mechanical Systems*, Allyn and Bacon, Needham, MA, 1989.
15. Kane, T.R. and Levinson, D.A., *Dynamics: Theory and Applications*, McGraw-Hill Publishing Co., New York, 1985.
16. Karnopp, D., "An approach to derivative causality in bond graph models of mechanical systems," *Journal of the Franklin Institute*, Vol. 329, No. 1, pp. 65–75, 1992.
17. Karnopp, D.C., Margolis, D., and Rosenberg, R.C., *System Dynamics: Modeling and Simulation of Mechatronic Systems*, Wiley, New York, 2000, 3rd edition, or *System Dynamics: A Unified Approach*, 1990, 2nd edition.
18. Karnopp, D. and Rosenberg, R.C., *Analysis and Simulation of Multiport Systems. The Bond Graph Approach to Physical System Dynamics*, MIT Press, Cambridge, MA, 1968.
19. Kuipers, J.B., *Quaternions and Rotation Sequences*, Princeton University Press, Princeton, NJ, 1998.
20. Lanczos, C., *The Variational Principles of Mechanics*, 4th edition, University of Toronto Press, Toronto, 1970. Also published by Dover, New York, 1986.
21. Lyshevski, S.E., *Electromechanical Systems, Electric Machines, and Applied Mechatronics*, CRC Press, Boca Raton, FL, 2000.
22. Matschinsky, W., *Road Vehicle Suspensions*, Professional Engineering Publishing Ltd., Suffolk, UK, 1999.
23. Meriam, J.L. and Kraige, L.G., *Engineering Mechanics. Dynamics*, 4th edition, John Wiley and Sons, New York, 1997.
24. Mortensen, R.E., "A globally stable linear regulator," *International Journal of Control*, Vol. 8, No. 3, pp. 297–302, 1968.
25. Nikravesh, P.E. and Chung, I.S., "Application of Euler parameters to the dynamic analysis of three-dimensional constrained mechanical systems," *Journal of Mechanical Design (ASME)*, Vol. 104, pp. 785–791, 1982.
26. Nikravesh, P.E., Wehage, R.A., and Kwon, O.K., "Euler parameters in computational kinematics and dynamics, Parts 1 and 2," *Journal of Mechanisms, Transmissions, and Automation in Design (ASME)*, Vol. 107, pp. 358–369, 1985.
27. Nososelov, V.S., "An example of a nonholonomic, nonlinear system not of the Chetaev type," *Vestnik Leningradskogo Universiteta*, No. 19, 1957.
28. Paynter, H., *Analysis and Design of Engineering Systems*, MIT Press, Cambridge, MA, 1961.
29. Roark, R.J. and Young, W.C., *Formulas for Stress and Strain*, McGraw-Hill, New York, 1975.
30. Roberson, R.E. and Schwertassek, *Dynamics of Multibody Systems*, Springer-Verlag, Berlin, 1988.
31. Rosenberg, R.M., *Analytical Dynamics of Discrete Systems*, Plenum Press, New York, 1977.
32. Rosenberg, R. and Karnopp, D., *Introduction to Physical System Dynamics*, McGraw-Hill, New York, 1983.
33. Rowell, D. and Wormley, D.N., *System Dynamics*, Prentice-Hall, Upper Saddle River, NJ, 1997.
34. Siciliano, B. and Villani, L., *Robot Force Control*, Kluwer Academic Publishers, Norwell, MA, 1999.
35. Tierneho, M.J.L. and Bos, A.M., "Modelling the dynamics and kinematics of mechanical systems with multibond graphs," *Journal of the Franklin Institute*, Vol. 319, No. 1–2, pp. 37–50, 1985.
36. Vance, J.M., *Rotordynamics of Turbomachinery*, John Wiley and Sons, New York, 1988.
37. Wehage, R.A., "Quaternions and Euler parameters—a brief exposition," in *Proceedings of the NATO Advanced Study Institute on Computer Aided Analysis and Optimization of Mechanical System Dynamics*, E.J. Haug (ed.), Iowa City, IA, August 1–12, 1983, pp. 147–182.
38. Wie, B. and Barba, P.M., "Quaternion feedback for spacecraft large angle maneuvers," *Journal of Guidance, Control, and Dynamics*, Vol. 8, pp. 360–365, May–June 1985.
39. Wittenburg, J., *Dynamics of Systems of Rigid Bodies*, B.G. Teubner, Stuttgart, 1977.

10

Fluid Power Systems

- 10.1 Introduction
Fluid Power Systems • Electrohydraulic Control Systems
- 10.2 Hydraulic Fluids
Density • Viscosity • Bulk Modulus
- 10.3 Hydraulic Control Valves
Principle of Valve Control • Hydraulic Control Valves
- 10.4 Hydraulic Pumps
Principles of Pump Operation • Pump Controls and Systems
- 10.5 Hydraulic Cylinders
Cylinder Parameters
- 10.6 Fluid Power Systems Control
System Steady-State Characteristics • System Dynamic Characteristics • E/H System Feedforward-Plus-PID Control • E/H System Generic Fuzzy Control
- 10.7 Programmable Electrohydraulic Valves

Qin Zhang

University of Illinois

Carroll E. Goering

University of Illinois

10.1 Introduction

Fluid Power Systems

A fluid power system uses either liquid or gas to perform desired tasks. Operation of both the liquid systems (hydraulic systems) and the gas systems (pneumatic systems) is based on the same principles. For brevity, we will focus on hydraulic systems only.

A fluid power system typically consists of a hydraulic pump, a line relief valve, a proportional direction control valve, and an actuator (Fig. 10.1). Fluid power systems are widely used on aerospace, industrial, and mobile equipment because of their remarkable advantages over other control systems. The major advantages include high power-to-weight ratio, capability of being stalled, reversed, or operated intermittently, capability of fast response and acceleration, and reliable operation and long service life.

Due to differing tasks and working environments, the characteristics of fluid power systems are different for industrial and mobile applications (Lambeck, 1983). In industrial applications, low noise level is a major concern. Normally, a noise level below 70 dB is desirable and over 80 dB is excessive. Industrial systems commonly operate in the low (below 7 MPa or 1000 psi) to moderate (below 21 MPa or 3000 psi) pressure range. In mobile applications, the size is the premier concern. Therefore, mobile hydraulic systems commonly operate between 14 and 35 MPa (2000–5000 psi). Also, their allowable temperature operating range is usually higher than in industrial applications.

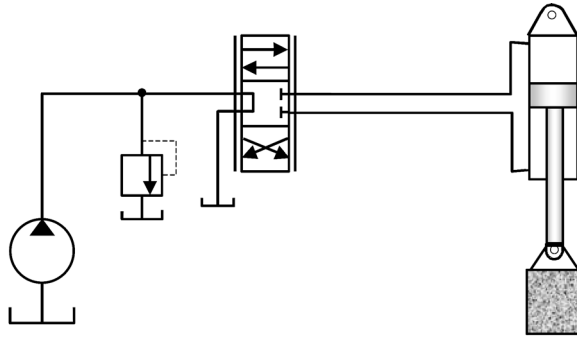

FIGURE 10.1 Schematic of a fluid power system.

Electrohydraulic Control Systems

The application of electronic controls to fluid power systems resulted in electrohydraulic control systems. Electrohydraulics has been widely used in aerospace, industrial, and mobile fluid power systems. Electrohydraulic controls have a few distinguishable advantages over other types of controls. First, an electrohydraulic system can be operated over a wide speed range, and its speed can be controlled continuously. More importantly, an electrohydraulic system can be stalled or operated under very large acceleration without causing its components to be damaged. A hydraulic actuator can be used in strong magnetic field without having the electromagnetic effects degrade control performance. In addition, hydraulic fluid flow can transfer heat away from system components and lubricate all moving parts continuously.

10.2 Hydraulic Fluids

Many types of fluids, e.g., mineral oils, biodegradable oils, and water-based fluids, are used in fluid power systems, depending on the task and the working environment. Ideally, hydraulic fluids should be inexpensive, noncorrosive, nontoxic, noninflammable, have good lubricity, and be stable in properties. The technically important properties of hydraulic fluids include density, viscosity, and bulk modulus.

Density

The density, ρ , of a fluid is defined as its mass per unit volume (Welty et al., 1984).

$$\rho = \frac{m}{V} \quad (10.1)$$

Density is approximately a linear function of pressure (P) and temperature (T) (Anderson, 1988).

$$\rho = \rho_0(1 + aP - bT) \quad (10.2)$$

In engineering practice, the manufacturers of the hydraulic fluids often provide the relative density (i.e., the specific gravity) instead of the actual density. The specific gravity of a fluid is the ratio of its actual density to the density of water at the same temperature.

Viscosity

The viscosity of a fluid is a measure of its resistance to deformation rate when subjected to a shearing force (Welty et al., 1984). Manufacturers often provide two kinds of viscosity values, namely the dynamic viscosity (μ) and the kinematic viscosity (ν). The dynamic viscosity is also named the absolute viscosity

and is defined by the Newtonian shear stress equation:

$$\mu = \frac{\tau}{\frac{dv}{dy}} \quad (10.3)$$

where dv is the relative velocity between two parallel layers dy apart, and τ is the shear stress.

The kinematic viscosity is the ratio of the dynamic viscosity to the density of the fluid and is defined using the following equation:

$$\nu = \frac{\mu}{\rho} \quad (10.4)$$

In the SI system, the unit of dynamic viscosity is Pascal-seconds (Pa s), and the unit of kinematic viscosity is square meter per second (m^2/s). Both the dynamic and kinematic vary strongly with temperature.

Bulk Modulus

Bulk modulus is a measure of the compressibility or the stiffness of a fluid. The basic definition of fluid bulk modulus is the fractional reduction in fluid volume corresponding to unit increase of applied pressure, expressed using the following equation (McCloy and Martin, 1973):

$$\beta = -V \left(\frac{\partial P}{\partial V} \right) \quad (10.5)$$

The bulk modulus can either be defined as the isothermal tangent bulk modulus if the compressibility is measured under a constant temperature or as the isentropic tangent bulk modulus if the compressibility is measured under constant entropy.

In analyzing the dynamic behavior of a hydraulic system, the stiffness of the hydraulic container plays a very important role. An effective bulk modulus, β_e , is often used to consider both the fluid's compressibility, β_f , and container stiffness, β_c , at the same time (Watton, 1989).

$$\frac{1}{\beta_e} = \frac{1}{\beta_f} + \frac{1}{\beta_c} \quad (10.6)$$

10.3 Hydraulic Control Valves

Principle of Valve Control

In a fluid power system, hydraulic control valves are used to control the pressure, flow rate, and flow direction. There are many ways to define a hydraulic valve so that a given valve can be named differently when it is used in different applications. Commonly, hydraulic valves can be classified based on their functions, such as pressure, flow, and directional control valves, or based on their control mechanisms, such as on-off, servo, and proportional electrohydraulic valves, or based on their structures, such as spool, poppet, and needle valves.

A hydraulic valve controls a fluid power system by opening and closing the flow-passing area of the valve. Such an adjustable flow-passing area is often described using an orifice area, A_o , in engineering practice. Physically, an orifice is a controllable hydraulic resistance, R_h . Under steady-state conditions, a hydraulic resistance can be defined as a ratio of pressure drop, Δp , across the valve to the flow rate, q , through the valve.

$$R_h = \frac{d(\Delta p)}{dq} \quad (10.7)$$

Control valves make use of many configurations of orifice to realize various hydraulic resistance characteristics for different applications. Therefore, it is essential to determine the relationship between the

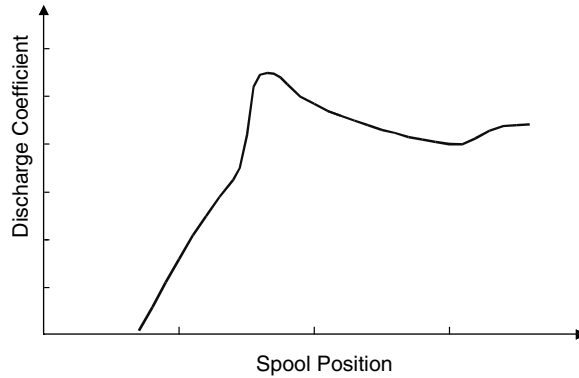

FIGURE 10.2 Discharge coefficient versus spool position in a spool valve.

pressure drop and the flow rate across the orifice. An orifice equation (McCloy and Martin, 1973) is often used to describe this relationship.

$$q = C_d A_o \sqrt{\frac{2}{\rho} \Delta P} \quad (10.8)$$

The pressure drop across the orifice is a system pressure loss in a fluid power system. In this equation, the orifice coefficient, C_d , plays an important role, and is normally determined experimentally. It has been found that the orifice coefficient varies greatly with the spool position, but does not appear to vary much with respect to the pressure drop across the orifice in a spool valve (Fig. 10.2, Viall and Zhang, 2000). Based on analytical results obtained from computational fluid dynamics simulations, the valve spool and sleeve geometries have little effect on the orifice coefficient for large spool displacements (Borghetti et al., 1998).

Hydraulic Control Valves

There are many ways to classify hydraulic control valves. For instance, based on their structural configurations, hydraulic control valves can be grouped as cartridge valves and spool valves. This section will provide mathematical models of hydraulic control valves based on their structural configurations.

A typical cartridge valve has either a poppet or a ball to control the passing flow rate. Representing the control characteristics of a cartridge valve without loss of generality, a poppet type cartridge is analyzed (Fig. 10.3).

The control characteristics of a poppet type cartridge valve can be described using an orifice equation and a force balance equation. As shown in Fig. 10.3, the valve opens by lifting the poppet. Because of the cone structure of the poppet, the flow-passing area can be determined using the following equation:

$$A_x = \pi dx \sin \alpha \quad (10.9)$$

Therefore, the passing flow can be calculated using the orifice equation. For a poppet type valve, it is recommended to use a relative higher orifice coefficient of $c_d = 0.77-0.82$ (Li et al., 2000).

$$q = c_d A_x \sqrt{\frac{2}{\rho} (P_B - P_A)} \quad (10.10)$$

The forces acting on the poppet include the pressure, spring, and hydraulic forces. The pressure force can be determined based on the upstream, downstream, and spring chamber pressures.

$$F_P = P_A \frac{\pi d^2}{4} + P_B \frac{\pi (D^2 - d^2)}{4} - P_C \frac{\pi D^2}{4} \quad (10.11)$$

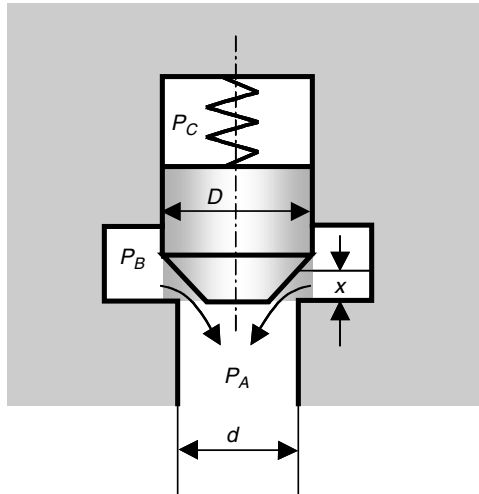

FIGURE 10.3 Operation principle of a puppet type cartridge valve.

The spring force biases the poppet towards closing. When the poppet is in the closed position, the spring force reaches its minimum value. The force increases as the poppet lifts to open the flow passage.

$$F_S = k(x_0 + x) \quad (10.12)$$

The steady-state flow force tends to open the poppet in this valve. The flow force is a function of the flow rate and fluid velocity passing through the valve orifice.

$$F_F = \rho q v \cos \alpha \quad (10.13)$$

The flow control characteristics of a spool valve are similar to those of a cartridge valve and can be described using an orifice equation. The only difference is that spool valve flow-passing area is determined by its wet perimeter, w , and spool displacement, x .

$$q = c_d w x \sqrt{\frac{2}{\rho} \Delta P} \quad (10.14)$$

If the orifice is formed by the edge of the spool and the valve body, the wet perimeter is $w = \pi d$. If the orifice is formed by n slots cut on the spool and the perimeter of each slot is n , the corresponding wet perimeter is $w = nb$. The orifice coefficient for a spool valve normally uses $c_d = 0.60-0.65$.

The forces acting on the spool also include the pressure, spring, and flow forces (Merritt, 1967). The pressure force is either balanced on the spool, because of its symmetric structure in a direct-actuator valve (actuated by a solenoid directly), or the pressure force to actuate the spool movement in a pilot actuated valve. The spring force tends to keep the spool in the central (neutral) position and can be described using Eq. (10.12). The flow forces acting on the spool can be calculated using Eq. (10.14). The flow velocity angle, α , is normally taken as 69° .

10.4 Hydraulic Pumps

Principles of Pump Operation

The pump is one of the most important components in a hydraulic system because it supplies hydraulic flow to the system. Driven by a prime mover, a hydraulic pump takes the fluid in at atmospheric pressure to fill an expanding volume of space inside the pump through an inlet port and delivers pressurized

fluids to the outlet due to the reduction in internal volume near the output port. The pump capacity is determined by pump displacement (D) and operating speed (n). The displacement of a pump is defined as the theoretical volume of fluid that can be delivered in one complete revolution of the pump shaft.

$$Q = Dn \quad (10.15)$$

The pump output pressure is determined by the system load, which is the combined resistance to fluid flow in the pipeline and the resistance to move an external load. Unless the pump flow has egress either by moving a load or by passing through a relief valve back to the reservoir, excessive pressure build-up can cause serious damage to the pump and/or the connecting pipeline (Reed and Larman, 1985).

Based on their ability to change displacement, hydraulic pumps can be categorized as fixed-flow or variable-flow pumps. Based on their design, hydraulic pumps can be categorized as gear pumps, vane pumps, and piston pumps. Normally, gear pumps are fixed-flow pumps, and vane pumps and piston pumps can be either fixed-flow pumps or variable-flow pumps.

The choice of pump design varies from industry to industry. For example, the machine tool manufacturers often select vane pumps because of their low noise, and their capability to deliver a variable flow at a constant pressure. Mobile equipment manufacturers like to use piston pumps due to their high power-to-weight ratio. Some agricultural equipment manufacturers prefer gear pumps for their low cost and robustness (Reed and Larman, 1985), but piston pumps are also popular.

Pump Controls and Systems

Pumps are energy conversion devices that convert mechanical energy into fluid potential energy to drive various hydraulic actuators to do work. To meet the requirements of different applications, there are many types of fluid power system controls from which to choose. The design of the directional control valve must be compatible with the pump design. Normally, an open-center directional control valve is used with a fixed displacement pump and a closed-center directional control valve is used in a circuit equipped with a variable displacement pump.

A fluid power system including a fixed displacement pump and an open-center directional control valve (Fig. 10.1) is an open-loop open-center system. Such a system is also called a load-sensitive system because the pump delivers only the pressure required to move the load, plus the pressure drop to overcome line losses. The open-loop open-center system is suitable for simple “on-off” controls. In such operations, the hydraulic actuator either moves the load at the maximum velocity or remains stationary with the pump unloaded. If a proportional valve is used, the open-loop open-center system can also achieve velocity control of the actuator. However, such control will increase the pressure of the extra flow for releasing it back to the tank. Such control causes significant power loss and results in low system efficiency and heat generation.

To solve this problem, an open-loop closed-center circuit is constructed using a variable displacement pump and a closed-center directional control valve. Because a variable displacement pump is commonly equipped with a pressure-limiting control or “pressure compensator,” the pump displacement will be automatically increased or decreased as the system pressure decreases or increases. If the metering position of the directional control valve is used to control the actuator velocity, constant velocity can be achieved if the load is constant. However, if the load is changing, the “pressure-compensating” system will not be able to keep a constant velocity without adjusting the metering position of the control valve. To solve this problem, a “load-sensing” pump should be selected for keeping a constant velocity under changing load. The reason for a “load-sensing” pump being able to maintain a constant velocity for any valve-metering position is that it maintains a constant pressure drop across the metering orifice of the directional control valve, and automatically adjusts the pump outlet pressure to compensate for the changes in pressure caused by external load. The constant pressure drop across the valve maintains constant flow, and therefore, constant load velocity.

10.5 Hydraulic Cylinders

A hydraulic cylinder transfers the potential energy of the pressurized fluid into mechanical energy to drive the operating device performing linear motions and is the most common actuator used in hydraulic systems. A hydraulic cylinder consists of a cylinder body, a piston, a rod, and seals. Based on their structure, hydraulic cylinders can be classified as single acting (applying force in one direction only), double acting (exerts force in either direction), single rod (does not have a rod at the cap side), and double rod (has a rod at both sides of the piston) cylinders.

Cylinder Parameters

A hydraulic cylinder transfers energy by converting the flow rate and pressure into the force and velocity. The velocity and the force from a double-acting double-rod cylinder can be determined using the following equations:

$$v = \frac{4q}{\pi(D^2 - d^2)} \quad (10.16)$$

$$F = \frac{\pi}{4}(D^2 - d^2)(P_1 - P_2) \quad (10.17)$$

The velocity and the force from a double-acting single-rod cylinder should be determined differently for extending and retracting motions. In retraction, the velocity can be determined using Eq. (10.16), and the force can be determined using the following equation:

$$F = P_1 \frac{\pi(D^2 - d^2)}{4} - P_2 \frac{\pi D^2}{4} \quad (10.18)$$

In extension, the velocity and exerting forces can be determined using the following equations:

$$v = \frac{4q}{\pi D^2} \quad (10.19)$$

$$F = (P_1 - P_2) \frac{\pi D^2}{4} + P_2 \frac{\pi d^2}{4} \quad (10.20)$$

The hydraulic stiffness, k_h , of the cylinder plays an important role in the dynamic performance of a hydraulic system. It is a function of fluid bulk modulus (β), piston areas (A_1 , A_2), cylinder chamber volumes (V_1 , V_2), and the volume of hydraulic hoses connected to both chambers (V_{L1} , V_{L2}). For a double-acting single-rod cylinder, the stiffness on both sides of the piston acts in parallel (Skinner and Long, 1998). The total stiffness of the cylinder is given by the following equation:

$$k_h = \beta \left(\frac{A_1^2}{V_{L1} + V_1} + \frac{A_1^2}{V_{L2} + V_2} \right) \quad (10.21)$$

The natural frequency, ω_n , of a hydraulic system is determined by the combined mass, m , of the cylinder and the load using the following equation:

$$\omega_n = \sqrt{\frac{k_h}{m}} \quad (10.22)$$

10.6 Fluid Power Systems Control

System Steady-State Characteristics

The steady-state characteristics of a fluid power system determine loading performance, speed control capability, and the efficiency of the system. Modeling a hydraulic system without loss of generality, a system consisting of an open-center four-way directional control valve and a single-rod double acting cylinder is used to analyze the steady-state characteristics of the system (Fig. 10.1). In this system, the orifice area of the cylinder-to-tank (C-T) port in the control valve is always larger than that of the pump-to-cylinder (P-C) port. Therefore, it is reasonable to assume that the P-C orifice controls the cylinder speed during extension (Zhang, 2000).

Based on Newton's Law, the force balance on the piston is determined by the head-end chamber pressure, P_1 , the head-end piston area, A_1 , the rod-end chamber pressure, P_2 , the rod-end piston area, A_2 , and the external load, F , when the friction and leakage are neglected.

$$P_1 A_1 - P_2 A_2 = F \quad (10.23)$$

If neglecting the line losses from actuator to reservoir, the rod-end pressure equals zero. Then, the head-end pressure is determined by the external load to the system.

$$P_1 = \frac{F}{A_1} \quad (10.24)$$

In order to push the fluid passing the control valve and entering the head-end of the cylinder, the discharge pressure, P_p , of the hydraulic pump has to be higher than the cylinder chamber pressure. The difference between the pump discharge pressure and the cylinder chamber pressure is determined by the hydraulic resistance across the control valve. Based on the orifice equation, the flow rate entering the cylinder head-end chamber is

$$q = C_d A_o \sqrt{\frac{2}{\rho} (P_p - P_1)} \quad (10.25)$$

Using a control coefficient, K , to represent C_d and ρ , the cylinder speed can be described using the following equation:

$$v = \frac{K A_o}{A_1} \sqrt{P_p - \frac{F}{A_1}} \quad (10.26)$$

Equation (10.13) describes the speed-load relationship of a hydraulic cylinder under a certain fluid passing area (orifice area) of the control valve. Depicted in Fig. 10.4, the cylinder speed decreases as the external load applied to the cylinder increases. When there is no external load, the cylinder speed reaches a maximum. Conversely, when the external load reaches the value of $F = P_p A_1$, then the cylinder will stall. The stall load is independent of the size of the fluid passing area in the valve. Such characteristics of a fluid power system eliminate the potential of overloading, which makes it a safer power transmission method.

In system analysis, the speed stiffness, k_v , is often used to describe the consistency of the cylinder speed under changing system load (Li et al., 2000).

$$k_v = -\frac{1}{\frac{\partial v}{\partial F}} = \frac{2(P_p A_1 - F)}{v} \quad (10.27)$$

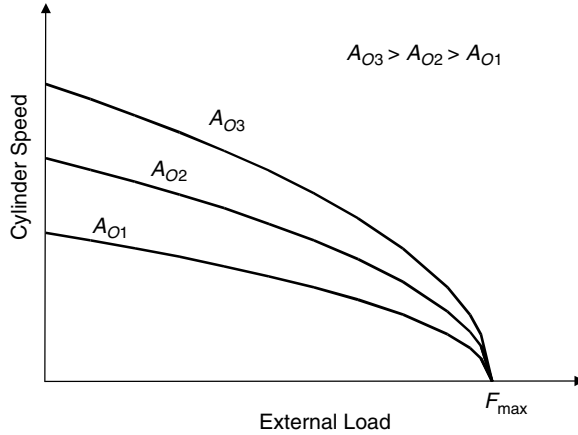

FIGURE 10.4 Hydraulic cylinder load-speed relationship under the same system pressure.

Equation (10.27) indicates that the increase in speed stiffness can be achieved either by increasing the system pressure or the cylinder size, or by decreasing the speed.

System Dynamic Characteristics

To analyze the dynamic characteristics of this hydraulic cylinder actuation system, one can use flow continuity and system momentum equations to model the cylinder motion. Neglecting system leakage, friction, and line loss, the following are the governing equations for the hydraulic system:

$$q = kx\sqrt{P_p - P_1} = A_1 \frac{dy}{dt} + \frac{V_1}{\beta} \frac{dP_1}{dt} \quad (10.28)$$

$$P_1 A_1 = m \frac{d^2 y}{dt^2} + F \quad (10.29)$$

To perform dynamic analysis on this hydraulic system, it is essential to derive its transfer function based on the above nonlinear equation, which can be obtained by taking the Laplace transform on the linearized form of the above equations (Watton, 1989).

$$\delta v(s) = \frac{\frac{k_1 K_i}{A_1} \delta i(s) - \left(\frac{V_1}{A_1^2 \beta} s + \frac{1}{A_1^2 k_3 R_o} \right) \delta F(s)}{\frac{V_1}{A_1^2 \beta} m s^2 + \frac{1}{A_1^2 k_2 R_o} m s + 1} \quad (10.30)$$

Making

$$\omega_n = \sqrt{\frac{A_1^2 \beta}{V_1 m}}, \quad \zeta = \frac{1}{2 k_2 R_o} \sqrt{\frac{m \beta}{V_1 A_1^2}}, \quad \text{and} \quad K_s = \frac{k_1 K_i}{A_1}$$

Equation (10.30) can be represented as

$$\delta v(s) = \frac{K_s \delta i(s)}{\frac{1}{\omega_n^2} s^2 + \frac{2\zeta}{\omega_n} s + 1} - \frac{\frac{1}{A_1^2} \left(\frac{V_1}{\beta} s + \frac{1}{k_3 R_o} \right) \delta F(s)}{\frac{1}{\omega_n^2} s^2 + \frac{2\zeta}{\omega_n} s + 1} \quad (10.31)$$

Based on the stability criterion for a second-order system, it should satisfy

$$\frac{1}{W_n^2}s^2 + \frac{2Z}{W_n}s + 1 = 0 \quad (10.32)$$

The speed control coefficient, K_s , is the gain between the control signal current and the cylinder speed. A higher gain can increase the system sensitivity in speed control.

E/H System Feedforward-Plus-PID Control

Equation (10.31) indicates that the speed control of a hydraulic cylinder is a third-order system. Its dynamic behaviors are affected by spool valve characteristics, system pressure, and cylinder size. Therefore, it is a challenging job to realize accurate and smooth speed control on a hydraulic cylinder. A feedforward plus proportional integral derivative (FPID) controller has proven capable of achieving high-speed control performance of a hydraulic cylinder (Zhang, 1999).

An FPID controller consists of a feedforward loop and a PID loop (Fig. 10.5). The feedforward loop is designed to compensate for the nonlinearity of the hydraulic system, including the deadband of the system and the nonlinear flow gain of the control valve. It uses a feedforward gain to determine the basic control input based on demand speed. This feedforward gain is scheduled based on the inverse valve transform, which provides the steady-state control characteristics of the E/H valve in terms of cylinder speed and control-current to valve PWM driver.

The PID loop complements the feedforward control via the speed tracking error compensation. The PID controller is developed based on the transfer function of the linearized system for the hydraulic cylinder speed control system.

$$G(s) = \hat{E}K_p + \frac{K_I}{s} + K_D\hat{s} \quad (10.33)$$

The robustness of the FPID control was evaluated based on its performance and stability. Performance robustness deals with unexpected external disturbances and stability robustness deals with internal structural or parametric changes in the system. The design of this FPID controller was based on a worst-case scenario of system operating conditions in tuning both the PID gains and the feedforward gain.

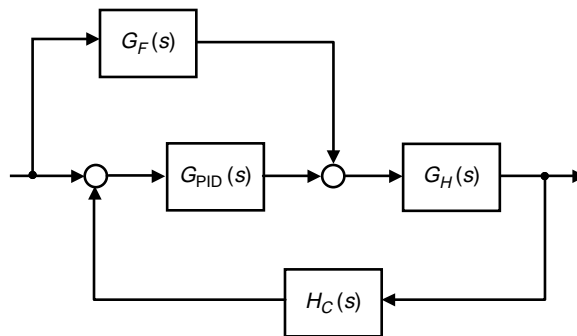

FIGURE 10.5 Schematic block diagram of the feedforward-plus-PID controller. $G_F(s)$ is the feedforward gain, $G_{PID}(s)$ is the overall gain of the feedback PID controller, $G_H(s)$ is hydraulic system gain, and $H_C(s)$ is the sensor gain.

E/H System Generic Fuzzy Control

Fuzzy control is an advanced control technology that can mimic a human's operating strategy in controlling complex systems and can handle systems with uncertainty and nonlinearity (Pedrycz, 1993). One common feature of fuzzy controllers is that most such controllers are designed based on natural language control laws. This feature makes it possible to design a generic controller for different plants if the control of those plants can be described using the same natural language control laws (Zhang, 2001).

The speed control on a hydraulic cylinder actually is achieved by regulating the supplied flow rate to the cylinder. In different hydraulic systems, the size of the cylinder and the capability of hydraulic system are usually different, but the control principles are very similar. Representing cylinder speed control operation, using natural language without loss of generality, the control laws are the same for all systems:

- To have a fast motion, open the valve fully.
- To make a slow motion, keep the valve open a_little.
- To hold the cylinder at its current position, return the valve to the center.
- To make a reverse motion, operate the valve to the other direction.

This natural language model represents the general roles in controlling the cylinder speed via an E/H control valve on all hydraulic systems. The differences in system parameters on different systems can be handled by redefining the domain of the fuzzy variable, such as fully, a_lot, and a_little, using fuzzy membership functions (Passino and Yurkovich, 1998). This model provides the basis for designing a generic fuzzy controller for E/H systems. The adoption of the generic controller on different systems can be as easy as redefining the fuzzy membership function based on its system parameters.

Figure 10.6 shows the block diagram of a generic fuzzy controller consisting of two input variable fuzzifiers, a control rule base, and a control command defuzzifier. The two input fuzzifiers were designed to convert real-valued input variables into linguistic variables with appropriate fuzzy memberships. Each fuzzifier consists of a set of fuzzy membership functions defining the domain for each linguistic input variable. A real-valued input variable is normally converted into two linguistic values with associated memberships. The definitions of these fuzzy values play a critical role in the design of generic fuzzy controllers and are commonly defined based upon hydraulic system parameters. The fuzzy controller uses fuzzy control rules to determine control actions according to typical behaviors in the speed control of hydraulic cylinders. The control outputs are also linguistic values and associated with fuzzy memberships. For example, if the demanding speed is negative_small (NS) and the error in speed was positive_small (PS), the appropriate valve control action will be positive_small (PS).

The appropriate control actions were determined based on predefined control rules. Since each real-valued variable commonly maps into two fuzzy values, the fuzzy inference engine fires at least two control rules containing these fuzzy values to determine the appropriate control action. Therefore, at least two appropriate fuzzy-valued control actions will be selected. However, the E/H controller can only implement one specific real-value control command at a given time. It is necessary to convert multiple fuzzy-valued control commands into one real-valued control signal in this fuzzy controller.

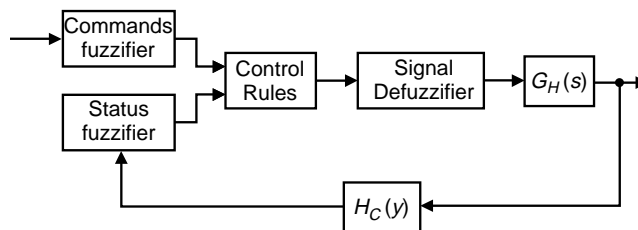

FIGURE 10.6 Block diagram of fuzzy E/H control system. The fuzzy controller consists of input variable fuzzifiers, control rules, and a signal defuzzifier.

The defuzzification process converts two or more fuzzy-valued outputs to one real-valued output. There are many defuzzification methods, such as center of gravity (COG) and center of area (COA), available for different applications (Passino and Yurkovich, 1998). By COA approach, the real-valued control signal, u , was determined by the domain and the memberships of the selected fuzzy control commands, $\mu(u_i)$, using the following equation:

$$u = \frac{\sum_{i=1}^n u_i \mu(u_i) du}{\sum_{i=1}^n \mu(u_i) du} \quad (10.34)$$

The COA method naturally averages the domains of selected fuzzy control commands, and thus reduces the sensitivity of the system to noise. The use of a COA approach increased the robustness and accuracy of the control.

The performance of the fuzzy controller depends on the appropriation of domain definition for both input and output fuzzy variables. Properly defined fuzzy variables for a specific E/H system will improve the stability, accuracy, and nonlinearity compensation of the fuzzy controller. Normally, a triangular fuzzy membership function, μ_{FV} , was defined by domain values of a_i , a_j , and a_k , for each fuzzy value (FV) in the fuzzy controller.

$$\mu_A = \begin{bmatrix} \mu_{NL} \\ \mu_{NM} \\ \mu_{NS} \\ \mu_{ZE} \\ \mu_{PS} \\ \mu_{PM} \\ \mu_{PL} \end{bmatrix} = \begin{bmatrix} a_1 & a_1 & a_2 \\ a_1 & a_2 & a_3 \\ a_2 & a_3 & a_4 \\ a_3 & a_4 & a_5 \\ a_4 & a_5 & a_6 \\ a_5 & a_6 & a_7 \\ a_6 & a_7 & a_7 \end{bmatrix} \quad (10.35)$$

where μ_A is a set of fuzzy membership functions for each fuzzy input or output variable; a_i , a_k are the boundaries; and a_j is the full membership point of the fuzzy value.

Equation (10.35) uses a set of seven domain values to define seven fuzzy values in the real-valued operating range. The tuning of the fuzzy controller was to determine the domain values for each of the fuzzy values. The following vector presents the domains of fuzzy membership functions for a particular variable:

$$A = \{a_1 \ a_2 \ a_3 \ a_4 \ a_5 \ a_6 \ a_7\} \quad (10.36)$$

10.7 Programmable Electrohydraulic Valves

Proportional directional control valves are by far the most common means for motion control of hydraulic motors or cylinders in fluid power systems (McCloy, 1973). Normally, a proportional direction control valve uses a sliding spool to control the direction and the amount of fluid passing through the valve. For different applications, the spool in a proportional direction control valve is often specially designed to provide the desired control characteristics. As a result, valves are specific and cannot be interchangeable even if they are exactly of the same size. The multiplicity of such specific valves make them inconvenient and costly to manufacture, distribute, and service. To provide a solution to these problems, researchers at the University of Illinois at Urbana-Champaign (Book and Goering, 1999; Hu et al., 2001) developed a generic programmable electrohydraulic (E/H) control valve. A generic programmable valve is a set of individually

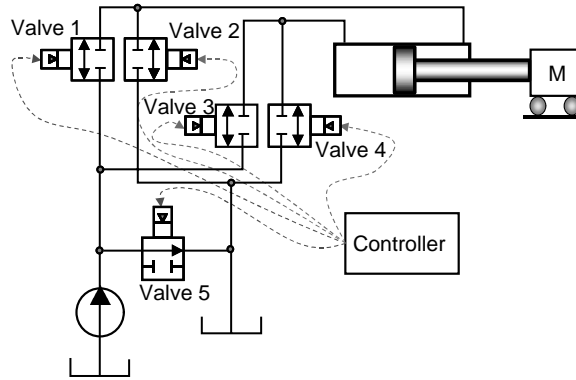

FIGURE 10.7 System schematic of a hydraulic system using generic programmable E/H valves.

controlled E/H valves capable of fulfilling flow and pressure control requirements. One set of such generic valves can replace a proportional direction control valve and other auxiliary valves, such as line release valves, in a circuit.

A generic programmable E/H valve is normally constructed using five bi-directional, proportional flow control sub-valves, three pressure sensors, and an electronic controller. Figure 10.7 shows the schematic of the generic valve circuit. Sub-valves 1 and 2 connect the pump and the head-end or the rod-end chambers of the cylinder and provide equilibrium ports of P-to-A and P-to-B as in a conventional direction control valve, while sub-valves 3 and 4 connect cylinder chambers A or B to the tank and provide equilibrium ports of A-to-T and B-to-T of a direction control valve. Sub-valve 5 connects the pump and the tank directly and provides a dual-function of line release and an equilibrium port of P-to-T of a direction control valve. By controlling the opening and closing of these sub-valves, the basic functions of the generic valve can be realized. In operation, the controller output control signals for each sub-valve are based on a predefined control logic.

With proper logic in the on-off control of all five sub-valves, the generic programmable valve was capable of realizing several basic functions, including open-center, closed-center, float-center, make-up, and pressure release functions. By applying modulation control, the generic valve can realize proportional functions such as meter-in/meter-out, load sensing, regeneration, and anti-cavitation. For example, in a conventional tandem-center or closed-center direction control valve, the ports A and B are normally closed for holding the pressure in cylinder chambers, while the ports P and T are either normally open or closed. To fulfill this function, the generic valve keeps sub-valves 1–4 closed to hold the cylinder chamber pressure, and fully opens sub-valve 5 to bleed the flow back to the tank, either at low pressure (tandem-center function) or when the system pressure exceeds a preset level (closed-center function). In conventional open-center direction control valves, all ports are normally connected. To fulfill this function, the generic valve keeps all sub-valves open. Similarly, to provide float-center function, the generic valve needs to open sub-valves 3 and 4 to release pressure in both the head-end and the rod-end chambers of the cylinder. In both cases, sub-valve 5 will be opened only when the system pressure exceeds a preset level.

It is almost impossible to achieve the regeneration function from a conventional direction control valve. In achieving this function, a generic valve needs to open sub-valves 1 and 2 to lead the returning flow of the rod-end chamber back to the head-end chamber to provide additional flow for increasing the extending speed. Make-up function in a conventional hydraulic system is provided by a separate make-up valve for supplying fluid directly from the tank in case of cavitation. The generic valve can also provide this function by actuating the corresponding cylinder-to-tank sub-valves open when the system pressure is below a certain level.

References

1. Anderson, W.R., *Controlling Electrohydraulic Systems*, Marcel Dekker, New York, NY, 1988.
2. Book, R. and Goering, C.E., Programmable electrohydraulic valve, *SAE 1999 Transactions, Journal of Commercial Vehicles* (1997), Section 2, 108:346–352.
3. Borghi, M.G., Cantore, G., Milani, M., and Paoluzzi, R., Analysis of hydraulic components using computational fluid dynamics models, *Proceedings of the Institution of Mechanical Engineers, Journal C* (1998), 212:619–629.
4. Lambeck, R.P., *Hydraulic Pumps and Motors: Selection and Application for Hydraulic Power Control Systems*, Marcel Dekker, New York, NY, 1983.
5. Li, Z., Ge, Y., and Chen, Y., *Hydraulic Components and Systems* (in Chinese), Mechanical Industry Publishing, Beijing, China, 2000.
6. Hu, H., Zhang, Q., and Alleyne, A., Multi-function realization of a generic programmable E/H valve using flexible control logic, *Proceedings of the Fifth International Conference on Fluid Power Transmission and Control* (2001), International Academic Publishers, Beijing, China, pp. 107–110.
7. Merritt, H.E., *Hydraulic Control Systems*, John Wiley & Sons, New York, NY, 1967.
8. McCloy, D. and Martin, H.R., *The Control of Fluid Power*, John Wiley & Sons, New York, NY, 1973.
9. Passino, K.M. and Yurkovich, S., *Fuzzy Control*, Addison-Wesley, Menlo Park, CA, 1998.
10. Pedrycz, W., *Fuzzy Control and Fuzzy Systems*, 2nd edition, Wiley, New York, NY, 1993.
11. Reed, E.W. and Larman, I.S., *Fluid Power with Microprocessor Control: An Introduction*, Prentice-Hall, New York, NY, 1985.
12. Skinner, S.C. and Long, R.J., *Closed Loop Electrohydraulic Systems Manual*, 2nd edition, Vickers, Rochester Hills, MI, 1998.
13. Viall, E.N. and Zhang, Q., Determining the discharge coefficient of a spool valve, *Proceedings of the American Control Conference* (2000), Chicago, IL, pp. 3600–3604.
14. Watton, J., *Fluid Power Systems, Modeling, Simulation, Analog and Microcomputer Control*, Prentice-Hall, New York, NY, 1989.
15. Welty, J.R., Wicks, C.E., and Wilson, R.E., *Fundamentals of Momentum, Heat, and Mass Transfer*, 3rd edition, John Wiley & Sons, New York, NY, 1984.
16. Zhang, Q., Hydraulic linear actuator velocity control using a feedforward-plus-PID control, *International Journal of Flexible Automation and Integrated Manufacturing* (1999), 7:275–290.
17. Zhang, Q., Design of a generic fuzzy controller for electrohydraulic steering, *Proceedings of the American Control Conference* (2001), (in press).

11

Electrical Engineering

- 11.1 Introduction
- 11.2 Fundamentals of Electric Circuits
Electric Power and Sign Convention • Circuit Elements and Their i - v Characteristics • Resistance and Ohm's Law • Practical Voltage and Current Sources • Measuring Devices
- 11.3 Resistive Network Analysis
The Node Voltage Method • The Mesh Current Method • One-Port Networks and Equivalent Circuits • Nonlinear Circuit Elements
- 11.4 AC Network Analysis
Energy-Storage (Dynamic) Circuit Elements • Time-Dependent Signal Sources • Solution of Circuits Containing Dynamic Elements • Phasors and Impedance

Giorgio Rizzoni
Ohio State University

11.1 Introduction

The role played by electrical and electronic engineering in mechanical systems has dramatically increased in importance in the past two decades, thanks to advances in integrated circuit electronics and in materials that have permitted the integration of sensing, computing, and actuation technology into industrial systems and consumer products. Examples of this integration revolution, which has been referred to as a new field called *Mechatronics*, can be found in consumer electronics (auto-focus cameras, printers, microprocessor-controlled appliances), in industrial automation, and in transportation systems, most notably in passenger vehicles. The aim of this chapter is to review and summarize the foundations of electrical engineering for the purpose of providing the practicing mechanical engineer a quick and useful reference to the different fields of electrical engineering. Special emphasis has been placed on those topics that are likely to be relevant to product design.

11.2 Fundamentals of Electric Circuits

This section presents the fundamental laws of circuit analysis and serves as the foundation for the study of electrical circuits. The fundamental concepts developed in these first pages will be called on through the chapter.

The fundamental electric quantity is **charge**, and the smallest amount of charge that exists is the charge carried by an electron, equal to

$$q_e = -1.602 \times 10^{-19} \text{ coulomb} \quad (11.1)$$

As you can see, the amount of charge associated with an electron is rather small. This, of course, has to do with the size of the unit we use to measure charge, the **coulomb** (C), named after Charles Coulomb. However, the definition of the coulomb leads to an appropriate unit when we define electric current,

since current consists of the flow of very large numbers of charge particles. The other charge-carrying particle in an atom, the proton, is assigned a positive sign and the same magnitude. The charge of a proton is

$$q_p = +1.602 \times 10^{-19} \text{ coulomb} \tag{11.2}$$

Electrons and protons are often referred to as **elementary charges**.

Electric current is defined as the time rate of change of charge passing through a predetermined area. If we consider the effect of the enormous number of elementary charges actually flowing, we can write this relationship in differential form:

$$i = \frac{dq}{dt} \text{ (C/sec)} \tag{11.3}$$

The units of current are called **amperes** (A), where 1 A = 1 C/sec. The electrical engineering convention states that the positive direction of current flow is that of positive charges. In metallic conductors, however, current is carried by negative charges; these charges are the free electrons in the conduction band, which are only weakly attracted to the atomic structure in metallic elements and are therefore easily displaced in the presence of electric fields.

In order for current to flow there must exist a closed circuit. [Figure 11.1](#) depicts a simple circuit, composed of a battery (e.g., a dry-cell or alkaline 1.5-V battery) and a light bulb.

Note that in the circuit of [Fig. 11.1](#), the current, i , flowing from the battery to the resistor is equal to the current flowing from the light bulb to the battery. In other words, no current (and therefore no charge) is “lost” around the closed circuit. This principle was observed by the German scientist G.R. Kirchhoff and is now known as **Kirchhoff’s current law** (KCL). KCL states that because charge cannot be created but must be conserved, *the sum of the currents at a node must equal zero* (in an electrical circuit, a **node** is the junction of two or more conductors). Formally:

$$\sum_{n=1}^{in} i_n = 0 \text{ Kirchhoff’s current law} \tag{11.4}$$

The significance of KCL is illustrated in [Fig. 11.2](#), where the simple circuit of [Fig. 11.1](#) has been augmented by the addition of two light bulbs (note how the two nodes that exist in this circuit have been emphasized by the shaded areas). In applying KCL, one usually defines currents entering a node as being negative and currents exiting the node as being positive. Thus, the resulting expression for the circuit of [Fig. 11.2](#) is

$$i + i_1 + i_2 + i_3 = 0$$

Charge moving in an electric circuit gives rise to a current, as stated in the preceding section. Naturally, it must take some work, or energy, for the charge to move between two points in a circuit, say, from point a to point b . The total *work per unit charge* associated with the motion of charge between two

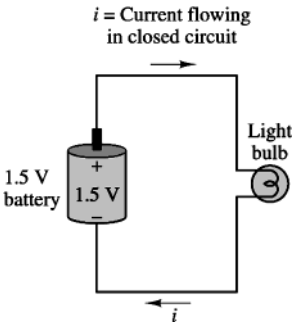

FIGURE 11.1 A simple electrical circuit.

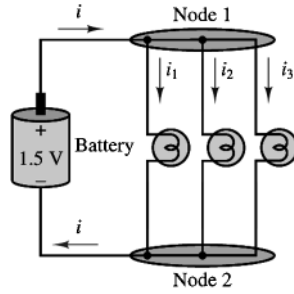

Illustration of KCL at node 1: $-i + i_1 + i_2 + i_3 = 0$

FIGURE 11.2 Illustration of Kirchhoff's current law.

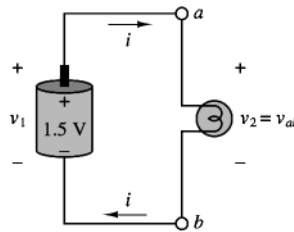

Illustration of Kirchhoff's voltage law: $v_1 - v_2 = 0$

FIGURE 11.3 Voltages around a circuit.

points is called **voltage**. Thus, the units of voltage are those of energy per unit charge:

$$1 \text{ volt} = \frac{1 \text{ joule}}{\text{coulomb}} \quad (11.5)$$

The voltage, or **potential difference**, between two points in a circuit indicates the energy required to move charge from one point to the other. As will be presently shown, the direction, or polarity, of the voltage is closely tied to whether energy is being dissipated or generated in the process. The seemingly abstract concept of work being done in moving charges can be directly applied to the analysis of electrical circuits; consider again the simple circuit consisting of a battery and a light bulb. The circuit is drawn again for convenience in Fig. 11.3, and nodes are defined by the letters *a* and *b*. A series of carefully conducted experimental observations regarding the nature of voltages in an electric circuit led Kirchhoff to the formulation of the second of his laws, **Kirchhoff's voltage law**, or KVL. The principle underlying KVL is that no energy is lost or created in an electric circuit; in circuit terms, the sum of all voltages associated with sources must equal the sum of the load voltages, so that *the net voltage around a closed circuit is zero*. If this were not the case, we would need to find a physical explanation for the excess (or missing) energy not accounted for in the voltages around a circuit. KVL may be stated in a form similar to that used for KCL:

$$\sum_{n=1}^N v_n = 0 \quad \text{Kirchhoff's voltage law} \quad (11.6)$$

where the v_n are the individual voltages around the closed circuit. Making reference to Fig. 11.3, we can see that it must follow from KVL that the work generated by the battery is equal to the energy dissipated in the light bulb to sustain the current flow and to convert the electric energy to heat and light:

$$v_{ab} = -v_{ba}$$

or

$$v_1 = v_2$$

A symbolic representation of the battery–light bulb circuit of Figure 2.5.

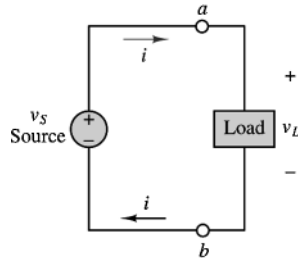

FIGURE 11.4 Sources and loads in an electrical circuit.

One may think of the work done in moving a charge from point a to point b and the work done moving it back from b to a as corresponding directly to the *voltages across individual circuit elements*. Let Q be the total charge that moves around the circuit per unit time, giving rise to the current i . Then the work done in moving Q from b to a (i.e., across the battery) is

$$W_{ba} = Q \times 1.5 \text{ V} \quad (11.7)$$

Similarly, work is done in moving Q from a to b , that is, across the light bulb. Note that the word *potential* is quite appropriate as a synonym of voltage, in that voltage represents the potential energy between two points in a circuit: if we remove the light bulb from its connections to the battery, there still exists a voltage across the (now disconnected) terminals b and a .

A moment's reflection upon the significance of voltage should suggest that it must be necessary to specify a sign for this quantity. Consider, again, the same dry-cell or alkaline battery, where, by virtue of an electrochemically induced separation of charge, a 1.5-V potential difference is generated. The potential generated by the battery may be used to move charge in a circuit. The rate at which charge is moved once a closed circuit is established (i.e., the current drawn by the circuit connected to the battery) depends now on the circuit element we choose to connect to the battery. Thus, while the voltage across the battery represents the potential for *providing energy* to a circuit, the voltage across the light bulb indicates the amount of work done in *dissipating energy*. In the first case, energy is generated; in the second, it is consumed (note that energy may also be stored, by suitable circuit elements yet to be introduced). This fundamental distinction required attention in defining the sign (or polarity) of voltages.

We shall, in general, refer to elements that provide energy as **sources**, and to elements that dissipate energy as **loads**. Standard symbols for a generalized source-and-load circuit are shown in Fig. 11.4. Formal definitions will be given in a later section.

Electric Power and Sign Convention

The definition of voltage as work per unit charge lends itself very conveniently to the introduction of power. Recall that power is defined as the work done per unit time. Thus, the power, P , either generated or dissipated by a circuit element can be represented by the following relationship:

$$\text{Power} = \frac{\text{work}}{\text{time}} = \frac{\text{work}}{\text{unit charge}} \frac{\text{charge}}{\text{time}} = \text{voltage} \times \text{current} \quad (11.8)$$

Thus, the electrical power generated by an active element, or that dissipated or stored by a passive element, is equal to the product of the voltage across the element and the current flowing through it.

$$P = VI \quad (11.9)$$

It is easy to verify that the units of voltage (joules/coulomb) times current (coulombs/second) are indeed those of power (joules/second, or watts).

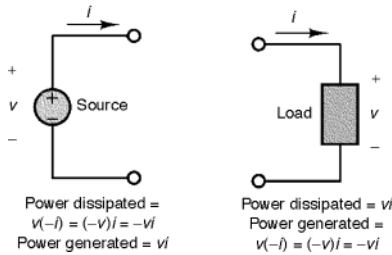

FIGURE 11.5 The passive sign convention.

It is important to realize that, just like voltage, power is a signed quantity, and that it is necessary to make a distinction between *positive* and *negative power*. This distinction can be understood with reference to Fig. 11.5, in which a source and a load are shown side by side. The polarity of the voltage across the source and the direction of the current through it indicate that the voltage source *is doing work in moving charge from a lower potential to a higher potential*. On the other hand, the load is dissipating energy, because the direction of the current indicates that *charge is being displaced from a higher potential to a lower potential*. To avoid confusion with regard to the sign of power, the electrical engineering community uniformly adopts the **passive sign convention**, which simply states that *the power dissipated by a load is a positive quantity* (or, conversely, that the power generated by a source is a positive quantity). Another way of phrasing the same concept is to state that if current flows from a higher to a lower voltage (+ to -), the power dissipated will be a positive quantity.

Circuit Elements and Their i - v Characteristics

The relationship between current and voltage at the terminals of a circuit element defines the behavior of that element within the circuit. In this section, we shall introduce a graphical means of representing the terminal characteristics of circuit elements. Figure 11.6 depicts the representation that will be employed throughout the chapter to denote a generalized circuit element: the variable i represents the current flowing through the element, while v is the potential difference, or voltage, across the element.

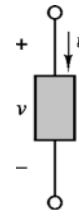

FIGURE 11.6 Generalized representation of circuit elements.

Suppose now that a known voltage were imposed across a circuit element. The current that would flow as a consequence of this voltage, and the voltage itself, form a unique pair of values. If the voltage applied to the element were varied and the resulting current measured, it would be possible to construct a functional relationship between voltage and current known as the **i - v characteristic** (or **volt-ampere characteristic**). Such a relationship defines the circuit element, in the sense that if we impose any prescribed voltage (or current), the resulting current (or voltage) is directly obtainable from the i - v characteristic. A direct consequence is that the power dissipated (or generated) by the element may also be determined from the i - v curve.

The i - v characteristics of ideal current and voltage sources can also be useful in visually representing their behavior. An ideal voltage source generates a prescribed voltage independent of the current drawn from the load; thus, its i - v characteristic is a straight vertical line with a voltage axis intercept corresponding to the source voltage. Similarly, the i - v characteristic of an ideal current source is a horizontal line with a current axis intercept corresponding to the source current. Figure 11.7 depicts this behavior.

Resistance and Ohm's Law

When electric current flows through a metal wire or through other circuit elements, it encounters a certain amount of **resistance**, the magnitude of which depends on the electrical properties of the material. Resistance to the flow of current may be undesired—for example, in the case of lead wires and connection

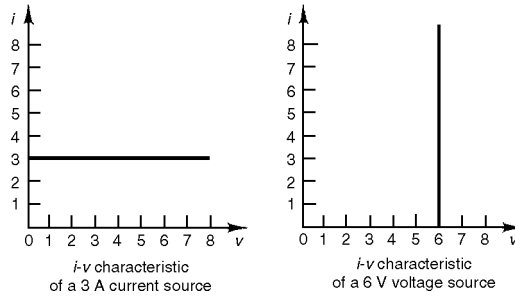

FIGURE 11.7 i - v characteristics of ideal sources.

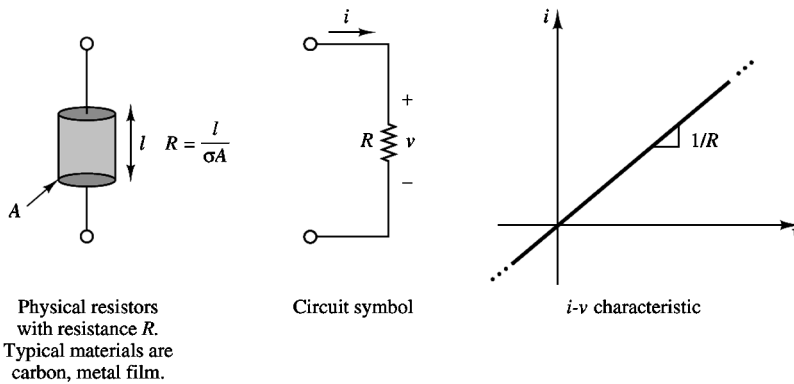

FIGURE 11.8 The resistance element.

cable—or it may be exploited in an electrical circuit in a useful way. Nevertheless, practically all circuit elements exhibit some resistance; as a consequence, current flowing through an element will cause energy to be dissipated in the form of heat. An ideal **resistor** is a device that exhibits linear resistance properties according to Ohm's law, which states that

$$V = IR \quad (11.10)$$

that is, that the voltage across an element is directly proportional to the current flow through it. R is the value of the resistance in units of ohms (Ω), where

$$1 \Omega = 1 \text{ V/A} \quad (11.11)$$

The resistance of a material depends on a property called **resistivity**, denoted by the symbol ρ ; the inverse of resistivity is called **conductivity** and is denoted by the symbol σ . For a cylindrical resistance element (shown in Fig. 11.8), the resistance is proportional to the length of the sample, l , and inversely proportional to its cross-sectional area, A , and conductivity, σ .

$$v = \frac{1}{\sigma A} i \quad (11.12)$$

It is often convenient to define the **conductance** of a circuit element as the inverse of its resistance. The symbol used to denote the conductance of an element is G , where

$$G = \frac{1}{R} \text{ siemens (S), where } 1 \text{ S} = 1 \text{ A/V} \quad (11.13)$$

TABLE 11.1 Common Resistor Values ($1/8$ -, $1/4$ -, $1/2$ -, 1-, 2-W Rating)

| Ω | Code | Ω | Multiplier | k Ω | Multiplier | k Ω | Multiplier | k Ω | Multiplier |
|----------|-------------|----------|------------|------------|------------|------------|------------|------------|------------|
| 10 | Brn-blk-blk | 100 | Brown | 1.0 | Red | 10 | Orange | 100 | Yellow |
| 12 | Brn-red-blk | 120 | Brown | 1.2 | Red | 12 | Orange | 120 | Yellow |
| 15 | Brn-grn-blk | 150 | Brown | 1.5 | Red | 15 | Orange | 150 | Yellow |
| 18 | Brn-gry-blk | 180 | Brown | 1.8 | Red | 18 | Orange | 180 | Yellow |
| 22 | Red-red-blk | 220 | Brown | 2.2 | Red | 22 | Orange | 220 | Yellow |
| 27 | Red-vlt-blk | 270 | Brown | 2.7 | Red | 27 | Orange | 270 | Yellow |
| 33 | Org-org-blk | 330 | Brown | 3.3 | Red | 33 | Orange | 330 | Yellow |
| 39 | Org-wht-blk | 390 | Brown | 3.9 | Red | 39 | Orange | 390 | Yellow |
| 47 | Ylw-vlt-blk | 470 | Brown | 4.7 | Red | 47 | Orange | 470 | Yellow |
| 56 | Grn-blu-blk | 560 | Brown | 5.6 | Red | 56 | Orange | 560 | Yellow |
| 68 | Blu-gry-blk | 680 | Brown | 6.8 | Red | 68 | Orange | 680 | Yellow |
| 82 | Gry-red-blk | 820 | Brown | 8.2 | Red | 82 | Orange | 820 | Yellow |

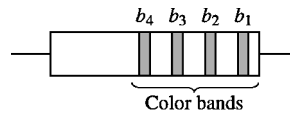

| | | | |
|--------|---|--------|-----|
| black | 0 | blue | 6 |
| brown | 1 | violet | 7 |
| red | 2 | gray | 8 |
| orange | 3 | white | 9 |
| yellow | 4 | silver | 10% |
| green | 5 | gold | 5% |

$$\text{Resistor value} = (b_1 b_2) \times 10^{b_3};$$

$$b_4 = \% \text{ tolerance in actual value}$$

FIGURE 11.9 Resistor color code.

Thus, Ohm's law can be restated in terms of conductance, as

$$I = GV \quad (11.14)$$

Ohm's law is an empirical relationship that finds widespread application in electrical engineering because of its simplicity. It is, however, only an approximation of the physics of electrically conducting materials. Typically, the linear relationship between voltage and current in electrical conductors does not apply at very high voltages and currents. Further, not all electrically conducting materials exhibit linear behavior even for small voltages and currents. It is usually true, however, that for some range of voltages and currents, most elements display a linear *i-v characteristic*.

The typical construction and the circuit symbol of the resistor are shown in Fig. 11.8. Resistors made of cylindrical sections of carbon (with resistivity $\rho = 3.5 \times 10^{-5} \Omega \text{ m}$) are very common and are commercially available in a wide range of values for several power ratings (as will be explained shortly). Another commonly employed construction technique for resistors employs metal film. A common power rating for resistors used in electronic circuits (e.g., in most consumer electronic appliances such as radios and television sets) is $\frac{1}{4}$ W. Table 11.1 lists the standard values for commonly used resistors and the color code associated with these values (i.e., the common combinations of the digits $b_1 b_2 b_3$ as defined in Fig. 11.9). For example, if the first three color bands on a resistor show the colors red ($b_1 = 2$), violet ($b_2 = 7$), and yellow ($b_3 = 4$), the resistance value can be interpreted as follows:

$$R = 27 \times 10^4 = 270,000 \Omega = 270 \text{ k}\Omega$$

In Table 11.1, the leftmost column represents the complete color code; columns to the right of it only show the third color, since this is the only one that changes. For example, a 10- Ω resistor has the code brown-black-black, while a 100- Ω resistor has brown-black-brown.

In addition to the resistance in ohms, the maximum allowable power dissipation (or **power rating**) is typically specified for commercial resistors. Exceeding this power rating leads to overheating and can cause the resistor to literally start on fire. For a resistor R , the power dissipated is given by

$$P = VI = I^2R = \frac{V^2}{R} \quad (11.15)$$

That is, the power dissipated by a resistor is proportional to the square of the current flowing through it, as well as the square of the voltage across it. The following example illustrates a common engineering application of resistive elements: the resistance strain gauge.

Example 11.1 Resistance Strain Gauges

A common application of the resistance concept to engineering measurements is the resistance **strain gauge**. Strain gauges are devices that are bonded to the surface of an object, and whose resistance varies as a function of the surface strain experienced by the object. Strain gauges may be used to perform measurements of strain, stress, force, torque, and pressure. Recall that the resistance of a cylindrical conductor of cross-sectional area A , length L , and conductivity σ is given by the expression

$$R = \frac{L}{\sigma A}$$

If the conductor is compressed or elongated as a consequence of an external force, its dimensions will change, and with them its resistance. In particular, if the conductor is stretched, its cross-sectional area will decrease and the resistance will increase. If the conductor is compressed, its resistance decreases, since the length, L , will decrease. The relationship between change in resistance and change in length is given by the gauge factor, G , defined by

$$G = \frac{\Delta R/R}{\Delta L/L}$$

and since the strain ε is defined as the fractional change in length of an object by the formula

$$\varepsilon = \frac{\Delta L}{L}$$

the change in resistance due to an applied strain ε is given by the expression

$$\Delta R = R_0 G \varepsilon$$

where R_0 is the resistance of the strain gauge under no strain and is called the zero strain resistance. The value of G for resistance strain gauges made of metal foil is usually about 2.

Figure 11.10 depicts a typical foil strain gauge. The maximum strain that can be measured by a foil gauge is about 0.4–0.5%; that is, $\Delta L/L = 0.004$ to 0.005 . For a $120\text{-}\Omega$ gauge, this corresponds to a change in resistance of the order of $0.96\text{--}1.2\ \Omega$. Although this change in resistance is very small, it can be detected by means of suitable circuitry. Resistance strain gauges are usually connected in a circuit called the Wheatstone bridge, which we analyze later in this section.

Open and Short Circuits

Two convenient idealizations of the resistance element are provided by the limiting cases of Ohm's law as the resistance of a circuit element approaches zero or infinity. A circuit element with resistance approaching zero is called a **short circuit**. Intuitively, one would expect a short circuit to allow for unimpeded flow of current. In fact, metallic conductors (e.g., short wires of large diameter) approximate the behavior of a short circuit. Formally, a short circuit is defined as a circuit element across which the voltage is zero, regardless of the current flowing through it. **Figure 11.11** depicts the circuit symbol for an ideal short circuit.

TABLE 11.2 Resistance of Copper Wire

| AWG Size | Number of Strands | Diameter per Strand | Resistance per 1000 ft (Ω) |
|----------|-------------------|---------------------|-------------------------------------|
| 24 | Solid | 0.0201 | 28.4 |
| 24 | 7 | 0.0080 | 28.4 |
| 22 | Solid | 0.0254 | 18.0 |
| 22 | 7 | 0.0100 | 19.0 |
| 20 | Solid | 0.0320 | 11.3 |
| 20 | 7 | 0.0126 | 11.9 |
| 18 | Solid | 0.0403 | 7.2 |
| 18 | 7 | 0.0159 | 7.5 |
| 16 | Solid | 0.0508 | 4.5 |
| 16 | 19 | 0.0113 | 4.7 |

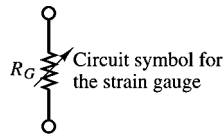

Metal-foil resistance strain gauge.
The foil is formed by a photo-etching process and is less than 0.00002 in. thick. Typical resistance values are 120, 350, and 1000 Ω . The wide areas are bonding pads for electrical connections.

FIGURE 11.10 The resistance strain gauge.

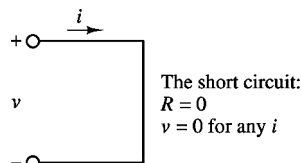

FIGURE 11.11 The short circuit.

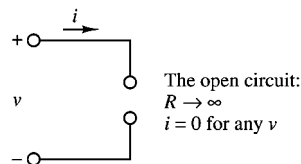

FIGURE 11.12 The open circuit.

Physically, any wire or other metallic conductor will exhibit some resistance, though small. For practical purposes, however, many elements approximate a short circuit quite accurately under certain conditions. For example, a large-diameter copper pipe is effectively a short circuit in the context of a residential electrical power supply, while in a low-power microelectronic circuit (e.g., an FM radio) a short length of 24 gauge wire (refer to [Table 11.2](#) for the resistance of 24 gauge wire) is a more than adequate short circuit.

A circuit element whose resistance approaches infinity is called an **open circuit**. Intuitively, one would expect no current to flow through an open circuit, since it offers infinite resistance to any current. In an open circuit, we would expect to see zero current regardless of the externally applied voltage. [Figure 11.12](#) illustrates this idea.

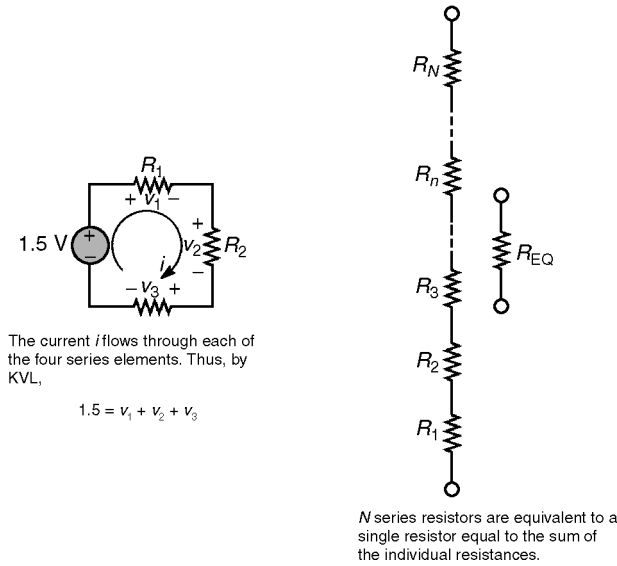

FIGURE 11.13 Voltage divider rule.

In practice, it is not too difficult to approximate an open circuit; any break in continuity in a conducting path amounts to an open circuit. The idealization of the open circuit, as defined in Fig. 11.12, does not hold, however, for very high voltages. The insulating material between two insulated terminals will break down at a sufficiently high voltage. If the insulator is air, ionized particles in the neighborhood of the two conducting elements may lead to the phenomenon of arcing; in other words, a pulse of current may be generated that momentarily jumps a gap between conductors (thanks to this principle, we are able to ignite the air-fuel mixture in a spark-ignition internal combustion engine by means of spark plugs). The ideal open and short circuits are useful concepts and find extensive use in circuit analysis.

Series Resistors and the Voltage Divider Rule

Although electrical circuits can take rather complicated forms, even the most involved circuits can be reduced to combinations of circuit elements *in parallel* and *in series*. Thus, it is important that you become acquainted with parallel and series circuits as early as possible, even before formally approaching the topic of network analysis. Parallel and series circuits have a direct relationship with Kirchhoff's laws. The objective of this section and the next is to illustrate two common circuits based on series and parallel combinations of resistors: the voltage and current dividers. These circuits form the basis of all network analysis; it is therefore important to master these topics as early as possible.

For an example of a series circuit, refer to the circuit of Fig. 11.13, where a battery has been connected to resistors R_1 , R_2 , and R_3 . The following definition applies.

Definition

Two or more circuit elements are said to be **in series** if the same current flows through each of the elements.

The three resistors could thus be replaced by a single resistor of value R_{EQ} without changing the amount of current required of the battery. From this result we may extrapolate to the more general relationship defining the equivalent resistance of N series resistors:

$$R_{EQ} = \sum_{n=1}^N R_n \quad (11.16)$$

which is also illustrated in Fig. 11.13. A concept very closely tied to series resistors is that of the **voltage divider**.

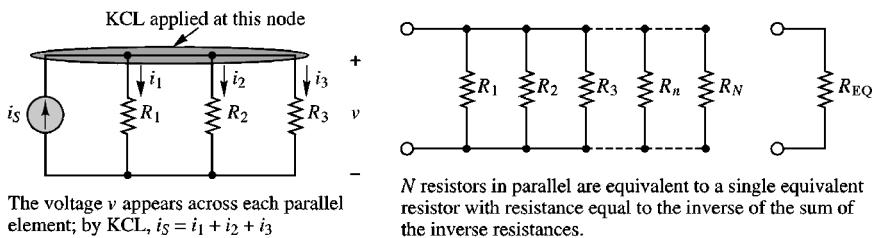

FIGURE 11.14 Parallel circuits.

The general form of the voltage divider rule for a circuit with N series resistors and a voltage source is

$$v_n = \frac{R_n}{R_1 + R_2 + \cdots + R_n + \cdots + R_N} v_S \quad (11.17)$$

Parallel Resistors and the Current Divider Rule

A concept analogous to that of the voltage may be developed by applying Kirchhoff's current law to a circuit containing only parallel resistances.

Definition

Two or more circuit elements are said to be **in parallel** if the same voltage appears across each of the elements. (See Fig. 11.14.)

N resistors in parallel act as a single equivalent resistance, R_{EQ} , given by the expression

$$\frac{1}{R_{EQ}} = \frac{1}{R_1} + \frac{1}{R_2} + \cdots + \frac{1}{R_N} \quad (11.18)$$

or

$$R_{EQ} = \frac{1}{1/R_1 + 1/R_2 + \cdots + 1/R_N} \quad (11.19)$$

Very often in the remainder of this book we shall refer to the parallel combination of two or more resistors with the following notation:

$$R_1 \parallel R_2 \parallel \cdots$$

where the symbol \parallel signifies "in parallel with."

The general expression for the current divider for a circuit with N parallel resistors is the following:

$$i_n = \frac{1/R_n}{1/R_1 + 1/R_2 + \cdots + 1/R_n + \cdots + 1/R_N} i_S \quad \text{Current divider} \quad (11.20)$$

Example 11.2 The Wheatstone Bridge

The **Wheatstone bridge** is a resistive circuit that is frequently encountered in a variety of measurement circuits. The general form of the bridge is shown in Fig. 11.15(a), where R_1 , R_2 , and R_3 are known, while R_x is an unknown resistance, to be determined. The circuit may also be redrawn as shown in Fig. 11.15(b). The latter circuit will be used to demonstrate the use of the voltage divider rule in a mixed series-parallel circuit.

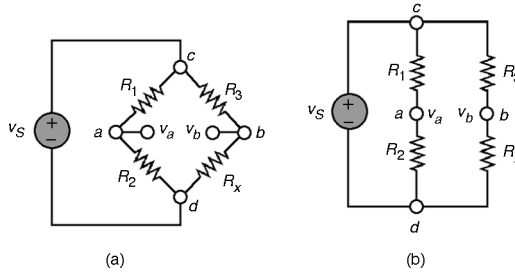

FIGURE 11.15 Wheatstone bridge circuits.

The objective is to determine the unknown resistance R_x .

1. Find the value of the voltage $v_{ad} = v_{ad} - v_{bd}$ in terms of the four resistances and the source voltage, v_s . Note that since the reference point d is the same for both voltages, we can also write $v_{ab} = v_a - v_b$.
2. If $R_1 = R_2 = R_3 = 1 \text{ k}\Omega$, $v_s = 12 \text{ V}$, and $v_{ab} = 12 \text{ mV}$, what is the value of R_x ?

Solution

1. First, we observe that the circuit consists of the parallel combination of three subcircuits: the voltage source, the series combination of R_1 and R_2 , and the series combination of R_3 and R_x . Since these three subcircuits are in parallel, the same voltage will appear across each of them, namely, the source voltage, v_s .

Thus, the source voltage divides between each resistor pair, R_1 - R_2 and R_3 - R_x , according to the voltage divider rule: v_a is the fraction of the source voltage appearing across R_2 , while v_b is the voltage appearing across R_x :

$$v_a = v_s \frac{R_2}{R_1 + R_2} \quad \text{and} \quad v_b = v_s \frac{R_x}{R_3 + R_x}$$

Finally, the voltage difference between points a and b is given by

$$v_{ab} = v_a - v_b = v_s \left(\frac{R_2}{R_1 + R_2} - \frac{R_x}{R_3 + R_x} \right)$$

This result is very useful and quite general, and it finds application in numerous practical circuits.

2. In order to solve for the unknown resistance, we substitute the numerical values in the preceding equation to obtain

$$0.012 = 12 \left(\frac{1000}{2000} - \frac{R_x}{1000 + R_x} \right)$$

which may be solved for R_x to yield

$$R_x = 996 \text{ }\Omega$$

Practical Voltage and Current Sources

Idealized models of voltage and current sources fail to take into consideration the finite-energy nature of practical voltage and current sources. The objective of this section is to extend the ideal models to models that are capable of describing the physical limitations of the voltage and current sources used in practice. Consider, for example, the model of an ideal voltage source. As the load resistance (R) decreases, the source is required to provide increasing amounts of current to maintain the voltage $v_s(t)$ across

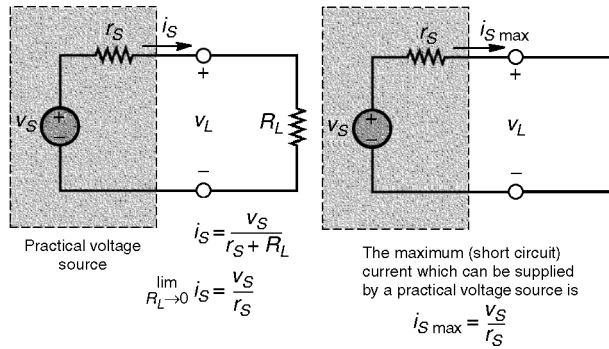

FIGURE 11.16 Practical voltage source.

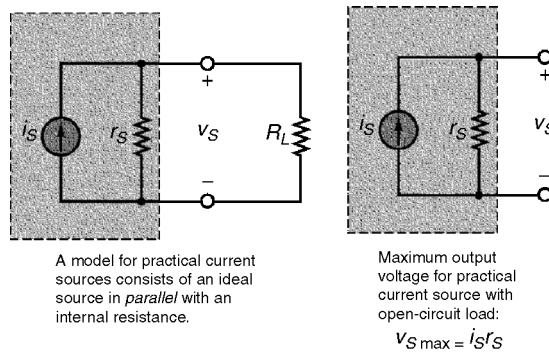

FIGURE 11.17 Practical current source.

its terminal:

$$i(t) = \frac{v_s(t)}{R} \tag{11.21}$$

This circuit suggests that the ideal voltage source is required to provide an infinite amount of current to the load, in the limit as the load resistance approaches zero.

Figure 11.16 depicts a model for a practical voltage source; this is composed of an ideal voltage source, v_s , in series with a resistance, r_s . The resistance r_s in effect poses a limit to the maximum current the voltage source can provide:

$$i_{S \max} = \frac{v_S}{r_S} \tag{11.22}$$

It should be apparent that a desirable feature of an ideal voltage source is a very small internal resistance, so that the current requirements of an arbitrary load may be satisfied.

A similar modification of the ideal current source model is useful to describe the behavior of a practical current source. The circuit illustrated in Fig. 11.17 depicts a simple representation of a practical current source, consisting of an ideal source in parallel with a resistor. Note that as the load resistance approaches infinity (i.e., an open circuit), the output voltage of the current source approaches its limit,

$$v_{S \max} = i_S r_S \tag{11.23}$$

A good current source should be able to approximate the behavior of an ideal current source. Therefore, a desirable characteristic for the internal resistance of a current source is that it be as large as possible.

Measuring Devices

The Ammeter

The **ammeter** is a device that, when connected in series with a circuit element, can measure the current flowing through the element. Figure 11.18 illustrates this idea. From Fig. 11.18, two requirements are evident for obtaining a correct measurement of current:

1. The ammeter must be placed in series with the element whose current is to be measured (e.g., resistor R_2).
2. The ammeter should not resist the flow of current (i.e., cause a voltage drop), or else it will not be measuring the true current flowing the circuit. *An ideal ammeter has zero internal resistance.*

The Voltmeter

The **voltmeter** is a device that can measure the voltage across a circuit element. Since voltage is the difference in potential between two points in a circuit, the voltmeter needs to be connected across the element whose voltage we wish to measure. A voltmeter must also fulfill two requirements:

1. The voltmeter must be placed in parallel with the element whose voltage it is measuring.
2. The voltmeter should draw no current away from the element whose voltage it is measuring, or else it will not be measuring the true voltage across that element. Thus, *an ideal voltmeter has infinite internal resistance.*

Figure 11.19 illustrates these two points.

Once again, the definitions just stated for the ideal voltmeter and ammeter need to be augmented by considering the practical limitations of the devices. A practical ammeter will contribute some series resistance to the circuit in which it is measuring current; a practical voltmeter will not act as an ideal open circuit but will always draw some current from the measured circuit. Figure 11.20 depicts the circuit models for the practical ammeter and voltmeter.

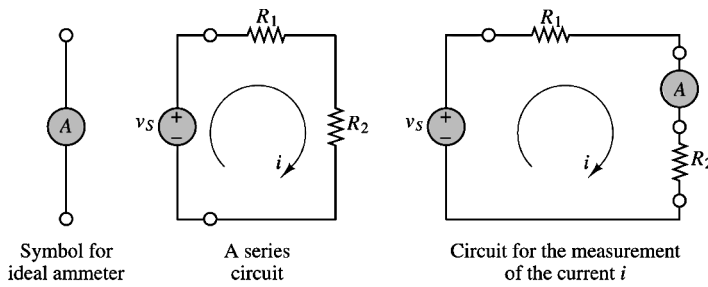

FIGURE 11.18 Measurement of current.

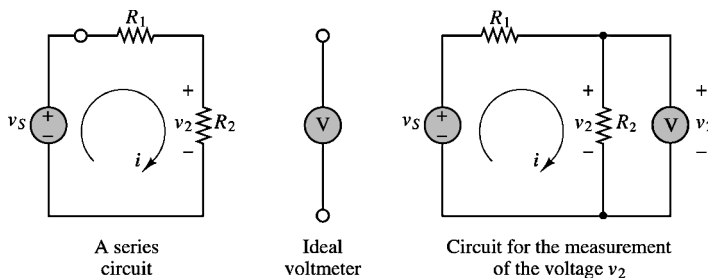

FIGURE 11.19 Measurement of voltage.

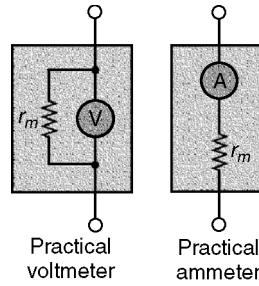

FIGURE 11.20 Models for practical ammeter and voltmeter.

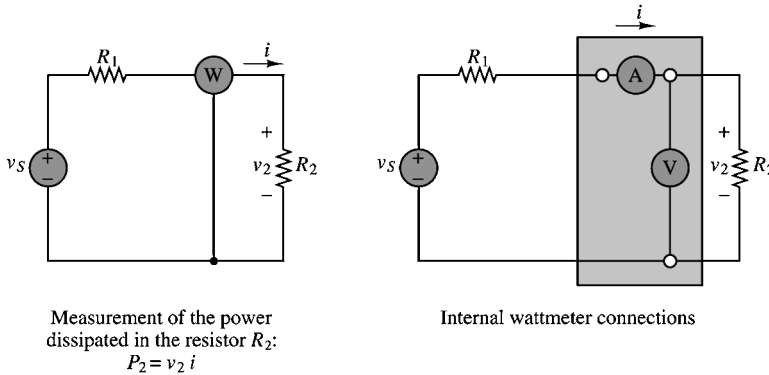

FIGURE 11.21 Measurement of power.

All of the considerations that pertain to practical ammeters and voltmeters can be applied to the operation of a **wattmeter**, a measuring instrument that provides a measurement of the power dissipated by a circuit element, since the wattmeter is in effect made up of a combination of a voltmeter and an ammeter.

Figure 11.21 depicts the typical connection of a wattmeter in the same series circuit used in the preceding paragraphs. In effect, the wattmeter measures the current flowing through the load and, simultaneously, the voltage across it multiplies the two to provide a reading of the power dissipated by the load.

11.3 Resistive Network Analysis

This section will illustrate the fundamental techniques for the analysis of resistive circuits. The methods introduced are based on Kirchhoff's and Ohm's laws. The main thrust of the section is to introduce and illustrate various methods of circuit analysis that will be applied throughout the book.

The Node Voltage Method

Node voltage analysis is the most general method for the analysis of electrical circuits. In this section, its application to linear resistive circuits will be illustrated. The **node voltage method** is based on defining the voltage at each node as an independent variable. One of the nodes is selected as a **reference node** (usually—but not necessarily—ground), and each of the other node voltages is referenced to this node. Once each node voltage is defined, Ohm's law may be applied between any two adjacent nodes in order to determine the current flowing in each branch. In the node voltage method, *each branch current is expressed in terms of one or more node voltages*; thus, currents do not explicitly enter into the equations. Figure 11.22 illustrates how one defines branch currents in this method.

In the node voltage method, we assign the node voltages v_a and v_b ; the branch current flowing from a to b is then expressed in terms of these node voltages.

$$i = \frac{v_a - v_b}{R}$$

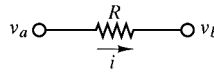

FIGURE 11.22 Branch current formulation in nodal analysis.

By KCL: $i_1 = i_2 + i_3$. In the node voltage method, we express KCL by

$$\frac{v_a - v_b}{R_1} = \frac{v_b - v_c}{R_2} + \frac{v_b - v_d}{R_3}$$

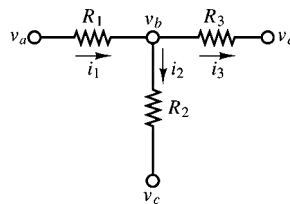

FIGURE 11.23 Use of KCL in nodal analysis.

Once each branch current is defined in terms of the node voltages, Kirchhoff's current law is applied at each node. The particular form of KCL employed in the nodal analysis equates the sum of the currents into the node to the sum of the currents leaving the node:

$$\sum i_{\text{in}} = \sum i_{\text{out}} \quad (11.24)$$

Figure 11.23 illustrates this procedure.

The systematic application of this method to a circuit with n nodes would lead to writing n linear equations. However, one of the node voltages is the reference voltage and is therefore already known, since it is usually assumed to be zero. Thus, we can write $n - 1$ independent linear equations in the $n - 1$ independent variables (the node voltages). Nodal analysis provides the minimum number of equations required to solve the circuit, since any branch voltage or current may be determined from knowledge of nodal voltages.

The nodal analysis method may also be defined as a sequence of steps, as outlined below.

Node Voltage Analysis Method

1. Select a reference node (usually ground). All other node voltages will be referenced to this node.
2. Define the remaining $n - 1$ node voltages as the independent variables.
3. Apply KCL at each of the $n - 1$ nodes, expressing each current in terms of the adjacent node voltages.
4. Solve the linear system of $n - 1$ equations in $n - 1$ unknowns.

In a circuit containing n nodes we can write at most $n - 1$ independent equations.

The Mesh Current Method

In the mesh current method, we observe that a current flowing through a resistor in a specified direction defines the polarity of the voltage across the resistor, as illustrated in Fig. 11.24, and that the sum of the voltages around a closed circuit must equal zero, by KVL. Once a convention is established regarding the direction of current flow around a mesh, simple application of KVL provides the desired equation. Figure 11.25 illustrates this point.

The current i , defined as flowing from left to right, establishes the polarity of the voltage across R .

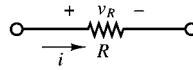

FIGURE 11.24 Basic principle of mesh analysis.

Once the direction of current flow has been selected, KVL requires that $v_1 = v_2 + v_3$.

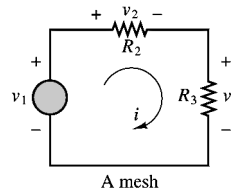

FIGURE 11.25 Use of KVL in mesh analysis.

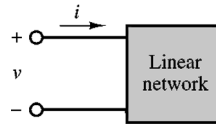

FIGURE 11.26 One-port network.

The number of equations one obtains by this technique is equal to the number of meshes in the circuit. All branch currents and voltages may subsequently be obtained from the mesh currents, as will presently be shown. Since meshes are easily identified in a circuit, this method provides a very efficient and systematic procedure for the analysis of electrical circuits. The following section outlines the procedure used in applying the mesh current method to a linear circuit.

Mesh Current Analysis Method

1. Define each mesh current consistently. We shall always define mesh currents clockwise, for convenience.
2. Apply KVL around each mesh, expressing each voltage in terms of one or more mesh currents.
3. Solve the resulting linear system of equations with mesh currents as the independent variables.

In mesh analysis, it is important to be consistent in choosing the direction of current flow. To avoid confusion in writing the circuit equations, mesh currents will be defined exclusively clockwise when we are using this method.

One-Port Networks and Equivalent Circuits

This general circuit representation is shown in Fig. 11.26. This configuration is called a **one-port network** and is particularly useful for introducing the notion of equivalent circuits. Note that the network of Fig. 11.26 is completely described by its i - v characteristic.

Thévenin and Norton Equivalent Circuits

This section discusses one of the most important topics in the analysis of electrical circuits: the concept of an **equivalent circuit**. It will be shown that it is always possible to view even a very complicated circuit in terms of much simpler *equivalent* source and load circuits, and that the transformations leading to equivalent circuits are easily managed, with a little practice. In studying node voltage and mesh current analysis, you may have observed that there is a certain correspondence (called **duality**) between current sources and voltage sources, on the one hand, and parallel and series circuits, on the other. This duality appears again very clearly in the analysis of equivalent circuits: it will shortly be shown that equivalent circuits fall into one of two classes, involving either voltage or current sources and (respectively) either

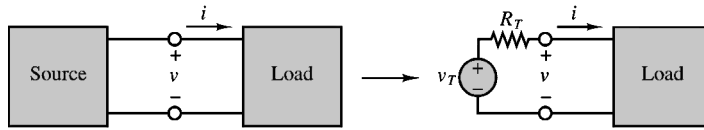

FIGURE 11.27 Illustration of Thévenin theorem.

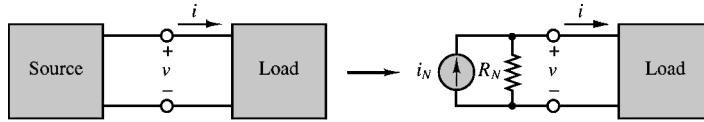

FIGURE 11.28 Illustration of Norton theorem.

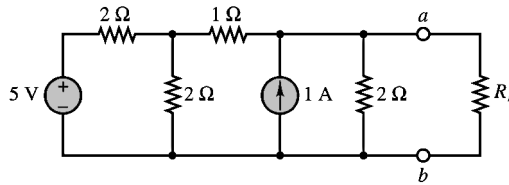

FIGURE 11.29 Computation of Thévenin resistance.

series or parallel resistors, reflecting this same principle of duality. The discussion of equivalent circuits begins with the statement of two very important theorems, summarized in Figs. 11.27 and 11.28.

The Thévenin Theorem

As far as a load is concerned, any network composed of ideal voltage and current sources, and of linear resistors, may be represented by an equivalent circuit consisting of an ideal voltage source, v_T , in series with an equivalent resistance, R_T .

The Norton Theorem

As far as a load is concerned, any network composed of ideal voltage and current sources, and of linear resistors, may be represented by an equivalent circuit consisting of an ideal current source, i_N , in parallel with an equivalent resistance, R_N .

Determination of Norton or Thévenin Equivalent Resistance

The first step in computing a Thévenin or Norton equivalent circuit consists of finding the equivalent resistance presented by the circuit at its terminals. This is done by setting all sources in the circuit equal to zero and computing the effective resistance between terminals. The voltage and current sources present in the circuit are set to zero as follows: voltage sources are replaced by short circuits, current sources by open circuits. We can produce a set of simple rules as an aid in the computation of the Thévenin (or Norton) equivalent resistance for a linear resistive circuit.

Computation of Equivalent Resistance of a One-Port Network:

1. Remove the load.
2. Zero all voltage and current sources
3. Compute the total resistance between load terminals, *with the load removed*. This resistance is equivalent to that which would be encountered by a current source connected to the circuit in place of the load.

For example, the equivalent resistance of the circuit of Fig. 11.29 as seen by the load is:

$$R_{eq} = ((2 \parallel 2) + 1) \parallel 2 = 1 \Omega.$$

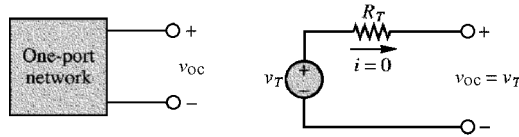

FIGURE 11.30 Equivalence of open-circuit and Thévenin voltage.

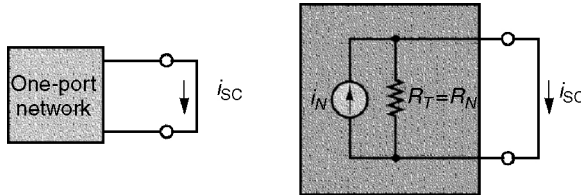

FIGURE 11.31 Illustration of Norton equivalent circuit.

Computing the Thévenin Voltage

The Thévenin equivalent voltage is defined as follows: the equivalent (Thévenin) source voltage is equal to the **open-circuit voltage** present at the load terminals with the load removed.

This states that in order to compute v_T , it is sufficient to remove the load and to compute the open-circuit voltage at the one-port terminals. Figure 11.30 illustrates that the open-circuit voltage, v_{OC} , and the Thévenin voltage, v_T , must be the same if the Thévenin theorem is to hold. This is true because in the circuit consisting of v_T and R_T , the voltage v_{OC} must equal v_T , since no current flows through R_T and therefore the voltage across R_T is zero. Kirchhoff's voltage law confirms that

$$v_T = R_T(0) + v_{OC} = v_{OC} \quad (11.25)$$

Computing the Norton Current

The computation of the Norton equivalent current is very similar in concept to that of the Thévenin voltage. The following definition will serve as a starting point.

Definition

The Norton equivalent current is equal to the **short-circuit current** that would flow were the load replaced by a short circuit.

An explanation for the definition of the Norton current is easily found by considering, again, an arbitrary one-port network, as shown in Fig. 11.31, where the one-port network is shown together with its Norton equivalent circuit.

It should be clear that the current, i_{SC} , flowing through the short circuit replacing the load is exactly the Norton current, i_N , since all of the source current in the circuit of Fig. 11.31 must flow through the short circuit.

Experimental Determination of Thévenin and Norton Equivalents

Figure 11.32 illustrates the measurement of the open-circuit voltage and short-circuit current for an arbitrary network connected to any load and also illustrates that the procedure requires some special attention, because of the nonideal nature of any practical measuring instrument. The figure clearly illustrates that in the presence of finite meter resistance, r_m , one must take this quantity into account in the computation of the short-circuit current and open-circuit voltage; v_{OC} and i_{SC} appear between quotation marks in the figure specifically to illustrate that the measured “open-circuit voltage” and “short-circuit current” are, in fact, affected by the internal resistance of the measuring instrument and are not the true quantities.

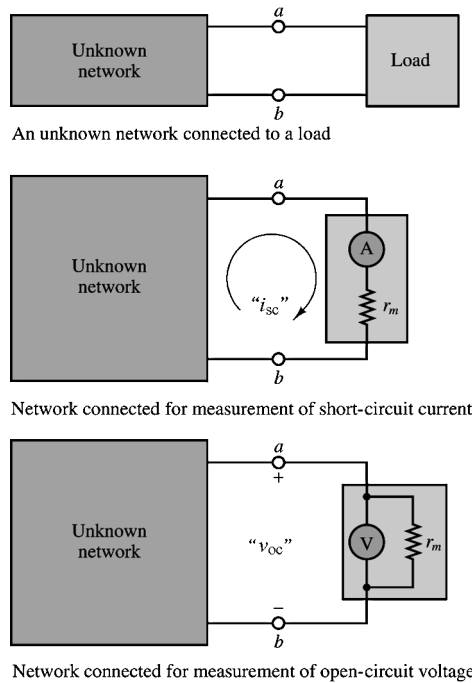

FIGURE 11.32 Measurement of open-circuit voltage and short-circuit current.

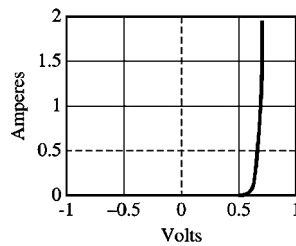

FIGURE 11.33 i - v characteristic of exponential resistor.

The following are expressions for the true short-circuit current and open-circuit voltage.

$$i_N = i_{sc} \left(1 + \frac{r_m}{R_T} \right) \tag{11.26}$$

$$v_T = v_{oc} \left(1 + \frac{R_T}{r_m} \right)$$

where i_N is the ideal Norton current, v_T the Thévenin voltage, and R_T the true Thévenin resistance.

Nonlinear Circuit Elements

Description of Nonlinear Elements

There are a number of useful cases in which a simple functional relationship exists between voltage and current in a nonlinear circuit element. For example, Fig. 11.33 depicts an element with an exponential i - v characteristic, described by the following equations:

$$i = I_0 e^{\alpha v}, \quad v > 0$$

$$i = -I_0, \quad v \leq 0 \tag{11.27}$$

Nonlinear element as a load. We wish to solve for v_x and i_x .

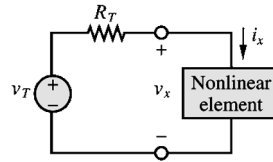

FIGURE 11.34 Representation of nonlinear element in a linear circuit.

There exists, in fact, a circuit element (the semiconductor diode) that very nearly satisfies this simple relationship. The difficulty in the i - v relationship of Eq. (11.27) is that it is not possible, in general, to obtain a closed-form analytical solution, even for a very simple circuit.

One approach to analyzing a circuit containing a nonlinear element might be to treat the nonlinear element as a load, and to compute the Thévenin equivalent of the remaining circuit, as shown in Fig. 11.34. Applying KVL, the following equation may then be obtained:

$$v_T = R_T i_x + v_x \quad (11.28)$$

To obtain the second equation needed to solve for both the unknown voltage, v_x , and the unknown current, i_x , it is necessary to resort to the i - v description of the nonlinear element, namely, Eq. (11.27). If, for the moment, only positive voltages are considered, the circuit is completely described by the following system:

$$\begin{aligned} i_x &= I_0 e^{\alpha v_x}, \quad v > 0 \\ v_T &= R_T i_x + v_x \end{aligned} \quad (11.29)$$

The two parts of Eq. (11.29) represent a system of two equations in two unknowns. Any numerical method of choice may now be applied to solve the system of Eqs. (11.29).

11.4 AC Network Analysis

In this section we introduce energy-storage elements, dynamic circuits, and the analysis of circuits excited by sinusoidal voltages and currents. Sinusoidal (or AC) signals constitute the most important class of signals in the analysis of electrical circuits. The simplest reason is that virtually all of the electric power used in households and industries comes in the form of sinusoidal voltages and currents.

Energy-Storage (Dynamic) Circuit Elements

The ideal resistor was introduced through Ohm's law in Section 11.2 as a useful idealization of many practical electrical devices. However, in addition to resistance to the flow of electric current, which is purely a dissipative (i.e., an energy-loss) phenomenon, electric devices may also exhibit energy-storage properties, much in the same way a spring or a flywheel can store mechanical energy. Two distinct mechanisms for energy storage exist in electric circuits: **capacitance** and **inductance**, both of which lead to the storage of energy in an electromagnetic field.

The Ideal Capacitor

A physical capacitor is a device that can store energy in the form of a charge separation when appropriately polarized by an electric field (i.e., a voltage). The simplest capacitor configuration consists of two parallel

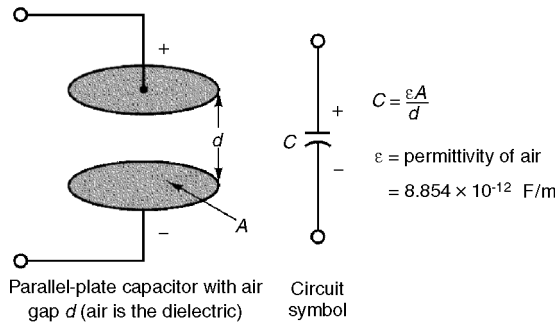

FIGURE 11.35 Structure of parallel-plate capacitor.

conducting plates of cross-sectional area A , separated by air (or another **dielectric*** material, such as mica or Teflon). Figure 11.35 depicts a typical configuration and the circuit symbol for a capacitor.

The presence of an insulating material between the conducting plates does not allow for the flow of DC current; thus, *a capacitor acts as an open circuit in the presence of DC currents*. However, if the voltage present at the capacitor terminals changes as a function of time, so will the charge that has accumulated at the two capacitor plates, since the degree of polarization is a function of the applied electric field, which is time-varying. In a capacitor, the charge separation caused by the polarization of the dielectric is proportional to the external voltage, that is, to the applied electric field:

$$Q = CV \quad (11.30)$$

where the parameter C is called the *capacitance* of the element and is a measure of the ability of the device to accumulate, or store, charge. The unit of capacitance is the coulomb/volt and is called the **farad** (F). The farad is an unpractically large unit; therefore, it is common to use microfarads ($1 \mu\text{F} = 10^{-6} \text{ F}$) or picofarads ($1 \text{ pF} = 10^{-12} \text{ F}$). From Eq. (11.30) it becomes apparent that if the external voltage applied to the capacitor plates changes in time, so will the charge that is internally stored by the capacitor:

$$q(t) = Cv(t) \quad (11.31)$$

Thus, although no current can flow through a capacitor if the voltage across it is constant, a time-varying voltage will cause charge to vary in time. The change with time in the stored charge is analogous to a current. The relationship between the current and voltage in a capacitor is as follows:

$$i(t) = C \frac{dv(t)}{dt} \quad (11.32)$$

If the above differential equation is integrated, one can obtain the following relationship for the voltage across a capacitor:

$$v_C(t) = \frac{1}{C} \int_{-\infty}^{t_0} i_C dt \quad (11.33)$$

Equation (11.33) indicates that the capacitor voltage depends on the past current through the capacitor, up until the present time, t . Of course, one does not usually have precise information regarding the flow

* A dielectric material contains a large number of electric dipoles, which become polarized in the presence of an electric field.

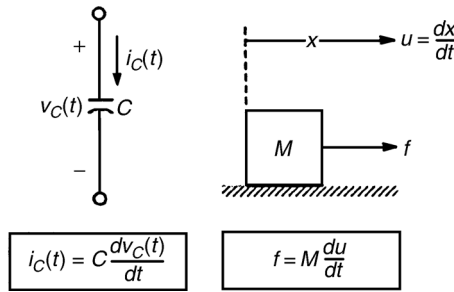

FIGURE 11.36 Defining equation for the ideal capacitor, and analogy with force-mass system.

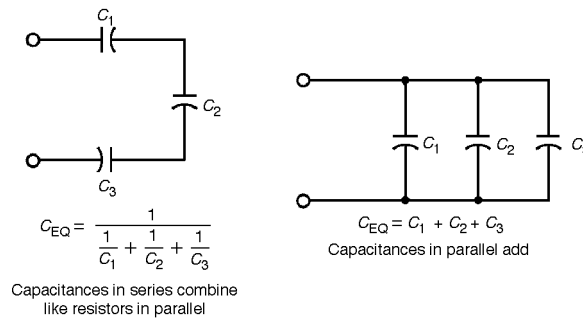

FIGURE 11.37 Combining capacitors in a circuit.

of capacitor current for all past time, and so it is useful to define the initial voltage (or *initial condition*) for the capacitor according to the following, where t_0 is an arbitrary initial time:

$$V_0 = v_C(t = t_0) = \frac{1}{C} \int_{-\infty}^{t_0} i_C dt \quad (11.34)$$

The capacitor voltage is now given by the expression

$$v_C(t) = \frac{1}{C} \int_{t_0}^t i_C dt + V_0 \quad t \geq t_0 \quad (11.35)$$

The significance of the initial voltage, V_0 , is simply that at time t_0 some charge is stored in the capacitor, giving rise to a voltage, $v_C(t_0)$, according to the relationship $Q = CV$. Knowledge of this initial condition is sufficient to account for the entire past history of the capacitor current. (See Fig. 11.36.)

From the standpoint of circuit analysis, it is important to point out that capacitors connected in series and parallel can be combined to yield a single equivalent capacitance. The rule of thumb, which is illustrated in Fig. 11.37, is the following: capacitors in parallel add; capacitors in series combine according to the same rules used for resistors connected in parallel.

Physical capacitors are rarely constructed of two parallel plates separated by air, because this configuration yields very low values of capacitance, unless one is willing to tolerate very large plate areas. In order to increase the capacitance (i.e., the ability to store energy), physical capacitors are often made of tightly rolled sheets of metal film, with a dielectric (paper or Mylar) sandwiched in-between. Table 11.3 illustrates typical values, materials, maximum voltage ratings, and useful frequency ranges for various

TABLE 11.3 Capacitors

| Material | Capacitance Range | Maximum Voltage (V) | Frequency Range (Hz) |
|--------------|-------------------|---------------------|-----------------------------------|
| Mica | 1 pF to 0.1 μF | 100–600 | 10 ³ –10 ¹⁰ |
| Ceramic | 10 pF to 1 μF | 50–1000 | 10 ³ –10 ¹⁰ |
| Mylar | 0.001 to 10 μF | 50–500 | 10 ² –10 ⁸ |
| Paper | 1000 pF to 50 μF | 100–105 | 10 ² –10 ⁸ |
| Electrolytic | 0.1 μF to 0.2 F | 3–600 | 10–10 ⁴ |

types of capacitors. The voltage rating is particularly important, because any insulator will break down if a sufficiently high voltage is applied across it. The energy stored in a capacitor is given by

$$W_C(t) = \frac{1}{2} C v_C^2(t) \text{ (J)}$$

Example 11.3 Capacitive Displacement Transducer and Microphone

As shown in Fig. 11.26, the capacitance of a parallel-plate capacitor is given by the expression

$$C = \frac{\epsilon A}{d}$$

where ϵ is the **permittivity** of the dielectric material, A the area of each of the plates, and d their separation. The permittivity of air is $\epsilon_0 = 8.854 \times 10^{-12}$ F/m, so that two parallel plates of area 1 m², separated by a distance of 1 mm, would give rise to a capacitance of 8.854×10^{-3} μF, a very small value for a very large plate area. This relative inefficiency makes parallel-plate capacitors impractical for use in electronic circuits. On the other hand, parallel-plate capacitors find application as *motion transducers*, that is, as devices that can measure the motion or displacement of an object. In a capacitive motion transducer, the air gap between the plates is designed to be variable, typically by fixing one plate and connecting the other to an object in motion. Using the capacitance value just derived for a parallel-plate capacitor, one can obtain the expression

$$C = \frac{8.854 \times 10^{-3} A}{x}$$

where C is the capacitance in picofarad, A is the area of the plates in square millimeter, and x is the (variable) distance in millimeter. It is important to observe that the change in capacitance caused by the displacement of one of the plates is nonlinear, since the capacitance varies as the inverse of the displacement. For small displacements, however, the capacitance varies approximately in a linear fashion.

The *sensitivity*, S , of this motion transducer is defined as the slope of the change in capacitance per change in displacement, x , according to the relation

$$S = \frac{dC}{dx} = -\frac{8.854 \times 10^{-3} A}{2x^2} \text{ (pF/mm)}$$

Thus, the sensitivity increases for small displacements. This behavior can be verified by plotting the capacitance as a function of x and noting that as x approaches zero, the slope of the nonlinear $C(x)$ curve becomes steeper (thus the greater sensitivity). Figure 11.38 depicts this behavior for a transducer with area equal to 10 mm².

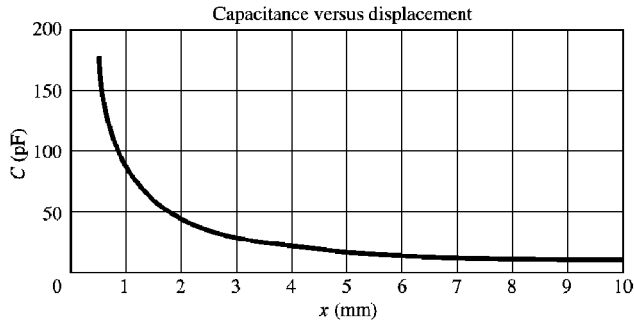

FIGURE 11.38 Response of a capacitive displacement transducer.

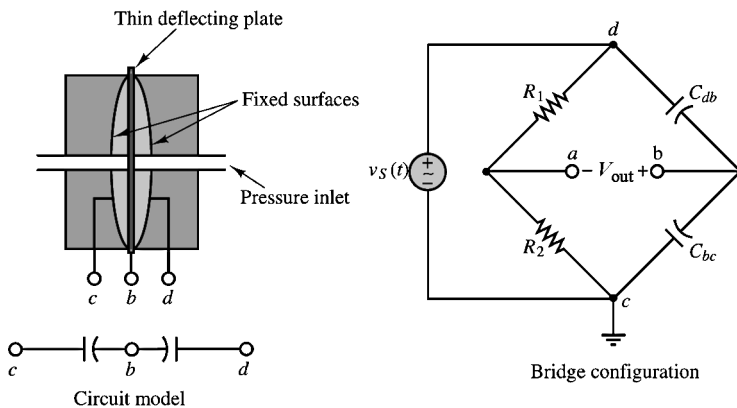

FIGURE 11.39 Capacitive pressure transducer and related bridge circuit.

This simple capacitive displacement transducer actually finds use in the popular *capacitive (or condenser) microphone*, in which the sound pressure waves act to displace one of the capacitor plates. The change in capacitance can then be converted into a change in voltage or current by means of a suitable circuit. An extension of this concept that permits measurement of differential pressures is shown in simplified form in Fig. 11.39. In the figure, a three-terminal variable capacitor is shown to be made up of two fixed surfaces (typically, spherical depressions ground into glass disks and coated with a conducting material) and of a deflecting plate (typically made of steel) sandwiched between the glass disks. Pressure inlet orifices are provided, so that the deflecting plate can come into contact with the fluid whose pressure it is measuring. When the pressure on both sides of the deflecting plate is the same, the capacitance between terminals b and d , C_{bd} , will be equal to that between terminals b and c , C_{bc} . If any pressure differential exists, the two capacitances will change, with an increase on the side where the deflecting plate has come closer to the fixed surface and a corresponding decrease on the other side.

This behavior is ideally suited for the application of a bridge circuit, similar to the Wheatstone bridge circuit illustrated in Example 11.2, and also shown in Fig. 11.39. In the bridge circuit, the output voltage, v_{out} , is precisely balanced when the differential pressure across the transducer is zero, but it will deviate from zero whenever the two capacitances are not identical because of a pressure differential across the transducer. We shall analyze the bridge circuit later in Example 11.4.

The Ideal Inductor

The ideal inductor is an element that has the ability to store energy in a magnetic field. Inductors are typically made by winding a coil of wire around a core, which can be an insulator or a ferromagnetic material, shown in Fig. 11.40. When a current flows through the coil, a magnetic field is established, as

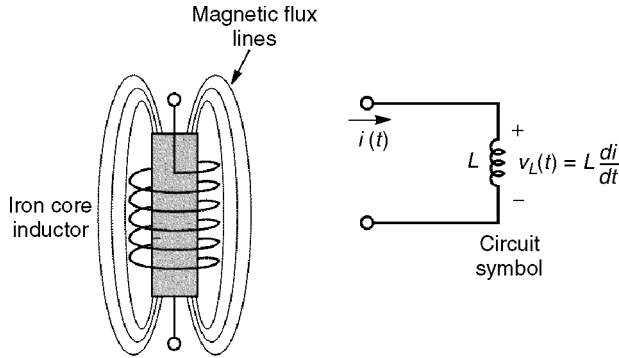

FIGURE 11.40 Iron-core inductor.

you may recall from early physics experiments with electromagnets. In an ideal inductor, the resistance of the wire is zero, so that a constant current through the inductor will flow freely without causing a voltage drop. In other words, *the ideal inductor acts as a short circuit in the presence of DC currents*. If a time-varying voltage is established across the inductor, a corresponding current will result, according to the following relationship:

$$v_L(t) = L \frac{di_L}{dt} \quad (11.36)$$

where L is called the *inductance* of the coil and is measured in henry (H), where

$$1 \text{ H} = 1 \text{ V sec/A} \quad (11.37)$$

Henrys are reasonable units for practical inductors; millihenrys (mH) and microhenrys (μH) are also used.

The inductor current is found by integrating the voltage across the inductor:

$$i_L(t) = \frac{1}{L} \int_{-\infty}^t v_L dt \quad (11.38)$$

If the current flowing through the inductor at time $t = t_0$ is known to be I_0 , with

$$I_0 = i_L(t = t_0) = \frac{1}{L} \int_{-\infty}^{t_0} v_L dt \quad (11.39)$$

then the inductor current can be found according to the equation

$$i_L(t) = \frac{1}{L} \int_{t_0}^t v_L dt + I_0 \quad t \geq t_0 \quad (11.40)$$

Inductors in series add. Inductors in parallel combine according to the same rules used for resistors connected in parallel. See Figs. 11.41–11.43.

Table 11.4 and Figs. 11.36, 11.41, and 11.43 illustrate a useful analogy between ideal electrical and mechanical elements.

TABLE 11.4 Analogy Between Electrical and Mechanical Variables

| Mechanical System | Electrical System |
|-------------------------|------------------------|
| Force, f (N) | Current, i (A) |
| Velocity, u (m/sec) | Voltage, v (V) |
| Damping, B (N sec/m) | Conductance, $1/R$ (S) |
| Compliance, $1/k$ (m/N) | Inductance, L (H) |
| Mass, M (kg) | Capacitance, C (F) |

The defining equation for the inductance circuit element is analogous to the equation of motion of a spring acted upon by a force.

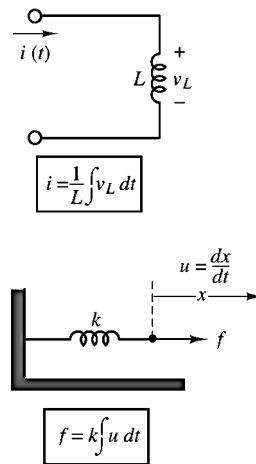

FIGURE 11.41 Defining equation for the ideal inductor and analogy with force-spring system.

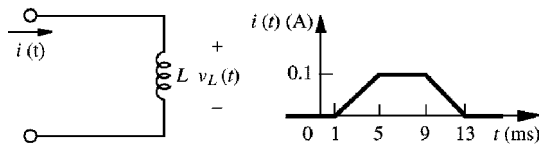

FIGURE 11.42 Combining inductors in a circuit.

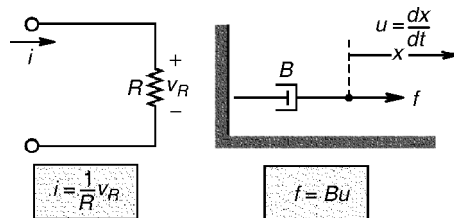

FIGURE 11.43 Analogy between electrical and mechanical elements.

Time-Dependent Signal Sources

Figure 11.44 illustrates the convention that will be employed to denote time-dependent signal sources.

One of the most important classes of time-dependent signals is that of **periodic signals**. These signals appear frequently in practical applications and are a useful approximation of many physical phenomena. A periodic signal $x(t)$ is a signal that satisfies the following equation:

$$x(t) = x(t + nT) \quad n = 1, 2, 3, \dots \quad (11.41)$$

where T is the **period** of $x(t)$. Figure 11.45 illustrates a number of the periodic waveforms that are typically encountered in the study of electrical circuits. Waveforms such as the sine, triangle, square, pulse, and sawtooth waves are provided in the form of voltages (or, less frequently, currents) by commercially available **signal** (or **waveform**) **generators**. Such instruments allow for selection of the waveform peak amplitude, and of its period.

As stated in the introduction, sinusoidal waveforms constitute by far the most important class of time-dependent signals. Figure 11.46 depicts the relevant parameters of a sinusoidal waveform. A generalized sinusoid is defined as follows:

$$x(t) = A \cos(\omega t + \phi) \quad (11.42)$$

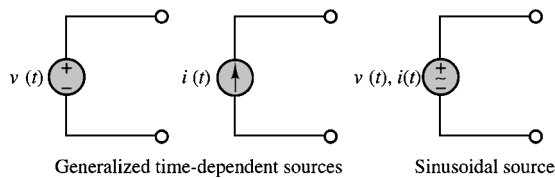

FIGURE 11.44 Time-dependent signal sources.

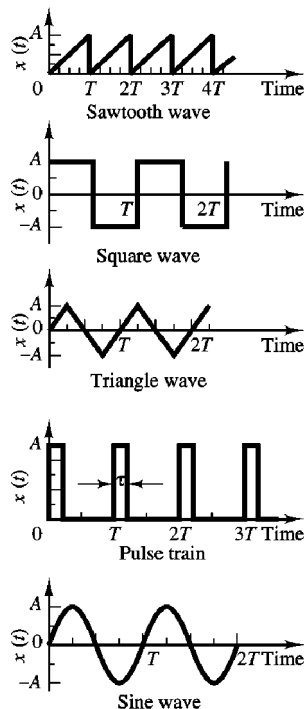

FIGURE 11.45 Periodic signal waveforms.

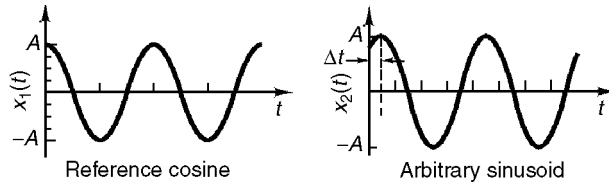

FIGURE 11.46 Sinusoidal waveforms.

where A is the **amplitude**, ω the **radian frequency**, and ϕ the **phase**. Figure 11.46 summarizes the definitions of A , ω , and ϕ for the waveforms

$$x_1(t) = A \cos(\omega t) \quad \text{and} \quad x_2(t) = A \cos(\omega t + \phi)$$

where

$$\begin{aligned} f &= \text{natural frequency} = \frac{1}{T} \text{ (cycles/sec, or Hz)} \\ \omega &= \text{radian frequency} = 2\pi f \text{ (radians/sec)} \\ \phi &= 2\pi \frac{\Delta T}{T} \text{ (radians)} = 360 \frac{\Delta T}{T} \text{ (degrees)} \end{aligned} \tag{11.43}$$

The phase shift, ϕ , permits the representation of an arbitrary sinusoidal signal. Thus, the choice of the reference cosine function to represent sinusoidal signals—arbitrary as it may appear at first—does not restrict the ability to represent all sinusoids. For example, one can represent a sine wave in terms of a cosine wave simply by introducing a phase shift of $\pi/2$ radians:

$$A \sin(\omega t) = A \cos\left(\omega t - \frac{\pi}{2}\right) \tag{11.44}$$

It is important to note that, although one usually employs the variable ω (in units of radians per second) to denote sinusoidal frequency, it is common to refer to natural frequency, f , in units of cycles per second, or hertz (Hz). The relationship between the two is the following:

$$\omega = 2\pi f \tag{11.45}$$

Average and RMS Values

Now that a number of different signal waveforms have been defined, it is appropriate to define suitable measurements for quantifying the strength of a time-varying electrical signal. The most common types of measurements are the **average** (or **DC**) **value** of a signal waveform, which corresponds to just measuring the mean voltage or current over a period of time, and the **root-mean-square (rms) value**, which takes into account the fluctuations of the signal about its average value. Formally, the operation of computing the average value of a signal corresponds to integrating the signal waveform over some (presumably, suitably chosen) period of time. We define the time-averaged value of a signal $x(t)$ as

$$\langle x(t) \rangle = \frac{1}{T} \int_0^T x(t) dt \tag{11.46}$$

where T is the period of integration. Figure 11.47 illustrates how this process does, in fact, correspond to computing the average amplitude of $x(t)$ over a period of T seconds.

$$\langle A \cos(\omega t + \phi) \rangle = 0$$



FIGURE 11.47 Averaging a signal waveform.

A circuit containing energy-storage elements is described by a differential equation. The differential equation describing the series RC circuit shown is

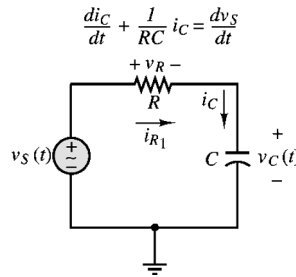

FIGURE 11.48 Circuit containing energy-storage element.

A useful measure of the voltage of an AC waveform is the rms value of the signal, $x(t)$, defined as follows:

$$x_{\text{rms}} = \sqrt{\frac{1}{T} \int_0^T x^2(t) dt} \quad (11.47)$$

Note immediately that if $x(t)$ is a voltage, the resulting x_{rms} will also have units of volts. If you analyze Eq. (11.47), you can see that, in effect, the rms value consists of the square root of the average (or mean) of the square of the signal. Thus, the notation *rms* indicates exactly the operations performed on $x(t)$ in order to obtain its rms value.

Solution of Circuits Containing Dynamic Elements

The major difference between the analysis of the resistive circuits and circuits containing capacitors and inductors is now that the equations that result from applying Kirchhoff's laws are differential equations, as opposed to the algebraic equations obtained in solving resistive circuits. Consider, for example, the circuit of Fig. 11.48 which consists of the series connection of a voltage source, a resistor, and a capacitor. Applying KVL around the loop, we may obtain the following equation:

$$v_S(t) = v_R(t) + v_C(t) \quad (11.48)$$

Observing that $i_R = i_C$, Eq. (11.48) may be combined with the defining equation for the capacitor (Eq. 4.6.6) to obtain

$$v_S(t) = Ri_C(t) + \frac{1}{C} \int_{-\infty}^t i_C dt \quad (11.49)$$

Equation (11.49) is an integral equation, which may be converted to the more familiar form of a differential equation by differentiating both sides of the equation, and recalling that

$$\frac{d}{dt} \left(\int_{-\infty}^t i_C dt \right) = i_C(t) \quad (11.50)$$

to obtain the following differential equation:

$$\frac{di_C}{dt} + \frac{1}{RC}i_C = \frac{1}{R} \frac{dv_S}{dt} \quad (11.51)$$

where the argument (t) has been dropped for ease of notation.

Observe that in Eq. (11.51), the independent variable is the series current flowing in the circuit, and that this is not the only equation that describes the series RC circuit. If, instead of applying KVL, for example, we had applied KCL at the node connecting the resistor to the capacitor, we would have obtained the following relationship:

$$i_R = \frac{v_S - v_C}{R} = i_C = C \frac{dv_C}{dt} \quad (11.52)$$

or

$$\frac{dv_C}{dt} + \frac{1}{RC}v_C = \frac{1}{RC}v_S \quad (11.53)$$

Note the similarity between Eqs. (11.51) and (11.53). The left-hand side of both equations is identical, except for the dependent variable, while the right-hand side takes a slightly different form. The solution of either equation is sufficient, however, to determine all voltages and currents in the circuit.

We can generalize the results above by observing that any circuit containing a single energy-storage element can be described by a differential equation of the form

$$a_1 \frac{dy(t)}{dt} + a_0(t) = F(t) \quad (11.54)$$

where $y(t)$ represents the capacitor voltage in the circuit of Fig. 11.48 and where the constants a_0 and a_1 consist of combinations of circuit element parameters. Equation (11.54) is a **first-order ordinary differential equation** with constant coefficients.

Consider now a circuit that contains two energy-storage elements, such as that shown in Fig. 11.49. Application of KVL results in the following equation:

$$Ri(t) + L \frac{di(t)}{dt} + \frac{1}{C} \int_{-\infty}^t i(t) dt = v_S(t) \quad (11.55)$$

Equation (11.55) is called an integro-differential equation because it contains both an integral and a derivative. This equation can be converted into a differential equation by differentiating both sides, to obtain:

$$R \frac{di(t)}{dt} + L \frac{d^2 i(t)}{dt^2} + \frac{1}{C} i(t) = \frac{dv_S(t)}{dt} \quad (11.56)$$

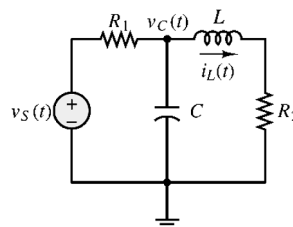

FIGURE 11.49 Second-order circuit.

or, equivalently, by observing that the current flowing in the series circuit is related to the capacitor voltage by $i(t) = Cdv_C/dt$, and that Eq. (11.55) can be rewritten as

$$RC \frac{dv_C}{dt} + LC \frac{d^2 v_C(t)}{dt^2} + v_C(t) = v_s(t) \quad (11.57)$$

Note that although different variables appear in the preceding differential equations, both Eqs. (11.55) and (11.57) can be rearranged to appear in the same general form as follows:

$$a_2 \frac{d^2 y(t)}{dt^2} + a_1 \frac{dy(t)}{dt} + a_0 y(t) = F(t) \quad (11.58)$$

where the general variable $y(t)$ represents either the series current of the circuit of Fig. 11.49 or the capacitor voltage. By analogy with Eq. (11.54), we call Eq. (11.58) a **second-order ordinary differential equation** with constant coefficients. As the number of energy-storage elements in a circuit increases, one can therefore expect that higher-order differential equations will result.

Phasors and Impedance

In this section, we introduce an efficient notation to make it possible to represent sinusoidal signals as *complex numbers*, and to eliminate the need for solving differential equations.

Phasors

Let us recall that it is possible to express a generalized sinusoid as the real part of a complex vector whose **argument**, or **angle**, is given by $(\omega t + \phi)$ and whose length, or **magnitude**, is equal to the peak amplitude of the sinusoid. The **complex phasor** corresponding to the sinusoidal signal $A \cos(\omega t + \phi)$ is therefore defined to be the complex number $Ae^{j\phi}$:

$$Ae^{j\phi} = \text{complex phasor notation for } A \cos(\omega t + \phi) \quad (11.59)$$

1. Any sinusoidal signal may be mathematically represented in one of two ways: a **time-domain form**

$$v(t) = A \cos(\omega t + \phi)$$

and a **frequency-domain** (or **phasor**) form

$$\mathbf{V}(j\omega) = Ae^{j\phi}$$

2. A phasor is a complex number, expressed in polar form, consisting of a *magnitude* equal to the peak amplitude of the sinusoidal signal and a *phase angle* equal to the phase shift of the sinusoidal signal *referenced to a cosine signal*.
3. When using phasor notation, it is important to make a note of the specific frequency, ω , of the sinusoidal signal, since this is not explicitly apparent in the phasor expression.

Impedance

We now analyze the i - v relationship of the three ideal circuit elements in light of the new phasor notation. The result will be a new formulation in which resistors, capacitors, and inductors will be described in the same notation. A direct consequence of this result will be that the circuit theorems of section 11.3 will be extended to AC circuits. In the context of AC circuits, any one of the three ideal circuit elements

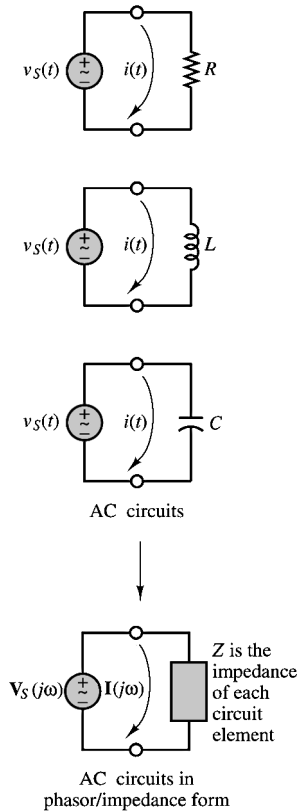

FIGURE 11.50 The impedance element.

defined so far will be described by a parameter called **impedance**, which may be viewed as a *complex resistance*. The impedance concept is equivalent to stating that capacitors and inductors act as *frequency-dependent resistors*, that is, as resistors whose resistance is a function of the frequency of the sinusoidal excitation. Figure 11.50 depicts the same circuit represented in conventional form (top) and in phasor-impedance form (bottom); the latter representation explicitly shows phasor voltages and currents and treats the circuit element as a generalized “impedance.” It will presently be shown that each of the three ideal circuit elements may be represented by one such impedance element.

Let the source voltage in the circuit of Fig. 11.50 be defined by

$$v_S(t) = A \cos \omega t \quad \text{or} \quad \mathbf{V}_S(j\omega) = A e^{j0^\circ} \quad (11.60)$$

without loss of generality. Then the current $i(t)$ is defined by the i - v relationship for each circuit element. Let us examine the frequency-dependent properties of the resistor, inductor, and capacitor, one at a time.

The *impedance* of the resistor is defined as the ratio of the phasor voltage across the resistor to the phasor current flowing through it, and the symbol Z_R is used to denote it:

$$Z_R(j\omega) = \frac{\mathbf{V}_S(j\omega)}{\mathbf{I}(j\omega)} = R \quad (11.61)$$

The impedance of the inductor is defined as follows:

$$Z_L(j\omega) = \frac{\mathbf{V}_S(j\omega)}{\mathbf{I}(j\omega)} = \omega L e^{j90^\circ} = j\omega L \quad (11.62)$$

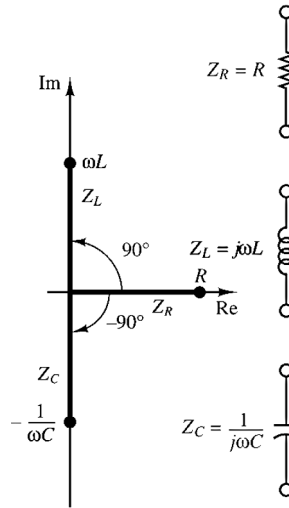

FIGURE 11.51 Impedances of R , L , and C in the complex plane.

Note that the inductor now appears to behave like a *complex frequency-dependent resistor*, and that the magnitude of this complex resistor, ωL , is proportional to the signal frequency, ω . Thus, an inductor will “impede” current flow in proportion to the sinusoidal frequency of the source signal. This means that at low signal frequencies, an inductor acts somewhat like a short circuit, while at high frequencies it tends to behave more as an open circuit. Another important point is that *the magnitude of the impedance of an inductor is always positive*, since both L and ω are positive numbers. You should verify that the units of this magnitude are also ohms.

The impedance of the ideal capacitor, $Z_C(j\omega)$, is therefore defined as follows:

$$Z_C(j\omega) = \frac{\mathbf{V}_s(j\omega)}{\mathbf{I}(j\omega)} = \frac{1}{\omega C} e^{-j90^\circ} = \frac{-j}{\omega C} = \frac{1}{j\omega C} \quad (11.63)$$

where we have used the fact that $1/j = e^{-j90^\circ} = -j$. Thus, the impedance of a capacitor is also a frequency-dependent complex quantity, with the impedance of the capacitor varying as an inverse function of frequency, and so a capacitor acts like a short circuit at high frequencies, whereas it behaves more like an open circuit at low frequencies. Another important point is that *the impedance of a capacitor is always negative*, since both C and ω are positive numbers. You should verify that the units of impedance for a capacitor are ohms. [Figure 11.51](#) depicts $Z_C(j\omega)$ in the complex plane, alongside $Z_R(j\omega)$ and $Z_L(j\omega)$.

The impedance parameter defined in this section is extremely useful in solving AC circuit analysis problems, because it will make it possible to take advantage of most of the network theorems developed for DC circuits by replacing resistances with complex-valued impedances. In its most general form, the impedance of a circuit element is defined as the sum of a real part and an imaginary part:

$$Z(j\omega) = R(j\omega) + jX(j\omega) \quad (11.64)$$

where R is called the **AC resistance** and X is called the **reactance**. The frequency dependence of R and X has been indicated explicitly, since it is possible for a circuit to have a frequency-dependent resistance. The examples illustrate how a complex impedance containing both real and imaginary parts arises in a circuit.

Example 11.4 Capacitive Displacement Transducer

In [Example 11.3](#), the idea of a capacitive displacement transducer was introduced when we considered a parallel-plate capacitor composed of a fixed plate and a movable plate. The capacitance of this variable capacitor was shown to be a *nonlinear* function of the position of the movable plate, x (see [Fig. 11.39](#)).

In this example, we show that under certain conditions the impedance of the capacitor varies as a *linear* function of displacement—that is, the movable-plate capacitor can serve as a linear transducer.

Recall the expression derived in [Example 11.3](#):

$$C = \frac{8.854 \times 10^{-3} A}{x}$$

where C is the capacitance in picofarad, A is the area of the plates in square millimeter, and x is the (variable) distance in millimeter. If the capacitor is placed in an AC circuit, its impedance will be determined by the expression

$$Z_C = \frac{1}{j\omega C}$$

so that

$$Z_C = \frac{x}{8.854 j\omega A}$$

Thus, at a fixed frequency ω , the impedance of the capacitor will vary linearly with displacement. This property may be exploited in the bridge circuit of [Example 11.3](#), where a differential pressure transducer was shown as being made of two movable-plate capacitors, such that if the capacitance of one increased as a consequence of a pressure differential across the transducer, the capacitance of the other had to decrease by a corresponding amount (at least for small displacements). The circuit is shown again in [Fig. 11.52](#) where two resistors have been connected in the bridge along with the variable capacitors (denoted by $C(x)$). The bridge is excited by a sinusoidal source.

Using phasor notation, we can express the output voltage as follows:

$$\mathbf{V}_{\text{out}}(j\omega) = \mathbf{V}_s(j\omega) \left(\frac{Z_{C_{bc}(x)}}{Z_{C_{db}(x)} + Z_{C_{bc}(x)}} - \frac{R_2}{R_1 + R_2} \right)$$

If the nominal capacitance of each movable-plate capacitor with the diaphragm in the center position is given by

$$C = \frac{\epsilon A}{d}$$

where d is the nominal (undisplaced) separation between the diaphragm and the fixed surfaces of the capacitors (in mm), the capacitors will see a change in capacitance given by

$$C_{db} = \frac{\epsilon A}{d - x} \quad \text{and} \quad C_{bc} = \frac{\epsilon A}{d + x}$$

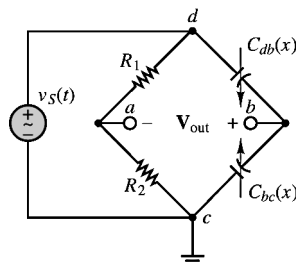

FIGURE 11.52 Bridge circuit for capacitive displacement transducer.

when a pressure differential exists across the transducer, so that the impedances of the variable capacitors change according to the displacement

$$Z_{C_{db}} = \frac{d-x}{8.854 j\omega A} \quad \text{and} \quad Z_{C_{bc}} = \frac{d+x}{8.854 j\omega A}$$

and we obtain the following expression for the phasor output voltage, if we choose $R_1 = R_2$.

$$\begin{aligned} \mathbf{V}_{\text{out}}(j\omega) &= \mathbf{V}_s(j\omega) \left(\frac{\frac{d+x}{8.854 j\omega A}}{\frac{d-x}{8.854 j\omega A} + \frac{d+x}{8.854 j\omega A}} - \frac{R_2}{R_1 + R_2} \right) \\ &= \mathbf{V}_s(j\omega) \left(\frac{1}{2} + \frac{x}{2d} - \frac{R_2}{R_1 + R_2} \right) \\ &= \mathbf{V}_s(j\omega) \frac{x}{2d} \end{aligned}$$

Thus, the output voltage will vary as a scaled version of the input voltage in proportion to the displacement.

References

- Irwin, J.D., 1989. *Basic Engineering Circuit Analysis*, 3rd ed., Macmillan, New York.
- Nilsson, J.W., 1989. *Electric Circuits*, 3rd ed., Addison-Wesley, Reading, MA.
- Rizzoni, G., 2000. *Principles and Applications of Electrical Engineering*, 3rd ed., McGraw-Hill, Burr Ridge, IL.
- Smith, R.J. and Dorf, R.C., 1992. *Circuits, Devices and Systems*, 5th ed., John Wiley & Sons, New York.
1993. *The Electrical Engineering Handbook*, CRC Press, Boca Raton, FL.
- Budak, A., *Passive and Active Network Analysis and Synthesis*, Houghton Mifflin, Boston.
- Van Valkenburg, M.E., 1982, *Analog Filter Design*, Holt, Rinehart & Winston, New York.

12

Engineering Thermodynamics

- 12.1 Fundamentals
Basic Concepts and Definitions • Laws of Thermodynamics
- 12.2 Extensive Property Balances
Mass Balance • Energy Balance • Entropy Balance • Control
Volumes at Steady State • Exergy Balance
- 12.3 Property Relations and Data
- 12.4 Vapor and Gas Power Cycles

Michael J. Moran
The Ohio State University

Although various aspects of what is now known as thermodynamics have been of interest since antiquity, formal study began only in the early nineteenth century through consideration of the motive power of heat: the capacity of hot bodies to produce work. Today the scope is larger, dealing generally with energy and entropy, and with relationships among the properties of matter. Moreover, in the past 25 years engineering thermodynamics has undergone a revolution, both in terms of the presentation of fundamentals and in the manner that it is applied. In particular, the second law of thermodynamics has emerged as an effective tool for engineering analysis and design.

12.1 Fundamentals

Classical thermodynamics is concerned primarily with the macrostructure of matter. It addresses the gross characteristics of large aggregations of molecules and not the behavior of individual molecules. The microstructure of matter is studied in kinetic theory and statistical mechanics (including quantum thermodynamics). In this chapter, the classical approach to thermodynamics is featured.

Basic Concepts and Definitions

Thermodynamics is both a branch of physics and an engineering science. The scientist is normally interested in gaining a fundamental understanding of the physical and chemical behavior of fixed, quiescent quantities of matter and uses the principles of thermodynamics to relate the properties of matter. Engineers are generally interested in studying systems and how they interact with their surroundings. To facilitate this, engineers have extended the subject of thermodynamics to the study of systems through which matter flows.

System

In a thermodynamic analysis, the *system* is the subject of the investigation. Normally the system is a specified quantity of matter and/or a region that can be separated from everything else by a well-defined surface. The defining surface is known as the *control surface* or *system boundary*. The control surface may be movable or fixed. Everything external to the system is the *surroundings*. A system of fixed mass is

referred to as a *control mass* or *closed system*. When there is flow of mass through the control surface, the system is called a *control volume* or *open system*. An *isolated system* is a closed system that does not interact in any way with its surroundings.

State, Property

The condition of a system at any instant of time is called its *state*. The state at a given instant of time is described by the properties of the system. A *property* is any quantity whose numerical value depends on the state, but not the history of the system. The value of a property is determined in principle by some type of physical operation or test.

Extensive properties depend on the size or extent of the system. Volume, mass, energy, entropy, and exergy are examples of extensive properties. An extensive property is additive in the sense that its value for the whole system equals the sum of the values for its parts. *Intensive* properties are independent of the size or extent of the system. Pressure and temperature are examples of intensive properties.

Process, Cycle

Two states are identical if, and only if, the properties of the two states are identical. When any property of a system changes in value there is a change in state, and the system is said to undergo a *process*. When a system in a given initial state goes through a sequence of processes and finally returns to its initial state, it is said to have undergone a *thermodynamic cycle*.

Phase and Pure Substance

The term *phase* refers to a quantity of matter that is homogeneous throughout in both chemical composition and physical structure. Homogeneity in physical structure means that the matter is all *solid*, or all *liquid*, or all *vapor* (or equivalently all *gas*). A system can contain one or more phases. For example, a system of liquid water and water vapor (steam) contains two phases. A *pure substance* is one that is uniform and invariable in chemical composition. A pure substance can exist in more than one phase, but its chemical composition must be the same in each phase. For example, if liquid water and water vapor form a system with two phases, the system can be regarded as a pure substance because each phase has the same composition. The nature of phases that coexist in equilibrium is addressed by the *phase rule* (for discussion see Moran and Shapiro, 2000).

Equilibrium

Equilibrium means a condition of balance. In thermodynamics the concept includes not only a balance of forces, but also a balance of other influences. Each kind of influence refers to a particular aspect of thermodynamic (complete) equilibrium. *Thermal* equilibrium refers to an equality of temperature, *mechanical* equilibrium to an equality of pressure, and *phase* equilibrium to an equality of chemical potentials (for discussion see Moran and Shapiro, 2000). *Chemical* equilibrium is also established in terms of chemical potentials. For complete equilibrium the several types of equilibrium must exist individually.

Temperature

A scale of temperature independent of the thermometric substance is called a *thermodynamic temperature scale*. The Kelvin scale, a thermodynamic scale, can be elicited from the second law of thermodynamics. The definition of temperature following from the second law is valid over all temperature ranges and provides an essential connection between the several *empirical* measures of temperature. In particular, temperatures evaluated using a *constant-volume gas thermometer* are identical to those of the Kelvin scale over the range of temperatures where gas thermometry can be used. On the Kelvin scale the unit is the kelvin (K).

The Celsius temperature scale (also called the centigrade scale) uses the degree Celsius ($^{\circ}\text{C}$), which has the same magnitude as the kelvin. Thus, temperature differences are identical on both scales. However, the zero point on the Celsius scale is shifted to 273.15 K, the *triple point* of water (Fig. 12.1b),

as shown by the following relationship between the Celsius temperature and the Kelvin temperature:

$$T(^{\circ}\text{C}) = T(\text{K}) - 273.15 \quad (12.1)$$

Two other temperature scales are commonly used in engineering in the U.S. By definition, the *Rankine scale*, the unit of which is the degree rankine ($^{\circ}\text{R}$), is proportional to the Kelvin temperature according to

$$T(^{\circ}\text{R}) = 1.8T(\text{K}) \quad (12.2)$$

The Rankine scale is also an absolute thermodynamic scale with an absolute zero that coincides with the absolute zero of the Kelvin scale. In thermodynamic relationships, temperature is always in terms of the Kelvin or Rankine scale unless specifically stated otherwise.

A degree of the same size as that on the Rankine scale is used in the *Fahrenheit scale*, but the zero point is shifted according to the relation

$$T(^{\circ}\text{F}) = T(^{\circ}\text{R}) - 459.67 \quad (12.3)$$

Substituting Eqs. (12.1) and (12.2) into Eq. (12.3) gives

$$T(^{\circ}\text{F}) = 1.8T(^{\circ}\text{C}) + 32 \quad (12.4)$$

This equation shows that the Fahrenheit temperature of the *ice point* (0°C) is 32°F and of the *steam point* (100°C) is 212°F . The 100 Celsius or Kelvin degrees between the ice point and steam point corresponds to 180 Fahrenheit or Rankine degrees.

To provide a standard for temperature measurement taking into account both theoretical and practical considerations, the International Temperature Scale of 1990 (ITS-90) is defined in such a way that the temperature measured on it conforms with the thermodynamic temperature, the unit of which is the kelvin, to within the limits of accuracy of measurement obtainable in 1990. Further discussion of ITS-90 is provided by Preston-Thomas (1990).

Irreversibilities

A process is said to be *reversible* if it is possible for its effects to be eradicated in the sense that there is some way by which both the system and its surroundings can be exactly restored to their respective initial states. A process is *irreversible* if both the system and surroundings cannot be restored to their initial states. There are many effects whose presence during a process renders it irreversible. These include, but are not limited to, the following: heat transfer through a finite temperature difference; unrestrained expansion of a gas or liquid to a lower pressure; spontaneous chemical reaction; mixing of matter at different compositions or states; friction (sliding friction as well as friction in the flow of fluids); electric current flow through a resistance; magnetization or polarization with hysteresis; and inelastic deformation. The term *irreversibility* is used to identify effects such as these.

Irreversibilities can be divided into two classes, *internal* and *external*. Internal irreversibilities are those that occur within the system, while external irreversibilities are those that occur within the surroundings, normally the immediate surroundings. As this division depends on the location of the boundary there is some arbitrariness in the classification (by locating the boundary to take in the immediate surroundings, all irreversibilities are internal). Nonetheless, valuable insights can result when this distinction between irreversibilities is made. When internal irreversibilities are absent during a process, the process is said to be *internally reversible*. At every intermediate state of an internally reversible process of a closed system, all intensive properties are uniform throughout each phase present: the temperature, pressure, specific volume, and other intensive properties do not vary with position.

Laws of Thermodynamics

The first steps in a thermodynamic analysis are definition of the system and identification of the relevant interactions with the surroundings. Attention then turns to the pertinent physical laws and relationships that allow the behavior of the system to be described in terms of an engineering model, which is a simplified representation of system behavior that is sufficiently faithful for the purpose of the analysis, even if features exhibited by the actual system are ignored.

Thermodynamic analyses of control volumes and closed systems typically use, directly or indirectly, one or more of three basic laws. The laws, which are independent of the particular substance or substances under consideration, are

- the conservation of mass principle,
- the conservation of energy principle,
- the second law of thermodynamics.

The second law may be expressed in terms of entropy or exergy.

The laws of thermodynamics must be supplemented by appropriate thermodynamic property data. For some applications a momentum equation expressing Newton's second law of motion also is required. Data for transport properties, heat transfer coefficients, and friction factors often are needed for a comprehensive engineering analysis. Principles of engineering economics and pertinent economic data also can play prominent roles.

12.2 Extensive Property Balances

The laws of thermodynamics can be expressed in terms of *extensive property balances* for mass, energy, entropy, and exergy. Engineering applications are generally analyzed on a control volume basis. Accordingly, the control volume formulations of the mass energy, entropy, and exergy balances are featured here. They are provided in the form of overall balances assuming one-dimensional flow. Equations of change for mass, energy, and entropy in the form of differential equations are also available in the literature (Bird et al., 1960).

Mass Balance

For applications in which inward and outward flows occur, each through one or more ports, the extensive property balance expressing the conservation of mass principle takes the form

$$\frac{dm}{dt} = \sum_i \dot{m}_i - \sum_e \dot{m}_e \quad (12.5)$$

where dm/dt represents the time rate of change of mass contained within the control volume, \dot{m}_i denotes the mass flow rate at an inlet port, and \dot{m}_e denotes the mass flow rate at an exit port.

The volumetric flow rate through a portion of the control surface with area dA is the product of the velocity component normal to the area, v_n , times the area: $v_n dA$. The mass flow rate through dA is $\rho(v_n dA)$, where ρ denotes density. The mass rate of flow through a port of area A is then found by integration over the area

$$\dot{m} = \int_A \rho v_n dA$$

For one-dimensional flow the intensive properties are uniform with position over area A , and the last equation becomes

$$\dot{m} = \rho v A = \frac{vA}{v} \quad (12.6)$$

where ν denotes the specific volume (the reciprocal of density) and the subscript n has been dropped from velocity for simplicity.

Energy Balance

Energy is a fundamental concept of thermodynamics and one of the most significant aspects of engineering analysis. Energy can be stored within systems in various macroscopic forms: kinetic energy, gravitational potential energy, and internal energy. Energy also can be transformed from one form to another and transferred between systems. Energy can be transferred by work, by heat transfer, and by flowing matter. The total amount of energy is conserved in all transformations and transfers. The extensive property balance expressing the conservation of energy principle takes the form

$$\frac{d(U + \text{KE} + \text{PE})}{dt} = \dot{Q} - \dot{W} + \sum_i \dot{m}_i \left(h_i + \frac{v_i^2}{2} + gz_i \right) - \sum_e \dot{m}_e \left(h_e + \frac{v_e^2}{2} + gz_e \right) \quad (12.7a)$$

where U , KE, and PE denote, respectively, the internal energy, kinetic energy, and gravitational potential energy of the overall control volume.

The right side of Eq. (12.7a) accounts for transfers of energy across the boundary of the control volume. Energy can enter and exit control volumes by work. Because work is done on or by a control volume when matter flows across the boundary, it is convenient to separate the work rate (or power) into two contributions. One contribution is the work rate associated with the force of the fluid pressure as mass is introduced at the inlet and removed at the exit. Commonly referred to as *flow work*, this contribution is accounted for by $\dot{m}_i(p_i \nu_i)$ and $\dot{m}_e(p_e \nu_e)$, respectively, where p denotes pressure and ν denotes specific volume. The other contribution, denoted by \dot{W} in Eq. (12.7a), includes all other work effects, such as those associated with rotating shafts, displacement of the boundary, and electrical effects. \dot{W} is considered *positive* for energy transfer *from* the control volume.

Energy also can enter and exit control volumes with flowing streams of matter. On a one-dimensional flow basis, the rate at which energy enters with matter at inlet i is $\dot{m}_i(u_i + v_i^2/2 + gz_i)$, where the three terms in parentheses account, respectively, for the specific internal energy, specific kinetic energy, and specific gravitational potential energy of the substance flowing through port i . In writing Eq. (12.7a) the sum of the specific internal energy and specific flow work at each inlet and exit is expressed in terms of the specific enthalpy $h(=u + p\nu)$. Finally, \dot{Q} accounts for the rate of energy transfer by heat and is considered *positive* for energy transfer *to* the control volume.

By dropping the terms of Eq. (12.7a) involving mass flow rates an energy rate balance for closed systems is obtained. In principle the closed system energy rate balance can be integrated for a process between two states to give the closed system energy balance:

$$(U_2 - U_1) + (\text{KE}_2 - \text{KE}_1) + (\text{PE}_2 - \text{PE}_1) = Q - W \quad (12.7b)$$

(closed systems)

where 1 and 2 denote the end states. Q and W denote the *amounts* of energy transferred by heat and work during the process, respectively.

Entropy Balance

Contemporary applications of engineering thermodynamics express the second law, alternatively, as an entropy balance or an exergy balance. The entropy balance is considered here.

Like mass and energy, entropy can be stored within systems and transferred across system boundaries. However, unlike mass and energy, entropy is not conserved, but generated (or produced) by *irreversibilities*

within systems. A control volume form of the extensive property balance for entropy is

$$\frac{dS}{dt} = \underbrace{\sum_j \frac{\dot{Q}_j}{T_j} + \sum_i \dot{m}_i s_i}_{\text{rates of entropy transfer}} - \underbrace{\sum_e \dot{m}_e s_e + \dot{S}_{\text{gen}}}_{\text{rate of entropy generation}} \quad (12.8)$$

where dS/dt represents the time rate of change of entropy within the control volume. The terms $\dot{m}_i s_i$ and $\dot{m}_e s_e$ account, respectively, for rates of entropy transfer into and out of the control volume accompanying mass flow. \dot{Q}_j represents the time rate of heat transfer at the location on the boundary where the instantaneous temperature is T_j , and \dot{Q}_j/T_j accounts for the accompanying rate of entropy transfer. \dot{S}_{gen} denotes the time rate of entropy generation due to irreversibilities within the control volume. An entropy rate balance for closed systems is obtained by dropping the terms of Eq. (12.8) involving mass flow rates.

When applying the entropy balance in any of its forms, the objective is often to evaluate the entropy generation term. However, the value of the entropy generation for a given process of a system usually does not have much significance by itself. The significance normally is determined through comparison: the entropy generation within a given component would be compared with the entropy generation values of the other components included in an overall system formed by these components. This allows the principal contributors to the irreversibility of the overall system to be pinpointed.

Control Volumes at Steady State

Engineering systems are often idealized as being at *steady state*, meaning that all properties are unchanging in time. For a control volume at steady state, the identity of the matter within the control volume changes continuously, but the total amount of mass remains constant. At steady state, the mass rate balance Eq. (12.5) reduces to

$$\sum_i \dot{m}_i = \sum_e \dot{m}_e \quad (12.9a)$$

At steady state, the energy rate balance Eq. (12.7a) becomes

$$0 = \dot{Q} - \dot{W} + \sum_i \dot{m}_i \left(h_i + \frac{v_i^2}{2} + gz_i \right) - \sum_e \dot{m}_e \left(h_e + \frac{v_e^2}{2} + gz_e \right) \quad (12.9b)$$

At steady state, the entropy rate balance Eq. (12.8) reads

$$0 = \sum_j \frac{\dot{Q}_j}{T_j} + \sum_i \dot{m}_i s_i - \sum_e \dot{m}_e s_e + \dot{S}_{\text{gen}} \quad (12.9c)$$

Mass and energy are conserved quantities, but entropy is not generally conserved. Equation (12.9a) indicates that the total rate of mass flow into the control volume equals the total rate of mass flow out of the control volume. Similarly, Eq. (12.9b) states that the total rate of energy transfer into the control volume equals the total rate of energy transfer out of the control volume. However, Eq. (12.9c) shows that the rate at which entropy is transferred out exceeds the rate at which entropy enters, the difference being the rate of entropy generation within the control volume owing to irreversibilities.

Many applications involve control volumes having a single inlet and a single exit. For such cases the mass rate balance, Eq. (12.9a), reduces to $\dot{m}_i = \dot{m}_e$. Denoting the common mass flow rate by \dot{m} ,

Eqs. (12.9b) and (12.9c) give, respectively,

$$0 = \dot{Q} - \dot{W} + \dot{m} \left[(h_i - h_e) + \left(\frac{v_i^2 - v_e^2}{2} \right) + g(z_i - z_e) \right] \quad (12.10a)$$

$$0 = \frac{\dot{Q}}{T_b} + \dot{m}(s_i - s_e) + \dot{S}_{\text{gen}} \quad (12.11a)$$

where for simplicity T_b denotes the temperature, or a suitable average temperature, on the boundary where heat transfer occurs.

When energy and entropy rate balances are applied to particular cases of interest, additional simplifications are usually made. The heat transfer term \dot{Q} is dropped when it is insignificant relative to other energy transfers across the boundary. This may be the result of one or more of the following: (1) the outer surface of the control volume is insulated; (2) the outer surface area is too small for there to be effective heat transfer; (3) the temperature difference between the control volume and its surroundings is small enough that the heat transfer can be ignored; (4) the gas or liquid passes through the control volume so quickly that there is not enough time for significant heat transfer to occur. The work term \dot{W} drops out of the energy rate balance when there are no rotating shafts, displacements of the boundary, electrical effects, or other work mechanisms associated with the control volume being considered. The effects of kinetic and potential energy are frequently negligible relative to other terms of the energy rate balance.

The special forms of Eqs. (12.10a) and (12.11a) listed in Table 12.1 are obtained as follows: When there is no heat transfer, Eq. (12.11a) gives

$$s_e - s_i = \frac{\dot{S}_{\text{gen}}}{\dot{m}} \geq 0 \quad (12.11b)$$

(no heat transfer)

Accordingly, when irreversibilities are present within the control volume, the specific entropy increases as mass flows from inlet to outlet. In the *ideal* case in which no internal irreversibilities are present, mass passes through the control volume with no change in its entropy—that is, *isentropically*.

For no heat transfer, Eq. (12.10a) gives

$$\dot{W} = \dot{m} \left[(h_i - h_e) + \left(\frac{v_i^2 - v_e^2}{2} \right) + g(z_i - z_e) \right] \quad (12.10b)$$

(no heat transfer)

A special form that is applicable, at least approximately, to compressors, pumps, and turbines results from dropping the kinetic and potential energy terms of Eq. (12.10b), leaving

$$\dot{W} = \dot{m}(h_i - h_e) \quad (12.10c)$$

(compressors, pumps, and turbines)

In *throttling devices* a significant reduction in pressure is achieved by introducing a restriction into a line through which a gas or liquid flows. For such devices $\dot{W} = 0$ and Eq. (12.10c) reduces further to read

$$h_i \cong h_e \quad (12.10d)$$

(throttling process)

That is, upstream and downstream of the throttling device, the specific enthalpies are equal.

TABLE 12.1 Energy and Entropy Balances for One-Inlet, One-Outlet Control Volumes at Steady State and No Heat Transfer

Energy balance

$$\dot{W} = \dot{m} \left[(h_i - h_e) + \left(\frac{v_i^2 - v_e^2}{2} \right) + g(z_i - z_e) \right] \quad (12.10b)$$

Compressors, pumps, and turbines^a

$$\dot{W} = \dot{m}(h_i - h_e) \quad (12.10c)$$

Throttling

$$h_e \cong h_i \quad (12.10d)$$

Nozzles, diffusers^b

$$v_e = \sqrt{v_i^2 + 2(h_i - h_e)} \quad (12.10e)$$

Entropy balance

$$s_e - s_i = \frac{\dot{S}_{\text{gen}}}{\dot{m}} \geq 0 \quad (12.11b)$$

^a For an ideal gas with constant c_p , Eq. (1') of Table 12.4 allows Eq. (12.10c) to be written as

$$\dot{W} = \dot{m}c_p(T_i - T_e) \quad (12.10c')$$

The power developed in an *isentropic process* is obtained with Eq. (5') of Table 12.4 as

$$\dot{W} = \dot{m}c_p T_i [1 - (p_e/p_i)^{(k-1)/k}] \quad (s = c) \quad (12.10c'')$$

where $c_p = kR/(k-1)$.

^b For an ideal gas with constant c_p , Eq. (1') of Table 12.4 allows Eq. (12.10e) to be written as

$$v_e = \sqrt{v_i^2 + 2c_p(T_i - T_e)} \quad (12.10e')$$

The exit velocity for an *isentropic process* is obtained with Eq. (5') of Table 12.4 as

$$v_e = \sqrt{v_i^2 + 2c_p T_i [1 - (p_e/p_i)^{(k-1)/k}]} \quad (s = c) \quad (12.10e'')$$

where $c_p = kR/(k-1)$.

A *nozzle* is a flow passage of varying cross-sectional area in which the velocity of a gas or liquid increases in the direction of flow. In a *diffuser*, the gas or liquid decelerates in the direction of flow. For such devices, $\dot{W} = 0$. The heat transfer and potential energy change are generally negligible. Then Eq. (12.10b) reduces to

$$0 = h_i - h_e + \frac{v_i^2 - v_e^2}{2}$$

Solving for the exit velocity

$$v_e = \sqrt{v_i^2 + 2(h_i - h_e)} \quad (12.10e)$$

(nozzle, diffuser)

The steady-state forms of the mass, energy, and entropy rate balances can be applied to control volumes with multiple inlets and/or exits, for example, cases involving heat-recovery steam generators, feedwater heaters, and counterflow and crossflow heat exchangers. Transient (or unsteady) analyses can be conducted with Eqs. (12.5), (12.7a), and (12.8). Illustrations of all such applications are provided by Moran and Shapiro (2000).

Exergy Balance

Exergy provides an alternative to entropy for applying the second law. When exergy concepts are combined with principles of engineering economy, the result is known as *thermoeconomics*. Thermoeconomics allows the real cost sources to be identified: capital investment costs, operating and maintenance costs, and the costs associated with the destruction and loss of exergy. Optimization of systems can be achieved by a careful consideration of such cost sources. From this perspective thermoeconomics is *exergy-aided cost minimization*. Discussions of exergy analysis and thermoeconomics are provided by Moran (1989), Bejan et al. (1996), Moran and Tsatsaronis (2000), and Moran and Shapiro (2000). In this section salient aspects are presented.

Defining Exergy

An opportunity for doing work exists whenever two systems at different states are placed in communication because, in principle, work can be developed as the two are allowed to come into equilibrium. When one of the two systems is a suitably idealized system called an *environment* and the other is some system of interest, *exergy* is the maximum theoretical useful work (shaft work or electrical work) obtainable as the system of interest and environment interact to equilibrium, heat transfer occurring with the environment only. (Alternatively, exergy is the minimum theoretical useful work required to form a quantity of matter from substances present in the environment and bring the matter to a specified state.) Exergy is a measure of the *departure* of the state of the system from that of the environment, and is therefore an attribute of the system and environment together. Once the environment is specified, however, a value can be assigned to exergy in terms of property values for the system only, so exergy can be regarded as an extensive property of the system. Exergy can be destroyed and, like entropy, generally is not conserved.

Models with various levels of specificity are employed for describing the environment used to evaluate exergy. Models of the environment typically refer to some portion of a system's surroundings, the intensive properties of each phase of which are uniform and do not change significantly as a result of any process under consideration. The environment is regarded as composed of common substances existing in abundance within the Earth's atmosphere, oceans, and crust. The substances are in their stable forms as they exist naturally, and there is no possibility of developing work from interactions—physical or chemical—between parts of the environment. Although the intensive properties of the environment are assumed to be unchanging, the extensive properties can change as a result of interactions with other systems. Kinetic and potential energies are evaluated relative to coordinates in the environment, all parts of which are considered to be at rest with respect to one another. For computational ease, the temperature T_0 and pressure p_0 of the environment are often taken as typical ambient values, such as 1 atm and 25°C (77°F). However, these properties may be specified differently depending on the application.

When a system is in equilibrium with the environment, the state of the system is called the *dead state*. At the dead state, the conditions of mechanical, thermal, and chemical equilibrium between the system and the environment are satisfied: the pressure, temperature, and chemical potentials of the system equal those of the environment, respectively. In addition, the system has no motion or elevation relative to coordinates in the environment. Under these conditions, there is no possibility of a spontaneous change within the system or the environment, nor can there be an interaction between them. The value of exergy is zero. Another type of equilibrium between the system and environment can be identified. This is a restricted form of equilibrium where only the conditions of mechanical and thermal equilibrium must be satisfied. This state of the system is called the *restricted dead state*. At the restricted dead state, the fixed quantity of matter under consideration is imagined to be sealed in an envelope impervious to mass flow, at zero velocity and elevation relative to coordinates in the environment, and at the temperature T_0 and pressure p_0 .

Exergy Transfer and Exergy Destruction

Exergy can be transferred by three means: exergy transfer associated with work, exergy transfer associated with heat transfer, and exergy transfer associated with the matter entering and exiting a control volume. All such exergy transfers are evaluated relative to the environment used to define exergy. Exergy also is

destroyed by irreversibilities within the system or control volume. Exergy balances can be written in various forms, depending on whether a closed system or control volume is under consideration and whether steady-state or transient operation is of interest. Owing to its importance for a wide range of applications, an exergy rate balance for control volumes at steady state is presented alternatively as Eqs. (12.12a) and (12.12b).

$$0 = \underbrace{\sum_j \dot{E}_{q,j} - \dot{W}}_{\text{rates of exergy transfer}} - \underbrace{\sum_i \dot{E}_i - \sum_e \dot{E}_e - \dot{E}_D}_{\text{rate of exergy destruction}} \quad (12.12a)$$

$$0 = \sum_j \left(1 - \frac{T_0}{T_j}\right) \dot{Q}_j - \dot{W} + \sum_i \dot{m}_i e_i - \sum_e \dot{m}_e e_e - \dot{E}_D \quad (12.12b)$$

\dot{W} has the same significance as in Eq. (12.7a): the work rate excluding the flow work. \dot{Q}_j is the time rate of heat transfer at the location on the boundary of the control volume where the instantaneous temperature is T_j . The associated rate of exergy transfer is

$$\dot{E}_{q,j} = \left(1 - \frac{T_0}{T_j}\right) \dot{Q}_j \quad (12.13)$$

As for other control volume rate balances, the subscripts i and e denote inlets and exits, respectively. The exergy transfer rates at control volume inlets and exits are denoted, respectively, as $\dot{E}_i = \dot{m}_i e_i$ and $\dot{E}_e = \dot{m}_e e_e$. Finally, \dot{E}_D accounts for the time rate of exergy destruction due to irreversibilities within the control volume. The exergy destruction rate is related to the entropy generation rate by

$$\dot{E}_D = T_0 \dot{S}_{\text{gen}} \quad (12.14)$$

The specific exergy transfer terms e_i and e_e are expressible in terms of four components: physical exergy e^{PH} , kinetic exergy e^{KN} , potential exergy e^{PT} , and chemical exergy e^{CH} :

$$e = e^{\text{PH}} + e^{\text{KN}} + e^{\text{PT}} + e^{\text{CH}} \quad (12.15a)$$

The first three components are evaluated as follows:

$$e^{\text{PH}} = (h - h_0) - T_0(s - s_0) \quad (12.15b)$$

$$e^{\text{KN}} = \frac{1}{2} v^2 \quad (12.15c)$$

$$e^{\text{PT}} = gz \quad (12.15d)$$

In Eq. (12.15b), h_0 and s_0 denote, respectively, the specific enthalpy and specific entropy at the restricted dead state. In Eqs. (12.15c) and (12.15d), v and z denote velocity and elevation relative to coordinates in the environment, respectively.

To evaluate the chemical exergy (the exergy component associated with the departure of the chemical composition of a system from that of the environment), alternative models of the environment can be employed depending on the application; see for example Moran (1989) and Kotas (1995). Exergy analysis is facilitated, however, by employing a *standard environment* and a corresponding table of *standard*

chemical exergies. Standard chemical exergies are based on standard values of the environmental temperature T_0 and pressure p_0 — for example, 298.15 K (25°C) and 1 atm, respectively. Standard environments also include a set of reference substances with standard concentrations reflecting as closely as possible the chemical makeup of the natural environment. Standard chemical exergy data is provided by Szargut et al. (1988), Bejan et al. (1996), and Moran and Shapiro (2000).

Guidelines for Improving Thermodynamic Effectiveness

To improve thermodynamic effectiveness it is necessary to deal directly with inefficiencies related to exergy destruction and exergy loss. The primary contributors to exergy destruction are chemical reaction, heat transfer, mixing, and friction, including unrestrained expansions of gases and liquids. To deal with them effectively, the principal sources of inefficiency not only should be understood qualitatively, but also determined quantitatively, at least approximately. Design changes to improve effectiveness must be done judiciously, however, for the cost associated with different sources of inefficiency can be different. For example, the unit cost of the electrical or mechanical power required to provide for the exergy destroyed owing to a pressure drop is generally higher than the unit cost of the fuel required for the exergy destruction caused by combustion or heat transfer.

Chemical reaction is a significant source of thermodynamic inefficiency. Accordingly, it is generally good practice to minimize the use of combustion. In many applications the use of combustion equipment such as boilers is unavoidable, however. In these cases a significant reduction in the combustion irreversibility by conventional means simply cannot be expected, for the major part of the exergy destruction introduced by combustion is an inevitable consequence of incorporating such equipment. Still, the exergy destruction in practical combustion systems can be reduced by minimizing the use of excess air and by preheating the reactants. In most cases only a small part of the exergy destruction in a combustion chamber can be avoided by these means. Consequently, after considering such options for reducing the exergy destruction related to combustion, efforts to improve thermodynamic performance should focus on components of the overall system that are more amenable to betterment by cost-effective measures. In other words, some exergy destructions and energy losses can be avoided, others cannot. Efforts should be centered on those that can be avoided.

Nonidealities associated with heat transfer also typically contribute heavily to inefficiency. Accordingly, unnecessary or cost-ineffective heat transfer must be avoided. Additional guidelines follow:

- The higher the temperature T at which a heat transfer occurs in cases where $T > T_0$, where T_0 denotes the temperature of the environment, the more valuable the heat transfer and, consequently, the greater the need to avoid heat transfer to the ambient, to cooling water, or to a refrigerated stream. Heat transfer across T_0 should be avoided.
- The lower the temperature T at which a heat transfer occurs in cases where $T < T_0$, the more valuable the heat transfer and, consequently, the greater the need to avoid direct heat transfer with the ambient or a heated stream.
- Since exergy destruction associated with heat transfer between streams varies inversely with the temperature level, the lower the temperature level, the greater the need to minimize the stream-to-stream temperature difference.

Although irreversibilities related to friction, unrestrained expansion, and mixing are often less significant than combustion and heat transfer, they should not be overlooked, and the following guidelines apply:

- Relatively more attention should be paid to the design of the lower temperature stages of turbines and compressors (the last stages of turbines and the first stages of compressors) than to the remaining stages of these devices. For turbines, compressors, and motors, consider the most thermodynamically efficient options.
- Minimize the use of throttling; check whether power recovery expanders are a cost-effective alternative for pressure reduction.

TABLE 12.2 Symbols and Definitions for Selected Properties

| Property | Symbol | Definition | Property | Symbol | Definition |
|-----------------------------|--------|------------|----------------------------------|----------|---|
| Pressure | p | | Specific heat, constant volume | c_v | $(\partial u / \partial T)_v$ |
| Temperature | T | | Specific heat, constant pressure | c_p | $(\partial h / \partial T)_p$ |
| Specific volume | v | | Volume expansivity | β | $\frac{1}{v}(\partial v / \partial T)_p$ |
| Specific internal energy | u | | Isothermal compressibility | κ | $-\frac{1}{v}(\partial v / \partial p)_T$ |
| Specific entropy | s | | Isothermal bulk modulus | B | $-v(\partial p / \partial v)_T$ |
| Specific enthalpy | h | $u + pv$ | Isothermal bulk modulus | B_s | $-v(\partial p / \partial v)_s$ |
| Specific Helmholtz function | ψ | $u - Ts$ | Joule–Thomson coefficient | μ_J | $(\partial T / \partial p)_h$ |
| Specific Gibbs function | g | $h - Ts$ | Joule coefficient | η | $(\partial T / \partial v)_u$ |
| Compressibility factor | Z | pv/RT | Velocity of sound | c | $\sqrt{-v^2(\partial p / \partial v)_s}$ |
| Specific heat ratio | k | c_p/c_v | | | |

- Avoid processes using excessively large thermodynamic driving forces (differences in temperature, pressure, and chemical composition). In particular, minimize the mixing of streams differing significantly in temperature, pressure, or chemical composition.
- The greater the mass flow rate the greater the need to use the exergy of the stream effectively.

Discussion of means for improving thermodynamic effectiveness also is provided by Bejan et al. (1996) and Moran and Tsatsaronis (2000).

12.3 Property Relations and Data

Engineering thermodynamics uses a wide assortment of thermodynamic properties and relations among these properties. Table 12.2 lists several commonly encountered properties. Pressure, temperature, and specific volume can be found experimentally. Specific internal energy, entropy, and enthalpy are among those properties that are not so readily obtained in the laboratory. Values for such properties are calculated using experimental data of properties that are more amenable to measurement, together with appropriate property relations derived using the principles of thermodynamics.

Property data are provided in the publications of the National Institute of Standards and Technology (formerly the U.S. Bureau of Standards), of professional groups such as the American Society of Mechanical Engineers (ASME), the American Society of Heating, Refrigerating, and Air Conditioning Engineers (ASHRAE), and the American Chemical Society, and of corporate entities such as Dupont and Dow Chemical. Handbooks and property reference volumes such as included in the list of references for this chapter are readily accessed sources of data. Property data also are retrievable from various commercial online data bases. Computer software increasingly is available for this purpose as well.

P-v-T Surface

Considerable pressure, specific volume, and temperature data have been accumulated for industrially important gases and liquids. These data can be represented in the form $p = f(v, T)$, called an *equation of state*. Equations of state can be expressed in graphical, tabular, and analytical forms. Figure 12.1(a) shows the p - v - T relationship for water. Figure 12.1(b) shows the projection of the p - v - T surface onto the pressure-temperature plane, called the *phase diagram*. The projection onto the p - v plane is shown in Fig. 12.1(c).

Figure 12.1(a) has three regions labeled solid, liquid, and vapor where the substance exists only in a single phase. Between the single phase regions lie *two-phase* regions, where two phases coexist in equilibrium. The lines separating the single-phase regions from the two-phase regions are *saturation lines*. Any state represented by a point on a saturation line is a *saturation state*. The line separating the liquid

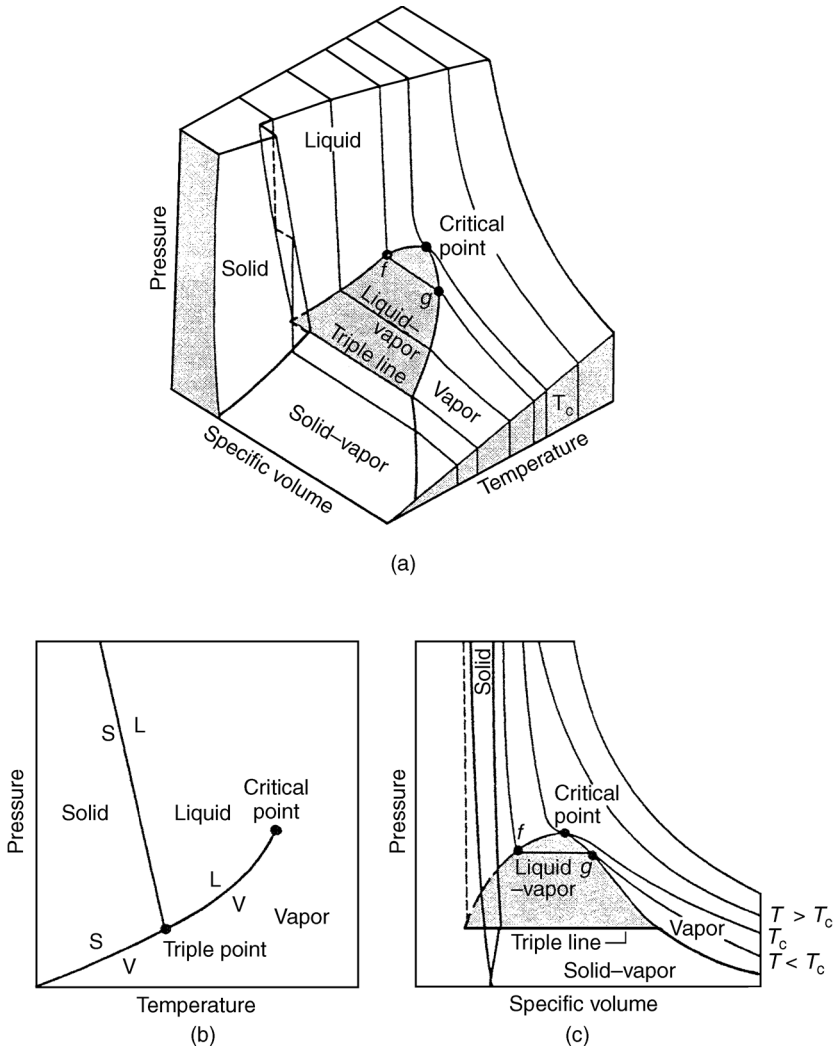

FIGURE 12.1 Pressure-specific volume-temperature surface and projections for water (not to scale).

phase and the two-phase liquid-vapor region is the saturated liquid line. The state denoted by f is a saturated liquid state. The saturated vapor line separates the vapor region and the two-phase liquid-vapor region. The state denoted by g is a saturated vapor state. The saturated liquid line and the saturated vapor line meet at the *critical point*. At the critical point, the pressure is the *critical pressure* p_c , and the temperature is the *critical temperature* T_c . Three phases can coexist in equilibrium along the line labeled *triple line*. The triple line projects onto a point on the phase diagram: the triple point.

When a phase change occurs during constant pressure heating or cooling, the temperature remains constant as long as both phases are present. Accordingly, in the two-phase liquid-vapor region, a line of constant pressure is also a line of constant temperature. For a specified pressure, the corresponding temperature is called the *saturation temperature*. For a specified temperature, the corresponding pressure is called the *saturation pressure*. The region to the right of the saturated vapor line is known as the *superheated vapor region* because the vapor exists at a temperature greater than the saturation temperature for its pressure. The region to the left of the saturated liquid line is known as the *compressed liquid region* because the liquid is at a pressure higher than the saturation pressure for its temperature.

When a mixture of liquid and vapor coexists in equilibrium, the liquid phase is a saturated liquid and the vapor phase is a saturated vapor. The total volume of any such mixture is $V = V_f + V_g$; or, alternatively, $mv = m_f v_f + m_g v_g$, where m and v denote mass and specific volume, respectively. Dividing by the total mass of the mixture m and letting the *mass fraction* of the vapor in the mixture, m_g/m , be symbolized by x , called the *quality*, the apparent specific volume v of the mixture is

$$v = (1 - x)v_f + xv_g = v_f + xv_{fg} \quad (12.16a)$$

where $v_{fg} = v_g - v_f$. Expressions similar in form can be written for internal energy, enthalpy, and entropy:

$$u = (1 - x)u_f + xu_g = u_f + xu_{fg} \quad (12.16b)$$

$$h = (1 - x)h_f + xh_g = h_f + xh_{fg} \quad (12.16c)$$

$$s = (1 - x)s_f + xs_g = s_f + xs_{fg} \quad (12.16d)$$

Thermodynamic Data Retrieval

Tabular presentations of pressure, specific volume, and temperature are available for practically important gases and liquids. The tables normally include other properties useful for thermodynamic analyses, such as internal energy, enthalpy, and entropy. The various *steam tables* included in the references of this chapter provide examples. Computer software for retrieving the properties of a wide range of substances is also available, as, for example, the ASME Steam Tables (1993) and Bornakke and Sonntag (1996). Increasingly, textbooks come with computer disks providing thermodynamic property data for water, certain refrigerants, and several gases modeled as ideal gases—see, e.g., Moran and Shapiro (2000).

The sample *steam table data* presented in [Table 12.3](#) are representative of data available for substances commonly encountered in engineering practice. The form of the tables and how they are used are assumed to be familiar. In particular, the use of *linear interpolation* with such tables is assumed known.

Specific internal energy, enthalpy, and entropy data are determined relative to arbitrary datums and such datums vary from substance to substance. Referring to [Table 12.3a](#), the datum state for the specific internal energy and specific entropy of water is seen to correspond to saturated liquid water at 0.01°C (32.02°F), the triple point temperature. The value of each of these properties is set to zero at this state. If calculations are performed involving only differences in a particular specific property, the datum cancels. When there are changes in chemical composition during the process, special care must be exercised. The approach followed when composition changes due to chemical reaction is considered in Moran and Shapiro (2000).

Liquid water data (see [Table 12.3d](#)) suggests that at fixed temperature the variation of specific volume, internal energy, and entropy with pressure is slight. The variation of specific enthalpy with pressure at fixed temperature is somewhat greater because pressure is explicit in the definition of enthalpy. This behavior for v , u , s , and h is exhibited generally by liquid data and provides the basis for the following set of equations for estimating property data at liquid states from saturated liquid data:

$$v(T, p) \approx v_f(T) \quad (12.17a)$$

$$u(T, p) \approx u_f(T) \quad (12.17b)$$

$$h(T, p) \approx h_f(T) + v_f [p - p_{\text{sat}}(T)] \quad (12.17c)$$

$$s(T, p) \approx s_f(T) \quad (12.17d)$$

The subscript f denotes the saturated liquid state at the temperature T , and p_{sat} is the corresponding saturation pressure. The underlined term of Eq. (12.17c) is usually negligible, giving $h(T, p) \approx h_f(T)$.

Graphical representations of property data also are commonly used. These include the p - T and p - v diagrams of Fig. 12.1, the T - s diagram of Fig. 12.2, the h - s (Mollier) diagram of Fig. 12.3, and the p - h diagram of Fig. 12.4. The compressibility charts considered next use the compressibility factor as one of the coordinates.

Compressibility Charts

The p - v - T relation for a wide range of common gases is illustrated by the generalized compressibility chart of Fig. 12.5. In this chart, the compressibility factor, Z , is plotted vs. the *reduced* pressure, p_R , *reduced* temperature, T_R , and *pseudoreduced* specific volume, v'_R where

$$Z = \frac{p\bar{v}}{\bar{R}T} \quad (12.18)$$

In this expression \bar{v} is the specific volume on a molar basis (m^3/kmol , for example) and \bar{R} is the *universal gas constant* ($8314 \text{ N} \cdot \text{m}/\text{kmol} \cdot \text{K}$, for example). The reduced properties are

$$p_R = \frac{p}{p_c}, \quad T_R = \frac{T}{T_c}, \quad v'_R = \frac{\bar{v}}{(\bar{R}T_c/p_c)} \quad (12.19)$$

where p_c and T_c denote the critical pressure and temperature, respectively. Values of p_c and T_c are obtainable from the literature—see, for example, Moran and Shapiro (2000). The reduced isotherms of Fig. 12.5 represent the best curves fitted to the data of several gases. For the 30 gases used in developing the chart, the deviation of observed values from those of the chart is at most on the order of 5% and for most ranges is much less.

Analytical Equations of State

Considering the isotherms of Fig. 12.5, it is plausible that the variation of the compressibility factor might be expressed as an equation, at least for certain intervals of p and T . Two expressions can be written that enjoy a theoretical basis. One gives the compressibility factor as an infinite series expansion in pressure,

$$Z = 1 + \hat{B}(T)p + \hat{C}(T)p^2 + \hat{D}(T)p^3 + \dots \quad (12.20a)$$

and the other is a series in $1/\bar{v}$,

$$Z = 1 + \frac{B(T)}{\bar{v}} + \frac{C(T)}{\bar{v}^2} + \frac{D(T)}{\bar{v}^3} + \dots \quad (12.20b)$$

Such equations of state are known as *virial expansions*, and the coefficients \hat{B} , \hat{C} , \hat{D} ... and B , C , D ... are called *virial coefficients*. In principle, the virial coefficients can be calculated using expressions from statistical mechanics derived from consideration of the force fields around the molecules. Thus far the first few coefficients have been calculated for gases consisting of relatively simple molecules. The coefficients also can be found, in principle, by fitting p - v - T data in particular realms of interest. Only the first few coefficients can be found accurately this way, however, and the result is a *truncated* equation valid only at certain states.

Over 100 equations of state have been developed in an attempt to portray accurately the p - v - T behavior of substances and yet avoid the complexities inherent in a full virial series. In general, these equations exhibit little in the way of fundamental physical significance and are mainly empirical in character. Most are developed for gases, but some describe the p - v - T behavior of the liquid phase, at least qualitatively.

TABLE 12.3 Sample Steam Table Data

(a) Properties of Saturated Water (Liquid-Vapor): Temperature Table

| Temp (°C) | Pressure (bar) | Specific Volume (m ³ /kg) | | Internal Energy (kJ/kg) | | Enthalpy (kJ/kg) | | | Entropy (kJ/kg · K) | |
|--------------|-------------------|--------------------------------------|--------------------|-------------------------|--------------------|---------------------|--------------|--------------------|---------------------|--------------------|
| | | Saturated Liquid | Saturated Vapor | Saturated Liquid | Saturated Vapor | Saturated Liquid | Evap. | Saturated Vapor | Saturated Liquid | Saturated Vapor |
| | | ($v_f \times 10^3$) | (v_g) | (u_f) | (u_g) | (h_f) | (h_{fg}) | (h_g) | (s_f) | (s_g) |
| .01 | 0.00611 | 1.0002 | 206.136 | 0.00 | 2375.3 | 0.01 | 2501.3 | 2501.4 | 0.0000 | 9.1562 |
| 4 | 0.00813 | 1.0001 | 157.232 | 16.77 | 2380.9 | 16.78 | 2491.9 | 2508.7 | 0.0610 | 9.0514 |
| 5 | 0.00872 | 1.0001 | 147.120 | 20.97 | 2382.3 | 20.98 | 2489.6 | 2510.6 | 0.0761 | 9.0257 |
| 6 | 0.00935 | 1.0001 | 137.734 | 25.19 | 2383.6 | 25.20 | 2487.2 | 2512.4 | 0.0912 | 9.0003 |
| 8 | 0.01072 | 1.0002 | 120.917 | 33.59 | 2386.4 | 33.60 | 2482.5 | 2516.1 | 0.1212 | 8.9501 |

(b) Properties of Saturated Water (Liquid-Vapor): Pressure Table

| Pressure (bar) | Temp (°C) | Specific Volume (m ³ /kg) | | Internal Energy (kJ/kg) | | Enthalpy (kJ/kg) | | | Entropy (kJ/kg · K) | |
|-------------------|--------------|--------------------------------------|--------------------|-------------------------|--------------------|---------------------|--------------|--------------------|---------------------|--------------------|
| | | Saturated Liquid | Saturated Vapor | Saturated Liquid | Saturated Vapor | Saturated Liquid | Evap. | Saturated Vapor | Saturated Liquid | Saturated Vapor |
| | | ($v_f \times 10^3$) | (v_g) | (u_f) | (u_g) | (h_f) | (h_{fg}) | (h_g) | (s_f) | (s_g) |
| 0.04 | 28.96 | 1.0040 | 34.800 | 121.45 | 2415.2 | 121.46 | 2432.9 | 2554.4 | 0.4226 | 8.4746 |
| 0.06 | 36.16 | 1.0064 | 23.739 | 151.53 | 2425.0 | 151.53 | 2415.9 | 2567.4 | 0.5210 | 8.3304 |
| 0.08 | 41.51 | 1.0084 | 18.103 | 173.87 | 2432.2 | 173.88 | 2403.1 | 2577.0 | 0.5926 | 8.2287 |
| 0.10 | 45.81 | 1.0102 | 14.674 | 191.82 | 2437.9 | 191.83 | 2392.8 | 2584.7 | 0.6493 | 8.1502 |
| 0.20 | 60.06 | 1.0172 | 7.649 | 251.38 | 2456.7 | 251.40 | 2358.3 | 2609.7 | 0.8320 | 7.9085 |

(c) Properties of Superheated Water Vapor

| $T(^{\circ}\text{C})$ | $v(\text{m}^3/\text{kg})$ | $u(\text{kJ}/\text{kg})$ | $h(\text{kJ}/\text{kg})$ | $s(\text{kJ}/\text{kg} \cdot \text{K})$ | $v(\text{m}^3/\text{kg})$ | $u(\text{kJ}/\text{kg})$ | $h(\text{kJ}/\text{kg})$ | $s(\text{kJ}/\text{kg} \cdot \text{K})$ |
|-----------------------|---|--------------------------|--------------------------|---|---|--------------------------|--------------------------|---|
| | $p = 0.06 \text{ bar} = 0.006 \text{ MPa} (T_{\text{sat}} = 36.16^{\circ}\text{C})$ | | | | $p = 0.35 \text{ bar} = 0.035 \text{ MPa} (T_{\text{sat}} = 72.69^{\circ}\text{C})$ | | | |
| Sat. | 23.739 | 2425.0 | 2567.4 | 8.3304 | 4.526 | 2473.0 | 2631.4 | 7.7158 |
| 80 | 27.132 | 2487.3 | 2650.1 | 8.5804 | 4.625 | 2483.7 | 2645.6 | 7.7564 |
| 120 | 30.219 | 2544.7 | 2726.0 | 8.7840 | 5.163 | 2542.4 | 2723.1 | 7.9644 |
| 160 | 33.302 | 2602.7 | 2802.5 | 8.9693 | 5.696 | 2601.2 | 2800.6 | 8.1519 |
| 200 | 36.383 | 2661.4 | 2879.7 | 9.1398 | 6.228 | 2660.4 | 2878.4 | 8.3237 |

(d) Properties of Compressed Liquid Water

| $T(^{\circ}\text{C})$ | $v \times 10^3$ (m^3/kg) | $u(\text{kJ}/\text{kg})$ | $h(\text{kJ}/\text{kg})$ | $s(\text{kJ}/\text{kg} \cdot \text{K})$ | $v \times 10^3$ (m^3/kg) | $u(\text{kJ}/\text{kg})$ | $h(\text{kJ}/\text{kg})$ | $s(\text{kJ}/\text{kg} \cdot \text{K})$ |
|-----------------------|--|--------------------------|--------------------------|---|--|--------------------------|--------------------------|---|
| | $p = 25 \text{ bar} = 2.5 \text{ MPa} (T_{\text{sat}} = 223.99^{\circ}\text{C})$ | | | | $p = 50 \text{ bar} = 5.0 \text{ MPa} (T_{\text{sat}} = 263.99^{\circ}\text{C})$ | | | |
| 20 | 1.0006 | 83.80 | 86.30 | 0.2961 | 0.9995 | 83.65 | 88.65 | 0.2956 |
| 80 | 1.0280 | 334.29 | 336.86 | 1.0737 | 1.0268 | 333.72 | 338.85 | 1.0720 |
| 140 | 1.0784 | 587.82 | 590.52 | 1.7369 | 1.0768 | 586.76 | 592.15 | 1.7343 |
| 200 | 1.1555 | 849.9 | 852.8 | 2.3294 | 1.1530 | 848.1 | 853.9 | 2.3255 |
| Sat. | 1.1973 | 959.1 | 962.1 | 2.5546 | 1.2859 | 1147.8 | 1154.2 | 2.9202 |

Source: Moran, M.J. and Shapiro, H.N. 2000. *Fundamentals of Engineering Thermodynamics*, 4th ed. Wiley, New York, as extracted from Keenan, J.H., Keyes, F.G., Hill, P.G., and Moore, J.G. 1969. *Steam Tables*. Wiley, New York.

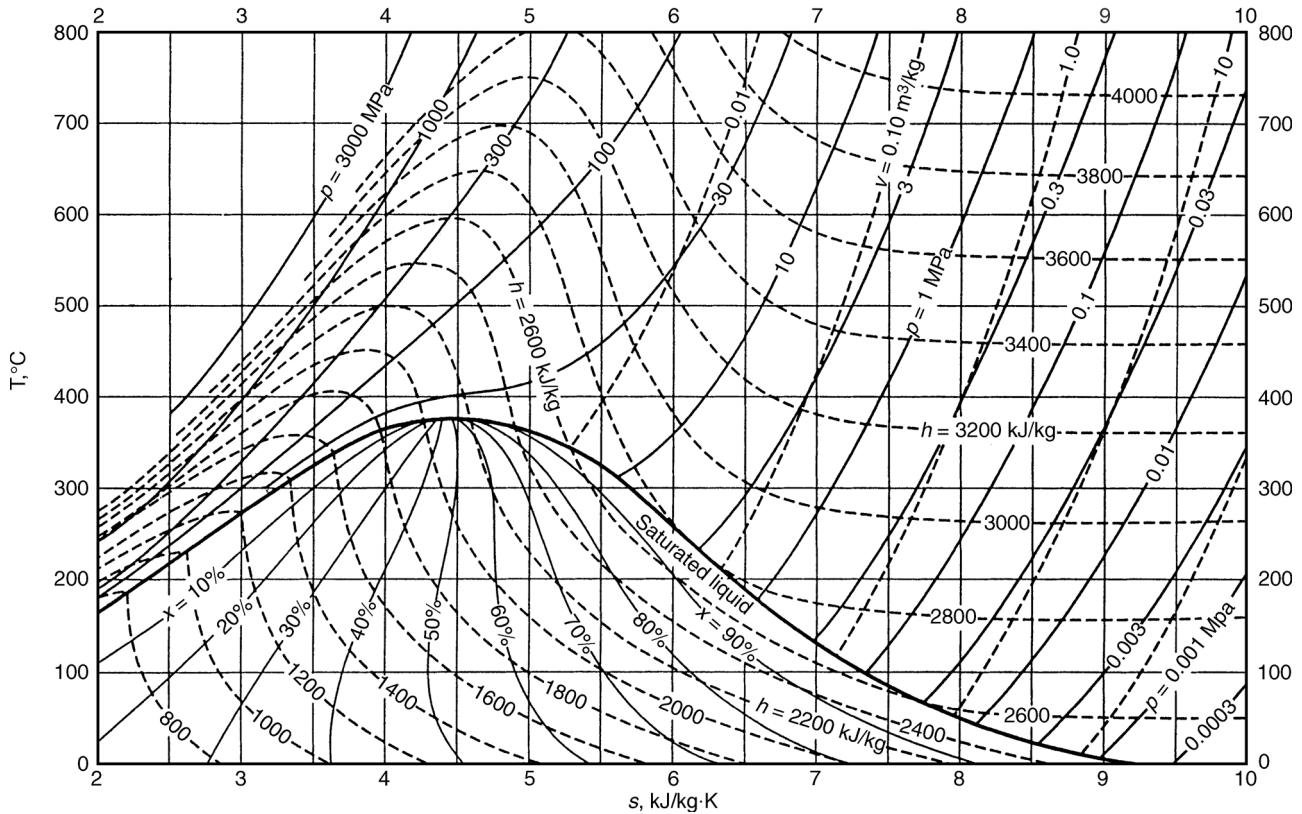

FIGURE 12.2 Temperature-entropy diagram for water. (Source: Jones, J.B. and Dugan, R.E. 1996. *Engineering Thermodynamics*, Prentice-Hall, Englewood Cliffs, NJ, based on data and formulations from Haar, L., Gallagher, J.S., and Kell, G.S. 1984. *NBS/NRC Steam Tables*. Hemisphere, Washington, D.C.)

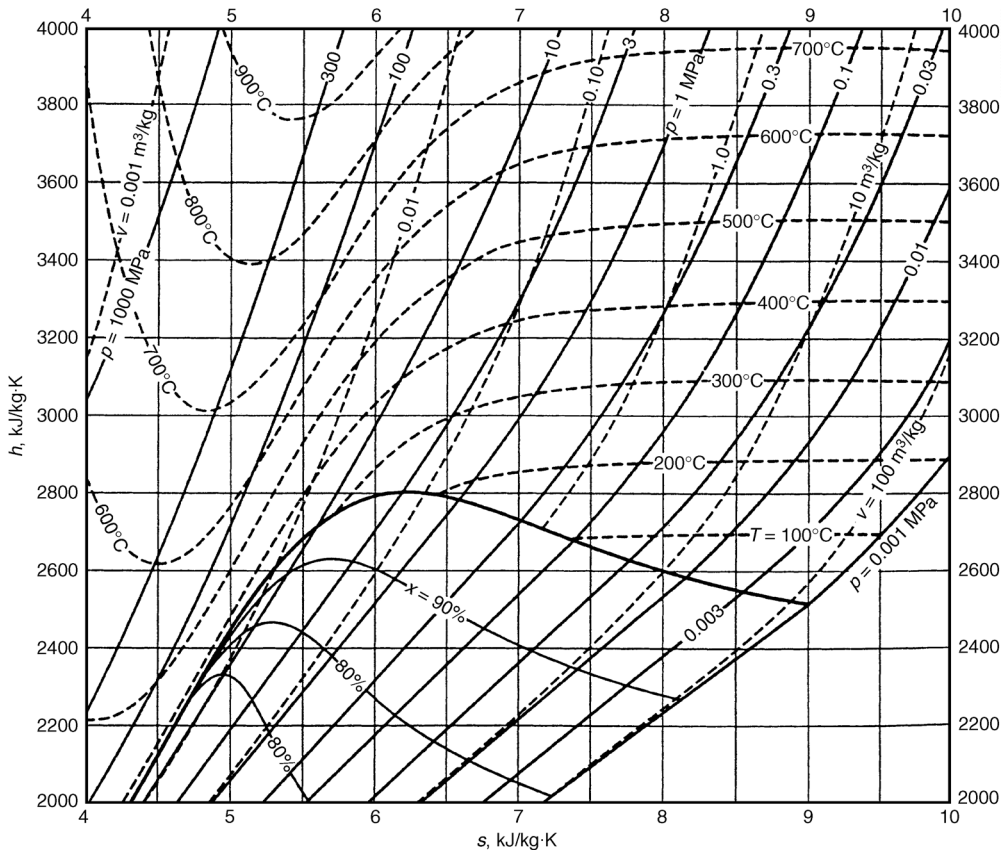

FIGURE 12.3 Enthalpy-entropy (Mollier) diagram for water. (Source: Jones, J.B. and Dugan, R.E. 1996. *Engineering Thermodynamics*. Prentice-Hall, Englewood Cliffs, NJ, based on data and formulations from Haar, L., Gallagher, J.S., and Kell, G.S. 1984. *NBS/NRC Steam Tables*. Hemisphere, Washington, D.C.)

Every equation of state is restricted to particular states. The realm of applicability is often indicated by giving an interval of pressure, or density, where the equation can be expected to represent the p - v - T behavior faithfully. For further discussion of equations of state see Reid and Sherwood (1966) and Reid et al. (1987).

Ideal Gas Model

Inspection of the generalized compressibility chart, Fig. 12.5, shows that when p_R is small, and for many states when T_R is large, the value of the compressibility factor Z is close to 1. In other words, for pressures that are low relative to p_c , and for many states with temperatures high relative to T_c , the compressibility factor approaches a value of 1. Within the indicated limits, it may be assumed with reasonable accuracy that $Z = 1$ —i.e.,

$$p\bar{v} = \bar{R}T \quad \text{or} \quad pv = RT \quad (12.21a)$$

Other forms of this expression in common use are

$$pV = n\bar{R}T, \quad pV = mRT \quad (12.21b)$$

In these equations, $n = m/\mathcal{M}$, $\bar{v} = \mathcal{M}v$, and the *specific gas constant* is $R = \bar{R}/\mathcal{M}$, where \mathcal{M} denotes the molecular weight.

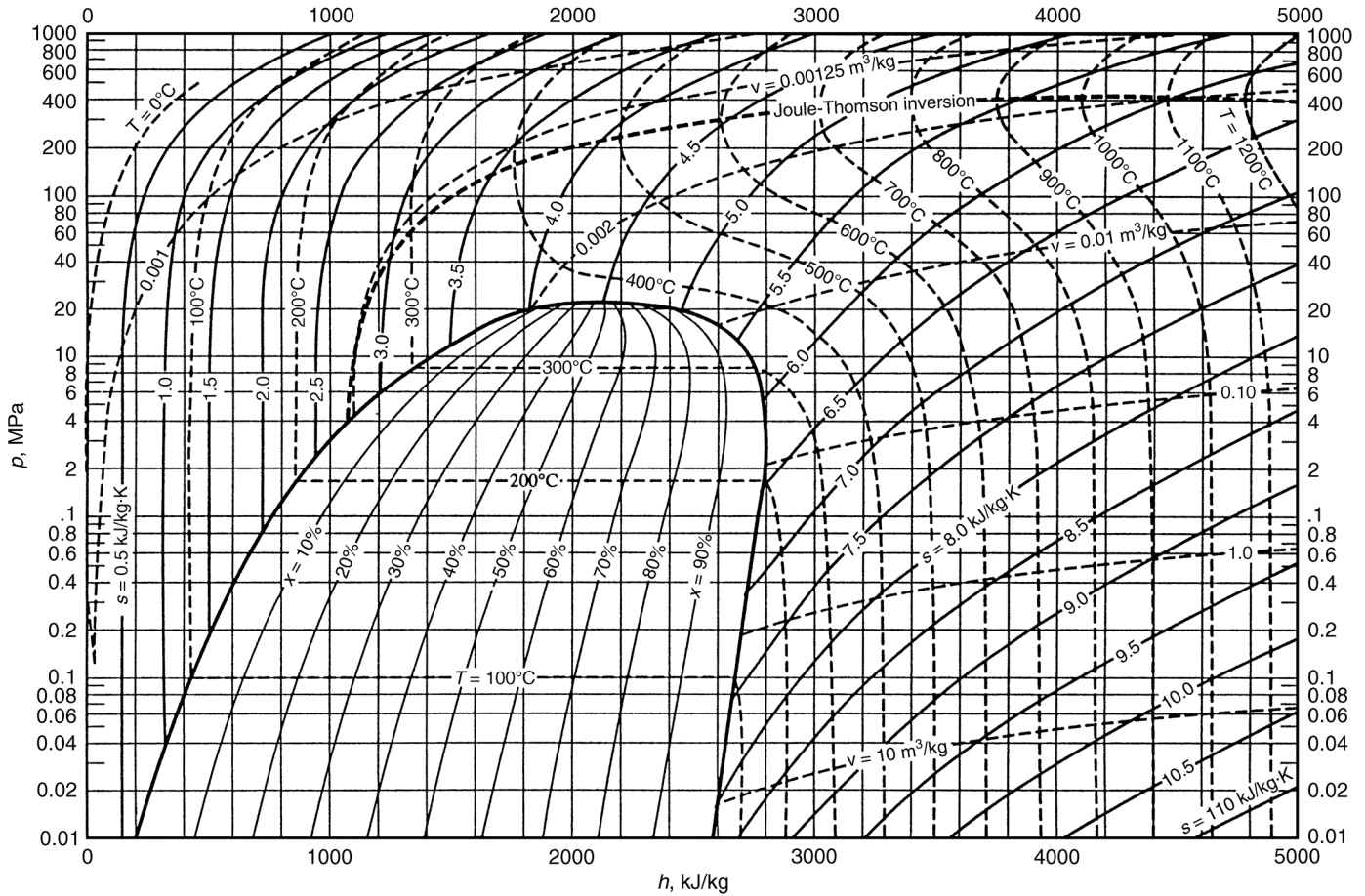

FIGURE 12.4 Pressure-enthalpy diagram for water. (Source: Jones, J.B. and Dugan, R.E. 1996. *Engineering Thermodynamics*. Prentice-Hall, Englewood Cliffs, NJ, based on data and formulations from Haar, L., Gallagher, J.S., and Kell, G.S. 1984. *NBS/NRC Steam Tables*. Hemisphere, Washington, D.C.)

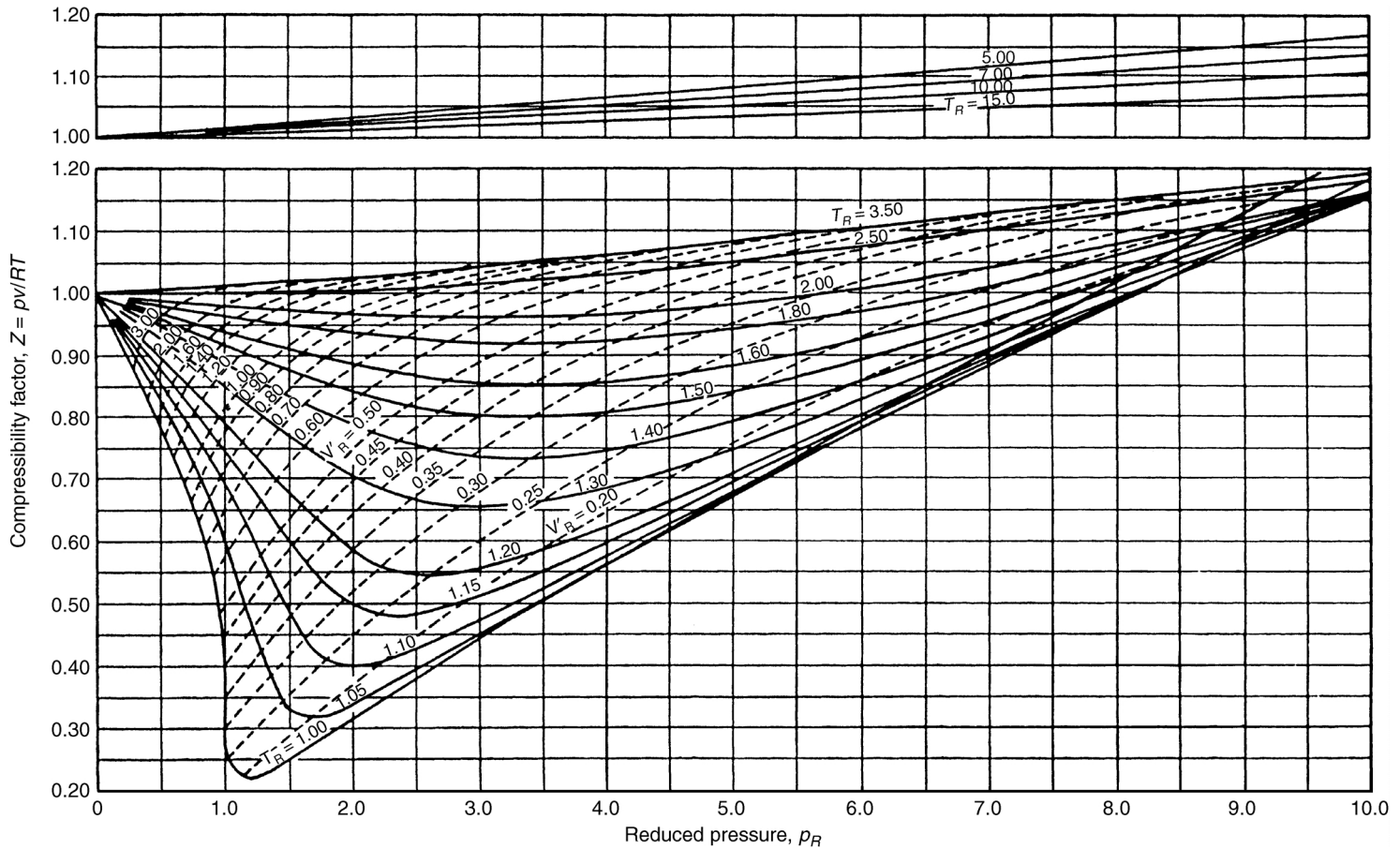

FIGURE 12.5 Generalized compressibility chart ($T_R = T/T_c$, $p_R = p/p_c$, $v'_R = \bar{v}p_c/\bar{R}T_c$) for $p_R \leq 10$. (Source: Obert, E.F. 1960 *Concepts of Thermodynamics*. McGraw-Hill, New York.)

TABLE 12.4 Ideal Gas Expressions for Δh , Δu , and Δs

| Variable Specific Heats | | Constant Specific Heats ^b | |
|--|------------------|---|------|
| $h(T_2) - h(T_1) = \int_{T_1}^{T_2} c_p(T) dT$ | (1) | $h(T_2) - h(T_1) = c_p(T_2 - T_1)$ | (1') |
| $s(T_2, p_2) - s(T_1, p_1) = \int_{T_1}^{T_2} \frac{c_p(T)}{T} dT - R \ln \frac{p_2}{p_1}$ | (2) ^a | $s(T_2, p_2) - s(T_1, p_1) = c_p \ln \frac{T_2}{T_1} - R \ln \frac{p_2}{p_1}$ | (2') |
| $u(T_2) - u(T_1) = \int_{T_1}^{T_2} c_v(T) dT$ | (3) | $u(T_2) - u(T_1) = c_v(T_2 - T_1)$ | (3') |
| $s(T_2, v_2) - s(T_1, v_1) = \int_{T_1}^{T_2} \frac{c_v(T)}{T} dT + R \ln \frac{v_2}{v_1}$ | (4) | $s(T_2, v_2) - s(T_1, v_1) = c_v \ln \frac{T_2}{T_1} + R \ln \frac{v_2}{v_1}$ | (4') |
| $s_2 = s_1$ $\frac{p_r(T_2)}{p_r(T_1)} = \frac{p_2}{p_1}$ | (5) | $s_2 = s_1$ $\frac{T_2}{T_1} = \left(\frac{p_2}{p_1}\right)^{(k-1)/k}$ | (5') |
| $\frac{v_r(T_2)}{v_r(T_1)} = \frac{v_2}{v_1}$ | (6) | $\frac{T_2}{T_1} = \left(\frac{v_2}{v_1}\right)^{k-1}$ | (6') |

^a Alternatively, $s(T_2, p_2) - s(T_1, p_1) = s^\circ(T_2) - s^\circ(T_1) - R \ln \frac{p_2}{p_1}$.

^b c_p and c_v are average values over the temperature interval from T_1 to T_2 .

It can be shown that $(\partial u / \partial v)_T$ vanishes identically for a gas whose equation of state is exactly given by Eq. (12.21), and thus the specific internal energy depends only on temperature. This conclusion is supported by experimental observations beginning with the work of Joule, who showed that the internal energy of air at low density depends primarily on temperature.

The above considerations allow for an *ideal gas model* of each real gas: (1) the equation of state is given by Eq. (12.21) and (2) the internal energy, enthalpy, and specific heats (Table 12.2) are functions of temperature alone. The real gas approaches the model in the limit of low reduced pressure. At other states the actual behavior may depart substantially from the predictions of the model. Accordingly, caution should be exercised when invoking the ideal gas model lest error is introduced.

Specific heat data for gases can be obtained by direct measurement. When extrapolated to zero pressure, ideal gas-specific heats result. Ideal gas-specific heats also can be calculated using molecular models of matter together with data from spectroscopic measurements. The following ideal gas-specific heat relations are frequently useful:

$$c_p(T) = c_v(T) + R \tag{12.22a}$$

$$c_p = \frac{kR}{k-1}, \quad c_v = \frac{R}{k-1} \tag{12.22b}$$

where $k = c_p/c_v$.

For processes of an ideal gas between states 1 and 2, Table 12.4 gives expressions for evaluating the changes in specific enthalpy, Δh , specific entropy, Δs , and specific internal energy, Δu . Relations also are provided for processes of an ideal gas between states having the same specific entropy: $s_2 = s_1$. Property relations and data required by the expressions of Table 12.4: h , u , c_p , c_v , p_r , v_r , and s° are obtainable from the literature—see, for example, Moran and Shapiro (2000).

12.4 Vapor and Gas Power Cycles

Vapor and gas power systems develop electrical or mechanical power from sources of chemical, solar, or nuclear origin. In *vapor* power systems the *working fluid*, normally water, undergoes a phase change from liquid to vapor, and conversely. In *gas* power systems, the working fluid remains a gas throughout, although the composition normally varies owing to the introduction of a fuel and subsequent combustion.

The processes taking place in power systems are sufficiently complicated that idealizations are typically employed to develop tractable thermodynamic models. The *air standard analysis* of gas power systems considered in the present section is a noteworthy example. Depending on the degree of idealization, such models may provide only qualitative information about the performance of the corresponding real-world systems. Yet such information frequently is useful in gauging how changes in major operating parameters might affect actual performance. Elementary thermodynamic models also can provide simple settings to assess, at least approximately, the advantages and disadvantages of features proposed to improve thermodynamic performance.

Work and Heat Transfer in Internally Reversible Processes

Expressions giving work and heat transfer in internally reversible processes are useful in describing the thermodynamic performance of vapor and gas cycles. Important special cases are presented in the discussion to follow. For a gas as the system, the work of expansion arises from the force exerted by the system to move the boundary against the resistance offered by the surroundings:

$$W = \int_1^2 F dx = \int_1^2 pA dx$$

where the force is the product of the moving area and the pressure exerted by the system there. Noting that $A dx$ is the change in total volume of the system,

$$W = \int_1^2 p dV$$

This expression for work applies to both actual and internal expansion processes. However, for an internally reversible process p is not only the pressure at the moving boundary but also the pressure throughout the system. Furthermore, for an internally reversible process the volume equals $m\nu$, where the specific volume ν has a single value throughout the system at a given instant. Accordingly, the work of an internally reversible expansion (or compression) process per unit of system mass is

$$\left(\frac{W}{m}\right)_{\text{rev}} = \int_1^2 p d\nu \quad (12.23)$$

When such a process of a closed system is represented by a continuous curve on a plot of pressure vs. specific volume, the area under the curve is the magnitude of the work per unit of system mass: area $a-b-c'-d'$ of Fig. 12.6.

For one-inlet, one-exit control volumes in the absence of internal irreversibilities, the following expression gives the work developed per unit of mass flowing:

$$\left(\frac{\dot{W}}{\dot{m}}\right)_{\text{rev}} = -\int_i^e \nu dp + \frac{v_i^2 - v_e^2}{2} + g(z_i - z_e) \quad (12.24a)$$

where the integral is performed from inlet to exit (see Moran and Shapiro (2000) for discussion). If there is no significant change in kinetic or potential energy from inlet to exit, Eq. (12.24a) reads

$$\left(\frac{\dot{W}}{\dot{m}}\right)_{\text{rev}} = -\int_i^e \nu dp \quad (\Delta ke = \Delta pe = 0) \quad (12.24b)$$

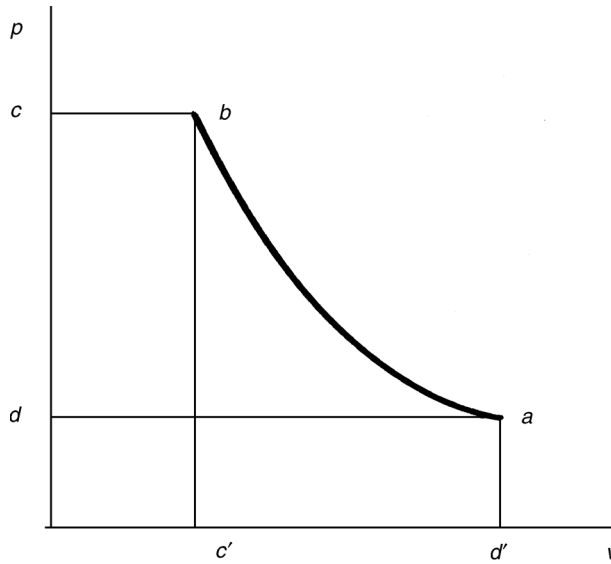

FIGURE 12.6 Internally reversible process on p - v coordinates.

The specific volume remains approximately constant in many applications with liquids. Then Eq. (12.24b) becomes

$$\left(\frac{\dot{W}}{\dot{m}}\right)_{\text{int rev}} = -v(p_e - p_i) \quad (v = \text{constant}) \quad (12.24c)$$

When the states visited by a unit of mass flowing without irreversibilities from inlet to outlet are described by a continuous curve on a plot pressure vs. specific volume, as shown in Fig. 12.6, the magnitude of the integral $\int v dp$ of Eqs. (12.24a) and (12.24b) is represented by the area a-b-c-d behind the curve.

For an internally reversible process of a closed system between state 1 and state 2, the heat transfer per unit of system mass is

$$\left(\frac{Q}{m}\right)_{\text{int rev}} = \int_1^2 T ds \quad (12.25)$$

For a one-inlet, one-exit control volume in the absence of internal irreversibilities, the following expression gives the heat transfer per unit of mass flowing from inlet i to exit e :

$$\left(\frac{Q}{\dot{m}}\right)_{\text{int rev}} = \int_i^e T ds \quad (12.26)$$

When any such process is represented by a continuous curve on a plot of temperature vs. specific entropy, the area under the curve is the magnitude of the heat transfer per unit of mass.

Polytropic Processes

An internally reversible process described by the expression $pv^n = \text{constant}$ is called a *polytropic process* and n is the *polytropic exponent*. In certain applications n can be obtained by fitting pressure-specific volume data. Although this expression can be applied when real gases are considered, it most generally appears in practice together with the use of the ideal gas model. Table 12.5 provides several expressions applicable to polytropic processes and the special forms they take when the ideal gas model is assumed. The expressions for $\int p dv$ and $\int v dp$ have application to work evaluations with Eqs. (12.23) and (12.24), respectively.

TABLE 12.5 Polytropic Processes: $pv^n = \text{Constant}^a$

| General | | Ideal Gas ^b | |
|--|-----|---|------|
| $\frac{p_2}{p_1} = \left(\frac{v_2}{v_1}\right)^n$ | (1) | $\frac{p_2}{p_1} = \left(\frac{v_1}{v_2}\right)^n = \left(\frac{T_2}{T_1}\right)^{n/(n-1)}$ | (1') |
| $n = 0$: constant pressure $n = \pm\infty$: constant specific volume | | $n = 0$: constant pressure $n = \pm\infty$: constant specific volume $n = 1$: constant temperature $n = k$: constant specific entropy when k is constant | |
| $n = 1$ | | $n = 1$ | |
| $\int_1^2 p dv = p_1 v_1 \ln \frac{v_2}{v_1}$ | (2) | $\int_1^2 p dv = RT \ln \frac{v_2}{v_1}$ | (2') |
| $-\int_1^2 v dp = -p_1 v_1 \ln \frac{p_2}{p_1}$ | (3) | $-\int_1^2 v dp = -RT \ln \frac{p_2}{p_1}$ | (3') |
| $n \neq 1$ | | $n \neq 1$ | |
| $\int_1^2 p dv = \frac{p_2 v_2 - p_1 v_1}{1-n}$ $= \frac{p_1 v_1}{n-1} \left[1 - \left(\frac{p_2}{p_1}\right)^{(n-1)/n} \right]$ | (4) | $\int_1^2 p dv = \frac{R(T_2 - T_1)}{1-n}$ $= \frac{RT_1}{n-1} \left[1 - \left(\frac{p_2}{p_1}\right)^{(n-1)/n} \right]$ | (4') |
| $-\int_1^2 v dp = \frac{n}{1-n} (p_2 v_2 - p_1 v_1)$ $= \frac{np_1 v_1}{n-1} \left[1 - \left(\frac{p_2}{p_1}\right)^{(n-1)/n} \right]$ | (5) | $-\int_1^2 v dp = \frac{nR}{1-n} (T_2 - T_1)$ $= \frac{nRT_1}{n-1} \left[1 - \left(\frac{p_2}{p_1}\right)^{(n-1)/n} \right]$ | (5') |

^a For polytropic processes of closed systems where volume change is the only work mode, Eqs. (2), (4), and (2'), (4') are applicable with Eq. (12.23) to evaluate the work. When each unit of mass passing through a one-inlet, one-exit control volume at steady state undergoes a polytropic process, Eqs. (3), (5), and (3'), (5') are applicable with Eqs. (12.24a) and (12.24b) to evaluate the power. Also note that generally, $-\int_1^2 v dp = n \int_1^2 p dv$.

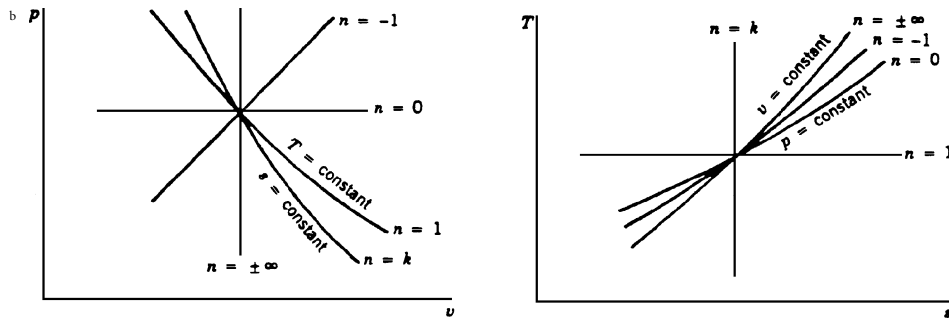

Rankine and Brayton Cycles

In their simplest embodiments vapor power and gas turbine power plants are represented conventionally in terms of four components in series, forming, respectively, the *Rankine cycle* and the *Brayton cycle* shown schematically in Table 12.6. The thermodynamically ideal counterparts of these cycles are composed of four internally reversible processes in series: two isentropic processes alternated with two constant pressure processes. Table 12.6 provides property diagrams of the actual and corresponding ideal cycles. Each actual cycle is denoted 1-2-3-4-1; the ideal cycle is 1-2s-3-4s-1. For simplicity, pressure drops through the boiler, condenser, and heat exchangers are not shown. Invoking Eq. (12.26) for the ideal cycles, the heat added per unit of mass flowing is represented by the area *under* the isobar from state 2s to state 3: area a-2s-3-b-a. The heat rejected is the area *under* the isobar from state 4s to state 1: area

TABLE 12.6 Rankine and Brayton Cycles

| Rankine Cycle | Brayton Cycle |
|--|---|
| | |
| | |
| $\left. \begin{aligned} \dot{W}_p \\ \dot{W}_c \end{aligned} \right\} = \dot{m}(h_2 - h_1) \quad (>0) \quad (1)$ | $\dot{Q}_{in} = \dot{m}(h_3 - h_2) \quad (>0) \quad (2)$ |
| $\dot{W}_t = \dot{m}(h_3 - h_4) \quad (>0) \quad (3)$ | $\dot{Q}_{out} = \dot{m}(h_1 - h_4) \quad (>0) \quad (4)$ |

a-1-4s-b-a. Enclosed area 1-2s-3-4s-1 represents the net heat added per unit of mass flowing. For any power cycle, the net heat added equals the net work done.

Expressions for the principal energy transfers shown on the schematics of Table 12.6 are provided by Eqs. (1) to (4) of the table. They are obtained by reducing Eq. (12.10a) with the assumptions of negligible heat loss and negligible changes in kinetic and potential energy from the inlet to the exit of each component. All quantities are positive in the directions of the arrows on the figure.

The thermal efficiency of a power cycle is defined as the ratio of the *net* work developed to the total energy added by heat transfer. Using expressions (1)–(3) of Table 12.6, the thermal efficiency is

$$\begin{aligned} \eta &= \frac{(h_3 - h_4) - (h_2 - h_1)}{h_3 - h_2} \\ &= 1 - \frac{h_4 - h_1}{h_3 - h_2} \end{aligned} \quad (12.27)$$

To obtain the thermal efficiency of the ideal cycle, h_{2s} replaces h_2 and h_{4s} replaces h_4 in Eq. (12.27).

Decisions concerning cycle operating conditions normally recognize that the thermal efficiency tends to increase as the average temperature of heat addition increases and/or the temperature of heat rejection decreases. In the Rankine cycle, a high average temperature of heat addition can be achieved by superheating the vapor prior to entering the turbine and/or by operating at an elevated steam-generator pressure. In the Brayton cycle an increase in the compressor pressure ratio p_2/p_1 tends to increase the average temperature of heat addition. Owing to materials limitations at elevated temperatures and pressures, the state of the working fluid at the turbine inlet must observe practical limits, however. The turbine inlet temperature of the Brayton cycle, for example, is controlled by providing air far in excess of what is required for combustion. In a Rankine cycle using water as the working fluid, a low temperature of heat rejection is typically achieved by operating the condenser at a pressure below 1 atm. To reduce erosion and wear by liquid droplets on the blades of the Rankine cycle steam turbine, at least 90% steam quality should be maintained at the turbine exit: $x_4 > 0.9$.

The back work ratio, bwr, is the ratio of the work required by the pump or compressor to the work developed by the turbine:

$$\text{bwr} = \frac{h_2 - h_1}{h_3 - h_4} \quad (12.28)$$

As a relatively high specific volume vapor expands through the turbine of the Rankine cycle and a much lower specific volume liquid is pumped, the back work ratio is characteristically quite low in vapor power plants—in many cases on the order of 1–2%. In the Brayton cycle, however, both the turbine and compressor handle a relatively high specific volume gas, and the back ratio is much larger, typically 40% or more.

The effect of friction and other irreversibilities for flow through turbines, compressors, and pumps is commonly accounted for by an appropriate *isentropic efficiency*. Referring to [Table 12.6](#) for the states, the isentropic turbine efficiency is

$$\eta_t = \frac{h_3 - h_4}{h_3 - h_{4s}} \quad (12.29a)$$

The isentropic compressor efficiency is

$$\eta_c = \frac{h_{2s} - h_1}{h_2 - h_1} \quad (12.29b)$$

In the isentropic pump efficiency, η_p , which takes the same form as Eq. (12.29b), the numerator is frequently approximated via Eq. (12.24c) as $h_{2s} - h_1 \approx v_1 \Delta p$, where Δp is the pressure rise across the pump.

Simple gas turbine power plants differ from the Brayton cycle model in significant respects. In actual operation, excess air is continuously drawn into the compressor, where it is compressed to a higher pressure; then fuel is introduced and combustion occurs; finally the mixture of combustion products and air expands through the turbine and is subsequently discharged to the surroundings. Accordingly, the low-temperature heat exchanger shown by a dashed line in the Brayton cycle schematic of [Table 12.6](#) is not an actual component, but included only to account formally for the cooling in the surroundings of the hot gas discharged from the turbine.

Another frequently employed idealization used with gas turbine power plants is that of an *air-standard analysis*. An air-standard analysis involves two major assumptions: (1) As shown by the Brayton cycle schematic of [Table 12.6](#), the temperature rise that would be brought about by combustion is effected instead by a heat transfer from an external source. (2) The working fluid throughout the cycle is air, which behaves as an ideal gas. In a cold air-standard analysis the specific heat ratio k for air is taken as constant. Equations (1) to (6) of [Table 12.4](#) apply generally to air-standard analyses. Equations (1') to (6')

of Table 12.4 apply to *cold* air-standard analyses, as does the following expression for the turbine power obtained from Table 12.1 (Eq. (10c'')):

$$\dot{W}_t = \dot{m} \frac{kRT_3}{k-1} [1 - (p_4/p_3)^{(k-1)/k}] \quad (12.30)$$

An expression similar in form can be written for the power required by the compressor.

Otto, Diesel, and Dual Cycles

Although most gas turbines are also internal combustion engines, the name is usually reserved to *reciprocating* internal combustion engines of the type commonly used in automobiles, trucks, and buses. Two principal types of reciprocating internal combustion engines are the spark-ignition engine and the compression-ignition engine. In a *spark-ignition* engine a mixture of fuel and air is ignited by a spark plug. In a *compression ignition* engine air is compressed to a high-enough pressure and temperature that combustion occurs spontaneously when fuel is injected.

In a *four-stroke* internal combustion engine, a piston executes four distinct strokes within a cylinder for every two revolutions of the crankshaft. Figure 12.7 gives a pressure-displacement diagram as it might be displayed electronically. With the intake valve open, the piston makes an *intake stroke* to draw a fresh charge into the cylinder. Next, with both valves closed, the piston undergoes a *compression stroke* raising the temperature and pressure of the charge. A combustion process is then initiated, resulting in a high-pressure, high-temperature gas mixture. A *power stroke* follows the compression stroke, during which the gas mixture expands and work is done on the piston. The piston then executes an *exhaust stroke* in which the burned gases are purged from the cylinder through the open exhaust valve. Smaller engines operate on *two-stroke* cycles. In two-stroke engines, the intake, compression, expansion, and exhaust operations are accomplished in one revolution of the crankshaft. Although internal combustion engines undergo *mechanical* cycles, the cylinder contents do not execute a *thermodynamic* cycle, since matter is introduced with one composition and is later discharged at a different composition.

A parameter used to describe the performance of reciprocating piston engines is the *mean effective pressure*, or mep. The mean effective pressure is the theoretical constant pressure that, if it acted on the

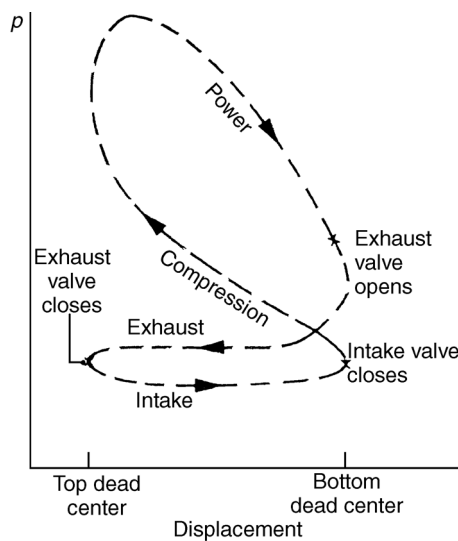

FIGURE 12.7 Pressure-displacement diagram for a reciprocating internal combustion engine.

piston during the power stroke, would produce the same net work as actually developed in one cycle. That is,

$$\text{mep} = \frac{\text{net work for one cycle}}{\text{displacement volume}} \quad (12.31)$$

where the displacement volume is the volume swept out by the piston as it moves from the top dead center to the bottom dead center. For two engines of equal displacement volume, the one with a higher mean effective pressure would produce the greater net work and, if the engines run at the same speed, greater power.

Detailed studies of the performance of reciprocating internal combustion engines may take into account many features, including the combustion process occurring within the cylinder and the effects of irreversibilities associated with friction and with pressure and temperature gradients. Heat transfer between the gases in the cylinder and the cylinder walls and the work required to charge the cylinder and exhaust the products of combustion also might be considered. Owing to these complexities, accurate modeling of reciprocating internal combustion engines normally involves computer simulation.

To conduct *elementary* thermodynamic analyses of internal combustion engines, considerable simplification is required. A procedure that allows engines to be studied *qualitatively* is to employ an *air-standard analysis* having the following elements: (1) a fixed amount of air modeled as an ideal gas is the system; (2) the combustion process is replaced by a heat transfer from an external source and represented in terms of elementary thermodynamic processes; (3) there are no exhaust and intake processes as in an actual engine: the cycle is completed by a constant-volume heat rejection process; (4) all processes are internally reversible.

The processes employed in air-standard analyses of internal combustion engines are selected to represent the events taking place within the engine simply and mimic the appearance of observed pressure-displacement diagrams. In addition to the constant volume heat rejection noted previously, the compression stroke and at least a portion of the power stroke are conventionally taken as isentropic. The heat addition is normally considered to occur at constant volume, at constant pressure, or at constant volume followed by a constant pressure process, yielding, respectively, the Otto, Diesel, and Dual cycles shown in [Table 12.7](#).

Reducing the closed system energy balance, Eq. (12.7b), gives the following expressions for work and heat applicable in each case shown in [Table 12.7](#):

$$\frac{W_{12}}{m} = u_1 - u_2, \quad \frac{W_{34}}{m} = u_3 - u_4, \quad \frac{Q_{41}}{m} = u_1 - u_4 \quad (12.32)$$

[Table 12.7](#) provides additional expressions for work, heat transfer, and thermal efficiency identified with each case individually. All expressions for work and heat adhere to the respective sign conventions of Eq. (12.7b). Equations (1) to (6) of [Table 12.4](#) apply generally to air-standard analyses. In a cold air-standard analysis the specific heat ratio k for air is taken as constant. Equations (1') to (6') of [Table 12.4](#) apply to cold air-standard analyses, as does Eq. (4') of [Table 12.5](#), with $n = k$ for the isentropic processes of these cycles.

Referring to [Table 12.7](#), the ratio of specific volumes v_1/v_2 is the *compression ratio*, r . For the Diesel cycle, the ratio v_3/v_2 is the *cutoff ratio*, r_c . [Figure 12.8](#) shows the variation of the thermal efficiency with compression ratio for an Otto cycle and Diesel cycles having cutoff ratios of 2 and 3. The curves are determined on a cold air-standard basis with $k = 1.4$ using the following expression:

$$\eta = 1 - \frac{1}{r^{k-1}} \left[\frac{r_c^k - 1}{k(r_c - 1)} \right] \quad (\text{constant } k) \quad (12.33)$$

where the Otto cycle corresponds to $r_c = 1$.

TABLE 12.7 Otto, Diesel, and Dual Cycles

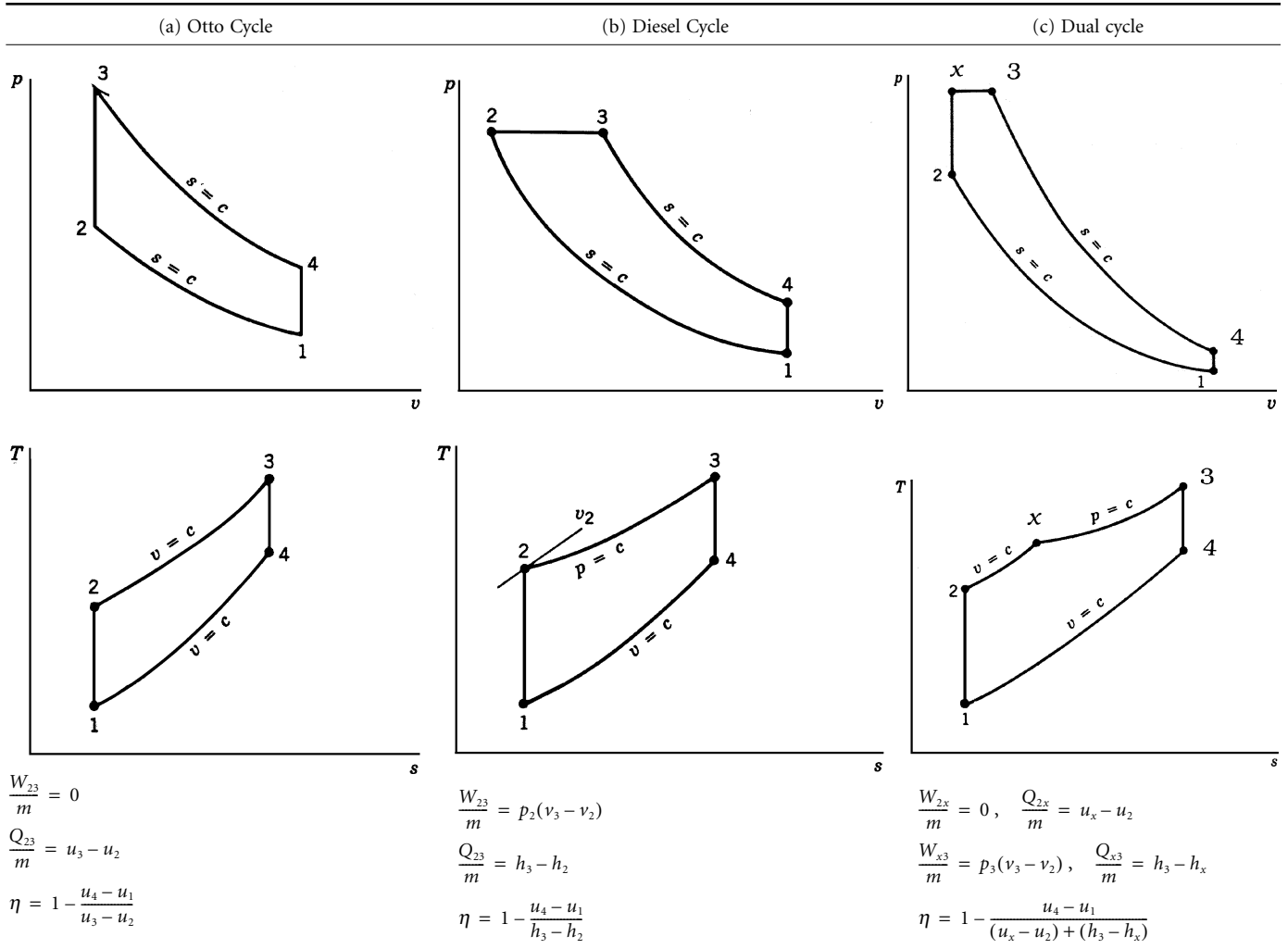

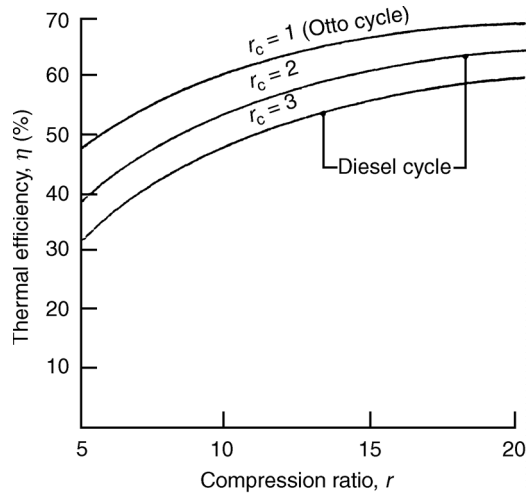

FIGURE 12.8 Thermal efficiency of the cold air-standard Otto and Diesel cycles, $k = 1.4$.

As all processes are internally reversible, areas on the p - v and T - s diagrams of Table 12.7 can be interpreted, respectively, as work and heat transfer. Invoking Eq. (12.23) and referring to the p - v diagrams, the areas under process 3-4 of the Otto cycle, process 2-3-4 of the Diesel cycle, and process x -3-4 of the Dual cycle represent the work done by the gas during the power stroke, per unit of mass. For each cycle, the area under the isentropic process 1-2 represents the work done on the gas during the compression stroke, per unit of mass. The enclosed area of each cycle represents the net work done per unit mass. With Eq. (12.25) and referring to the T - s diagrams, the areas under process 2-3 of the Otto and Diesel cycles and under process 2- x -3 of the Dual cycle represent the heat added per unit of mass. For each cycle, the area under the process 4-1 represents the heat rejected per unit of mass. The enclosed area of each cycle represents the net heat added, which equals the net work done, each per unit of mass.

References

- ASHRAE Handbook 1993 Fundamentals. 1993. American Society of Heating, Refrigerating, and Air Conditioning Engineers, Atlanta.
- ASME Steam Tables, 6th ed., 1993. ASME Press, Fairfield, NJ.
- Bejan, A., Tsatsaronis, G., and Moran, M. 1996. *Thermal Design and Optimization*, John Wiley & Sons, New York.
- Bird, R.B., Stewart, W.E., and Lightfoot, E.N. 1960. *Transport Phenomena*, John Wiley & Sons, New York.
- Bolz, R.E. and Tuve, G.L. (Eds.). 1973. *Handbook of Tables for Applied Engineering Science*, 2nd ed., CRC Press, Boca Raton, FL.
- Bornakke, C. and Sonntag, R.E. 1996. *Tables of Thermodynamic and Transport Properties*, John Wiley & Sons, New York.
- Gray, D.E. (Ed.). 1972. *American Institute of Physics Handbook*, McGraw-Hill, New York.
- Haar, L., Gallagher, J.S., and Kell, G.S. 1984. *NBS/NRC Steam Tables*, Hemisphere, New York.
- Handbook of Chemistry and Physics*, annual editions, CRC Press, Boca Raton, FL.
- JANAF Thermochemical Tables, 3rd ed., 1986. American Chemical Society and the American Institute of Physics for the National Bureau of Standards.
- Jones, J.B. and Dugan, R.E. 1996. *Engineering Thermodynamics*, Prentice-Hall, Englewood Cliffs, NJ.
- Keenan, J.H., Keyes, F.G., Hill, P.G., and Moore, J.G. 1969 and 1978. *Steam Tables*, John Wiley & Sons, New York (1969, English Units; 1978, SI Units).

- Keenan, J.H., Chao, J., and Kaye, J. 1980 and 1983. *Gas Tables—International Version*, 2nd ed., John Wiley & Sons, New York (1980, English Units; 1983, SI Units).
- Knacke, O., Kubaschewski, O., and Hesselmann, K. 1991. *Thermochemical Properties of Inorganic Substances*, 2nd ed., Springer-Verlag, Berlin.
- Kotas, T.J. 1995. *The Exergy Method of Thermal Plant Analysis*, Krieger, Melbourne, FL.
- Liley, P.E. 1987. *Thermodynamic Properties of Substances*, In *Marks' Standard Handbook for Mechanical Engineers*, E.A. Avallone and T. Baumeister (Eds.), 9th ed., McGraw-Hill, New York, Sec. 4.2.
- Liley, P.E., Reid, R.C., and Buck, E. 1984. Physical and chemical data. In *Perry's Chemical Engineers Handbook*, R.H. Perry and D.W. Green (Eds.), 6th ed., McGraw-Hill, New York, Sec. 3.
- Moran, M.J. 1989. *Availability Analysis—A Guide to Efficient Energy Use*, ASME Press, New York.
- Moran, M.J. 1998. Engineering Thermodynamics. In *The CRC Handbook of Mechanical Engineering*, F. Kreith (Ed.), CRC Press, Boca Raton, FL, Chap. 2.
- Moran, M.J. and Shapiro, H.N. 2000. *Fundamentals of Engineering Thermodynamics*, 4th ed., John Wiley & Sons, New York.
- Moran, M.J. and Shapiro, H.N. 2000. *IT: Interactive Thermodynamics*, Computer Software to Accompany Fundamentals of Engineering Thermodynamics, 4th ed., Intellipro, John Wiley & Sons, New York.
- Moran, M.J. and Tsatsaronis, G. 2000. Engineering Thermodynamics. In *The CRC Handbook of Thermal Engineering*, F. Kreith (Ed.), CRC Press, Boca Raton, FL, Chap. 1.
- Obert, E.F. 1960. *Concepts of Thermodynamics*, McGraw-Hill, New York.
- Preston-Thomas, H. 1990. The International Temperature Scale of 1990 (ITS-90). *Metrologia*. 27: 3–10.
- Reid, R.C. and Sherwood, T.K. 1966. *The Properties of Gases and Liquids*, 2nd ed., McGraw-Hill, New York.
- Reid, R.C., Prausnitz, J.M., and Poling, B.E. 1987. *The Properties of Gases and Liquids*, 4th ed., McGraw-Hill, New York.
- Reynolds, W.C. 1979. *Thermodynamic Properties in SI—Graphs, Tables and Computational Equations for 40 Substances*. Department of Mechanical Engineering, Stanford University, Palo Alto, CA.
- Stephan, K. 1994. Tables. In *Dubbel Handbook of Mechanical Engineering*, W. Beitz and K. H. Kuttner (Eds.), Springer-Verlag, London, Sec. C11.
- Szargut, J., Morris, D.R., and Steward, F.R. 1988. *Exergy Analysis of Thermal, Chemical and Metallurgical Processes*, Hemisphere, New York.
- Van Wylen, G.J., Sonntag, R.E., and Bornakke, C. 1994. *Fundamentals of Classical Thermodynamics*, 4th ed., John Wiley & Sons, New York.
- Zemansky, M.W. 1972. *Thermodynamic Symbols, Definitions, and Equations*. In *American Institute of Physics Handbook*, D.E. Gray (Ed.), McGraw-Hill, New York, Sec. 4b.

13

Modeling and Simulation for MEMS

- 13.1 Introduction
- 13.2 The Digital Circuit Development Process: Modeling and Simulating Systems with Micro- (or Nano-) Scale Feature Sizes
- 13.3 Analog and Mixed-Signal Circuit Development: Modeling and Simulating Systems with Micro- (or Nano-) Scale Feature Sizes and Mixed Digital (Discrete) and Analog (Continuous) Input, Output, and Signals
- 13.4 Basic Techniques and Available Tools for MEMS Modeling and Simulation
Basic Modeling and Simulation Techniques • A Catalog of Resources for MEMS Modeling and Simulation
- 13.5 Modeling and Simulating MEMS, i.e., Systems with Micro- (or Nano-) Scale Feature Sizes, Mixed Digital (Discrete) and Analog (Continuous) Input, Output, and Signals, Two- and Three-Dimensional Phenomena, and Inclusion and Interaction of Multiple Domains and Technologies
- 13.6 A “Recipe” for Successful MEMS Simulation
- 13.7 Conclusion: Continuing Progress in MEMS Modeling and Simulation

Carla Purdy
University of Cincinnati

13.1 Introduction

Accurate modeling and efficient simulation, in support of greatly reduced development cycle time and cost, are well established techniques in the miniaturized world of integrated circuits (ICs). Simulation accuracies of 5% or less for parameters of interest are achieved fairly regularly [1], although even much less accurate simulations (25–30%, e.g.) can still be used to obtain valuable information [2]. In the IC world, simulation can be used to predict the performance of a design, to analyze an already existing component, or to support automated synthesis of a design. Eventually, MEMS simulation environments should also be capable of these three modes of operation. The MEMS developer is, of course, most interested in quick access to particular techniques and tools to support the system currently under development. In the long run, however, consistently achieving acceptably accurate MEMS simulations will depend both on the ability of the CAD (computer-aided design) community to develop robust, efficient, user-friendly tools which will be widely available both to cutting-edge researchers and to production engineers and on the existence of readily accessible standardized processes. In this chapter we focus on fundamental approaches which will eventually lead to successful MEMS simulations becoming routine.

We also survey available tools which a MEMS developer can use to achieve good simulation results. Many of these tools build MEMS development systems on platforms already in existence for other technologies, thus leveraging the extensive resources which have gone into previous development and avoiding “reinventing the wheel.”

For our discussion of modeling and simulation, the salient characteristics of MEMS are:

1. inclusion and interaction of multiple domains and technologies,
2. both two- and three-dimensional behaviors,
3. mixed digital (discrete) and analog (continuous) input, output, and signals, and
4. micro- (or nano-) scale feature sizes.

Techniques for the manufacture of reliable (two-dimensional) systems with micro- or nano-scale feature sizes (Characteristic 4) are very mature in the field of microelectronics, and it is logical to attempt to extend these techniques to MEMS, while incorporating necessary changes to deal with Characteristics 1–3. Here we survey some of the major principles which have made microelectronics such a rapidly evolving field, and we look at microelectronics tools which can be used or adapted to allow us to apply these principles to MEMS. We also discuss why applying such strategies to MEMS may not always be possible.

13.2 The Digital Circuit Development Process: Modeling and Simulating Systems with Micro- (or Nano-) Scale Feature Sizes

A typical VLSI digital circuit or system process flow is shown in Fig. 13.1, where the dotted lines show the most optimistic point to which the developer must return if errors are discovered. Option A, for a “mature” technology, is supported by efficient and accurate simulators, so that even the first actual implementation (“first silicon”) may have acceptable performance. As a process matures, the goal is to have better and better simulations, with a correspondingly smaller chance of discovering major performance flaws after implementation. However, development of models and simulators to support this goal is in itself a major task. Option B (immature technology), at its extreme, would represent an experimental technology for which not enough data are available to support even moderately robust simulations. In modern software and hardware development systems, the emphasis is on tools which provide increasingly good support for the initial stages of this process. This increases the probability that conceptual or design errors will be identified and modifications made as early in the process as possible and thus decreases both development time and overall development cost.

At the microlevel, the development cycle represented by Option A is routinely achieved today for many digital circuits. In fact, the entire process can in some cases be highly automated, so that we have “silicon compilers” or “computers designing computers.” Thus, not only design analysis, but even design synthesis is possible. This would be the case for well-established silicon-based CMOS technologies, for example. There are many characteristics of digital systems which make this possible. These include:

- Existence of a small set of basic digital circuit elements. All Boolean functions can be realized by combinations of the logic functions AND, OR, NOT. In fact, all Boolean functions can be realized by combinations of just one gate, a NAND (NOT-AND) gate. So if a “model library” of basic gates (and a few other useful parts, such as I/O pins, multiplexors, and flip-flops) is developed, systems can be implemented just by combining suitable library elements.
- A small set of standardized and well-understood technologies, with well-characterized fabrication processes that are widely available. For example, in the United States, the MOSIS service [3] provides access to a range of such technologies. Similar services elsewhere include CMP in France [4], Europractice in Europe [5], VDEC in Japan [6], and CMC in Canada [7].
- A well-developed educational infrastructure and prototyping facilities. These are provided by all of the services listed above. These types of organization and educational support had their origins in the work of Mead and Conway [8] and continue to produce increasingly sophisticated VLSI engineers.

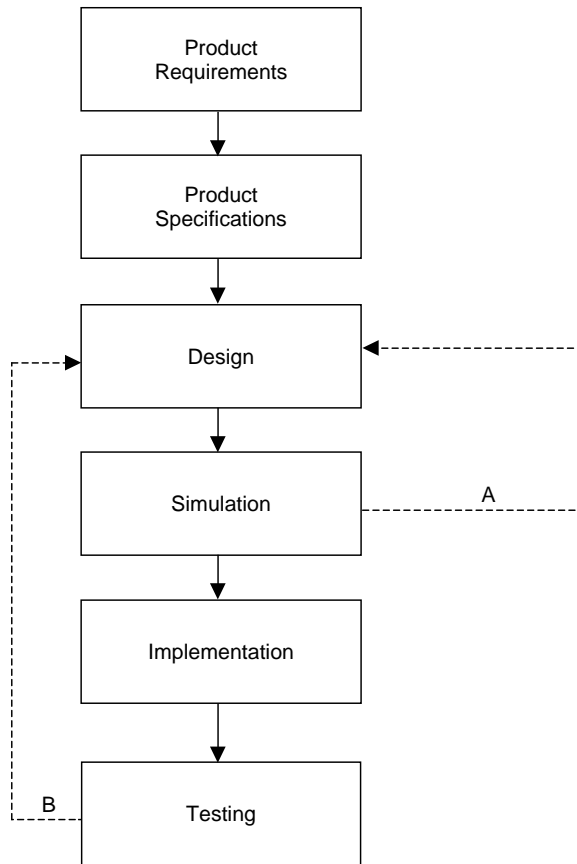

FIGURE 13.1 Product design process. A: mature technology, B: immature technology.

An important aspect of this infrastructure is that it also provides, at relatively low cost, access to example devices and systems, made with stable fabrication processes, whose behavior can be tested and compared to simulation results, thereby enabling improvements in simulation techniques.

- “Levels and views” (abstraction and encapsulation or “information hiding”) (see [9]). This concept is illustrated in Fig. 13.2(a). For the VLSI domain, we can identify at least five useful levels of abstraction, from the lowest (layout geometry) to the highest (system specification). We can also “view” a system behaviorally, structurally, or physically. In the *behavioral domain* we describe the functionality of the circuit without specifying how this functionality will be achieved. This allows us to think clearly about what the system needs to do, what inputs are needed, and what outputs will be provided. Thus we can view the component as a “black box” that has specified responses to given inputs. The current through a MOS field effect transistor (MOSFET), given as a function of the gate voltage, is a (low-level) behavioral description, for example. In the *physical domain* we specify the actual physical parts of the circuit. At the lowest levels in this domain, we must choose what material each piece of the circuit will be made from (for example, which pieces of wire will lie in each of the metal layers usually provided in a CMOS circuit) and exactly where each piece will be placed in the actual physical layout. The physical description will be translated directly into mask layouts for the circuit. The *structural domain* is intermediate between physical and behavioral. It provides an interface between the functionality specified in the behavioral domain, which ignores geometry, and the geometry specified in the physical domain, which ignores functionality. In this intermediate domain, we can carry out logic optimization and state minimization, for example.

| Levels | Views | | |
|--------|----------------------------|--|---------------------|
| | Behavioral | Structural | Physical |
| 4 | Performance Specifications | CPUs, Memory, Switches, Controllers, Buses | Physical Partitions |
| 3 | Algorithms | Modules, Data Structures | Clusters |
| 2 | Register Transfers | ALUs, MUXs, Registers | Floorplans |
| 1 | Boolean Equations, FSMs | Gates, Flip-flops | Cells, Modules |
| 0 | Transfer Functions, Timing | Transistors, Wires, Contacts, Vias | Layout Geometry |

| Levels | Views | | |
|--------|----------------------------|--|---------------------|
| | Behavioral | Structural | Physical |
| 4 | Performance Specifications | Sensors, Actuators, Systems | Physical Partitions |
| 3 | | Multiple Energy Domain Components | Clusters |
| 2 | | Domain-Domain Components | Floorplans |
| 1 | | Single Energy Domain Components | Cells, Modules |
| 0 | Transfer Functions, Timing | Beams, Membranes, Holes, Grooves, Joints | Layout Geometry |

FIGURE 13.2 A taxonomy for component development (“levels and views”): (a) standard VLSI classifications, (b) a partial classification for MEMS components.

A schematic diagram is an example of a structural description. Of course, not all circuit characteristics can be completely encapsulated in a single one of these views. For example, if we change the physical size of a wire, we will probably affect the timing, which is a behavioral property. The principle of encapsulation leads naturally to the development of extensive IP (intellectual property), i.e., libraries of increasingly sophisticated components that can be used as “black boxes” by the system developer.

- Well-developed models for basic elements that clearly delineate effects due to changes in design, fabrication process, or environment. For example, in [10], the factors in the basic first-order equations for I_{ds} , the drain-to-source current in an NMOS transistor, can clearly be divided into those under the control of the designer (W/L , the width-to-length ratio for the transistor channel), those dependent on the fabrication process (ϵ , the permittivity of the gate insulator, and t_{ox} , the thickness of the gate insulator), those dependent on environmental factors (V_{ds} and V_{gs} , the drain-to-source and gate-to-source voltages, respectively), and those that are a function of both the fabrication process and the environment (μ , the effective surface mobility of the carriers in the channel, and V_p , the threshold voltage). More detailed information on modeling MOSFETs can be found in [11]. Identification of fundamental parameters in one stage of the development process can be of great value in other stages. For example, the minimum feature size λ for a given technology can be used to develop a set of “design rules” that express mandatory overlaps and spacings for the different physical materials. A design tool can then be developed to “enforce” these rules, and the consequences can be used to simplify, to some extent, the modeling and simulation stages. The parameter λ can also be used to express effects due to scaling when scaling is valid.

- Mature tools for design and simulation, which have evolved over many generations and for which moderately priced versions are available from multiple sources. For example, many of today's tools incorporate versions of the design tool MAGIC [12] and the simulator SPICE (Simulation Program with Integrated Circuit Emphasis) [13], both of which were originally developed at the University of California, Berkeley. Versions of the SPICE simulator typically support several device models (currently, for example, six or more different MOS models and five different transmission line models), so that a developer can choose the level of device detail appropriate to the task at hand. Free or low-cost versions of both MAGIC and SPICE, as well as extended versions of both tools, are widely available. Many different techniques, such as model binning (optimizing models for specific ranges of model parameters) and inclusion of proprietary process information, are employed to produce better models and simulation results, especially in the HSPICE version of SPICE and in other high-end versions of these tools [11].
- Integrated development systems that are widely available and that provide support for a variety of levels and views, extensive component libraries, user-friendly interfaces and online help, as well as automatic translation between domains, along with error and constraint checking. In an integrated VLSI development system, sophisticated models, simulators, and translators keep track of circuit information for multiple levels and views, while allowing the developer to focus on one level or view at a time. Many development systems available today also support, at the higher levels of abstraction, structured “programming” languages such as VHDL (Very Large Scale Integrated Circuit Hardware Description Language) [14,15] or Verilog [16].

A digital circuit developer has many options, depending on performance constraints, number of units to be produced, desired cost, available development time, etc. At one extreme the designer may choose to develop a “custom” circuit, creating layout geometries, sizing individual transistors, modeling RC effects in individual wires, and validating design choices through extensive low-level SPICE-based simulations. At the other extreme, the developer can choose to produce a PLD (programmable logic device), with a predetermined basic layout geometry consisting of cells incorporating programmable logic and storage (Fig. 13.3) that can be connected as needed to produce the desired device functionality. A high end PLD may contain as many as 100,000 (100 K) cells similar to the one in Fig. 13.3 and an additional 100 K bytes of RAM (random access memory) storage. In an integrated development system, such as those

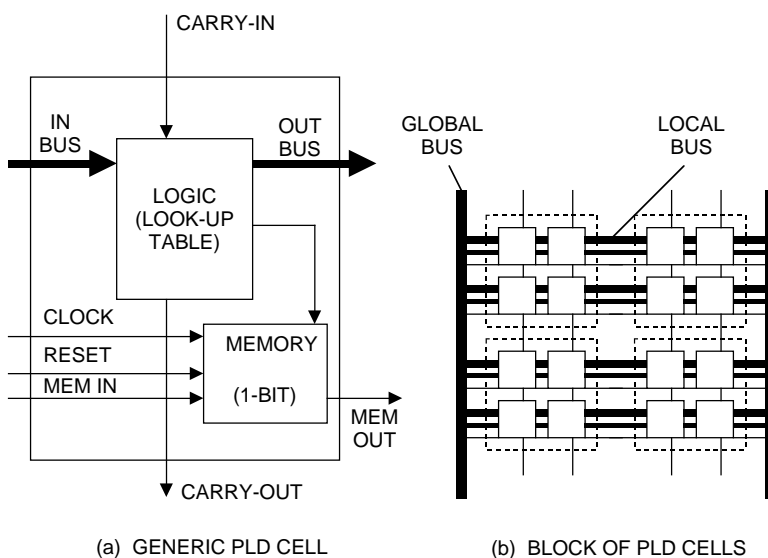

FIGURE 13.3 A generic programmable logic device architecture.

provided by [17] and [18], the developer enters the design in either schematic form or a high level language, and then the design is automatically “compiled” and mapped to the PLD geometry, and functional and timing simulations can be run. If the simulation results are acceptable, an actual PLD can then be programmed directly, as a further step in the development process, and even tested, to some extent, with the same set of test data as was used for the simulation step. This “rapid prototyping” [19] for the production of a “chip” is not very different from the production of a working software program (and the PLD can be reprogrammed if different functionality is later desired). Such a system, of course, places many constraints on achievable designs. In addition, the automated steps, which rely on heuristics rather than exact techniques to find acceptable solutions to the many computationally complex problems that need to be solved during the development process, sacrifice performance for ease of development, so that a device designed in such a system will never achieve the ultimate performance possible for the given technology. However, the trade-offs include ease of use, much shorter development times, and the management of much larger numbers of individual circuit elements than would be possible if each individual element were tuned to its optimum performance. In addition, if a high-level language is used for input, an acceptable design can often be translated, with few changes, to a more powerful design system that will allow implementation in more flexible technologies and additional fine tuning of circuit performance. In Fig. 13.4 we see some of the levels of abstraction which are present in such a development

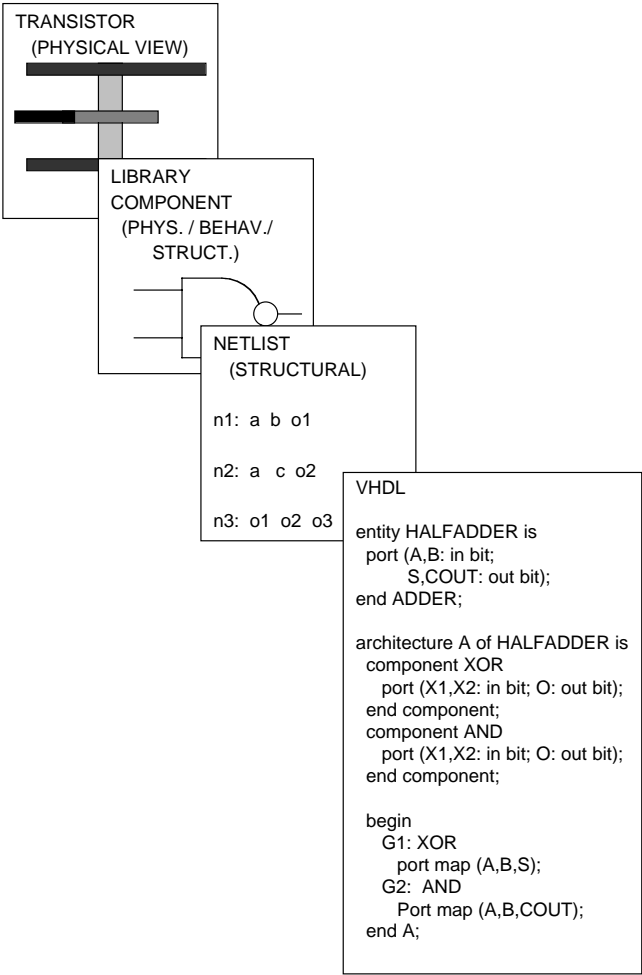

FIGURE 13.4 Levels of abstraction–half adder.

process, with the lowest level being detailed transistor models and the highest a VHDL description of a half adder.

13.3 Analog and Mixed-Signal Circuit Development: Modeling and Simulating Systems with Micro- (or Nano-) Scale Feature Sizes and Mixed Digital (Discrete) and Analog (Continuous) Input, Output, and Signals

At the lowest level, digital circuits are in fact analog devices. A CMOS inverter, for example, does not “switch” instantaneously from a voltage level representing binary 0 to a voltage level representing binary 1. However, by careful design of the inverter’s physical structures, it is possible to make the switching time from the range of voltage outputs which are considered to be “0” to the range considered to be “1” (or vice versa) acceptably short. In MOSFETs, for example, the two discrete signals of interest can be identified with the transistor, modeled as a switch, being “open” or “closed,” and the “switching” from one state to another can be ignored except at the very lowest levels of abstraction. In much design and simulation work, the analog aspects of the digital circuit’s behavior can thus be ignored. Only at the lower levels of abstraction will the analog properties of VLSI devices or the quantum effects occurring, e.g., in a MOSFET need to be explicitly taken into account, ideally by powerful automated development tools supported by detailed models. At higher levels this behavior can be encapsulated and expressed in terms of minimum and maximum switching times with respect to a given capacitive load and given voltage levels. Even in digital systems, however, as submicron feature sizes become more common, more attention must be paid to analog effects. For example, at small feature sizes, wire delay due to RC effects and crosstalk in nearby wires become more significant factors in obtaining good simulation results [20]. It is instructive to examine how simulation support for digital systems can be extended to account for these factors.

Typically, analog circuit devices are much more likely to be “hand-crafted” than digital devices. SPICE and SPICE-like simulations are commonly used to measure performance at the level of transistors, resistors, capacitors, and inductors. For example, due to the growing importance of wireless and mobile computing, a great deal of work in analog design is currently addressing the question of how to produce circuits (digital, analog, and mixed-signal) that are “low-power,” and simulations for devices to be used in these circuits are typically carried out at the SPICE level. Unless a new physical technology is to be employed, the simulations will mostly rely on the commonly available models for transistors, transmission lines, etc., thus encapsulating the lowest level behaviors.

Let us examine the factors given above for the success of digital system simulation and development to see how the analog domain compares. We assume a development cycle similar to that shown in Fig. 13.1.

- Is there a small set of basic circuit elements? In the analog domain it is possible to identify sets of components, such as current mirrors, op-amps, etc. However, there is no “universal” gate or small set of gates from which all other devices can be made, as is true in the digital domain. Another complicating factor is that elementary analog circuit elements are usually defined in terms of physical performance. There is no clean notion of 0/1 behavior. Because analog signals are continuous, it is often much more difficult to untangle complex circuit behaviors and to carry out meaningful simulations where clean parameter separations give clear results. Once a preliminary analog device or circuit design has been developed, the process of using simulations to decide on exact parameter values is known as “exploring the design space.” This process necessarily exhibits high computational complexity. Often heuristic methods such as simulated annealing, neural nets, or a genetic algorithm can be used to perform the necessary search efficiently [21].
- Is there a small set of well-understood technologies? In this area, the analog and mixed signal domain is similar to the digital domain. Much analog development activity focuses on a few standard and well-parameterized technologies. In general, analog devices are much more sensitive to variations in process parameters, and this must be accounted for in analog simulation.

Statistical techniques to model process variation have been included, for example, in the APLAC tool [22], which supports object-oriented design and simulation for analog circuits. Modeling and simulation methods, which incorporate probabilistic models, will become increasingly important as nanoscale devices become more common and as new technologies depending on quantum effects and biology-based computing are developed. Several current efforts, for example, are aimed at developing a “BIOSPICE” simulator, which would incorporate more stochastic system behavior [23].

- Is there a well-developed educational infrastructure and prototyping facilities? All the organizations, which support education and prototyping in the digital domain [3–7], provide similar support for analog and mixed-signal design.
- Are encapsulation and abstraction widely employed? In the past few years, a great deal of progress has been made in incorporating these concepts into analog and mixed-signal design systems. The wide availability of very powerful computers, which can perform the necessary design and simulation tasks in reasonable amounts of time, has helped to make this progress possible. In [24], for example, top-down, constraint-driven methods are described, and in [25] a rapid prototyping method for synthesizing analog and mixed signal systems, based on the tool suite VASE (VHDL-AMS Synthesis Environment), is demonstrated. These methods rely on classifications similar to those given for digital systems in Fig. 13.2(a).
- Are there well-developed models, mature tools, and integrated development systems which are widely available? In the analog domain, there is still much more to be done in these areas than in the digital domain, but prototypes do exist. In particular, the VHDL and Verilog languages have been extended to allow for analog and mixed-signal components. The VHDL extension, e.g., VHDL-AMS [14], will allow the inclusion of any algebraic or ordinary differential equation in a simulation. However, there does not exist a completely functional VHDL-AMS simulator, although a public domain version, incorporating many useful features, is available at [26] and many commercial versions are under development (e.g., [27]). Thus, at present, expanded versions of MAGIC and SPICE are still the most widely-used design and simulation tools. While there have been some attempts to develop design systems with configurable devices similar to the digital devices shown in Fig. 13.3, these have not so far been very successful. Currently, more attention is being focused on component-based development with design reuse for SOC (systems on a chip) through initiatives such as [28].

13.4 Basic Techniques and Available Tools for MEMS Modeling and Simulation

Before trying to answer the above questions for MEMS, we need to look specifically at the tools and techniques the MEMS designer has available for the modeling and simulation tasks. As pointed out in [29,30], the bottom line is, in any simulator, all models are not created equal. The developer must be very clear about what parameters are of greatest interest and then must choose the models and simulation techniques (including implementation in a tool or tools) that are most likely to give the most accurate values for those parameters in the least amount of simulation time. For example, the model used to determine static behavior may be different from the model needed for an adequate determination of dynamic behavior. Thus, it is useful to have a range of models and techniques available.

Basic Modeling and Simulation Techniques

We need to make the following choices:

- What kind of behavior are we interested in? IC simulators, for example, typically support DC operating analysis, DC sweep analysis (stepping current or voltage source values) and transient sweep analysis (stepping time values), along with several other types of transient analysis [30].

- Will the computation be symbolic or numeric?
- Will use of an exact equation, nodal analysis, or finite element analysis be most appropriate? Currently, these are the techniques which are favored by most MEMS developers.

To show what these choices entail, let us look at a simple example that combines electrical and mechanical parts. The cantilever beam in Fig. 13.5(a), fabricated in metal, polysilicon, or a combination, may be combined with an electrically isolated plate to form a parallel plate capacitor. If a mechanical force or a varying voltage is applied to the beam (Fig. 13.5(b1)), an accelerometer or a switch can be obtained [31]. If instead the plate can be moved back and forth, a more efficient accelerometer design results (Fig. 13.5(b2)); this is the basic design of Analog Devices' accelerometer, probably the first truly successful commercial MEMS device [32,33]. If several beams are combined into two "combs," a comb-drive sensor or actuator results, as in Fig. 13.5(b3) [34]. Let us consider just the simplest case, as shown in Fig. 13.5(b1).

If we assume the force on the beam is concentrated at its end point, then we can use the method of [35] to calculate the "pull-in" voltage, i.e., the voltage at which the plates are brought together, or to a stopper which keeps the two plates from touching. We model the beam as a dampened spring-mass system and look for the force F , which, when translated into voltage, will give the correct x value for the beam to be "pulled in."

$$F = m\ddot{x} + B\dot{x} + kx$$

Here mass $m = \rho WTL$, where ρ is the density of the beam material, $I = WT^3/12$ is the moment of inertia, $k = 3EI/L^3$, E is the Young's modulus of the beam material, and $B = (k/EI)^{1/4}$. This second-order linear differential equation can be solved numerically to obtain the pull-down voltage. In this case, since a closed form expression can be obtained for x , symbolic computation would also be an option. In [36] it is shown that for this simple problem several commonly used methods and tools will give the same result, as is to be expected.

To obtain a more accurate model of the beam we can use the method of nodal analysis, that treats the beam as a graph consisting of a set of edges or "devices," linked together at "nodes." Nodal analysis assumes that at equilibrium the sum of all values around each closed loop (the "across" quantities) will

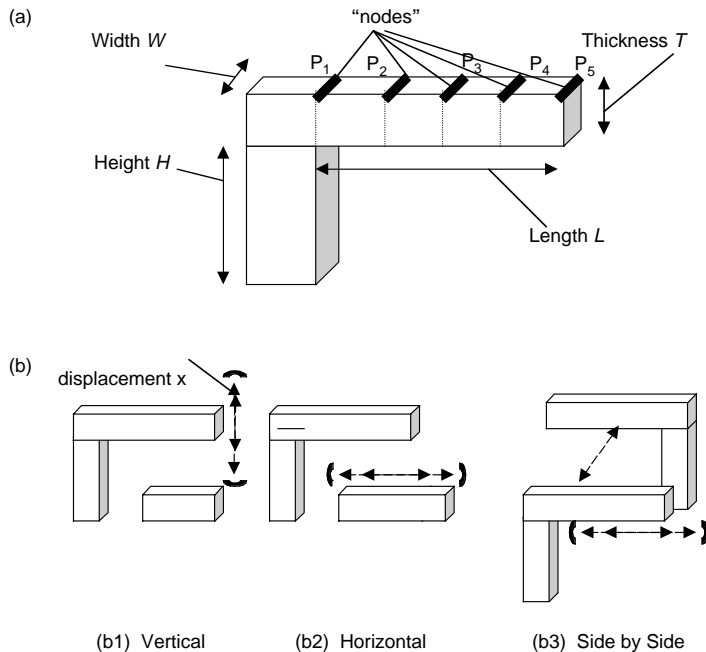

FIGURE 13.5 Cantilever beam and beam-capacitor options: (a) cantilever beam dimensions, (b) basic beam-capacitor designs.

be zero, as will the sum of all values entering or leaving a given node (the “through” quantities). Thus, for example, the sum of all forces and moments on each node must be zero, as must the sum of all currents flowing into or out of a given node. This type of modeling is sometimes referred to as “lumped parameter,” since quantities such as resistance and capacitance, which are in fact distributed along a graph edge, are modeled as discrete components. In the electrical domain Kirchhoff’s laws are examples of these rules. This method, which is routinely applied to electrical circuits in elementary network analysis courses (see, e.g., [37]), can easily be applied to other energy domains by using correct domain equivalents (see, e.g., [38]). A comprehensive discussion of the theory of nodal analysis can be found in [39]. In Fig. 13.5(a), the cantilever beam has been divided into four “devices,” subbeams between node i and $i + 1$, $i = 1, 2, 3, 4$, where the positions of nodes i and $i + 1$ are described by (x_i, y_i, θ_i) and $(x_{i+1}, y_{i+1}, \theta_{i+1})$ the coordinates and slope at P_i and P_{i+1} . The beam is assumed to have uniform width W and thickness T , and each subbeam is treated as a two-dimensional structure free to move in three-space. In [40] a modified version of nodal analysis is used to develop numerical routines to simulate several MEMS behaviors, including static and transient behavior of a beam-capacitor actuator. This modified method also adds position coordinates z_i and z_{i+1} and replaces the slope θ_i at each node with a vector of slopes, θ_{ix} , θ_{iy} , and θ_{iz} , giving each node six degrees of freedom.

Since nodal analysis is based on linear elements represented as the edges in the underlying graph, it cannot be used to model many complex structures and phenomena such as fluid flow or piezoelectricity. Even for the cantilever beam, if the beam is composed of layers of two different materials (e.g., polysilicon and metal), it cannot be adequately modeled using nodal analysis. The technique of finite element analysis (FEA) must be used instead. For example, in some follow-up work to that reported in [36], nodal analysis and symbolic computation gave essentially the same results, but the FEA results were significantly different. Finite element analysis for the beam begins with the identification of subelements, as in Fig. 13.5(a), but each element is treated as a true three-dimensional object. Elements need not all have the same shape, for example, tetrahedral and cubic “brick” elements could be mixed together, as appropriate. In FEA, one cubic element now has eight nodes, rather than two (Fig. 13.6), so computational complexity is increased. Thus, developing efficient computer software to carry out FEA for a given structure can be a difficult task in itself. But this general method can take into account many features that cannot be adequately addressed using nodal analysis, including, for example, unaligned beam sections, and surface texture (Fig. 13.7). FEA, which can incorporate static, transient, and dynamic behavior, and which can treat heat and fluid flow, as well as electrical, mechanical, and other forces, is explained in detail in [41]. The basic procedure is as follows:

- Discretize the structure or region of interest into finite elements. These need not be homogeneous, either in size or in shape. Each element, however, should be chosen so that no sharp changes in geometry or behavior occur at an interior point.
- For each element, determine the element characteristics using a “local” coordinate system. This will represent the equilibrium state (or an approximation if that state cannot be computed exactly) for the element.
- Transform the local coordinates to a global coordinate system and “assemble” the element equations into one (matrix) equation.
- Impose any constraints implied by restricted degrees of freedom (e.g., a fixed node in a mechanical problem).
- Solve (usually numerically) for the nodal unknowns.
- From the global solution, calculate the element resultants.

A Catalog of Resources for MEMS Modeling and Simulation

To make our discussion of the state-of-the-art of MEMS simulation less confusing, we first list some of the tools and products available. This list is by no means comprehensive, but it will provide us with a range of approaches for comparison. It should be noted that this list is accurate as of July 2001, but the MEMS development community is itself developing, with both commercial companies and university

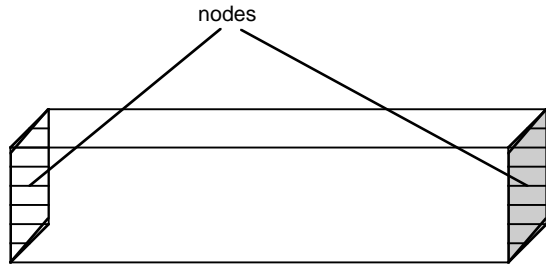

(a) Nodal analysis/Modified nodal analysis
("Linear" elements)

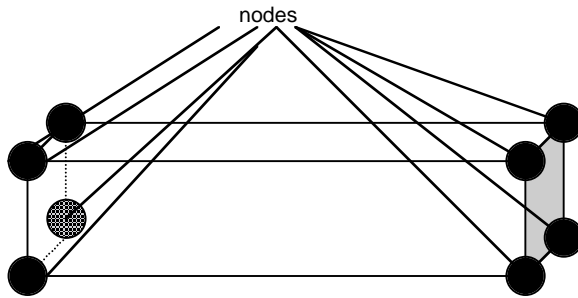

(b) Finite element analysis
(Three-dimensional elements)

FIGURE 13.6 Nodal analysis and finite element analysis.

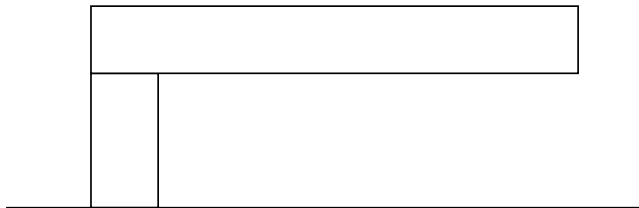

(a) Ideal beam

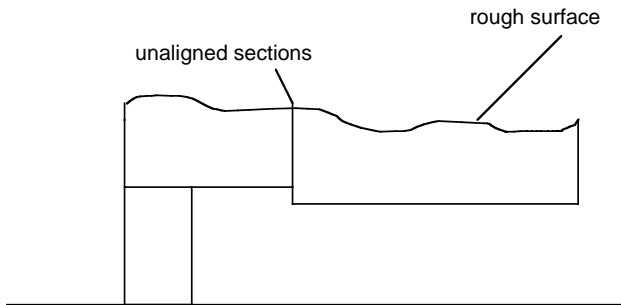

(b) Actual beam

FIGURE 13.7 Ideal and actual cantilever beams (side view).

research sites frequently taking on new identities and partners and also expanding the range of services they offer.

A. Widely Available Tools for General Numeric and Symbolic Computation

These tools are relatively easy to learn to use. Most engineering students will have mastered at least one before obtaining a bachelor's degree. They can be used to model a device "from scratch" and to perform simple simulations. For more complex simulations, they are probably not appropriate for two reasons. First, neither is optimized to execute long computations efficiently. Second, developing the routines necessary to carry out a complex nodal or finite element analysis will in itself be a time-consuming task and will in most cases only replicate functionality already available in other tools listed here.

- Mathematica [42]. In [36] Mathematica simulation results for a cantilever beam-capacitor system are compared with results from several other tools.
- Matlab (integrated with Maple) [43]. In [44], for example, Matlab simulations are shown to give good approximations for a variety of parameters for microfluidic system components.

B. Tools Originally Developed for Specific Energy Domains

Low-cost easy to use versions of some of these tools (e.g., SPICE, ANSYS) are also readily available. Phenomena from other energy domains can be modeled using domain translation.

- SPICE (analog circuits) [13]. SPICE is the de facto standard for analog circuit simulators. It is also used to support simulation of transistors and other components for digital systems. SPICE implements numerical methods for nodal analysis. Several authors have used SPICE to simulate MEMS behavior in other energy domains. In [35], for example, the equation for the motion of a damped spring, which is being used to calculate pull-in voltage, is translated into the electrical domain and reasonable simulation accuracy is obtained. In [45] steady-state thermal behavior for flow-rate sensors is simulated by dividing the device to be modeled into three-dimensional "bricks," modeling each brick as a set of thermal resistors, and translating the resulting conduction and convection equations into electrical equivalents.
- APLAC [22]. This object-oriented analog and mixed-signal simulator incorporates routines, which allow statistical modeling of process variation.
- VHDL-AMS [14,26,27]. The VHDL-AMS language, designed to support digital, analog, and mixed-signal simulation, will in fact support simulation of general algebraic and ordinary differential equations. Thus mixed-energy domain simulations can be carried out. VHDL-AMS, which is typically built on a SPICE kernel, uses the technique of nodal analysis. Some VHDL-AMS MEMS models have been developed (see, e.g., [46,47]). Additional information about VHDL-AMS is available at [48].
- ANSYS [49]. Student versions of the basic ANSYS software are widely available. ANSYS is now partnering with MemsPro (see below). ANSYS models both mechanical and fluidic phenomena using FEA techniques. A survey of the ANSYS MEMS initiative can be found at [50].
- CFD software [51]. This package, which also uses FEA, was developed to model fluid flow and temperature phenomena.

C. Tools Developed Specifically for MEMS

The tools in this category use various simplifying techniques to provide reasonably accurate MEMS simulations without all the computational overhead of FEA.

- SUGAR [40,52]. This free package is built on a Matlab core. It uses nodal analysis and modified nodal analysis to model electrical and mechanical elements. Mechanical elements must be built from a fixed set of components including beams and gaps.

- NODAS v 1.4 [53]. This downloadable tool provides a library of parameterized components (beams, plate masses, anchors, vertical and horizontal electrostatic comb drives, and horizontal electrostatic gaps) that can be interconnected to form MEMS systems. The tool outputs parameters that can be used to perform electromechanical simulations with the Saber simulator [27]. A detailed example is available at [54], and a description of how the tool works (for v 1.3) is also available [55]. Useful information is also available in [70].

D. “Metatools” Which Attempt to Integrate Two or More Domain-Specific Tools into One Package

- MEMCAD, currently being supported by the firm Coventor [56]. This product was previously supported by Microcosm, Inc. It provides low-level simulation capability by integrating domain-specific FEA tools into one package to support coupled energy domain simulations. It also supports process simulation. Much of the extensive research underlying this tool is summarized in [57].
- MemPro [58], which currently incorporates links to ANSYS. MemPro itself is an offshoot of Tanner Tools, Inc. [59], which originally produced a version of MAGIC [12] that would run on PCs. The MemPro system provides integrated design and simulation capability. Process “design rules” can be defined by the user. SPICE simulation capability is integrated into the toolset, and a data file for use with ANSYS can also be generated. MemPro does not do true energy domain coupling at this time. Some library components are also available.

E. Other Useful Resources

- The MEMS Clearinghouse website [60]. This website contains links to products, research groups, and conference information. One useful link is the Material Properties database [61], which includes results from a wide number of experiments by many different research groups. Information from this database can be used for initial “back of the envelope” calculations for component feasibility, for example.
- The Cronos website [62]. This company provides prototyping and production-level fabrication for all three process approaches (surface micromachining, bulk micromachining, and high aspect ratio manufacturing). It is also attempting to build a library of MEMS components for both surface micromachining (MUMPS, or the Multi-User MEMS Process [63]) and bulk micromachining.

13.5 Modeling and Simulating MEMS, i.e., Systems with Micro- (or Nano-) Scale Feature Sizes, Mixed Digital (Discrete) and Analog (Continuous) Input, Output, and Signals, Two- and Three-Dimensional Phenomena, and Inclusion and Interaction of Multiple Domains and Technologies

In preceding sections we briefly described the current state-of-the-art in modeling and simulation in both the digital and analog domains. While the digital tools are much more developed, in both the digital and analog domains there exist standard, well-characterized technologies, standard widely available tools, and stable educational and prototyping programs. In the much more complex realm of MEMS, this is not the case. Let us compare MEMS, point by point, with digital and analog circuits.

- Is there a small set of basic elements? The answer to this question is emphatically no. Various attempts have been made by researchers to develop a comprehensive basic set of building blocks, beginning with Petersen’s identification of the fundamental component set consisting of beams, membranes, holes, grooves, and joints [64]. Most of these efforts focus on adding mechanical and electromechanical elements. In the SUGAR system, for example, the basic elements are the *beam* and the *electrostatic gap*. In the Carnegie Mellon tool MEMSYN [65], which is supported by the

NODAS simulator, basic elements include beams and gaps, as well as plate masses, anchors, and electrostatic comb drives (vertical and horizontal). For the MUMPS process there is the Consolidated Micromechanical Element Library (CaMEL), which contains both a nonparameterized cell database and a library of parameterized elements (which can be accessed through a component “generator,” but not directly by the user). CaMEL supports the creation of a limited set of components, including motors and resonators, in a fixed surface-micromachined technology. But the bottom line for MEMS is that no set of basic building blocks has yet been identified which can support all the designs, in many different energy domains and in a variety of technologies, which researchers are interested in building. Moreover, there is no consensus as to how to effectively limit design options so that such a fundamental set could be identified. In addition, the continuous nature of most MEMS behavior presents the same kinds of difficulties that are faced with analog elements. Development of higher level component libraries, however, is a fairly active field, with, for example, ANSYS, CFD, MEMCAD, Carnegie Mellon, and MemsPro all providing libraries of previously designed and tested components for systems developers to use. Most of these components are in the electromechanical domain. As mentioned above, a few VHDL-AMS models are also available, but these will not be of practical value until more robust and complete VHDL-AMS simulators are developed and more experimental results can be obtained to validate these models.

- Is there a small set of well-understood technologies? Again the answer must be no. Almost all digital and analog circuits are essentially two-dimensional, but, in the case of MEMS, many designs can be developed either in the “2.5-dimensional” technology known as micromachining or in the true three-dimensional technology known as bulk micromachining. Thus, before doing any modeling or simulation, the MEMS developer must first choose not only among very different fabrication techniques but also among actual processes. Both the Carnegie Mellon and Cronos tools, for example, are based on processes that are being developed in parallel with the tools. MOSIS does provide central access to technology in which all but the final steps of surface micromachining can be done, but no other centrally maintained processing is available to the community of MEMS researchers in general. For surface micromachining, the fact that the final processing steps are performed in individual research labs is problematic for producing repeatable experimental results. For bulk micromachining examples, fabrication in small research labs rather than in a production environment is more the norm than the exception, so standardization for bulk processes is difficult to achieve. In addition, because much MEMS work is relatively low-volume, most processes are not well enough characterized for low-level modeling to be very effective. In such circumstances it is very difficult to have reliable process characterizations on which to build robust models.
- Is there a well-developed educational infrastructure and prototyping facilities? Again we must answer no. Introductory MEMS courses, especially, are much more likely to emphasize fabrication techniques than modeling and simulation. In [66] a set of teaching modules for a MEMS course emphasizing integrated design and simulation is described. However, this course requires the use of devices previously fabricated for validating design and simulation results, rather than expecting students to complete the entire design-simulate-test-fabricate sequence in one quarter or semester. In addition, well-established institutional practices make it difficult to provide the necessary support for multidisciplinary education which MEMS requires.
- Are encapsulation and abstraction widely employed? In the 1980s many researchers believed that multiple levels of abstraction were not useful for MEMS devices. Currently, however, the concept of intermediate-level “macromodels” has gained much support [57,70], and increasing emphasis is being placed on developing macromodels for MEMS components that will be a part of larger systems. In addition, there are several systems in development that are based on sets of more primitive components. But this method of development is not the norm, in large part because of the rich set of possibilities inherent in MEMS in general. In Fig. 13.2(b) we have given a partial classification of MEMS corresponding to the classification for digital devices in Fig. 13.2(a). At this point it is not

| Simulation Tool | Levels Supported |
|---------------------|------------------|
| Mathematica, Matlab | all |
| MEMCAD | low |
| SPICE | low to medium |
| APLAC | low to medium |
| ANSYS, CFD | low to medium |
| SUGAR, NODAS | low to medium |
| MemsPro | low to medium |
| VHDL-AMS | medium to high |

*Because MEMCAD incorporates process simulations, it supports both physical and behavioral views. All other tools support the behavioral view.

FIGURE 13.8 Available MEMS simulation tools, by level and view.

clear what the optimum number of levels of abstraction for MEMS would be. In Fig. 13.8 we have attempted to classify some of the tools from Section 13.4 in terms of their ability to support various levels (since these are simulators, they all support the “behavioral” view. MEMCAD, which allows fabrication process simulation, also supports the “physical” view). Note that VHDL-AMS is the only tool, besides the general-purpose Mathematica and Matlab, that supports a high-level view of MEMS.

- Are there well-developed models, mature tools, and integrated development systems which are widely available? While such systems do not currently exist, it is predicted that some examples should become available within the next ten years [57].

13.6 A “Recipe” for Successful MEMS Simulation

A useful set of guidelines for analog simulation can be found in [67]. From this we can construct a set of guidelines for MEMS simulation.

1. Be sure you have access to the necessary domain-specific knowledge for all energy domains of interest before undertaking the project.
2. Never use a simulator unless you know the range of answers beforehand.
3. Never simulate more of the system than is necessary.
4. Always use the simplest model that will do the job.
5. Use the simulator exactly as you would do the experiment.
6. Use a specified procedure for exploring the design space. In most cases this means that you should change only one parameter at a time.
7. Understand the simulator you are using and all the options it makes available.
8. Use the correct multipliers for all quantities.
9. Use common sense.
10. Compare your results with experiments and make them available to the MEMS community.
11. Be sensitive to the possibility of microlevel phenomena, which may make your results invalid.

The last point is particularly important. Many phenomena, which can be ignored at larger feature sizes, will need to be taken into account at the micro level. For example, at the micro scale, fluid flow can behave in dramatically different ways [44]. Many other effects of scaling feature sizes down to the microlevel, including an analysis of why horizontal cantilever beam actuators are “better” than vertical cantilever beam actuators, are discussed in Chapter 9 of [68]. Chapters 4 and 5 of [68] also provide important information for low-level modeling and simulation.

13.7 Conclusion: Continuing Progress in MEMS Modeling and Simulation

In the past fifteen years, much progress has been made in providing MEMS designers with simulators and other tools which will give them the ability to make MEMS as useful and ubiquitous as was predicted in [64]. While there is still much to be done, the future is bright for this flexible and powerful technology. One of the main challenges remaining for modeling and simulation is to complete the design and development of a high-level MEMS description language, along with supporting models and simulators, both to speed prototyping and to provide a common user-friendly language for designers. One candidate for such a language is VHDL-AMS. In [69], the strengths and weaknesses of VHDL-AMS as a tool for MEMS development are discussed. Strengths include the ability to handle both discrete and continuous behavior, smooth transitions between levels of abstraction, the ability to handle both conservative and nonconservative systems simultaneously, and the ability to import code from other languages. Major drawbacks include the inability to do symbolic computation, the limitation to ordinary differential equations, lack of support for frequency domain simulations, and inability to do automatic unit conversions. It remains to be seen whether VHDL-AMS will eventually be extended to make it more suitable to support the MEMS domain. But it is highly likely that VHDL-AMS or some similar language will eventually come to be widely used and appreciated in the MEMS community.

References

1. Kielkowski, R.M., *SPICE: Practical Device Modeling*, McGraw-Hill, 1995.
2. Leong, S.K., Extracting MOSFET RF SPICE models, <http://www.polyfet.com/MTT98.pdf> (accessed July 20, 2001).
3. <http://www.mosis.edu> (accessed July 20, 2001).
4. <http://cmp.imag.fr> (accessed July 20, 2001).
5. <http://www.imec.be/europractice/europractice.html> (accessed July 20, 2001).
6. <http://www.vdec.u-tokyo.ac.jp/English> (accessed July 20, 2001).
7. <http://www.cmc.ca> (accessed July 20, 2001).
8. Mead, C. and Conway, L., *Introduction to VLSI Systems*, Addison-Wesley, 1980.
9. Gajski, D. and Thomas, D., Introduction to silicon compilation, in *Silicon Compilation*, D. Gajski, Ed., Addison-Wesley, 1988, 1–48.
10. Weste, N. and Esraghian, K., *Principles of CMOS VLSI Design: A Systems Perspective*, 2nd ed., Addison-Wesley, 1993.
11. Foty, D., *MOSFET Modeling with SPICE*, Prentice Hall, 1997.
12. <http://www.research.compaq.com/wrl/projects/magic/magic.html> (accessed July 20, 2001).
13. <http://bwrc.eecs.berkeley.edu/Courses/IcBook/SPICE> (accessed July 20, 2001).
14. Design Automation Standards Committee, IEEE Computer Society, *IEEE VHDL Standard Language Reference Manual (Integrated with VHDL-AMS Changes)*, Standard 1076.1, IEEE, 1997.
15. Ashenden, P., *The Designer's Guide to VHDL, 2nd ed.*, Morgan Kaufman, 2001.
16. Bhasker, J., *A Verilog HDL Primer*, 2nd ed., Star Galaxy Pub., 1999.
17. <http://www.altera.com> (accessed July 20, 2001).
18. <http://www.xilinx.com> (accessed July 20, 2001).
19. Hamblen, J.O. and Furman, M.D., *Rapid Prototyping of Digital Systems, A Tutorial Approach*, Kluwer, 1999.
20. Uyemura, J.P., *Introduction to VLSI Circuits and Systems*, John Wiley & Sons, Inc., 2002.
21. Sobecks, B., Performance Modeling of Analog Circuits via Neural Networks: The Design Process View, Ph.D. Dissertation, University of Cincinnati, 1998.
22. <http://www.aplac.hut.fi> (accessed July 20, 2001).
23. Weiss, R., Homsy, G., and Knight, T., Toward *in vivo* digital circuits, <http://www.swiss.ai.mit.edu/~rweiss/bio-programming/dimacs99-evocomp-talk/> (accessed July 20, 2001).

24. Chang, H., Charbon, E., Choudhury, U., Demir, A., Liu, Felt E., Malavasi, E., Sangiovanni-Vincentelli, A., Charbon, E., and Vassiliou, I., *A Top-down, Constraint-Driven Design Methodology for Analog Integrated Circuits*, Kluwer Academic Publishers, 1996.
25. Ganesan, S., Synthesis and Rapid Prototyping of Analog and Mixed Signal Systems, Ph.D. Dissertation, University of Cincinnati, 2001.
26. SEAMS simulator project, University of Cincinnati ECECS Department, Distributed Processing Laboratory, <http://www.ececs.uc.edu/~hcarter> (accessed July 20, 2001).
27. <http://www.analogy.com/products/Simulation/simulation.htm#Saber> (accessed July 20, 2001).
28. www.design-reuse.com (accessed July 20, 2001).
29. S. M. Sandler and Analytical Engineering Inc., *The SPICE Handbook of 50 Basic Circuits*, <http://dacafe.ibsystems.com/DACafe/EDATools/EDAbooks/SpiceHandBook> (accessed July 20, 2001).
30. Kielkowski, R.M., *Inside Spice*, 2nd ed., McGraw Hill, 1998.
31. Gibson, D., Hare, A., Beyette, F., Jr., and Purdy, C., Design automation of MEMS systems using behavioral modeling, *Proc. Ninth Great Lakes Symposium on VLSI*, Ann Arbor Mich. (Eds. R.J. Lomax and P. Mazumder), March 1999, pp. 266–269.
32. <http://www.analog.com/industry/iMEMS> (accessed July 20, 2001).
33. <http://www-ccrma.stanford.edu/CCRMA/Courses/252/sensors/node6.html> (accessed July 20, 2001).
34. Tang, W., Electrostatic Comb Drive for Resonant Sensor and Actuator Applications, Ph.D. Dissertation, UC Berkeley, 1990.
35. Lo, N.R., Berg, E.C., Quakkelaar, S.R., Simon, J.N., Tachiki, M., Lee, H.-J., and Pister, S.J., Parameterized layout synthesis, extraction, and SPICE simulation for MEMS, *ISCAS 96*, May 1996, pp. 481–484.
36. Gibson, D., and Purdy, C.N., Extracting behavioral data from physical descriptions of MEMS for simulation, *Analog Integrated Circuits and Signal Processing* 20, 1999, pp. 227–238.
37. Hayt, W.H., Jr. and Kemmerly, J.E., *Engineering Circuit Analysis*, 5th ed., McGraw-Hill, 1993, pp. 88–95.
38. Dewey, A., Hanna, J., Hillman, B., Dussault, H., Fedder, G., Christen, E., Bakalar, K., Carter, H., and Romanowica, B., VHDL-AMS Modeling Considerations and Styles for Composite Systems, Version 2.0, http://www.ee.duke.edu/research/IMPACT/documents/model_g.pdf (accessed July 20, 2001).
39. McCalla, W.J., *Fundamentals of Computer-Aided Circuit Simulation*, Kluwer Academic, 1988.
40. Clark, J.V., Zhou, N., and Pister, K.S.J., Modified nodal analysis for MEMS with multi-energy domains, *International Conference on Modeling and Simulation of Microsystems, Semiconductors, Sensors and Actuators*, San Diego, CA, March 27–29, 2000, pp. 31–34.
41. Stasa, F.L., *Applied Finite Element Analysis for Engineers*, Holt, Rinehart and Winston, 1985.
42. <http://www.wolfram.com/products/mathematica> (accessed July 20, 2001).
43. <http://www.mathworks.com/products/matlab> (accessed July 20, 2001).
44. Mehta, A., Design and Control Oriented Approach to the Modeling of Microfluidic System Components, M.S. Thesis, University of Cincinnati, 1999.
45. Swart, N., Nathan, A., Shams, M., and Parameswaran, M., Numerical optimisation of flow-rate microsensors using circuit simulation tools, *Transducers '91*, 1991, pp. 26–29.
46. <http://www.ee.duke.edu/research/IMPACT/vhdl-ams/index.html> (accessed July 20, 2001).
47. Gibson, D., Carter, H., and Purdy, C., The use of hardware description languages in the development of microelectromechanical systems, *International Journal of Analog Integrated Circuits and Signal Processing*, 28(2), August 2001, pp. 173–180.
48. <http://www.vhdl-ams.com/> (accessed July 20, 2001).
49. <http://www.ansys.com/action/MEMSiinitiative/index.htm> (accessed July 20, 2001).
50. http://www.ansys.com/action/pdf/MEMS_WP.pdf (accessed July 20, 2001).
51. <http://www.cfdr.com> (accessed July 20, 2001).
52. Pister, K., SUGAR V2.0, <http://www-bsac.EECS.Berkeley.edu/~cfm/mainpage.html> (accessed July 20, 2001).
53. http://www.ece.cmu.edu/~mems/projects/memsyn/nodasv1_4/index.shtml (accessed July 20, 2001).
54. http://www2.ece.cmu.edu/~mems/projects/memsyn/nodasv1_4/tutorial.html (accessed July 20, 2001).

55. Jing, Q. and Fedder, G.K., NODAS 1.3-nodal design of actuators and sensors, *IEEE/VIUF International Workshop on Behavioral Modeling and Simulation*, Orlando, Fla., October 27–28, 1998.
56. <http://www.coventor.com/software/coventorware/index.html> (accessed July 20, 2001).
57. Senturia, S.D., Simulation and design of microsystems: a 10-year perspective, *Sensors and Actuators A*, 67, 1998, pp. 1–7.
58. www.memscap.com/index2.html (accessed July 20, 2001).
59. <http://www.tanner.com/> (accessed July 20, 2001).
60. <http://mems.isi.edu> (accessed July 20, 2001).
61. <http://mems.isi.edu/mems/materials/index.html> (accessed July 20, 2001).
62. <http://www.memsrus.com> (accessed July 20, 2001).
63. <http://www.memsrus.com/cronos/svcsmumps.html> (accessed July 20, 2001).
64. Petersen, K., Silicon as a mechanical material, *IEEE Proceedings*, 70(5), May 1982, pp. 420–457.
65. <http://www.ece.cmu.edu/~mems/projects/memsyn/index.shtml> (accessed July 20, 2001).
66. Beyette, F., Jr. and C.N. Purdy, Teaching modules for a class in mechatronics, *European Workshop on Microelectronics Education (EWME2000)*, May 2000.
67. Allen, P.E. and Holberg, D.R., *CMOS Analog Circuit Design*, Oxford University Press, 1987, pp. 142–144.
68. Madou, M., *Fundamentals of Microfabrication*, CRC Press, Boca Raton, FL, 1997.
69. Gibson, D. and Purdy, C., The strengths and weaknesses of VHDL-AMS as a tool for MEMS development, white paper, 2000, <http://www.eecs.uc.edu/~cpurdy/csl.html/pub.html/weakvhdl.pdf> (accessed July 20, 2001).
70. Mukherjee, T. and Fedder, G.K., Hierarchical mixed-domain circuit simulation, synthesis and extraction methodology for MEMS, *Journal of VLSI Signal Processing*, 21, 1999, pp. 233–249.

14

Rotational and Translational Microelectromechanical Systems: MEMS Synthesis, Microfabrication, Analysis, and Optimization

- 14.1 Introduction
- 14.2 MEMS Motion Microdevice Classifier and Structural Synthesis
- 14.3 MEMS Fabrication
 - Bulk Micromachining • Surface Micromachining
 - LIGA and LIGA-Like Technologies
- 14.4 MEMS Electromagnetic Fundamentals and Modeling
- 14.5 MEMS Mathematical Models
 - Example 14.5.1: Mathematical Model of the Translational Microtransducer • Example 14.5.2: Mathematical Model of an Elementary Synchronous Reluctance Micromotor
 - Example 14.5.3: Mathematical Model of Two-Phase Permanent-Magnet Stepper Micromotors • Example 14.5.4: Mathematical Model of Two-Phase Permanent-Magnet Synchronous Micromotors
- 14.6 Control of MEMS
 - Proportional-Integral-Derivative Control • Tracking Control • Time-Optimal Control • Sliding Mode Control • Constrained Control of Nonlinear MEMS: Hamilton–Jacobi Method • Constrained Control of Nonlinear Uncertain MEMS: Lyapunov Method
 - Example 14.6.1: Control of Two-Phase Permanent-Magnet Stepper Micromotors
- 14.7 Conclusions

Sergey Edward Lyshevski
Purdue University Indianapolis

14.1 Introduction

Electromagnetic-based MEMS are widely used in various sensing and actuation applications. For these MEMS, rotational and translational motion microdevices are needed to be devised, designed, and controlled. We introduce the classifier paradigm to perform the structural synthesis of MEMS upon electromagnetic features. As motion microdevices are devised, the following issues are emphasized: modeling, analysis, simulation, control, optimization, and validation. Innovative results are researched and studied applying the classifier, structural synthesis, design, analysis, and optimization concepts developed. The need for innovative integrated methods to perform the comprehensive analysis, high-fidelity modeling, and design of MEMS has facilitated theoretical developments within the overall spectrum of engineering and science. This chapter provides one with viable tools to perform structural synthesis, modeling, analysis, optimization, and control of MEMS.

Microelectromechanical systems integrate motion microstructures and devices as well as ICs on a single chip or on a hybrid chip. To fabricate MEMS, modified advanced microelectronics fabrication technologies, techniques, processes, and materials are used. Due to the use of complementary metal oxide semiconductor (CMOS) lithography-based technologies in fabrication microstructures, microdevices, and ICs, MEMS leverage microelectronics.

The following definition for MEMS was given in [1]:

Batch-fabricated microscale devices (ICs and motion microstructures) that convert physical parameters to electrical signals and vice versa, and in addition, microscale features of mechanical and electrical components, architectures, structures, and parameters are important elements of their operation and design.

The scope of MEMS has been further expanded towards devising novel paradigms, system-level integration high-fidelity modeling, data-intensive analysis, control, optimization, fabrication, and implementation. Therefore, we define MEMS as:

Batch-fabricated microscale systems (motion and radiating energy microdevices/microstructures—driving/sensing circuitry—controlling/processing ICs) that

1. convert physical stimuli, events, and parameters to electrical and mechanical signals and vice versa,
2. perform actuation and sensing,
3. comprise control (intelligence, decision making, evolutionary learning, adaptation, self-organization, etc.), diagnostics, signal processing, and data acquisition features,

and microscale features of electromechanical, electronic, optical, and biological components (structures, devices, and subsystems), architectures, and operating principles are basics of their operation, design, analysis, and fabrication.

The integrated design, analysis, optimization, and virtual prototyping of intelligent and high-performance MEMS, system intelligence, learning, adaptation, decision making, and self-organization can be addressed, researched, and solved through the use of advanced electromechanical theory, state-of-the-art hardware, novel technologies, and leading-edge software. Many problems in MEMS can be formulated, attacked, and solved using the microelectromechanics. In particular, microelectromechanics deals with benchmarking and emerging problems in integrated electrical–mechanical–computer engineering, science, and technologies. Microelectromechanics is the integrated design, analysis, optimization, and virtual prototyping of high-performance MEMS, system intelligence, learning, adaptation, decision making, and control through the use of advanced hardware, leading-edge software, and novel fabrication technologies and processes. Integrated multidisciplinary features approach quickly, and the microelectromechanics takes place.

The computer-aided design tools are required to support MEMS analysis, simulation, design, optimization, and fabrication. Much effort has been devoted to attain the specified steady-state and dynamic performance of MEMS to meet the criteria and requirements imposed. Currently, MEMS are designed, optimized, and analyzed using available software packages based on the linear and steady-state analysis.

However, highly detailed nonlinear electromagnetic and mechanical modeling must be performed to design high-performance MEMS. Therefore, the research is concentrated on high-fidelity mathematical modeling, data intensive analysis, and nonlinear simulations, as well as control (design of control algorithms to attain the desired performance). The reported synthesis, modeling, analysis, simulation, optimization, and control concepts, tools, and paradigms ensure a cost-effective solution and can be used to guarantee rapid prototyping of high-performance state-of-the-art MEMS. It is often very difficult, and sometimes impossible, to solve a large array of nonlinear analysis and design problems for motion microdevices using conventional methods. Innovative concepts, methods, and tools that fully support the analysis, modeling, simulation, control, design, and optimization are needed. The fabrication technologies used in MEMS were developed [2,3], and micromachining technologies are discussed in this chapter. This chapter solves a number of long-standing problems for electromagnetic-based MEMS.

14.2 MEMS Motion Microdevice Classifier and Structural Synthesis

It was emphasized that the designer must design MEMS by devising novel high-performance motion microdevices, radiating energy microdevices, microscale driving/sensing circuitry, and controlling/processing ICs. A step-by-step procedure in the design of motion microdevices is:

- define application and environmental requirements,
- specify performance specifications,
- devise motion microstructures and microdevices, radiating energy microdevices, microscale driving/sensing circuitry, and controlling/processing ICs,
- develop the fabrication process using micromachining and CMOS technologies,
- perform electromagnetic, energy conversion, mechanical, and sizing/dimension estimates,
- perform electromagnetic, mechanical, vibroacoustic, and thermodynamic design with performance analysis and outcome prediction,
- verify, modify, and refine design with ultimate goals and objectives to optimize the performance.

In this section, the design and optimization of motion microdevices is reported.

To illustrate the procedure, consider two-phase permanent-magnet synchronous slotless micromachines as documented in Fig. 14.1.

It is evident that the electromagnetic system is *endless*, and different geometries can be utilized as shown in Fig. 14.1. In contrast, in translational (linear) synchronous micromachines, the *open-ended* electromagnetic system results. The attempts to classify microelectromechanical motion devices were made in [1,4,5]; however, the qualitative and quantitative comprehensive analysis must be researched.

Motion microstructure geometry and electromagnetic systems must be integrated into the synthesis, analysis, design, and optimization. Motion microstructures can have the plate, spherical, toroidal, conical, cylindrical, and asymmetrical geometry. Using these distinct geometry and electromagnetic systems, we propose to classify MEMS. This idea is extremely useful in the study of existing MEMS as well as in the synthesis of an infinite number of innovative motion microdevices. In particular, using the possible geometry and electromagnetic systems (*endless*, *open-ended*, and *integrated*), novel high-performance MEMS can be synthesized.

The basic electromagnetic micromachines (microdevices) under consideration are direct- and alternating-current, induction and synchronous, rotational and translational (linear). That is, microdevices are classified using a type classifier

$$Y = \{y : y \in Y\}$$

Motion microdevices are categorized using a geometric classifier (plate *P*, spherical *S*, toroidal *T*, conical *N*, cylindrical *C*, or asymmetrical *A* geometry) and an electromagnetic system classifier (*endless* *E*, *open-ended* *O*, or *integrated* *I*). The microdevice classifier, documented in Table 14.1, is partitioned

TABLE 14.1 Classification of Electromagnetic Microdevices Using the Electromagnetic System–Geometry Classifier

| M | G | Geometry | | | | | |
|------------------------|-----------------------------|-----------------|---------------------|--------------------|-------------------|-----------------------|------------------------|
| | | Plate, <i>P</i> | Spherical, <i>S</i> | Toroidal, <i>T</i> | Conical, <i>N</i> | Cylindrical, <i>C</i> | Asymmetrical, <i>A</i> |
| Electromagnetic System | Endless (Closed), <i>E</i> | | | | | | Σ |
| | Open-Ended (Open), <i>O</i> | | | | | | Σ |
| | Integrated, <i>I</i> | Σ | Σ | Σ | Σ | Σ | Σ |

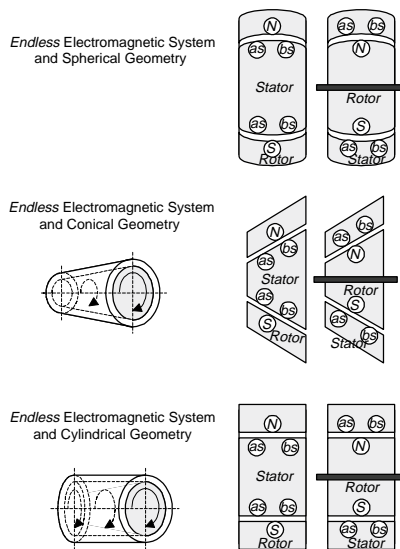

FIGURE 14.1 Permanent-magnet synchronous micromachines with different geometry.

into three horizontal and six vertical strips, and contains 18 sections, each identified by ordered pairs of characters, such as (E, P) or (O, C) .

In each ordered pair, the first entry is a letter chosen from the bounded electromagnetic system set

$$M = \{E, O, I\}$$

The second entry is a letter chosen from the geometric set

$$G = \{P, S, T, N, C, A\}$$

That is, for electromagnetic microdevices, the electromagnetic system–geometric set is

$$M \times G = \{(E, F), (E, S), (E, T), \dots, (I, N), (I, C), (I, A)\}$$

In general, we have

$$M \times G = \{(m, g) : m \in M \text{ and } g \in G\}$$

Other categorization can be applied. For example, single-, two-, three-, and multi-phase microdevices are classified using a phase classifier

$$H = \{h : h \in H\}$$

Therefore, $Y \times M \times G \times H = \{(y, m, g, h) : y \in Y, m \in M, g \in G \text{ and } h \in H\}$

Topology (radial or axial), permanent magnets shaping (strip, arc, disk, rectangular, triangular, or other shapes), permanent magnet characteristics (BH demagnetization curve, energy product, hysteresis minor loop), commutation, *emf* distribution, cooling, power, torque, size, torque-speed characteristics, as well as other distinct features of microdevices can be easily classified.

That is, the devised electromagnetic microdevices can be classified by an N -tuple as

{microdevice type, electromagnetic system, geometry, topology, phase, winding, connection, cooling}.

Using the classifier, which is given in Table 14.1 in terms of electromagnetic system–geometry, the designer can classify the existing motion microdevices as well as synthesize novel high-performance microdevices. As an example, the spherical, conical, and cylindrical geometries of a two-phase permanent-magnet synchronous microdevice are illustrated in Fig. 14.2.

This section documents new results in structural synthesis which can be used to optimize the microdevice performance. The conical (existing) and spherical-conical (devised) microdevice geometries are illustrated in Fig. 14.2. Using the innovative spherical-conical geometry, which is different compared to the existing conical geometry, one increases the active length L_r and average diameter D_r . For radial flux microdevices, the electromagnetic torque T_e is proportional to the squared rotor diameter and axial length. In particular, $T_e = k_T D_r^2 L_r$, where k_T is the constant. From the above relationship, it is evident

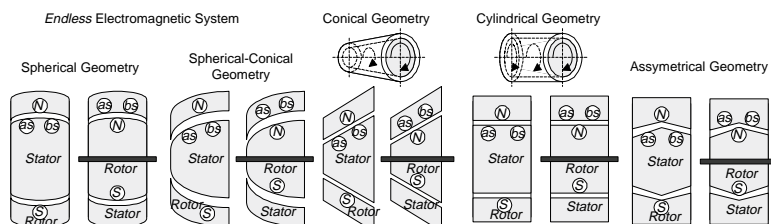

FIGURE 14.2 Two-phase permanent-magnet synchronous microdevice (micromachine) geometry.

that the spherical-conical micromotors develop higher electromagnetic torque compared with the conventional design. In addition, improved cooling, reduced undesirable torques components, as well as increased ruggedness and robustness contribute to the viability of the proposed solution. Thus, using the classifier paradigm, novel microdevices with superior performance can be devised.

14.3 MEMS Fabrication

Microelectromechanics, which integrates micromechanics and microelectronics, requires affordable, low-cost, high-yield fabrication technologies which allow one to fabricate 3-D microscale structures and devices. Micromachining is a key fabrication technology for microscale structures, devices, and MEMS. Microelectromechanical systems fabrication technologies fall into three broad categories: bulk machining, surface machining, and LIGA (LIGA-like) techniques [1–3].

Bulk Micromachining

Bulk and surface micromachining are based on the modified CMOS and specifically designed micromachining processes. Bulk micromachining of silicon uses wet and dry etching techniques in conjunction with etch masks and etch-stop-layers to develop microstructures from the silicon substrate. Microstructures are fabricated by etching areas of the silicon substrate to release the desired 3-D microstructures. The *anisotropic* and *isotropic* wet etching processes, as well as concentration dependent etching techniques, are widely used in bulk micromachining. The microstructures are formed by etching away the bulk of the silicon wafer to fabricate the desired 3-D structures. Bulk machining with its crystallographic and dopant-dependent etch processes, when combined with wafer-to-wafer bonding, produces complex 3-D microstructures with the desired geometry. Through bulk micromachining, one fabricates microstructures by etching deeply into the silicon wafer. There are several ways to etch the silicon wafer. The *anisotropic* etching uses etchants that etch different crystallographic directions at different rates. Through *anisotropic* etching, 3-D structures (cons, pyramids, cubes, and channels into the surface of the silicon wafer) are fabricated. In contrast, the *isotropic* etching etches all directions in the silicon wafer at same (or close) rate, and, therefore, hemisphere and cylinder structures can be made. Deep reactive ion etching uses plasma to etch straight walled structures (cubes, rectangular, triangular, etc.).

Surface Micromachining

Surface micromachining has become the major fabrication technology in recent years because complex 3-D microscale structures and devices can be fabricated. Surface micromachining with single-crystal silicon, polysilicon, silicon nitride, silicon oxide, and silicon dioxide (as structural and sacrificial materials which deposited and etched) is widely used to fabricate microscale structures and devices on the surface of a silicon wafer. This affordable low-cost high-yield technology is integrated with IC fabrication processes guaranteeing the needed microstructures-IC fabrication compatibility. The techniques for depositing and patterning thin films are used to produce complex microstructures and microdevices on the surface of silicon wafers (surface silicon micromachining) or on the surface of other substrates. Surface micromachining technology allows one to fabricate the structure as layers of thin films. This technology guarantees the fabrication of 3-D microdevices with high accuracy, and the surface micromachining can be called a thin film process. Each thin film is usually limited to thickness up to 5 μm , which leads to fabrication of high-performance planar-type microscale structures and devices. The advantage of surface micromachining is the use of standard CMOS fabrication processes and facilities, as well as compliance with ICs. Therefore, this technology is widely used to manufacture microscale actuators and sensors (microdevices).

Surface micromachining is based on the application of sacrificial (temporary) layers that are used to maintain subsequent layers and are removed to reveal (release) fabricated (released or suspended) microstructures. This technology was first demonstrated for ICs and applied to fabricate microstructures in the 80s. On the surface of a silicon wafer, thin layers of structural and sacrificial materials are deposited

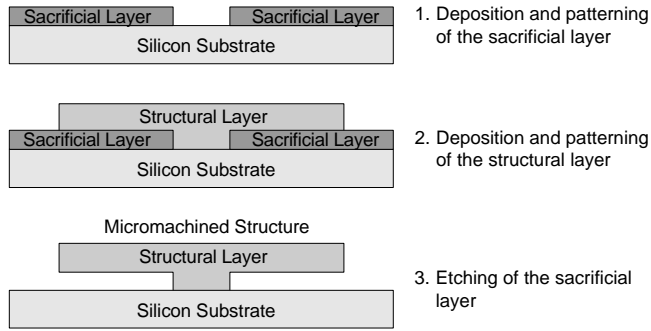

FIGURE 14.3 Surface micromachining.

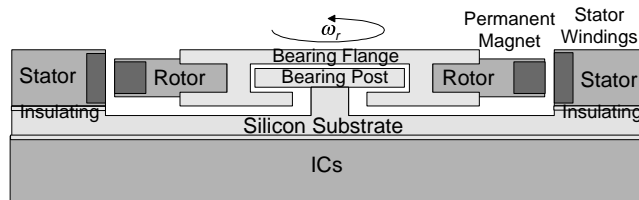

FIGURE 14.4 Cross-section schematics for slotless permanent-magnet brushless micromotor with ICs.

and patterned. Then, the sacrificial material is removed, and a micromechanical structure or device is fabricated. Figure 14.3 illustrates a typical process sequence of the surface micromachining fabrication technology.

Usually, the sacrificial layer is made of silicon dioxide (SiO_2), phosphorous-doped silicon dioxide, or silicon nitride (Si_3N_4). The structural layers are then typically formed with polysilicon, and the sacrificial layer is removed. In particular, after fabrication of the surface microstructures and microdevices (micromachines), the silicon wafer can be wet bulk etched to form cavities below the surface components, which allows a wider range of desired motion for the device. The wet etching can be done using hydrofluoric and buffered hydrofluoric acids, potassium hydroxide, ethylene-diamene-pyrocatechol, tetramethylammonium hydroxide, or sodium hydroxide. Surface micromachining technology was used to fabricate rotational micromachines [6]. For example, heavily-phosphorous-doped polysilicon can be used to fabricate rotors and stators, and silicon nitride can be applied as the structural material to attain electrical insulation. The cross-section of the slotless micromotor fabricated on the silicon substrate with polysilicon stator with deposited windings, polysilicon rotor with deposited permanent-magnets, and bearing is illustrated in Fig. 14.4. The micromotor is controlled by the driving/sensing and controlling/processing ICs. To fabricate micromotor and ICs on a single- or double-sided chip (which significantly enhances the performance), similar fabrication technologies and processes are used, and the compatibility issues are addressed and resolved. The surface micromachining processes were integrated with the CMOS technology (e.g., similar materials, lithography, etching, and other techniques). To fabricate the integrated MEMS, post-, mixed-, and pre-CMOS/micromachining techniques can be applied [1–3].

LIGA and LIGA-Like Technologies

There is a critical need to develop the fabrication technologies allowing one to fabricate high-aspect-ratio microstructures. The LIGA process, which denotes Lithography–Galvanofarming–Molding (in German words, *Lithografie–Galvanik–Abformung*), is capable of producing 3-D microstructures of up to centimeter high with the aspect ratio (depth versus lateral dimension) more than 100 [2,7,8]. The LIGA technology is based upon X-ray lithography, which guarantees shorter wavelength (in order from

few to 10 Å, which leads to negligible diffraction effects) and larger depth of focus compared with optical lithography. The ability to fabricate microstructures and microdevices in the centimeter range is particularly important in the actuators and drives applications since the specifications are imposed on the rated force and torque developed by the microdevices, and due to the limited force and torque densities, the designer faces the need to increase the actuator dimensions.

14.4 MEMS Electromagnetic Fundamentals and Modeling

The MEMS classifier, structural synthesis, and optimization were reported in Section 14.2. The classification and optimization are based on the consideration and synthesis of the electromagnetic system, analysis of the *magnetomotive* force, design of the MEMS geometry and topology, and optimization of other quantities. Different rotational (radial and axial) and translational motion microdevices are classified using *endless* (closed), *open-ended* (open), and *integrated* electromagnetic systems.

Our goal is to approach and solve a wide range of practical problems encountered in nonlinear design, modeling, analysis, control, and optimization of motion microstructures and microdevices with driving/sensing circuitry controlled by ICs for high-performance MEMS. Studying MEMS, the emphases are placed on:

- design of high-performance MEMS through devising innovative motion microdevices with radiating energy microdevices, microscale driving/sensing circuitry, and controlling/signal processing ICs,
- optimization and analysis of rotational and translation motion microdevices,
- development of high-performance signal processing and controlling ICs for microdevices devised,
- development of mathematical models with minimum level of simplifications and assumptions in the time domain,
- design of optimal robust control algorithms,
- design of intelligent systems through self-adaptation, self-organization, evolutionary learning, decision-making, and intelligence,
- development of advanced software and hardware to attain the highest degree of intelligence, integration, efficiency, and performance.

In this section, our goal is to perform nonlinear modeling, analysis, and simulation. To attain these objectives, we apply the MEMS synthesis paradigm, develop nonlinear mathematical models to model complex electromagnetic-mechanical dynamics, perform optimization, design closed-loop control systems, and perform data-intensive analysis in the time domain.

→ To model electromagnetic motion microdevices, using the magnetic vector and electric scalar potentials \vec{A} and V , respectively, one usually solves the partial differential equations

$$-\nabla^2 \vec{A} + \mu \sigma \frac{\partial \vec{A}}{\partial t} + \mu \epsilon \frac{\partial^2 \vec{A}}{\partial t^2} = -\mu \sigma \nabla V$$

using finite element analysis. Here, μ , σ , and ϵ are the permeability, conductivity, and permittivity.

However, to design electromagnetic MEMS as well as to perform electromagnetic–mechanical analysis and optimization, differential equations must be solved in the time domain. In fact, basic phenomena cannot be comprehensively modeled, analyzed, and assessed applying traditional finite element analysis, which gives the steady-state solutions and models. There is a critical need to develop the modeling tools that will allow one to augment nonlinear electromagnetics and mechanics in a single electromagnetic–mechanical modeling core to attain high-fidelity analysis with performance assessment and outcome prediction.

Operating principles of MEMS are based upon electromagnetic principles. A complete electromagnetic model is derived in terms of five electromagnetic field vectors. In particular, three electric field vectors

and two magnetic field vectors are used. The electric field vectors are the electric field intensity, \vec{E} , the electric flux density, \vec{D} , and the current density, \vec{J} . The magnetic field vectors are the magnetic field intensity \vec{H} and the magnetic field density \vec{B} . The differential equations for microelectromechanical motion device are found using Maxwell's equations, constitutive (auxiliary) equations, and classical mechanics.

Maxwell's partial differential equations in the \vec{E} - and \vec{H} -domain in the point form are

$$\begin{aligned}\nabla \times \vec{E}(x, y, z, t) &= -\mu \frac{\partial \vec{H}(x, y, z, t)}{\partial t} \\ \nabla \times \vec{H}(x, y, z, t) &= \varepsilon \frac{\partial \vec{E}(x, y, z, t)}{\partial t} + \vec{J}(x, y, z, t) = \varepsilon \frac{\partial \vec{E}(x, y, z, t)}{\partial t} + \sigma \vec{E}(x, y, z, t) \\ \nabla \cdot \vec{E}(x, y, z, t) &= \frac{\rho_v(x, y, z, t)}{\varepsilon} \\ \nabla \cdot \vec{H}(x, y, z, t) &= 0\end{aligned}$$

where ε is the permittivity, μ is the permeability, σ is the conductivity, and ρ_v is the volume charge density.

The constitutive (auxiliary) equations are given using the permittivity ε , permeability tensor μ , and conductivity σ . In particular, one has

$$\begin{aligned}\vec{D} &= \varepsilon \vec{E} \quad \text{or} \quad \vec{D} = \varepsilon \vec{E} + \vec{P} \\ \vec{B} &= \mu \vec{H} \quad \text{or} \quad \vec{B} = \mu(\vec{H} + \vec{M}) \\ \vec{J} &= \sigma \vec{E} \quad \text{or} \quad \vec{J} = \rho_v \vec{v}\end{aligned}$$

The Maxwell's equations can be solved using the boundary conditions on the field vectors. In two-region media, we have

$$\vec{a}_N \times (\vec{E}_2 - \vec{E}_1) = 0, \quad \vec{a}_N \times (\vec{H}_2 - \vec{H}_1) = \vec{J}_s, \quad \vec{a}_N \cdot (\vec{D}_2 - \vec{D}_1) = \rho_s, \quad \vec{a}_N \cdot (\vec{B}_2 - \vec{B}_1) = 0$$

where \vec{J}_s is the surface current density vector, \vec{a}_N is the surface normal unit vector at the boundary from region 2 into region 1, and ρ_s is the surface charge density.

The constitutive relations that describe media can be integrated with Maxwell's equations, which relate the fields in order to find two partial differential equations. Using the electric and magnetic field intensities \vec{E} and \vec{H} to model electromagnetic fields in MEMS, one has

$$\begin{aligned}\nabla \times (\nabla \times \vec{E}) &= \nabla(\nabla \cdot \vec{E}) - \nabla^2 \vec{E} = -\mu \frac{\partial \vec{J}}{\partial t} - \mu \frac{\partial^2 \vec{D}}{\partial t^2} = -\mu \sigma \frac{\partial \vec{E}}{\partial t} - \mu \varepsilon \frac{\partial^2 \vec{E}}{\partial t^2} \\ \nabla \times (\nabla \times \vec{H}) &= \nabla(\nabla \cdot \vec{H}) - \nabla^2 \vec{H} = -\mu \sigma \frac{\partial \vec{H}}{\partial t} - \mu \varepsilon \frac{\partial^2 \vec{H}}{\partial t^2}\end{aligned}$$

The following pair of homogeneous and inhomogeneous wave equations

$$\begin{aligned}\nabla^2 \vec{E} - \mu \sigma \frac{\partial \vec{E}}{\partial t} - \mu \varepsilon \frac{\partial^2 \vec{E}}{\partial t^2} &= \nabla \left(\frac{\rho_v}{\varepsilon} \right) \\ \nabla^2 \vec{H} - \mu \sigma \frac{\partial \vec{H}}{\partial t} - \mu \varepsilon \frac{\partial^2 \vec{H}}{\partial t^2} &= 0\end{aligned}$$

is equivalent to four Maxwell's equations and constitutive relations. For some cases, these two equations can be solved independently. It must be emphasized that it is not always possible to use the boundary conditions using only \vec{E} and \vec{H} , and thus, the problem not always can be simplified to two electromagnetic field vectors. Therefore, the electric scalar and magnetic vector potentials are used. Denoting the magnetic vector potential as \vec{A} and the electric scalar potential as V , we have

$$\nabla \times \vec{A} = \vec{B} = \mu \vec{H} \quad \text{and} \quad \vec{E} = -\frac{\partial \vec{A}}{\partial t} - \nabla V$$

The electromagnetic field is derivative from the potentials. Using the Lorentz equation

$$\nabla \cdot \vec{A} = -\frac{\partial V}{\partial t}$$

the inhomogeneous vector potential wave equation to be solved is

$$-\nabla^2 \vec{A} + \mu \sigma \frac{\partial \vec{A}}{\partial t} + \mu \epsilon \frac{\partial^2 \vec{A}}{\partial t^2} = -\mu \sigma \nabla V$$

To model motion microdevices, the mechanical equations must be used, and Newton's second law is usually applied to derive the equations of motion.

Using the volume charge density ρ_v , the Lorentz force, which relates the electromagnetic and mechanical phenomena, is found as

$$\vec{F} = \rho_v (\vec{E} + \vec{v} \times \vec{B}) = \rho_v \vec{E} + \vec{J} \times \vec{B}$$

The electromagnetic force can be found by applying the Maxwell stress tensor method. This concept employs a volume integral to obtain the stored energy, and stress at all points of a bounding surface can be determined. The sum of local stresses gives the net force. In particular, the electromagnetic stress is

$$\vec{F} = \int_v (\rho_v \vec{E} + \vec{J} \times \vec{B}) dv = \frac{1}{\mu} \oint_s \vec{T}_{\alpha\beta} \cdot d\vec{s}$$

The electromagnetic stress energy tensor (the second Maxwell stress tensor) is

$$\vec{T}_{\alpha\beta} = \begin{bmatrix} 0 & \vec{E}_x & \vec{E}_y & \vec{E}_z \\ -\vec{E}_x & 0 & \vec{B}_z & -\vec{B}_y \\ -\vec{E}_y & -\vec{B}_z & 0 & \vec{B}_x \\ -\vec{E}_z & \vec{B}_y & -\vec{B}_x & 0 \end{bmatrix}$$

In general, the electromagnetic torque developed by motion microstructures is found using the electromagnetic field. In particular, the electromagnetic stress tensor is given as

$$T_s = T_s^E + T_s^M$$

$$= \begin{bmatrix} E_1 D_1 - \frac{1}{2} E_j D_j & E_1 D_2 & E_1 D_3 \\ E_2 D_1 & E_2 D_2 - \frac{1}{2} E_j D_j & E_2 D_3 \\ E_3 D_1 & E_3 D_2 & E_3 D_3 - \frac{1}{2} E_j D_j \end{bmatrix} + \begin{bmatrix} B_1 H_1 - \frac{1}{2} B_j H_j & B_1 H_2 & B_1 H_3 \\ B_2 H_1 & B_2 H_2 - \frac{1}{2} B_j H_j & B_2 H_3 \\ B_3 H_1 & B_3 H_2 & B_3 H_3 - \frac{1}{2} B_j H_j \end{bmatrix}$$

For the Cartesian, cylindrical, and spherical coordinate systems, which can be used to develop the mathematical model, we have

$$\begin{aligned}
 E_x &= E_1, E_y = E_2, E_z = E_3, & D_x &= D_1, D_y = D_2, D_z = D_3, \\
 H_x &= H_1, H_y = H_2, H_z = H_3, & B_x &= B_1, B_y = B_2, B_z = B_3 \\
 E_r &= E_1, E_\theta = E_2, E_z = E_3, & D_r &= D_1, D_\theta = D_2, D_z = D_3, \\
 H_r &= H_1, H_\theta = H_2, H_z = H_3, & B_r &= B_1, B_\theta = B_2, B_z = B_3 \\
 E_\rho &= E_1, E_\theta = E_2, E_\phi = E_3, & D_\rho &= D_1, D_\theta = D_2, D_\phi = D_3, \\
 H_\rho &= H_1, H_\theta = H_2, H_\phi = H_3, & B_\rho &= B_1, B_\theta = B_2, B_\phi = B_3
 \end{aligned}$$

Maxwell's equations can be solved using the MATLAB environment.

In motion microdevices, the designer analyzes the torque or force production mechanisms.

Newton's second law for rotational and translational motions is

$$\begin{aligned}
 \frac{d\omega_r}{dt} &= \frac{1}{J} \sum \vec{T}_\Sigma, & \frac{d\theta_r}{dt} &= \omega_r \\
 \frac{dv}{dt} &= \frac{1}{m} \sum \vec{F}_\Sigma, & \frac{dx}{dt} &= v
 \end{aligned}$$

where ω_r and θ_r are the angular velocity and displacement, v and x are the linear velocity and displacement, $\sum \vec{T}_\Sigma$ is the net torque, $\sum \vec{F}_\Sigma$ is the net force, J is the equivalent moment of inertia, and m is the mass.

14.5 MEMS Mathematical Models

The problems of modeling and control of MEMS are very important in many applications. A mathematical model is a mathematical description (in the form of functions or equations) of MEMS, which integrate motion microdevices (microscale actuators and sensors), radiating energy microdevices, microscale driving/sensing circuitry, and controlling/signal processing ICs. The purpose of the model development is to understand and comprehend the phenomena, as well as to analyze the end-to-end behavior.

To model MEMS, advanced analysis methods are required to accurately cope with the involved highly complex physical phenomena, effects, and processes. The need for high-fidelity analysis, computationally-efficient algorithms, and simulation time reduction increases significantly for complex microdevices, restricting the application of Maxwell's equations to problems possible to solve. As was illustrated in the previous section, nonlinear electromagnetic and energy conversion phenomena are described by the partial differential equations. The application of Maxwell's equations fulfills the need for data-intensive analysis capabilities with outcome prediction within overall modeling domains as particularly necessary for simulation and analysis of high-performance MEMS. In addition, other modeling and analysis methods are applied. The lumped mathematical models, described by ordinary differential equations, can be used. The process of mathematical modeling and model development is given below.

The first step is to formulate the modeling problem:

- examine and analyze MEMS using a multilevel hierarchy concept, develop multivariable input-output subsystem pairs, e.g., motion microstructures (microscale actuators and sensors), radiating energy microdevices, microscale circuitry, ICs, controller, input/output devices;
- understand and comprehend the MEMS structure and system configuration;
- gather the data and information;
- develop input-output variable pairs, identify the independent and dependent control, disturbance, output, reference (command), state and performance variables, as well as events;

- making accurate assumptions, simplify the problem to make the studied MEMS mathematically tractable (mathematical models, which are the idealization of physical phenomena, are never absolutely accurate, and comprehensive mathematical models simplify the reality to allow the designer to perform a thorough analysis and make accurate predictions of the system performance).

The second step is to derive equations that relate the variables and events:

- define and specify the basic laws (Kirchhoff, Lagrange, Maxwell, Newton, and others) to be used to obtain the equations of motion. Mathematical models of electromagnetic, electronic, and mechanical microscale subsystems can be found and augmented to derive mathematical models of MEMS using defined variables and events;
- derive mathematical models;

The third step is the simulation, analysis, and validation:

- identify the numerical and analytic methods to be used in analysis and simulations;
- analytically and/or numerically solve the mathematical equations (e.g., differential or difference equations, nonlinear equations, etc.);
- using information variables (measured or observed) and events, synthesize the fitting and mismatch functionals;
- verify the results through the comprehensive comparison of the solution (model input-state-output-event mapping sets) with the experimental data (experimental input-state-output-event mapping sets);
- calculate the fitting and mismatch functionals;
- examine the analytical and numerical data against new experimental data and evidence.

If the matching with the desired accuracy is not guaranteed, the mathematical model of MEMS must be refined, and the designer must start the cycle again.

Electromagnetic theory and classical mechanics form the basis for the development of mathematical models of MEMS. It was illustrated that MEMS can be modeled using Maxwell's equations and *torsional-mechanical* equations of motion. However, from modeling, analysis, design, control, and simulation perspectives, the mathematical models as given by ordinary differential equations can be derived and used.

Consider the rotational microstructure (bar magnet, current loop, and microsolenoid) in a uniform magnetic field, see Fig. 14.5. The microstructure rotates if the electromagnetic torque is developed. The electromagnetic field must be studied to find the electromagnetic torque.

The torque tends to align the magnetic moment \vec{m} with \vec{B} , and

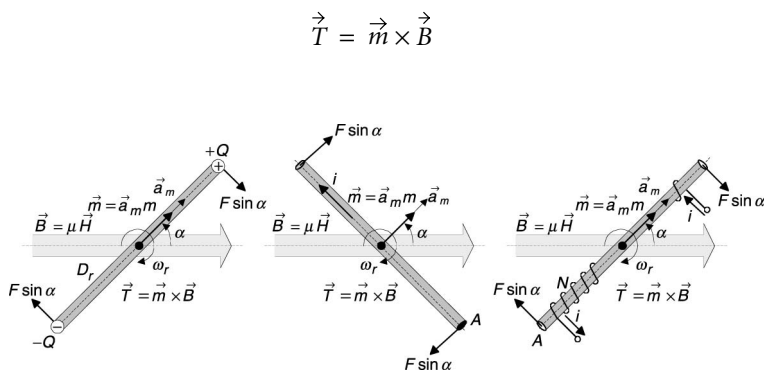

FIGURE 14.5 Clockwise rotation of the motion microstructure.

For a microstructure with outside diameter D_r , the magnet strength is Q . Hence, the magnetic moment is $m = QD_r$, and the force is found as $F = QB$.

The electromagnetic torque is

$$T = 2F \frac{1}{2} D_r \sin \alpha = QD_r B \sin \alpha = mB \sin \alpha$$

Using the unit vector in the magnetic moment direction \vec{a}_m , one obtains

$$\vec{T} = \vec{m} \times \vec{B} = \vec{a}_m m \times \vec{B} = QD_r \vec{a}_m \times \vec{B}$$

For a current loop with the area A , the torque is found as

$$\vec{T} = \vec{m} \times \vec{B} = \vec{a}_m m \times \vec{B} = iA \vec{a}_m \times \vec{B}$$

For a solenoid with N turns, one obtains

$$\vec{T} = \vec{m} \times \vec{B} = \vec{a}_m m \times \vec{B} = iAN \vec{a}_m \times \vec{B}$$

As the electromagnetic torque is found, using Newton's second law, one has

$$\frac{d\omega_r}{dt} = \frac{1}{J} \sum \vec{T}_\Sigma = \frac{1}{J} (\vec{T} - \vec{T}_L), \quad \frac{d\theta_r}{dt} = \omega_r$$

where \vec{T}_L is the load torque.

The *electromotive (emf)* and *magnetomotive (mmf)* forces can be used in the model development.

We have

$$\text{emf} = \oint_l \vec{E} \cdot d\vec{l} = \underbrace{\oint_l (\vec{v} \times \vec{B}) \cdot d\vec{l}}_{\text{motional induction generation}} - \underbrace{\int_s \frac{\partial \vec{B}}{\partial t} \cdot d\vec{s}}_{\text{transformer induction}}$$

and

$$\text{mmf} = \int_l \vec{H} \cdot d\vec{l} = \oint_s \vec{J} \cdot d\vec{s} + \oint_s \frac{\partial \vec{D}}{\partial t} \cdot d\vec{s}$$

For preliminary design, it is sufficiently accurate to apply Faraday's or Lenz's laws, which give the electromotive force in term of the time-varying magnetic field changes. In particular,

$$\text{emf} = -\frac{d\psi}{dt} = -\frac{\partial \psi}{\partial t} - \frac{\partial \psi}{\partial \theta_r} \frac{d\theta_r}{dt} = -\frac{\partial \psi}{\partial t} - \frac{\partial \psi}{\partial \theta_r} \omega_r$$

where $\frac{\partial \psi}{\partial t}$ is the transformer term.

The total flux linkages are

$$\psi = \frac{1}{4} \pi N_s \Phi_p$$

where N_s is the number of turns and Φ_p is the flux per pole.

For radial topology micromachines, we have

$$\Phi_p = \frac{\mu i N_s}{P^2 g_e} R_{\text{in st}} L$$

where i is the current in the phase microwinding (supplied by the IC), $R_{\text{in st}}$ is the inner stator radius, L is the inductance, P is the number of poles, and g_e is the equivalent gap, which includes the airgap and radial thickness of the permanent magnet.

Denoting the number of turns per phase as N_s , the magnetomotive force is

$$\text{mmf} = \frac{iN_s}{P} \cos P\theta_r$$

The simplified expression for the electromagnetic torque for radial topology brushless micromachines is

$$T = \frac{1}{2}PB_{\text{ag}}i_sN_sL_rD_r$$

where B_{ag} is the air gap flux density, $B_{\text{ag}} = (\mu_iN_s/2Pg_e)\cos P\theta_r$, i_s is the total current, L_r is the active length (rotor axial length), and D_r is the outside rotor diameter.

The axial topology brushless micromachines can be designed and fabricated. The electromagnetic torque is given as

$$T = k_{\text{ax}}B_{\text{ag}}i_sN_sD_a^2$$

where k_{ax} is the nonlinear coefficient, which is found in terms of active conductors and thin-film permanent magnet length; and D_a is the equivalent diameter, which is a function of windings and permanent-magnet topography.

Example 14.5.1: Mathematical Model of the Translational Microtransducer

Figure 14.6 illustrates a simple translational microstructure with a stationary member and movable translational microstructure (plunger), which can be fabricated using continuous batch-fabrication process [2]. The winding can be “printed” using the micromachining/CMOS technology.

We apply Newton’s second law of motion to study the dynamics. Newton’s law states that the acceleration of an object is proportional to the net force. The vector sum of all forces is found as

$$F(t) = m \frac{d^2x}{dt^2} + B_v \frac{dx}{dt} + (k_{s1}x + k_{s2}x^2) + F_e(t)$$

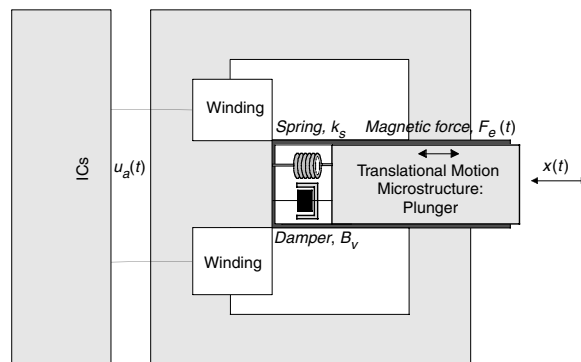

FIGURE 14.6 Microtransducer schematics with translational motion microstructure.

where x is the displacement of a translational microstructure (plunger), m is the mass of a movable plunger, B_v is the viscous friction coefficient, k_{s1} and k_{s2} are the spring constants (the spring can be made from polysilicon), and $F_e(t)$ is the magnetic force which is found using the coenergy W_c , $F_e(i, x) = \frac{\partial W_c(i, x)}{\partial x}$.

The stretch and restoring forces are not directly proportional to the displacement, and these forces are different on either side of the equilibrium position. The restoring/stretching force exerted by the polysilicon spring is expressed as $(k_{s1}x + k_{s2}x^2)$.

Assuming that the magnetic system is linear, the coenergy is expressed as

$$W_c(i, x) = \frac{1}{2}L(x)i^2$$

Then

$$F_e(i, x) = \frac{1}{2}i^2 \frac{dL(x)}{dx}$$

The inductance is found as

$$L(x) = \frac{N^2}{\mathfrak{R}_f + \mathfrak{R}_g} = \frac{N^2 \mu_f \mu_0 A_f A_g}{A_g l_f + 2A_f \mu_f (x + 2d)}$$

where \mathfrak{R}_f and \mathfrak{R}_g are the reluctances of the ferromagnetic material and air gap, A_f and A_g are the associated cross section areas, and l_f and $(x + 2d)$ are the lengths of the magnetic material and the air gap. Hence

$$\frac{dL}{dx} = -\frac{2N^2 \mu_f^2 \mu_0 A_f^2 A_g}{[A_g l_f + 2A_f \mu_f (x + 2d)]^2}$$

Using Kirchhoff's law, the voltage equation for the phase microcircuitry is

$$u_a = ri + \frac{d\psi}{dt}$$

where the flux linkage ψ is expressed as $\psi = L(x)i$.

One obtains

$$u_a = ri + L(x) \frac{di}{dt} + i \frac{dL(x)}{dx} \frac{dx}{dt}$$

and thus

$$\frac{di}{dt} = -\frac{r}{L(x)}i + \frac{2N^2 \mu_f^2 \mu_0 A_f^2 A_g}{L(x)[A_g l_f + 2A_f \mu_f (x + 2d)]^2} iv + \frac{1}{L(x)} u_a$$

Augmenting this equation with differential equation

$$F(t) = m \frac{d^2 x}{dt^2} + B_v \frac{dx}{dt} + (k_{s1}x + k_{s2}x^2) + F_e(t)$$

three nonlinear differential equations for the studied translation microdevice are found as

$$\frac{di}{dt} = -\frac{r[A_g l_f + 2A_f \mu_f(x + 2d)]}{N^2 \mu_f \mu_0 A_f A_g} i + \frac{2\mu_f A_f}{A_g l_f + 2A_f \mu_f(x + 2d)} i v + \frac{A_g l_f + 2A_f \mu_f(x + 2d)}{N^2 \mu_f \mu_0 A_f A_g} u_a$$

$$\frac{dx}{dt} = v$$

$$\frac{dv}{dt} = \frac{N^2 \mu_f^2 \mu_0 A_f^2 A_g}{m[A_g l_f + 2A_f \mu_f(x + 2d)]^2} i^2 - \frac{1}{m}(k_{s1}x + k_{s2}x^2) - \frac{B_v}{m}v$$

Example 14.5.2: Mathematical Model of an Elementary Synchronous Reluctance Micromotor

Consider a single-phase reluctance micromotor, which can be straightforwardly fabricated using conventional CMOS, LIGA, and LIGA-like technologies. Ferromagnetic materials are used to fabricate microscale stator and rotor, and windings can be deposited on the stator, see Fig. 14.7.

The *quadrature* and *direct* magnetic axes are fixed with the microrotor, which rotates with angular velocity ω_r . These magnetic axes rotate with the angular velocity ω . Assume that the initial conditions are zero. Hence, the angular displacements of the rotor θ_r and the angular displacement of the *quadrature* magnetic axis θ are equal, and

$$\theta_r = \theta = \int_{t_0}^t \omega_r(\tau) d\tau = \int_{t_0}^t \omega(\tau) d\tau.$$

The magnetizing reluctance \mathfrak{R}_m is a function of the rotor angular displacement θ_r . Using the number of turns N_s , the magnetizing inductance is

$$L_m(\theta_r) = \frac{N_s^2}{\mathfrak{R}_m(\theta_r)}.$$

This magnetizing inductance varies twice per one revolution of the rotor and has minimum and maximum values, and

$$L_{m \min} = \frac{N_s^2}{\mathfrak{R}_{m \max}(\theta_r)} \Big|_{\theta_r=0, \pi, 2\pi, \dots}, \quad L_{m \max} = \frac{N_s^2}{\mathfrak{R}_{m \min}(\theta_r)} \Big|_{\theta_r=\frac{1}{2}\pi, \frac{3}{2}\pi, \frac{5}{2}\pi, \dots}$$

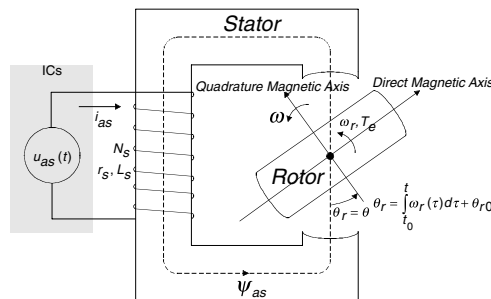

FIGURE 14.7 Microscale single-phase reluctance motor with rotational motion microstructure (microrotor).



FIGURE 14.8 Magnetizing inductance $L_m(\theta_r)$.

Assume that this variation is a sinusoidal function of the rotor angular displacement. Then,

$$L_m(\theta_r) = \bar{L}_m - L_{\Delta m} \cos 2\theta_r$$

where \bar{L}_m is the average value of the magnetizing inductance and $L_{\Delta m}$ is half of the amplitude of the sinusoidal variation of the magnetizing inductance.

The plot for $L_m(\theta_r)$ is documented in Fig. 14.8.

The electromagnetic torque, developed by single-phase reluctance motors is found using the expression for the coenergy $W_c(i_{as}, \theta_r)$. From $W_c(i_{as}, \theta_r) = \frac{1}{2}(L_{ls} + \bar{L}_m - L_{\Delta m} \cos 2\theta_r) i_{as}^2$, one finds

$$T_e = \frac{\partial W_c(i_{as}, \theta_r)}{\partial \theta_r} = \frac{\partial [\frac{1}{2} i_{as}^2 (L_{ls} + \bar{L}_m - L_{\Delta m} \cos 2\theta_r)]}{\partial \theta_r} = L_{\Delta m} i_{as}^2 \sin 2\theta_r$$

The electromagnetic torque is not developed by synchronous reluctance motors if IC feeds the dc current or voltage to the motor winding because $T_e = L_{\Delta m} i_{as}^2 \sin 2\theta_r$. Hence, conventional control algorithms cannot be applied, and new methods, which are based upon electromagnetic features must be researched. The average value of T_e is not equal to zero if the current is a function of θ_r . As an illustration, let us assume that the following current is fed to the motor winding:

$$i_{as} = i_M \operatorname{Re}(\sqrt{\sin 2\theta_r})$$

Then, the electromagnetic torque is

$$T_e = L_{\Delta m} i_{as}^2 \sin 2\theta_r = L_{\Delta m} i_M^2 (\operatorname{Re} \sqrt{\sin 2\theta_r})^2 \sin 2\theta_r \neq 0$$

and

$$T_{e \text{ av}} = \frac{1}{\pi} \int_0^\pi L_{\Delta m} i_{as}^2 \sin 2\theta_r d\theta_r = \frac{1}{4} L_{\Delta m} i_M^2$$

The mathematical model of the microscale single-phase reluctance motor is found by using Kirchhoff's and Newton's second laws

$$u_{as} = r_s i_{as} + \frac{d\psi_{as}}{dt} \quad (\text{circuitry equation})$$

$$T_e - B_m \omega_r - T_L = J \frac{d^2 \theta_r}{dt^2} \quad (\text{torsional-mechanical equation})$$

From $\psi_{as} = (L_{ls} + \bar{L}_m - L_{\Delta m} \cos 2\theta_r) i_{as}$, one obtains a set of three first-order nonlinear differential equations. In particular, we have

$$\begin{aligned}\frac{di_{as}}{dt} &= \frac{r_s}{L_{ls} + \bar{L}_m - L_{\Delta m} \cos 2\theta_r} i_{as} - \frac{2L_{\Delta m}}{L_{ls} + \bar{L}_m - L_{\Delta m} \cos 2\theta_r} i_{as} \omega_r \sin 2\theta_r + \frac{1}{L_{ls} + \bar{L}_m - L_{\Delta m} \cos 2\theta_r} u_{as} \\ \frac{d\omega_r}{dt} &= \frac{1}{J} (L_{\Delta m} i_{as}^2 \sin 2\theta_r - B_m \omega_r - T_L) \\ \frac{d\theta_r}{dt} &= \omega_r\end{aligned}$$

Example 14.5.3: Mathematical Model of Two-Phase Permanent-Magnet Stepper Micromotors

For two-phase permanent-magnet stepper micromotors, we have

$$\begin{aligned}u_{as} &= r_s i_{as} + \frac{d\psi_{as}}{dt} \\ u_{bs} &= r_s i_{bs} + \frac{d\psi_{bs}}{dt}\end{aligned}$$

where the flux linkages are $\psi_{as} = L_{asas} i_{as} + L_{asbs} i_{bs} + \psi_{asm}$ and $\psi_{bs} = L_{bsas} i_{as} + L_{bsbs} i_{bs} + \psi_{bsm}$.

Here, u_{as} and u_{bs} are the phase voltages in the stator microwindings as and bs ; i_{as} and i_{bs} are the phase currents in the stator microwindings; ψ_{as} and ψ_{bs} are the stator flux linkages; r_s are the resistances of the stator microwindings; L_{asas} , L_{asbs} , L_{bsas} , and L_{bsbs} are the mutual inductances.

The electrical angular velocity and displacement are found using the number of rotor tooth RT ,

$$\begin{aligned}\omega_r &= RT\omega_{rm} \\ \theta_r &= RT\theta_{rm}\end{aligned}$$

where ω_r and ω_{rm} are the electrical and rotor angular velocities, and θ_r and θ_{rm} are the electrical and rotor angular displacements.

The flux linkages are functions of the number of the rotor tooth RT , and the magnitude of the flux linkages produced by the permanent magnets ψ_m . In particular,

$$\psi_{asm} = \psi_m \cos(RT\theta_{rm}) \quad \text{and} \quad \psi_{bsm} = \psi_m \sin(RT\theta_{rm})$$

The self-inductance of the stator windings is

$$L_{ss} = L_{asas} = L_{bsbs} = L_{ls} + \bar{L}_m$$

The stator microwindings are displaced by 90 electrical degrees. Hence, the mutual inductances between the stator microwindings are zero, $L_{asbs} = L_{bsas} = 0$.

Then, we have

$$\psi_{as} = L_{ss} i_{as} + \psi_m \cos(RT\theta_{rm}) \quad \text{and} \quad \psi_{bs} = L_{ss} i_{bs} + \psi_m \sin(RT\theta_{rm})$$

Taking note of the circuitry equations, one has

$$u_{as} = r_s i_{as} + \frac{d[L_{ss} i_{as} + \psi_m \cos(RT\theta_{rm})]}{dt} = r_s i_{as} + L_{ss} \frac{di_{as}}{dt} - RT\psi_m \omega_{rm} \sin(RT\theta_{rm})$$

$$u_{bs} = r_s i_{bs} + \frac{d[L_{ss} i_{bs} + \psi_m \sin(RT\theta_{rm})]}{dt} = r_s i_{bs} + L_{ss} \frac{di_{bs}}{dt} + RT\psi_m \omega_{rm} \cos(RT\theta_{rm})$$

Therefore, we obtain

$$\frac{di_{as}}{dt} = -\frac{r_s}{L_{ss}} i_{as} + \frac{RT\psi_m}{L_{ss}} \omega_{rm} \sin(RT\theta_{rm}) + \frac{1}{L_{ss}} u_{as}$$

$$\frac{di_{bs}}{dt} = -\frac{r_s}{L_{ss}} i_{bs} - \frac{RT\psi_m}{L_{ss}} \omega_{rm} \cos(RT\theta_{rm}) + \frac{1}{L_{ss}} u_{bs}$$

Using Newton's second law, we have

$$\frac{d\omega_{rm}}{dt} = \frac{1}{J} (T_e - B_m \omega_{rm} - T_L)$$

$$\frac{d\theta_{rm}}{dt} = \omega_{rm}$$

The expression for the electromagnetic torque developed by permanent-magnet stepper micromotors must be found. Taking note of the relationship for the coenergy

$$W_c = \frac{1}{2} (L_{ss} i_{as}^2 + L_{ss} i_{bs}^2) + \psi_m i_{as} \cos(RT\theta_{rm}) + \psi_m i_{bs} \sin(RT\theta_{rm}) + W_{PM}$$

one finds the electromagnetic torque:

$$T_e = \frac{\partial W_c}{\partial \theta_{rm}} = -RT\psi_m [i_{as} \sin(RT\theta_{rm}) - i_{bs} \cos(RT\theta_{rm})]$$

Hence, the transient evolution of the phase currents i_{as} and i_{bs} , rotor angular velocity ω_{rm} , and displacement θ_{rm} , is modeled by the following differential equations:

$$\frac{di_{as}}{dt} = -\frac{r_s}{L_{ss}} i_{as} + \frac{RT\psi_m}{L_{ss}} \omega_{rm} \sin(RT\theta_{rm}) + \frac{1}{L_{ss}} u_{as}$$

$$\frac{di_{bs}}{dt} = -\frac{r_s}{L_{ss}} i_{bs} - \frac{RT\psi_m}{L_{ss}} \omega_{rm} \cos(RT\theta_{rm}) + \frac{1}{L_{ss}} u_{bs}$$

$$\frac{d\omega_{rm}}{dt} = -\frac{RT\psi_m}{J} [i_{as} \sin(RT\theta_{rm}) - i_{bs} \cos(RT\theta_{rm})] - \frac{B_m}{J} \omega_{rm} - \frac{1}{J} T_L$$

$$\frac{d\theta_{rm}}{dt} = \omega_{rm}$$

These four nonlinear differential equations are rewritten in the state-space form as

$$\begin{bmatrix} \frac{di_{as}}{dt} \\ \frac{di_{bs}}{dt} \\ \frac{d\omega_{rm}}{dt} \\ \frac{d\theta_{rm}}{dt} \end{bmatrix} = \begin{bmatrix} \frac{r_s}{L_{ss}} & 0 & 0 & 0 \\ 0 & -\frac{r_s}{L_{ss}} & 0 & 0 \\ 0 & 0 & \frac{B_m}{J} & 0 \\ 0 & 0 & 1 & 0 \end{bmatrix} \begin{bmatrix} i_{as} \\ i_{bs} \\ \omega_{rm} \\ \theta_{rm} \end{bmatrix} + \begin{bmatrix} \frac{RT\psi_m}{L_{ss}}\omega_{rm}\sin(RT\theta_{rm}) \\ -\frac{RT\psi_m}{L_{ss}}\omega_{rm}\cos(RT\theta_{rm}) \\ -\frac{RT\psi_m}{J}[i_{as}\sin(RT\theta_{rm}) - i_{bs}\cos(RT\theta_{rm})] \\ 0 \end{bmatrix}$$

$$+ \begin{bmatrix} \frac{1}{L_{ss}} & 0 \\ 0 & \frac{1}{L_{ss}} \\ 0 & 0 \\ 0 & 0 \end{bmatrix} \begin{bmatrix} u_{as} \\ u_{bs} \end{bmatrix} - \begin{bmatrix} 0 \\ 0 \\ \frac{1}{J} \\ 0 \end{bmatrix} T_L$$

The analysis of the torque equation

$$T_e = -RT\psi_m[i_{as}\sin(RT\theta_{rm}) - i_{bs}\cos(RT\theta_{rm})]$$

guides one to the conclusion that the expressions for a balanced two-phase current sinusoidal set is

$$i_{as} = -\sqrt{2}i_M\sin(RT\theta_{rm}) \quad \text{and} \quad i_{bs} = \sqrt{2}i_M\cos(RT\theta_{rm})$$

If these phase currents are fed, the electromagnetic torque is a function of the current magnitude i_M , and

$$T_e = \sqrt{2}RT\psi_m i_M$$

The phase currents needed to be fed are the functions of the rotor angular displacement. Assuming that the inductances are negligibly small, we have the following phase voltages needed to be supplied:

$$u_{as} = -\sqrt{2}u_M\sin(RT\theta_{rm}) \quad \text{and} \quad u_{bs} = \sqrt{2}u_M\cos(RT\theta_{rm})$$

Example 14.5.4: Mathematical Model of Two-Phase Permanent-Magnet Synchronous Micromotors

Consider two-phase permanent-magnet synchronous micromotors. Using Kirchhoff's voltage law, we have

$$u_{as} = r_s i_{as} + \frac{d\psi_{as}}{dt}$$

$$u_{bs} = r_s i_{bs} + \frac{d\psi_{bs}}{dt}$$

where the flux linkages are expressed as $\psi_{as} = L_{asas}i_{as} + L_{asbs}i_{bs} + \psi_{asm}$ and $\psi_{bs} = L_{bsas}i_{as} + L_{bsbs}i_{bs} + \psi_{bsm}$.

The flux linkages are periodic functions of the angular displacement (rotor position), and let

$$\psi_{asm} = \psi_m \sin \theta_{rm} \quad \text{and} \quad \psi_{bsm} = -\psi_m \cos \theta_{rm}$$

The self-inductances of the stator windings are found to be

$$L_{ss} = L_{asas} = L_{bsbs} = L_{ls} + \bar{L}_m$$

The stator windings are displaced by 90 electrical degrees, and hence, the mutual inductances between the stator windings are $L_{asbs} = L_{bsas} = 0$. Thus, we have

$$\psi_{as} = L_{ss}i_{as} + \psi_m \sin \theta_{rm} \quad \text{and} \quad \psi_{bs} = L_{ss}i_{bs} - \psi_m \cos \theta_{rm}$$

Therefore, one finds

$$u_{as} = r_s i_{as} + \frac{d(L_{ss}i_{as} + \psi_m \sin \theta_{rm})}{dt} = r_s i_{as} + L_{ss} \frac{di_{as}}{dt} + \psi_m \omega_{rm} \cos \theta_{rm}$$

$$u_{bs} = r_s i_{bs} + \frac{d(L_{ss}i_{bs} - \psi_m \cos \theta_{rm})}{dt} = r_s i_{bs} + L_{ss} \frac{di_{bs}}{dt} - \psi_m \omega_{rm} \sin \theta_{rm}$$

Using Newton's second law

$$T_e - B_m \omega_{rm} - T_L = J \frac{d^2 \theta_{rm}}{dt^2}$$

we have

$$\frac{d\omega_{rm}}{dt} = \frac{1}{J}(T_e - B_m \omega_{rm} - T_L)$$

$$\frac{d\theta_{rm}}{dt} = \omega_{rm}$$

The expression for the electromagnetic torque developed by permanent-magnet motors can be obtained by using the coenergy

$$W_c = \frac{1}{2}(L_{ss}i_{as}^2 + L_{ss}i_{bs}^2) + \psi_m i_{as} \sin \theta_{rm} - \psi_m i_{bs} \cos \theta_{rm} + W_{PM}$$

Then, one has

$$T_e = \frac{\partial W_c}{\partial \theta_{rm}} = \frac{P\psi_m}{2}(i_{as} \cos \theta_{rm} + i_{bs} \sin \theta_{rm})$$

Augmenting the circuitry transients with the *torsional-mechanical* dynamics, one finds the mathematical model of two-phase permanent-magnet micromotors in the following form:

$$\frac{di_{as}}{dt} = -\frac{r_s}{L_{ss}}i_{as} - \frac{\psi_m}{L_{ss}}\omega_{rm} \cos \theta_{rm} + \frac{1}{L_{ss}}u_{as}$$

$$\frac{di_{bs}}{dt} = -\frac{r_s}{L_{ss}}i_{bs} + \frac{\psi_m}{L_{ss}}\omega_{rm} \sin \theta_{rm} + \frac{1}{L_{ss}}u_{bs}$$

$$\frac{d\omega_{rm}}{dt} = \frac{P\psi_m}{2J}(i_{as} \cos \theta_{rm} + i_{bs} \sin \theta_{rm}) - \frac{B_m}{J}\omega_{rm} - \frac{1}{J}T_L$$

$$\frac{d\theta_{rm}}{dt} = \omega_{rm}$$

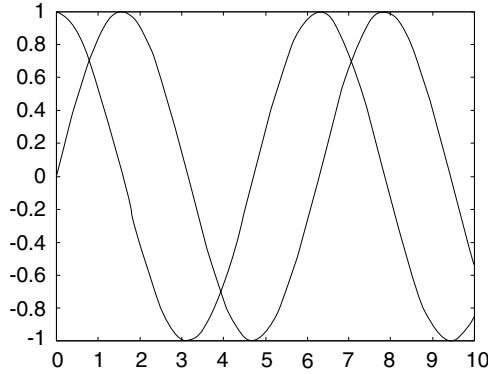

FIGURE 14.9 Air-gap mmf and the phase current waveforms.

For two-phase motors (assuming the sinusoidal winding distributions and the sinusoidal mmf waveforms), the electromagnetic torque is expressed as

$$T_e = \frac{P\Psi_m}{2}(i_{as}\cos\theta_{rm} + i_{bs}\sin\theta_{rm})$$

Hence, to guarantee the balanced operation, one feeds

$$i_{as} = \sqrt{2}i_M\cos\theta_{rm} \quad \text{and} \quad i_{bs} = \sqrt{2}i_M\sin\theta_{rm}$$

to maximize the electromagnetic torque. In fact, one obtains

$$T_e = \frac{P\Psi_m}{2}(i_{as}\cos\theta_{rm} + i_{bs}\sin\theta_{rm}) = \frac{P\Psi_m}{2}\sqrt{2}i_M(\cos^2\theta_{rm} + \sin^2\theta_{rm}) = \frac{P\Psi_m}{\sqrt{2}}i_M$$

The air-gap mmf and the phase current waveforms are plotted in Fig. 14.9.

14.6 Control of MEMS

Mathematical models of MEMS can be developed with different degrees of complexity. It must be emphasized that in addition to the models of microscale motion devices, the fast dynamics of ICs should be examined. Due to the complexity of complete mathematical models of ICs, impracticality of the developed equations, and very fast dynamics, the IC dynamics can be modeled using reduced-order differential equation or as unmodeled dynamics. For MEMS, modeled using linear and nonlinear differential equations

$$\begin{aligned} \dot{x}(t) &= Ax + Bu, \quad u_{\min} \leq u \leq u_{\max}, \quad y = Hx \\ \dot{x}(t) &= F_z(t, x, r, z) + B_p(t, x, p)u, \quad u_{\min} \leq u \leq u_{\max}, \quad y = H(x) \end{aligned}$$

different control algorithms can be designed.

Here, the state, control, output, and reference (command) vectors are denoted as x , u , y , and r ; parameter uncertainties (e.g., time-varying coefficients, unmodeled dynamics, unpredicted changes, etc.) are modeled using z and p vectors.

The matrices of coefficients are A , B , and H . The smooth mapping fields of the nonlinear model are denoted as $F_z(\cdot)$, $B_p(\cdot)$, and $H(\cdot)$.

It should be emphasized that the control is bounded. For example, using the IC duty ratio d_D as the control signal, we have $0 \leq d_D \leq 1$ or $-1 \leq d_D \leq +1$. Four-quadrant ICs are used due to superior performance, and $-1 \leq d_D \leq +1$. Hence, we have $-1 \leq u \leq +1$. However, in general, $u_{\min} \leq u \leq u_{\max}$.

Proportional-Integral-Derivative Control

Many MEMS can be controlled by the proportional-integral-derivative (PID) controllers, which, taking note of control bounds, are given as [9]

$$u(t) = \text{sat}_{u_{\min}}^{u_{\max}} \left(e, \int e dt, \frac{de}{dt} \right)$$

$$= \text{sat}_{u_{\min}}^{u_{\max}} \left(\underbrace{\sum_{j=0}^{\zeta} k_{pj} e^{\frac{2j+1}{2\beta+1}}}_{\text{proportional}} + \underbrace{\sum_{j=0}^{\sigma} k_{ij} \int e^{\frac{2j+1}{2\mu+1}} dt}_{\text{integral}} + \underbrace{\sum_{j=0}^{\alpha} k_{dj} e^{\frac{2j+1}{2\gamma+1}}}_{\text{derivative}} \right), \quad u_{\min} \leq u \leq u_{\max}$$

where k_{pj} , k_{ij} , and k_{dj} are the matrices of the proportional, integral, and derivative feedback gains; ζ , β , σ , μ , α , and γ are the nonnegative integers.

In the nonlinear PID controllers, the tracking error is used. In particular,

$$e(t) = \underbrace{r(t)}_{\text{reference/command}} - \underbrace{y(t)}_{\text{output}}$$

Linear bounded controllers can be straightforwardly designed. For example, letting $\zeta = \beta = \sigma = \mu = 0$, we have the following linear PI control law:

$$u(t) = \text{sat}_{u_{\min}}^{u_{\max}} \left(k_{p0} e(t) + k_{i0} \int e t dt \right)$$

The PID controllers with the state feedback extension can be synthesized as

$$u(t) = \text{sat}_{u_{\min}}^{u_{\max}} (e, x)$$

$$= \text{sat}_{u_{\min}}^{u_{\max}} \left(\underbrace{\sum_{j=0}^{\zeta} k_{pj} e^{\frac{2j+1}{2\beta+1}}}_{\text{proportional}} + \underbrace{\sum_{j=0}^{\sigma} k_{ij} \int e^{\frac{2j+1}{2\mu+1}} dt}_{\text{integral}} + \underbrace{\sum_{j=0}^{\alpha} k_{dj} e^{\frac{2j+1}{2\gamma+1}}}_{\text{derivative}} + G(t)B \frac{\partial V(e, x)}{\partial \begin{bmatrix} e \\ x \end{bmatrix}} \right), \quad u_{\min} \leq u \leq u_{\max}$$

where $V(e, x)$ is the function that satisfies the general requirements imposed on the Lyapunov pair [9], e.g., the sufficient conditions for stability are used.

It is evident that nonlinear feedback mappings result, and the nonquadratic function $V(e, x)$ can be synthesized and used to obtain the control algorithm and feedback gains.

Tracking Control

Tracking control is designed for the augmented systems, which are modeled using the state variables and the reference dynamics. In particular, from

$$\dot{x}(t) = Ax + Bu, \quad \dot{x}^{\text{ref}}(t) = r(t) - y(t) = r(t) - Hx(t)$$

one finds

$$\dot{x}_\Sigma(t) = A_\Sigma x_\Sigma + B_\Sigma u + N_\Sigma r, \quad y = Hx, \quad x_\Sigma = \begin{bmatrix} x \\ x^{\text{ref}} \end{bmatrix}, \quad A_\Sigma = \begin{bmatrix} A & 0 \\ -H & 0 \end{bmatrix}, \quad B_\Sigma = \begin{bmatrix} B \\ 0 \end{bmatrix}, \quad N_\Sigma = \begin{bmatrix} 0 \\ I \end{bmatrix}$$

Minimizing the quadratic performance functional

$$J = \frac{1}{2} \int_{t_0}^{t_f} (x_\Sigma^T Q x_\Sigma + u^T G u) dt$$

one finds the control law using the first-order necessary condition for optimality. In particular, we have

$$u = -G^{-1} B_\Sigma^T \frac{\partial V}{\partial x_\Sigma} = -G^{-1} \begin{bmatrix} B \\ 0 \end{bmatrix}^T \frac{\partial V}{\partial x_\Sigma}$$

Here, Q is the positive semi-definite constant-coefficient matrix, and G is the positive weighting constant-coefficient matrix.

The solution of the Hamilton–Jacobi equation

$$-\frac{\partial V}{\partial t} = \frac{1}{2} x_\Sigma^T Q x_\Sigma + \left(\frac{\partial V}{\partial x_\Sigma} \right)^T A x_\Sigma - \frac{1}{2} \left(\frac{\partial V}{\partial x_\Sigma} \right)^T B_\Sigma G^{-1} B_\Sigma^T \frac{\partial V}{\partial x_\Sigma}$$

is satisfied by the quadratic return function $V = \frac{1}{2} x_\Sigma^T K x_\Sigma$. Here, K is the symmetric matrix, which must be found by solving the nonlinear differential equation

$$-\dot{K} = Q + A_\Sigma^T K + K^T A_\Sigma - K^T B_\Sigma G^{-1} B_\Sigma^T K, \quad K(t_f) = K_f$$

The controller is given as

$$u = -G^{-1} B_\Sigma^T K x_\Sigma = -G^{-1} \begin{bmatrix} B \\ 0 \end{bmatrix}^T K x_\Sigma$$

From $\dot{x}_{\text{ref}}(t) = e(t)$, one has

$$x_{\text{ref}}(t) = \int e(t) dt$$

Therefore, we obtain the integral control law

$$u(t) = -G^{-1} \begin{bmatrix} B \\ 0 \end{bmatrix}^T K \begin{bmatrix} x(t) \\ \int e(t) dt \end{bmatrix}$$

In this control algorithm, the error vector is used in addition to the state feedback.

As was illustrated, the bounds are imposed on the control, and $u_{\min} \leq u \leq u_{\max}$. Therefore, the bounded controllers must be designed. Using the nonquadratic performance functional [9]

$$J = \int_{t_0}^{t_f} \left(x_\Sigma^T Q x_\Sigma + G \int \tan^{-1} u du \right) dt$$

with positive semi-definite constant-coefficient matrix Q and positive-definite matrix G , one finds

$$u(t) = -\tanh\left(G^{-1}\begin{bmatrix} B \\ 0 \end{bmatrix}^T K \begin{bmatrix} x(t) \\ \int e(t) dt \end{bmatrix}\right) \approx -\text{sat}_{-1}^+ \left(G^{-1}\begin{bmatrix} B \\ 0 \end{bmatrix}^T K \begin{bmatrix} x(t) \\ \int e(t) dt \end{bmatrix}\right), \quad -1 \leq u \leq 1$$

This controller is obtained assuming that the solution of the functional partial differential equation can be approximated by the quadratic return function

$$V = \frac{1}{2} x_{\Sigma}^T K x_{\Sigma}$$

where K is the symmetric matrix.

Time-Optimal Control

A time-optimal controller can be designed using the functional

$$J = \frac{1}{2} \int_{t_0}^{t_f} (x_{\Sigma}^T Q x_{\Sigma}) dt$$

Taking note of the Hamilton–Jacobi equation

$$-\frac{\partial V}{\partial t} = \min_{-1 \leq u \leq 1} \left[\frac{1}{2} x_{\Sigma}^T Q x_{\Sigma} + \left(\frac{\partial V}{\partial x_{\Sigma}} \right)^T (A x_{\Sigma} + B_{\Sigma} u) \right]$$

the relay-type controller is found to be

$$u = -\text{sgn} \left(B_{\Sigma}^T \frac{\partial V}{\partial x_{\Sigma}} \right), \quad -1 \leq u \leq 1$$

This “optimal” control algorithm cannot be implemented in practice due to the chattering phenomenon. Therefore, relay-type control laws with dead zone

$$u = -\text{sgn} \left(B_{\Sigma}^T \frac{\partial V}{\partial x_{\Sigma}} \right) \Bigg|_{\text{dead zone}}, \quad -1 \leq u \leq 1$$

are commonly used.

Sliding Mode Control

Soft-switching sliding mode control laws are synthesized in [9]. Sliding mode soft-switching algorithms provide superior performance, and the chattering effect is eliminated.

To design controllers, we model the states and errors dynamics as

$$\begin{aligned} \dot{x}(t) &= Ax + Bu, \quad -1 \leq u \leq 1 \\ \dot{e}(t) &= N\dot{r}(t) - HAx - HBu \end{aligned}$$

The smooth sliding manifold is

$$\begin{aligned} M &= \{(t, x, e) \in R_{\geq 0} \times X \times E \mid v(t, x, e) = 0\} \\ &= \bigcap_{j=1}^m \{(t, x, e) \in R_{\geq 0} \times X \times E \mid v_j(t, x, e) = 0\} \end{aligned}$$

The time-varying nonlinear switching surface is $v(t, x, e) = K_{ux}(t, x, e) = 0$. The soft-switching control law is given as

$$u(t, x, e) = -G\phi(v), \quad -1 \leq u \leq 1, \quad G > 0$$

where $\phi(\cdot)$ is the continuous real-analytic function of class C^ϵ ($\epsilon \geq 1$), for example, \tanh and erf .

Constrained Control of Nonlinear MEMS: Hamilton–Jacobi Method

Constrained optimization of MEMS is a topic of great practical interest. Using the Hamilton–Jacobi theory, the bounded controllers can be synthesized for continuous-time systems modeled as

$$\begin{aligned} \dot{x}^{\text{MEMS}}(t) &= F_s(x^{\text{MEMS}}) + B_s(x^{\text{MEMS}})u^{2w+1}, & y &= Hx^{\text{MEMS}} \\ u_{\min} \leq u \leq u_{\max}, & x^{\text{MEMS}}(t_0) &= x_0^{\text{MEMS}} \end{aligned}$$

Here, $x^{\text{MEMS}} \in X_s$ is the state vector; $u \in U$ is the vector of control inputs; $y \in Y$ is the measured output; $F_s(\cdot)$, $B_s(\cdot)$ and $H(\cdot)$ are the smooth mappings; $F_s(0) = 0$, $B_s(0) = 0$, and $H(0) = 0$; and w is the nonnegative integer.

To design the tracking controller, we augment the MEMS dynamics

$$\begin{aligned} \dot{x}^{\text{MEMS}}(t) &= F_s(x^{\text{MEMS}}) + B_s(x^{\text{MEMS}})u^{2w+1} & y &= H(x^{\text{MEMS}}) \\ u_{\min} \leq u \leq u_{\max}, & x^{\text{MEMS}}(t_0) &= x_0^{\text{MEMS}} \end{aligned}$$

with the *exogenous* dynamics $\dot{x}^{\text{ref}}(t) = Nr - y = Nr - H(x^{\text{MEMS}})$.

Using the augmented state vector

$$x = \begin{bmatrix} x^{\text{MEMS}} \\ x^{\text{ref}} \end{bmatrix} \in X$$

one obtains

$$\begin{aligned} \dot{x}(t) &= F(x, r) + B(x)u^{2w+1}, \quad u_{\min} \leq u \leq u_{\max}, \quad x(t_0) = x_0, \quad x = \begin{bmatrix} x^{\text{MEMS}} \\ x^{\text{ref}} \end{bmatrix} \\ F(x, r) &= \begin{bmatrix} F_s(x^{\text{MEMS}}) \\ -H(x^{\text{MEMS}}) \end{bmatrix} + \begin{bmatrix} 0 \\ N \end{bmatrix} r, & B(x) &= \begin{bmatrix} B_s(x^{\text{MEMS}}) \\ 0 \end{bmatrix} \end{aligned}$$

The set of admissible control U consists of the Lebesgue measurable function $u(\cdot)$, and a bounded controller should be designed within the constrained control set

$$U = \{u \in \mathbb{R}^m \mid u_{i\min} \leq u_i \leq u_{i\max}, \quad i = 1, \dots, m\}.$$

We map the control bounds imposed by a bounded, integrable, one-to-one, globally Lipschitz, vector-valued continuous function $\Phi \in C^\epsilon$ ($\epsilon \geq 1$). Our goal is to analytically design the bounded admissible state-feedback controller in the closed form as $u = \Phi(x)$. The most common Φ are the algebraic and transcendental (exponential, hyperbolic, logarithmic, trigonometric) continuously differentiable, integrable, one-to-one functions. For example, the odd one-to-one integrable function \tanh with domain $(-\infty, +\infty)$ maps the control bounds. This function has the corresponding inverse function \tanh^{-1} with range $(-\infty, +\infty)$.

The performance cost to be minimized is given as

$$J = \int_{t_0}^{\infty} [W_x(x) + W_u(u)] dt = \int_{t_0}^{\infty} \left[W_x(x) + (2w+1) \int (\Phi^{-1}(u))^T G^{-1} \text{diag}(u^{2w}) du \right] dt$$

where $G^{-1} \in \mathbb{R}^{m \times m}$ is the positive-definite diagonal matrix.

Performance integrands $W_x(\cdot)$ and $W_u(\cdot)$ are real-valued, positive-definite, and continuously differentiable integrand functions. Using the properties of Φ one concludes that inverse function Φ^{-1} is integrable. Hence, integral

$$\int (\Phi^{-1}(u))^T G^{-1} \text{diag}(u^{2w}) du$$

exists.

Example

Consider a nonlinear dynamic system

$$\frac{dx}{dt} = ax + bu^3, \quad u_{\min} \leq u \leq u_{\max}$$

Taking note of

$$W_u(u) = (2w + 1) \int (\Phi^{-1}(u))^T G^{-1} \text{diag}(u^{2w}) du$$

one has the positive-definite integrand

$$W_u(u) = 3 \int \tanh^{-1} u G^{-1} u^2 du = \frac{1}{3} u^3 \tanh^{-1} u + \frac{1}{6} u^2 + \frac{1}{6} \ln(1 - u^2), \quad G^{-1} = \frac{1}{3}$$

In general, if the hyperbolic tangent is used to map the saturation effect, for the single-input case, one has

$$W_u(u) = (2w + 1) \int u^{2w} \tanh^{-1} \frac{u}{k} du = u^{2w+1} \tanh^{-1} \frac{u}{k} - k \int \frac{u^{2w+1}}{k^2 - u^2} du$$

Necessary conditions that the control function $u(\cdot)$ guarantees a minimum to the Hamiltonian

$$H = W_x(x) + (2w + 1) \int (\Phi^{-1}(u))^T G^{-1} \text{diag}(u^{2w}) du + \frac{\partial V(x)^T}{\partial x} [F(x, r) + B(x)u^{2w+1}]$$

are: first-order necessary condition $n1$,

$$\frac{\partial H}{\partial u} = 0$$

and second-order necessary condition $n2$,

$$\frac{\partial^2 H}{\partial u \times \partial u^T} > 0$$

The positive-definite return function $V(\cdot)$, $V \in C^\kappa$, $\kappa \geq 1$, is

$$V(x_0) = \inf_{u \in U} J(x_0, u) = \inf_{u \in U} J(x_0, \Phi(\cdot)) \geq 0$$

The Hamilton–Jacobi–Bellman equation is given as

$$-\frac{\partial V}{\partial t} = \min_{u \in U} \left\{ W_x(x) + (2w + 1) \int (\Phi^{-1}(u))^T G^{-1} \text{diag}(u^{2w}) du + \frac{\partial V(x)^T}{\partial x} [F(x, r) + B(x)u^{2w+1}] \right\}$$

The controller should be derived by finding the control value that attains the minimum to nonquadratic functional. The first-order necessary condition (n1) leads us to an admissible bounded control law. In particular,

$$u = -\Phi\left(GB(x)^T \frac{\partial V(x)}{\partial x}\right), \quad u \in U$$

The second-order necessary condition for optimality (n2) is met because the matrix G^{-1} is positive-definite. Hence, a unique, bounded, real-analytic, and continuous control candidate is designed.

If there exists a proper function $V(x)$ which satisfies the Hamilton–Jacobi equation, the resulting closed-loop system is robustly stable in the specified state X and control U sets, and robust tracking is ensured in the convex and compact set $XY(X_0, U, R, E_0)$. That is, there exists an invariant domain of stability

$$S = \{x \in \mathbb{R}^c, e \in \mathbb{R}^b: \|x(t)\| \leq \mathcal{Q}_x(\|x_0\|, t) + \mathcal{Q}_u(\|u\|), \|e(t)\| \leq \mathcal{Q}_e(\|e_0\|, t) + \mathcal{Q}_r(\|r\|) + \mathcal{Q}_y(\|y\|), \\ \forall x \in X(X_0, U), \forall t \in [t_0, \infty), \forall e \in E(E_0, R, Y)\} \subset \mathbb{R}^c \times \mathbb{R}^b,$$

and control $u(\cdot)$, $u \in U$ steers the tracking error to the set

$$S_E(\delta) = \{e \in \mathbb{R}^b: e_0 \in E_0, x \in X(X_0, U), r \in R, y \in Y, t \in [t_0, \infty) \\ \|\|e(t)\| \leq \mathcal{Q}_e(\|e_0\|, t) + \delta, \delta \geq 0, \forall e \in E(E_0, R, Y), \forall t \in [t_0, \infty)\} \subset \mathbb{R}^b$$

Here \mathcal{Q}_x and \mathcal{Q}_e are the KL-functions; and \mathcal{Q}_u , \mathcal{Q}_r , and \mathcal{Q}_y are the K-functions.

The solution of the functional equation should be found using nonquadratic return functions. To obtain $V(\cdot)$, the performance cost must be evaluated at the allowed values of the states and control. Linear and nonlinear functionals admit the final values, and the minimum value of the nonquadratic cost is given by power-series forms [9]. That is,

$$J_{\min} = \sum_{i=0}^{\eta} v(x_0) \frac{2^{(i+\gamma+1)}}{2^{2\gamma+1}}, \quad \eta = 0, 1, 2, \dots, \quad \gamma = 0, 1, 2, \dots$$

The solution of the partial differential equation is satisfied by a continuously differentiable positive-definite return function

$$V(x) = \sum_{i=0}^{\eta} \frac{2\gamma+1}{2(i+\gamma+1)} \left(x^{\frac{i+\gamma+1}{2\gamma+1}}\right)^T K_i x^{\frac{i+\gamma+1}{2\gamma+1}}$$

where matrices K_i are found by solving the Hamilton–Jacobi equation.

The quadratic return function in $V(x) = \frac{1}{2}x^T K_0 x$ is found by letting $\eta = \gamma = 0$. This quadratic candidate may be employed only if the designer enables to neglect the high-order terms in Taylor’s series expansion. Using $\eta = 1$ and $\gamma = 0$, one obtains

$$V(x) = \frac{1}{2}x^T K_0 x + \frac{1}{4}(x^2)^T K_1 x^2$$

while for $\eta = 4$ and $\gamma = 1$, we have the following function:

$$V(x) = \frac{3}{4}(x^{2/3})^T K_0 x^{2/3} + \frac{1}{2}x^T K_1 x + \frac{3}{8}(x^{4/3})^T K_2 x^{4/3} + \frac{3}{10}(x^{5/3})^T K_3 x^{5/3} + \frac{1}{4}(x^2)^T K_4 x^2$$

The nonlinear bounded controller is given as

$$u = -\Phi \left(GB(x)^T \sum_{i=0}^{\eta} \text{diag} \left[x(t)^{\frac{i-\gamma}{2\gamma+1}} \right] K_i(t) x(t)^{\frac{i+\gamma+1}{2\gamma+1}} \right),$$

$$\text{diag} \left[x(t)^{\frac{i-\gamma}{2\gamma+1}} \right] = \begin{bmatrix} x_1^{\frac{i-\gamma}{2\gamma+1}} & 0 & \cdots & 0 & 0 \\ 0 & x_2^{\frac{i-\gamma}{2\gamma+1}} & \cdots & 0 & 0 \\ \vdots & \vdots & \ddots & \vdots & \vdots \\ 0 & 0 & \cdots & x_{c-1}^{\frac{i-\gamma}{2\gamma+1}} & 0 \\ 0 & 0 & \vdots & 0 & x_c^{\frac{i-\gamma}{2\gamma+1}} \end{bmatrix}$$

If matrices K_i are diagonal, we have the following control algorithm:

$$u = -\Phi \left(GB(x)^T \sum_{i=0}^{\eta} K_i x^{\frac{2i+1}{2\gamma+1}} \right)$$

Constrained Control of Nonlinear Uncertain MEMS: Lyapunov Method

Over the horizon $[t_0, \infty)$ we consider the dynamics of MEMS modeled as

$$\dot{x}(t) = F_z(t, x, r, z) + B_p(t, x, p)u, \quad y = H(x), \quad u_{\min} \leq u \leq u_{\max}, \quad x(t_0) = x_0$$

where $t \in \mathbb{R}_{\geq 0}$ is the time; $x \in X$ is the state-space vector; $u \in U$ is the vector of bounded control inputs; $r \in R$ and $y \in Y$ are the measured reference and output vectors; $z \in Z$ and $p \in P$ are the parameter uncertainties, functions $z(\cdot)$ and $p(\cdot)$ are Lebesgue measurable and known within bounds; Z and P are the known nonempty compact sets; and $F_z(\cdot)$, $B_p(\cdot)$, and $H(\cdot)$ are the smooth mapping fields.

Let us formulate and solve the motion control problem by synthesizing robust controllers that guarantee stability and robust tracking. Our goal is to design control laws that robustly stabilize nonlinear systems with uncertain parameters and drive the tracking error $e(t) = r(t) - y(t)$, $e \in E$ robustly to the compact set. For MEMS modeled by nonlinear differential equations with parameter variations, the robust tracking of the measured output vector $y \in Y$ must be accomplished with respect to the measured uniformly bounded reference input vector $r \in R$.

The *nominal* and uncertain dynamics are mapped by $F(\cdot)$, $B(\cdot)$, and $\Xi(\cdot)$. Hence, the system evolution is described as

$$\dot{x}(t) = F(t, x, r) + B(t, x)u + \Xi(t, x, u, z, p), \quad y = H(x), \quad u_{\min} \leq u \leq u_{\max}, \quad x(t_0) = x_0$$

There exists a norm of $\Xi(t, x, u, z, p)$, and $\|\Xi(t, x, u, z, p)\| \leq \rho(t, x)$, where $\rho(\cdot)$ is the continuous Lebesgue measurable function. Our goal is to solve the motion control problem, and tracking controllers must be synthesized using the tracking error vector and the state variables. Furthermore, to guarantee robustness and to expand stability margins, to improve dynamic performance, and to meet other requirements, nonquadratic Lyapunov functions $V(t, e, x)$ will be used in stability analysis and design of robust tracking control laws.

Suppose that a set of admissible control U consists of the Lebesgue measurable function $u(\cdot)$. It was demonstrated that the Hamilton–Jacobi theory can be used to find control laws, and the minimization of nonquadratic performance functionals leads one to the bounded controllers.

Letting $u = \Phi(t, e, x)$, one obtains a set of admissible controllers. Applying the error and state feedback we define a family of tracking controllers as

$$u = \Omega(x)\Phi(t, e, x) = -\Omega(x)\Phi\left(G_E(t)B_E(t, x)^T \frac{1}{s} \frac{\partial V(t, e, x)}{\partial e} + G_X(t)B(t, x)^T \frac{\partial V(t, e, x)}{\partial x}\right), \quad s = \frac{d}{dt}$$

where $\Omega(\cdot)$ is the nonlinear function; $G_E(\cdot)$ and $G_X(\cdot)$ are the diagonal matrix-functions defined on $[t_0, \infty)$; $B_E(\cdot)$ is the matrix-function; and $V(\cdot)$ is the continuous, differentiable, and real-analytic function.

Let us design the Lyapunov function. This problem is a critical one and involves well-known difficulties. The quadratic Lyapunov candidates can be used. However, for uncertain nonlinear systems, nonquadratic functions $V(t, e, x)$ allow one to realize the full potential of the Lyapunov-based theory and lead us to the nonlinear feedback maps which are needed to achieve conflicting design objectives. We introduce the following family of Lyapunov candidates:

$$V(t, e, x) = \sum_{i=0}^{\zeta} \frac{2\beta+1}{2(i+\beta+1)} \left(e^{\frac{i+\beta+1}{2\beta+1}}\right)^T K_{Ei}(t) e^{\frac{i+\beta+1}{2\beta+1}} + \sum_{i=0}^{\eta} \frac{2\gamma+1}{2(i+\gamma+1)} \left(x^{\frac{i+\gamma+1}{2\gamma+1}}\right)^T K_{Xi}(t) x^{\frac{i+\gamma+1}{2\gamma+1}}$$

where $K_{Ei}(\cdot)$ and $K_{Xi}(\cdot)$ are the symmetric matrices; ζ, β, η , and γ are the nonnegative integers; $\zeta = 0, 1, 2, \dots$; $\beta = 0, 1, 2, \dots$; $\eta = 0, 1, 2, \dots$; and $\gamma = 0, 1, 2, \dots$

The well-known quadratic form of $V(t, e, x)$ is found by letting $\zeta = \beta = \eta = \gamma = 0$, and we have

$$V(t, e, x) = \frac{1}{2} e^T K_{E0}(t) e + \frac{1}{2} x^T K_{X0}(t) x$$

By using $\zeta = 1, \beta = 0, \eta = 1$, and $\gamma = 0$, one obtains a nonquadratic candidate:

$$V(t, e, x) = \frac{1}{2} e^T K_{E0}(t) e + \frac{1}{4} e^{2T} K_{E1}(t) e^2 + \frac{1}{2} x^T K_{X0}(t) x + \frac{1}{4} x^{2T} K_{X1}(t) x^2$$

One obtains the following tracking control law:

$$u = -\Omega(x)\Phi\left(G_E(t)B_E(t, x)^T \sum_{i=0}^{\zeta} \text{diag}\left[e(t)^{\frac{i-\beta}{2\beta+1}}\right] K_{Ei}(t) \frac{1}{s} e(t)^{\frac{i+\beta+1}{2\beta+1}} + G_X(t)B(t, x)^T \sum_{i=0}^{\eta} \text{diag}\left[x(t)^{\frac{i-\gamma}{2\gamma+1}}\right] K_{Xi}(t) x(t)^{\frac{i+\gamma+1}{2\gamma+1}}\right)$$

$$\text{diag}\left[e(t)^{\frac{i-\beta}{2\beta+1}}\right] = \begin{bmatrix} e_1^{\frac{i-\beta}{2\beta+1}} & 0 & \cdots & 0 & 0 \\ 0 & e_2^{\frac{i-\beta}{2\beta+1}} & \cdots & 0 & 0 \\ \vdots & \vdots & \ddots & \vdots & \vdots \\ 0 & 0 & \cdots & e_{b-1}^{\frac{i-\beta}{2\beta+1}} & 0 \\ 0 & 0 & \vdots & 0 & e_b^{\frac{i-\beta}{2\beta+1}} \end{bmatrix}$$

and

$$\text{diag}\left[x(t)^{\frac{i-\gamma}{2\gamma+1}}\right] = \begin{bmatrix} x_1^{\frac{i-\gamma}{2\gamma+1}} & 0 & \cdots & 0 & 0 \\ 0 & x_2^{\frac{i-\gamma}{2\gamma+1}} & \cdots & 0 & 0 \\ \vdots & \vdots & \ddots & \vdots & \vdots \\ 0 & 0 & \cdots & x_{n-1}^{\frac{i-\gamma}{2\gamma+1}} & 0 \\ 0 & 0 & \vdots & 0 & x_n^{\frac{i-\gamma}{2\gamma+1}} \end{bmatrix}$$

If matrices K_{Ei} and K_{Xi} are diagonal, we have

$$u = -\Omega(x)\Phi\left(G_E(t)B_E(t,x)^T \sum_{i=0}^{\zeta} K_{Ei}(t) \frac{1}{s} e(t)^{\frac{2i+1}{2\beta+1}} + G_X(t)B(t,x)^T \sum_{i=0}^{\eta} K_{Xi}(t)x(t)^{\frac{2i+1}{2\gamma+1}}\right)$$

A closed-loop uncertain system is robustly stable in $X(X_0, U, Z, P)$ and robust tracking is guaranteed in the convex and compact set $E(E_0, Y, R)$ if for reference inputs $r \in R$ and uncertainties in Z and P there exists a C^κ ($\kappa \geq 1$) function $V(\cdot)$, as well as K_∞ -functions $\rho_{X1}(\cdot)$, $\rho_{X2}(\cdot)$, $\rho_{E1}(\cdot)$, $\rho_{E2}(\cdot)$ and K -functions $\rho_{X3}(\cdot)$, $\rho_{E3}(\cdot)$, such that the following sufficient conditions:

$$\begin{aligned} \rho_{X1}(\|x\|) + \rho_{E1}(\|e\|) &\leq V(t, e, x) \leq \rho_{X2}(\|x\|) + \rho_{E2}(\|e\|) \\ \frac{dV(t, e, x)}{dt} &\leq -\rho_{X3}(\|x\|) - \rho_{E3}(\|e\|) \end{aligned}$$

are guaranteed in an invariant domain of stability S , and $XE(X_0, E_0, U, R, Z, P) \subseteq S$.

The sufficient conditions under which the robust control problem is solvable were given. Computing the derivative of the $V(t, e, x)$, the unknown coefficients of $V(t, e, x)$ can be found. That is, matrices $K_{Ei}(\cdot)$ and $K_{Xi}(\cdot)$ are obtained. This problem is solved using the nonlinear inequality concept [9].

Example 14.6.1: Control of Two-Phase Permanent-Magnet Stepper Micromotors

High-performance MEMS with permanent-magnet stepper micromotors have been designed and manufactured. Controllers are needed to be designed to control permanent-magnet stepper micromotors, and the angular velocity and position are regulated by changing the magnitude of the voltages applied or currents fed to the stator windings (see Example 14.5.3). The rotor displacement is measured or observed in order to properly apply the voltages to the phase windings. To solve the motion control problem, the controller must be designed. It is illustrated that novel control algorithms are needed to be deployed to maximize the torque developed. In fact, conventional controllers

$$u = -G^{-1}B^T \frac{\partial V}{\partial x} \quad \text{and} \quad u = -\Phi\left(G^{-1}B^T \frac{\partial V}{\partial x}\right)$$

cannot be used.

Using the coenergy concept, one finds the expression for the electromagnetic torque as given by

$$T_e = -RT\psi_m [i_{as} \sin(RT\theta_{rm}) - i_{bs} \cos(RT\theta_{rm})]$$

and thus, one must feed the phase currents as sinusoidal and cosinusoidal functions of the rotor displacement.

The mathematical model of permanent-magnet stepper micromotor was found in [Example 14.5.3](#) as

$$\begin{aligned}\frac{di_{as}}{dt} &= -\frac{r_s}{L_{ss}}i_{as} + \frac{RT\psi_m}{L_{ss}}\omega_{rm}\sin(RT\theta_{rm}) + \frac{1}{L_{ss}}u_{as} \\ \frac{di_{bs}}{dt} &= -\frac{r_s}{L_{ss}}i_{bs} - \frac{RT\psi_m}{L_{ss}}\omega_{rm}\cos(RT\theta_{rm}) + \frac{1}{L_{ss}}u_{bs} \\ \frac{d\omega_{rm}}{dt} &= -\frac{RT\psi_m}{J}[i_{as}\sin(RT\theta_{rm}) - i_{bs}\cos(RT\theta_{rm})] - \frac{B_m}{J}\omega_{rm} - \frac{1}{J}T_L \\ \frac{d\theta_{rm}}{dt} &= \omega_{rm}\end{aligned}$$

The rotor resistance is a function of temperature because the resistivity is $\rho_T = \rho_0[(1 + \alpha_p(T^\circ - 20^\circ))]$. Hence, $r_s(\cdot) \in [r_{s\min} \ r_{s\max}]$. The susceptibility of the permanent magnets (thin films) decreases with increasing temperature. Other servo-system parameters also vary; in particular, $L_{ss}(\cdot) \in [L_{ss\min} \ L_{ss\max}]$ and $B_m(\cdot) \in [B_{m\min} \ B_{m\max}]$.

The following equation of motion in vector form results:

$$\dot{x}(t) = F_z(t, x, r, d, z) + B_p(p)u, \quad u_{\min} \leq u \leq u_{\max}$$

$$x(t_0) = x_0, \quad x = \begin{bmatrix} i_{as} \\ i_{bs} \\ \omega_{rm} \\ \theta_{rm} \end{bmatrix}, \quad u = \begin{bmatrix} u_{as} \\ u_{bs} \end{bmatrix}, \quad y = \theta_{rm}$$

Here, $x \in X$ and $u \in U$ are the state and control vectors, $r \in R$ and $y \in Y$ are the measured reference and output, $d \in D$ is the disturbance, $d = T_L$, and $z \in Z$ and $p \in P$ are the unknown and bounded parameter uncertainties.

Our goal is to design the bounded control $u(\cdot)$ within the constrained set

$$U = \{u \in \mathbb{R}^2: u_{\min} \leq u \leq u_{\max}, u_{\min} < 0, u_{\max} > 0\} \subset \mathbb{R}^2$$

An admissible control law, which guarantees a balanced two-phase voltage applied to the ab windings and ensures the maximal electromagnetic torque production, is synthesized as

$$\begin{aligned}u &= \begin{bmatrix} u_{as} \\ u_{bs} \end{bmatrix} = \begin{bmatrix} -\sin(RT\theta_{rm}) & 0 \\ 0 & \cos(RT\theta_{rm}) \end{bmatrix} \\ &\quad \times \Phi \left(G_x(t)B^T \frac{\partial V(t, x, e)}{\partial x} + G_e(t)B_e^T \frac{\partial V(t, x, e)}{\partial e} + G_i(t)B_e^T \frac{1}{s} \frac{\partial V(t, x, e)}{\partial e} \right)\end{aligned}$$

where $e \in E$ is the measured tracking error, $e(t) = r(t) - y(t)$; $\Phi(\cdot)$ is the bounded function (erf, sat, tanh), and $\Phi \in U$, $|\Phi(\cdot)| \leq V_{\max}$, V_{\max} is the rated voltage; $G_x(\cdot)$, $G_e(\cdot)$, and $G_i(\cdot)$ are bounded and symmetric, $G_x > 0$, $G_e > 0$, $G_i > 0$; and $V(\cdot)$ is the C^k ($k \geq 1$) continuously differentiable, real-analytic function.

For $X_0 \subseteq X$, $u \in U$, $r \in R$, $d \in D$, $z \in Z$, and $p \in P$, we obtain the state evolution set X . The state-output set is

$$XY(X_0, U, R, D, Z, P) = \{(x, y) \in X \times Y: x_0 \in X_0, u \in U, r \in R, d \in D, z \in Z, p \in P, t \in [t_0, \infty)\}$$

and a *reference-output* map can be found. Our goal is to find the bounded controller such that the tracking error $e(\cdot): [t_0, \infty) \rightarrow E$ with $E_0 \subseteq E$ evolves in the specified closed set

$$S_\varepsilon(\delta) = \{e \in \mathbb{R}^1 : e_0 \in E_0, x \in X(X_0, U, R, D, Z, P), t \in [t_0, \infty) | \\ \|e(t)\| \leq \rho_e(t, \|e_0\|) + \rho_r(\|r\|) + \rho_d(\|d\|) + \rho_y(\|y\|) + \delta, \delta \geq 0, \forall e \in E(E_0, R, D, Y), \forall t \in [t_0, \infty)\}$$

Here, $\rho_e(\cdot)$ is the KL-function; $\rho_r(\cdot)$, $\rho_d(\cdot)$ and $\rho_y(\cdot)$ are the K-functions.

A positive-invariant domain of stability is found for the closed-loop system with $x_0 \in X_0$, $e_0 \in E_0$, $u \in U$, $r \in R$, $d \in D$, $z \in Z$ and $p \in P$. In particular,

$$S_s = \{x \in \mathbb{R}^4, e \in \mathbb{R}^1 : \|x(t)\| \leq \rho_x(t, \|x_0\|) + \rho_r(\|r\|) + \rho_d(\|d\|) + \delta, \\ \forall x \in X(X_0, U, R, D, Z, P), \forall t \in [t_0, \infty), \|e(t)\| \leq \rho_e(t, \|e_0\|) + \rho_r(\|r\|) \\ + \rho_d(\|d\|) + \rho_y(\|y\|) + \delta, \forall e \in E(E_0, R, D, Y), \forall t \in [t_0, \infty)\},$$

where $\rho_x(\cdot)$ is the KL-function.

To study the robustness, tracking, and disturbance rejection, we consider a state-error set

$$XE(X_0, E_0, U, R, D, Z, P) = \{(x, e) \in X \times E : x_0 \in X_0, e_0 \in E_0, u \in U, \\ r \in R, d \in D, z \in Z, p \in P, t \in [t_0, \infty)\}$$

The robust tracking, stability, and disturbance rejection are guaranteed if $XE \subseteq S_s$. The *admissible* set S_s is found by using the Lyapunov stability theory [9], and

$$S_s = \left\{ x \in \mathbb{R}^4, e \in \mathbb{R}^1 : x_0 \in X_0, e_0 \in E_0, u \in U, r \in R, d \in D, z \in Z, p \in P | \right. \\ \left. \rho_1\|x\| + \rho_2\|e\| \leq V(t, x, e) \leq \rho_3\|x\| + \rho_4\|e\|, \frac{dV(t, x, e)}{dt} \leq -\rho_5\|x\| - \rho_6\|e\|, \right. \\ \left. \forall x \in X(X_0, U, R, P, Z, P), \forall e \in E(E_0, R, D, Y), \forall t \in [t_0, \infty) \right\}$$

where $\rho_1(\cdot)$, $\rho_2(\cdot)$, $\rho_3(\cdot)$ and $\rho_4(\cdot)$ are the K_∞ -functions; and $\rho_5(\cdot)$ and $\rho_6(\cdot)$ are the K-functions.

If in XE there exists a C^k Lyapunov function $V(t, x, e)$ such that for all $x_0 \in X_0$, $e_0 \in E_0$, $u \in U$, $r \in R$, $d \in D$, $z \in Z$, and $p \in P$ on $[t_0, \infty)$ sufficient condition for stability (s1)

$$\rho_1\|x\| + \rho_2\|e\| \leq V(t, x, e) \leq \rho_3\|x\| + \rho_4\|e\|$$

and inequality

$$\frac{dV(t, x, e)}{dt} \leq -\rho_5\|x\| - \rho_6\|e\|$$

which is the sufficient condition for stability s2, hold, then

1. solution $x(\cdot): [t_0, \infty) \rightarrow X$ for closed-loop system is robustly bounded and stable,
2. convergence of the error vector $e(\cdot): [t_0, \infty) \rightarrow E$ to S_ε is ensured in XE ,
3. XE is convex and compact, and $XE \subseteq S_s$.

That is, if criteria (s1) and (s2) are guaranteed, we have $XE \subseteq S_s$.

Using the nonquadratic Lyapunov candidate

$$V(t, x, e) = \sum_{j=0}^{\eta} \frac{2\gamma+1}{2(j+\gamma+1)} \left(x^{\frac{j+\gamma+1}{2\gamma+1}} \right)^T K_{xj}(t) x^{\frac{j+\gamma+1}{2\gamma+1}} + \sum_{j=0}^{\varsigma} \frac{2\beta+1}{2(j+\beta+1)} \left(e^{\frac{j+\beta+1}{2\beta+1}} \right)^T K_{ej}(t) e^{\frac{j+\beta+1}{2\beta+1}} \\ + \sum_{i=0}^{\sigma} \frac{2\mu+1}{2(j+\mu+1)} \left(e^{\frac{j+\mu+1}{2\mu+1}} \right)^T K_{ij}(t) e^{\frac{j+\mu+1}{2\mu+1}}$$

one obtains the bounded controller as

$$u = \begin{bmatrix} u_{as} \\ u_{bs} \end{bmatrix} = \begin{bmatrix} -\sin(RT\theta_{rm}) & 0 \\ 0 & \cos(RT\theta_{rm}) \end{bmatrix} \Phi \left(G_x(t) B^T \sum_{j=0}^{\eta} \text{diag} \left[x^{\frac{j-\gamma}{2\gamma+1}} \right] K_{xj}(t) x^{\frac{j+\gamma+1}{2\gamma+1}} \right. \\ \left. + G_e(t) B_e^T \sum_{j=0}^{\varsigma} K_{ej}(t) e^{\frac{2j+1}{2\beta+1}} + G_i(t) B_e^T \sum_{j=0}^{\sigma} K_{ij}(t) \frac{1}{s} e^{\frac{2j+1}{2\mu+1}} \right)$$

Here, $K_{xj}(\cdot)$ are the unknown matrix-functions, and $K_{ej}(\cdot)$ and $K_{ij}(\cdot)$ are the unknown coefficients; $\eta = 0, 1, 2, \dots$; $\gamma = 0, 1, 2, \dots$; $\varsigma = 0, 1, 2, \dots$; $\beta = 0, 1, 2, \dots$; $\sigma = 0, 1, 2, \dots$; and $\mu = 0, 1, 2, \dots$

Under the assumption that X_0, E_0, R, D, Z , and P are admissible, the robust tracking problem is solvable in XE . That is, the bounded real-analytic control $u(\cdot)$ guarantees the robust stability and steers the tracking error to S_e . Furthermore, stability is guaranteed, disturbance rejection is ensured, and specified input-output tracking performance can be achieved.

Applying the controller designed, one maximizes the electromagnetic torque developed by permanent-magnet stepper micromotors. This can be easily shown by using the expression for the electromagnetic torque, the balanced two-phase sinusoidal voltage set (applied phase voltages u_{as} and u_{bs}), as well as the trigonometric identity $\sin^2 a + \cos^2 a = 1$.

The tracking controller can be designed using the tracking error. In particular, we have

$$u = \begin{bmatrix} u_{as} \\ u_{bs} \end{bmatrix} = \begin{bmatrix} -\sin(RT\theta_{rm}) & 0 \\ 0 & \cos(RT\theta_{rm}) \end{bmatrix} \Phi \left(G_e(t) B_e^T \sum_{j=0}^{\varsigma} K_{ej}(t) e^{\frac{2j+1}{2\beta+1}} + G_i(t) B_e^T \sum_{i=0}^{\sigma} K_{ij}(t) \frac{1}{s} e^{\frac{2j+1}{2\mu+1}} \right)$$

The controller design, implementation, and experimental verification are reported in [9].

14.7 Conclusions

This chapter reports the current status, documents innovative results, and researches novel paradigms in synthesis, modeling, analysis, simulation, control, and optimization of high-performance MEMS. These results are obtained applying reported nonlinear modeling, analysis, synthesis, control, and optimization methods which allow one to attain performance assessment and predict outcomes. Novel MEMS were devised. The application of the plate, spherical, toroidal, conical, cylindrical, and asymmetrical motor geometry, as well as *endless*, *open-ended*, and *integrated* electromagnetic systems, allows one to classify MEMS. This idea is extremely useful in the studying of existing MEMS as well as in the synthesis of innovative high-performance MEMS. For example, asymmetrical (unconventional) geometry and *integrated* electromagnetic system can be applied. Optimization can be performed, and the classifier paradigm serves as a starting point from which advanced configurations can be synthesized and straightforwardly interpreted. Microscale motion devices geometry and electromagnetic systems, which play a central role, are related. Structural synthesis and optimization of MEMS are formalized and interpreted using innovative ideas. The MEMS classifier paradigm, in addition to being qualitative, leads one to quantitative analysis. In fact, using the cornerstone laws of electromagnetics and mechanics (e.g., Maxwell's,

Kirchhoff and Newton equations), the differential equations to model electromagnetic and mechanical phenomena and effects can be derived and applied to attain the performance analysis with outcome prediction. Mathematical models for MEMS are found. Making use of these mathematical models, analysis and optimization were performed, and nonlinear control algorithms were designed. The electromagnetics features and phenomena were integrated into the analysis, modeling, synthesis, and optimization. It is shown that to meet the specified level of performance, novel high-performance MEMS should be synthesized, high-fidelity modeling must be performed, advanced controllers have to be synthesized, and highly detailed dynamic nonlinear simulations must be carried out. The results reported have direct application to the analysis and design of high-performance MEMS. Different MEMS can be devised, synthesized, defined, and designed, and a number of long-standing issues related to geometrical variability and electromagnetics are studied. These benchmarking results allow one to reformulate and refine extremely important problems in MEMS theory, and solve a number of very complex issues in design and optimization with the ultimate goal to synthesize innovative high-performance, high torque, and power densities MEMS.

References

1. Lyshevski, S. E., *Nano- and Micro-Electromechanical Systems: Fundamentals of Nano- and Micro-Engineering*, CRC Press, Boca Raton, FL, 2000.
2. Madou, M., *Fundamentals of Microfabrication*, CRC Press, Boca Raton, FL, 1997.
3. Campbell, S. A., *The Science and Engineering of Microelectronic Fabrication*, Oxford University Press, New York, 2001.
4. Lyshevski, S. E., *Electromechanical Systems, Electric Machines, and Applied Mechatronics*, CRC Press, Boca Raton, FL, 1999.
5. Lyshevski, S. E. and Lyshevski, M. A., "Analysis, dynamics, and control of micro-electromechanical systems," *Proc. American Control Conference*, Chicago, IL, pp. 3091–3095, 2000.
6. Mehregany, M. and Tai, Y. C., "Surface micromachined mechanisms and micro-motors," *J. Micromechanics and Microengineering*, vol. 1, pp. 73–85, 1992.
7. Becker, E. W., Ehrfeld, W., Hagmann, P., Maner, A., and Mynchmeyer, D., "Fabrication of micro-structures with high aspect ratios and great structural heights by synchrotron radiation lithography, galvanoformung, and plastic molding (LIGA process)," *Microelectronic Engineering*, vol. 4, pp. 35–56, 1986.
8. Guckel, H., Christenson, T. R., Skrobis, K. J., Klein, J., and Karnowsky, M., "Design and testing of planar magnetic micromotors fabricated by deep X-ray lithography and electroplating," *Technical Digest of International Conference on Solid-State Sensors and Actuators, Transducers 93*, Yokohama, Japan, pp. 60–64, 1993.
9. Lyshevski, S. E., *Control Systems Theory with Engineering Applications*, Birkhäuser, Boston, MA, 2001.

15

The Physical Basis of Analogies in Physical System Models

- 15.1 Introduction
- 15.2 History
- 15.3 The Force-Current Analogy: Across and Through Variables
 - Drawbacks of the Across-Through Classification • Measurement as a Basis for Analogies • Beyond One-Dimensional Mechanical Systems • Physical Intuition
- 15.4 Maxwell's Force-Voltage Analogy: Effort and Flow Variables
 - Systems of Particles • Physical Intuition • Dependence on Reference Frames
- 15.5 A Thermodynamic Basis for Analogies
 - Extensive and Intensive Variables • Equilibrium and Steady State • Analogies, Not Identities • Nodicity
- 15.6 Graphical Representations
- 15.7 Concluding Remarks

Neville Hogan

*Massachusetts Institute
of Technology*

Peter C. Breedveld

University of Twente

15.1 Introduction

One of the fascinating aspects of mechatronic systems is that their function depends on interactions between electrical and mechanical behavior and often magnetic, fluid, thermal, chemical, or other effects as well. At the same time, this can present a challenge as these phenomena are normally associated with different disciplines of engineering and physics. One useful approach to this multidisciplinary or “multi-physics” problem is to establish analogies between behavior in different domains—for example, resonance due to interaction between inertia and elasticity in a mechanical system is analogous to resonance due to interaction between capacitance and inductance in an electrical circuit. Analogies can provide valuable insight about how a design works, identify equivalent ways a particular function might be achieved, and facilitate detailed quantitative analysis. They are especially useful in studying dynamic behavior, which often arises from interactions between domains; for example, even in the absence of elastic effects, a mass moving in a magnetic field may exhibit resonant oscillation. However, there are many ways that analogies may be established and, unfortunately, the most appropriate analogy between electrical circuits, mechanical and fluid systems remains unresolved: is force like current, or is force more like voltage? In this contribution we examine the physical basis of the analogies in common use and how they may be extended beyond mechanical and electrical systems.

15.2 History

It is curious that one of the earliest applications of analogies between electrical and mechanical systems was to enable the demonstration and study of transients in electrical networks that were otherwise too fast to be observed by the instrumentation of the day by identifying mechanical systems with equivalent dynamic behavior; that was the topic of a series of articles on “Models and analogies for demonstrating electrical principles” (*The Engineer*, 1926). Improved methods capable of observing fast electrical transients directly (especially the cathode ray oscilloscope, still in use today) rendered this approach obsolete but enabled quantitative study of nonelectrical systems via analogous electrical circuits (Nickle, 1925). Although that method had considerably more practical importance at the time than it has today (we now have the luxury of vastly more powerful tools for numerical computation of electromechanical system responses), in the late '20s and early '30s a series of papers (Darrieus, 1929; Hähnle, 1932; Firestone, 1933) formulated a rational method to use electrical networks as a framework for establishing analogies between physical systems.

15.3 The Force-Current Analogy: Across and Through Variables

Firestone identified two types of variable in each physical domain—“across” and “through” variables—which could be distinguished based on how they were measured. An “across” variable may be measured as a difference between values at two points in space (conceptually, *across* two points); a “through” variable may be measured by a sensor in the path of power transmission between two points in space (conceptually, it is transmitted *through* the sensor). By this classification, electrical voltage is analogous to mechanical velocity and electrical current is analogous to mechanical force. Of course, this classification of variables implies a classification of network elements: a mass is analogous to a capacitor, a spring is analogous to an inductor and so forth.

The “force-is-like-current” or “mass-capacitor” analogy has a sound mathematical foundation. Kirchhoff’s node law or current law, introduced in 1847 (the sum of currents into a circuit node is identically zero) can be seen as formally analogous to D’Alembert’s principle, introduced in 1742 (the sum of forces on a body is identically zero, provided the sum includes the so-called “inertia force,” the negative of the body mass times its acceleration). It is the analogy used in linear-graph representations of lumped-parameter systems, proposed by Trent in 1955. Linear graphs bring powerful results from mathematical graph theory to bear on the analysis of lumped-parameter systems. For example, there is a systematic procedure based on partitioning a graph into its *tree* and *links* for selecting sets of independent variables to describe a system. Graph-theoretic approaches are closely related to matrix methods that in turn facilitate computer-aided methods. Linear graphs provide a unified representation of lumped-parameter dynamic behavior in several domains that has been expounded in a number of successful textbooks (e.g., Shearer et al., 1967; Rowell & Wormley, 1997).

The mass-capacitor analogy also appears to afford some practical convenience. It is generally easier to identify points of common velocity in a mechanical system than to identify which elements experience the same force; and it is correspondingly easier to identify the nodes in an electrical circuit than all of its loops. Hence with this analogy it is straightforward to identify an electrical network equivalent to a mechanical system, at least in the one-dimensional case.

Drawbacks of the Across-Through Classification

Despite the obvious appeal of establishing analogies based on practical measurement procedures, the force-current analogy has some drawbacks that will be reviewed below: (i) on closer examination, measurement-based classification is ambiguous; (ii) its extension to more than one-dimensional mechanical systems is problematical; and (iii) perhaps most important, it leads to analogies (especially between mechanical and fluid systems) that defy common physical insight.

Measurement as a Basis for Analogies

Even a cursory review of state-of-the-art measurement technologies shows that the across-through classification may be an anachronism or, at best, an over-simplification. Velocity (an “across” variable) may be measured by an integrating accelerometer that is attached only to the point where velocity is measured—that’s how the human inner ear measures head velocity. While the velocity is measured with respect to an inertial reference frame (as it should be), there is no tangible connection to that frame. As a further example, current in a conductor (a “through” variable) may be measured without inserting an ammeter in the current path; sensors that measure current by responding to the magnetic field next to the conductor are commercially available (and preferred in some applications). Moreover, in some cases similar methods can be applied to measure both “across” and “through” variables. For example, fluid flow rate is classified as a through variable, presumably by reference to its measurement by, for example, a positive-displacement meter in the flow conduit; that’s the kind of fluid measurement commonly used in a household water meter. However, optical methods that are used to measure the velocity of a rigid body (classified as an across variable) are often adapted to measure the volumetric flow rate of a fluid (laser doppler velocimetry is a notable example). Apparently the same fundamental measurement technology can be associated with an across variable in one domain and a through variable in another. Thus, on closer inspection, the definition of across and through variables based on measurement procedures is, at best, ambiguous.

Beyond One-Dimensional Mechanical Systems

The apparent convenience of equating velocities in a mechanical system with voltages at circuit nodes diminishes rapidly as we go beyond translation in one dimension or rotation about a fixed axis. A translating body may have two or three independent velocities (in planar and spatial motion, respectively). Each independent velocity would appear to require a separate independent circuit node, but the kinetic energy associated with translation can be redistributed at will among these two or three degrees of freedom (e.g., during motion in a circle at constant speed the total kinetic energy remains constant while that associated with each degree of freedom varies). This requires some form of connection between the corresponding circuit nodes in an equivalent electrical network, but what that connection should be is not obvious.

The problem is further exacerbated when we consider rotation. Even the simple case of planar motion (i.e., a body that may rotate while translating) requires three independent velocities, hence three independent nodes in an equivalent electrical network. Reasoning as above we see that these three nodes must be connected but in a different manner from the connection between three nodes equivalent to spatial translation. Again, this connection is hardly obvious, yet translating while rotating is ubiquitous in mechanical systems—that’s what a wheel usually does.

Full spatial rotation is still more daunting. In this case interaction between the independent degrees of freedom is especially important as it gives rise to gyroscopic effects, including oscillatory precession and nutation. These phenomena are important practical considerations in modern mechatronics, not arcane subtleties of classical mechanics; for example, they are the fundamental physics underlying several designs for a microelectromechanical (MEMS) vibratory rate gyroscope (Yazdi et al., 1998).

Physical Intuition

In our view the most important drawback of the across-through classification is that it identifies force as analogous to fluid flow rate as well as electrical current (with velocity analogous to fluid pressure as well as voltage). This is highly counter-intuitive and quite confusing. By this analogy, fluid pressure is not analogous to force despite the fact that pressure is commonly defined as force per unit area. Furthermore, stored kinetic energy due to fluid motion is not analogous to stored kinetic energy due to motion of a rigid body. Given the remarkable similarity of the physical processes underlying these two forms of energy storage, it is hard to understand why they should not be analogous.

Insight is the ultimate goal of modeling. It is a crucial factor in producing innovative and effective designs and depends on developing and maintaining a “physical intuition” about the way devices behave. It is important that analogies between physical effects in different domains can be reconciled with the physical intuition and any method that requires a counter-intuitive analogy is questionable; at a minimum it warrants careful consideration.

15.4 Maxwell’s Force-Voltage Analogy: Effort and Flow Variables

An alternative analogy classifies variables in each physical domain that (loosely speaking) describe motion or cause it. Thus fluid flow rate, electrical current, and velocity are considered analogous (sometimes generically described as “flow” variables). Conversely, fluid pressure, electrical voltage, and force are considered analogous (sometimes generically described as “effort” variables).

The “force-is-like-voltage” analogy is the oldest drawn between mechanical and electrical systems. It was first proposed by Maxwell (1873) in his treatise on electricity and magnetism, where he observed the similarity between the Lagrangian equations of classical mechanics and electromechanics. That was why Firestone (1933) presented his perspective that force is like current as “A *new* analogy between mechanical and electrical systems” (emphasis added). Probably because of its age, the force-voltage analogy is deeply embedded in our language. In fact, voltage is still referred to as “electromotive force” in some contexts. Words like “resist” or “impede” also have this connotation: a large resistance or impedance implies a large force for a given motion or a large voltage for a given current.

In fact, Maxwell’s classification of velocity as analogous to electrical current (with force analogous to voltage) has a deeper justification than the similarity of one mathematical form of the equations of mechanics and electromechanics; it can be traced to a similarity of the underlying physical processes.

Systems of Particles

Our models of the physical world are commonly introduced by describing systems of particles distributed in space. The particles may have properties such as mass, charge, etc., though in a given context we will deliberately choose to neglect most of those properties so that we may concentrate on a single physical phenomenon of interest. Thus, to describe electrical capacitance, we consider only charge, while to describe translational inertia, we consider only mass and so forth.

Given that this common conceptual model is used in different domains, it may be used to draw analogies between the variables of different physical domains. From this perspective, quantities associated with the motion of particles may be considered analogous to one another; thus mechanical velocity, electrical current, and fluid flow rate are analogous. Accordingly, mechanical displacement, displaced fluid volume, and displaced charge are analogous; and thus force, fluid pressure, and voltage are analogous. This classification of variables obviously implies a classification of network elements: a spring relates mechanical displacement and force; a capacitor relates displaced charge and voltage. Thus a spring is analogous to a capacitor, a mass to an inductor, and for this reason, this analogy is sometimes termed the “mass-inductor” analogy.

Physical Intuition

The “system-of-particles” models naturally lead to the “intuitive” analogy between pressure, force, and voltage. But, is such a vague and ill-defined concept as “physical intuition” an appropriate consideration in drawing analogies between physical systems? After all, physical intuition might largely be a matter of usage and familiarity, rooted in early educational and cultural background.

We think not; instead we speculate that physical intuition may be related to conformity with a mental model of the physical world. That mental model is important for thinking about physical systems and, if shared, for communicating about them. Because the “system-of-particles” model is widely assumed

(sometimes explicitly, sometimes implicitly) in the textbooks and handbooks of basic science and engineering we speculate that it may account for the physical intuition shared by most engineers. If so, then conforming with that common “system-of-particles” mental model is important to facilitate designing, thinking, and communicating about mechatronic systems. The force-voltage analogy does so; the force-current analogy does not.

Dependence on Reference Frames

The “system-of-particles” model also leads to another important physical consideration in the choice of analogies between variables: the way they depend on reference frames. The mechanical displacement that determines the elastic potential energy stored in a spring and the displaced charge that determines the electrostatic potential energy stored in a capacitor may be defined with respect to *any* reference frame (whether time-varying or stationary). In contrast, the motion required for kinetic energy storage in a rigid body or a fluid must be defined with respect to an *inertial* frame. Though it may often be overlooked, the motion of charges required for magnetic field storage must also be defined with respect to an inertial frame (Feynman et al., 1963).

To be more precise, the constitutive equations of energy storage based on motion (e.g., in a mass or an inductor) require an inertial reference frame (or must be modified in a non-inertial reference frame). In contrast, the constitutive equations of energy storage based on displacement (e.g., in a spring or a capacitor) do not. Therefore, the mass-inductor (force-voltage) analogy is more consistent with fundamental physics than the mass-capacitor (force-current) analogy.

The modification of the constitutive equations for magnetic energy storage in a non-inertial reference frame is related to the transmission of electromagnetic radiation. However, Kirchhoff’s laws (more aptly termed “Kirchhoff’s approximations”), which are the foundations of electric network theory, are equivalent to assuming that electromagnetic radiation is absent or negligible. It might, therefore, be argued that the dependence of magnetic energy storage on an inertial reference frame is negligible for electrical circuits, and hence is irrelevant for any discussion of the physical basis of analogies between electrical circuits and other lumped-parameter dynamic-system models. That is undeniably true and could be used to justify the force-current analogy. Nevertheless, because of the confusion that can ensue, the value of an analogy that is fundamentally inconsistent with the underlying physics of lumped-parameter models is questionable.

15.5 A Thermodynamic Basis for Analogies

Often in the design and analysis of mechatronic systems it is necessary to consider a broader suite of phenomena than those of mechanics and electromechanics. For instance, it may be important to consider thermal conduction, convection, or even chemical reactions and more. To draw analogies between the variables of these domains it is helpful to examine the underlying physics. The analogous dynamic behavior observed in different physical domains (resonant oscillation, relaxation to equilibrium, etc.) is not merely a similarity of *mathematical* forms, it has a common *physical* basis which lies in the storage, transmission, and irreversible dissipation of energy. Consideration of energy leads us to thermodynamics; we show next that thermodynamics provides a broader basis for drawing analogies and yields some additional insight.

All of the displacements considered to be analogous above (i.e., mechanical displacement, displaced fluid volume, and displaced charge) may be associated with an energy storage function that requires equilibrium for its definition, the displacement being the argument of that energy function. Generically, these may be termed potential energy functions. To elaborate, elastic energy storage requires sustained but recoverable deformation of a material (e.g., as in a spring); the force required to sustain that deformation is determined at equilibrium, defined when the time rate of change of relative displacement of the material particles is uniformly zero (i.e., all the particles are at rest relative to each other). Electrostatic energy storage requires sustained separation of mobile charges of opposite sign (e.g., as in

a capacitor); the required voltage is determined at equilibrium, defined when the time rate of change of charge motion is zero (i.e., all the charges are at rest relative to each other).

Extensive and Intensive Variables

In the formalism of thermodynamics, the amount of stored energy and the displacement that determines it are *extensive* variables. That is, they vary with the spatial extent (i.e., size or volume) of the object storing the energy. The total elastic energy stored in a uniform rod of constant cross-sectional area in an idealized uniform state of stress is proportional to the length (and hence volume) of the rod; so is the total relative displacement of its ends; both are extensive variables. The total electrostatic energy stored in an idealized parallel-plate capacitor (i.e., one with no fringe fields) is proportional to the area of the plates (and hence, for constant gap, the volume they enclose); so is the total separated charge on the plates; both are extensive variables (cf., Breedveld, 1984).

Equilibrium of these storage elements is established by an *intensive* variable that does not change with the size of the object. This variable is the gradient (partial derivative) of the stored energy with respect to the corresponding displacement. Thus, at equilibrium, the force on each cross-section of the rod is the same regardless of the length or volume of the rod; force is an intensive variable. If the total charge separated in the capacitor is proportional to area, the voltage across the plates is independent of area; voltage is an intensive variable.

Dynamics is not solely due to the storage of energy but arises from the transmission and deployment of power. The instantaneous power into an equilibrium storage element is the product of the (intensive) gradient variable (force, voltage) with the time rate of change of the (extensive) displacement variable (velocity, current). Using this thermodynamics-based approach, all intensive variables are considered analogous, as are all extensive variables and their time rates of change, and so on.

Drawing analogies from a thermodynamic classification into extensive and intensive variables may readily be applied to fluid systems. Consider the potential energy stored in an open container of incompressible fluid: The pressure at any specified depth is independent of the area at that depth and the volume of fluid above it; pressure is an intensive variable analogous to force and voltage, as our common physical intuition suggests it should be. Conversely, the energy stored in the fluid above that depth is determined by the volume of fluid; energy and volume are extensive variables, volume playing the role of displacement analogous to electrical charge and mechanical displacement. Pressure is the partial derivative of stored energy with respect to volume and the instantaneous power into storage is the product of pressure with volumetric flow rate, the time rate of change of volume flowing past the specified depth.

An important advantage of drawing analogies from a classification into extensive and intensive variables is that it may readily be generalized to domains to which the “system-of-particles” image may be less applicable. For example, most mechatronic designs require careful consideration of heating and cooling but there is no obvious flow of particles associated with heat flux. Nevertheless, extensive and intensive variables associated with equilibrium thermal energy storage can readily be identified. Drawing on classical thermodynamics, it can be seen that (total) entropy is an extensive variable and plays the role of a displacement. The gradient of energy with respect to energy is temperature, an intensive variable, which should be considered analogous to force, voltage, and pressure. Equality of temperature establishes thermal equilibrium between two bodies that may store heat (energy) and communicate it to one another.

A word of caution is appropriate here as a classification into extensive and intensive variables properly applies only to scalar quantities such as pressure, volume, etc. As outlined below, the classification can be generalized in a rigorous way to nonscalar quantities, but care is required (cf., Breedveld, 1984).

Equilibrium and Steady State

In some (though not all) domains energy storage may also be based on motion. Kinetic energy storage may be associated with rigid body motion or fluid motion; magnetic energy storage requires motion of charges. The thermodynamics-based classification properly groups these different kinds of energy storage as analogous to one another and generically they may be termed *kinetic* energy storage elements.

All of the motion variables considered to be analogous (i.e., velocity, fluid flow rate, current) may be associated with an energy storage function that is defined by *steady state* (rather than by equilibrium). For a rigid body, steady motion requires zero net force, and hence constant momentum and kinetic energy. For the magnetic field that stores energy in an inductor, steady current requires zero voltage, and hence constant magnetic flux and magnetic energy.

It might reasonably be argued that any distinction between equilibrium and steady state is purely a matter of perspective and common usage, rather than a fundamental feature of the physical world. For example, with an alternative choice of reference frames, “sustained motion” could be redefined as “rest” or “equilibrium.” From this perspective, a zero-relative-velocity “equilibrium” between two rigid bodies (or between a rigid body and a reference frame) could be defined by zero force. Following this line of reasoning any distinction between the mass-inductor and mass-capacitor analogies would appear to be purely a matter of personal choice. However, while the apparent equivalence of “equilibrium” and “steady state” may be justifiable in the formal mathematical sense of zero rate of change of a variable, in a mechanical system, displacement (or position) and velocity (or momentum) are fundamentally different. For example, whereas velocity, force, and momentum may be transformed between reference frames as rank-one tensors, position (or displacement) may not be transformed as a tensor of any kind. Thus, a distinction between equilibrium and steady state reflects an important aspect of the structure of physical system models.

Analogies, Not Identities

It is important to remember that any classification to establish analogies is an abstraction. At most, dynamic behavior in different domains may be similar; it is not identical. We have pointed out above that if velocity or current is used as the argument of an energy storage function, care must be taken to identify an appropriate inertial reference frame and/or to understand the consequences of using a non-inertial frame. However, another important feature of these variables is that they are fundamentally vectors (i.e., they have a definable spatial orientation). One consequence is that the thermodynamic definition of extensive and intensive variables must be generalized before it may be used to classify these variables (cf., Breedveld, 1984). In contrast, a quantity such as temperature or pressure is fundamentally a scalar. Furthermore, both of these quantities are intrinsically “positive” scalars insofar as they have well-defined, unique and physically meaningful zero values (absolute zero temperature, the pressure of a perfect vacuum). Quite aside from any dependence on inertial reference frames, the across-through analogy between velocity (a vector with no unique zero value) and pressure (a scalar with a physically important zero) will cause error and confusion if used without due care.

This consideration becomes especially important when similar elements of a model are combined (for example, a number of bodies moving with identical velocity may be treated as a single rigid body) to simplify the expression of dynamic equations or improve their computability. The engineering variables used to describe energy storage can be categorized into two groups: (i) positive-valued scalar variables and (ii) nonscalar variables. Positive-valued scalar variables have a physically meaningful zero or absolute reference; examples include the volume of stored fluid, the number of moles of a chemical species, entropy, etc. Nonscalar¹ variables have a definable spatial orientation. Even in the one-dimensional case they can be positive or negative, the sign denoting direction with respect to some reference frame; examples include displacement, momentum, etc. These variables generally do not have a physically meaningful zero or absolute reference, though some of them must be defined with respect to an inertial frame.

Elements of a model that describe energy storage based on scalar variables can be combined in only one way: they must be in mutual equilibrium; their extensive variables are added, while the corresponding intensive variables are equal, independent of direction, and determine the equilibrium condition. For model elements that describe energy storage based on nonscalar variables there are usually two options.

¹The term “vector variables” suggests itself but these variables may include three-dimensional spatial orientation, which may not be described as a vector.

Electrical capacitors, for instance, may be combined in parallel or in series and the resulting equivalent capacitor may readily be determined. In a parallel connection, equilibrium is determined by voltage (an intensive variable) and the electric charges (extensive variables) are added as before. However, a series connection is the “dual” in the sense that the roles of charge and voltage are exchanged: equality of charges determines equilibrium and the voltages are added. Mechanical springs may also be combined in two ways. However, that is not the case for translational masses and rotational inertias; they may only be combined into a single equivalent rigid body if their velocities are equal and in that case their momenta are added.

The existence of two “dual” ways to combine some, but not all, of the energy storage elements based on nonscalar quantities is somewhat confusing. It may have contributed to the lengthy debate (if we date its beginning to Maxwell, lasting for over a century!) on the best analogy between mechanical and electrical systems. Nevertheless, the important point is that series and parallel connections may not be generalized in a straightforward way to all domains.

Nodicity

As insight is the foremost goal of modeling, analogies should be chosen to promote insight. Because there may be fundamental differences between all of the physical domains, care should be exercised in drawing analogies to ensure that special properties of one domain should not be applied inappropriately to other domains. This brings us to what may well be the strongest argument against the across-through classification. History suggests that it originated with the use of equivalent electrical network representations of nonelectrical systems. Unfortunately, electrical networks provide an inappropriate basis for developing a general representation of physical system dynamics. This is because electrical networks enjoy a special property, *nodicity*, which is quite unusual among the physical system domains (except as an approximation).

Nodicity refers to the fact that any sub-network (cut-set) of an electrical network behaves as a node in the sense that a Kirchhoff current balance equation may be written for the entire sub-network. As a result of nodicity, electrical network elements can be assembled in arbitrary topologies and yet still describe a physically realizable electrical network. This property of “arbitrary connectability” is not a general property of lumped-parameter physical system models. Most notably, mass elements cannot be connected arbitrarily; they must always be referenced to an inertial frame. For that reason, electrical networks can be quite misleading when used as a basis for a general representation of physical system dynamics. This is not merely a mathematical nicety; some consequences of non-nodic behavior for control system analysis have recently been explored (Won and Hogan, 1998).

By extension, because each of the physical domains has its unique characteristics, any attempt to formulate analogies by taking one of the domains (electrical, mechanical, or otherwise) as a starting point is likely to have limitations. A more productive approach is to begin with those characteristics of physical variables common to all domains and that is the reason to turn to thermodynamics. In other words, the best way to identify analogies *between* domains may be to “step outside” *all* of them. By design, general characteristics of all domains such as the extensive nature of stored energy, the intensive nature of the variables that define equilibrium, and so forth, are not subject to the limitations of any one (such as nodicity). That is the main advantage of drawing analogies based on thermodynamic concepts such as the distinction between extensive and intensive variables.

15.6 Graphical Representations

Analogies are often associated with abstract graphical representations of multi-domain physical system models. The force-current analogy is usually associated with the linear graph representation of networks introduced by Trent (1955); the force-voltage analogy is usually associated with the bond graph representation introduced by Paynter (1960). Bond graphs classify variables into efforts (commonly force, voltage, pressure, and so forth) and flows (commonly velocity, current, fluid flow rate, and so forth). Bond graphs extend all the practical benefits of the force-current (across-through) analogy to the force-voltage (effort-flow) analogy: they provide a unified representation of lumped-parameter dynamic behavior in several

domains that has been expounded in a number of successful textbooks (e.g., Karnopp et al., 1975, 1999), there are systematic methods for selecting sets of independent variables to describe a system, ways to take advantage of the ease of identifying velocities and voltages, and matrix methods to facilitate computer analysis. In fact, several computer-aided modeling support packages using the bond-graph language are now available. Furthermore, bond graphs have been applied successfully to describe the dynamics of spatial mechanisms (including gyroscopic effects) while, to the authors' knowledge, linear graphs have not.

Although the force-voltage analogy is most commonly used with bond graphs, the force-current analogy can be used just as readily; the underlying mathematical formalism is indifferent to the choice of which variables are chosen as analogous. In fact, pursuing this line of thought, the choice is unnecessary and may be avoided; doing so affords a way to clarify the potential confusion over the role of intensive variables and the dual types of connection available for some elements in some domains.

In the Generalized Bond Graph (GBG) approach (Breedveld, 1984) all energy storage becomes analogous and only one type of storage element, a (generalized) capacitor, is identified. Its displacement is an extensive variable; the gradient of its energy storage function with respect to that displacement is an intensive variable. In some (but not all) domains a particular kind of coupling known as a *gyrator* is found that gives rise to the *appearance* of a dual type of energy storage, a (generalized) inertia as well as the possibility of dual ways to connect elements. The GBG representation emphasizes the point that the presence of dual types of energy storage and dual types of connection is a special property (albeit an important one) of a limited number of domains. In principle, either a “mass-capacitor” analogy or a “mass-inductor” analogy can be derived from a GBG representation by choosing to associate the gyrating coupling with either the “equilibrium” or “steady-state” energy storage elements.

The important point to be taken here is that the basis of analogies between domains does not depend on the use of a particular abstract graphical representation. The practical value of establishing analogies between domains and the merits of a domain-independent approach based on intensive vs. extensive variables remains regardless of which graph-theoretic tools (if any) are used for analysis.

15.7 Concluding Remarks

In the foregoing we articulated some important considerations in the choice of analogies between variables in different physical domains. From a strictly mathematical viewpoint there is little to choose; both analogies may be used as a basis for rigorous, self-consistent descriptions of physical systems. The substantive and important factors emerge from a physical viewpoint—considering the structured way physical behavior is described in the different domains. Summarizing:

- The “system-of-particles” model that is widely assumed in basic science and engineering naturally leads to the intuitive analogy between force and voltage, velocity and current, a mass and an inductor, and so on.
- The measurement procedures used to motivate the distinction between across and through variables at best yield an ambiguous classification.
- Nodicity (the property of “arbitrary connectability”) is not a general property of lumped-parameter physical system models. Thus, electrical networks, which are nodic, can be quite misleading when used as a basis for a general representation of physical system dynamics.
- The intuitive analogy between velocity and current is consistent with a thermodynamic classification into extensive and intensive variables. As a result, the analogy can be generalized to dynamic behavior in domains to which the “system-of-particles” image may be less applicable.
- The force-voltage or mass-inductor analogy reflects an important distinction between equilibrium energy-storage phenomena and steady-state energy-storage phenomena: the constitutive equations of steady-state energy storage phenomena require an inertial reference frame (or must be modified in a non-inertial reference frame) while the constitutive equations of equilibrium energy storage phenomena do not.

Our reasoning is based on an assumption that models of physical system dynamics should properly reflect the way descriptions of physical phenomena depend on reference frames and should be compatible with thermodynamics. The across-through classification of variables does not meet these requirements. By contrast, the classification of variables based on the system-of-particles point of view that leads to an analogy between force, pressure, and voltage on the one hand and velocity, fluid flow, and current on the other not only satisfies these criteria, but is the least artificial from a common-sense point of view. We believe this facilitates communication and promotes insight, which are the ultimate benefits of using analogies.

Acknowledgments

Neville Hogan was supported in part by grant number AR40029 from the National Institutes of Health.

References

- (1926). Models and analogies for demonstrating electrical principles, parts I-XIX. *The Engineer*, 142.
- Breedveld, P.C. (1984). *Physical Systems Theory in Terms of Bond Graphs*, University of Twente, Enschede, Netherlands, ISBN 90-9000599-4 (distr. by author).
- Darrius, M. (1929). Les modeles mecaniques en electrotechnique. Leur application aux problemes de stabilite. *Bull. Soc. Franc. Electric.*, 36:729–809.
- Feynman, R.P., Leighton, R.B., and Sands, M. (1963). *The Feynman Lectures on Physics, Volume II: Mainly Electromagnetism and Matter*, Addison-Wesley Publishing Company.
- Firestone, F.A. (1933). A new analogy between mechanical and electrical system elements. *Journal of the Acoustic Society of America*, 3:249–267.
- Hähle, W. (1932). Die darstellung elektromechanischer gebilde durch rein elektrisiche schaltbilder. *Wissenschaftliche Veroffentl. Siemens Konzern*, 11:1–23.
- Karnopp, D.C. and Rosenberg, R.C. (1975). *System Dynamics: A Unified Approach*, John Wiley.
- Karnopp, D.C., Margolis, D.L., and Rosenberg, R.C. (1999). *System Dynamics: Modeling and Simulation of Mechatronic Systems*, 3rd edition, John Wiley.
- Maxwell, J.C. (1873). *Treatise on Electricity and Magnetism*.
- Nickle, C.A. (1925). Oscillographic solutions of electro-mechanical systems. *Trans. A.I.E.E.*, 44:844–856.
- Rowell, D. and Wormley, D.N. (1997). *System Dynamics: An Introduction*, Prentice-Hall, NJ.
- Shearer, J.L., Murphy, A.T., and Richardson, H.H. (1967). *Introduction to System Dynamics*, Addison-Wesley Publishing Company.
- Trent, H.M. (1955). Isomorphisms between oriented linear graphs and lumped physical systems. *Journal of the Acoustic Society of America*, 27:500–527.
- Won, J. and Hogan, N. (1998). Coupled stability of non-nodic physical systems. *IFAC Symposium on Nonlinear Control Systems Design*.
- Yazdi, N., Ayazi, F., and Najafi, K. (1998). Micromachined inertial sensors. *Proc. IEEE*, 86(8), 1640–1659.

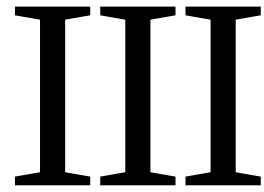

Sensors and Actuators

- 16 Introduction to Sensors and Actuators** *M. Anjanappa, K. Datta, and T. Song*
Sensors • Actuators
- 17 Fundamentals of Time and Frequency** *Michael A. Lombardi*
Introduction • Time and Frequency Measurement • Time and Frequency Standards • Time and Frequency Transfer • Closing
- 18 Sensor and Actuator Characteristics** *Joey Parker*
Range • Resolution • Sensitivity • Error • Repeatability • Linearity and Accuracy • Impedance • Nonlinearities • Static and Coulomb Friction • Eccentricity • Backlash • Saturation • Deadband • System Response • First-Order System Response • Underdamped Second-Order System Response • Frequency Response
- 19 Sensors** *Kevin M. Lynch, Michael A. Peshkin, Halit Eren, M. A. Elbestawi, Ivan J. Garshelis, Richard Thorn, Pamela M. Norris, Bouvard Hosticka, Jorge Fernando Figueroa, H. R. (Bart) Everett, Stanley S. Ipson, and Chang Liu*
Linear and Rotational Sensors • Acceleration Sensors • Force Measurement • Torque and Power Measurement • Flow Measurement • Temperature Measurements • Distance Measuring and Proximity Sensors • Light Detection, Image, and Vision Systems • Integrated Microsensors
- 20 Actuators** *George T.-C. Chiu, C. J. Fraser, Ramutis Bansevicius, Rymantas Tadas Tolocka, Massimo Sorli, Stefano Pastorelli, and Sergey Edward Lyshevski*
Electromechanical Actuators • Electrical Machines • Piezoelectric Actuators • Hydraulic and Pneumatic Actuation Systems • MEMS: Microtransducers Analysis, Design, and Fabrication

16

Introduction to Sensors and Actuators

M. Anjanappa

University of Maryland Baltimore
County

K. Datta

University of Maryland Baltimore
County

T. Song

University of Maryland Baltimore
County

16.1 Sensors

[Classification](#) • [Principle of Operation](#) • [Selection Criteria](#)
• [Signal Conditioning](#) • [Calibration](#)

16.2 Actuators

[Classification](#) • [Principle of Operation](#) • [Selection Criteria](#)

Sensors and actuators are two critical components of every closed loop control system. Such a system is also called a *mechatronics system*. A typical mechatronics system as shown in [Fig. 16.1](#) consists of a sensing unit, a controller, and an actuating unit. A sensing unit can be as simple as a single sensor or can consist of additional components such as filters, amplifiers, modulators, and other signal conditioners. The controller accepts the information from the sensing unit, makes decisions based on the control algorithm, and outputs commands to the actuating unit. The actuating unit consists of an actuator and optionally a power supply and a coupling mechanism.

16.1 Sensors

Sensor is a device that when exposed to a physical phenomenon (temperature, displacement, force, etc.) produces a proportional output signal (electrical, mechanical, magnetic, etc.). The term transducer is often used synonymously with sensors. However, ideally, a sensor is a device that responds to a change in the physical phenomenon. On the other hand, a transducer is a device that converts one form of energy into another form of energy. Sensors are transducers when they sense one form of energy input and output in a different form of energy. For example, a thermocouple responds to a temperature change (thermal energy) and outputs a proportional change in electromotive force (electrical energy). Therefore, a thermocouple can be called a sensor and or transducer.

Classification

Table 16.1 lists various types of sensors that are classified by their measurement objectives. Although this list is by no means exhaustive, it covers all the basic types including the new generation sensors such as smart material sensors, microsensors, and nanosensors.

TABLE 16.1 Type of Sensors for Various Measurement Objectives

| Sensor | Features |
|--|---|
| | Linear/Rotational sensors |
| Linear/Rotational variable differential transducer (LVDT/RVDT) | High resolution with wide range capability Very stable in static and quasi-static applications |
| Optical encoder | Simple, reliable, and low-cost solution Good for both absolute and incremental measurements |
| Electrical tachometer | Resolution depends on type such as generator or magnetic pickups |
| Hall effect sensor | High accuracy over a small to medium range |
| Capacitive transducer | Very high resolution with high sensitivity Low power requirements Good for high frequency dynamic measurements |
| Strain gauge elements | Very high accuracy in small ranges Provides high resolution at low noise levels |
| Interferometer | Laser systems provide extremely high resolution in large ranges Very reliable and expensive |
| Magnetic pickup | Output is sinusoidal |
| Gyroscope | |
| Inductosyn | Very high resolution over small ranges |
| | Acceleration sensors |
| Seismic accelerometer | Good for measuring frequencies up to 40% of its natural frequency |
| Piezoelectric accelerometer | High sensitivity, compact, and rugged Very high natural frequency (100 kHz typical) |
| | Force, torque, and pressure sensor |
| Strain gauge | Good for both static and dynamic measurements |
| Dynamometers/load cells | They are also available as micro- and nanosensors |
| Piezoelectric load cells | Good for high precision dynamic force measurements |
| Tactile sensor | Compact, has wide dynamic range, and high |
| Ultrasonic stress sensor | Good for small force measurements |
| | Flow sensors |
| Pitot tube | Widely used as a flow rate sensor to determine speed in aircrafts |
| Orifice plate | Least expensive with limited range |
| Flow nozzle, venturi tubes | Accurate on wide range of flow More complex and expensive |
| Rotameter | Good for upstream flow measurements Used in conjunction with variable inductance sensor |
| Ultrasonic type | Good for very high flow rates Can be used for both upstream and downstream flow measurements |
| Turbine flow meter | Not suited for fluids containing abrasive particles Relationship between flow rate and angular velocity is linear |
| Electromagnetic flow meter | Least intrusive as it is noncontact type Can be used with fluids that are corrosive, contaminated, etc. The fluid has to be electrically conductive |
| | Temperature sensors |
| Thermocouples | This is the cheapest and the most versatile sensor Applicable over wide temperature ranges (-200°C to 1200°C typical) |
| Thermistors | Very high sensitivity in medium ranges (up to 100°C typical) Compact but nonlinear in nature |
| Thermodiodes, thermo transistors | Ideally suited for chip temperature measurements Minimized self heating |
| RTD—resistance temperature detector | More stable over a long period of time compared to thermocouple Linear over a wide range |

(continued)

TABLE 16.1 Type of Sensors for Various Measurement Objectives (Continued)

| Sensor | Features |
|---|--|
| Infrared type Infrared thermography | Noncontact point sensor with resolution limited by wavelength Measures whole-field temperature distribution |
| | Proximity sensors |
| Inductance, eddy current, hall effect, photoelectric, capacitance, etc. | Robust noncontact switching action The digital outputs are often directly fed to the digital controller |
| | Light sensors |
| Photoresistors, photodiodes, photo transistors, photo conductors, etc. Charge-coupled diode | Measure light intensity with high sensitivity Inexpensive, reliable, and noncontact sensor Captures digital image of a field of vision |
| | Smart material sensors |
| Optical fiber | |
| As strain sensor | Alternate to strain gages with very high accuracy and bandwidth Sensitive to the reflecting surface's orientation and status |
| As level sensor | Reliable and accurate |
| As force sensor | High resolution in wide ranges |
| As temperature sensor | High resolution and range (up to 2000°C) |
| Piezoelectric | |
| As strain sensor | Distributed sensing with high resolution and bandwidth |
| As force sensor | Most suitable for dynamic applications |
| As accelerometer | Least hysteresis and good setpoint accuracy |
| Magnetostrictive | |
| As force sensors | Compact force sensor with high resolution and bandwidth Good for distributed and noncontact sensing applications |
| As torque sensor | Accurate, high bandwidth, and noncontact sensor |
| | Micro- and nano-sensors |
| Micro CCD image sensor | Small size, full field image sensor |
| Fiberscope | Small (0.2 mm diameter) field vision scope using SMA coil actuators |
| Micro-ultrasonic sensor | Detects flaws in small pipes |
| Micro-tactile sensor | Detects proximity between the end of catheter and blood vessels |

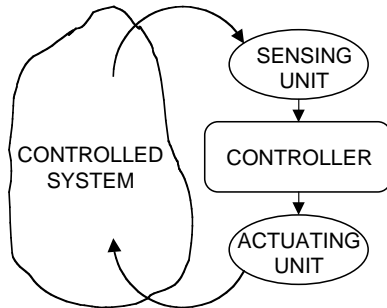

FIGURE 16.1 A typical mechatronics system.

Sensors can also be classified as *passive* or *active*. In passive sensors, the power required to produce the output is provided by the sensed physical phenomenon itself (such as a thermometer) whereas the active sensors require external power source (such as a strain gage).

Furthermore, sensors are classified as *analog* or *digital* based on the type of output signal. Analog sensors produce continuous signals that are proportional to the sensed parameter and typically require

analog-to-digital conversion before feeding to the digital controller. Digital sensors on the other hand produce digital outputs that can be directly interfaced with the digital controller. Often, the digital outputs are produced by adding an analog-to-digital converter to the sensing unit. If many sensors are required, it is more economical to choose simple analog sensors and interface them to the digital controller equipped with a multi-channel analog-to-digital converter.

Principle of Operation

Linear and Rotational Sensors

Linear and rotational position sensors are two of the most fundamental of all measurements used in a typical mechatronics system. The most common type position sensors are listed in Table 16.1. In general, the position sensors produce an electrical output that is proportional to the displacement they experience. There are contact type sensors such as strain gage, LVDT, RVDT, tachometer, etc. The noncontact type includes encoders, hall effect, capacitance, inductance, and interferometer type. They can also be classified based on the range of measurement. Usually the high-resolution type of sensors such as *hall effect*, *fiber optic inductance*, *capacitance*, and *strain gage* are suitable for only very small range (typically from 0.1 mm to 5 mm). The *differential transformers* on the other hand, have a much larger range with good resolution. *Interferometer* type sensors provide both very high resolution (in terms of microns) and large range of measurements (typically up to a meter). However, interferometer type sensors are bulky, expensive, and requires large set up time.

Among many linear displacement sensors, strain gage provides high resolution at low noise level and is least expensive. A typical resistance strain gage consists of resistive foil arranged as shown in the Fig. 16.2. A typical setup to measure the normal strain of a member loaded in tension is shown in Fig. 16.3. Strain gage 1 is bonded to the loading member whereas strain gage 2 is bonded to a second member made of same material, but not loaded. This arrangement compensates for any temperature effect. When the member is loaded, the gage 1 elongates thereby changing the resistance of the gage. The change in resistance is transformed into a change in voltage by the voltage-sensitive wheatstone bridge circuit. Assuming that the resistance of all four arms are equal initially, the change in output voltage (Δv_o) due to change in resistance (ΔR_1) of gage 1 is

$$\frac{\Delta v_o}{v_i} = \frac{\Delta R_1/R}{4 + 2(\Delta R_1/R)}$$

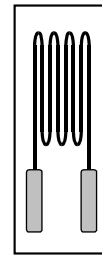

FIGURE 16.2 Bonded strain gage.

Acceleration Sensors

Measurement of acceleration is important for systems subject to shock and vibration. Although acceleration can be derived from the time history data obtainable from linear or rotary sensors, the accelerometers whose output is directly proportional to the acceleration is preferred. Two common types include

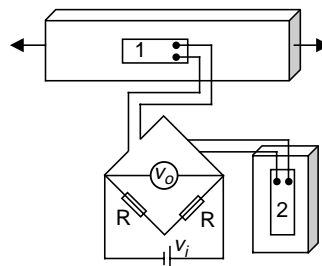

FIGURE 16.3 Experimental setup to measure normal strain using strain gages.

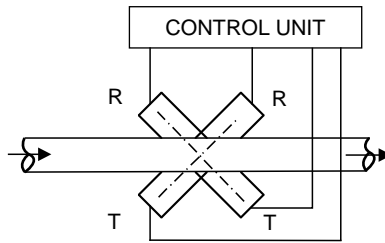

FIGURE 16.4 Ultrasonic flow sensor arrangement.

the *seismic mass* type and the *piezoelectric* accelerometer. The seismic mass type accelerometer is based on the relative motion between a mass and the supporting structure. The natural frequency of the seismic mass limits its use to low to medium frequency applications. The piezoelectric accelerometer, however, is compact and more suitable for high frequency applications.

Force, Torque, and Pressure Sensors

Among many type of force/torque sensors, the *strain gage dynamometers* and *piezoelectric type* are most common. Both are available to measure force and/or torque either in one axis or multiple axes. The dynamometers make use of mechanical members that experiences elastic deflection when loaded. These types of sensors are limited by their natural frequency. On the other hand, the piezoelectric sensors are particularly suitable for dynamic loadings in a wide range of frequencies. They provide high stiffness, high resolution over a wide measurement range, and are compact.

Flow Sensors

Flow sensing is relatively a difficult task. The fluid medium can be liquid, gas, or a mixture of the two. Furthermore, the flow could be laminar or turbulent and can be a time-varying phenomenon. The *venturi meter* and *orifice plate* restrict the flow and use the pressure difference to determine the flow rate. The *pitot tube* pressure probe is another popular method of measuring flow rate. When positioned against the flow, they measure the total and static pressures. The flow velocity and in turn the flow rate can then be determined. The *rotameter* and the *turbine meters* when placed in the flow path, rotate at a speed proportional to the flow rate. The *electromagnetic flow meters* use noncontact method. Magnetic field is applied in the transverse direction of the flow and the fluid acts as the conductor to induce voltage proportional to the flow rate.

Ultrasonic flow meters measure fluid velocity by passing high-frequency sound waves through fluid. A schematic diagram of the ultrasonic flow meter is as shown in Fig. 16.4. The transmitters (T) provide the sound signal source. As the wave travels towards the receivers (R), its velocity is influenced by the velocity of the fluid flow due to the doppler effect. The control circuit compares the time to interpret the flow rate. This can be used for very high flow rates and can also be used for both upstream and downstream flow. The other advantage is that it can be used for corrosive fluids, fluids with abrasive particles, as it is like a noncontact sensor.

Temperature Sensors

A variety of devices are available to measure temperature, the most common of which are thermocouples, thermistors, resistance temperature detectors (RTD), and infrared types.

Thermocouples are the most versatile, inexpensive, and have a wide range (up to 1200°C typical). A thermocouple simply consists of two dissimilar metal wires joined at the ends to create the sensing junction. When used in conjunction with a reference junction, the temperature difference between the reference junction and the actual temperature shows up as a voltage potential. *Thermistors* are semiconductor devices whose resistance changes as the temperature changes. They are good for very high sensitivity measurements in a limited range of up to 100°C. The relationship between the temperature and the resistance is nonlinear. The *RTDs* use the phenomenon that the resistance of a metal changes with temperature. They are, however, linear over a wide range and most stable.

Infrared type sensors use the radiation heat to sense the temperature from a distance. These noncontact sensors can also be used to sense a field of vision to generate a thermal map of a surface.

Proximity Sensors

They are used to sense the proximity of an object relative to another object. They usually provide a on or off signal indicating the presence or absence of an object. *Inductance, capacitance, photoelectric,* and *hall effect* types are widely used as proximity sensors. Inductance proximity sensors consist of a coil wound around a soft iron core. The inductance of the sensor changes when a ferrous object is in its proximity. This change is converted to a voltage-triggered switch. Capacitance types are similar to inductance except the proximity of an object changes the gap and affects the capacitance. Photoelectric sensors are normally aligned with an infrared light source. The proximity of a moving object interrupts the light beam causing the voltage level to change. Hall effect voltage is produced when a current-carrying conductor is exposed to a transverse magnetic field. The voltage is proportional to transverse distance between the hall effect sensor and an object in its proximity.

Light Sensors

Light intensity and full field vision are two important measurements used in many control applications. *Phototransistors, photoresistors,* and *photodiodes* are some of the more common type of light intensity sensors. A common photoresistor is made of cadmium sulphide whose resistance is maximum when the sensor is in dark. When the photoresistor is exposed to light, its resistance drops in proportion to the intensity of light. When interfaced with a circuit as shown in Fig. 16.5 and balanced, the change in light intensity will show up as change in voltage. These sensors are simple, reliable, and cheap, used widely for measuring light intensity.

Smart Material Sensors

There are many new smart materials that are gaining more applications as sensors, especially in distributed sensing circumstances. Of these, *optic fibers, piezoelectric,* and *magnetostrictive* materials have found applications. Within these, optic fibers are most used.

Optic fibers can be used to sense strain, liquid level, force, and temperature with very high resolution. Since they are economical for use as *in situ* distributed sensors on large areas, they have found numerous applications in smart structure applications such as damage sensors, vibration sensors, and cure-monitoring sensors. These sensors use the inherent material (glass and silica) property of optical fiber to sense the environment. Figure 16.6 illustrates the basic principle of operation of an embedded optic fiber used to sense displacement, force, or temperature. The relative change in the transmitted intensity or spectrum is proportional to the change in the sensed parameter.

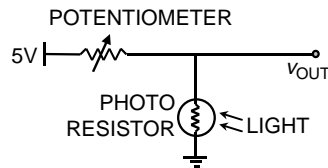

FIGURE 16.5 Light sensing with photoresistors.

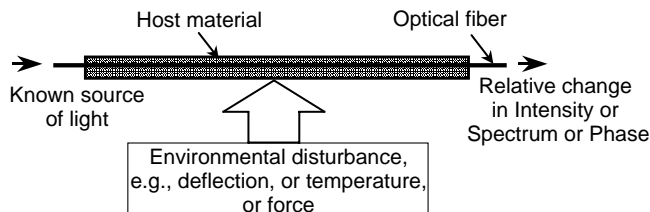

FIGURE 16.6 Principle of operation of optic fiber sensing.

Micro- and Nanosensors

Microsensors (sometimes also called MEMS) are the miniaturized version of the conventional macrosensors with improved performance and reduced cost. Silicon micromachining technology has helped the development of many microsensors and continues to be one of the most active research and development topics in this area.

Vision microsensors have found applications in medical technology. A *fiberscope* of approximately 0.2 mm in diameter has been developed to inspect flaws inside tubes. Another example is a *microtactile sensor*, which uses laser light to detect the contact between a catheter and the inner wall of blood vessels during insertion that has sensitivity in the range of 1 mN. Similarly, the progress made in the area of nanotechnology has fuelled the development of nanosensors. These are relatively new sensors that take one step further in the direction of miniaturization and are expected to open new avenues for sensing applications.

Selection Criteria

A number of static and dynamic factors must be considered in selecting a suitable sensor to measure the desired physical parameter. Following is a list of typical factors:

Range—Difference between the maximum and minimum value of the sensed parameter

Resolution—The smallest change the sensor can differentiate

Accuracy—Difference between the measured value and the true value

Precision—Ability to reproduce repeatedly with a given accuracy

Sensitivity—Ratio of change in output to a unit change of the input

Zero offset—A nonzero value output for no input

Linearity—Percentage of deviation from the best-fit linear calibration curve

Zero Drift—The departure of output from zero value over a period of time for no input

Response time—The time lag between the input and output

Bandwidth—Frequency at which the output magnitude drops by 3 dB

Resonance—The frequency at which the output magnitude peak occurs

Operating temperature—The range in which the sensor performs as specified

Deadband—The range of input for which there is no output

Signal-to-noise ratio—Ratio between the magnitudes of the signal and the noise at the output

Choosing a sensor that satisfies all the above to the desired specification is difficult, at best. For example, finding a position sensor with micrometer resolution over a range of a meter eliminates most of the sensors. Many times the lack of a cost-effective sensor necessitates redesigning the mechatronic system. It is, therefore, advisable to take a system level approach when selecting a sensor and avoid choosing it in isolation.

Once the above-referred functional factors are satisfied, a short list of sensors can be generated. The final selection will then depend upon the size, extent of signal conditioning, reliability, robustness, maintainability, and cost.

Signal Conditioning

Normally, the output from a sensor requires post processing of the signals before they can be fed to the controller. The sensor output may have to be demodulated, amplified, filtered, linearized, range quantized, and isolated so that the signal can be accepted by a typical analog-to-digital converter of the controller. Some sensors are available with integrated signal conditioners, such as the microsensors. All the electronics are integrated into one microcircuit and can be directly interfaced with the controllers.

Calibration

The sensor manufacturer usually provides the calibration curves. If the sensors are stable with no drift, there is no need to recalibrate. However, often the sensor may have to be recalibrated after integrating it with a signal conditioning system. This essentially requires that a known input signal is provided to

the sensor and its output recorded to establish a correct output scale. This process proves the ability to measure reliably and enhances the confidence.

If the sensor is used to measure a time-varying input, dynamic calibration becomes necessary. Use of sinusoidal inputs is the most simple and reliable way of dynamic calibration. However, if generating sinusoidal input becomes impractical (for example, temperature signals) then a step input can substitute for the sinusoidal signal. The transient behavior of step response should yield sufficient information about the dynamic response of the sensor.

16.2 Actuators

Actuators are basically the muscle behind a mechatronics system that accepts a control command (mostly in the form of an electrical signal) and produces a change in the physical system by generating force, motion, heat, flow, etc. Normally, the actuators are used in conjunction with the power supply and a coupling mechanism as shown in Fig. 16.7. The power unit provides either AC or DC power at the rated voltage and current. The coupling mechanism acts as the interface between the actuator and the physical system. Typical mechanisms include rack and pinion, gear drive, belt drive, lead screw and nut, piston, and linkages.

Classification

Actuators can be classified based on the type of energy as listed in Table 16.2. The table, although not exhaustive, lists all the basic types. They are essentially of electrical, electromechanical, electromagnetic, hydraulic, or pneumatic type. The new generations of actuators include smart material actuators, micro-actuators, and Nanoactuators.

Actuators can also be classified as *binary* and *continuous* based on the number of stable-state outputs. A relay with two stable states is a good example of a binary actuator. Similarly, a stepper motor is a good example of continuous actuator. When used for a position control, the stepper motor can provide stable outputs with very small incremental motion.

Principle of Operation

Electrical Actuators

Electrical switches are the choice of actuators for most of the on-off type control action. Switching devices such as *diodes*, *transistors*, *triacs*, *MOSFET*, and *relays* accept a low energy level command signal from the controller and switch on or off electrical devices such as motors, valves, and heating elements. For example, a MOSFET switch is shown in Fig. 16.8. The gate terminal receives the low energy control signal from the controller that makes or breaks the connection between the power supply and the actuator load. When switches are used, the designer must make sure that *switch bounce* problem is eliminated either by hardware or software.

Electromechanical Actuators

The most common electromechanical actuator is a motor that converts electrical energy to mechanical motion. Motors are the principal means of converting electrical energy into mechanical energy in industry. Broadly they can be classified as *DC motors*, *AC motors*, and *stepper motors*. DC motors operate on DC

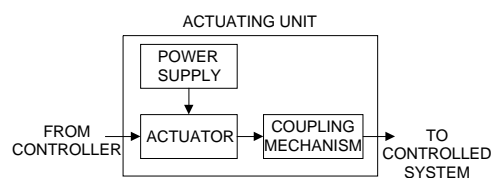

FIGURE 16.7 A typical actuating unit.

TABLE 16.2 Type of Actuators and Their Features

| Actuator | | Features | |
|---|---------------------|--|---|
| Electrical | | | |
| Diodes, thyristor, bipolar transistor, triacs, diacs, power MOSFET, solid state relay, etc. | | Electronic type Very high frequency response Low power consumption | |
| Electromechanical | | | |
| DC motor | Wound field | Separately excited | Speed can be controlled either by the voltage across the armature winding or by varying the field current |
| | | Shunt | Constant-speed application |
| | | Series | High starting torque, high acceleration torque, high speed with light load |
| | Permanent magnet | Compound | Low starting torque, good speed regulation Instability at heavy loads |
| | | Conventional PM motor | High efficiency, high peak power, and fast response |
| | | Moving-coil PM motor | Higher efficiency and lower inductance than conventional DC motor |
| AC motor | AC induction motor | Torque motor | Designed to run for a long periods in a stalled or a low rpm condition |
| | | Electronic commutation (brushless motor) | Fast response High efficiency, often exceeding 75% Long life, high reliability, no maintenance needed Low radio frequency interference and noise production |
| | | Universal motor | The most commonly used motor in industry Simple, rugged, and inexpensive Rotor rotates at synchronous speed Very high efficiency over a wide range of speeds and loads Need an additional system to start Can operate in DC or AC Very high horsepower per pound ratio Relatively short operating life |
| Stepper motor | Hybrid | Change electrical pulses into mechanical movement Provide accurate positioning without feedback | |
| | Variable reluctance | Low maintenance | |
| Electromagnetic | | | |
| Solenoid type devices Electromagnets, relay | | Large force, short duration On/off control | |
| Hydraulic and Pneumatic | | | |
| Cylinder | Hydraulic motor | Gear type | Suitable for liner movement |
| | | Vane type | Wide speed range |
| | | Piston type | High horsepower output |
| Air motor | Reciprocating | Rotary type | High degree of reliability |
| | | Valves | No electric shock hazard Low maintenance |
| Smart Material actuators | | | |
| Piezoelectric & Electrostrictive | | Directional control valves Pressure control valves Process control valves | High frequency with small motion High voltage with low current excitation High resolution |

(continued)

TABLE 16.2 Type of Actuators and Their Features (Continued)

| Actuator | Features |
|---------------------------|---|
| Magnetostrictive | High frequency with small motion Low voltage with high current excitation |
| Shape Memory Alloy | Low voltage with high current excitation Low frequency with large motion |
| Electrorheological fluids | Very high voltage excitation Good resistance to mechanical shock and vibration Low frequency with large force |
| Micro- and Nanoactuators | |
| Micromotors | Suitable for micromechanical system |
| Microvalves | Can use available silicon processing technology, such as electrostatic motor |
| Micropumps | Can use any smart material |

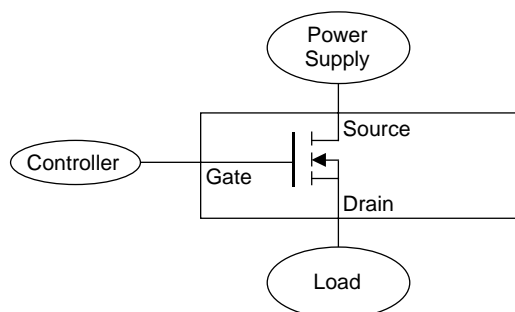

FIGURE 16.8 n-channel power MOSFET.

voltage and varying the voltage can easily control their speed. They are widely used in applications ranging from thousands of horsepower motors used in rolling mills to fractional horsepower motors used in automobiles (starter motors, fan motors, windshield wiper motors, etc.). Although they are costlier, they need DC power supply and require more maintenance compared to AC motors.

The governing equation of motion of a DC motor can be written as:

$$T = J \frac{d\omega}{dt} + T_L + T_{\text{loss}}$$

where T is torque, J is the total inertia, ω is the angular mechanical speed of the rotor, T_L is the torque applied to the motor shaft, and T_{loss} is the internal mechanical losses such as friction.

AC motors are the most popular since they use standard AC power, do not require brushes and commutator, and are therefore less expensive. AC motors can be further classified as the *induction motors*, *synchronous motors*, and *universal motors* according to their physical construction. The induction motor is simple, rugged, and maintenance free. They are available in many sizes and shapes based on number of phases used. For example, a three-phase induction motor is used in large-horsepower applications, such as pump drives, steel mill drives, hoist drives, and vehicle drives. The two-phase servomotor is used extensively in position control systems. Single-phase induction motors are widely used in many household appliances. The synchronous motor is one of the most efficient electrical motors in industry, so it is used in industry to reduce the cost of electrical power. In addition, synchronous motors rotate at synchronous speed, so they are also used in applications that require synchronous operations. The universal motors operate with either

AC or DC power supply. They are normally used in fractional horsepower application. The DC universal motor has the highest horsepower-per-pound ratio, but has a relatively short operating life.

The *stepper motor* is a discrete (incremental) positioning device that moves one step at a time for each pulse command input. Since they accept direct digital commands and produce a mechanical motion, the stepper motors are used widely in industrial control applications. They are mostly used in fractional horsepower applications. With the rapid progress in low cost and high frequency solid-state drives, they are finding increased applications.

Figure 16.9 shows a simplified unipolar stepper motor. The winding-1 is between the top and bottom stator pole, and the winding-2 is between the left and right motor poles. The rotor is a permanent magnet with six poles resulting in a single step angle of 30° . With appropriate excitation of winding-1, the top stator pole becomes a north pole and the bottom stator pole becomes a south pole. This attracts the rotor into the position as shown. Now if the winding-1 is de-energized and winding-2 is energized, the rotor will turn 30° . With appropriate choice of current flow through winding-2, the rotor can be rotated either clockwise or counterclockwise. By exciting the two windings in sequence, the motor can be made to rotate at a desired speed continuously.

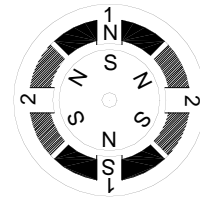

FIGURE 16.9 Unipolar stepper motor.

Electromagnetic Actuators

The *solenoid* is the most common electromagnetic actuator. A DC solenoid actuator consists of a soft iron core enclosed within a current carrying coil. When the coil is energized, a magnetic field is established that provides the force to push or pull the iron core. AC solenoid devices are also encountered, such as AC excitation relay.

A solenoid operated directional control valve is shown in Fig. 16.10. Normally, due to the spring force, the soft iron core is pushed to the extreme left position as shown. When the solenoid is excited, the soft iron core will move to the right extreme position thus providing the electromagnetic actuation.

Another important type is the *electromagnet*. The electromagnets are used extensively in applications that require large forces.

Hydraulic and Pneumatic Actuators

Hydraulic and pneumatic actuators are normally either *rotary motors* or *linear piston/cylinder* or *control valves*. They are ideally suited for generating very large forces coupled with large motion. Pneumatic actuators use air under pressure that is most suitable for low to medium force, short stroke, and high-speed applications. Hydraulic actuators use pressurized oil that is incompressible. They can produce very large forces coupled with large motion in a cost-effective manner. The disadvantage with the hydraulic actuators is that they are more complex and need more maintenance.

The rotary motors are usually used in applications where low speed and high torque are required. The cylinder/piston actuators are suited for application of linear motion such as aircraft flap control. Control valves in the form of directional control valves are used in conjunction with rotary motors and cylinders to control the fluid flow direction as shown in Fig. 16.10. In this solenoid operated directional control valve, the valve position dictates the direction motion of the cylinder/piston arrangement.

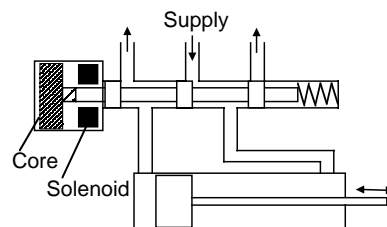

FIGURE 16.10 Solenoid operated directional control valve.

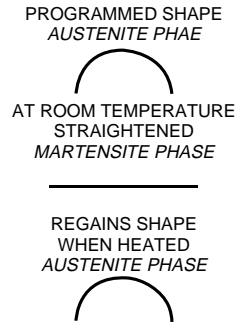

FIGURE 16.11 Phase changes of Shape Memory Alloy.

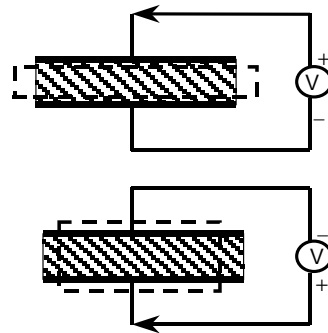

FIGURE 16.12 Piezoelectric actuator.

Smart Material Actuators

Unlike the conventional actuators, the smart material actuators typically become part of the load bearing structures. This is achieved by embedding the actuators in a distributed manner and integrating into the load bearing structure that could be used to suppress vibration, cancel the noise, and change shape. Of the many smart material actuators, *shape memory alloys*, *piezoelectric (PZT)*, *magnetostrictive*, *Electrorheological fluids*, and *ion exchange polymers* are most common.

Shape Memory Alloys (SMA) are alloys of nickel and titanium that undergo phase transformation when subjected to a thermal field. The SMAs are also known as NITINOL for Nickel Titanium Naval Ordnance Laboratory. When cooled below a critical temperature, their crystal structure enters martensitic phase as shown in Fig. 16.11. In this state the alloy is plastic and can easily be manipulated. When the alloy is heated above the critical temperature (in the range of 50–80°C), the phase changes to austenitic phase. Here the alloy resumes the shape that it formally had at the higher temperature. For example, a straight wire at room temperature can be made to regain its programmed semicircle shape when heated that has found applications in orthodontics and other tensioning devices. The wires are typically heated by passing a current (up to several amperes), 0 at very low voltage (2–10 V typical).

The PZT actuators are essentially piezocrystals with top and bottom conducting films as shown in Fig. 16.12. When an electric voltage is applied across the two conducting films, the crystal expands in the transverse direction as shown by the dotted lines. When the voltage polarity is reversed, the crystal contracts thereby providing bidirectional actuation. The interaction between the mechanical and electrical behavior of the piezoelectric materials can be expressed as:

$$T = c^E S - eE$$

where T is the stress, c^E is the elastic coefficients at constant electric field, S is the strain, e is the dielectric permittivity, and E is the electric field.

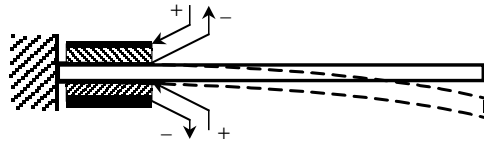

FIGURE 16.13 Vibration of beam using piezoelectric actuators.

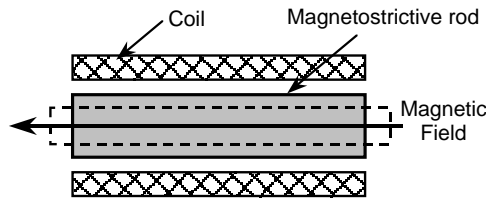

FIGURE 16.14 Magnetostrictive rod actuator.

One application of these actuators is as shown in Fig. 16.13. The two piezoelectric patches are excited with opposite polarity to create transverse vibration in the cantilever beam. These actuators provide high bandwidth (0–10 kHz typical) with small displacement. Since there are no moving parts to the actuator, it is compact and ideally suited for micro and nano actuation. Unlike the bidirectional actuation of piezoelectric actuators, the *electrostriction* effect is a second-order effect, i.e., it responds to an electric field with unidirectional expansion regardless of polarity.

Magnetostrictive material is an alloy of terbium, dysprosium, and iron that generates mechanical strains up to 2000 microstrain in response to applied magnetic fields. They are available in the form of rods, plates, washers, and powder. Figure 16.14 shows a typical magnetostrictive rod actuator that is surrounded by a magnetic coil. When the coil is excited, the rod elongates in proportion to the intensity of the magnetic field established. The magnetomechanical relationship is given as:

$$\varepsilon = S^H \sigma + dH$$

where, ε is the strain, S^H the compliance at constant magnetic field, σ the stress, d the magnetostriction constant, and H the magnetic field intensity.

Ion exchange polymers exploit the electro-osmosis phenomenon of the natural ionic polymers for purposes of actuation. When a voltage potential is applied across the cross-linked polyelectrolytic network, the ionizable groups attain a net charge generating a mechanical deformation. These types of actuators have been used to develop artificial muscles and artificial limbs. The primary advantage is their capacity to produce large deformation with a relatively low voltage excitation.

Micro- and Nanoactuators

Microactuators, also called micromachines, microelectromechanical system (MEMS), and microsystems are the tiny mobile devices being developed utilizing the standard microelectronics processes with the integration of semiconductors and machined micromechanical elements. Another definition states that any device produced by assembling extremely small functional parts of around 1–15 mm is called a micromachine.

In *electrostatic motors*, electrostatic force is dominant, unlike the conventional motors that are based on magnetic forces. For smaller micromechanical systems the electrostatic forces are well suited as an actuating force. Figure 16.15 shows one type of electrostatic motor. The rotor is an annular disk with uniform permittivity and conductivity. In operation, a voltage is applied to the two conducting parallel

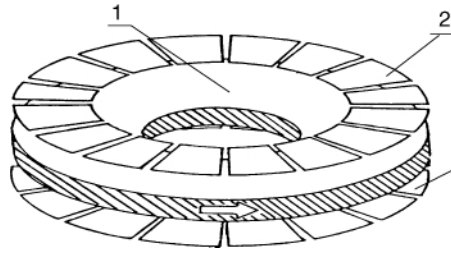

FIGURE 16.15 Electrostatic motor: 1-rotor, 2-stator electrodes.

plates separated by an insulation layer. The rotor rotates with a constant velocity between the two coplanar concentric arrays of stator electrodes.

Selection Criteria

The selection of the proper actuator is more complicated than selection of the sensors, primarily due to their effect on the dynamic behavior of the overall system. Furthermore, the selection of the actuator dominates the power needs and the coupling mechanisms of the entire system. The coupling mechanism can sometimes be completely avoided if the actuator provides the output that can be directly interfaced to the physical system. For example, choosing a linear motor in place of a rotary motor can eliminate the need of a coupling mechanism to convert rotary motion to linear motion.

In general, the following performance parameters must be addressed before choosing an actuator for a specific need:

Continuous power output—The maximum force/torque attainable continuously without exceeding the temperature limits

Range of motion—The range of linear/rotary motion

Resolution—The minimum increment of force/torque attainable

Accuracy—Linearity of the relationship between the input and output

Peak force/torque—The force/torque at which the actuator stalls

Heat dissipation—Maximum wattage of heat dissipation in continuous operation

Speed characteristics—Force/torque versus speed relationship

No load speed—Typical operating speed/velocity with no external load

Frequency response—The range of frequency over which the output follows the input faithfully, applicable to linear actuators

Power requirement—Type of power (AC or DC), number of phases, voltage level, and current capacity

In addition to the above-referred criteria, many other factors become important depending upon the type of power and the coupling mechanism required. For example, if a rack- and-pinion coupling mechanism is chosen, the backlash and friction will affect the resolution of the actuating unit.

17

Fundamentals of Time and Frequency

- 17.1 Introduction
 - Coordinated Universal Time (UTC)
- 17.2 Time and Frequency Measurement
 - Accuracy • Stability
- 17.3 Time and Frequency Standards
 - Quartz Oscillators • Rubidium Oscillators
 - Cesium Oscillators
- 17.4 Time and Frequency Transfer
 - Fundamentals of Time and Frequency Transfer
 - Radio Time and Frequency Transfer Signals
- 17.5 Closing

Michael A. Lombardi
National Institute of Standards
and Technology

17.1 Introduction

Time and frequency standards supply three basic types of information: *time-of-day*, *time interval*, and *frequency*. Time-of-day information is provided in hours, minutes, and seconds, but often also includes the *date* (month, day, and year). A device that displays or records time-of-day information is called a *clock*. If a clock is used to label when an event happened, this label is sometimes called a *time tag* or *time stamp*. Date and time-of-day can also be used to ensure that events are *synchronized*, or happen at the same time.

Time interval is the duration or elapsed time between two events. The standard unit of time interval is the second(s). However, many engineering applications require the measurement of shorter time intervals, such as milliseconds ($1 \text{ ms} = 10^{-3} \text{ s}$), microseconds ($1 \mu\text{s} = 10^{-6} \text{ s}$), nanoseconds ($1 \text{ ns} = 10^{-9} \text{ s}$), and picoseconds ($1 \text{ ps} = 10^{-12} \text{ s}$). Time is one of the seven base physical quantities, and the second is one of seven base units defined in the International System of Units (SI). The definitions of many other physical quantities rely upon the definition of the second. The second was once defined based on the earth's rotational rate or as a fraction of the tropical year. That changed in 1967 when the era of atomic time keeping formally began. The current definition of the SI second is:

The duration of 9,192,631,770 periods of the radiation corresponding to the transition between two hyperfine levels of the ground state of the cesium-133 atom.

Frequency is the rate of a repetitive event. If T is the period of a repetitive event, then the frequency f is its reciprocal, $1/T$. Conversely, the period is the reciprocal of the frequency, $T = 1/f$. Since the period is a time interval expressed in seconds (s), it is easy to see the close relationship between time interval and frequency. The standard unit for frequency is the hertz (Hz), defined as events or cycles per second. The frequency of electrical signals is often measured in multiples of hertz, including kilohertz (kHz), megahertz (MHz), or gigahertz (GHz), where 1 kHz equals one thousand (10^3) events per second, 1 MHz

TABLE 17.1 Uncertainties of Physical Realizations of the Base SI Units

| SI Base Unit | Physical Quantity | Uncertainty |
|--------------|---------------------|---------------------|
| Candela | Luminous intensity | 1×10^{-4} |
| Kelvin | Temperature | 3×10^{-7} |
| Mole | Amount of substance | 8×10^{-8} |
| Ampere | Electric current | 4×10^{-8} |
| Kilogram | Mass | 1×10^{-8} |
| Meter | Length | 1×10^{-12} |
| Second | Time interval | 1×10^{-15} |

equals one million (10^6) events per second, and 1 GHz equals one billion (10^9) events per second. A device that produces frequency is called an *oscillator*. The process of setting multiple oscillators to the same frequency is called *syntonization*.

Of course, the three types of time and frequency information are closely related. As mentioned, the standard unit of time interval is the second. By counting seconds, we can determine the date and the time-of-day. And by counting events or cycles per second, we can measure frequency.

Time interval and frequency can now be measured with less uncertainty and more resolution than any other physical quantity. Today, the best time and frequency standards can realize the SI second with uncertainties of $\cong 1 \times 10^{-15}$. Physical realizations of the other base SI units have much larger uncertainties, as shown in [Table 17.1](#) [1–5].

Coordinated Universal Time (UTC)

The world’s major metrology laboratories routinely measure their time and frequency standards and send the measurement data to the Bureau International des Poids et Mesures (BIPM) in Sevres, France. The BIPM averages data collected from more than 200 atomic time and frequency standards located at more than 40 laboratories, including the National Institute of Standards and Technology (NIST). As a result of this averaging, the BIPM generates two time scales, International Atomic Time (TAI), and Coordinated Universal Time (UTC). These time scales realize the SI second as closely as possible.

UTC runs at the same frequency as TAI. However, it differs from TAI by an integral number of seconds. This difference increases when *leap seconds* occur. When necessary, leap seconds are added to UTC on either June 30 or December 31. The purpose of adding leap seconds is to keep atomic time (UTC) within ± 0.9 s of an older time scale called UT1, which is based on the rotational rate of the earth. Leap seconds have been added to UTC at a rate of slightly less than once per year, beginning in 1972 [3,5].

Keep in mind that the BIPM maintains TAI and UTC as “paper” time scales. The major metrology laboratories use the published data from the BIPM to steer their clocks and oscillators and generate real-time versions of UTC. Many of these laboratories distribute their versions of UTC via radio signals, which are discussed in [section 17.4](#).

You can think of UTC as the ultimate standard for time-of-day, time interval, and frequency. Clocks synchronized to UTC display the same hour, minute, and second all over the world (and remain within one second of UT1). Oscillators syntonized to UTC generate signals that serve as reference standards for time interval and frequency.

17.2 Time and Frequency Measurement

Time and frequency measurements follow the conventions used in other areas of metrology. The frequency standard or clock being measured is called the *device under test (DUT)*. A measurement compares the DUT to a *standard* or *reference*. The standard should outperform the DUT by a specified ratio, called the *test uncertainty ratio (TUR)*. Ideally, the TUR should be 10:1 or higher. The higher the ratio, the less averaging is required to get valid measurement results.

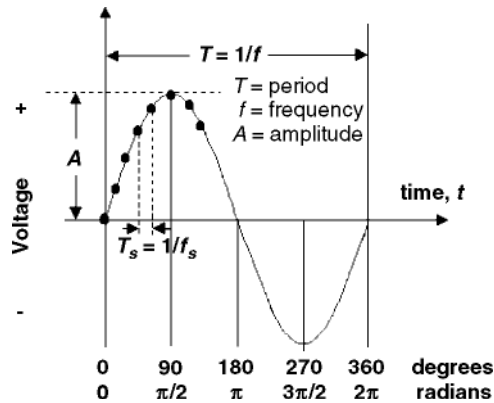

FIGURE 17.1 An oscillating sine wave.

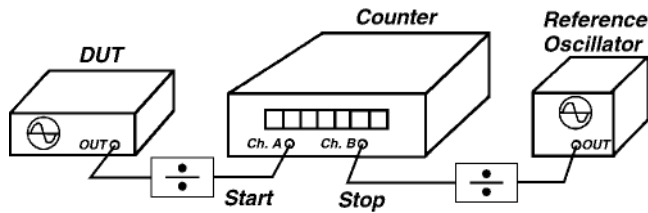

FIGURE 17.2 Measurement using a time interval counter.

The test signal for time measurements is usually a pulse that occurs once per second (1 pps). The pulse width and polarity varies from device to device, but TTL levels are commonly used. The test signal for frequency measurements is usually at a frequency of 1 MHz or higher, with 5 or 10 MHz being common. Frequency signals are usually sine waves, but can also be pulses or square waves. If the frequency signal is an oscillating sine wave, it might look like the one shown in Fig. 17.1. This signal produces one cycle (360° or 2π radians of phase) in one period. The signal amplitude is expressed in volts, and must be compatible with the measuring instrument. If the amplitude is too small, it might not be able to drive the measuring instrument. If the amplitude is too large, the signal must be attenuated to prevent overdriving the measuring instrument.

This section examines the two main specifications of time and frequency measurements—*accuracy* and *stability*. It also discusses some instruments used to measure time and frequency.

Accuracy

Accuracy is the degree of conformity of a measured or calculated value to its definition. Accuracy is related to the offset from an ideal value. For example, *time offset* is the difference between a measured on-time pulse and an ideal on-time pulse that coincides exactly with UTC. *Frequency offset* is the difference between a measured frequency and an ideal frequency with zero uncertainty. This ideal frequency is called the *nominal frequency*.

Time offset is usually measured with a *time interval counter (TIC)*, as shown in Fig. 17.2. A TIC has inputs for two signals. One signal starts the counter and the other signal stops it. The time interval between the start and stop signals is measured by counting cycles from the time base oscillator. The resolution of a low cost TIC is limited to the period of its time base. For example, a TIC with a 10-MHz time base oscillator would have a resolution of 100 ns. More elaborate TICs use interpolation schemes to detect parts of a time base cycle and have much higher resolution—1 ns resolution is commonplace, and 20 ps resolution is available.

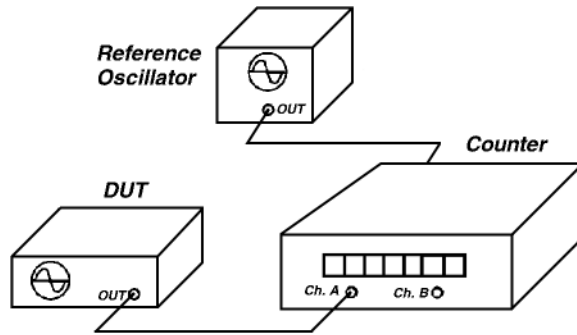

FIGURE 17.3 Measurement using a frequency counter.

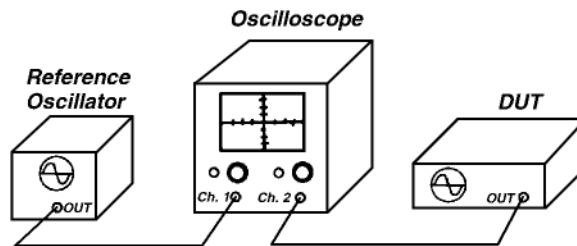

FIGURE 17.4 Phase comparison using an oscilloscope.

Frequency offset can be measured in either the *frequency domain* or *time domain*. A simple frequency domain measurement involves directly counting and displaying the frequency output of the DUT with a *frequency counter*. The reference for this measurement is either the counter's internal time base oscillator, or an external time base (Fig. 17.3). The counter's resolution, or the number of digits it can display, limits its ability to measure frequency offset. For example, a 9-digit frequency counter can detect a frequency offset no smaller than 0.1 Hz at 10 MHz (1×10^{-8}). The frequency offset is determined as

$$f(\text{offset}) = \frac{f_{\text{measured}} - f_{\text{nominal}}}{f_{\text{nominal}}}$$

where f_{measured} is the reading from the frequency counter, and f_{nominal} is the frequency labeled on the oscillator's nameplate, or specified output frequency.

Frequency offset measurements in the time domain involve a *phase comparison* between the DUT and the reference. A simple phase comparison can be made with an oscilloscope (Fig. 17.4). The oscilloscope will display two sine waves (Fig. 17.5). The top sine wave represents a signal from the DUT, and the bottom sine wave represents a signal from the reference. If the two frequencies were exactly the same, their phase relationship would not change and both would appear to be stationary on the oscilloscope display. Since the two frequencies are not exactly the same, the reference appears to be stationary and the DUT signal moves. By measuring the rate of motion of the DUT signal we can determine its frequency offset. Vertical lines have been drawn through the points where each sine wave passes through zero. The bottom of the figure shows bars whose width represents the phase difference between the signals. In this case the phase difference is increasing, indicating that the DUT is lower in frequency than the reference.

Measuring high accuracy signals with an oscilloscope is impractical, since the phase relationship between signals changes very slowly and the resolution of the oscilloscope display is limited. More precise phase comparisons can be made with a TIC, using a setup similar to Fig. 17.2. If the two input signals have the same frequency, the time interval will not change. If the two signals have different frequencies,

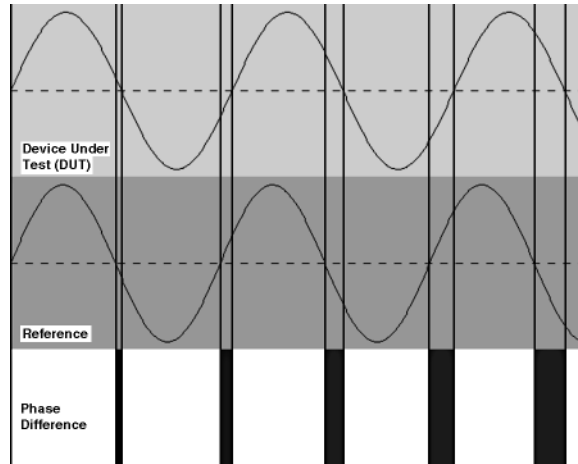

FIGURE 17.5 Two sine waves with a changing phase relationship.

the time interval will change, and the rate of change is the frequency offset. The resolution of a TIC determines the smallest frequency change that it can detect without averaging. For example, a low cost TIC with a single-shot resolution of 100 ns can detect frequency changes of 1×10^{-7} in 1 s. The current limit for TIC resolution is about 20 ps, which means that a frequency change of 2×10^{-11} can be detected in 1 s. Averaging over longer intervals can improve the resolution to <1 ps in some units [6].

Since standard frequencies like 5 or 10 MHz are not practical to measure with a TIC, *frequency dividers* (shown in Fig. 17.2) or *frequency mixers* are used to convert the test frequency to a lower frequency. Divider systems are simpler and more versatile, since they can be easily built or programmed to accommodate different frequencies. Mixer systems are more expensive, require more hardware including an additional reference oscillator, and can often measure only one input frequency (e.g., 10 MHz), but they have a higher signal-to-noise ratio than divider systems.

If dividers are used, measurements are made from the TIC, but instead of using these measurements directly, we determine the rate of change from reading to reading. This rate of change is called the *phase deviation*. We can estimate frequency offset as follows:

$$f(\text{offset}) = \frac{-\Delta t}{T}$$

where Δt is the amount of phase deviation, and T is the measurement period.

To illustrate, consider a measurement of $+1 \mu\text{s}$ of phase deviation over a measurement period of 24 h. The unit used for measurement period (h) must be converted to the unit used for phase deviation (μs). The equation becomes

$$f(\text{offset}) = \frac{-\Delta t}{T} = \frac{-1 \mu\text{s}}{86,400,000,000 \mu\text{s}} = -1.16 \times 10^{-11}$$

As shown, a device that accumulates $1 \mu\text{s}$ of phase deviation/day has a frequency offset of -1.16×10^{-11} with respect to the reference. This simple example requires only two time interval readings to be made, and Δt is simply the difference between the two readings. Often, multiple readings are taken and the frequency offset is estimated by using least squares linear regression on the data set, and obtaining Δt from the slope of the least squares line. This information is usually presented as a phase plot, as shown in Fig. 17.6. The device under test is high in frequency by exactly 1×10^{-9} , as indicated by a phase deviation of 1 ns/s [2,7,8].

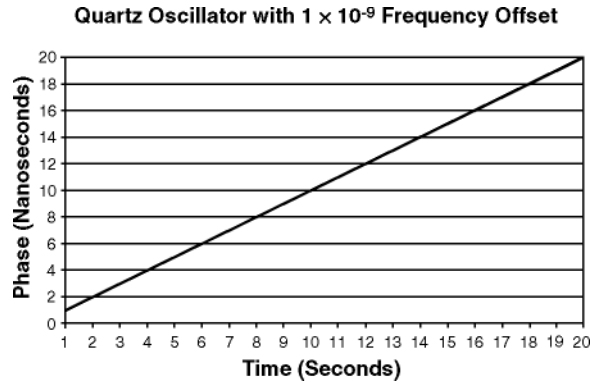

FIGURE 17.6 A sample phase plot.

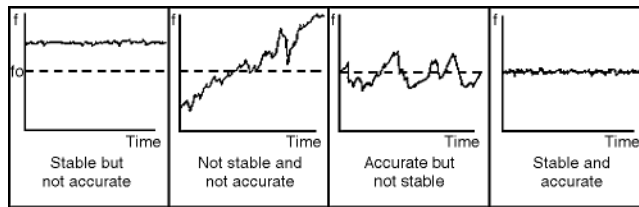

FIGURE 17.7 The relationship between accuracy and stability.

Dimensionless frequency offset values can be converted to units of frequency (Hz) if the nominal frequency is known. To illustrate this, consider an oscillator with a nominal frequency of 5 MHz and a frequency offset of $+1.16 \times 10^{-11}$. To find the frequency offset in hertz, multiply the nominal frequency by the offset:

$$(5 \times 10^6) (+1.16 \times 10^{-11}) = 5.80 \times 10^{-5} = +0.0000580 \text{ Hz}$$

Then, add the offset to the nominal frequency to get the actual frequency:

$$5,000,000 \text{ Hz} + 0.0000580 \text{ Hz} = 5,000,000.0000580 \text{ Hz}$$

Stability

Stability indicates how well an oscillator can produce the same time or frequency offset over a given time interval. It doesn't indicate whether the time or frequency is "right" or "wrong," but only whether it *stays the same*. In contrast, accuracy indicates how well an oscillator has been set on time or on frequency. To understand this difference, consider that a stable oscillator that needs adjustment might produce a frequency with a large offset. Or, an unstable oscillator that was just adjusted might temporarily produce a frequency near its nominal value. [Figure 17.7](#) shows the relationship between accuracy and stability.

Stability is defined as the statistical estimate of the frequency or time fluctuations of a signal over a given time interval. These fluctuations are measured with respect to a mean frequency or time offset. *Short-term* stability usually refers to fluctuations over intervals less than 100 s. *Long-term* stability can refer to measurement intervals greater than 100 s, but usually refers to periods longer than 1 day.

Stability estimates can be made in either the frequency domain or time domain, and can be calculated from a set of either frequency offset or time interval measurements. In some fields of measurement, stability is estimated by taking the standard deviation of the data set. However, standard deviation only

works with stationary data, where the results are time independent, and the noise is *white*, meaning that it is evenly distributed across the frequency band of the measurement. Oscillator data is usually nonstationary, since it contains time dependent noise contributed by the frequency offset. With stationary data, the mean and standard deviation will converge to particular values as more measurements are made. With nonstationary data, the mean and standard deviation never converge to any particular values. Instead, there is a moving mean that changes each time we add a measurement.

For these reasons, a non-classical statistic is often used to estimate stability in the time domain. This statistic is sometimes called the *Allan variance*, but since it is the square root of the variance, its proper name is the *Allan deviation*. The equation for the Allan deviation ($\sigma_y(\tau)$) is

$$\sigma_y(\tau) = \sqrt{\frac{1}{2(M-1)} \sum_{i=1}^{M-1} (y_{i+1} - y_i)^2}$$

where y_i is a set of frequency offset measurements containing y_1, y_2, y_3 , and so on, M is the number of values in the y_i series, and the data are equally spaced in segments τ seconds long. Or

$$\sigma_y(\tau) = \sqrt{\frac{1}{2(N-2)\tau^2} \sum_{i=1}^{N-2} [x_{i+2} - 2x_{i+1} + x_i]^2}$$

where x_i is a set of phase measurements in time units containing x_1, x_2, x_3 , and so on, N is the number of values in the x_i series, and the data are equally spaced in segments τ seconds long. Note that while standard deviation subtracts the mean from each measurement before squaring their summation, the Allan deviation subtracts the previous data point. This differencing of successive data points removes the time dependent noise contributed by the frequency offset.

An Allan deviation graph is shown in Fig. 17.8. It shows the stability of the device improving as the averaging period (τ) gets longer, since some noise types can be removed by averaging. At some point, however, more averaging no longer improves the results. This point is called the *noise floor*, or the point where the remaining noise consists of nonstationary processes such as flicker noise or random walk. The device measured in Fig. 17.8 has a noise floor of $\sim 5 \times 10^{-11}$ at $\tau = 100$ s.

Practically speaking, a frequency stability graph also tells us how long we need to average to get rid of the noise contributed by the reference and the measurement system. The noise floor provides some indication of the amount of averaging required to obtain a TUR high enough to show us the true frequency

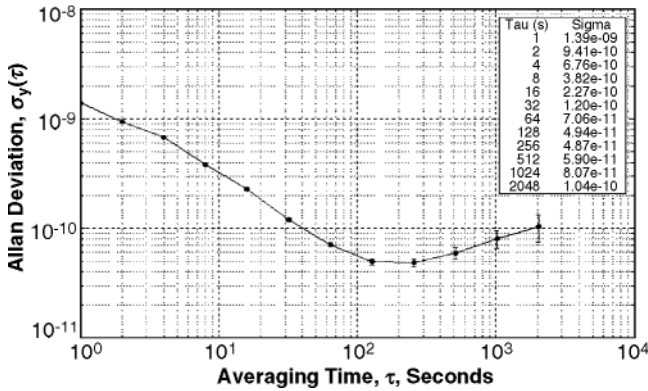

FIGURE 17.8 A frequency stability graph.

TABLE 17.2 Statistics Used to Estimate Time and Frequency Stability and Noise Types

| Name | Mathematical Notation | Description |
|--------------------------|----------------------------------|--|
| Allan deviation | $\sigma_y(\tau)$ | Estimates frequency stability. Particularly suited for intermediate- to long-term measurements. |
| Modified Allan deviation | MOD $\sigma_y(\tau)$ | Estimates frequency stability. Unlike the normal Allan deviation, it can distinguish between white and flicker phase noise, which makes it more suitable for short-term stability estimates. |
| Time deviation | $\sigma_x(\tau)$ | Used to measure time stability. Clearly identifies both white and flicker phase noise, the noise types of most interest when measuring time or phase. |
| Total deviation | $\sigma_{y, \text{TOTAL}}(\tau)$ | Estimates frequency stability. Particularly suited for long-term estimates where τ exceeds 10% of the total data sample. |

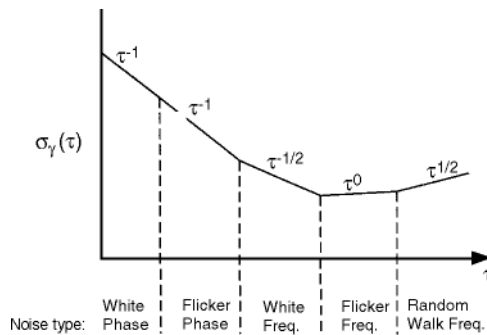

FIGURE 17.9 Using a frequency stability graph to identify noise types.

offset of the DUT. If the DUT is an atomic oscillator (section 17.4) and the reference is a radio controlled transfer standard (section 17.5) we might have to average for 24 h or longer to have confidence in the measurement result.

Five noise types are commonly discussed in the time and frequency literature: *white phase*, *flicker phase*, *white frequency*, *flicker frequency*, and *random walk frequency*. The slope of the Allan deviation line can help identify the amount of averaging needed to remove these noise types (Fig. 17.9). The first type of noise to be removed by averaging is phase noise, or the rapid, random fluctuations in the phase of the signal. Ideally, only the device under test would contribute phase noise to the measurement, but in practice, some phase noise from the measurement system and reference needs to be removed through averaging. Note that the Allan deviation does not distinguish between white phase noise and flicker phase noise. Table 17.2 shows several other statistics used to estimate stability and identify noise types for various applications.

Identifying and eliminating sources of oscillator noise can be a complex subject, but plotting the first order differences of a set of time domain measurements can provide a basic understanding of how noise is removed by averaging. Figure 17.10 was made using a segment of the data from the stability graph in Fig. 17.8. It shows phase plots dominated by white phase noise (1 s averaging), white frequency noise (64 s averages), flicker frequency noise (256 s averages), and random walk frequency (1024 s averages). Note that the white phase noise plot has a 2 ns scale, and the other plots use a 100 ps scale [8–12].

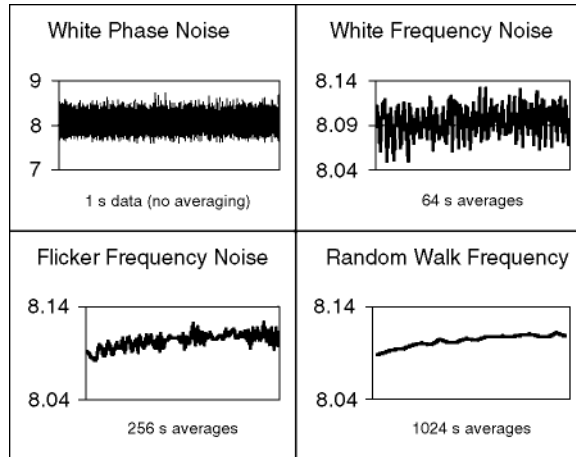

FIGURE 17.10 Phase plots of four noise types.

17.3 Time and Frequency Standards

All time and frequency standards are based on a *periodic event* that repeats at a constant rate. The device that produces this event is called a *resonator*. In the simple case of a pendulum clock, the pendulum is the resonator. Of course, a resonator needs an energy source before it can move back and forth. Taken together, the energy source and resonator form an *oscillator*. The oscillator runs at a rate called the *resonance frequency*. For example, a clock's pendulum can be set to swing back and forth at a rate of once per second. Counting one complete swing of the pendulum produces a time interval of 1 s. Counting the total number of swings creates a *time scale* that establishes longer time intervals, such as minutes, hours, and days. The device that does the counting and displays or records the results is called a *clock*. Table 17.3 shows how the frequency uncertainty of a clock's resonator corresponds to the timing uncertainty of a clock.

Throughout history, clock designers have searched for more stable resonators, and the evolution of time and frequency standards is summarized in Table 17.4. The uncertainties listed for modern standards represent current (year 2001) devices, and not the original prototypes. Note that the performance of time and frequency standards has improved by 13 orders of magnitude in the past 700 years, and by about nine orders of magnitude in the past 100 years.

The stability of time and frequency standards is closely related to their quality factor, or Q . The Q of an oscillator is its resonance frequency divided by its resonance width. The resonance frequency is the natural frequency of the oscillator. The resonance width is the range of possible frequencies where the oscillator will oscillate. A high- Q resonator will not oscillate at all unless it is near its resonance frequency. Obviously, a high resonance frequency and a narrow resonance width are both advantages when seeking a high Q . Generally speaking, the higher the Q , the more stable the oscillator, since a high Q means that an oscillator will stay close to its natural resonance frequency.

This section begins by discussing quartz oscillators, which achieve the highest Q of any mechanical-type device. It then discusses oscillators with much higher Q factors, based on the atomic resonance of rubidium and cesium. Atomic oscillators use the quantized energy levels in atoms and molecules as the source of their resonance. The laws of quantum mechanics dictate that the energies of a bound system, such as an atom, have certain discrete values. An electromagnetic field at a particular frequency can boost an atom from one energy level to a higher one. Or, an atom at a high energy level can drop to a lower level by emitting energy. The resonance frequency (f) of an atomic oscillator is the difference between

Table 17.3 Relationship of Frequency Uncertainty to Time Uncertainty

| Frequency Uncertainty | Measurement Period | Time Uncertainty |
|----------------------------|--------------------|------------------|
| $\pm 1.00 \times 10^{-3}$ | 1 s | ± 1 ms |
| $\pm 1.00 \times 10^{-6}$ | 1 s | ± 1 μ s |
| $\pm 1.00 \times 10^{-9}$ | 1 s | ± 1 ns |
| $\pm 2.78 \times 10^{-7}$ | 1 h | ± 1 ms |
| $\pm 2.78 \times 10^{-10}$ | 1 h | ± 1 μ s |
| $\pm 2.78 \times 10^{-13}$ | 1 h | ± 1 ns |
| $\pm 1.16 \times 10^{-8}$ | 1 day | ± 1 ms |
| $\pm 1.16 \times 10^{-11}$ | 1 day | ± 1 μ s |
| $\pm 1.16 \times 10^{-14}$ | 1 day | ± 1 ns |

TABLE 17.4 The Evolution of Time and Frequency Standards

| Standard | Resonator | Date of Origin | Timing Uncertainty (24 h) | Frequency Uncertainty (24 h) |
|---------------------------|--|----------------|---------------------------|------------------------------|
| Sundial | Apparent motion of the sun | 3500 B.C. | NA | NA |
| Verge escapement | Verge and foliet mechanism | 14th century | 15 min | 1×10^{-2} |
| Pendulum | Pendulum | 1656 | 10 s | 1×10^{-4} |
| Harrison chronometer (H4) | Spring and balance wheel | 1759 | 350 ms | 4×10^{-6} |
| Shortt pendulum | Two pendulums, slave and master | 1921 | 10 ms | 1×10^{-7} |
| Quartz crystal | Quartz crystal | 1927 | 10 μ s | 1×10^{-10} |
| Rubidium gas cell | 87 Rb resonance (6,834,682,608 Hz) | 1958 | 100 ns | 1×10^{-12} |
| Cesium beam | 133 Cs resonance (9,192,631,770 Hz) | 1952 | 1 ns | 1×10^{-14} |
| Hydrogen maser | Hydrogen resonance (1,420,405,752 Hz) | 1960 | 1 ns | 1×10^{-14} |
| Cesium fountain | 133 Cs resonance (9,192,631,770 Hz) | 1991 | 100 ps | 1×10^{-15} |

the two energy levels divided by Planck's constant (h):

$$f = \frac{E_2 - E_1}{h}$$

The principle underlying the atomic oscillator is that since all atoms of a specific element are identical, they should produce exactly the same frequency when they absorb or release energy. In theory, the atom is a perfect "pendulum" whose oscillations are counted to measure time interval. The discussion of atomic oscillators is limited to devices that are commercially available, and excludes the primary and experimental standards found in laboratories such as NIST. [Table 17.5](#) provides a summary [1,4,8].

Quartz Oscillators

Quartz crystal oscillators are by far the most common time and frequency standards. An estimated two billion (2×10^9) quartz oscillators are manufactured annually. Most are small devices built for wrist-watches, clocks, and electronic circuits. However, they are also found inside test and measurement equipment, such as counters, signal generators, and oscilloscopes; and interestingly enough, inside every atomic oscillator.

TABLE 17.5 Summary of Oscillator Types

| Oscillator Type | Quartz (TCXO) | Quartz (OCXO) | Rubidium | Commercial Cesium Beam | Hydrogen Maser |
|--|---|--|---|---|---|
| Q | 10^4 to 10^6 | 3.2×10^6 (5 MHz) | 10^7 | 10^8 | 10^9 |
| Resonance frequency | Various | Various | 6.834682608 GHz | 9.192631770 GHz | 1.420405752 GHz |
| Leading cause of failure | None | None | Rubidium lamp (life expectancy >15 years) | Cesium beam tube (life expectancy of 3 to 25 years) | Hydrogen depletion (life expectancy >7 years) |
| Stability, $\sigma_y(\tau)$, $\tau = 1$ s | 1×10^{-8} to 1×10^{-9} | 1×10^{-12} | 5×10^{-11} to 5×10^{-12} | 5×10^{-11} to 5×10^{-12} | 1×10^{-12} |
| Noise floor, $\sigma_y(\tau)$ | 1×10^{-9} ($\tau = 1$ to 10^2 s) | 1×10^{-12} ($\tau = 1$ to 10^2 s) | 1×10^{-12} ($\tau = 10^3$ to 10^5 s) | 1×10^{-12} ($\tau = 10^5$ to 10^7 s) | 1×10^{-15} ($\tau = 10^3$ to 10^5 s) |
| Aging/year | 5×10^{-7} | 5×10^{-9} | 1×10^{-10} | None | $\sim 1 \times 10^{-13}$ |
| Frequency offset after warm-up | 1×10^{-6} | 1×10^{-8} to 1×10^{-10} | 5×10^{-10} to 5×10^{-12} | 5×10^{-12} to 1×10^{-14} | 1×10^{-12} to 1×10^{-13} |
| Warm-Up period | <10 s to 1×10^{-6} | <5 min to 1×10^{-8} | <5 min to 5×10^{-10} | 30 min to 5×10^{-12} | 24 h to 1×10^{-12} |

A quartz crystal inside the oscillator is the resonator. It can be made of either natural or synthetic quartz, but all modern devices use synthetic quartz. The crystal strains (expands or contracts) when a voltage is applied. When the voltage is reversed, the strain is reversed. This is known as the *piezoelectric effect*. Oscillation is sustained by taking a voltage signal from the resonator, amplifying it, and feeding it back to the resonator. The rate of expansion and contraction is the resonance frequency and is determined by the cut and size of the crystal. The output frequency of a quartz oscillator is either the fundamental resonance or a multiple of the resonance, called an *overtone frequency*. Most high stability units use either the third or fifth overtone to achieve a high Q. Overtones higher than fifth are rarely used because they make it harder to tune the device to the desired frequency. A typical Q for a quartz oscillator ranges from 10^4 to 10^6 . The maximum Q for a high stability quartz oscillator can be estimated as $Q = 1.6 \times 10^7/f$, where f is the resonance frequency in megahertz.

Environmental changes due to temperature, humidity, pressure, and vibration can change the resonance frequency of a quartz crystal, but there are several designs that reduce these environmental effects. The *oven-controlled crystal oscillator (OCXO)* encloses the crystal in a temperature-controlled chamber called an oven. When an OCXO is turned on, it goes through a “warm-up” period while the temperatures of the crystal resonator and its oven stabilize. During this time, the performance of the oscillator continuously changes until it reaches its normal operating temperature. The temperature within the oven then remains constant, even when the outside temperature varies. An alternate solution to the temperature problem is the *temperature-compensated crystal oscillator (TCXO)*. In a TCXO, the signal from a temperature sensor is used to generate a correction voltage that is applied to a voltage-variable reactance, or varactor. The varactor then produces a frequency change equal and opposite to the frequency change produced by temperature. This technique does not work as well as oven control, but is less expensive. Therefore, TCXOs are used when high stability over a wide temperature range is not required.

Quartz oscillators have excellent short-term stability. An OCXO might be stable ($\sigma_y(\tau)$, at $\tau = 1$ s) to 1×10^{-12} . The limitations in short-term stability are due mainly to noise from electronic components in the oscillator circuits. Long-term stability is limited by *aging*, or a change in frequency with time due to internal changes in the oscillator. Aging is usually a nearly linear change in the resonance frequency that can be either positive or negative, and occasionally, a reversal in direction of aging occurs. Aging has many possible causes including a build-up of foreign material on the crystal, changes in the oscillator circuitry,

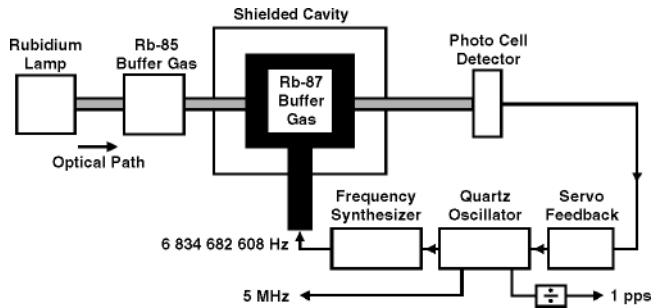

FIGURE 17.11 Rubidium oscillator.

or changes in the quartz material or crystal structure. A high quality OCXO might age at a rate of $<5 \times 10^{-9}$ per year, while a TCXO might age 100 times faster.

Due to aging and environmental factors such as temperature and vibration, it is hard to keep even the best quartz oscillators within 1×10^{-10} of their nominal frequency without constant adjustment. For this reason, atomic oscillators are used for applications that require better long-term accuracy and stability [4,13,14].

Rubidium Oscillators

Rubidium oscillators are the lowest priced members of the atomic oscillator family. They operate at 6,834,682,608 Hz, the resonance frequency of the rubidium atom (^{87}Rb), and use the rubidium frequency to control the frequency of a quartz oscillator. A microwave signal derived from the crystal oscillator is applied to the ^{87}Rb vapor within a cell, forcing the atoms into a particular energy state. An optical beam is then pumped into the cell and is absorbed by the atoms as it forces them into a separate energy state. A photo cell detector measures how much of the beam is absorbed, and its output is used to tune a quartz oscillator to a frequency that maximizes the amount of light absorption. The quartz oscillator is then locked to the resonance frequency of rubidium, and standard frequencies are derived from the quartz oscillator and provided as outputs (Fig. 17.11).

Rubidium oscillators continue to get smaller and less expensive, and offer perhaps the best price-to-performance ratio of any oscillator. Their long-term stability is much better than that of a quartz oscillator and they are also smaller, more reliable, and less expensive than cesium oscillators.

The Q of a rubidium oscillator is about 10^7 . The shifts in the resonance frequency are due mainly to collisions of the rubidium atoms with other gas molecules. These shifts limit the long-term stability. Stability ($\sigma_y(\tau)$, at $\tau = 1$ s) is typically 1×10^{-11} , and about 1×10^{-12} at 1 day. The frequency offset of a rubidium oscillator ranges from 5×10^{-10} to 5×10^{-12} after a warm-up period of a few minutes or hours, so they meet the accuracy requirements of most applications without adjustment.

Cesium Oscillators

Cesium oscillators are primary frequency standards since the SI second is defined from the resonance frequency of the cesium atom (^{133}Cs), which is 9,192,631,770 Hz. A properly working cesium oscillator should be close to its nominal frequency without adjustment, and there should be no change in frequency due to aging.

Commercially available oscillators use *cesium beam* technology. Inside a cesium oscillator, ^{133}Cs atoms are heated to a gas in an oven. Atoms from the gas leave the oven in a high-velocity beam that travels through a vacuum tube toward a pair of magnets. The magnets serve as a gate that allows only atoms of a particular magnetic energy state to pass into a microwave cavity, where they are exposed to a microwave

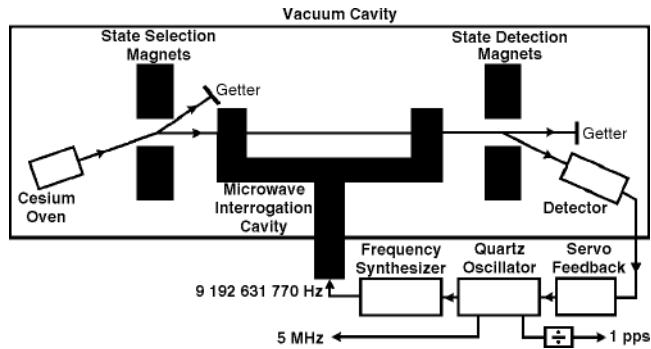

FIGURE 17.12 Cesium beam oscillator.

frequency derived from a quartz oscillator. If the microwave frequency matches the resonance frequency of cesium, the cesium atoms change their magnetic energy state.

The atomic beam then passes through another magnetic gate near the end of the tube. Those atoms that changed their energy state while passing through the microwave cavity are allowed to proceed to a detector at the end of the tube. Atoms that did not change state are deflected away from the detector. The detector produces a feedback signal that continually tunes the quartz oscillator in a way that maximizes the number of state changes so that the greatest number of atoms reaches the detector. Standard output frequencies are derived from the locked quartz oscillator (Fig. 17.12).

The Q of a commercial cesium standard is a few parts in 10^8 . The beam tube is typically <0.5 m in length, and the atoms travel at velocities of >100 m/s inside the tube. This limits the observation time to a few milliseconds, and the resonance width to a few hundred hertz. Stability ($\sigma_y(\tau)$, at $\tau = 1$ s) is typically 5×10^{-12} and reaches a noise floor near 1×10^{-14} at about 1 day, extending out to weeks or months. The frequency offset is typically near 1×10^{-12} after a warm-up period of 30 min.

17.4 Time and Frequency Transfer

Many applications require clocks or oscillators at different locations to be set to the same time (*synchronization*), or the same frequency (*syntonization*). *Time and frequency transfer* techniques are used to compare and adjust clocks and oscillators at different locations. Time and frequency transfer can be as simple as setting your wristwatch to an audio time signal, or as complex as controlling the frequency of oscillators in a network to parts in 10^{13} .

Time and frequency transfer can use signals broadcast through many different media, including coaxial cables, optical fiber, radio signals (at numerous places in the radio spectrum), telephone lines, and the Internet. Synchronization requires both an on-time pulse and a time code. Syntonization requires extracting a stable frequency from the broadcast. The frequency can come from the carrier itself, or from a time code or other information modulated onto the carrier.

This section discusses both the fundamentals of time and frequency transfer and the radio signals used as calibration references. Table 17.6 provides a summary.

Fundamentals of Time and Frequency Transfer

Signals used for time and frequency transfer are generally referenced to atomic oscillators that are steered to agree as closely as possible with UTC. Information is sent from a transmitter (A) to a receiver (B) and is delayed by τ_{ab} , commonly called the *path delay* (Fig. 17.13).

To illustrate path delay, consider a radio signal broadcast over a path 1000 km long. Since radio signals travel at the speed of light ($\sim 3.3 \mu\text{s}/\text{km}$), we can calibrate the path by applying a 3.3-ms correction to

TABLE 17.6 Summary of Time and Frequency Transfer Signals and Methods

| Signal or Link | Receiving Equipment | Time Uncertainty (24 h) | Frequency Uncertainty (24 h) |
|---------------------------------|--|-------------------------|--|
| Dial-Up Computer Time Service | Computer, client software, modem, and phone line | <15 ms | Not recommended for frequency measurements |
| Internet Time Service | Computer, client software, and Internet connection | <1 s | Not recommended for frequency measurements |
| HF Radio (3 to 30 MHz) | HF receiver and antenna | 1 to 20 ms | 10^{-6} to 10^{-9} |
| LF Radio (30 to 300 kHz) | LF receiver and antenna | 1 to 100 μ s | 10^{-10} to 10^{-12} |
| Global Positioning System (GPS) | GPS receiver antenna | <20 ns | $<2 \times 10^{-13}$ |

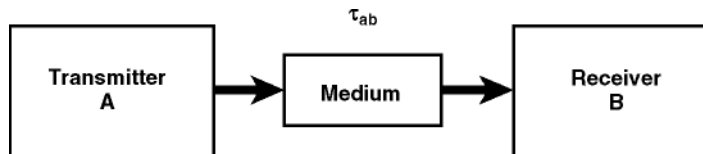

FIGURE 17.13 One-way time and frequency transfer.

our measurement. Of course, for many applications the path delay is simply ignored. For example, if our goal is simply to synchronize a computer clock within 1 s of UTC, there is no need to worry about a 100-ms path delay through a network. And, of course, path delay is not important to frequency transfer systems, since on-time pulses are not required. Instead, frequency transfer requires only a stable path where the delays remain relatively constant.

More sophisticated transfer systems estimate and remove all or part of the path delay. This is usually done in one of two ways. The first way is to estimate τ_{ab} and send the time out early by this amount. For example, if τ_{ab} is at least 20 ms for all users, the time can be sent 20 ms early. This advancement of the timing signal removes at least some of the delay for all users.

A better technique is to compute τ_{ab} and to apply a correction to the received signal. A correction for τ_{ab} can be computed if the position of both the transmitter and receiver are known. If the transmitter is stationary, a constant can be used for the transmitter position. If the transmitter is moving (a satellite, for example) it must broadcast its position in addition to broadcasting time. The Global Positioning System (GPS) provides the best of both worlds—each GPS satellite broadcasts its position and the receiver can use coordinates from multiple satellites to compute its own position.

The transmitted information often includes a *time code* so that a clock can be set to the correct time-of-day. Most time codes contain the UTC hour, minute, and second; the month, day, and year; and advance warning of daylight saving time and leap seconds.

Radio Time and Frequency Transfer Signals

There are many types of radio receivers designed to receive time and frequency signals. Some are designed primarily to produce time-of-day information or an on-time pulse, others are designed to output standard frequencies, and some can be used for both time and frequency transfer. The following sections look at three types of time and frequency radio signals that distribute UTC—high frequency (HF), low frequency (LF), and GPS satellite signals.

HF Radio Signals (Including WWV and WWVH)

High frequency (HF) radio broadcasts occupy the radio spectrum from 3 to 30 MHz. These signals are commonly used for time and frequency transfer at moderate performance levels. Some HF broadcasts provide audio time announcements and digital time codes. Other broadcasts simply provide a carrier frequency for use as a reference.

HF time and frequency stations include NIST radio stations WWV and WWVH. WWV is located near Fort Collins, Colorado, and WWVH is on the island of Kauai, Hawaii. Both stations broadcast continuous time and frequency signals on 2.5, 5, 10, and 15 MHz, and WWV also broadcasts on 20 MHz. All frequencies broadcast the same program, and at least one frequency should be usable at all times. The stations can also be heard by telephone; dial (303) 499-7111 for WWV or (808) 335-4363 for WWVH.

WWV and WWVH signals can be used in one of three modes:

- The audio portion of the broadcast includes seconds pulses or ticks, standard audio frequencies, and voice announcements of the UTC hour and minute. WWV uses a male voice, and WWVH uses a female voice.
- A binary time code is sent on a 100 Hz subcarrier at a rate of 1 bit per second. The time code contains the hour, minute, second, year, day of year, leap second and Daylight Saving Time (DST) indicators, and a UT1 correction. This code can be read and displayed by radio clocks.
- The carrier frequency can be used as a reference for the calibration of oscillators. This is done most often with the 5 and 10 MHz carrier signals, since they match the output frequencies of standard oscillators.

The time broadcast by WWV and WWVH will be late when it arrives at the user's location. The time offset depends upon the receiver's distance from the transmitter, but should be <15 ms in the continental United States. A good estimate of the time offset requires knowledge of HF radio propagation. Most users receive a signal that has traveled up to the ionosphere and was then reflected back to earth. Since the height of the ionosphere changes throughout the day, the path delay also changes. Path delay variations limit the received frequency uncertainty to parts in 10^9 when averaged for 1 day.

HF radio stations such as WWV and WWVH are useful for low level applications, such as the manual synchronization of analog and digital clocks, simple frequency calibrations, and calibrations of stop watches and timers. However, LF and GPS signals are better choices for more demanding applications [2,7,15].

LF Radio Signals (Including WWVB)

Before the advent of satellites, low frequency (LF) signals were the method of choice for time and frequency transfer. While the use of LF signals has diminished in the laboratory, they still have two major advantages—they can often be received indoors without an external antenna and several stations broadcast a time code. This makes them ideal for many consumer electronic products that display time-of-day information.

Many time and frequency stations operate in the LF band from 30 to 300 kHz (Table 17.7). The performance of the received signal is influenced by the path length and signal strength. Path length is important because the signal is divided into ground wave and sky wave. The ground wave signal is more stable. Since it travels the shortest path between the transmitter and receiver, it arrives first and its path delay is much easier to estimate. The sky wave is reflected from the ionosphere and produces results similar to those obtained with HF reception. Short paths make it possible to continuously track the ground wave. Longer paths produce a mixture of sky wave and ground wave. And over very long paths, only sky wave reception is possible.

Signal strength is also important. If the signal is weak, the receiver might search for a new cycle of the carrier to track. Each time the receiver adjusts its tracking point by one cycle, it introduces a phase step equal to the period of the carrier. For example, a cycle slip on a 60 kHz carrier introduces a $16.67 \mu\text{s}$ phase step. However, a strong ground wave signal can produce very good results. An LF receiver that

TABLE 17.7 LF Time and Frequency Broadcast Stations

| Call Sign | Country | Frequency (kHz) | Always On? |
|-----------|----------------|--------------------|------------|
| DCF77 | Germany | 77.5 | Yes |
| DGI | Germany | 177 | Yes |
| HBG | Switzerland | 75 | Yes |
| JG2AS | Japan | 40 | Yes |
| MSF | United Kingdom | 60 | Yes |
| RBU | Russia | 66.666 | No |
| RTZ | Russia | 50 | Yes |
| TDF | France | 162 | Yes |
| WWVB | United States | 60 | Yes |

continuously tracks the same cycle of a ground wave signal can transfer frequency with an uncertainty of about 1×10^{-12} when averaged for 1 day.

NIST operates LF radio station WWVB from Fort Collins, Colorado at a transmission frequency of 60 kHz. The station broadcasts 24 h per day, with an effective radiated output power of 50 kW. The WWVB time code is synchronized with the 60 kHz carrier and contains the year, day of year, hour, minute, second, and flags that indicate the status of daylight saving time, leap years, and leap seconds. The time code is received and displayed by wristwatches, alarm clocks, wall clocks, and other consumer electronic products [2,7,15].

Global Positioning System (GPS)

The GPS is a navigation system developed and operated by the U.S. Department of Defense (DoD) that is usable nearly anywhere on the earth. The system consists of a constellation of at least 24 satellites that orbit the earth at a height of 20,200 km in six fixed planes inclined 55° from the equator. The orbital period is 11 h 58 m, which means that each satellite will pass over the same place on earth twice per day. By processing signals received from the satellites, a GPS receiver can determine its position with an uncertainty of <10 m.

The satellites broadcast on two carrier frequencies, L1 at 1575.42 MHz and L2 at 1227.6 MHz. Each satellite broadcasts a spread spectrum waveform, called a *pseudo random noise (PRN)* code on L1 and L2, and each satellite is identified by the PRN code it transmits. There are two types of PRN codes. The first type is a *coarse acquisition (C/A)* code with a chipping rate of 1023 chips per millisecond. The second is a *precision (P)* code with a chipping rate of 10230 chips per millisecond. The C/A code is broadcast on L1, and the P code is broadcast on both L1 and L2. GPS reception is line-of-sight, which means that the receiving antenna must have a clear view of the sky [16].

Each satellite carries either rubidium or cesium oscillators, or a combination of both. These oscillators are steered from DoD ground stations and are referenced to the United States Naval Observatory time scale, UTC (USNO), which by agreement is always maintained within 100 ns of UTC (NIST). The oscillators provide the reference for both the carrier and the code broadcasts.

GPS signals now dominate the world of high performance time and frequency transfer, since they provide reliable reception and exceptional results with minimal effort. A GPS receiver can automatically compute its latitude, longitude, and altitude from position data received from the satellites. The receiver can then calibrate the radio path and synchronize its on-time pulse. In addition to the on-time pulse, many receivers provide standard frequencies such as 5 or 10 MHz by steering an OCXO or rubidium oscillator using the satellite signals. GPS receivers also produce time-of-day and date information.

A GPS receiver calibrated for equipment delays has a timing uncertainty of <20 ns relative to UTC (NIST), and the frequency uncertainty is often $<2 \times 10^{-13}$ when averaged for 1 day. Figure 17.14 shows an Allan deviation plot of the output of a low cost GPS receiver. The stability is near 1×10^{-13} after about 1 day of averaging.

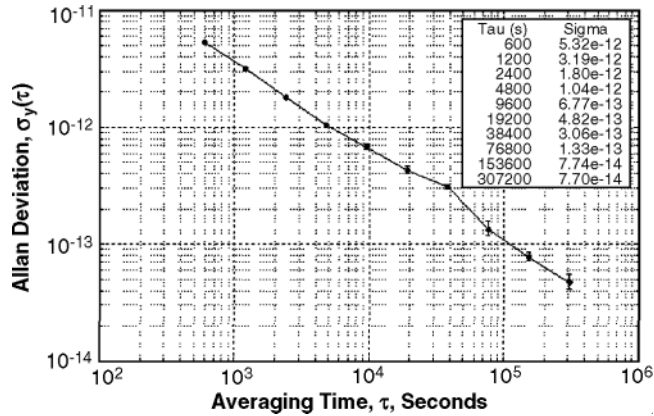

FIGURE 17.14 Frequency stability of GPS receiver.

17.5 Closing

As noted earlier, time and frequency standards and measurements have improved by about nine orders of magnitude in the past 100 years. This rapid advance has made many new products and technologies possible. While it is impossible to predict what the future holds, we can be certain that oscillator Qs will continue to increase, measurement uncertainties will continue to decrease, and new technologies will continue to emerge.

References

1. Jespersen, J., and Fitz-Randolph, J., *From Sundials to Atomic Clocks: Understanding Time and Frequency*, 2nd ed., Dover, Mineola, New York, 1999.
2. Kamas, G., and Lombardi, M. A., *Time and Frequency Users Manual*, NIST Special Publication 559, U.S. Government Printing Office, Washington, DC, 1990.
3. Levine, J., Introduction to time and frequency metrology, *Rev. Sci. Instrum.*, 70, 2567, 1999.
4. Hackman, C., and Sullivan, D. B., Eds., *Time and Frequency Measurement*, American Association of Physics Teachers, College Park, Maryland, 1996.
5. ITU Radiocommunication Study Group 7, *Selection and Use of Precise Frequency and Time Systems*, International Telecommunications Union, Geneva, Switzerland, 1997.
6. Novick, A. N., Lombardi, M. A., Zhang, V. S., and Carpentier, A., A high performance multi-channel time interval counter with an integrated GPS receiver, in *Proc. 31st Annu. Precise Time and Time Interval (PTTI) Meeting*, Dana Point, California, p. 561, 1999.
7. Lombardi, M. A., Time measurement and frequency measurement, in *The Measurement, Instrumentation, and Sensors Handbook*, Webster, J. G., Eds., CRC Press, Boca Raton, Florida, 1999, chap. 18–19.
8. Sullivan, D. B., Allan, D. W., Howe, D. A., and Walls, F. L., Eds., *Characterization of Clocks and Oscillators*, NIST Technical Note 1337, U.S. Government Printing Office, Washington, DC, 1990.
9. Jespersen, J., Introduction to the time domain characterization of frequency standards, in *Proc. 23rd Annu. Precise Time and Time Interval (PTTI) Meeting*, Pasadena, California, p. 83, 1991.
10. IEEE Standards Coordinating Committee 27, *IEEE Standard Definitions of Physical Quantities for Fundamental Frequency and Time Metrology—Random Instabilities*, Institute of Electrical and Electronics Engineers, New York, 1999.
11. Walls, F. L., and Ferre-Pikal, E. S., Measurement of frequency, phase noise, and amplitude noise, in *Wiley Encyclopedia of Electrical and Electronics Engineering*, John Wiley and Sons, New York, 1999, 12, 459.

12. Howe, D. A., An extension of the Allan variance with increased confidence at long term, *IEEE Int. Freq. Control Symp.*, 321, 1995.
13. Vig, J. R., Introduction to quartz frequency standards, *Army Research and Development Technical Report*, SLCET-TR-92-1, October 1992.
14. Hewlett-Packard Company, *Fundamentals of Quartz Oscillators*, HP Application Note 200-2, 1997.
15. Carr, J. J., *Elements of Electronic Instrumentation and Measurement*, 3rd ed., Prentice-Hall, NJ, 1996.
16. Hoffmann-Wellenhof, B., Lichtenegger, H., and Collins, J., *GPS: Theory and Practice*, 3rd ed., Springer-Verlag, New York, 1994.

18

Sensor and Actuator Characteristics

- 18.1 Range
- 18.2 Resolution
- 18.3 Sensitivity
- 18.4 Error
- 18.5 Repeatability
- 18.6 Linearity and Accuracy
- 18.7 Impedance
- 18.8 Nonlinearities
- 18.9 Static and Coulomb Friction
- 18.10 Eccentricity
- 18.11 Backlash
- 18.12 Saturation
- 18.13 Deadband
- 18.14 System Response
- 18.15 First-Order System Response
- 18.16 Underdamped Second-Order System Response
- 18.17 Frequency Response

Joey Parker
University of Alabama

Mechatronic systems use a variety of sensors and actuators to measure and manipulate mechanical, electrical, and thermal systems. Sensors have many characteristics that affect their measurement capabilities and their suitability for each application. Analog sensors have an output that is continuous over a finite region of inputs. Examples of analog sensors include potentiometers, LVDTs (linear variable differential transformers), load cells, and thermistors. Digital sensors have a fixed or countable number of different output values. A common digital sensor often found in mechatronic systems is the incremental encoder. An analog sensor output conditioned by an analog-to-digital converter (ADC) has the same digital output characteristics, as seen in Fig. 18.1.

18.1 Range

The range (or span) of a sensor is the difference between the minimum (or most negative) and maximum inputs that will give a valid output. Range is typically specified by the manufacturer of the sensor. For example, a common type K thermocouple has a range of 800°C (from -50°C to 750°C). A ten-turn potentiometer would have a range of 3600 degrees.

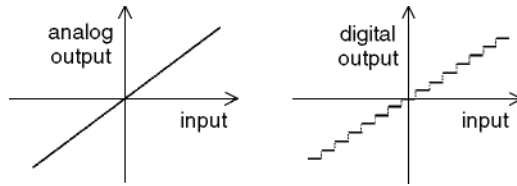

FIGURE 18.1 Analog and digital sensor outputs.

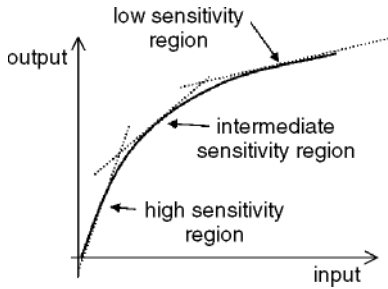

FIGURE 18.2 Sensor sensitivity.

18.2 Resolution

The resolution of a sensor is the smallest increment of input that can be reliably detected. Resolution is also frequently known as the least count of the sensor. Resolution of digital sensors is easily determined. A 1024 ppr (pulse per revolution) incremental encoder would have a resolution of

$$\frac{1 \text{ revolution}}{1024 \text{ pulses}} \times \frac{360 \text{ degrees}}{1 \text{ revolution}} = 0.3516 \frac{\text{degrees}}{\text{pulse}}$$

The resolution of analog sensors is usually limited only by low-level electrical noise and is often much better than equivalent digital sensors.

18.3 Sensitivity

Sensor sensitivity is defined as the change in output per change in input. The sensitivity of digital sensors is closely related to the resolution. The sensitivity of an analog sensor is the slope of the output versus input line. A sensor exhibiting truly linear behavior has a constant sensitivity over the entire input range. Other sensors exhibit nonlinear behavior where the sensitivity either increases or decreases as the input is changed, as shown in Fig. 18.2.

18.4 Error

Error is the difference between a measured value and the true input value. Two classifications of errors are bias (or systematic) errors and precision (or random) errors. Bias errors are present in all measurements made with a given sensor, and cannot be detected or removed by statistical means. These bias errors can be further subdivided into

- calibration errors (a zero or null point error is a common type of bias error created by a nonzero output value when the input is zero),
- loading errors (adding the sensor to the measured system changes the system), and
- errors due to sensor sensitivity to variables other than the desired one (e.g., temperature effects on strain gages).

18.5 Repeatability

Repeatability (or reproducibility) refers to a sensor's ability to give identical outputs for the same input. Precision (or random) errors cause a lack of repeatability. Fortunately, precision errors can be accounted for by averaging several measurements or other operations such as low-pass filtering. Electrical noise and hysteresis (described later) both contribute to a loss of repeatability.

18.6 Linearity and Accuracy

The accuracy of a sensor is inversely proportional to error, i.e., a highly accurate sensor produces low errors. Many manufacturers specify accuracy in terms of the sensor's linearity. A least-squares straight-line fit between all output measurements and their corresponding inputs determines the nominal output of the sensor. Linearity (or accuracy) is specified as a percentage of full scale (maximum valid input), as shown in Fig. 18.3, or as a percentage of the sensor reading, as shown in Fig. 18.4. Figures 18.3 and 18.4 show both of these specifications for 10% linearity, which is much larger than most actual sensors.

Accuracy and precision are two terms that are frequently confused. Figure 18.5 shows four sets of histograms for ten measurements of angular velocity of an actuator turning at a constant 100 rad/s. The first set of data shows a high degree of precision (low standard deviation) and repeatability, but the

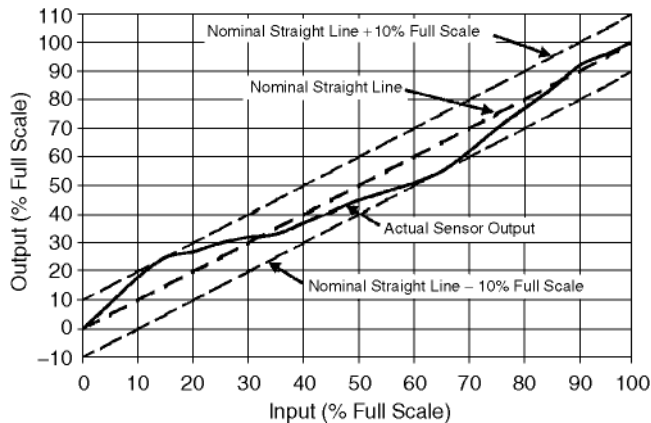

FIGURE 18.3 Linearity specified at full scale.

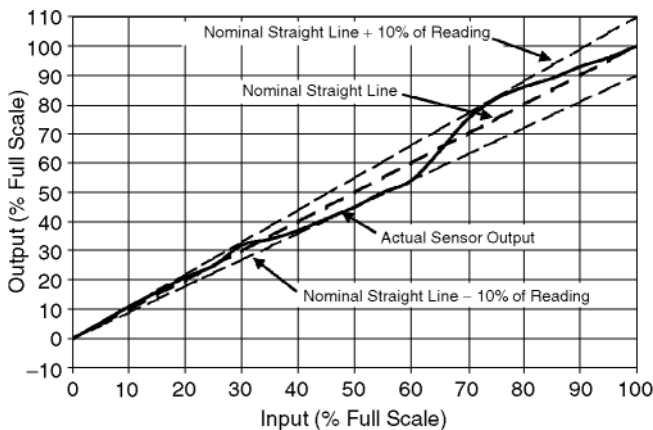

FIGURE 18.4 Linearity specified at reading.

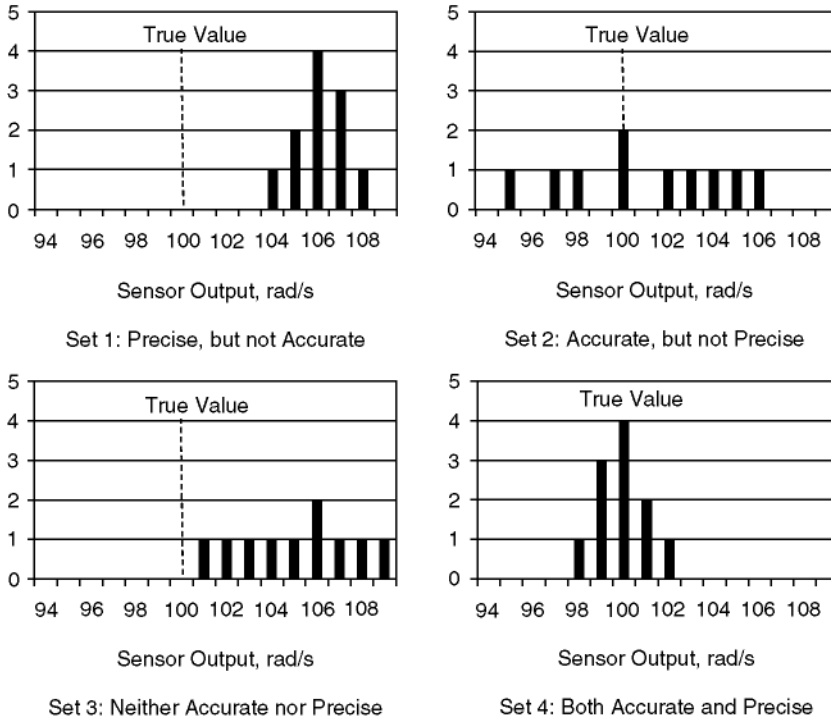

FIGURE 18.5 Examples of accuracy and precision.

average accuracy is poor. The second set of data shows a low degree of precision (high standard deviation), but the average accuracy is good. The third set of data shows both low precision and low accuracy, while the fourth set of data shows both high precision, high repeatability, and high accuracy.

18.7 Impedance

Impedance is the ratio of voltage and current flow for a sensor. For a simple resistive sensor (such as a strain gage or a thermistor), the impedance Z is the same as the resistance R , which has units of ohms (Ω),

$$Z_R = \frac{V}{I} = R$$

For more complicated sensors, impedance includes the effects of capacitance, C , and inductance, L . Inclusion of these terms makes the impedance frequency sensitive, but the units remain ohms:

$$Z_C = \frac{V}{I} = \frac{1}{jC\omega} \quad \text{and} \quad Z_L = \frac{V}{I} = jL\omega$$

where $j = \sqrt{-1}$ is the imaginary number and ω is the driving frequency. The impedance form is particularly nice for analyzing simple circuits, as parallel and series inductances can be treated just like resistances. Two types of impedance are important in sensor applications: input impedance and output impedance. Input impedance is a measure of how much current must be drawn to power a sensor (or signal conditioning circuit). Input impedance is frequently modeled as a resistor in parallel with the

input terminals. High input impedance is desirable, since the device will then draw less current from the source. Oscilloscopes and data acquisition equipment frequently have input impedances of $1\text{ M}\Omega$ or more to minimize this current draw. Output impedance is a measure of a sensor's (or signal conditioning circuit's) ability to provide current for the next stage of the system. Output impedance is frequently modeled as a resistor in series with the sensor output. Low output impedance is desirable, but is often not available directly from a sensor. Piezoelectric sensors in particular have high output impedances and cannot source much current (typically micro-amps or less). Op-amp circuits are frequently used to buffer sensor outputs for this reason. Op-amp circuits (especially voltage followers) provide nearly ideal circumstances for many sensors, since they have high input impedance but can substantially lower output impedance.

18.8 Nonlinearities

Linear systems have the property of superposition. If the response of the system to input A is output A, and the response to input B is output B, then the response to input C (= input A + input B) will be output C (= output A + output B). Many real systems will exhibit linear or nearly linear behavior over some range of operation. Therefore, linear system analysis is correct, at least over these portions of a system's operating envelope. Unfortunately, most real systems have nonlinearities that cause them to operate outside of this linear region, and many common assumptions about system behavior, such as superposition, no longer apply. Several nonlinearities commonly found in mechatronic systems include static and coulomb friction, eccentricity, backlash (or hysteresis), saturation, and deadband.

18.9 Static and Coulomb Friction

In classic linear system analysis, friction forces are assumed to be proportional to velocity, i.e., viscous friction. With an actuator velocity of zero, there should be no friction. In reality, a small amount of static (no velocity) or Coulomb friction is almost always present, even in roller or ball type anti-friction bearings. A typical plot of friction force vs. velocity is given in Fig. 18.6. Note that the static friction force can assume any value between some upper and lower limit at zero velocity. Static friction has two primary effects on mechatronic systems:

1. Some of the actuator torque or force is wasted overcoming friction forces, which leads to inefficiency from an energy viewpoint.
2. As the actuator moves the system to its final location, the velocity approaches zero and the actuator force/torque will approach a value that exactly balances frictional and gravity loads. Since static friction can assume any value at zero velocity, the actuator will come to slightly different final resting positions each time—depending on the final value of static friction. This effect contributes to some loss of repeatability in mechatronic systems.

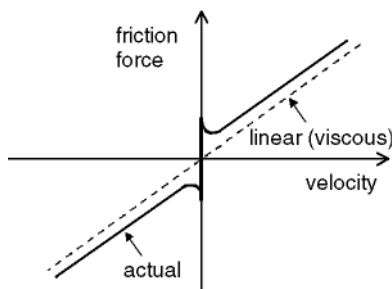

FIGURE 18.6 Static and Coulomb friction.

18.10 Eccentricity

The ideal relationships for gears, pulleys, and chain drives assume that the point of gear contact remains at a fixed distance from the center of rotation for each gear. In reality, the true center of the gears pitch circle and the center of rotation will be separated by a small amount, known as the eccentricity. Small tooth-to-tooth errors can also cause local variations in the pitch circle radius. The combination of these two effects can lead to a nonlinear geometrical relationship between two gears like that of Fig. 18.7, where the nonlinear behavior is greatly exaggerated for clarity. Eccentricity impacts the accuracy of position measurements made on the input side of the gear pair, as the output gear is not exactly where the sensor measurement indicates.

18.11 Backlash

If two otherwise perfect gears are not mounted on a center-to-center distance that exactly matches the sum of the pitch radii, there will be a small clearance, or backlash, between the teeth. When the input gear reverses direction, a small rotation is required before this clearance is removed and the output gear begins to move. Gear backlash is just one of many phenomena that can be characterized as hysteresis, as shown in Fig. 18.8. Clearance between shafts and bearings can cause hysteretic effects also. Backlash exhibits effects similar to those for eccentricity, i.e., a loss of repeatability, particularly when approaching a measured point from different directions. The gear backlash problem is so prevalent and potentially harmful that many manufacturers go to great lengths to minimize or reduce the effect:

- gears mounted closer together than the theoretically ideal spacing,
- split “anti-backlash” gears that are spring loaded to force teeth to maintain engagement at all times,
- external spring-loaded mounts for one of the gears to force engagement, or
- specially designed gears with anti-backlash features.

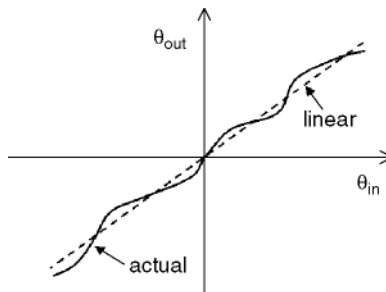

FIGURE 18.7 Gear eccentricity.

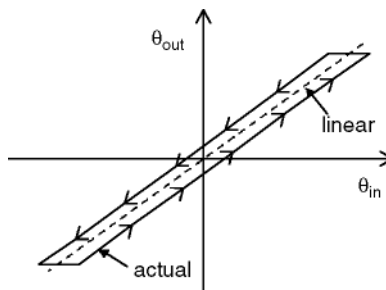

FIGURE 18.8 Gear backlash.

18.12 Saturation

All real actuators have some maximum output capability, regardless of the input. This violates the linearity assumption, since at some point the input command can be increased without significantly changing the output; see Fig. 18.9. This type of nonlinearity must be considered in mechatronic control system design, since maximum velocity and force or torque limitations affect system performance. Control systems modeled with linear system theory must be carefully tested or analyzed to determine the impact of saturation on system performance.

18.13 Deadband

Another nonlinear characteristic of some actuators and sensors is known as deadband. The deadband is typically a region of input close to zero at which the output remains zero. Once the input travels outside the deadband, then the output varies with input, as shown in Fig. 18.10. Analog joystick inputs frequently use a small amount of deadband to reduce the effect of noise from human inputs. A very small movement of the joystick produces no output, but the joystick acts normally with larger inputs.

Deadband is also commonly found in household thermostats and other process type controllers, as shown in Fig. 18.11. When a room warms and the temperature reaches the setpoint (or desired value)

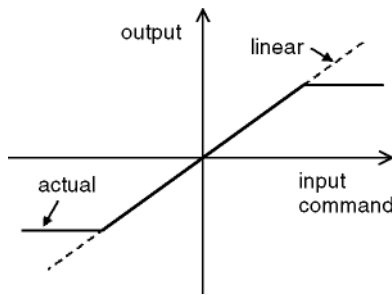

FIGURE 18.9 Saturation.

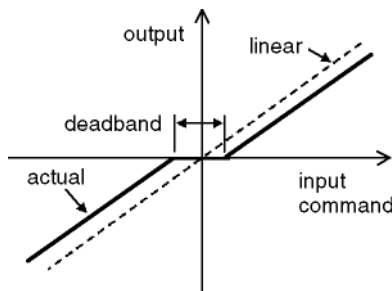

FIGURE 18.10 Deadband.

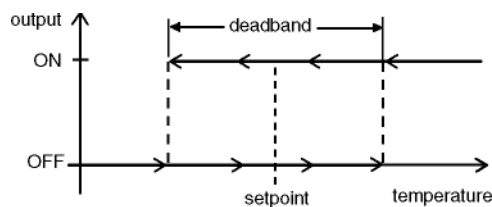

FIGURE 18.11 Thermostat deadband.

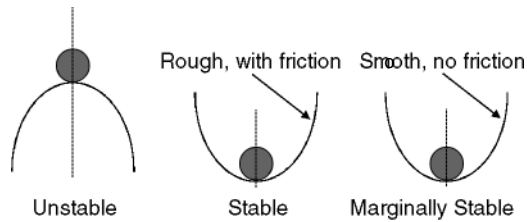

FIGURE 18.12 System stability.

on the thermostat, the output remains off. Once room temperature has increased to the setpoint plus half the deadband, then the cooling system output goes to fully on. As the room cools, the output stays fully on until the temperature reaches the setpoint minus half the deadband. At this point the cooling system output goes fully off.

18.14 System Response

Sensors and actuators respond to inputs that change with time. Any system that changes with time is considered a dynamic system. Understanding the response of dynamic systems to different types of inputs is important in mechatronic system design. The most important concept in system response is stability. The term stability has many different definitions and uses, but the most common definition is related to equilibrium. A system in equilibrium will remain in the same state in the absence of external disturbances. A stable system will return to an equilibrium state if a “small” disturbance moves the system away from the initial state. An unstable system will not return to an equilibrium position, and frequently will move “far” from the initial state.

Figure 18.12 illustrates three stability conditions with a simple ball and hill system. In each case an equilibrium position is easily identified—either the top of the hill or the bottom of the valley. In the unstable case, a small motion of the ball away from the equilibrium position will cause the ball to move “far” away, as it rolls down the hill. In the stable case, a small movement of the ball away from the equilibrium position will eventually result in the ball returning, perhaps after a few oscillations. In the third case, the absence of friction causes the ball to oscillate continuously about the equilibrium position once a small movement has occurred. This special case is often known as marginal stability, since the system never quite returns to the equilibrium position.

Most sensors and actuators are inherently stable. However, the addition of active control systems can cause a system of stable devices to exhibit overall unstable behavior. Careful analysis and testing is required to ensure that a mechatronic system acts in a stable manner. The complex response of stable dynamic systems is frequently approximated by much simpler systems. Understanding both first-order and second-order system responses to either instantaneous (or step) changes in inputs or sinusoidal inputs will suffice for most situations.

18.15 First-Order System Response

First-order systems contain two primary elements: an energy storing element and an element which dissipates (or removes) energy. Typical first-order systems include resistor–capacitor filters and resistor–inductor networks (e.g., a coil of a stepper motor). Thermocouples and thermistors also form first-order systems, due to thermal capacitance and resistance. The differential equation describing the time response of a generic first-order system is

$$\frac{dy(t)}{dt} + \frac{1}{\tau} y(t) = f(t)$$

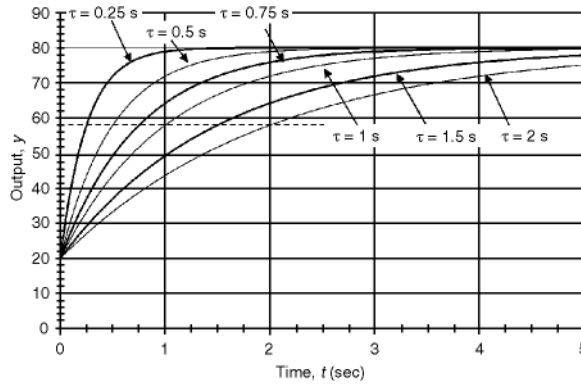

FIGURE 18.13 First-order system—step response.

where $y(t)$ is the dependent output variable (velocity, acceleration, temperature, voltage, etc.), t is the independent input variable (time), τ is the time constant (units of seconds), and $f(t)$ is the forcing function (or system input).

The solution to this equation for a step or constant input is given by

$$y(t) = y_{\infty} + (y_0 - y_{\infty})e^{-t/\tau}$$

where y_{∞} is the limiting or final (steady-state) value, y_0 is the initial value of the independent variable at $t = 0$.

A set of typical first-order system step responses is shown in Fig. 18.13. The initial value is arbitrarily selected as 20 with final values of 80. Time constants ranging from 0.25 to 2 s are shown. Each of these curves directly indicates its time constant at a key point on the curve. Substituting $t = \tau$ into the first-order response equation with $y_0 = 20$ and $y_{\infty} = 80$ gives

$$y(\tau) = 80 + (20 - 80)e^{-1} = 57.9$$

Each curve crosses the $y(\tau) \approx 57.9$ line when its time constant τ equals the time t . This concept is frequently used to experimentally determine time constants for first-order systems.

18.16 Underdamped Second-Order System Response

Second-order systems contain three primary elements: two energy storing elements and an element which dissipates (or removes) energy. The two energy storing elements must store different types of energy. A typical mechanical second-order system is the spring–mass–damper combination shown in Fig. 18.14. The spring stores potential energy ($PE = \frac{1}{2} kx^2$), while the mass stores kinetic energy ($KE = \frac{1}{2} mv^2$), where k is the spring stiffness (typical units of N/m), x is the spring deflection (typical units of m), m is the mass (typical units of kg), and v is the absolute velocity of the mass (typical units of m/s).

A common electrical second-order system is the resistor–inductor–capacitor (RLC) network, where the capacitor and inductor store electrical energy in two different forms. The generic form of the dynamic equation for an underdamped second-order system is

$$\frac{d^2y(t)}{dt^2} + 2\zeta\omega_n \frac{dy(t)}{dt} + \omega_n^2y(t) = f(t)$$

where $y(t)$ is the dependent variable (velocity, acceleration, temperature, voltage, etc.), t is the independent variable (time), ζ is the damping ratio (a dimensionless quantity), ω_n is the natural frequency (typical units of rad/s), and $f(t)$ is the forcing function (or input).

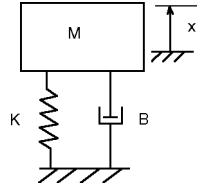

FIGURE 18.14 Spring–mass–damper system.

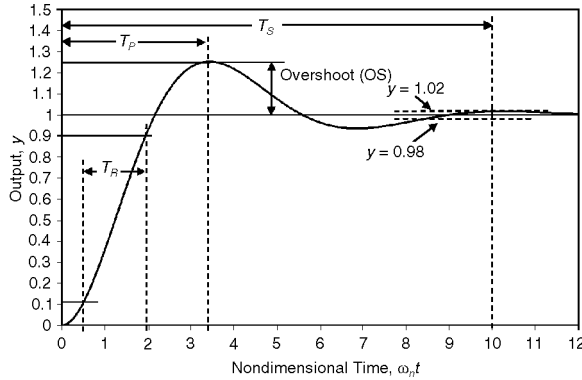

FIGURE 18.15 Second-order system—step response.

The response of an underdamped ($0 \leq \zeta < 1$) second-order system to a *unit* step input can be determined as:

$$y(t) = 1 - e^{-\zeta\omega_n t} \left(\cos \omega_n \sqrt{1 - \zeta^2} t + \frac{\zeta}{\sqrt{1 - \zeta^2}} \sin \omega_n \sqrt{1 - \zeta^2} t \right)$$

This second-order system step response is often characterized by a set of time response parameters illustrated in Fig. 18.15.

These time response parameters are functions of the damping ratio ζ and the natural frequency ω_n :

- peak time, T_p : the time required to reach the first (or maximum) peak

$$T_p = \frac{\pi}{\omega_n \sqrt{1 - \zeta^2}}$$

- percent overshoot, %OS: amount the response exceeds or overshoots the steady-state value

$$\%OS = 100e^{-(\zeta\pi/\sqrt{1 - \zeta^2})}$$

- settling time, T_s : the time when the system response remains within $\pm 2\%$ of the steady-state value

$$T_s = \frac{4}{\zeta\omega_n}$$

- rise time, T_R : time required for the response to go from 10% to 90% of the steady-state value. Figure 18.16 shows the nondimensional rise time ($\omega_n T_R$) as a function of damping ratio, ζ . A frequently used approximation relating these two parameters is

$$\omega_n T_R \approx 2.16\zeta + 0.6 \quad 0.3 \leq \zeta \leq 0.8$$

Figures 18.17 and 18.18 show the unit step response of a second-order system as a function of damping ratio ζ .

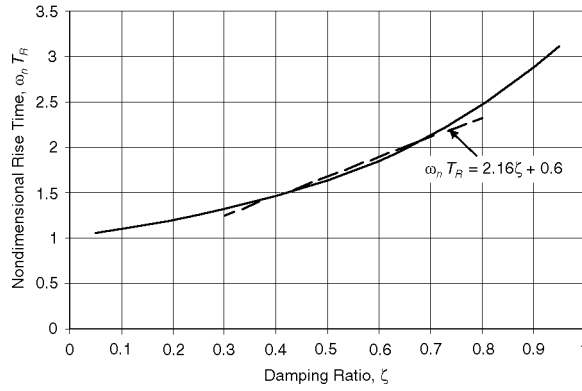

FIGURE 18.16 Rise time vs. damping ratio, ζ .

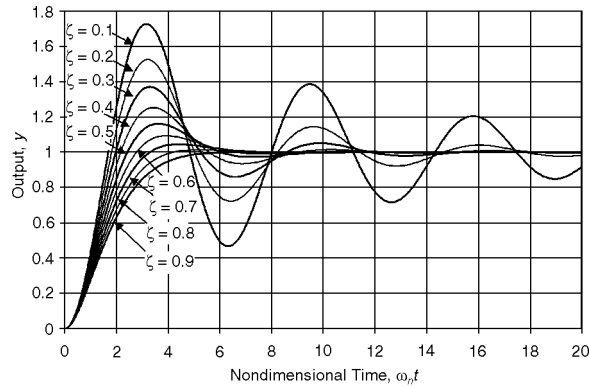

FIGURE 18.17 Second-order system step response vs. damping ratio, ζ .

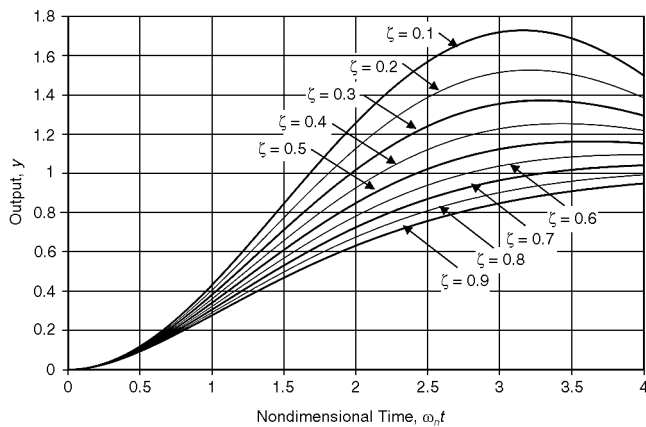

FIGURE 18.18 Initial second-order system step response vs. damping ratio, ζ .

18.17 Frequency Response

The response of any dynamic system to a sinusoidal input is called the frequency response. A generic first-order system with a sinusoidal input of amplitude A would have the dynamic equation of

$$\frac{dy(t)}{dt} + \frac{1}{\tau} y(t) = f(t) = A \sin(\omega t)$$

where ω is the frequency of the sinusoidal input and τ is the first-order time constant. The steady-state solution to this equation is

$$y(t) = AM \sin(\omega t + \Phi)$$

where $M = 1/\sqrt{(\tau\omega)^2 + 1}$ is the amplitude ratio (a dimensionless quantity), and $\Phi = -\tan^{-1}(\tau\omega)$ is the phase angle.

Figure 18.19 is a plot of the magnitude ratio M_{dB} and the phase angle Φ as a function of the non-dimensional frequency, $\tau\omega$. Note that the magnitude is frequently plotted in terms of decibels, where $M_{dB} = 20 \log_{10}(M)$.

The frequency at which the magnitude ratio equals 0.707 (or -3 dB) is called the bandwidth. For a first-order system, the bandwidth is inversely proportional to the time constant. So, $\omega = 1/\tau$.

A generic second-order system with a sinusoidal input of amplitude A and frequency ω would have the dynamic equation of

$$\frac{d^2 y(t)}{dt^2} + 2\zeta\omega_n \frac{dy(t)}{dt} + \omega_n^2 y(t) = A \sin(\omega t)$$

The steady-state solution to this equation is

$$y(t) = \frac{AM}{\omega_n^2} \sin(\omega t + \Phi)$$

where

$$M = \frac{1}{\sqrt{[1 - (\omega^2/\omega_n^2)]^2 + [2\zeta(\omega/\omega_n)]^2}}$$

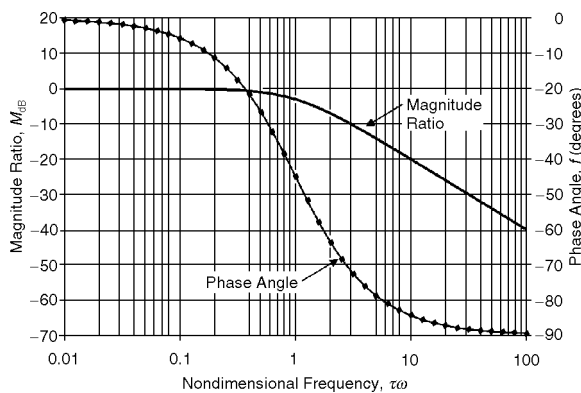

FIGURE 18.19 Frequency response for first-order system.

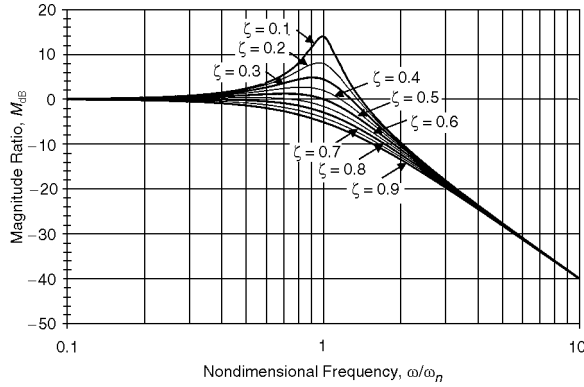

FIGURE 18.20 Frequency response magnitude for second-order system.

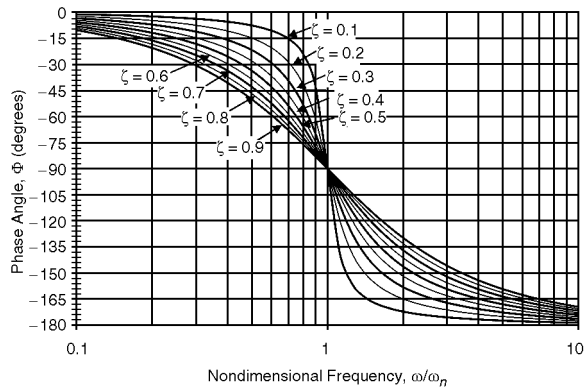

FIGURE 18.21 Frequency response phase angle for second-order system.

is the amplitude ratio (a dimensionless quantity), and

$$\Phi = -\tan^{-1} \left[\frac{2\zeta(\omega/\omega_n)}{1 - (\omega^2/\omega_n^2)} \right]$$

is the phase angle.

Figures 18.20 and 18.21 are plots of the magnitude response $M_{dB} = 20 \log_{10}(M)$ and the phase angle Φ for the second-order system as a function of damping ratio, ζ . The peak value in the magnitude response, M_p , can be found by taking the derivative of M with respect to ω and setting the result to zero to find (Nise, 1995)

$$M_p = \frac{1}{2\zeta\sqrt{1 - \zeta^2}}$$

This peak value in M occurs at the frequency ω_p given by

$$\omega_p = \omega_n \sqrt{1 - 2\zeta^2}$$

The peak value in an experimentally determined frequency response can be used to estimate both the natural frequency and damping ratio for a second-order system. These parameters can then be used to estimate time domain responses such as peak time and percent overshoot.

Reference

Nise, N. S., *Control Systems Engineering*, 2nd ed., Benjamin/Cummings, 1995.

19

Sensors

Kevin M. Lynch

Northwestern University

Michael A. Peshkin

Northwestern University

Halit Eren

Curtin University of Technology

M. A. Elbestawi

McMaster University

Ivan J. Garshelis

Magnova, Inc.

Richard Thorn

University of Derby

Pamela M. Norris

University of Virginia

Bouvard Hosticka

University of Virginia

Jorge Fernando Figueroa

NASA Stennis Space Center

H. R. (Bart) Everett

Space and Naval Warfare Systems Center

Stanley S. Ipson

University of Bradford

Chang Liu

University of Illinois

- 19.1 **Linear and Rotational Sensors**
 - Contact • Infrared • Resistive • Tilt (Gravity) • Capacitive • AC Inductive • DC Magnetic • Ultrasonic • Magnetostrictive Time-of-Flight • Laser Interferometry
- 19.2 **Acceleration Sensors**
 - Overview of Accelerometer Types • Dynamics and Characteristics of Accelerometers • Vibrations • Typical Error Sources and Error Modeling • Inertial Accelerometers • Electromechanical Accelerometers • Piezoelectric Accelerometers • Piezoresistive Accelerometers • Strain-Gauge Accelerometers • Electrostatic Accelerometers • Micro- and Nanoaccelerometers • Signal Conditioning and Biasing
- 19.3 **Force Measurement**
 - General Considerations • Hooke's Law • Force Sensors
- 19.4 **Torque and Power Measurement**
 - Fundamental Concepts • Arrangements of Apparatus for Torque and Power Measurement • Torque Transducer Technologies • Torque Transducer Construction, Operation, and Application • Apparatus for Power Measurement
- 19.5 **Flow Measurement**
 - Introduction • Terminology • Flow Characteristics • Flowmeter Classification • Differential Pressure Flowmeter • The Variable Area Flowmeter • The Positive Displacement Flowmeter • The Turbine Flowmeter • The Vortex Shedding Flowmeter • The Electromagnetic Flowmeter • The Ultrasonic Flowmeter • The Coriolis Flowmeter • Two-Phase Flow • Flowmeter Installation • Flowmeter Selection
- 19.6 **Temperature Measurements**
 - Introduction • Thermometers That Rely Upon Differential Expansion Coefficients • Thermometers That Rely Upon Phase Changes • Electrical Temperature Sensors and Transducers • Noncontact Thermometers • Microscale Temperature Measurements • Closing Comments
- 19.7 **Distance Measuring and Proximity Sensors**
 - Distance Measuring Sensors • Proximity Sensors
- 19.8 **Light Detection, Image, and Vision Systems**
 - Introduction • Basic Radiometry • Light Sources • Light Detectors • Image Formation • Image Sensors • Vision Systems
- 19.9 **Integrated Microsensors**
 - Introduction • Examples of Micro- and Nanosensors • Future Development Trends • Conclusions

19.1 Linear and Rotational Sensors

Kevin M. Lynch and Michael A. Peshkin

By far the most common motions in mechanical systems are linear translation along a fixed axis and angular rotation about a fixed axis. More complex motions are usually accomplished by composing these simpler motions. In this chapter we provide a summary of some of the many technologies available for sensing linear and rotational motion along a single axis. We have arranged the sensing modalities according to the physical effect exploited to provide the measurement.

Contact

The simplest kind of displacement sensor is a mechanical switch which returns one bit of information: touching or not touching. A typical *microswitch* consists of a lever which, when depressed, creates a mechanical contact within the switch, which closes an electrical connection (Fig. 19.1). Microswitches may be used as bump sensors for mobile robots, often by attaching a compliant material to the lever (such as a whisker) to protect the robot body from impact with a rigid obstacle. Another popular application of the microswitch in robotics is as a *limit switch*, indicating that a joint has reached the limit of its allowable travel.

Figure 19.2 shows a typical configuration for a microswitch. The pull-up resistor keeps the signal at +V until the switch closes, sending the signal to ground. As the switch closes, however, a series of micro-impacts may lead to “bounce” in the signal. A “debouncing” circuit may be necessary to clean up the output signal.

Switches may be designated NO or NC for normally open or normally closed, where “normally” indicates the unactivated or unpressed state of the switch. A switch may also have multiple *poles* (P) and one or two *throws* (T) for each pole. A pole moves as the switch is activated, and the throws are the possible contact points for the pole. Thus an SPDT (single pole double throw) switch switches a single pole from contact with one throw to the other, and a DPST (double pole single throw) switch switches two poles from open to closed circuit (Fig. 19.3).

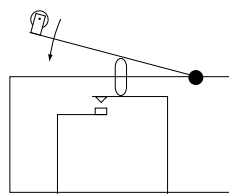

FIGURE 19.1 A typical microswitch.

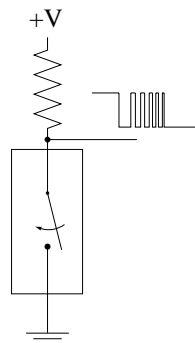

FIGURE 19.2 Signal bounce at a closing switch.

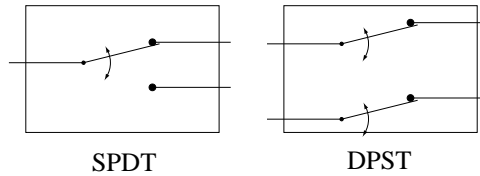

FIGURE 19.3 SPDT and DPST switch configurations.

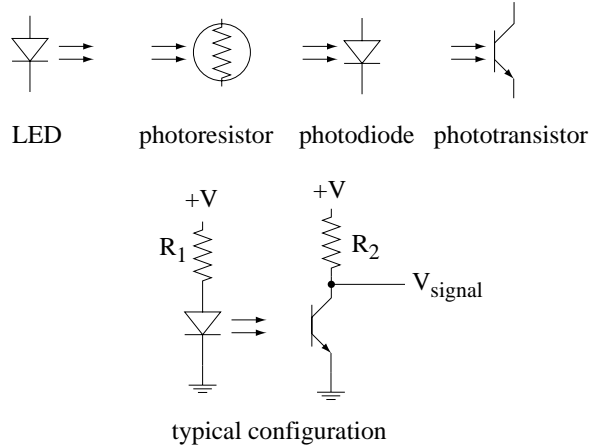

FIGURE 19.4 Optoelectronic circuit symbols and a typical emitter/detector configuration.

Infrared

Infrared light can be used in a variety of ways to measure linear and rotational displacement. Typically, an infrared light-emitting diode (LED), or *photoemitter*, is used as a source, and an infrared sensitive device is used to detect the emitted light. The detector could be a *photoresistor* or *photocell*, a variable resistor which changes resistance depending on the strength of the incident light (possibly infrared or visible); a *photodiode*, which allows the flow of electrical current in one direction in the presence of infrared light, and otherwise acts as an open circuit; or a *phototransistor*. In a phototransistor, the incident infrared light acts as the base current for the transistor, allowing the flow of collector current proportional to the strength of the received infrared light (up to saturation of the transistor). Circuit symbols for the various elements are shown in Fig. 19.4.

If the emitter and detector are facing each other, they can be used as a beam-breaker, to detect if something passes between. This is called a *photointerrupter* (Fig. 19.5). If the emitter and detector are free to move along the line connecting them, the strength of the received signal can be used to measure the distance separating them. Infrared photodetectors may be sensitive to ambient light, however. To distinguish the photoemitter light from background light, the source can be modulated (i.e., switched on and off at a high frequency), and the detector circuitry designed to respond only to the modulated infrared.

An emitter and detector facing the same direction can be used to roughly measure the distance to a nearby surface by the strength of the returned light reflecting off the surface. This is called a *photoreflector* (Fig. 19.6). Alternatively, such a sensor could be used to detect light absorbing or light reflecting surfaces at a constant distance, as in mobile robot line following. Light polarizing filters can also be used on the emitter and detector so that the detector only recognizes light reflected by a special “optically active” retroreflecting surface.

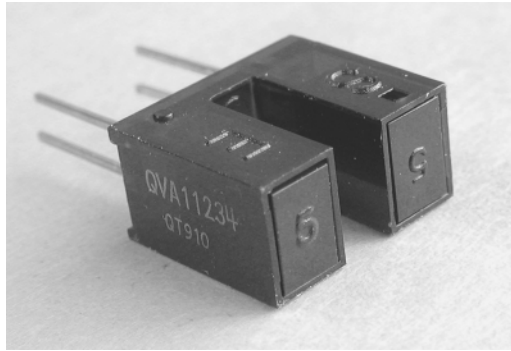

FIGURE 19.5 The Fairchild semiconductor QVA11234 photointerrupter.

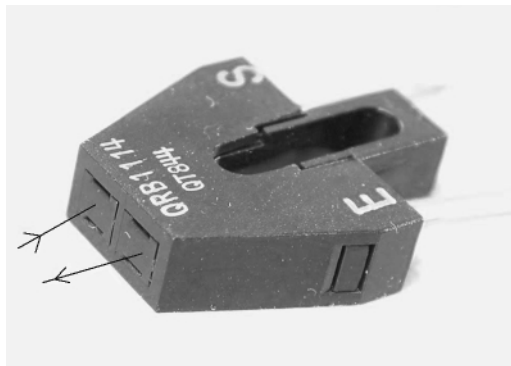

FIGURE 19.6 The Fairchild semiconductor QRB1114 photoreflexive sensor.

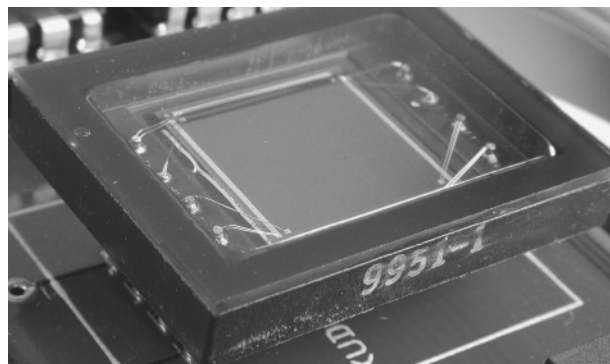

FIGURE 19.7 A position sensitive detector (PSD), UDT Sensors, Inc.

Photointerrupters and photoreflectors can be bought prepackaged or constructed separately from an infrared LED and a photodiode or phototransistor, after making certain the detector is sensitive to the wavelength produced by the LED.

Photoreflector units are also available with more advanced position sensitive detectors (PSDs), which report the location of infrared light incident on the sensing surface (Fig. 19.7). The fixed location of the LED relative to the PSD, as well as the location of the image of the infrared light on the PSD, allows the

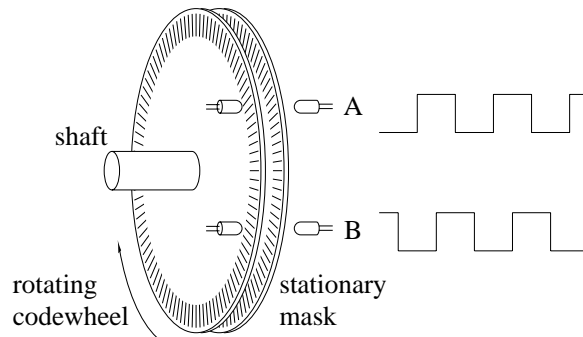

FIGURE 19.8 Schematic of an incremental encoder.

use of triangulation to determine the distance to the target. Such distance measuring sensors are manufactured by Sharp and Hamamatsu.

Optical Encoders

An optical encoder uses photointerrupters to convert motion into an electrical pulse train. These electrical pulses “encode” the motion, and the pulses are counted or “decoded” by circuitry to produce the displacement measurement. The motion may be either linear or rotational, but we focus on more common rotary optical encoders.

There are two basic configurations for rotary optical encoders, the *incremental* encoder and the *absolute* encoder. In an incremental encoder, a disk (or codewheel) attached to a rotating shaft spins between two photointerrupters (Fig. 19.8). The disk has a radial pattern of lines, deposited on a clear plastic or glass disk or cut out of an opaque disk, so that as the disk spins, the radial lines alternately pass and block the infrared light to the photodetectors. (Typically there is also a stationary mask, with the same pattern as the rotating codewheel, in the light path from the emitters to the detectors.) This results in pulse trains from each of the photodetectors at a frequency proportional to the angular velocity of the disk. These signals are labeled A and B, and they are 1/4 cycle out of phase with each other. The signals may come from photointerrupters aligned with two separate tracks of lines at different radii on the disk, or they may be generated by the same track, with the photointerrupters placed relative to each other to give out of phase pulse trains.

By counting the number of pulses and knowing the number of radial lines in the disk, the rotation of the shaft can be measured. The direction of rotation is determined by the phase relationship of the A and B pulse trains, i.e., which signal leads the other. For example, a rising edge of A while B = 1 may indicate counterclockwise rotation, while a rising edge of A while B = 0 indicates clockwise rotation. The two out-of-phase signals are known as quadrature signals.

Incremental encoders commonly have a third output signal called the index signal, labeled I or Z. The index signal is derived from a separate track yielding a single pulse per revolution of the disk, providing a home signal for absolute orientation. In practice, multiple photointerrupters can be replaced by a single source and a single array detecting device.

IC decoder chips are available to decode the pulse trains. The inputs to the chip are the A and B signals, and the outputs are one or more pulse trains to be fed into a counter chip. For example, the US Digital LS7083 outputs two pulse trains, one each for clockwise and counterclockwise rotation, which can be sent to the inputs of a 74193 counter chip (Fig. 19.9). Standard decoding methods for the quadrature input are 1X, 2X, and 4X resolution. In 1X resolution, a single count is generated for the rising or falling edge of just one of the pulse trains, so that the total number of encoder counts for a single revolution of the disk is equal to the number of lines in the disk. In 4X resolution, a count is generated for each rising and falling edge of both pulse trains, resulting in four times the angular resolution. An encoder

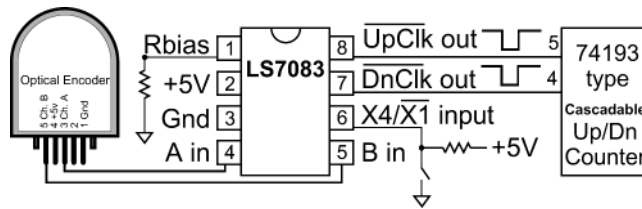

FIGURE 19.9 An optical encoder, US Digital LS7083 quadrature decoder chip, and counter (courtesy of US Digital, Inc.).

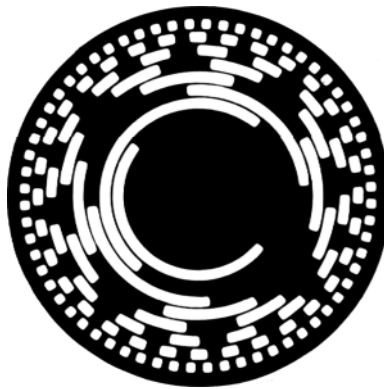

FIGURE 19.10 An 8-bit Gray code absolute encoder disk, courtesy of BEI Technologies Industrial Encoder Division.

with 1000 lines on the code wheel being decoded at 4X resolution yields an angular resolution of $360^\circ / (4 \times 1000) = 0.09^\circ$.

While a *single-ended output* encoder provides the signals A, B, and possibly Z, a *differential output* encoder also provides the complementary outputs A', B', and Z'. Differential outputs, when used with a differential receiver, can increase the electrical noise immunity of the encoder.

A drawback of the incremental encoder is that there is no way to know the absolute position of the shaft at power-up without rotating it until the index pulse is received. Also, if pulses are momentarily garbled due to electrical noise, the estimate of the shaft rotation is lost until the index pulse is received. A solution to these problems is the absolute encoder. An absolute encoder uses k photointerrupters and k code tracks to produce a k -bit binary word uniquely representing 2^k different orientations of the disk, giving an angular resolution of $360^\circ / 2^k$ (Fig. 19.10). Unlike an incremental encoder, an absolute encoder always reports the absolute angle of the encoder.

The radial patterns on the tracks are arranged so that as the encoder rotates in one direction, the binary word increments or decrements according to a binary code. Although natural binary code is a possibility, the Gray code is a more common solution. With natural binary code, incrementing by one may change many or all of the bits, e.g., 7 to 8 in decimal is 0111 to 1000 in natural binary. With the Gray code, only one bit changes as the number increments or decrements, e.g., 7 to 8 in decimal is 0100 to 1100 in Gray code. The rotational uncertainty during a Gray code transition is only a single count, or $360^\circ / 2^k$. With the natural binary code, an infinitesimal misalignment between the lines and the photointerrupters may cause the reading to briefly go from 0111 (7) to 1111 (15) during the transition to 1000 (8).

In general, incremental encoders provide higher resolution at a lower cost and are the most common choice for many industrial and robotic applications.

Resistive

One of the simplest and least expensive ways to measure rotational or linear motion is using a variable resistor called a *potentiometer* or *rheostat*. We focus on rotary potentiometers, or “pots” for short, but the principle of operation is the same in the linear case.

A pot consists of three terminals (Fig. 19.11(a,b)). Two end terminals, call them terminals 1 and 3, connect to either end of a length of resistive material, such as partially conductive plastic, ceramic, or a long thin wire. (For compactness, the long wire is wound around in loops to make a coil, leading to the name *wirewound* potentiometer.)

The other terminal, terminal 2, is connected to a *wiper*, which slides over the material as the pot shaft rotates. The total resistance of the pot R_{13} is equal to the sum of the resistance R_{12} between terminal 1 and the wiper, and the resistance R_{23} between the wiper and terminal 3. Typically the wiper can rotate from one end of the resistive material ($R_{13} = R_{12}$) to the other ($R_{13} = R_{23}$). If the full motion of the wiper is caused by one revolution of the shaft or less, the pot is called a *single-turn* pot. If the full motion is caused by multiple revolutions, it is called a *multi-turn* pot.

Typically a pot is used by connecting terminal 1 to a voltage V , terminal 3 to ground, and using the voltage at the wiper as a measure of the rotation. The voltage observed at the wiper is $V(R_{23}/R_{13})$ and is a linear function of the rotation of the shaft.

A remarkably simple absolute sensor for a wide range of distances is the string pot or draw-wire sensor (Fig. 19.12). It consists of a string wrapped on a spool, with a potentiometer to monitor rotations of the spool. A return spring keeps the string taut. Lengths up to many meters may be measured, using sensors incorporating multi-turn pots. The same technique is similarly useful for short distances (a few centimeters) using compact single-turn pots and a small spool. Both tolerate misalignment or arc-like motion well. String pots are susceptible to damage to the string in exposed applications, but the sensor element is small and unobtrusive. Manufacturers include RDP Electronics, SpaceAge Control, and UniMeasure.

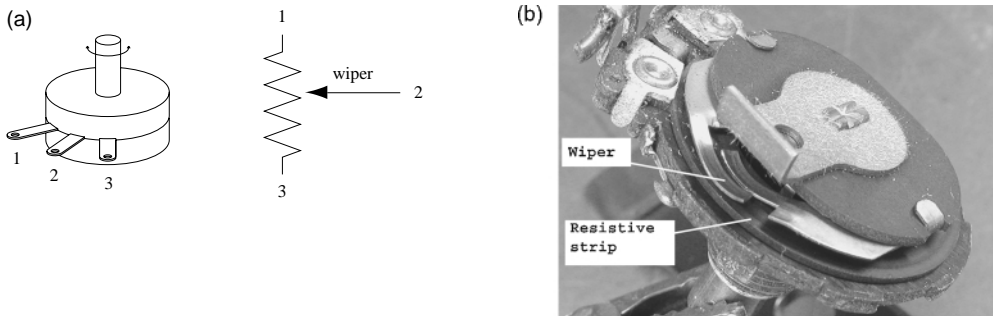

FIGURE 19.11 (a) As the shaft of the potentiometer rotates, the wiper moves from one end of the resistive material to the other. (b) The inside of a typical potentiometer, showing the wiper contacting a resistive strip.

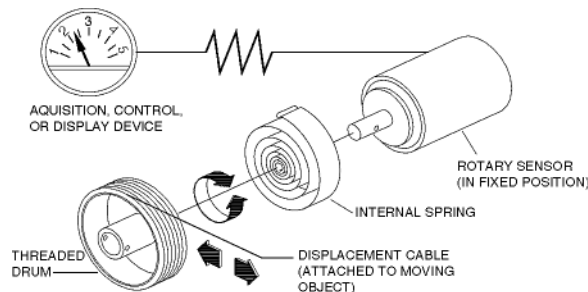

FIGURE 19.12 A string pot, courtesy of Space Age Control, Inc.

Another type of resistive sensor is the flexible bend sensor. Conductive ink between two electrical contacts on a flexible material changes resistance as the material bends and stretches. Used in a voltage divider with a fixed resistor, the analog voltage may be used as a measure of the bend. Such a sensor could be used to detect contact (like a whisker) or as a rough measure of the deformation of a surface to which it is attached.

Tilt (Gravity)

A *mercury switch* can be used to provide one bit of information about orientation relative to the gravity vector. A small drop of mercury enclosed in a glass bulb opens or closes the electrical connection between two leads depending on the orientation of the sensor. Several mercury switches at different orientations may be used to get a rough estimate of tilt. The signal from a mercury switch may “bounce” much like the signal from a mechanical contact switch (Fig. 19.2).

An *inclinometer* can be used to measure the amount of tilt. One example is the *electrolytic tilt sensor*. Manufacturers include The Fredericks Company and Spectron Glass. Two-axis models have five parallel rod-like electrodes in a sealed capsule, partially filled with a conductive liquid. Four of the electrodes are at the corners of a square, with one in the middle. Tilting the sensor changes the distribution of current injected via the center electrode in favor of the electrodes which are more deeply immersed.

Tilt sensors may be obtained with liquids of varying viscosity, to minimize sloshing. Because a DC current through the liquid would cause electrolysis and eventually destroy the sensor, AC measurements of conductivity are used. As a result, the support electronics are not trivial.

The liquid conductivity is highly temperature dependent. The support electronics for the tilt sensor must rely on a ratio of conductivity between pairs of rods. Also, although the electrolytic tilt sensor operates over a wide temperature range, it is greatly disturbed by nonuniformities of temperature across the cell.

Another kind of simple inclinometer can be constructed from a rotary potentiometer with a pendulum bob attached. A problem with this solution is that friction may stop the bob’s motion when it is not vertical. A related idea is to use an absolute optical encoder with a pendulum bob. Complete sensors operating on this principle can be purchased with advanced options, such as magnetic damping to reduce overshoot and oscillation. An example is US Digital’s 12-bit A2I absolute inclinometer.

Of course, gravity acting on a device is indistinguishable from acceleration. If the steady-state tilt of a device is the measurement of interest, simple signal conditioning should be used to ensure that the readings have settled.

Other more sophisticated tilt sensors include gyroscopes and microelectromechanical (MEMS) devices, which are not discussed here.

Capacitive

Capacitance can be used to measure proximity or linear motions on the order of millimeters. The capacitance C of a parallel plate capacitor is given by $C = \epsilon_r \epsilon_0 A/d$, where ϵ_r is the relative permittivity of the dielectric between the plates, ϵ_0 is the permittivity of free space, A is the area of overlap of the two plates, and d is the plate separation. As the plates translate in the direction normal to their planes, C is a nonlinear function of the distance d . As the plates translate relative to each other in their planes, C is a linear function of the area of overlap A . Used as proximity sensors, capacitive sensors can detect metallic or nonmetallic objects, liquids, or any object with a dielectric constant greater than air.

One common sensing configuration has one plate of the capacitor inside a probe, sealed in an insulator. The external target object forms the other plate of the capacitor, and it must be grounded to the proximity sensor ground. As the sensor approaches the target, the capacitance increases, modifying the oscillation of a detector circuit including the capacitor. This altered oscillation may be used to signal proximity or to obtain a distance measurement.

Manufacturers of capacitive sensors include Cutler-Hammer and RDP Electronics.

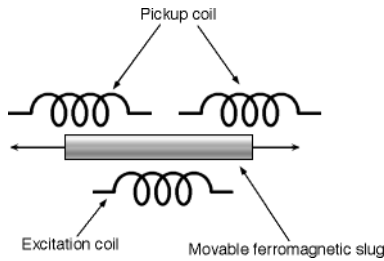

FIGURE 19.13 Operating principle of an LVDT.

AC Inductive

LVDT

The best known AC inductive sensor is the *linear variable differential transformer*, or LVDT. The LVDT is a tube with a plunger, the displacement of the plunger being the variable to be measured (Fig. 19.13). The tube is wrapped with at least two coils, an excitation coil and a pickup coil. An AC current (typically 1 kHz) is passed through the excitation coil, and an AC signal is detected from the pickup coil and compared in magnitude and in phase (0 or 180°) to the excitation current. Support electronics are needed for the demodulation, which is called synchronous detection. The plunger carries a ferromagnetic slug, which enhances the magnetic coupling from the excitation coil to the pickup coil. Depending on the position of the slug within the pickup coil, the detected signal may be zero (when the ferrite slug is centered in the pickup coil), or increasing in amplitude in one or the other phase, depending on displacement of the slug.

LVDTs are a highly evolved technology and can be very accurate, in some cases to the micron level. They have displacement ranges of millimeters up to a meter. They do not tolerate misalignment or nonlinear motion, as a string pot does.

Resolvers

A *resolver* provides a measure of shaft angle, typically with sine and cosine analog outputs. It uses an AC magnetic technique similar to the LVDT, and similar support electronics to provide synchronous detection. Resolvers are very rugged and for this reason are often preferred over optical encoders on motor shafts, although they are not as accurate and they have greater support electronics requirements. Some resolver drives have extra outputs as if they were incremental encoders, for compatibility. Additionally, resolvers provide an absolute measure of shaft angle. The resolver, like the LVDT, is a well established and evolved technology.

DC Magnetic

A magnetic field acting on moving electrons (e.g., a current in a semiconductor) produces a sideways force on the electrons, and this force can be detected as a voltage perpendicular to the current. The effect is small, even in semiconductors, but has become the basis of a class of very rugged, inexpensive, and versatile sensors.

Hall Effect Switches

Hall effect switches refers to devices which produce a binary output, depending on whether the magnetic field intensity exceeds a threshold or not. In their component form, these switches may be packaged as 3-terminal devices the size of a transistor package (TO-92) or surface mount, having only a power lead (3–24 V), a ground lead, and an output lead. Typically the output is pulled to ground, or not, depending on the magnetic state. Hall effect switches are also available in environmental packages of all sorts.

The actuation threshold ranges from a few gauss (the Earth's magnetic field is $1/2$ G) up to the hundreds of gauss levels typical of permanent magnets. Often there is a fair degree of unit-to-unit variability in threshold.

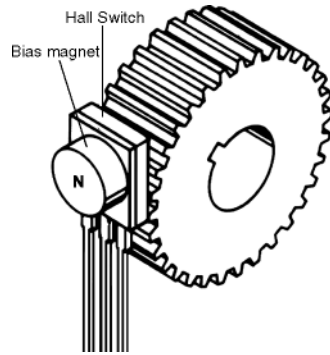

FIGURE 19.14 Detecting gear teeth in a ferrous material using a Hall switch and a bias magnet. Courtesy of Allegro Microsystems, Inc.

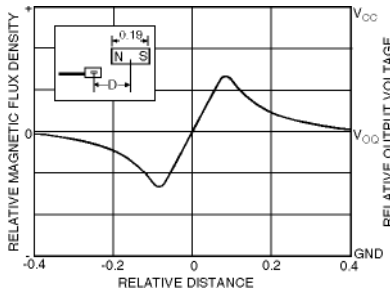

FIGURE 19.15 Output of an analog Hall sensor vs. position relative to a magnet. Courtesy of Allegro Microsystems, Inc.

Hall effect switches are hysteretic: their “turn-on” threshold may be different than the “turn-off” threshold. Sometimes hysteresis is used to make a switch latching, so that it stays in its last state (on or off) until the applied magnetic field is reversed. Non-latching Hall switches may be unipolar (responding only to one orientation of magnetic field) or bipolar (responding to a field of either polarity). Turn-on and turn-off times are in microseconds.

Hall switches have wide operating temperature ranges and are often used in automobile engine compartments. Another advantage is that they are not susceptible to most of the fouling mechanisms of optical or mechanical switches, such as liquids or dirt. While often the moving part that is detected is a magnet, it can also be arranged that a stationary “bias” magnet is intensified in its effect on the hall switch by the approach of a ferrous part, such as a gear tooth, thus allowing nonmagnetized objects to be detected (Fig. 19.14).

Typical applications are the detection of a moving part, replacing a mechanical limit switch. The Hall switch has no moving or exposed parts and is wear-free. Another common use is in indexing of rotational or translational motion. The Hall switch is installed to detect one position, and its output pulse is used as a reference for an incremental encoder which can count distance from that reference point. Hall switches are inexpensive and small, so a number of them can be spaced at intervals of millimeters, forming a low-resolution linear or rotational encoder or multi-position switch. Such an encoder or switch has the ruggedness advantages of Hall switches.

Analog Hall Sensors

In a package the same small size as Hall switches, and costing little more, one can also get Hall devices that have an analog output proportional to magnetic field strength (Fig. 19.15). Typically, these have full-scale magnetic field sensitivity in the 100 G range. These are not useful as a compass in the Earth’s sub-gauss magnetic field.

Hall sensors are useful as linear or rotational encoders. Two Hall sensors may be arranged at right angles to detect the sine and cosine of the angle of a rotating magnet, thus forming an absolute rotation sensor.

Commercially available devices of this nature are called “Hall potentiometers” and have a variety of outputs (e.g., sine and cosine, or a linear ramp repeating with each revolution). In contrast to potentiometers with resistive strips and sliders, Hall pots allow continuous 360° rotation and experience no wear. All Hall effect devices are susceptible to external magnetic fields, however.

Hall sensors are also excellent transducers of short linear or arc-like motions. The motion of a bar magnet past a Hall sensor exposes the sensor to a magnetic field—which can be arranged to vary linearly with displacement—over a range of several millimeters up to several centimeters. (The bar magnet travels less than its own length.) Commercial implementations are known as throttle position sensors.

Tape-Based Sensors

There are a number of linear and rotational sensors, both incremental and absolute, which are similar to optical encoders but use magnetic patterns rather than optical ones. Linear applications are likely to require an exposed strip. In exposed applications, magnetic sensors have advantages in resistance to dirt, although the magnetic stripes must be protected from damage.

Ultrasonic

Ultrasonic (US) sensors use the time-of-flight of a pulse of ultrasonic sound through air or liquid to measure distance. Sensors are available with ranges from a few centimeters to 10 m. A great advantage of US sensors is that all of the sensor’s electronic and transducer components are in one location, out of harm’s way. The corresponding disadvantages are that US sensors tend to be indiscriminate: they may detect spurious targets, even very small ones, especially if these are near the transducer. Sensors are available with carefully shaped beams (down to 7°) to minimize detection of spurious targets. Some include compensation for variation in air temperature, which affects sound velocity. US sensors can be used in surprising geometries. For instance, they can be used to detect the liquid level in a vertical pipe; back-reflection of sound pulses from the walls of a smooth pipe are minimal.

There is also an inexpensive and easily interfaced US sensor from Polaroid, derived from a ranging device for an instant camera, which is popular with experimenters.

Ultrasonic sensors typically have an analog output proportional to distance to target. Accuracies of the 1% level can be expected in a well-controlled environment.

Magnetostrictive Time-of-Flight

A more accurate technique for using time-of-flight to infer distance is the *magnetostrictive wire transducer* (MTS). A moving magnet forms the “target” corresponding to the acoustic target in US sensors, and need not touch the magnetostrictive wire which is the heart of the device. The magnet’s field acting on the magnetostrictive wire creates an ultrasonic pulse in the wire when a current pulse is passed through the wire. The time interval from the current pulse to the detection of the ultrasonic pulse at the end of the wire is used to determine the position of the magnet along the wire (Fig. 19.16).

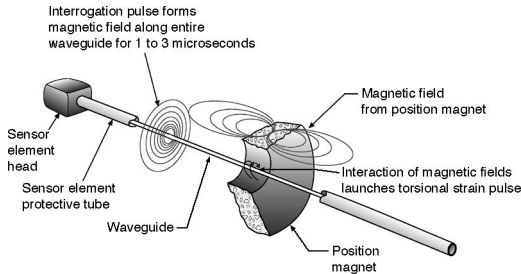

FIGURE 19.16 Principle of operation of a magnetostrictive linear position sensor, courtesy of Temposonics, Inc.

The magnetostrictive transducer does not have the inherent compactness and ruggedness of ultrasonic through air, but does achieve similarly large measurement lengths, up to several meters. Accuracy and stability are excellent, far better than ultrasonic. Some misalignment or nonlinear motion is tolerated, because the target magnet does not need to be in very close proximity to the magnetostrictive wire.

Laser Interferometry

Laser interferometers are capable of measuring incremental linear motions with resolution on the order of nanometers. In an interferometer, collimated laser light passes through a beam-splitter, sending the light energy on two different paths. One path is directly reflected to the detector, such as an optical sensing array, giving a flight path of fixed length. The other path reflects back to the detector from a retroreflector (mirror) attached to the target to be measured. The two beams constructively or destructively interfere with each other at the detector, creating a pattern of light and dark fringes. The interference pattern can be interpreted to find the phase relationship between the two beams, which depends on the relative lengths of the two paths, and therefore the distance to the moving target. As the target moves, the pattern repeats when the length of the variable path changes by the wavelength of the laser. Thus the laser interferometer is inherently an incremental measuring device.

Laser interferometers are easily the most expensive sensors discussed in this chapter. They also have the highest resolution. Laser interferometers are very sensitive to mechanical misalignment and vibrations.

More information about sensors may be found in Sensors magazine (<http://www.sensorsmag.com/>).

References

1. Hystand, M. B. and Alciatore, D. G., *Introduction to Mechatronics and Measurement Systems*, McGraw-Hill, Boston, MA, 1999.
2. Bolton, W., *Mechatronics*, 2nd edition, Addison Wesley Longman, New York, NY, 1999.
3. Horowitz, P. and Hill, W., *The Art of Electronics*, 2nd edition, Cambridge University Press, Cambridge, UK, 1998.
4. Auslander, D. M. and Kempf, C. J., *Mechatronics: Mechanical System Interfacing*, Prentice-Hall, Upper Saddle River, NJ, 1996.
5. Jones, J. L., Flynn, A. M., and Seiger, B. A., *Mobile Robots: Inspiration to Implementation*, 2nd edition, A. K. Peters, Boston, MA, 1999.

19.2 Acceleration Sensors

Halit Eren

Acceleration relating to motion is an important section of kinematic quantities: position, velocity, acceleration, and jerk. Each one of these quantities has a linear relationship with the neighboring ones. That is, all the kinematic quantities can be derived from a single quantity. For example, acceleration can be obtained by differentiating the corresponding velocity or by integrating the jerk. Likewise, velocity can be obtained by differentiating the position or by integrating the acceleration. In practice, only integration is widely used since it provides better noise characteristics and attenuation.

There are two classes of acceleration measurements techniques: *direct* measurements by specific accelerometers and *indirect* measurements where velocity is differentiated. The applicability of these techniques depends on the type of motion (rectilinear, angular, or curvilinear motion) or equilibrium centered vibration. For rectilinear and curvilinear motions, the direct measurement accelerometers are preferred. However, the angular acceleration is usually measured by indirect methods.

Acceleration is an important parameter for general-purpose absolute motion measurements, vibration, and shock sensing. For these measurements, accelerometers are commercially available in a wide range and many different types to meet diverse application requirements, mainly in three areas: (1) *Commercial applications*—automobiles, ships, appliances, sports and other hobbies; (2) *Industrial applications*—robotics, machine control, vibration testing and instrumentation; and (3) *High reliability applications*—military, space and aerospace, seismic monitoring, tilt, vibration and shock measurements.

Accelerometers have been in use for many years. Early accelerometers were mechanical types relying on analog electronics. Although early accelerometers still find many applications, modern accelerometers are essentially semiconductor devices within electronic chips integrated with the signal processing circuitry. Mechanical accelerometers detect the force imposed on a mass when acceleration occurs. A new type of accelerometer, the thermal type, senses the position through heat transfer.

Overview of Accelerometer Types

A basic accelerometer consists of a mass that is free to move along a sensitive axis within a case. The technology is largely based on this basic accelerometer and can be classified in a number of ways, such as mechanical or electrical, active or passive, deflection or null-balance accelerometers, etc. The majority of industrial accelerometers are classified as either deflection or null-balance types. Accelerometers used in vibration and shock measurements are usually the deflection types, whereas those used for the measurement of motions of vehicles, aircraft, and so on for navigation purposes may be either deflection or null-balance type.

This article will concentrate on the direct measurements of acceleration, which can be achieved by the accelerometers of the following types:

- Inertial and mechanical
- Electromechanical
- Piezoelectric
- Piezoresistive
- Strain gauges
- Capacitive and electrostatic force balance
- Micro- and nanoaccelerometers

Depending on the principles of operations, these accelerometers have their own subclasses.

Dynamics and Characteristics of Accelerometers

Acceleration is related to motion, a vector quantity, exhibiting a direction as well as magnitude. The direction of motion is described in terms of some arbitrary Cartesian or orthogonal coordinate systems. Typical rectilinear, angular, and curvilinear motions are illustrated in Figs. 19.17(a–c), respectively.

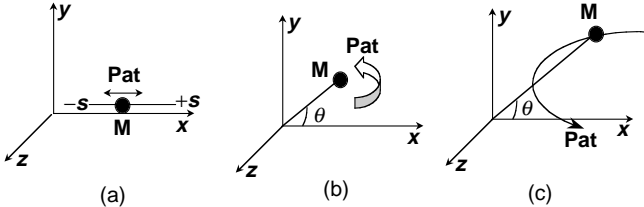

FIGURE 19.17 Types of motions to which accelerometers are commonly applied.

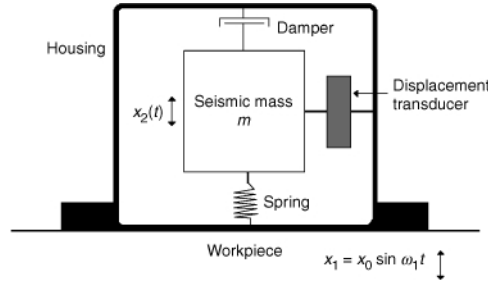

FIGURE 19.18 A typical seismic accelerometer.

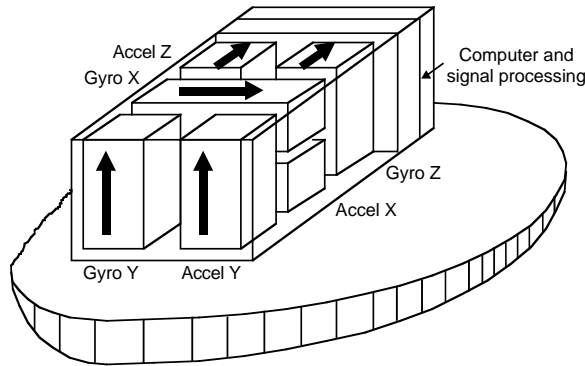

FIGURE 19.19 Arrangements of accelerometers in navigation and guidance systems.

The governing equations of these motions are as follows:

$$\text{Rectilinear acceleration } a = \lim_{\Delta t \rightarrow 0} \frac{\Delta v}{\Delta t} = \frac{dv}{dt} = \frac{d(ds/dt)}{dt} = \frac{d^2s}{dt^2} \quad (19.1)$$

$$\text{Angular acceleration } \alpha = \lim_{\Delta t \rightarrow 0} \frac{\Delta \omega}{\Delta t} = \frac{d\omega}{dt} = \frac{d(d\alpha/dt)}{dt} = \frac{d^2\alpha}{dt^2} \quad (19.2)$$

$$\text{Curvilinear acceleration } a = \frac{dv}{dt} = \frac{d^2x}{dt^2} i + \frac{d^2y}{dt^2} j + \frac{d^2z}{dt^2} k \quad (19.3)$$

where a and α are the accelerations; v and ω are the speeds; s is the distance; θ is the angle; i , j , and k are the unit vectors in x , y , and z directions, respectively.

For the correct applications of the accelerometers, a sound understanding of the characteristics of the motion under investigation is very important. The application areas may be linear and vibratory motion, angular motion, monitoring of the tilt of an object, or various forms of combinations. In each case, the correct selection and mounting of the accelerometer is necessary.

The majority of accelerometers can be viewed and analyzed as a single-degree-of-freedom seismic instrument that can be characterized by a mass, a spring, and a damper arrangement as shown in Fig. 19.18. In the case of multi-degrees-of-freedom systems, the principles of curvilinear motion can be applied as in Eq. (19.3) and multiple transducers must be used to create uniaxial, biaxial, or triaxial sensing points of the measurements. A typical example is the inertial navigation and guidance systems as illustrated in Fig. 19.19. In such applications, acceleration sensors play an important role in orientation and direction finding. Usually, miniature triaxial sensors detect changes in roll, pitch, and azimuth in x , y , and z directions.

If a single-degree-of-freedom system behaves linearly in a time invariant manner, the basic second-order differential equation describing the motion of the forced mass-spring system can be written as

$$f(t) = m \frac{d^2 x}{dt^2} + c \frac{dx}{dt} + kx \quad (19.4)$$

where $f(t)$ is the force, m is the mass, c is the velocity constant, and k is the spring constant.

Nevertheless, the base of the accelerometer is in motion too. When the base is in motion, the force is transmitted through the spring to the suspended mass, depending on the transmissibility of the force to the mass. Equation (19.4) may be generalized by taking the effect motion of the base into account as

$$m \frac{d^2 z}{dt^2} + c \frac{dz}{dt} + kz = mg \cos \alpha - m \frac{d^2 x_1}{dt^2} \quad (19.5)$$

where $z = x_2 - x_1$ is the relative motion between the mass and the base, x_1 is the displacement of the base, x_2 is the displacement of mass, and θ is the angle between the sense axis and gravity.

The complete solution to Eq. (19.5) can be obtained by applying the superposition principle. The superposition principle states that if there are simultaneously superimposed actions on a body, the total effect can be obtained by summing the effects of each individual action. Using superposition and using Laplace transforms gives

$$\frac{X(s)}{F(s)} = \frac{1}{ms^2 + cs + k} \quad (19.6)$$

or

$$\frac{X(s)}{F(s)} = \frac{K}{s^2/\omega_n^2 + 2\zeta s/\omega_n + 1} \quad (19.7)$$

where s is the Laplace operator, $K = 1/k$ is the static sensitivity, $\omega_n = \sqrt{k/m}$ is the undamped critical frequency (rad/s), and $\zeta = (c/2)\sqrt{k/m}$ is the damping ratio.

As can be seen in the performance of accelerometers, the important parameters are the static sensitivity, the natural frequency, and the damping ratio, which are all functions of mass, velocity, and spring constants. Accelerometers are designed and manufactured to have different characteristics by suitable selection of these parameters. A short list of major manufacturers is given in [Table 19.1](#).

Vibrations

This section is concerned with applications of accelerometers to measure physical properties such as acceleration, vibration and shock, and the motion in general. Although there may be fundamental differences in the types of motions, a sound understanding of the basic principles of the vibration will lead to the applications of accelerometers in different situations by making appropriate corrective measures.

Vibration is an oscillatory motion resulting from application of varying forces to a structure. The vibrations can be periodic, stationary random, nonstationary random, or transient.

Periodic Vibrations

In periodic vibrations, the motion of an object repeats itself in an oscillatory manner. This can be represented by a sinusoidal waveform

$$x(t) = X_p \sin(\omega t) \quad (19.8)$$

TABLE 19.1 List of Manufacturers

| | |
|---|--|
| Analog Devices, Inc. 1 Technology Way, P.O. Box 9106 Norwood, MA 02062-9106 USA Tel: 781-329-4700 Fax: 781-326-8703 | Kistler Instrument Corp. 75 John Glenn Dr. Amherst, NY 14228 2119 USA Tel: 888-KISTLER (547-8537) Fax: 716-691-5226 |
| Aydin Telemetry 47 Friends Lane & Penns Trail Newtown, PA 18940 0328 USA Tel: 215-968-4271 Fax: 215-968-3214 | Oceana Sensor Technologies, Inc. 1632-T Corporate Landing Pkwy. Virginia Beach, VA 23454 USA Tel: 757-426-3678 Fax: 757-426-3633 |
| Bruel & Kjaer 2815-A Colonnades Court Norcross, GA 30071 USA Tel: 800-332-2040 Fax: 770-447-8440 | PCB Piezotronics, Inc. 3425-T Walden Ave. Depew, NY 14043 2495 USA Tel: 716-684-0001 Fax: 716-684-0987 |
| Dytran Instruments, Inc. 21592 Marilla St. Chatsworth, CA 91311 USA Tel: 800-899-7818 Fax: 800-899-7088 | Piezo Systems, Inc. 186 Massachusetts Ave. Cambridge, MA 02139-4229 USA Tel: 617-547-1777 Fax: 617-354-2200 |
| Endevco Corp. 30700 Rancho Viejo Rd. San Juan Capistrano, CA 92675 USA Tel: 800-982-6732 Fax: 949-661-7231 | Rieker Instrument Co. P.O. Box 128 Folcroft, PA 19032 0128 USA Tel: 610-534-9000 Fax: 610-534-4670 |
| Entran Devices, Inc. 10-T Washington Ave. Fairfield, NJ 07004 USA Tel: 888-8-ENTRAN (836-8726) Fax: 973-227-6865 | Sensotec, Inc. 2080 Arlingate Lane Columbus, OH 43228 USA Tel: 800-858-6184 Fax: 614-850-1111 |
| GS Sensors, Inc. 16 W. Chestnut St. Ephrata, PA 17522 USA Tel: 717-721-9727 Fax: 717-721-9859 | Techkor Instrumentation 2001 Fulling Mill Rd. P.O. Box 70 Dept. T-1 New Cumberland, PA 17057-0070 USA Tel: 800-697-4567 Fax: 717-939-7170 |

where $x(t)$ is the time-dependent displacement, $\omega = 2\pi ft$ is the angular frequency, and X_p is the maximum displacement from a reference point.

The velocity of the object is the time rate of change of displacement,

$$v(t) = \frac{dx}{dt} = \omega X_p \cos(\omega t) = V_p \sin(\omega t + \pi/2) \quad (19.9)$$

where $v(t)$ is the time-dependent velocity, and $V_p = \omega X_p$ is the maximum velocity.

The acceleration of the object is the time rate of change of velocity,

$$a(t) = \frac{dv}{dt} = \frac{d^2x}{dt^2} = -\omega^2 X_p \sin(\omega t) = A_p \sin(\omega t + \pi) \quad (19.10)$$

where $a(t)$ is the time-dependent acceleration, and $A_p = \omega^2 X_p = \omega V_p$ is the maximum acceleration.

From the preceding equations it can be seen that the basic form and the period of vibration remains the same in acceleration, velocity, and displacement. But velocity leads displacement by a phase angle of 90° and acceleration leads velocity by another 90° .

In nature, vibrations can be periodic, but not necessarily sinusoidal. If they are periodic but nonsinusoidal, they can be expressed as a combination of a number of pure sinusoidal curves, determined by Fourier analysis as

$$x(t) = X_0 + X_1 \sin(\omega_1 t + \Phi_1) + X_2 \sin(\omega_2 t + \Phi_2) + \dots + X_n \sin(\omega_n t + \Phi_n) \quad (19.11)$$

where $\omega_1, \omega_2, \dots, \omega_n$ are the frequencies (rad/s), X_0, X_1, \dots, X_n are the maximum amplitudes of respective frequencies, and $\phi_1, \phi_2, \dots, \phi_n$ are the phase angles.

The number of terms may be infinite, and the higher the number of elements, the better the approximation. These elements constitute the frequency spectrum. The vibrations can be represented in the time domain or frequency domain, both of which are extremely useful in analysis.

Stationary Random Vibrations

Random vibrations are often met in nature, where they constitute irregular cycles of motion that never repeat themselves exactly. Theoretically, an infinitely long time record is necessary to obtain a complete description of these vibrations. However, statistical methods and probability theory can be used for the analysis by taking representative samples. Mathematical tools such as probability distributions, probability densities, frequency spectra, cross-correlations, auto-correlations, digital Fourier transforms (DFTs), fast Fourier transforms (FFTs), auto-spectral-analysis, root mean squared (rms) values, and digital filter analysis are some of the techniques that can be employed.

Nonstationary Random Vibrations

In this case, the statistical properties of vibrations vary in time. Methods such as time averaging and other statistical techniques can be employed.

Transients and Shocks

Often, short duration and sudden occurrence vibrations need to be measured. Shock and transient vibrations may be described in terms of force, acceleration, velocity, or displacement. As in the case of random transients and shocks, statistical methods and Fourier transforms are used in the analysis.

Typical Error Sources and Error Modeling

Acceleration measurement errors occur due to four primary reasons: sensors, acquisition electronics, signal processing, and application specific errors. In the direct acceleration measurements, the main error sources are the sensors and data acquisition electronics. These errors will be discussed in the biasing section and in some cases, sensor and acquisition electronic errors may be as high as 5%. Apart from these errors, sampling and A/D converters introduce the usual errors, which are inherent in them and exist in all computerized data acquisition systems. However, the errors may be minimized by the careful selection of multiplexers, sample-and-hold circuits, and A/D converters.

When direct measurements are made, ultimate care must be exercised for the selection of the correct accelerometer to meet the requirements of a particular application. In order to reduce the errors, once the characteristics of the motion are studied, the following particulars of the accelerometers need to be considered: the transient response or cross-axis sensitivity; frequency range; sensitivity, mass and dynamic range; cross-axis response; and environmental conditions, such as temperature, cable noise, stability of bias, scale factor, and misalignment, etc.

Sensitivity of Accelerometers

During measurements, the transverse motions of the system affect most accelerometers and the sensitivity to these motions plays a major role in the accuracy of the measurement. The transverse, also known as cross-axis, sensitivity of an accelerometer is its response to acceleration in a plane perpendicular to the

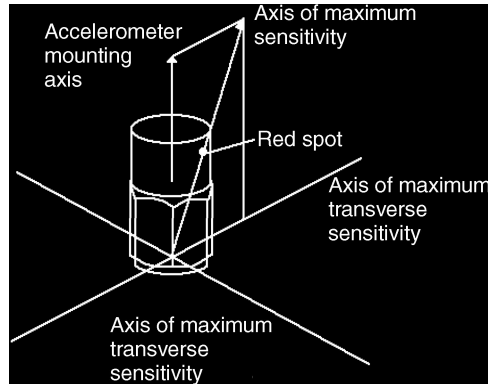

FIGURE 19.20 Illustration of cross-axis sensitivity.

main accelerometer axis as shown in Fig. 19.20. The cross-axis sensitivity is normally expressed as a percentage of the main-axis sensitivity and should be as low as possible. The manufacturers usually supply the direction of minimum sensitivity.

The measurement of the maximum cross-axis sensitivity is part of the individual calibration process and should always be less than 3% or 4%. If high levels of transverse vibration are present, this may result in erroneous overall results. In this case, separate arrangements should be made to establish the level and frequency contents of the cross-axis motions. The cross-axis sensitivity of typical accelerometers mentioned in the relevant sections were 2–3% for piezoelectric types and less than 1% for most others.

The Frequency Range

Acceleration measurements are normally confined to using the linear portion of the response curve of the accelerometer. The response is limited at the low frequencies as well as at the high frequencies by the natural resonances. As a rule of thumb, the upper-frequency limit for the measurement can be set to one-third of the accelerometer’s resonance frequency such that the vibrations measured will be less than 1 dB in linearity. It should be noted that an accelerometer’s useful frequency range may be significantly higher; that is, one-half or two-thirds of its resonant frequency. The measurement frequencies may be set to higher values in applications in which lower linearity (say 3 dB) is acceptable. The lower measuring frequency limit is determined by two factors. The first is the low-frequency cutoff of the associated preamplifiers. The second is the effect of ambient temperature fluctuations to which the accelerometer may be sensitive.

The Mass of Accelerometer and Dynamic Range

Ideally, the higher the transducer sensitivity, the better. Compromises may have to be made for sensitivity versus frequency, range, overload capacity, size, and so on.

In some cases, high errors will be introduced due to wrong selection of the sensor that is suitable for a specific application. For example, accelerometer mass becomes important when using small and light test objects. The accelerometer should not load the structural member, since additional mass can significantly change the levels and frequency presence at measuring points and invalidate the results. As a general rule, the accelerometer mass should not be greater than one-tenth the effective mass of the part or the structure that it is mounted onto for measurements.

The dynamic range of the accelerometer should match the high or low acceleration levels of the measured objects. General-purpose accelerometers can be linear from 5000g to 10,000g, which is well in the range of most mechanical shocks. Special accelerometers can measure up to 100,000g.

The Transient Response

Shocks are characterized as sudden releases of energy in the form of short-duration pulses exhibiting various shapes and rise times. They have high magnitudes and wide frequency contents. In applications where transient and shock measurements are involved, the overall linearity of the measuring system may be limited to high and low frequencies by a phenomena known as *zero shift* and *ringing*, respectively. The zero shift is caused by both the phase nonlinearity in the preamplifiers and the accelerometer not returning to steady-state operation conditions after being subjected to high shocks. Ringing is caused by high-frequency components of the excitation near-resonance frequency, preventing the accelerometer from returning back to its steady-state operation condition. To avoid measuring errors due to these effects, the operational frequency of the measuring system should be limited to the linear range.

Full Scale Range and Overload Capability

Most accelerometers are able to measure acceleration in both positive and negative directions. They are also designed to be able to accommodate overload capacity. Manufacturers also supply information on these two characteristics.

Environmental Conditions

In selection and implementation of accelerometers, environmental conditions such as temperature ranges, temperature transients, cable noise, magnetic field effects, humidity, and acoustic noise need to be considered. Manufacturers supply information on environmental conditions.

Inertial Accelerometers

Inertial accelerometers are mechanical accelerometers that make use of a seismic mass that is suspended by a spring or a lever inside a rigid frame as shown in Fig. 19.17. The frame carrying the seismic mass is connected firmly to the vibrating source whose characteristics are to be measured. As the system vibrates, the mass tends to remain fixed in its position so that the motion can be registered as a relative displacement between the mass and the frame. An appropriate transducer senses this displacement and the output signal is processed further. The displacement sensing element can be made from a variety of materials exhibiting resistive, capacitive, inductive, piezoelectric, piezoresistive, and optical capabilities. In practice, the seismic mass does not remain absolutely steady, but it can satisfactorily act as a reference position for selected frequencies.

By proper selection of mass, spring, and damper combinations, the seismic instrument may be used for either acceleration or displacement measurements. In general, a large mass and soft spring are suitable for vibration and displacement measurement, while a relatively small mass and a stiff spring are used in accelerometers. However, the term seismic is commonly applied to instruments, which sense very low levels of vibration in the ground or structures.

In order to describe the response of the seismic accelerometer in Fig. 19.17, Newton's second law, the equation of motion, may be written as

$$m \frac{d^2 x_2}{dt^2} + c \frac{dx_2}{dt} + kx_2 = c \frac{dx_1}{dt} + kx_1 + mg \cos(\theta) \quad (19.12)$$

where x_1 is the displacement of the vibration frame, x_2 is the displacement of the seismic mass, c is the velocity constant, θ is the angle between the sense axis and gravity, and k is the spring constant.

Taking $m d^2 x_1 / dt^2$ from both sides of the equation and rearranging gives

$$m \frac{d^2 z}{dt^2} + c \frac{dz}{dt} + kz = mg \cos(\theta) - m \frac{d^2 x_1}{dt^2} \quad (19.13)$$

where $z = x_2 - x_1$ is the relative motion between the mass and the base.

In Eq. (19.12), it is assumed that the damping force on the seismic mass is proportional to velocity only. If a harmonic vibratory motion is impressed on the instrument such that

$$x_1(t) = X_0 \sin(\omega_1 t) \quad (19.14)$$

where ω_1 is the frequency of vibration (rad/s), writing

$$-m \frac{d^2 x_1}{dt^2} = m X_0 \sin \omega_1 t$$

modifies Eq. (19.13) as

$$m \frac{d^2 z}{dt^2} + c \frac{dz}{dt} + kz = mg \cos(\theta) + m a_1 \sin \omega_1 t \quad (19.15)$$

where $a_1 = m X_0 \omega_1^2$.

Equation (19.15) will have transient and steady-state solutions. The steady-state solution of the differential equation (19.15) may be determined as

$$z = \frac{mg \cos(\theta)}{k} + \frac{m a_1 \sin \omega_1 t}{(k - m \omega_1^2 + j c \omega_1)} \quad (19.16)$$

Rearranging Eq. (19.16) results in

$$z = \frac{mg \cos(\theta)}{\omega_n} + \frac{a_1 \sin(\omega_1 t - \phi)}{\sqrt{\omega_n^2 (1 - r^2)^2 + (2 z r)^2}} \quad (19.17)$$

where $\omega_n (= \sqrt{k/m})$ is the natural frequency of the seismic mass, $V (= c/2\sqrt{km})$ is the damping ratio. The damping ratio can be written in terms of the critical damping ratio as $V = c/c_c$, where $c_c = 2\sqrt{km}$, $\phi (= \tan^{-1} [c\omega_1/(k - m\omega_1^2)])$ is the phase angle, and $r (= \omega_1/\omega_n)$ is the frequency ratio.

A plot of Eq. (19.17), $(x_2 - x_1)_0/x_0$ against frequency ratio ω_1/ω_n , is illustrated in Fig. 19.21. This figure shows that the output amplitude is equal to the input amplitude when $c/c_c = 0.7$ and $\omega_1/\omega_n > 2$. The output becomes essentially a linear function of the input at high frequency ratios. For satisfactory system performance, the instrument constant c/c_c and ω_n should be carefully calculated or obtained from calibrations.

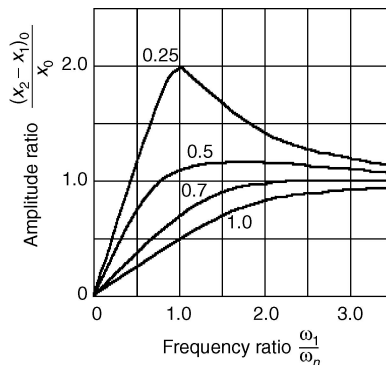

FIGURE 19.21 Frequency versus amplitude ratio of seismic accelerometers.

In this way the anticipated accuracy of measurement may be predicted for frequencies of interest. A comprehensive treatment of the analysis has been performed by McConnell [7]; interested readers should refer to this text for further details.

Seismic instruments are constructed in a variety of ways. In a potentiometric instrument, a voltage divider potentiometer is used for sensing the relative displacement between the frame and the seismic mass. In the majority of potentiometric accelerometers, the device is filled with a viscous liquid that interacts continuously with the frame and the seismic mass to provide damping. These accelerometers have a low frequency of operation (less than 100 Hz) and are mainly intended for slowly varying accelerations, and low-frequency vibrations. A typical family of such instruments offers many different models, covering the range of $\pm 1g$ to $\pm 50g$ full scale. The natural frequency ranges from 12 to 89 Hz, and the damping ratio ζ can be kept between 0.5 and 0.8 by using a temperature compensated liquid-damping arrangement. Potentiometer resistance may be selected in the range of 1000–10,000 Ω , with a corresponding resolution of 0.45–0.25% of full scale. The cross-axis sensitivity is less than $\pm 1\%$. The overall accuracy is $\pm 1\%$ of full scale or less at room temperatures. The size is about 50 mm³ with a total mass of about 1/2 kg.

Linear variable differential transformers (LVDTs) offer another convenient means of measurement of the relative displacement between the seismic mass and the accelerometer housing. These devices have higher natural frequencies than potentiometer devices, up to 300 Hz. Since the LVDT has lower resistance to motion, it offers much better resolution. A typical family of liquid-damped differential-transformer accelerometers exhibits the following characteristics. The full scale ranges from $\pm 2g$ to $\pm 700g$, the natural frequency from 35 to 620 Hz, the nonlinearity 1% of full scale. The full-scale output is about 1 V with an LVDT excitation of 10 V at 2000 Hz, the damping ratio ranges from 0.6 to 0.7, the residual voltage at the null position is less than 1%, and the hysteresis is less than 1% of full scale. The size is about 50 mm³ with a mass of about 120 g.

Electrical resistance strain gages are also used for displacement sensing of the seismic mass. In this case, the seismic mass is mounted on a cantilever beam rather than on springs. Resistance strain gauges are bonded on each side of the beam to sense the strain in the beam resulting from the vibrational displacement of the mass. A viscous liquid that entirely fills the housing provides damping of the system. The output of the strain gauges is connected to an appropriate bridge circuit. The natural frequency of such a system is about 300 Hz. The low natural frequency is due to the need for a sufficiently large cantilever beam to accommodate the mounting of the strain gauges.

One serious drawback of the seismic instruments is temperature effects requiring additional compensation circuits. The damping of the instrument may also be affected by changes in the viscosity of the fluid due to temperature. For instance, the viscosity of silicone oil, often used in these instruments, is strongly dependent on temperature.

Suspended-Mass, Cantilever, and Pendulum-Type Inertial Accelerometers

There are a number of different inertial-type accelerometers, most of which are in development stages or used under very special circumstances, such as gyropendulum, reaction-rotor, vibrating-string, and centrifugal-force-balance.

The vibrating-string instrument, Fig. 19.22, makes use of a proof mass supported longitudinally by a pair of tensioned, transversely vibrating strings with uniform cross section and equal lengths and masses. The frequency of vibration of the strings is set to several thousand cycles per second. The proof mass is supported radially in such a way that the acceleration normal to the strings does not affect the string tension. In the presence of acceleration along the sensing axis, a differential tension exists on the two strings, thus altering the frequency of vibration. From the second law of motion the frequencies may be written as

$$f_1^2 = \frac{T_1}{4m_s l} \quad \text{and} \quad f_2^2 = \frac{T_2}{4m_s l} \quad (19.18)$$

where T is the tension, m_s are the mass, and l is the lengths of strings.

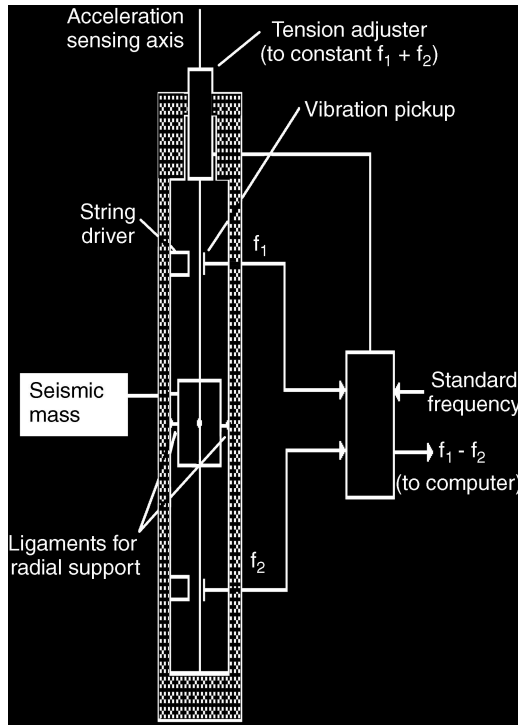

FIGURE 19.22 A typical suspended-mass-vibrating string accelerometer.

The quantity $T_1 - T_2$ is proportional to ma where a is the acceleration along the axis of the strings. An expression for the difference of the frequency-squared terms may be written as

$$f_1^2 - f_2^2 = \frac{T_1 - T_2}{4m_s l} = \frac{ma}{4m_s l} \quad (19.19)$$

Hence

$$f_1 - f_2 = \frac{ma}{4m_s l(f_1 + f_2)} \quad (19.20)$$

The sum of frequencies ($f_1 + f_2$) can be held constant by serving the tension in the strings with reference to the frequency of a standard oscillator. Then, the difference between the frequencies becomes linearly proportional to acceleration. In some versions, the beamlike property of the vibratory elements is used by gripping them at nodal points corresponding to the fundamental mode of the vibration of the beam, and at the respective centers of percussion of the common proof mass. The output frequency is proportional to acceleration and the velocity is proportional to phase, thus offering an important advantage. The improved versions of these devices lead to cantilever-type accelerometers, discussed next.

In a cantilever-type accelerometer, a small cantilever beam mounted on the block is placed against the vibrating surface, and an appropriate mechanism is provided for varying the beam length. The beam length is adjusted such that its natural frequency is equal to the frequency of the vibrating surface, and hence the resonance condition is obtained. Recently, slight variations of cantilever-beam arrangements are finding new applications in microaccelerometers.

In a different type of suspended-mass configuration, a pendulum is used that is pivoted to a shaft rotating about a vertical axis. Pickoff mechanisms are provided for the pendulum and the shaft speed.

The system is servo controlled to maintain it at null position. Gravitational acceleration is balanced by the centrifugal acceleration. The shaft speed is proportional to the square root of the local value of the acceleration.

Electromechanical Accelerometers

Electromechanical accelerometers, essentially servo or null-balance types, rely on the principle of feedback. In these instruments, an acceleration-sensitive mass is kept very close to a neutral position or zero displacement point by sensing the displacement and feeding back the effect of this displacement. A proportional magnetic force is generated to oppose the motion of the mass displaced from the neutral position, thus restoring this position just as a mechanical spring in a conventional accelerometer would do. The advantages of this approach are better linearity and elimination of hysteresis effects, as compared to the mechanical springs. Also, in some cases, electrical damping can be provided, which is much less sensitive to temperature variations.

One very important feature of electromechanical accelerometers is the capability of testing the static and dynamic performances of the devices by introducing electrically excited test forces into the system. This remote self-checking feature can be quite convenient in complex and expensive tests where accuracy is essential. These instruments are also useful in acceleration control systems, since the reference value of acceleration can be introduced by means of a proportional current from an external source. They are used for general-purpose motion measurements and monitoring low-frequency vibrations.

There are a number of different electromechanical accelerometers: coil-and-magnetic types, induction types, etc.

Coil-and-Magnetic Accelerometers

These accelerometers are based on Ampere's law, that is, "a current-carrying conductor disposed within a magnetic field experiences a force proportional to the current, the length of the conductor within the field, the magnetic field density, and the sine of the angle between the conductor and the field." The coils of these accelerometers are located within the cylindrical gap defined by a permanent magnet and a cylindrical soft iron flux return path. They are mounted by means of an arm situated on a minimum friction bearing or flexure so as to constitute an acceleration-sensitive seismic mass. A pickoff mechanism senses the displacement of the coil under acceleration and causes the coil to be supplied with a direct current via a suitable servo controller to restore or maintain a null condition. The electrical currents in the restoring circuit are linearly proportional to acceleration, provided (1) armature reaction effects are negligible and fully neutralized by a compensating coil in opposition to the moving coil, and (2) the gain of the servo system is large enough to prevent displacement of the coil from the region in which the magnetic field is constant.

In these accelerometers, the magnetic structure must be shielded adequately to make the system insensitive to external disturbances or the earth's magnetic field. Also, in the presence of acceleration there will be a temperature rise due to i^2R losses. The effects of these i^2R losses on the performance are determined by the thermal design and heat-transfer properties of the accelerometers.

Induction Accelerometers

The cross-product relationship of current, magnetic field, and force is the basis for induction-type electromagnetic accelerometers. These accelerometers are essentially generators rather than motors. One type of instrument, the cup-and-magnet design, includes a pendulous element with a pickoff mechanism and a servo controller driving a tachometer coupling. A permanent magnet and a flux return ring, closely spaced with respect to an electrically conductive cylinder, are attached to the pendulous element. A rate-proportional drag force is obtained by the electromagnetic induction effect between the magnet and the conductor. The pickoff mechanism senses pendulum deflection under acceleration and causes the servo controller to turn the rotor to drag the pendulous element toward the null position. Under steady-state conditions motor speed is a measure of the acceleration acting on the instrument. Stable servo operation is achieved by employing a time-lead network to compensate the inertial time lag of

the motor and magnet combination. The accuracy of the servo-type accelerometers is ultimately limited by consistency and stability of scale factors of coupling and cup-and-magnet devices as a function of time and temperature.

Another accelerometer based on induction design uses the eddy-current induction torque generation. The force-generating mechanism of an induction accelerometer consists of a stable magnetic field, usually supplied by a permanent magnet, which penetrates orthogonally through a uniform conduction sheet. The movement of the conducting sheet relative to the magnetic field in response to acceleration results in a generated electromotive potential in each circuit in the conductor. This action is in accordance with Faraday's principle. In induction-type accelerometers, the induced eddy currents are confined to the conductor sheet, making the system essentially a drag coupling. Since angular rate is proportional to acceleration, angular position represents change in velocity. This is a particularly useful feature in navigation applications.

A typical commercial instrument based on the servo-accelerometer principle might have a micromachined quartz flexure suspension, differential capacitance angle pick-off, air-squeeze film plus servo-lead compensation for system damping. Of the available models, as an example, a typical 30g unit has a threshold and resolution of 1 μ g, a frequency response that is flat to within 0.05% at 10 Hz and 2% at 100 Hz, a natural frequency of 1500 Hz, a damping ratio from 0.3 to 0.8, and transverse or cross-axis sensitivity of 0.1%. If, for example, the output current is about 1.3 mA/g, a 250 Ω readout resistor would give about ± 10 V full scale at 30g. These accelerometers are good for precision work and used in many applications such as aircraft and missile control systems, measurement of tilt angles for borehole navigation, and axle angular bending in aircraft weight and balance systems.

Piezoelectric Accelerometers

Piezoelectric accelerometers are widely used for general-purpose acceleration, shock, and vibration measurements. They are basically motion transducers with large output signals and comparatively small sizes and they are self generators not requiring external power sources. They are available with very high natural frequencies and are therefore suitable for high-frequency applications and shock measurements.

These devices utilize a mass in direct contact with the piezoelectric component or crystal as shown in Fig. 19.23. When a varying motion is applied to the accelerometer, the crystal experiences a varying force excitation ($F = ma$), causing a proportional electric charge q to be developed across it. So,

$$q = d_{ij}F = d_{ij}ma \tag{19.21}$$

where q is the charge developed and d_{ij} is the piezoelectric coefficient of the material.

As this equation shows, the output from the piezoelectric material is dependent on its mechanical properties, d_{ij} . Two commonly used piezoelectric crystals are lead-zirconate titanate ceramic (PZT) and crystalline quartz. They are both self-generating materials and produce a large electric charge for their size. The piezoelectric strain constant of PZT is about 150 times that of quartz. As a result, PZTs are much more sensitive and smaller in size than quartz counterparts. These accelerometers are useful for

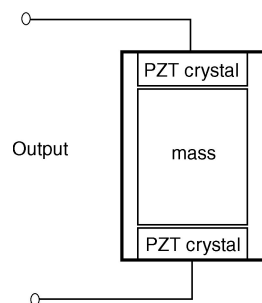

FIGURE 19.23 A compression type piezoelectric accelerometer arrangement.

high-frequency applications. The roll-off typically starts near 100 Hz. These active devices have no DC response. Since piezoelectric accelerometers have comparatively low mechanical impedances, their effect on the motion of most structures is negligible.

Mathematically, their transfer function approximates a third-order system that can be expressed as

$$\frac{e_0(s)}{a(s)} = \frac{K_q \tau s}{C \omega_n^2 (\tau s + 1) (s^2 / \omega_n^2 + 2 \zeta s / \omega_n + 1)} \quad (19.22)$$

where K_q is the piezoelectric constant related to charge ($C \text{ cm}$), τ is the time constant of the crystal, and s is the Laplace variable. It is worth noting that the crystal itself does not have a time constant τ , but the time constant is observed when the accelerometer is connected to an electric circuit, for example, an RC circuit.

The low-frequency response is limited by the piezoelectric characteristic $\tau s / (\tau s + 1)$, while the high-frequency response is related to mechanical response. The damping factor ζ is very small, usually less than 0.01 or near zero. Accurate low-frequency response requires large τ , which is usually achieved by use of high-impedance voltage amplifiers. At very low frequencies thermal effects can have severe influences on the operation characteristics.

In piezoelectric accelerometers, two basic design configurations are used: compression types and shear-stress types. In compression-type accelerometers, the crystal is held in compression by a preload element; therefore the vibration varies the stress in compressed mode. In a shear-stress accelerometer, vibration simply deforms the crystal in shear mode. The compression accelerometer has a relatively good mass to sensitivity ratio and hence exhibits better performance. But, since the housing acts as an integral part of the spring-mass system, it may produce spurious interfaces in the accelerometer output if excited around its natural frequency.

Piezoelectric accelerometers are available in a wide range of specifications and are offered by a large number of manufacturers. For example, the specifications of a shock accelerometer may have 0.004 pC/g in sensitivity and a natural frequency of up to 250,000 Hz, while a unit designed for low-level seismic measurements might have 1000 pC/g in sensitivity and only 7000 Hz natural frequency. They are manufactured as small as $3 \times 3 \text{ mm}$ in dimension with about 0.5 g in mass, including cables. They have excellent temperature ranges and some of them are designed to survive the intensive radiation environment of nuclear reactors. However, piezoelectric accelerometers tend to have larger cross-axis sensitivity than other types, about 2–4%. In some cases, large cross-axis sensitivity may be minimized during installations by the correct orientation of the device. These accelerometers may be mounted with threaded studs, with cement or wax adhesives, or with magnetic holders.

Piezoresistive Accelerometers

Piezoresistive accelerometers are essentially semiconductor strain gauges with large gauge factors. High gauge factors are obtained since the material resistivity is dependent primarily on the stress, not only on the dimensions. This effect can be greatly enhanced by appropriate doping of semiconductors such as silicon. Most piezoresistive accelerometers use two or four active gauges arranged in a Wheatstone bridge. Extra precision resistors are used, as part of the circuit, in series with the input to control the sensitivity, for balancing, and for offsetting temperature effects. The sensitivity of a piezoresistive sensor comes from the elastic response of its structure and resistivity of the material. Wire and thick or thin film resistors have low gauge factors, that is, the resistance change due to strain is small. The mechanical construction of a piezoresistive accelerometer is shown in Fig. 19.24.

Piezoresistive accelerometers are useful for acquiring vibration information at low frequencies, for example, below 1 Hz. In fact, they are inherently true non-vibrational acceleration sensors. They generally have wider bandwidth, smaller nonlinearities and zero shifting, and better hysteresis characteristics compared to piezoelectric counterparts. They are suitable to measure shocks well above 100,000g. Typical characteristics

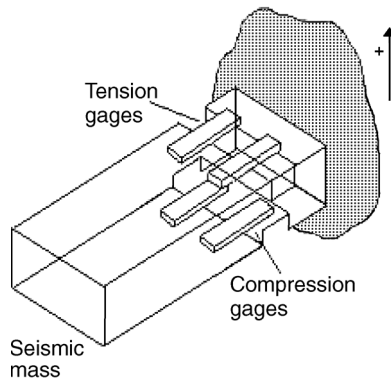

FIGURE 19.24 Bonding of piezoresistive and piezoelectric accelerometers to the inertial systems.

of piezoresistive accelerometers may be listed to be 100 mV/g as the sensitivity, 0–750 Hz as the frequency range, 2500 Hz in resonance frequency, 25g as the amplitude range, 2000g as the shock rating, and 0–95°C as the temperature range, with a total mass of about 25 g.

Most contemporary piezoresistive sensors are manufactured from a single piece of silicon. This gives better stability and less thermal mismatch between parts. In a typical monolithic sensing element a 1-mm silicon chip incorporates the spring, mass, and four-arm bridge assembly. The elements are formed by a pattern of dopant in the originally flat silicon. Subsequent etching of channels frees the gauges and simultaneously defines the masses as regions of silicon of original thickness.

Strain-Gauge Accelerometers

Strain-gauge accelerometers are based on resistance properties of electrical conductors. If a conductor is stretched or compressed, its resistance alters due to (a) dimensional changes, and (b) the changes in the fundamental property of material called piezoresistance. This indicates that the resistivity ρ of the conductor depends on the mechanical strain applied onto it. The dependence is expressed as the gauge factor:

$$\frac{dR/R}{dL/L} = 1 + 2\nu + \frac{d\rho/\rho}{dL/L} \quad (19.23)$$

where 1 indicates the resistance change due to length, 2ν indicates resistance change due to area, and $(d\rho/\rho)/(dL/L)$ indicates the resistance change due to piezoresistivity.

There are many types of strain-gauges: unbonded metal-wire gauges, bonded metal-wire gauges, bonded metal-foil gauges, vacuum-deposited thin-metal-film gauges, bonded semiconductor gauges, and diffused semiconductor gauges. However, usually bonded and unbonded metal-wire gauges find wider applications. A section of the strain-gauge accelerometers, particularly bonded semiconductor types, known as the piezoresistive transducers, are used, but they suffer from high temperature sensitivities, nonlinearities, and some mounting difficulties. Nevertheless, with the recent developments of micromachine technology, these sensors have been improved considerably, thus finding many new applications.

Unbonded-strain-gauge accelerometers use the strain wires as the spring element and as the motion transducer, using similar arrangements as in Fig. 19.25. They are useful for general-purpose motion and vibration measurements from low to medium frequencies. They are available in wide ranges and characteristics: typically $\pm 5g$ to $\pm 200g$ full scale, a natural frequency of 17–800 Hz, a 10-V excitation voltage AC or DC, full scale output ± 20 mV to ± 50 mV, a resolution less than 0.1%, an inaccuracy less than 1% full scale, and a cross-axis sensitivity less than 2%. The damping ratio (using silicone oil damping) is 0.6–0.8 at room temperature. These instruments are small and light, usually with a mass less than 25 g.

Bonded-strain-gauge accelerometers generally use a mass supported by a thin flexure beam. The strain gauges are cemented onto the beam to achieve maximum sensitivity, temperature compensation, and sensitivity to both cross-axis and angular accelerations. Their characteristics are similar to the unbonded-strain-gauge accelerometers but have greater sizes and weights. Often silicone oil is used for damping. Semiconductor strain gauges are widely used as strain sensors in cantilever-beams and mass types of accelerometers. They allow high outputs (0.2–0.5 V full scale). Typically, a $\pm 25g$ acceleration unit has a flat response from 0 to 750 Hz, a damping ratio of 0.7, a mass of about 28 g, and an operational temperature of -18°C to $+93^\circ\text{C}$. A triaxial $\pm 20,000g$ model has a flat response from 0 to 15 kHz, a damping ratio of 0.01, and a compensation temperature range of $0\text{--}45^\circ\text{C}$, and is $13 \times 10 \times 13 \text{ mm}^3$ in size and 10 g in mass.

Electrostatic Accelerometers

Electrostatic accelerometers are based on Coulomb's law between two charged electrodes; therefore, they are capacitive types. Depending on the operation principles and external circuits they can be broadly classified as (a) electrostatic-force-feedback accelerometers, and (b) differential-capacitance accelerometers.

Electrostatic-Force-Feedback Accelerometers

An electrostatic-force-feedback accelerometer consists of an electrode, with mass m and area S , mounted on a light pivoted arm that moves relative to some fixed electrodes. The nominal gap h between the pivoted and fixed electrodes is maintained by means of a force-balancing servo system, which is capable of varying the electrode potential in response to signals from a pickoff mechanism that senses relative changes in the gap. Mathematically, the field between the electrodes may be expressed by

$$E = \frac{Q}{\epsilon k S} \quad (19.24)$$

where E is the intensity or potential gradient (dV/dx), Q is the charge, S is the area of the conductor, and k is the dielectric constant of the space outside the conductor.

From this expression, it can be shown that the force per unit area of the charged conductor (in N/m^2) is given by

$$\frac{F}{S} = \frac{Q^2}{2\epsilon k S^2} = \frac{\epsilon k E^2}{2} \quad (19.25)$$

Consider one movable and one stationary electrode and assume that the movable electrode is maintained at a bias potential V_1 and the stationary one at a potential V_2 . The electrical intensity E in the gap, h , can be expressed as

$$E_1 = \frac{V_1 - V_2}{h} \quad (19.26)$$

so that the force of attraction may be found as

$$F_1 = \frac{\epsilon k E^2 S}{2h^2} = \frac{\epsilon k (V_1 - V_2)^2 S}{2h^2} \quad (19.27)$$

In the presence of acceleration, if V_2 is adjusted to restrain the movable electrode to the null position, the expression relating acceleration and electrical potential may be given by

$$a = \frac{F_1}{m} = \frac{\epsilon k (V_1 - V_2)^2 S}{2h^2 m} \quad (19.28)$$

The device so far described can measure acceleration in one direction only, and the output is quadratic in character, that is,

$$(V_1 - V_2) = D\sqrt{a} \quad (19.29)$$

where D is the constant of proportionality.

The output may be linearized in a number of ways, one of which is the quarter-square method. If the servo controller applies a potential $-V_2$ to the other fixed electrode, the force of attraction between this electrode and the movable electrode becomes

$$a = \frac{F_2}{m} = \frac{\epsilon k (V_1 + V_2)^2 S}{2h^2 m} \quad (19.30)$$

and the force-balance equation of the movable electrode when the instrument experiences a downward acceleration a now is

$$ma = F_2 - F_1 = \frac{\epsilon k S [(V_1 + V_2)^2 - (V_1 - V_2)^2]}{2h^2}$$

or

$$ma = F_2 - F_1 = \frac{2\epsilon k S V_1 V_2}{h^2} \quad (19.31)$$

Hence, if the bias potential V_1 is held constant and the gain of the control loop is high so that variations in the gap are negligible, the acceleration becomes a linear function of the controller output voltage V_2 .

The principal difficulty in mechanizing the electrostatic force accelerometer is the relatively high electric field intensity required to obtain an adequate force. Damping can be provided electrically or by viscosity of the gaseous atmosphere in the inter-electrode space if the gap h is sufficiently small. The scheme works best in micromachined instruments. Nonlinearity in the voltage breakdown phenomenon permits larger gradients in very small gaps.

A typical electrostatic accelerometer has the following characteristics: range $\pm 50g$, resolution $10^{-3}g$, sensitivity 100 mV/g, nonlinearity $<1\%$ FS, transverse sensitivity $<1\%$ FS, thermal sensitivity $6 \times 10^{-4}/K$, mechanical shock 10,000g, operating temperature -45°C to 90°C , supply voltage 5 V DC, and weight 45 g. The main advantages of electrostatic accelerometers are their extreme mechanical simplicity, low power requirements, absence of inherent sources of hysteresis errors, zero temperature coefficients, and ease of shielding from stray fields.

Differential-Capacitance Accelerometers

Differential-capacitance accelerometers are based on the principle of the change of capacitance in proportion to applied acceleration. In one type, the seismic mass of the accelerometer is made as the movable element of an electrical oscillator. The seismic mass is supported by a resilient parallel-motion beam arrangement from the base. The system is set to have a certain defined nominal frequency when undisturbed. If the instrument is accelerated, the frequency varies above and below the nominal value depending on the direction of acceleration.

The seismic mass carries an electrode located in opposition to a number of base-fixed electrodes that define variable capacitors. The base-fixed electrodes are resistances coupled in the feedback path of a wideband, phase-inverting amplifier. The gain of the amplifier is predetermined to ensure maintenance

of oscillations over the range of variation of the capacitance determined by the applied acceleration. The value of the capacitance C for each of the variable capacitors is given by

$$C = \frac{\epsilon k S}{h} \quad (19.32)$$

where k is the dielectric constant, ϵ is the permittivity of free space, S is the area of the electrode, and h is the variable gap.

Denoting the magnitude of the gap for zero acceleration as h_0 , the value of h in the presence of acceleration a may be written as

$$h = h_0 + \frac{ma}{K} \quad (19.33)$$

where m is the value of the proof mass and K is the spring constant. Thus,

$$C = \frac{\epsilon k S}{h_0 + (ma/K)} \quad (19.34)$$

For example, the frequency of oscillation of the resistance-capacitance type circuit is given by the expression

$$f = \frac{\sqrt{6}}{2\pi RC} \quad (19.35)$$

Substituting this value of C in Eq. (19.34) gives

$$f = \frac{\sqrt{6}[h_0 + (ma/K)]}{2\pi R \epsilon k S} \quad (19.36)$$

Denote the constant quantity $\sqrt{6}/(2\pi R \epsilon k S)$ as B and rewrite Eq. (19.36) as

$$f = B h_0 + \frac{B m a}{K} \quad (19.37)$$

The first term on the right-hand side expresses the fixed bias frequency f_0 and the second term denotes the change in frequency resulting from acceleration, so that the expression may be written as

$$f = f_0 + f_a \quad (19.38)$$

If the output frequency is compared with an independent source of a constant frequency of f_0 , then f_a can be determined easily.

A commonly used capacitive-type accelerometer is based on a thin diaphragm with spiral flexures that provide the spring, proof mass, and moving plate necessary for the differential capacitor. Plate motion between the electrodes pumps air parallel to the plate surface and through holes in the plate to provide squeeze film damping. Since air viscosity is less temperature sensitive than oil, the desired damping ratio of 0.7 hardly changes more than 15%. A family of such instruments are easily available with full-scale ranges from $\pm 0.2g$ (4 Hz flat response) to $\pm 1000g$ (3000 Hz), a cross-axis sensitivity less than 1%, and a full-scale output of ± 1.5 V. The size of a typical device is about 25 mm^3 with a mass of 50 g.

Micro- and Nanoaccelerometers

By the end of the 1970s it became apparent that the essentially planar processing integrated-circuit (IC) technology could be modified to fabricate three-dimensional electromechanical structures by the micromachining process. Accelerometers and pressure sensors were among the first IC sensors. The first accelerometer was developed in 1979. Since then the technology has been progressing steadily and now an extremely diverse range of accelerometers are readily available. Most sensors use bulk micromachining rather than surface micromachining techniques. In bulk micromachining the flexures, resonant beams, and all other critical components of the accelerometer are made from bulk silicon in order to exploit the full mechanical properties of silicon crystals. With proper design and film process, bulk micromachining yields extremely stable and robust accelerometers.

The selective etching of multiple layers of deposited thin films, or surface micromachining, allows movable microstructures to be fabricated on silicon wafers. With surface micromachining, layers of structure material are disposed and patterned as shown in Fig. 19.25. These structures are formed by polysilicons and sacrificial materials such as silicon dioxides. The sacrificial material acts as an intermediate spacer layer and is etched away to produce a freestanding structure. Surface machining technology also allows smaller and more complex structures to be built in multiple layers on a single substrate. A typical example of modern micromachined accelerometer is given in Fig. 19.26. Multiple accelerometers can be mounted on a single chip, sensing accelerations in x , y , and z directions. The primary signal conditioning is also provided in the same chip. The output from the chip is usually read in the digital form.

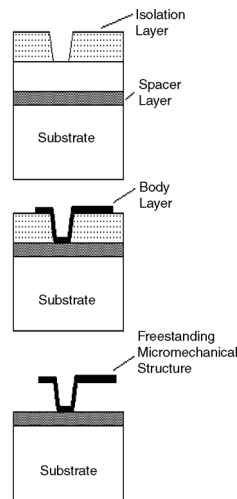

FIGURE 19.25 Steps of micromachining to manufacture micro- and nanoaccelerometers.

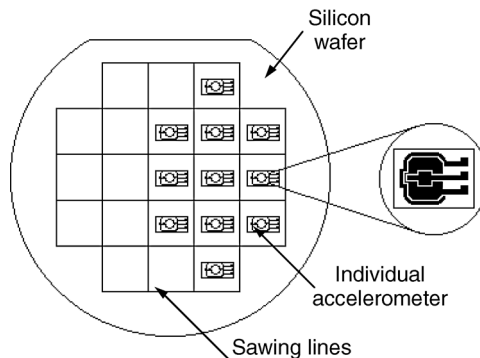

FIGURE 19.26 Multiple accelerometers in a single chip.

Most micro- and nanoaccelerometers detect acceleration by measuring the relative motion between proof mass and mounting substrate. The proof mass is suspended above the substrate by a mechanical spring suspension. When the sensor undergoes acceleration, the proof mass tends to remain stationary and therefore displaces with respect to the moving substrate. This displacement is measured capacitively or by means of piezoresistive or piezoelectric methods using CMOS technology. Chip circuits provide offset cancellation for bias stability, gain scale factor stability, zero acceleration bias stability, temperature compensation, prefiltering, noise immune digital output, and so on.

The operational principles of some of the microaccelerometers are very similar to capacitive force-balance or vibrating-beam accelerometers, discussed earlier. Manufacturing techniques may change from one manufacturer to another. However, in general, vibrating-beam accelerometers are preferred because of better air-gap properties and improved bias performance characteristics.

Vibrating-beam accelerometers, also termed resonant-beam force transducers, are made in such a way that an acceleration along a positive input axis places the vibrating beam in tension. Thus, the resonant frequency of the vibrating beam increases or decreases with the applied acceleration.

In DETF, an electronic oscillator capacitively couples energy into two vibrating beams to keep them oscillating at their resonant frequency. The beams vibrate 180° out of phase to cancel reaction forces at the ends. The dynamic cancellation effect of the DETF design prevents energy from being lost through the ends of the beam. Hence, the dynamically balanced DETF resonator has a high Q factor, which leads to a stable oscillator circuit. The acceleration signal is produced from the oscillator as a frequency-modulated square wave that can be used for a digital interface.

The frequency of resonance of the system must be much higher than any input acceleration, and this limits the measurable range. In a micromachined accelerometer, used in military applications, the following characteristics are given: a range of $\pm 1200g$, a sensitivity of 1.11 Hz/g, a bandwidth of 2500 Hz, an unloaded DETF frequency of 9952 Hz. The frequency at +1200g is 11,221 Hz, the frequency at -1200g is 8544 Hz, and the temperature sensitivity is 5 mg/°C. The accelerometer size is 6 mm diameter by 4.3 mm length, with a mass of about 9 g. It has a turn-on time of less than 60 s, the accelerometer is powered with +9 to +16 V DC, and the nominal output is a 9000-Hz square wave.

Surface micromachining has also been used to manufacture specific application accelerometers, such as air-bag applications in the automotive industry. In one type, a three-layer differential capacitor is created by alternate layers of polysilicon and phosphosilicate glass (PSG) on a 0.38-mm thick, 100-mm long wafer. A silicon wafer serves as the substrate for the mechanical structure. The trampoline-shaped middle layer is suspended by four supporting arms. This movable structure is the seismic mass for the accelerometer. The upper and lower polysilicon layers are fixed plates for the differential capacitors. The glass is sacrificially etched by hydrofluoric acid (HF).

Signal Conditioning and Biasing

Common signal conditioners are appropriate for interfacing accelerometers to computers or other instruments for further signal processing. Generally, the generated raw signals are amplified and filtered suitably by the circuits within the accelerometer casing supplied by manufacturers. Nevertheless, piezoelectric and piezoresistive transducers require special signal conditioners with certain characteristics that will be discussed next.

Piezoelectric Accelerometers

Piezoelectric accelerometers supply small energy to the signal conditioners since they have high capacitive source impedances. The equivalent circuit of a piezoelectric accelerometer can be regarded as an active capacitor that charges itself when mechanically loaded. The selection of the elements of the external signal conditioning circuit is dependent on the characteristics of the equivalent circuit. A most common approach is the charge amplifier since the system gain and low-frequency responses of these amplifiers are well defined. The performance of the circuit is also independent of cable length and capacitance of the accelerometer. In many applications, noise-treated cables are necessary to avoid the triboelectric charges occurring due to movement of cables.

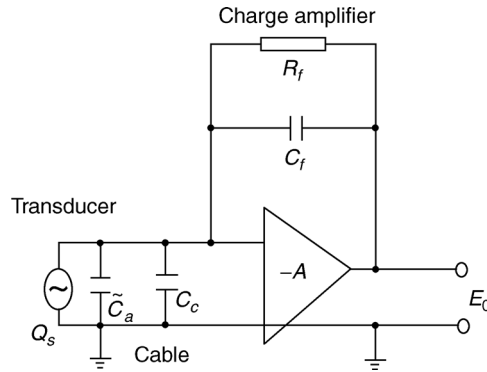

FIGURE 19.27 A typical charge amplifier.

The charge amplifier (with about 1000 MΩ input impedance) basically converts the input charge to voltage first and then amplifies this voltage. It consists of a charge converter output voltage, which occurs as a result of the charge input signal returning through the feedback capacitor to maintain the input voltage at the input level close to zero, as shown in Fig. 19.27. With the help of basic operational-type feedback, the amplifier input is maintained at essentially 0 V; therefore, it looks like a short circuit to the input. Thus, the charge input is stored in the feedback capacitor, producing a voltage across it that is equal to the value of the charge input divided by the capacitance of the feedback capacitor. The complete transfer function of the circuit describing the relationship between the output voltage and the input acceleration magnitude may be determined by the following complex transform:

$$\frac{E_0}{a_0} = S_a j R_f C_f \omega \left[1 + j R_f C_f \omega \left(1 + C_f + \frac{C_a + C_c}{1 + G} \right) \right] \quad (19.39)$$

where E_0 is the charge converter output (V), a_0 is the magnitude of acceleration (m/s^2), S_a is the accelerometer sensitivity (mV/g), C_a is the accelerometer capacitance (F), C_c is the cable capacitance (F), C_f is the feedback capacitance (F), R_f is the feedback loop resistance, and G is the amplifier open-loop gain.

In most applications, since C_f is selected to be large compared to $(C_a + C_c)/(1 + G)$, the system gain becomes independent of the cable length. In this case the denominator of the equation can be simplified to give a first-order system with roll off at

$$f_{-3\text{dB}} = \frac{1}{2\pi R_e C_f} \quad (19.40)$$

with a slope of 10 dB per decade. For practical purposes, the low-frequency response of this system is a function of well-defined electronic components and does not vary by cable length. This is an important feature when measuring low-frequency vibrations.

Many piezoelectric accelerometers are manufactured with preamplifiers and other signal-conditioning circuits enclosed in the same casing. Some accelerometer preamplifiers include integrators to convert the acceleration proportional outputs to either velocity or displacement proportional signals. To attenuate noise and vibration signals that lie outside the frequency range of interest, most preamplifiers are equipped with a range of high-pass and low-pass filters. This avoids interference from electrical noise or signals inside the linear portion of the accelerometer frequency range. Nevertheless, it is worth mentioning that these devices usually have two time constants, external and internal. The mixture of these two time constants can lead to problems particularly at low frequencies. Manufacturers through design and construction usually fix the internal time constants. However, care must be observed to account for the effect of external time constants through impedance matching.

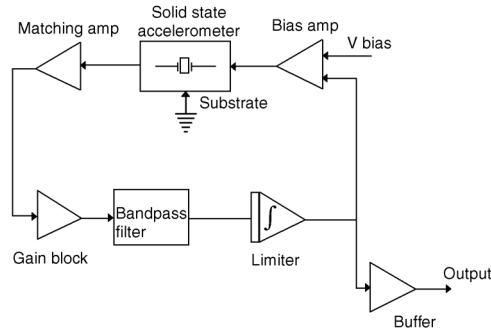

FIGURE 19.28 A typical signal conditioning arrangement for single chip microaccelerometers.

Piezoresistive Transducers

Piezoresistive transducers generally have high-amplitude outputs, low-output impedance, and low intrinsic noise. Most of these transducers are designed for constant-voltage excitations. They are usually calibrated for constant-current excitations to avoid external interference. Many piezoresistive transducers are configured as full-bridge devices. Some have four active piezoresistive arms, together with two fixed precision resistors to permit shunt calibration.

Microaccelerometers

In microaccelerometers signal-conditioning circuitry is integrated within the same chip as the sensor. A typical example of the signal-conditioning circuitry is given in Fig. 19.28 in block diagram form. In this type of accelerometer, the electronic system is essentially a crystal-controlled oscillator circuit and the output signal of the oscillator is a frequency-modulated acceleration signal. Some circuits provide a buffered square-wave output that can be directly interfaced digitally. In these cases the need for analog-to-digital (A/D) conversion is eliminated, thus removing one of the major sources of errors. In other types of accelerometers, signal conditioning circuits such as A/D converters are retained within the chip.

Force Feedback Accelerometers

Signals from force feedback accelerometers often must be digitized for use in digital systems. A common solution is to use voltage to frequency or current to frequency converters to convert the analog signals to train pulses. These converters are expensive, often as much as the accelerometer, and add as much to the error budget.

Here, it is worth mentioning that GPS systems are becoming add-ons to many position sensing mechanisms. Because of antenna dynamics, shadowing, multipath effects, and to provide redundancy for critical systems such as aircraft, many of these systems require inertial aiding, tied-in with accelerometers and gyros. With the development of micromachining, small and cost-effective GPS assisted inertial systems will be available in the near future. These developments will require extensive signal processing with a high degree of accuracy. Dynamic ranges on the order of a million to one (e.g., 30–32 bits) need to be dealt with. In order to achieve accuracy requirements, a great challenge awaits the signal processing practitioner.

References

1. Bentley, J. P., *Principles of Measurement Systems*, 2nd ed., Burnt Mill, UK: Longman Scientific and Technical, 1988.
2. Doebelin, E. O., *Measurement Systems: Application and Design*, 4th ed., Singapore: McGraw-Hill, 1990.
3. Frank, R., *Understanding Smart Sensors*, Boston: Artech House, 1996.
4. Harris, C., *Shock and Vibration Handbook*, 4th ed., McGraw-Hill, 1995.
5. Holman, J. P., *Experimental Methods for Engineers*, 5th ed., Singapore: McGraw-Hill, 1989.

6. Lawrance, A., *Modern Inertial Technology-Navigation, Guidance, and Control*, Springer-Verlag, New York, 1993.
7. McConnell, K. G., *Vibration Testing: Theory and Practice*, New York: Wiley, 1995.
8. *Machine Vibration: Dynamics and Control*, London: Springler, 1992–1996.
9. *Measuring Vibration*, Bruel & Kjaer, 1982.
10. Sydenham, P. H., Hancock, N. H., and Thorn, R., *Introduction to Measurement Science and Engineering*, New York: Wiley, 1989.
11. Tompkins, W. J. and Webster, J. G., *Interfacing Sensors to the IBM PC*, Englewood Cliffs, NJ: Prentice-Hall, 1988.

19.3 Force Measurement

M. A. Elbestawi

Force, which is a vector quantity, can be defined as an action that will cause an acceleration or a certain reaction of a body. This chapter will outline the methods that can be employed to determine the magnitude of these forces.

General Considerations

The determination or measurement of forces must yield to the following considerations: if the forces acting on a body do not produce any acceleration, they must form a *system of forces in equilibrium*. The system is then considered to be in static equilibrium. The forces experienced by a body can be classified into two categories: internal, where the individual particles of a body act on each other, and external otherwise. If a body is supported by other bodies while subject to the action of forces, deformations and/or displacements will be produced at the points of support or contact. The internal forces will be distributed throughout the body until equilibrium is established, and then the body is said to be in a state of tension, compression, or shear. In considering a body at a definite section, it is evident that all the internal forces act in pairs, the two forces being equal and opposite, whereas the external forces act singly.

Hooke's Law

The basis for force measurement results from the physical behavior of a body under external forces. Therefore, it is useful to review briefly the mechanical behavior of materials. When a metal is loaded in uniaxial tension, uniaxial compression, or simple shear (Fig. 19.29), it will behave elastically until a critical value of normal stress (S) or shear stress (τ) is reached, and then it will deform plastically [1]. In the

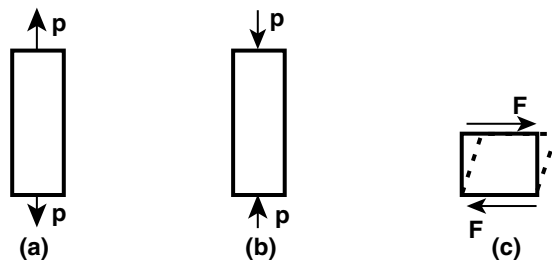

FIGURE 19.29 When a metal is loaded in uniaxial tension (a), uniaxial compression (b), or simple shear(c), it will behave elastically until a critical value of normal stress or shear stress is reached.

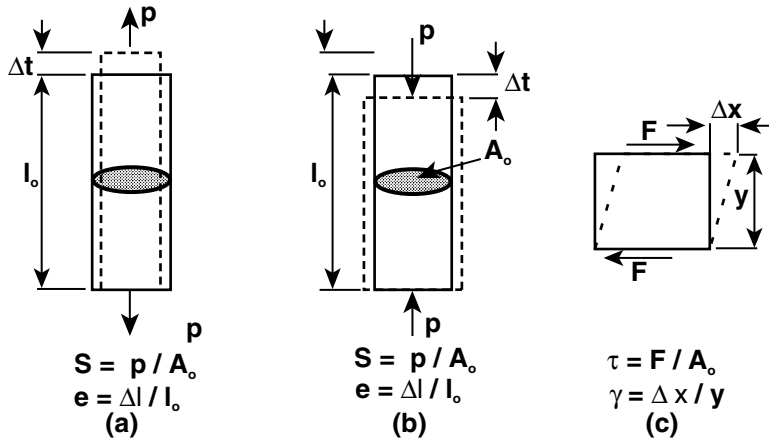

FIGURE 19.30 Elastic stress and strain for: (a) uniaxial tension; (b) uniaxial compression; (c) simple shear [1].

elastic region, the atoms are temporarily displaced but return to their equilibrium positions when the load is removed. Stress (S or τ) and strain (e or γ) in the elastic region are defined as indicated in Fig. 19.30.

$$\nu = -\frac{e_2}{e_1} \quad (19.41)$$

Poisson's ratio (ν) is the ratio of transverse (e_2) to direct (e_1) strain in tension or compression. In the elastic region, ν is between 1/4 and 1/3 for metals. The relation between stress and strain in the elastic region is given by Hooke's law:

$$S = Ee \quad (\text{tension or compression}) \quad (19.42)$$

$$\tau = G\gamma \quad (\text{simple shear}) \quad (19.43)$$

where E and G are the Young's and shear modulus of elasticity, respectively. A small change in specific volume ($\Delta Vol / Vol$) can be related to the elastic deformation, which is shown to be as follows for an isotropic material (same properties in all directions):

$$\frac{\Delta Vol}{Vol} = e_1(1 - 2\nu) \quad (19.44)$$

The bulk modulus ($K = \text{reciprocal of compressibility}$) is defined as follows:

$$K = \Delta p / \left(\frac{\Delta Vol}{Vol} \right) \quad (19.45)$$

where Δp is the pressure acting at a particular point. For an elastic solid loaded in uniaxial compression (S):

$$K = S / \left(\frac{\Delta Vol}{Vol} \right) = \frac{S}{e_1(1 - 2\nu)} = \frac{E}{1 - 2\nu} \quad (19.46)$$

Thus, an elastic solid is compressible as long as ν is less than 1/2, which is normally the case for metals. Hooke's law, Eq. (19.42), for uniaxial tension can be generalized for a three-dimensional elastic condition.

The theory of elasticity is well established and is used as a basis for force measuring techniques. Note that the measurement of forces in separate engineering applications is very application specific, and care must be taken in the selection of the measuring techniques outlined below.

Basic Methods of Force Measurement

An unknown force may be measured by the following means:

1. balancing the unknown force against a standard mass through a system of levers,
2. measuring the acceleration of a known mass,
3. equalizing it to a magnetic force generated by the interaction of a current-carrying coil and a magnet,
4. distributing the force on a specific area to generate pressure and then measuring the pressure,
5. converting the applied force into the deformation of an elastic element.

The aforementioned methods used for measuring forces yield a variety of designs of measuring equipment. The challenge involved with the task of measuring force resides primarily in sensor design. The basics of sensor design can be resolved into two problems:

1. primary geometric, or physical constraints, governed by the application of the force sensor device;
2. the means by which the force can be converted into a workable signal form (such as electronic signals or graduated displacements).

The remaining sections will discuss the types of devices used for force-to-signal conversion and finally illustrate some examples of applications of these devices for measuring forces.

Force Sensors

Force sensors are required for a basic understanding of the response of a system. For example, cutting forces generated by a machining process can be monitored to detect a tool failure or to diagnose the causes of this failure in controlling the process parameters, and in evaluating the quality of the surface produced. Force sensors are used to monitor impact forces in the automotive industry. Robotic handling and assembly tasks are controlled by detecting the forces generated at the end effector. Direct measurement of forces is useful in controlling many mechanical systems.

Some types of force sensors are based on measuring a deflection caused by the force. Relatively high deflections (typically, several micrometers) would be necessary for this technique to be feasible. The excellent elastic properties of helical springs make it possible to apply them successfully as force sensors that transform the load to be measured into a deflection. The relation between force and deflection in the elastic region is demonstrated by Hooke's law. Force sensors that employ strain gage elements or piezoelectric (quartz) crystals with built-in microelectronics are common. Both impulsive forces and slowly varying forces can be monitored using these sensors.

Of the available force measuring techniques, a general subgroup can be defined as that of load cells. Load cells are comprised generally of a rigid outer structure, some medium that is used for measuring the applied force, and the measuring gage. Load cells are used for sensing large, static, or slowly varying forces with little deflection and are a relatively accurate means of sensing forces. Typical accuracies are of the order of 0.1% of the full-scale readings. Various strategies can be employed for measuring forces that are strongly dependent on the design of the load cell. For example, [Fig. 19.31](#) illustrates different types of load cells that can be employed in sensing large forces for relatively little cost. The hydraulic load cell employs a very stiff outer structure with an internal cavity filled with a fluid. Application of a load increases the oil pressure, which can be read off an accurate gage.

Other sensing techniques can be utilized to monitor forces, such as piezoelectric transducers for quicker response of varying loads, pneumatic methods, strain gages, etc. The proper sensing technique needs special consideration based on the conditions required for monitoring.

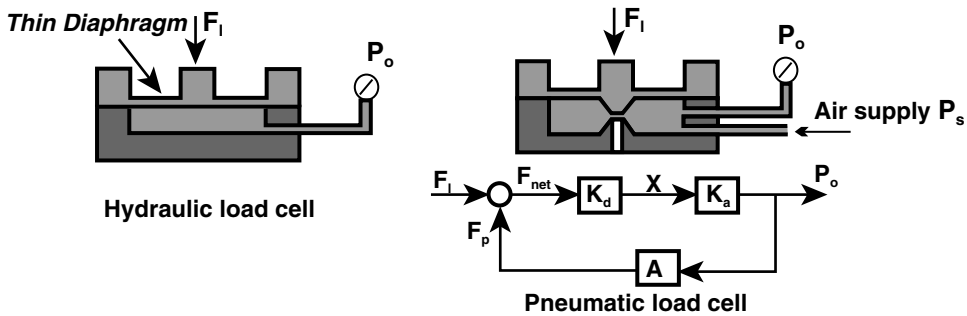

FIGURE 19.31 Different types of load cells [2].

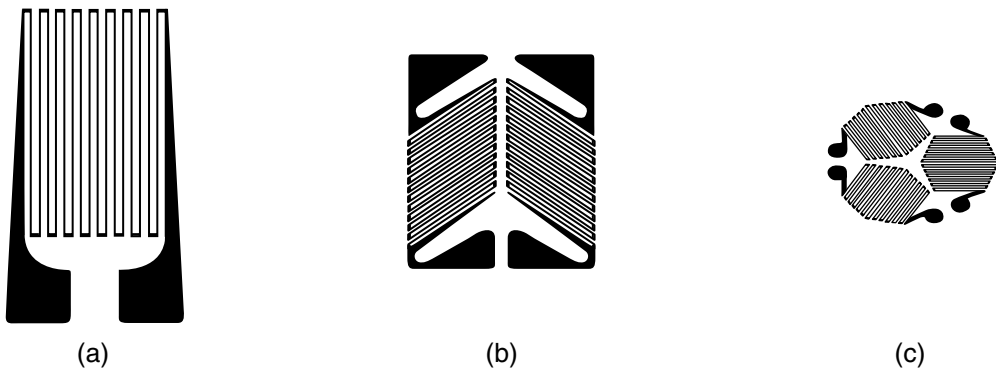

FIGURE 19.32 Configuration of metal-foil resistance strain gages: (a) single element, (b) two element, and (c) three element.

Strain Gage Load Cell

The strain gage load cell consists of a structure that elastically deforms when subjected to a force and a strain gage network that produces an electrical signal proportional to this deformation. Examples of this are beam and ring types of load cells.

Strain Gages

Strain gages use a length of gage wire to produce the desired resistance (which is usually about $120\ \Omega$) in the form of a flat coil. This coil is then cemented (bonded) between two thin insulating sheets of paper or plastic. Such a gage cannot be used directly to measure deflection. It has to be first fixed properly to a member to be strained. After bonding the gage to the member, they are baked at about 195°F (90°C) to remove moisture. Coating the unit with wax or resin will provide some mechanical protection. The resistance between the member under test and the gage itself must be at least $50\ \text{M}\Omega$. The total area of all conductors must remain small so that the cement can easily transmit the force necessary to deform the wire. As the member is stressed, the resulting strain deforms the strain gage and the cross-sectional area diminishes. This causes an increase in resistivity of the gage that is easily determined. In order to measure very small strains, it is necessary to measure small changes of the resistance per unit resistance ($\Delta R/R$). The change in the resistance of a bonded strain gage is usually less than 0.5%. A wide variety of gage sizes and grid shapes are available, and typical examples are shown in Fig. 19.32.

The use of strain gages to measure force requires careful consideration with respect to rigidity and environment. By virtue of their design, strain gages of shorter length generally possess higher response frequencies (examples: 660 kHz for a gage of 0.2 mm and 20 kHz for a gage of 60 mm in length). The environmental considerations focus mainly on the temperature of the gage. It is well known that resistance is a function of temperature and, thus, strain gages are susceptible to variations in temperature.

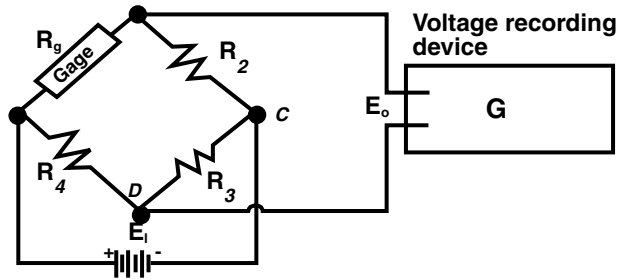

FIGURE 19.33 The Wheatstone bridge.

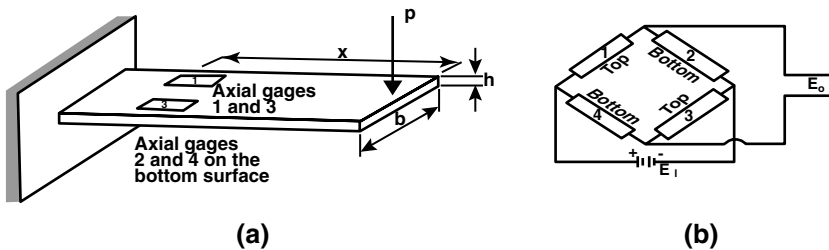

FIGURE 19.34 Beam-type load cells: (a) a selection of beam-type load cells (elastic element with strain gages), and (b) gage positions in the Wheatstone bridge [3].

Thus, if it is known that the temperature of the gage will vary due to any influence, temperature compensation is required in order to ensure that the force measurement is accurate.

A Wheatstone bridge (Fig. 19.33) is usually used to measure this small order of magnitude. In Fig. 19.33, no current will flow through the galvanometer (G) if the four resistances satisfy a certain condition. In order to demonstrate how a Wheatstone bridge operates [3], a voltage scale has been drawn at points C and D of Fig. 19.33. Assume that R_1 is a bonded gage and that initially Eq. (19.47) is satisfied. If R_1 is now stretched so that its resistance increases by one unit ($+\Delta R$), the voltage at point D will be increased from zero to plus one unit of voltage ($+\Delta V$), and there will be a voltage difference of one unit between C and D that will give rise to a current through C. If R_4 is also a bonded gage, and at the same time that R_1 changes by $+\Delta R$, R_4 changes by $-\Delta R$, the voltage at D will move to $+2\Delta V$. Also, if at the same time, R_2 changes by $-\Delta R$, and R_3 changes by $+\Delta R$, then the voltage of point C will move to $-2\Delta V$, and the voltage difference between C and D will now be $4\Delta V$. It is then apparent that although a single gage can be used, the sensitivity can be increased fourfold if two gages are used in tension while two others are used in compression.

$$\frac{R_1}{R_4} = \frac{R_2}{R_3} \quad (19.47)$$

The grid configuration of the metal-foil resistance strain gages is formed by a photo-etching process. The shortest gage available is 0.20 mm; the longest is 102 mm. Standard gage resistances are 120 Ω and 350 Ω . A strain gage exhibits a resistance change $\Delta R/R$ that is related to the strain in the direction of the grid lines by the expression in Eq. (19.48) (where S_g is the gage factor or calibration constant for the gage).

$$\frac{\Delta R}{R} = S_g \epsilon \quad (19.48)$$

Beam-Type Load Cell

Beam-type load cells are commonly employed for measuring low-level loads [3]. A simple cantilever beam (see Fig. 19.34(a)) with four strain gages, two on the top surface and two on the bottom surface (all oriented along the axis of the beam) is used as the elastic member (sensor) for the load cell. The gages

are wired into a Wheatstone bridge as shown in Fig. 19.34(b). The load P produces a moment $M = Px$ at the gage location (x) that results in the following strains:

$$\epsilon_1 = -\epsilon_2 = \epsilon_3 = -\epsilon_4 = \frac{6M}{Ebh^2} = \frac{6Px}{Ebh^2} \quad (19.49)$$

where b is the width of the cross-section of the beam and h is the height of the cross-section of the beam. Thus, the response of the strain gages is obtained from Eq. (19.50).

$$\frac{\Delta R_1}{R_1} = -\frac{\Delta R_2}{R_2} = \frac{\Delta R_3}{R_3} = -\frac{\Delta R_4}{R_4} = \frac{6S_g Px}{Ebh^2} \quad (19.50)$$

The output voltage E_o from the Wheatstone bridge, resulting from application of the load P , is obtained from Eq. (19.51). If the four strain gages on the beam are assumed to be identical, then Eq. (19.51) holds.

$$E_o = \frac{6S_g Px E_1}{Ebh^2} \quad (19.51)$$

The range and sensitivity of a beam-type load cell depends on the shape of the cross-section of the beam, the location of the point of application of the load, and the fatigue strength of the material from which the beam is fabricated.

Ring-Type Load Cell

Ring-type load cells incorporate a proving ring (see Fig. 19.35) as the elastic element. The ring element can be designed to cover a very wide range of loads by varying the diameter D , the thickness t , or the depth w of the ring. Either strain gages or a linear variable-differential transformer (LVDT) can be used as the sensor.

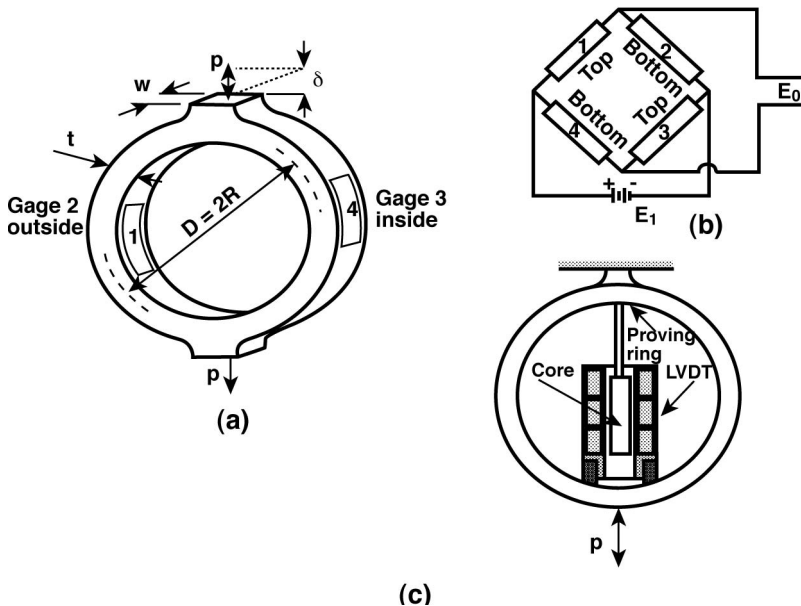

FIGURE 19.35 Ring-type load cells: (a) elastic element with strain-gage sensors; (b) gage positions in the Wheatstone bridge; and (c) elastic element with an LVDT sensor [3].

The load P is linearly proportional to the output voltage E_o . The sensitivity of the ring-type load cell with an LVDT sensor depends on the geometry of the ring (R , t , and w), the material from which the ring is fabricated (E), and the characteristics of the LVDT (S and E_i). The range of a ring-type load cell is controlled by the strength of the material used in fabricating the ring.

Piezoelectric Methods

A piezoelectric material exhibits a phenomenon known as the *piezoelectric effect*. This effect states that when asymmetrical, elastic crystals are deformed by a force, an electrical potential will be developed within the distorted crystal lattice. This effect is reversible. That is, if a potential is applied between the surfaces of the crystal, it will change its physical dimensions [4]. Elements exhibiting piezoelectric qualities are sometimes known as electrorestrictive elements.

The magnitude and polarity of the induced surface charges are proportional to the magnitude and direction of the applied force [4]:

$$Q = dF \quad (19.52)$$

where d is the charge sensitivity (a constant for a given crystal) of the crystal in C/N . The force F causes a thickness variation Δt meters of the crystal:

$$F = \frac{aY}{t}\Delta t \quad (19.53)$$

where a is area of crystal, t is thickness of crystal, and Y is Young's modulus.

$$Y = \frac{\text{stress}}{\text{strain}} = \frac{Ft}{a\Delta t} \quad (19.54)$$

The charge at the electrodes gives rise to a voltage $E_o = Q/C$, where C is capacitance in farads between the electrodes and $C = \epsilon a/t$ where ϵ is the absolute permittivity.

$$E_o = \frac{dF}{C} = \frac{dtF}{\epsilon a} \quad (19.55)$$

The voltage sensitivity $= g = d/\epsilon$ in volt meter per newton can be obtained as:

$$E_o = g\frac{t}{a}F = gtP \quad (19.56)$$

The piezoelectric materials used are quartz, tourmaline, Rochelle salt, ammonium dihydrogen phosphate (ADP), lithium sulfate, barium titanate, and lead zirconate titanate (PZT) [4]. Quartz and other earthly piezoelectric crystals are naturally polarized. However, synthetic piezoelectric material, such as barium titanate ceramic, are made by baking small crystallites under pressure and then placing the resultant material in a strong dc electric field [4]. After that, the crystal is polarized, along the axis on which the force will be applied, to exhibit piezoelectric properties. Artificial piezoelectric elements are free from the limitations imposed by the crystal structure and can be molded into any size and shape. The direction of polarization is designated during their production process.

The different modes of operation of a piezoelectric device for a simple plate are shown in Fig. 19.36 [4]. By adhering two crystals together so that their electrical axes are perpendicular, bending moments or torque can be applied to the piezoelectric transducer and a voltage output can be produced (Fig. 19.37) [4]. The range of forces that can be measured using piezoelectric transducers are from 1 to 200 kN and at a ratio of 2×10^5 .

Piezoelectric crystals can also be used in measuring an instantaneous change in the force (dynamic forces). A thin plate of quartz can be used as an electronic oscillator. The frequency of these oscillations will be dominated by the natural frequency of the thin plate. Any distortion in the shape of the plate

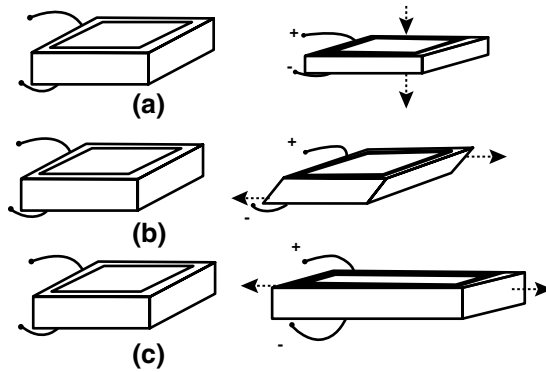

FIGURE 19.36 Modes of operation for a simple plate as a piezoelectric device [4].

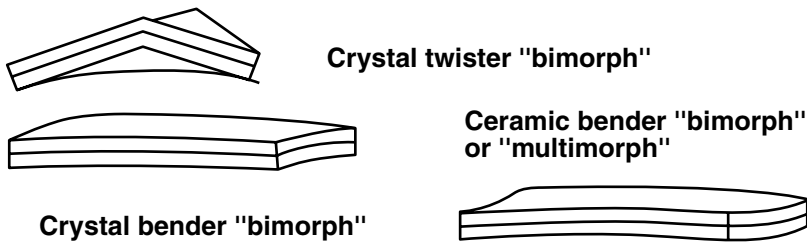

FIGURE 19.37 Curvature of “twister” and “bender” piezoelectric transducers when voltage applied [4].

caused by an external force, alters the oscillation frequency. Hence, a dynamic force can be measured by the change in frequency of the oscillator.

Resistive Method

The resistive method employs the fact that when the multiple contact area between semiconducting particles (usually carbon) and the distance between the particles are changed, the total resistance is altered. The design of such transducers yields a very small displacement when a force is applied. A transducer might consist of 2–60 thin carbon disks mounted between a fixed and a movable electrode. When a force is applied to the movable electrode and the carbon disks move together by 5–250 μm per interface, the transfer function of their resistance against the applied force is approximately hyperbolic, that is, highly nonlinear. The device is also subject to large hysteresis and drift together with a high transverse sensitivity.

In order to reduce hysteresis and drift, rings are used instead of disks. The rings are mounted on an insulated rigid core and prestressed. This almost completely eliminates any transverse sensitivity error. The core’s resonant frequency is high and can occur at a frequency as high as 10 kHz. The possible measuring range of such a transducer is from 0.1 to 10 kg. The accuracy and linear sensitivity of this transducer is very poor.

Inductive Method

The inductive method utilizes the fact that a change in mechanical stress of a ferromagnetic material causes its permeability to alter. The changes in magnetic flux are converted into induced voltages in the pickup coils as the movement takes place. This phenomenon is known as the *Villari effect* or *magnetostriction*. It is known to be particularly strong in nickel–iron alloys.

Transducers utilizing the Villari effect consist of a coil wound on a core of magnetostrictive material. The force to be measured is applied on this core, stressing it and causing a change in its permeability and inductance. This change can be monitored and used for determining the force.

The applicable range for this type of transducer is a function of the cross-sectional area of the core. The accuracy of the device is determined by a calibration process. This transducer has poor linearity and is subject to hysteresis. The permeability of a magnetostrictive material increases when it is subject to pure torsion, regardless of direction. A flat frequency response is obtained over a wide range from 150 to 15,000 Hz.

Piezotransistor Method

Devices that utilize *anisotropic stress effects* are described as piezotransistors. In this effect, if the upper surface of a *p-n* diode is subjected to a localized stress, a significant reversible change occurs in the current across the junction. These transistors are usually silicon nonplanar type, with an emitter base junction. This junction is mechanically connected to a diaphragm positioned on the upper surface of a typical TO-type can [4]. When a pressure or a force is applied to the diaphragm, an electronic charge is produced. It is advisable to use these force-measuring devices at a constant temperature by virtue of the fact that semiconducting materials also change their electric properties with temperature variations. The attractive characteristic of piezotransistors is that they can withstand a 500% overload.

Multicomponent Dynamometers Using Quartz Crystals as Sensing Elements

The Piezoelectric Effects in Quartz

For force measurements, the *direct piezoelectric effect* is utilized. The direct longitudinal effect measures compressive force; the direct shear effect measures shear force in one direction. For example, if a disk of crystalline quartz (SiO_2) cut normally to the crystallographic *x*-axis is loaded by a compression force, it will yield an electric charge, nominally 2.26 pC/N. If a disk of crystalline quartz is cut normally to the crystallographic *y*-axis, it will yield an electric charge (4.52 pC/N) if loaded by a shear force in one specific direction. Forces applied in the other directions will not generate any output [5].

A charge amplifier is used to convert the charge yielded by a quartz crystal element into a proportional voltage. The range of a charge amplifier with respect to its conversion factor is determined by a feedback capacitor. Adjustment to mechanical units is obtained by additional operational amplifiers with variable gain.

The Design of Quartz Multicomponent Dynamometers

The main element for designing multicomponent dynamometers is the three-component force transducer (Fig. 19.38). It contains a pair of X-cut quartz disks for the normal force component and a pair of Y-cut quartz disks (shear-sensitive) for each shear force component.

Three-component dynamometers can be used for measuring cutting forces during machining. Four three-component force transducers sandwiched between a base plate and a top plate are shown in Fig. 19.38. The force transducer is subjected to a preload as shear forces are transmitted by friction. The four force transducers experience a drastic change in their load, depending on the type and position of force application. An overhanging introduction of the force develops a tensile force for some transducers, thus reducing the preload. Bending of the dynamometer top plate causes bending and shearing stresses. The measuring ranges of a dynamometer depend not only on the individual forces, but also on the individual bending stresses.

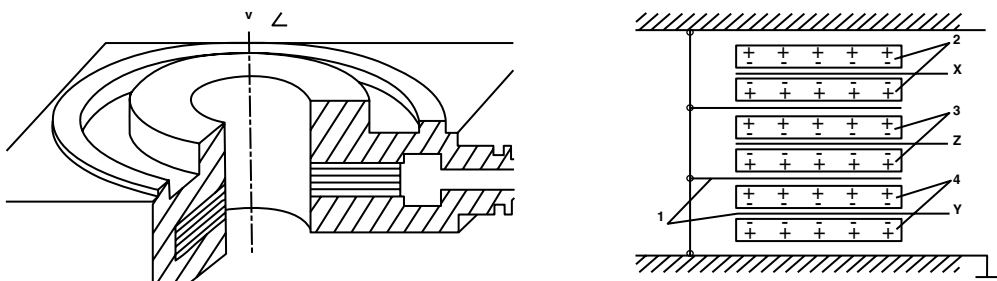

FIGURE 19.38 Three-component force transducer.

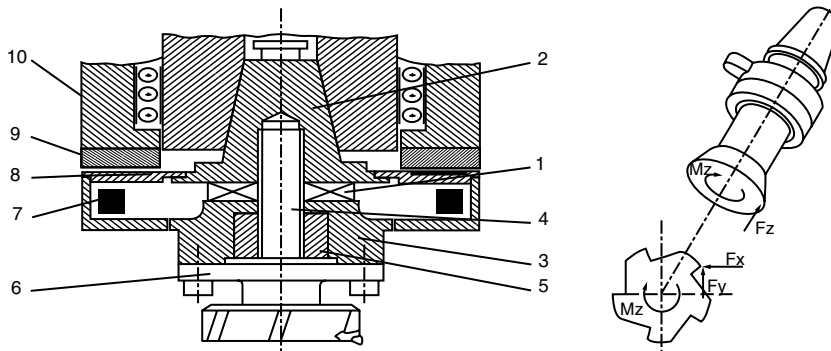

FIGURE 19.39 Force measuring system to determine the tool-related cutting forces in five-axis milling [6].

Measuring Signals Transmitted by Telemetry

Figure 19.39 shows the newly designed force measuring system RCD (rotating cutting force dynamometer). A ring-shaped sensor (1) is fitted in a steep angle taper socket (2) and a base ring (3) allowing sensing of the three force components F_x , F_y , and F_z at the cutting edge as well as the moment M_z . The physical operating principle of this measuring cell is based on the piezoelectric effect in quartz plates. The quartz plates incorporated in the sensor are aligned so that the maximum cross-sensitivity between the force components is 1%. As a result of the rigid design of the sensor, the resonant frequencies of the force measuring system range from 1200 to 3000 Hz and the measuring ranges cover a maximum of 10 kN [6].

Force-proportional charges produced at the surfaces of the quartz plates are converted into voltages by four miniature charge amplifiers (7) in hybrid construction. These signals are then filtered by specific electrical circuitry to prevent aliasing effects, and digitized with 8-bit resolution using a high sampling rate (pulse-code modulation). The digitized signals are transmitted by a telemetric unit consisting of a receiver and transmitter module, an antenna at the top of the rotating force measuring system (8), as well as a fixed antenna (9) on the splash cover of the two-axis milling head (10). The electrical components, charge amplifier, and transmitter module are mounted on the circumference of the force measuring system [6].

The cutting forces and the moment measured are digitized with the force measuring system described above. They are modulated on an FM carrier and transmitted by the rotating transmitter to the stationary receiver. The signals transmitted are fed to an external measured-variable conditioning unit.

Measuring Dynamic Forces

Any mechanical system can be considered in the first approximation as a weakly damped oscillator consisting of a spring and a mass. If a mechanical system has more than one resonant frequency, the lowest one must be taken into consideration. As long as the test frequency remains below 10% of the resonant frequency of the reference transducer (used for calibration), the difference between the dynamic sensitivity obtained from static calibration will be less than 1%. The above considerations assume a sinusoidal force signal. The static calibration of a reference transducer is also valid for dynamic calibration purposes if the test frequency is much lower (at least 10 times lower) than the resonant frequency of the system.

Capacitive Force Transducer

A transducer that uses capacitance variation can be used to measure force. The force is directed onto a membrane whose elastic deflection is detected by a capacitance variation. A highly sensitive force transducer can be constructed because the capacitive transducer senses very small deflections accurately. An electronic circuit converts the capacitance variations into DC-voltage variations [7].

A capacitance sensor consists of two metal plates separated by an air gap. The capacitance C between terminals is given by the expression:

$$C = \epsilon_0 \epsilon_r \frac{A}{h} \quad (19.57)$$

where

- C = capacitance in farads (F),
- ϵ_0 = dielectric constant of free space,
- ϵ_r = relative dielectric constant of the insulator,
- A = overlapping area for the two plates,
- h = thickness of the gap between the two plates.

The sensitivity of capacitance-type sensors is inherently low. Theoretically, decreasing the gap h should increase the sensitivity; however, there are practical electrical and mechanical conditions that preclude high sensitivities. One of the main advantages of the capacitive transducer is that moving of one of its plates relative to the other requires an extremely small force to be applied. A second advantage is stability and the sensitivity of the sensor is not influenced by pressure or temperature of the environment.

Force Sensing Resistors (Conductive Polymers)

Force sensing resistors (FSRs) utilize the fact that certain polymer thick-film devices exhibit decreasing resistance with the increase of an applied force. A force sensing resistor is made up of two parts. The first is a resistive material applied to a film. The second is a set of digitating contacts applied to another film. [Figure 19.40](#) shows this configuration. The resistive material completes the electrical circuit between the two sets of conductors on the other film. When a force is applied to this sensor, a better connection is made between the contacts; hence, the conductivity is increased. Over a wide range of forces, it turns out that the conductivity is approximately a linear function of force. [Figure 19.41](#) shows the resistance of the sensor as a function of force. It is important to note that there are three possible regions for the sensor to operate. The first abrupt transition occurs somewhere in the vicinity of 10 g of force. In this region, the resistance changes very rapidly. This behavior is useful when one is designing switches using force sensing resistors.

FSRs should not be used for accurate measurements of force because sensor parts may exhibit 15–25% variation in resistance between each other. However, FSRs exhibit little hysteresis and are considered far less costly than other sensing devices. Compared to piezofilm, the FSR is far less sensitive to vibration and heat.

Magneto-resistive Force Sensors

The principle of *magneto-resistive force sensors* is based on the fact that metals, when cooled to low temperatures, show a change of resistivity when subjected to an applied magnetic field. Bismuth, in particular, is quite sensitive in this respect. In practice, these devices are severely limited because of their high sensitivity to ambient temperature changes.

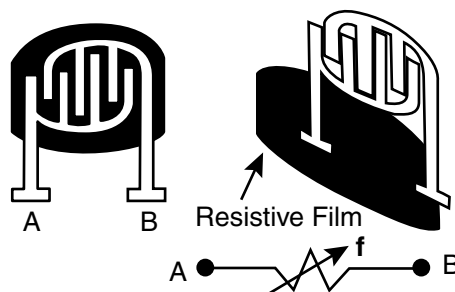

FIGURE 19.40 Diagram of a typical force sensing resistor (FSR).

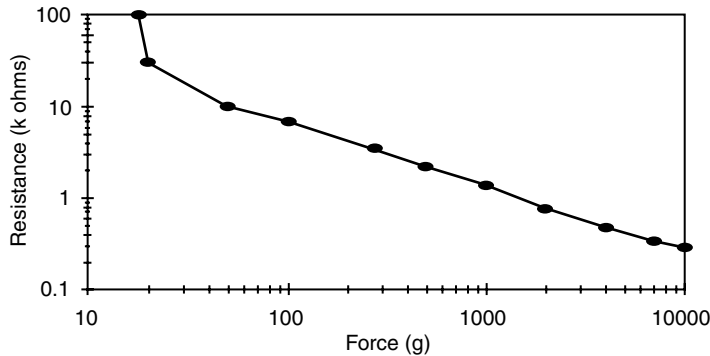

FIGURE 19.41 Resistance as a function of force for a typical force sensing resistor.

Magnetoelastic Force Sensors

Magnetoelastic transducer devices operate based on the Joule effect, that is, a ferromagnetic material is dimensionally altered when subjected to a magnetic field. The principle of operation is as follows: Initially, a current pulse is applied to the conductor within the waveguide. This sets up a magnetic field circumference-wise around the waveguide over its entire length. There is another magnetic field generated by the permanent magnet that exists only where the magnet is located. This field has a longitudinal component. These two fields join vectorially to form a helical field near the magnet which, in turn, causes the waveguide to experience a minute torsional strain or twist only at the location of the magnet. This twist effect is known as the *Wiedemann effect* [8].

Magnetoelastic force transducers have a high frequency response (on the order of 20 kHz). Some of the materials that exhibit magnetoelastic include Monel metal, Permalloy, Cekas, Alfer, and a number of nickel–iron alloys. Disadvantages of these transducers include: (1) the fact that excessive stress and aging may cause permanent changes, (2) zero drift and sensitivity changes due to temperature sensitivity, and (3) hysteresis errors.

Torsional Balances

Balancing devices that utilize the deflection of a spring may also be used to determine forces. *Torsional balances* are equal arm-scale-force measuring devices. They are comprised of horizontal steel bands instead of pivots and bearings. The principle of operation is based on force application on one of the arms that will deflect the torsional spring (within its design limits) in proportion to the applied force. This type of instrument is susceptible to hysteresis and temperature errors and, therefore, is not used for precise measurements.

Tactile Sensors

Tactile sensors are usually interpreted as a touch sensing technique. Tactile sensors cannot be considered as simple touch sensors, where very few discrete force measurements are made. In tactile sensing, a force “distribution” is measured using a closely spaced array of force sensors.

Tactile sensing is important in both grasping and object identification operations. Grasping an object must be done in a stable manner so that the object is not allowed to slip or get damaged. Object identification includes recognizing the shape, location, and orientation of a product, as well as identifying surface properties and defects. Ideally, these tasks would require two types of sensing [9]:

1. continuous sensing of contact forces,
2. sensing of the surface deformation profile.

These two types of data are generally related through stress–strain relations of the tactile sensor. As a result, almost continuous variable sensing of tactile forces (the sensing of the tactile deflection profile) is achieved.

Tactile Sensor Requirements

Significant advances in tactile sensing are taking place in the robotics area. Applications include automated inspection of surface profiles, material handling or parts transfer, parts assembly, and parts identification and gaging in manufacturing applications and fine-manipulation tasks. Some of these applications may need only simple touch (force–torque) sensing if the parts being grasped are properly oriented and if adequate information about the process is already available.

Naturally, the main design objective for tactile sensing devices has been to mimic the capabilities of human fingers [9]. Typical specifications for an industrial tactile sensor include:

1. Spatial resolution of about 2 mm
2. Force resolution (sensitivity) of about 2 g
3. Maximum touch force of about 1 kg
4. Low response time of 5 ms
5. Low hysteresis
6. Durability under extremely difficult working conditions
7. Insensitivity to change in environmental conditions (temperature, dust, humidity, vibration, etc.)
8. Ability to monitor slip

Tactile Array Sensor

Tactile array sensors (Fig. 19.42) consist of a regular pattern of sensing elements to measure the distribution of pressure across the fingertip of a robot. The 8 × 8 array of elements at 2 mm spacing in each direction provides 64 force sensitive elements. Table 19.2 outlines some of the characteristics of early tactile array sensors. The sensor is composed of two crossed layers of copper strips separated by strips of thin silicone rubber. The sensor forms a thin, compliant layer that can be easily attached to a variety of fingertip shapes and sizes. The entire array is sampled by computer.

TABLE 19.2 Summary of Some of the Characteristics of Early Tactile Array Sensors

| Device Parameter | Size of Array | | |
|--------------------------------|---------------|---------|-----------|
| | (4 × 4) | (8 × 8) | (16 × 16) |
| Cell spacing (mm) | 4.00 | 2.00 | 1.00 |
| Zero-pressure capacitance (fF) | 6.48 | 1.62 | 0.40 |
| Rupture force (N) | 18.90 | 1.88 | 0.19 |
| Max. linear capacitance (fF) | 4.80 | 1.20 | 0.30 |
| Max. output voltage (V) | 1.20 | 0.60 | 0.30 |
| Max. resolution (bit) | 9.00 | 8.00 | 8.00 |
| Readout (access) time (μs) | — | <20 | — |

©IEEE 1985.

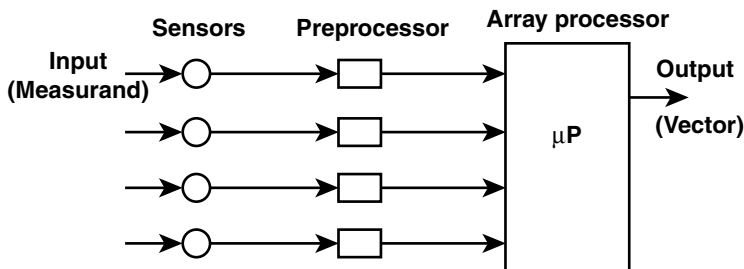

FIGURE 19.42 Tactile array sensor.

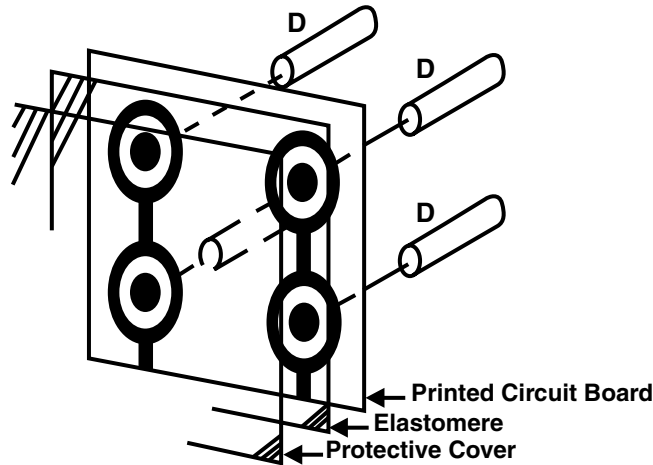

FIGURE 19.43 Typical taxel sensor array.

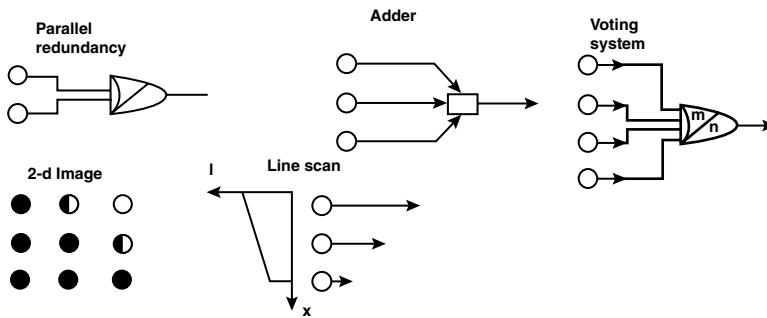

FIGURE 19.44 General arrangement of an intelligent sensor array system [9].

A typical tactile sensor array can consist of several sensing elements. Each element or taxel (Fig. 19.43) is used to sense the forces present. Since tactile sensors are implemented in applications where sensitivity providing semblance to human touch is desired, an elastomer is utilized to mimic the human skin. The elastomer is generally a conductive material whose electrical conductivity changes locally when pressure is applied. The sensor itself consists of three layers: a protective covering, a sheet of conductive elastomer, and a printed circuit board. The printed circuit board consists of two rows of two “bullseyes,” each with conductive inner and outer rings that compromise the taxels of the sensor. The outer rings are connected together and to a column-select transistor. The inner rings are connected to diodes (D) in Fig. 19.43. Once the column in the array is selected, the current flows through the diodes, through the elastomer, and thence through a transistor to ground. As such, it is generally not possible to excite just one taxel because the pressure applied causes a local deformation in neighboring taxels. This situation is called *crossstalk* and is eliminated by the diodes [10].

Tactile array sensor signals are used to provide information about the contact kinematics. Several feature parameters, such as contact location, object shape, and the pressure distribution, can be obtained. The general layout of a sensor array system can be seen in Fig. 19.44. An example of this is a contact and force sensing finger. This tactile finger has four contact sensors made of piezoelectric polymer strips on the surface of the fingertip that provide dynamic contact information. A strain gage force sensor provides static grasp force information.

References

1. Shaw, M. C., *Metal Cutting Principles*, Oxford: Oxford Science Publications, Clarendon Press, 1989.
2. Doebelin, E. O., *Measurement Systems, Application and Design*, 4th ed., New York: McGraw-Hill, 1990.
3. Dally, J. W., Riley, W. F., and McConnel, K. G., *Instrumentation for Engineering Measurements*, New York: John Wiley & Sons, 1984.
4. Mansfield, P. H., *Electrical Transducers for Industrial Measurement*, London: The Butterworth Group, 1973.
5. Martini, K. H., Multicomponent dynamometers using quartz crystals as sensing elements, *ISA Trans.*, 22(1), 1983.
6. Spur, G., Al-Badrawy, S. J., and Stirnimann, J., Measuring the Cutting Force in Five-Axis Milling, Translated paper "Zerpankraftmessung bei der funfachsigen Frasbearbeitung," *Zeitschrift fur wirtschaftliche Fertigung und Automatisierung* 9/93 Carl Hanser, Munchen, Kistler Piezo-Instrumentation, 20.162e 9.94.
7. Nachtigal, C. L., *Instrumentation and Control, Fundamentals and Applications*, Wiley Series in Mechanical Engineering Practice, New York: Wiley Interscience, John Wiley & Sons, 1990.
8. DeSilva, C. W., *Control Sensors and Actuators*, Englewood Cliffs, NJ: Prentice-Hall, 1989.
9. Gardner, J. W., *Microsensors Principles and Applications*, New York: John Wiley & Sons, 1995.
10. Stadler, W., *Analytical Robotics and Mechatronics*, New York: McGraw-Hill, 1995.

Further Information

- Wright, C. P., *Applied Measurement Engineering, How to Design Effective Mechanical Measurement Systems*, Englewood Cliffs, NJ: Prentice Hall, 1995.
- Herceg, E. E., *Handbook of Measurement and Control*, Pennsauken, NJ: Schavitz Engineering, 1972.
- Considine, D. M., *Encyclopedia of Instrumentation and Control*, New York: McGraw-Hill, 1971.
- Norton, H. N., *Sensor and Analyzer Handbook*, Englewood Cliffs, NJ: Prentice-Hall, 1982.
- Sze, S. M., *Semiconductor Sensors*, New York: John Wiley & Sons, 1994
- Lindberg, B., and Lindstrom, B., Measurements of the segmentation frequency in the chip formation process, *Ann. CIRP*, 32(1), 1983.
- Tlusty, J., and Andrews, G. C., A critical review of sensors for unmanned machining, *Ann. CIRP*, 32(2), 1983.

19.4 Torque and Power Measurement

Ivan J. Garshelis

Torque, speed, and power are the defining mechanical variables associated with the functional performance of rotating machinery. The ability to accurately measure these quantities is essential for determining a machine's efficiency and for establishing operating regimes that are both safe and conducive to long and reliable services. Online measurements of these quantities enable real-time control, help ensure consistency in product quality, and can provide early indications of impending problems. Torque and power measurements are used in testing advanced designs of new machines and in the development of new machine components. Torque measurements also provide a well-established basis for controlling and verifying the tightness of many types of threaded fasteners. This chapter describes the basic concepts as well as the various methods and apparatus in current use for the measurement of torque and power; the measurement of speed, or more precisely, angular velocity, is discussed elsewhere [1].

Fundamental Concepts

Angular Displacement, Velocity, and Acceleration

The concept of *rotational* motion is readily formalized: all points within a rotating rigid body move in parallel or coincident planes while remaining at fixed distances from a line called the *axis*. In a perfectly rigid body, all points also remain at fixed distances from each other. Rotation is perceived as a change in the angular position of a reference point on the body, i.e., as its *angular displacement*, $\Delta\theta$, over some time interval, Δt . The motion of that point, and therefore of the whole body, is characterized by its clockwise (CW) or counterclockwise (CCW) *direction* and by its *angular velocity*, $\omega = \Delta\theta/\Delta t$. If during a time interval Δt , the velocity changes by $\Delta\omega$, the body is undergoing an *angular acceleration*, $\alpha = \Delta\omega/\Delta t$. With angles measured in radians, and time in seconds, units of ω become radians per second (rad s^{-1}) and of α , radians per second per second (rad s^{-2}). Angular velocity is often referred to as *rotational speed* and measured in numbers of complete revolutions per minute (rpm) or per second (rps).

Force, Torque, and Equilibrium

Rotational motion, as with motion in general, is controlled by *forces* in accordance with Newton's laws. Because a force directly affects only that component of motion in its line of action, forces or components of forces acting in any plane that includes the axis produce no tendency for rotation about that axis. Rotation can be initiated, altered in velocity, or terminated only by a *tangential force* F_t acting at a finite radial distance l from the axis. The effectiveness of such forces increases with both F_t and l ; hence, their product, called a *moment*, is the activating quantity for rotational motion. A moment about the rotational axis constitutes a *torque*. Figure 19.45(a) shows a force F acting at an angle β to the tangent at a point P , distant l (the moment arm) from the axis. The torque T is found from the *tangential component* of F as

$$T = F_t l = (F \cos \beta) l \quad (19.58)$$

The combined effect, known as the *resultant*, of any number of torques acting at different locations along a body is found from their *algebraic sum*, wherein torques tending to cause rotation in CW and CCW directions are assigned opposite signs. Forces, hence torques, arise from physical contact with other solid bodies, motional interaction with fluids, or via gravitational (including inertial), electric, or magnetic force fields. The *source* of each such torque is subjected to an equal, but oppositely directed, *reaction* torque. With force measured in newtons and distance in meters, Eq. (19.58) shows the unit of torque to be a Newton meter (Nm).

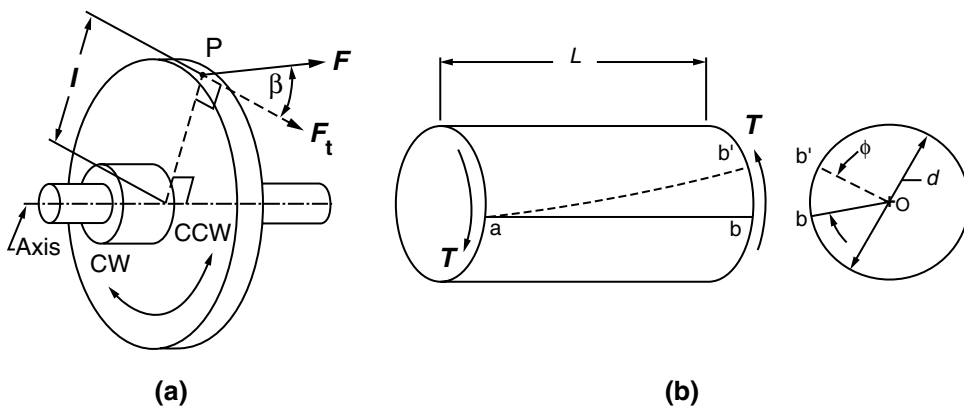

FIGURE 19.45 (a) The off-axis force F at P produces a torque $T = (F \cos \beta)l$ tending to rotate the body in the CW direction. (b) Transmitting torque T over length L twists the shaft through angle ϕ .

A nonzero resultant torque will cause the body to undergo a proportional angular acceleration, found, by application of Newton's second law, from

$$T_r = I\alpha \quad (19.59)$$

where I , having units of kilogram square meter (kg m^2), is the moment of inertia of the body around the axis (i.e., its *polar* moment of inertia). Equation (19.59) is applicable to any body regardless of its state of motion. When $\alpha = 0$, Eq. (19.59) shows that T_r is also zero; the body is said to be in *equilibrium*. For a body to be in equilibrium, there must be either more than one *applied* torque, or none at all.

Stress, Rigidity, and Strain

Any portion of a rigid body in equilibrium is also in equilibrium; hence, as a condition for equilibrium of the portion, any torques applied thereto from *external* sources must be balanced by equal and directionally opposite *internal* torques from adjoining portions of the body. Internal torques are *transmitted* between adjoining portions by the collective action of *stresses* over their common cross-sections. In a solid body having a round cross-section (e.g., a typical shaft), the *shear stress* τ varies linearly from zero at the axis to a maximum value at the surface. The shear stress, τ_m , at the surface of a shaft of diameter, d , transmitting a torque, T , is found from

$$\tau_m = \frac{16T}{\pi d^3} \quad (19.60)$$

Real materials are not *perfectly* rigid but have instead a *modulus of rigidity*, G , which expresses the finite ratio between τ and *shear strain*, γ . The maximum strain in a solid round shaft therefore also exists at its surface and can be found from

$$\gamma_m = \frac{\tau_m}{G} = \frac{16T}{\pi d^3 G} \quad (19.61)$$

Figure 19.45(b) shows the manifestation of shear strain as an angular displacement between axially separated cross sections. Over the length L , the solid round shaft shown will be *twisted* by the torque through an angle ϕ found from

$$\phi = \frac{32LT}{\pi d^4 G} \quad (19.62)$$

Work, Energy, and Power

If during the time of application of a torque, T , the body rotates through some angle θ , mechanical work

$$W = T\theta \quad (19.63)$$

is performed. If the torque acts in the same CW or CCW sense as the displacement, the work is said to be done *on* the body, or else it is done *by* the body. Work done *on* the body causes it to accelerate, thereby appearing as an increase in *kinetic energy* ($\text{KE} = I\omega^2/2$). Work done *by* the body causes deceleration with a corresponding decrease in kinetic energy. If the body is not accelerating, any work done on it at one location must be done by it at another location. Work and energy are each measured in units called a joule (J). Equation (19.63) shows that 1 J is equivalent to 1 Nm rad, which, since a radian is a dimensionless ratio, \equiv 1 Nm. To avoid confusion with torque, it is preferable to quantify mechanical work in units of mN, or better yet, in J.

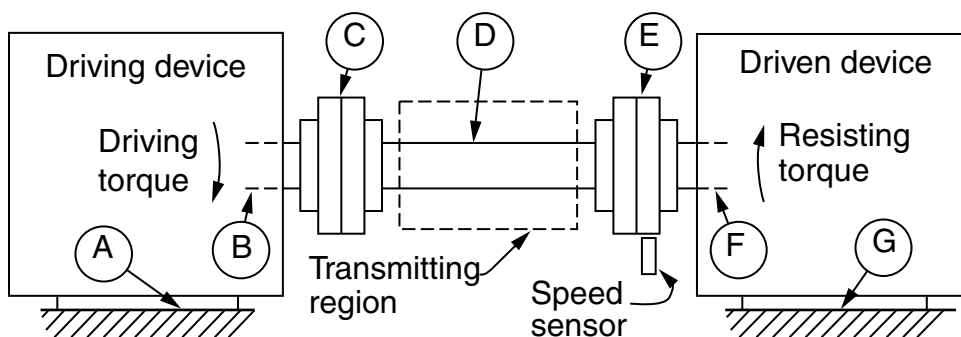

FIGURE 19.46 Schematic arrangement of devices used for the measurement of torque and power.

The *rate* at which work is performed is termed *power*, P . If a torque T acts over a small interval of time Δt , during which there is an angular displacement $\Delta\theta$, work equal to $T\Delta\theta$ is performed at the rate $T\Delta\theta/\Delta t$. Replacing $\Delta\theta/\Delta t$ by ω , power is found simply as

$$P = T\omega \quad (19.64)$$

The unit of power follows from its definition and is given the special name watt (W). $1 \text{ W} = 1 \text{ J s}^{-1} = 1 \text{ mN s}^{-1}$. Historically, power has also been measured in horsepower (Hp), where $1 \text{ Hp} = 746 \text{ W}$. Rotating bodies effectively transmit power between locations where torques from external sources are applied.

Arrangements of Apparatus for Torque and Power Measurement

Equations (19.58) through (19.64) express the physical bases for torque and power measurement. Figure 19.46 illustrates a generalized measurement arrangement. The actual apparatus used is selected to fulfill the specific measurement purposes. In general, a driving torque originating within a device at one location (B in Fig. 19.46) is resisted by an opposing torque developed by a different device at another location (F). The driving torque (from, e.g., an electric motor, a gasoline engine, a steam turbine, muscular effort, etc.) is coupled through connecting members C, transmitting region D, and additional couplings, E, to the driven device (an electric generator, a pump, a machine tool, mated threaded fasteners, etc.) within which the resisting torque is met at F. The torque at B or F is the quantity to be measured. These torques may be *indirectly* determined from a correlated physical quantity, e.g., an electrical current or fluid pressure associated with the operation of the driving or driven device, or more directly by measuring either the *reaction* torque at A or G, or the *transmitted* torque through D. It follows from the cause-and-effect relationship between torque and rotational motion that most interest in transmitted torque will involve rotating bodies.

To the extent that the frames of the driving and driven devices and their mountings to the “Earth” are *perfectly rigid*, the reaction at A will *at every instant* equal the torque at B, as will the reaction at G equal the torque at F. Under equilibrium conditions, these equalities are independent of the compliance of any member. Also under equilibrium conditions, and except for usually minor *parasitic* torques (due, e.g., to bearing friction and air drag over rapidly moving surfaces), the driving torque at B will equal the resisting torque at F.

Reaction torque at A or G is often determined, using Eq. (19.58), from measurements of the forces acting at known distances fixed by the apparatus. Transmitted torque is determined from measurements, on a suitable member within region D, of τ_m , γ_m , or ϕ and applying Eqs. (19.60)–(19.62) (or analogous expressions for members having other than solid round cross sections [2]). *Calibration*, the measurement of the stress, strain, or twist angle resulting from the application of a *known* torque, makes it unnecessary to know any details about the member within D. When $\alpha \neq 0$, and is measurable, T may

also be determined from Eq. (19.59). Requiring only noninvasive, observational measurements, this method is especially useful for determining transitory torques; for example those associated with firing events in multicylinder internal combustion engines [3].

Equations (19.63) and (19.64) are applicable *only* during rotation because, in the absence of motion, no work is done and power transfer is zero. Equation (19.63) can be used to determine *average* torque from calorimetric measurements of the heat generated (equal to the mechanical work W) during a totalized number of revolutions ($\equiv \theta/2\pi$). Equation (19.64) is routinely applied in power measurement, wherein T is determined by methods based on Eqs. (19.58), (19.60), (19.61), or (19.62), and ω is measured by any suitable means [4].

F , T , and ϕ are sometimes measured by simple mechanical methods. For example, a “torque wrench” is often used for the controlled tightening of threaded fasteners. In these devices, torque is indicated by the position of a needle moving over a calibrated scale in response to the elastic deflection of a spring member, in the simplest case, the bending of the wrench handle [5]. More generally, instruments, variously called *sensors* or *transducers*, are used to convert the desired (torque or speed related) quantity into a linearly proportional electrical signal. (Force sensors are also known as *load cells*.) The determination of P most usually requires multiplication of the two signals from separate sensors of T and ω . A transducer, wherein the amplitude of a *single* signal proportional to the power being transmitted along a shaft, has also been described [6].

Torque Transducer Technologies

Various physical interactions serve to convert F , τ , γ , or ϕ into proportional electrical signals. Each requires that some axial portion of the shaft be dedicated to the torque sensing function. Figure 19.47 shows typical features of sensing regions for four sensing technologies in present use.

Surface Strain

Figure 19.47(a) illustrates a sensing region configured to convert surface strain (γ_m) into an electrical signal proportional to the transmitted torque. Surface strain became the key basis for measuring both force and torque following the invention of bonded wire strain gages by E. E. Simmons, Jr. and Arthur C. Ruge in 1938 [7]. A modern strain gage consists simply of an elongated electrical conductor, generally formed in a serpentine pattern in a very thin foil or film, bonded to a thin insulating carrier. The carrier is attached, usually with an adhesive, to the surface of the load carrying member. Strain is sensed as a change in gage resistance. These changes are generally too small to be accurately measured directly and so it is common to employ two to four gages arranged in a Wheatstone bridge circuit. Independence from axial and bending loads as well as from temperature variations are obtained by using a four-gage bridge comprised of two diametrically opposite pairs of matched strain gages, each aligned along a *principal strain* direction. In round shafts (and other shapes used to transmit torque), tensile and compressive principal strains occur at 45° angles to the axis. Limiting strains, as determined from Eq. (19.61) (with τ_m equal to the shear proportional limit of the shaft material), rarely exceed a few parts in 10^3 . Typical practice is to increase the compliance of the sensing region (e.g., by reducing its diameter or with hollow or specially shaped sections) in order to attain the limiting strain at the highest value of the torque to be measured. This maximizes the measurement sensitivity.

Twist Angle

If the shaft is *slender* enough (e.g., $L > 5d$), ϕ , at limiting values of τ_m for typical shaft materials, can exceed 1° , enough to be resolved with sufficient accuracy for practical torque measurements (ϕ at τ_m can be found by manipulating Eqs. (19.60)–(19.62)). Figure 19.47(b) shows a common arrangement wherein torque is determined from the difference in tooth-space phasing between two identical “toothed” wheels attached at opposite ends of a compliant “torsion bar.” The phase displacement of the periodic electrical signals from the two “pickups” is proportional to the peripheral displacement of salient features on the two wheels, and hence to the twist angle of the torsion bar and thus to the torque. These features are chosen to be sensible by any of a variety of noncontacting magnetic, optical, or capacitive techniques.

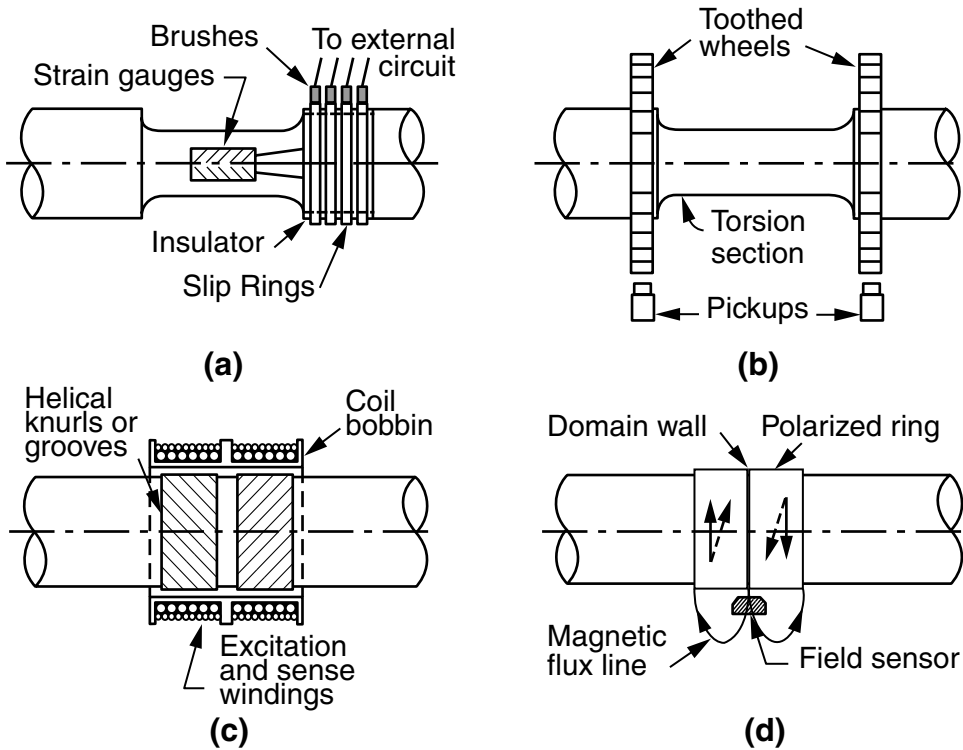

FIGURE 19.47 Four techniques in present use for measuring transmitted torque. (a) Torsional strain in the shaft alters the electrical resistance for four strain gages (two not seen) connected in a Wheatstone bridge circuit. In the embodiment shown, electrical connections are made to the bridge through slip rings and brushes. (b) Twist of the torsion section causes angular displacement of the surface features on the toothed wheels. This creates a phase difference in the signals from the two pickups. (c) The permeabilities of the two grooved regions of the shaft change oppositely with torsional stress. This is sensed as a difference in the output voltages of the two sense windings. (d) Torsional stress causes the initially circumferential magnetizations in the ring (solid arrows) to tilt (dashed arrows). These helical magnetizations cause magnetic poles to appear at the domain wall and ring ends. The resulting magnetic field is sensed by the field sensor.

With more elaborate pickups, the relative angular position of the two wheels appears as the amplitude of a *single* electrical signal, thus providing for the measurement of torque even on a stationary shaft (e.g., [13–15]). In still other constructions, a shaft-mounted variable displacement transformer or a related type of electrical device is used to provide speed independent output signals proportional to ϕ .

Stress

In addition to elastic strain, the stresses by which torque is transmitted are manifested by changes in the magnetic properties of ferromagnetic shaft materials. This “magnetoelastic interaction” [8] provides an inherently noncontacting basis for measuring torque. Two types of magnetoelastic (sometimes called magnetostrictive) torque transducers are in present use: Type 1 derive output signals from torque-induced variations in magnetic circuit permeances; Type 2 create a magnetic field in response to torque. Type 1 transducers typically employ “branch,” “cross,” or “solenoidal” constructions [9]. In branch and cross designs, torque is detected as an imbalance in the permeabilities along orthogonal 45° helical paths (the principal stress directions) on the shaft surface or on the surface of an *ad hoc* material attached to the shaft. In solenoidal constructions torque is detected by differences in the *axial* permeabilities of two adjacent surface regions, preendowed with symmetrical magnetic “easy” axes (typically along the 45° principal stress directions). While branch and cross-type sensors are readily miniaturized [10], local

variations in magnetic properties of typical shaft surfaces limit their accuracy. Solenoidal designs, illustrated in Fig. 19.47(c), avoid this pitfall by effectively averaging these variations. Type 2 transducers are generally constructed with a ring of magnetoelastically active material rigidly attached to the shaft. The ring is magnetized during manufacture of the transducer, usually with each axial half polarized in an opposite circumferential direction as indicated by the solid arrows in Fig. 19.47(d) [11]. When torque is applied, the magnetizations tilt into helical directions (dashed arrows), causing magnetic poles to develop at the central domain wall and (of opposite polarity) at the ring end faces. Torque is determined from the output signal of one or more magnetic field sensors (e.g., Hall effect, magnetoresistive, or flux gate devices) mounted so as to sense the intensity and polarity of the magnetic field that arises in the space near the ring.

Torque Transducer Construction, Operation, and Application

Although a torque sensing region can be created directly on a desired shaft, it is more usual to install a preassembled *modular* torque transducer into the driveline. Transducers of this type are available with capacities from 0.001 to 200,000 N·m. Operating principle descriptions and detailed installation and operating instructions can be found in the catalogs and literature of the various manufacturers [12–20]. Tradenames often identify a specific type of transducers; for example, *Torquemeters* [13] refers to a family of noncontact strain gage models; *Torkducer*® [18] identifies a line of Type 1 magnetoelastic transducers; *Torqstar*™ [12] identifies a line of Type 2 magnetoelastic transducers; *Torquetronic* [16] is a class of transducers using wrap-around twist angle sensors; and *TorXimator*™ [20] identifies optoelectronic-based, noncontact, strain gage transducers. Many of these devices show generic similarities transcending their specific sensing technology as well as their range. Figure 19.48 illustrates many of these common features.

Mechanical Considerations

Maximum operating speeds vary widely; upper limits depend on the size, operating principle, type of bearings, lubrication, and dynamic balance of the rotating assembly. Ball bearings, lubricated by grease, oil, or oil mist, are typical. Parasitic torques associated with bearing lubricants and seals limit the accuracy of low-end torque measurements. (Minute capacity units have no bearings [15].) Forced lubrication can

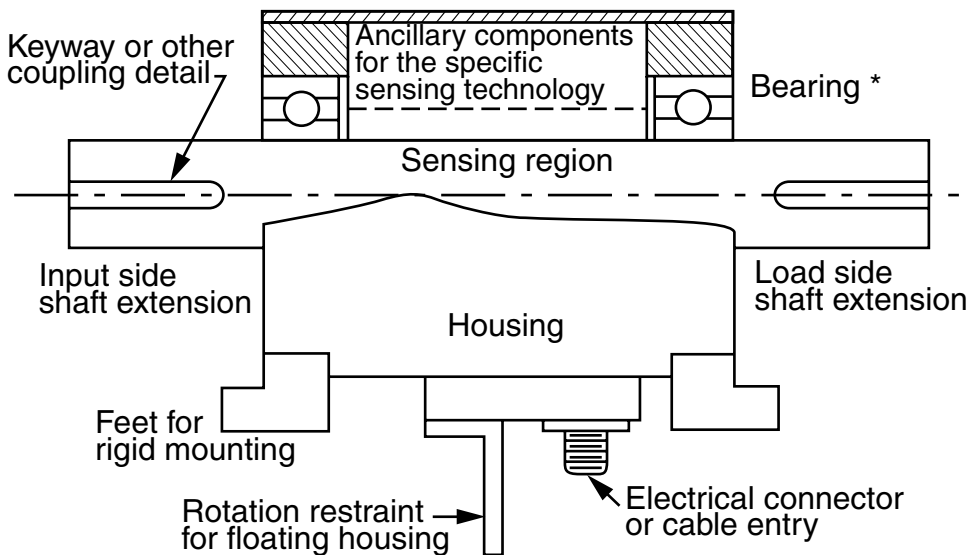

FIGURE 19.48 Modular torque transducer showing generic features and alternative arrangements for free floating or rigid mounting. Bearings* are used only on rotational models. Shaft extensions have keyways or other features to facilitate torque coupling.

allow operation up to 80,000 rpm [16]. High-speed operation requires careful consideration of the effects of centrifugal stresses on the sensed quantity as well as of critical (vibration inducing) speed ranges. Torsional oscillations associated with resonances of the shaft elasticity (characterized by its spring constant) with the rotational inertia of coupled masses can corrupt the measurement, damage the transducer by dynamic excursions above its rated overload torque, and *even be physically dangerous*.

Housings either *float* on the shaft bearings or are *rigidly mounted*. Free floating housings are restrained from rotating by such “soft” means as a cable, spring, or compliant bracket, or by an eccentric external feature simply resting against a fixed surface. In free floating installations, the axes of the driving and driven shafts must be carefully aligned. Torsionally rigid “flexible” couplings at each shaft end are used to accommodate small angular and/or radial misalignments. Alternatively, the use of dual flexible couplings at one end will allow direct coupling of the other end. Rigidly mounted housings are equipped with mounting feet or lugs similar to those found on the frame of electric motors. Free-floating models are sometimes rigidly mounted using adapter plates fastened to the housing. Rigid mountings are preferred when it is difficult or impractical to align the driving and driven shafts, as for example when driving or driven machines are changed often. Rigidly mounted housings *require* the use of dual flexible couplings at *both* shaft ends.

Modular transducers designed for zero or limited rotation applications have no need for bearings. To ensure that *all* of the torque applied at the ends is sensed, it is important in such “reaction”-type torque transducers to limit attachment of the housing to the shaft to only one side of the sensing region. Whether rotating or stationary, the external shaft ends generally include such torque coupling details as flats, keyways, splines, tapers, flanges, male/female squares drives, etc.

Electrical Considerations

By their very nature, transducers require some electrical input power or *excitation*. The “raw” output signal of the actual sensing device also generally requires “conditioning” into a level and format appropriate for display on a digital or analog meter or to meet the input requirements of data acquisition equipment. Excitation and signal conditioning are supplied by electronic circuits designed to match the characteristics of the specific sensing technology. For example, strain gage bridges are typically powered with 10–20 V (DC or AC) and have outputs in the range of 1.5–3.0 mV per volt of excitation at the rated load. Raising these millivolt signals to more usable levels requires amplifiers having gains of 100 or more. With AC excitation, oscillators and demodulators (or rectifiers) are also needed. Circuit elements of these types are normal when inductive elements are used either as a necessary part of the sensor or simply to implement noncontact constructions.

Strain gages, differential transformers, and related sensing technologies require that electrical components be mounted *on* the torqued member. Bringing electrical power to and output signals from these components on rotating shafts require special methods. The most direct and common approach is to use conductive means wherein brushes (typically of silver graphite) bear against (silver) slip rings. Useful life is extended by providing means to lift the brushes off the rotating rings when measurements are not being made. Several “noncontacting” methods are also used. For example, power can be supplied via inductive coupling between stationary and rotating transformer windings [12–15], by the illumination of shaft-mounted photovoltaic cells [20], or even by batteries strapped to the shaft [21] (limited by centrifugal force to relatively low speeds). Output signals are coupled off the shaft through rotary transformers, by frequency-modulated (infrared) LEDs [19,20], or by radio-frequency (FM) telemetry [21]. Where shaft rotation is limited to no more than a few full rotations, as in steering gear, valve actuators or oscillating mechanisms, hard wiring both power and signal circuits is often suitable. Flexible cabling minimizes incidental torques and makes for a long and reliable service life. All such wiring considerations are avoided when noncontact technologies or constructions are used.

Costs and Options

Prices of torque transducers reflect the wide range of available capacities, performance ratings, types, styles, optional features, and accessories. In general, prices of any one type increase with increasing capacity. Reaction types cost about half of similarly rated rotating units. A typical foot-mounted, 565 Nm

capacity, strain gage transducer with either slip rings or rotary transformers and integral speed sensor, specified nonlinearity and hysteresis each within $\pm 0.1\%$, costs about \$4000 (1997). Compatible instrumentation providing transducer excitation, conditioning, and analog output with digital display of torque and speed costs about \$2000. A comparable magnetoelastic transducer with $\pm 0.5\%$ accuracy costs about \$1300. High-capacity transducers for extreme speed service with appropriate lubrication options can cost more than \$50,000. Type 2 magnetoelastic transducers, mass produced for automotive power steering applications, cost approximately \$10.

Apparatus for Power Measurement

Rotating machinery exists in specific types without limit and can operate at power levels from fractions of a watt to some tens of megawatts, a range spanning more than 10^8 . Apparatus for power measurement exists in a similarly wide range of types and sizes. Mechanical power flows from a *driver* to a *load*. This power can be determined *directly* by application of Eq. (19.64), simply by measuring, in addition to ω , the output torque of the driver or the input torque to the load, whichever is the device under test (DUT). When the DUT is a driver, measurements are usually required over its full service range of speed and torque. The test apparatus therefore must act as a controllable load and be able to *absorb* the delivered power. Similarly, when the DUT is a pump or fan or other type of load, or one whose function is simply to alter speed and torque (e.g., a gear box), the test apparatus must include a *driver* capable of supplying power over the DUT's full rated range of torque and speed. Mechanical power can also be determined *indirectly* by conversion into (or from) another form of energy (e.g., heat or electricity) and measuring the relevant calorimetric or electrical quantities. In view of the wide range of readily available methods and apparatus for accurately measuring both torque and speed, indirect methods need only be considered when special circumstances make direct methods difficult.

Dynamometer is the special name given to the power-measuring apparatus that includes absorbing and/or driving means and wherein torque is determined by the reaction forces on a stationary part (the *stator*). An effective dynamometer is conveniently assembled by mounting the DUT in such a manner as to allow measurement of the reaction torque on its frame. Figure 19.49 shows a device designed to facilitate such measurements. Commercial models (Torque Table® [12]) rated to support DUTs weighing 222–4900 N are available with torque capacities from 1.3 to 226 Nm. “Torque tubes” [4] or other DUT mounting arrangements are also used. Other than for possible rotational/elastic resonances, these systems

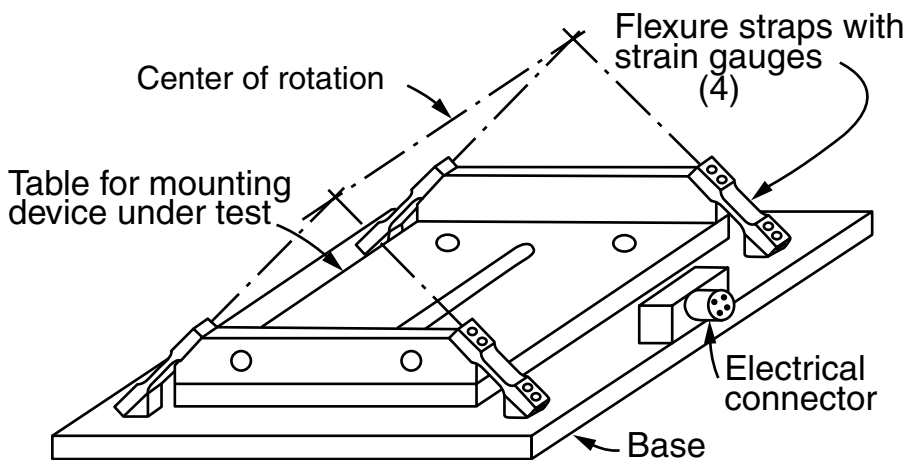

FIGURE 19.49 Support system for measuring the reaction torque of a rotating machine. The axis of the machine must be accurately set on the “center of rotation.” The holes and keyway in the table facilitate machine mounting and alignment. Holes in the front upright provide for attaching a lever arm from which calibrating weights may be hung [4,11].

have no speed limitations. More generally, and especially for large machinery, dynamometers include a specialized driving or absorbing machine. Such dynamometers are classified according to their function as *absorbing* or *driving* (sometimes *motoring*). A *universal dynamometer* can function as either a driver or an absorber.

Absorption Dynamometers

Absorption dynamometers, often called *brakes* because their operation depends on the creation of a controllable *drag* torque, convert mechanical work into heat. A drag torque, as distinguished from an active torque, can act only to restrain and not to initiate rotational motion. Temperature rise within a dynamometer is controlled by carrying away the heat energy, usually by transfer to a moving fluid, typically air or water. Drag torque is created by inherently dissipative processes such as: friction between rubbing surfaces, shear or turbulence of viscous liquids, the flow of electrical current, or magnetic hysteresis. Gaspard Riche de Prony (1755–1839), in 1821 [22], invented a highly useful form of a friction brake to meet the needs for testing the steam engines that were then becoming prevalent. Brakes of this type are often used for instructional purposes, for they embody the general principles and major operating considerations for all types of absorption dynamometers. Figure 19.50 shows the basic form and constructional features of a *prony brake*. The power that would normally be delivered by the shaft of the driving engine to the driven load is (for measurement purposes) converted instead into heat via the work done by the frictional forces between the friction blocks and the flywheel rim. Adjusting the tightness of the clamping bolts varies the frictional drag torque as required. Heat is removed from the inside surface of the rim by arrangements (not shown) utilizing either a continuous flow or evaporation of water. There is no need to know the magnitude of the frictional forces nor even the radius of the flywheel (facts recognized by Prony), because, while the drag torque tends to rotate the clamped-on apparatus, it is held stationary by the equal but opposite reaction torque Fr . F at the end of the torque arm of radius r (a fixed dimension of the apparatus) is monitored by a scale or load cell. The power is found from Eqs. (19.58) and (19.64) as $P = Fr\omega = Fr2\pi N/60$ where N is in rpm.

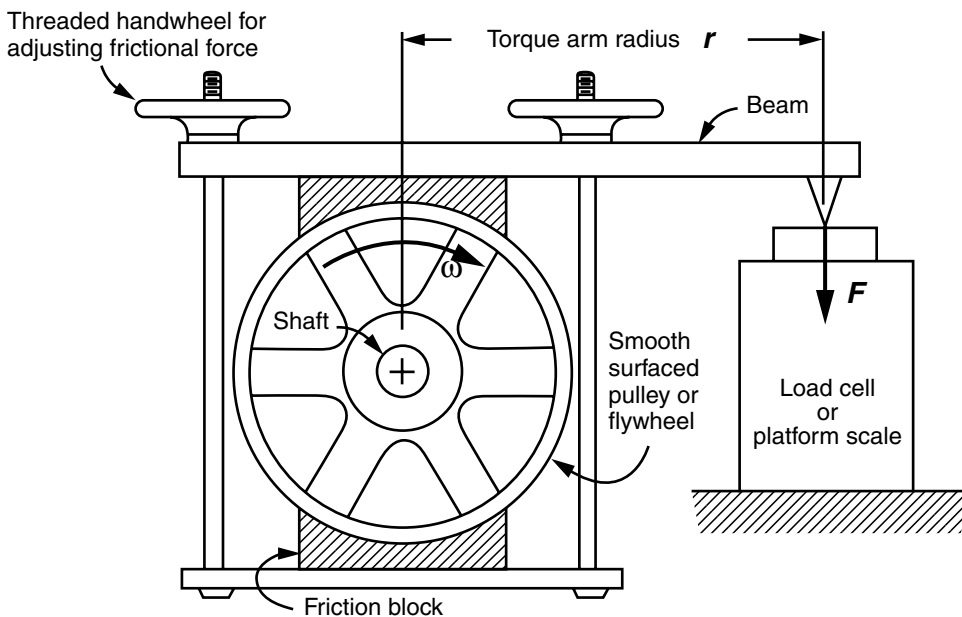

FIGURE 19.50 A classical prony brake. This brake embodies the defining features of all absorbing dynamometers: conversion of mechanical work into heat and determination of power from measured values of reaction torque and rotational velocity.

Uneven retarding forces associated with fluctuating coefficients of friction generally make rubbing friction a poor way to generate drag torque. Nevertheless, because they can be easily constructed, *ad hoc* variations of prony brakes, often using only bare ropes or wooden cleats connected by ropes or straps, find use in the laboratory or wherever undemanding or infrequent power measurements are to be made. More sophisticated prony brake constructions are used in standalone dynamometers with self-contained cooling water tanks in sizes up to 746 kW (1000 Hp) for operation up to 3600 rpm with torques to 5400 Nm [23]. Available in stationary and mobile models, they find use in testing large electric motors as well as engines and transmissions on agricultural vehicles. Prony brakes allow full drag torque to be imposed down to zero speed.

William Froude (1810–1879) [24] invented a *water brake* (1877) that does not depend on rubbing friction. Drag torque within a *Froude brake* is developed between the rotor and the stator by the momentum imparted by the rotor to water contained within the brake casing. Rotor rotation forces the water to circulate between cup-like pockets cast into facing surfaces of both rotor and stator. The rotor is supported in the stator by bearings that also fix its axial position. Labyrinth-type seals prevent water leakage while minimizing frictional drag and wear. The stator casing is supported in the dynamometer frame in cradle fashion by *trunnion* bearings. The torque that prevents rotation of the stator is measured by reaction forces in much the same manner as with the prony brake. Drag torque is adjusted by a valve, controlling either the back pressure in the water outlet piping [25] or the inlet flow rate [26] or sometimes (to allow very rapid torque changes) with two valves controlling both [27]. In any case, the absorbed energy is carried away by the continuous water flow. Other types of cradle-mounted water brakes, while externally similar, have substantially different internal constructions and depend on other principles for developing the drag torque (e.g., smooth rotors develop viscous drag by shearing and turbulence). Nevertheless, all *hydraulic dynamometers* purposefully function as *inefficient* centrifugal pumps. Regardless of internal design and valve settings, maximum drag torque is low at low speeds (zero at standstill) but can rise rapidly, typically varying with the square of rotational speed. The irreducible presence of some water, as well as windage, places a speed-dependent lower limit on the *controllable* drag torque. In any one design, wear and vibration caused by cavitation place upper limits on the speed and power level. Hydraulic dynamometers are available in a wide range of capacities between 300 and 25,000 kW, with some portable units having capacities as low as 75 kW [26]. The largest ever built [27], absorbing up to about 75,000 kW (100,000 Hp), has been used to test propulsion systems for nuclear submarines. Maximum speeds match the operating speeds of the prime movers that they are built to test and therefore generally decrease with increasing capacity. High-speed gas turbine and aerospace engine test equipment can operate as high as 30,000 rpm [25].

In 1855, Jean B. L. Foucault (1819–1868) [22] demonstrated the conversion of mechanical work into heat by rotating a copper disk between the poles of an electromagnet. This simple means of developing drag torque, based on *eddy currents*, has, since circa 1935, been widely exploited in dynamometers. [Figure 19.51](#) shows the essential features of this type of brake. Rotation of a toothed or spoked steel rotor through a spatially uniform magnetic field, created by direct current through coils in the stator, induces locally circulating (eddy) currents in electrically conductive (copper) portions of the stator. Electromagnetic forces between the rotor, which is magnetized by the uniform field, and the field arising from the eddy currents, create the drag torque. This torque, and hence the mechanical input power, are controlled by adjusting the *excitation* current in the stator coils. Electrical input power is less than 1% of the rated capacity. The dynamometer is effectively an internally short-circuited generator because the power associated with the resistive losses from the generated eddy currents is dissipated *within* the machine. Being heated by the flow of these currents, the stator must be cooled, sometimes (in smaller capacity machines) by air supplied by blowers [23], but more often by the continuous flow of water [25,27,28]. In *dry gap* eddy current brakes (the type shown in [Figure 19.51](#)), water flow is limited to passages within the stator. Larger machines are often of the *water in gap* type, wherein water also circulates around the rotor [28]. Water in contact with the moving rotor effectively acts as in a water brake, adding a nonelectromagnetic component to the total drag torque, thereby placing a lower limit to the controllable torque. Windage limits the minimum value of controllable torque in dry gap types. Since drag torque is developed

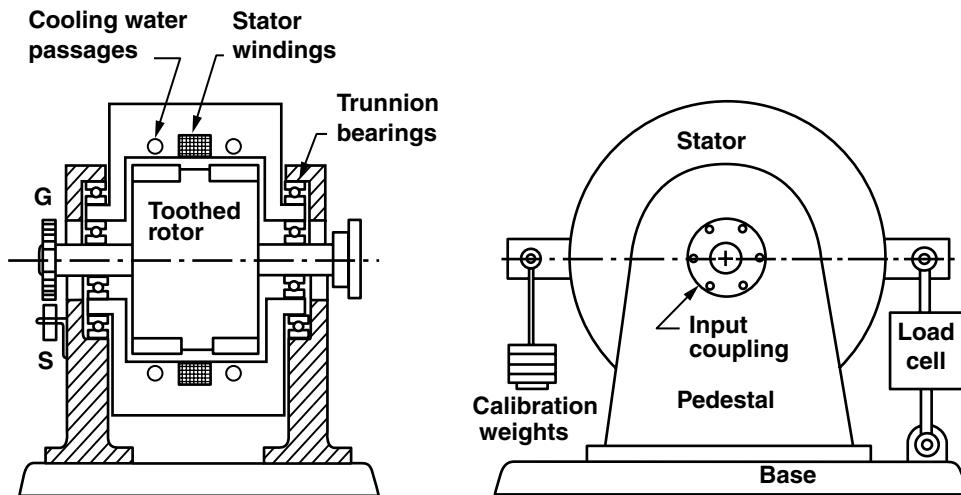

FIGURE 19.51 Cross-section (left) and front view (right) of an eddy current dynamometer. G is a gear wheel and S is a speed sensor. Hoses carrying cooling water and cable carrying electrical power to the stator are not shown.

by the motion of the rotor, it is zero at standstill for any value of excitation current. Initially rising rapidly, approximately linearly, with speed, torque eventually approaches a current limited saturation value. As in other cradled machines, the torque required to prevent rotation of the stator is measured by the reaction force acting at a fixed known distance from the rotation axis. Standard model eddy current brakes have capacities from less than 1 kW [23,27] to more than 2000 kW [27,28], with maximum speeds from 12,000 rpm in the smaller capacity units to 3600 rpm in the largest units. Special units with capacities of 3000 Hp (2238 kW) at speeds to 25,000 rpm have been built [28].

Hysteresis brakes [29] develop drag torque via magnetic attractive/repulsive forces between the magnetic poles established in a reticulated stator structure by a current through the field coil, and those created in a “drag cup” rotor by the stator field gradients. Rotation of the special steel rotor, through the spatial field pattern established by the stator, results in a cyclical reversal of the polarity of its local magnetizations. The energy associated with these reversals (proportional to the area of the hysteresis loop of the rotor material) is converted into heat within the drag cup. Temperature rise is controlled by forced air cooling from a blower or compressed air source. As with eddy current brakes, the drag torque of these devices is controlled by the excitation current. In contrast with eddy current brakes, rated drag torque is available down to zero speed. (Eddy current effects typically add only 1% to the drag torque for each 1000 rpm). As a result of their smooth surfaced rotating parts, hysteresis brakes exhibit low parasitic torques and hence cover a dynamic range as high as 200 to 1. Standard models are available having continuous power capacities up to 6 kW (12 kW with two brakes in tandem cooled by two blowers). Intermittent capacities per unit (for 5 min or less) are 7 kW. Some low-capacity units are convection cooled; the smallest has a continuous rating of just 7 W (35 W for 5 min). Maximum speeds range from 30,000 rpm for the smallest to 10,000 rpm for the largest units. Torque is measured by a strain gage bridge on a moment arm supporting the machine stator.

Driving and Universal Dynamometers

Electric generators, both AC and DC, offer another means for developing a controllable drag torque and they are readily adapted for dynamometer service by cradle mounting their stator structures. Moreover, electrical machines of these types can also operate in a motoring mode wherein they can deliver controllable *active* torque. When configured to operate selectively in either driving or absorbing modes, the machine serves as a universal dynamometer. With DC machines in the absorbing mode, the generated power is typically dissipated in a convection-cooled resistor bank. Air cooling the machine with blowers is usually adequate, since *most* of the mechanical power input is dissipated externally. Nevertheless, *all*

of the mechanical input power is accounted for by the product of the reaction torque and the rotational speed. In the motoring mode, torque and speed are controlled by adjustment of both field and armature currents. Modern AC machines utilize regenerative input power converters to allow braking power to be returned to the utility power line. In the motoring mode, speed is controlled by high-power, solid-state, adjustable frequency inverters. Internal construction is that of a simple three-phase induction motor, having neither brushes, slip rings, nor commutators. The absence of rotor windings allows for higher speed operation than DC machines. Universal dynamometers are “four-quadrant” machines, a term denoting their ability to produce torque in the same or opposite direction as their rotational velocity. This unique ability allows the effective drag torque to be reduced to zero at any speed. Universal dynamometers [25,28] are available in a relatively limited range of capacities (56–450 kW), with commensurate torque (110–1900 Nm) and speed (4500–13,500 rpm) ranges, reflecting their principal application in automotive engine development. Special dynamometers for testing transmissions and other vehicular drive train components insert the DUT between a diesel engine or electric motor prime mover and a hydraulic or eddy current brake [30].

Measurement Accuracy

Accuracy of power measurement (see discussion in [4]) is generally limited by the torque measurement ($\pm 0.25\%$ to $\pm 1\%$) since rotational speed can be measured with almost any desired accuracy. Torque errors can arise from the application of extraneous (i.e., not indicated) torques from hose and cable connections, from windage of external parts, and from miscalibration of the load cell. Undetected friction in the trunnion bearings of cradled dynamometers can compromise the torque measurement accuracy. Ideally, well-lubricated antifriction bearings make no significant contribution to the restraining torque. In practice, however, the unchanging contact region of the balls or other rolling elements on the bearing races makes them prone to brinelling (a form of denting) from forces arising from vibration, unsupported weight of attached devices, or even inadvertently during the alignment of connected machinery. The problem can be alleviated by periodic rotation of the (primarily outer) bearing races. In some bearing-in-bearing constructions, the central races are continuously rotated at low speeds by an electric motor while still others avoid the problem by supporting the stator on hydrostatic oil lift bearings [28].

Costs

The wide range of torque, speed, and power levels, together with the variation in sophistication of associated instrumentation, is reflected in the very wide range of dynamometer prices. Suspension systems of the type illustrated in Fig. 19.49 (for which the user must supply the rotating machine) cost \$4000–6000, increasing with capacity [12]. A 100-Hp (74.6 kW) *portable* water brake equipped with a strain gage load cell and a digital readout instrument for torque, speed, and power costs \$4500, or \$8950 with more sophisticated data acquisition equipment [26]. Stationary (and some *transportable* [23]) hydraulic dynamometers cost from \$113/kW in the smaller sizes [25] down to \$35/kW for the very largest [27]. Transportation, installation, and instrumentation can add significantly to these costs. Eddy current dynamometers cost from as little as \$57/kW to nearly \$700/kW, depending on the rated capacity, type of control system, and instrumentation [24,25,28]. Hysteresis brakes with integral speed sensors cost from \$3300 to \$14,000 according to capacity [29]. Compatible controllers, from manual to fully programmable for PC test control and data acquisition via an IEEE-488 interface, vary in price from \$500 to \$4200. The flexibility and high performance of AC universal dynamometers is reflected in their comparatively high prices of \$670–2200/kW [25,28].

References

1. Pinney, C. P. and Baker, W. E., Velocity Measurement, *The Measurement, Instrumentation and Sensors Handbook*, Webster, J. G., Ed., Boca Raton, FL: CRC Press, 1999.
2. Timoshenko, S. *Strength of Materials*, 3rd ed., New York: Robert E. Kreiger, Part I, 281–290; Part II, 235–250, 1956.

3. Citron, S. J., *On-line engine torque and torque fluctuation measurement for engine control utilizing crankshaft speed fluctuations*, U. S. Patent No. 4,697,561, 1987.
4. Supplement to ASME Performance Test Codes, Measurement of Shaft Power, ANSI/ASME PTC 19.7-1980 (Reaffirmed 1988).
5. See, for example, the catalog of torque wrench products of Consolidated Devices, Inc., 19220 San Jose Ave., City of Industry, CA 91748.
6. Garshelis, I. J., Conto, C. R., and Fiegel, W. S., A single transducer for non-contact measurement of the power, torque and speed of a rotating shaft, SAE Paper No. 950536, 1995.
7. Perry, C. C., and Lissner, H. R., *The Strain Gage Primer*, 2nd ed., New York: McGraw-Hill, 1962, 9. (This book covers all phases of strain gage technology.)
8. Cullity, B. D., *Introduction to Magnetic Materials*, Reading, MA: Addison-Wesley, 1972, Section 8.5, 266–274.
9. Fleming, W. J., Magnetostrictive torque sensors—comparison of branch, cross and solenoidal designs, SAE Paper No. 900264, 1990.
10. Nonomura, Y., Sugiyama, J., Tsukada, K., Takeuchi, M., Itoh, K., and Konomi, T., Measurements of engine torque with the intra-bearing torque sensor, SAE Paper No. 870472, 1987.
11. Garshelis, I. J., *Circularly magnetized non-contact torque sensor and method for measuring torque using same*, U.S. Patent 5,351,555, 1994 and 5,520,059, 1996.
12. Lebow® Products, Siebe, plc., 1728 Maplelawn Road, Troy, MI 48099, Transducer Design Fundamentals/Product Listings, Load Cell and Torque Sensor Handbook No. 710, 1997, also: Torqstar™ and Torque Table®.
13. S. Himmelstein & Co., 2490 Pembroke, Hoffman Estates, IL 60195, MCRT® Non-Contact Strain Gage Torquemeters and Choosing the Right Torque Sensor.
14. Teledyne Brown Engineering, 513 Mill Street, Marion, MA 02738-0288.
15. Staiger, Mohilo & Co. GmbH, Baumwasenstrasse 5, D-7060 Schorndorf, Germany (In the U.S.: Schlenker Enterprises, Ltd., 5143 Electric Ave., Hillside, IL 60162), Torque Measurement.
16. Torquemeters Ltd., Ravensthorpe, Northampton, NN6 8EH, England (In the U.S.: Torquetronics Inc., P.O. Box 100, Allegheny, NY 14707), Power Measurement.
17. Vibrac Corporation, 16 Columbia Drive, Amherst, NH 03031, Torque Measuring Transducer.
18. GSE, Inc., 23640 Research Drive, Farmington Hills, MI 48335-2621, Torkducer®.
19. Sensor Developments, Inc., P.O. Box 290, Lake Orion, MI 48361-0290, 1996 Catalog.
20. Bently Nevada Corporation, P.O. Box 157, Minden, NV 89423, TorXimator™.
21. Binsfield Engineering, Inc., 4571 W. MacFarlane, Maple City, MI 49664.
22. Gillispie, C. C. (Ed.), *Dictionary of Scientific Biography*, Vol. XI, New York: Charles Scribner's Sons, 1975.
23. AW Dynamometer, Inc., P.O. Box 428, Colfax, IL 61728, Traction dynamometers: portable and stationary dynamometers for motors, engines, vehicle power take-offs.
24. Roy Porter (Ed.), *The Biographical Dictionary of Scientists*, 2nd ed., New York: Oxford University Press, 1994.
25. Froude-Consine, Inc., 39201 Schoolcraft Rd., Livonia, MI 48150, F Range Hydraulic Dynamometers, AG Range Eddy Current Dynamometers, AC Range Dynamometers.
26. Go-Power Systems, 1419 Upfield Drive, Carrollton, TX 75006, Portable Dynamometer System, Go-Power Portable Dynamometers.
27. Zöllner GmbH, Postfach 6540, D-2300 Kiel 14, Germany (In the U.S. and Canada: Roland Marine, Inc., 90 Broad St., New York, NY 10004), Hydraulic Dynamometers Type P, High Dynamic Hydraulic Dynamometers.
28. Dynamatic Corporation, 3122 14th Ave., Kenosha, WI 53141-1412, Eddy Current Dynamometer—Torque Measuring Equipment, Adjustable Frequency Dynamometer.
29. Magtrol, Inc., 70 Gardenville Parkway, Buffalo, NY 14224-1322, Hysteresis Absorption Dynamometers.
30. Hicklin Engineering, 3001 NW 104th St., Des Moines, IA 50322, Transdyne™ (transmission test systems, brake and towed chassis dynamometers).

19.5 Flow Measurement

Richard Thorn

Introduction

Flow measurement is something that nearly everyone has experienced of. Everyday examples include the metering of household utilities such as water and gas. Similarly flowmeters are used in nearly every sector of industry, from petroleum to food manufacture and processing. It is therefore not surprising that today, the total world flowmeter market is worth over \$3000 million and expected to continue growing steadily in the future.

However, what is surprising, given the undoubted importance of flow measurement to the economy, is the accuracy and technology of the most commonly used flowmeters which are poor and relatively old fashioned in comparison to instruments used to measure other measurands such as pressure and temperature. For example, the orifice plate flowmeter, which is still one of the most frequently used flowmeters in the process industry, only has a typical accuracy of $\pm 2\%$ of reading and was first used commercially in the late 1800s. The conservative nature of the flow measurement industry means that traditional techniques such as the orifice plate, Venturimeter, and variable area flowmeter still dominate, while ultrasonic flowmeters which were first demonstrated in the 1950s are still considered to be “new” devices by many users. This article will consider the most commonly used commercially available methods of flow measurement. For recent research developments in flow measurement see [1].

Terminology

The term flow measurement is a general term, and before selecting a flowmeter it is important to be sure what type of flow measurement is actually required. For a fluid flowing through a pipe, flow measurement may mean any one of six different types of measurement.

1. Point velocity measurement—the fluid’s velocity at a fixed point across the pipe’s cross section (m/s)
2. Mean flow velocity measurement—average fluid velocity across the cross section of the pipe (m/s)
3. Volumetric flowrate measurement—the rate of change in the volume of fluid passing through the pipe with time (m^3/s)
4. Total volume measurement—the total volume of fluid which has passed through the pipe (m^3)
5. Mass flowrate measurement—the rate of change in the mass of the fluid passing through the pipe with time (kg/s)
6. Total mass measurement—the total mass of fluid passing through the pipe (kg/s)

Although the most common type of flow measurement is that of a fluid through a closed conduit or pipe, open channel flow measurements are also regularly needed in applications such as sewage and water treatment. For further information on open channel flow measurement techniques see [2].

Flow Characteristics

The fluid being metered is usually a liquid or gas, and is known as single phase flow. However, there is an increasing need for the flowrate of multiphase mixtures to be measured (see the section titled “Two-Phase Flow”).

There are a number of important principles relating to the characteristic of flow in a pipe, which should be understood before a flowmeter can be selected and used with confidence. These are the meaning of Reynolds number, and the importance of the flow’s velocity profile.

The Reynolds number Re is the ratio of the inertia forces in the flow ($\rho \bar{v}D$) to the viscous forces in the flow (η), and it can be used to determine whether a fluid flow is laminar or turbulent in nature.

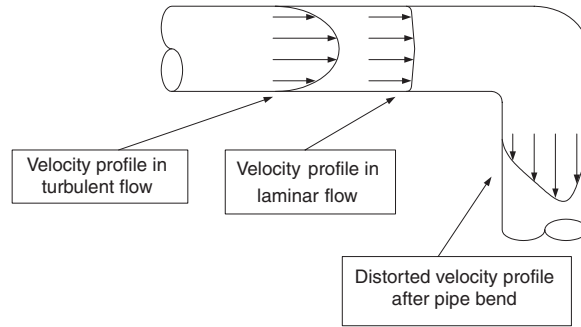

FIGURE 19.52 Flow velocity profiles in laminar and turbulent flow.

Reynolds number can be calculated using

$$Re = \frac{\rho \bar{v} D}{\eta} \quad (19.65)$$

where ρ is the density of the fluid, \bar{v} is the mean velocity of the fluid, D is the pipe diameter, and η is the dynamic viscosity of the fluid. If Re is less than 2000, viscous forces in the flow dominate and the flow will be laminar. If Re is greater than 4000, inertia forces in the flow dominate and the flow will be turbulent. If Re is between 2000 and 4000 the flow is transitional and either mode can be present. The Reynolds number is mainly calculated using properties of the fluid and does not take into account factors such as pipe roughness, bends, and valves, which also affect the flow characteristic. However, the Reynolds number is a good guide to the type of flow which might be expected in most situations.

The fluid velocity across a pipe's cross section is not constant and depends on the type of flow present (Fig. 19.52). In laminar flow, the velocity at the center of the pipe is twice the average velocity across the pipe cross-section and the flow profile is unaffected by the roughness of the pipe wall. In turbulent flow, pipe wall effects are less and the flow's velocity profile is flatter, with the velocity at the center being about 1.2 times the mean velocity. The exact flow profile in a turbulent flow depends on pipe wall roughness and Reynolds number. In industrial applications laminar flows are rarely encountered unless very viscous fluids are being metered. The pipe Reynolds number should always be calculated since some flowmeters are not suitable for use in both laminar and turbulent flow conditions.

A flow's velocity profile will only be symmetrical at the end of a very long pipe. Bends and obstructions such as valves will cause the profile to become distorted or asymmetric. Since the calibration of many flowmeters is sensitive to the velocity profile of the flow passing through the meter then in order to have confidence in the performance of a flowmeter, the velocity profile of the flow passing through the flowmeter should be stable and known.

Flowmeter Classification

Although there are at least 80 different types of flowmeter commercially available, they may be all classified into nine main groups. Table 19.3 gives examples of the main types of flowmeter in each group.

Traditional flow measurement technologies are represented by the differential pressure, variable area, positive displacement, and turbine categories. Newer techniques are represented by the electromagnetic, ultrasonic, oscillatory, and mass categories. Although differential pressure flowmeters are still the most commonly used method of flow measurement, especially in the process industrial sector, in general traditional methods are being increasingly replaced by newer techniques. These techniques are now often preferred because in most cases they do not obstruct the flow, and yet match many of the traditional flowmeters in terms of accuracy and reliability.

TABLE 19.3 Main Categories of Closed Conduit Flowmeter

| |
|--|
| Type 1—differential pressure flowmeters |
| Sharp edged orifice plate, chord orifice plate, eccentric orifice plate, Venturi, nozzle, Pitot tube, elbow, wedge, V-cone, Dall tube, Elliot-Nathan flow tube, Epiflo |
| Type 2—variable area flowmeters |
| Rotameter, orifice and tapered plug, cylinder and piston, target, variable aperture |
| Type 3—positive displacement flowmeters |
| Sliding vane, tri-rotor, bi-rotor, piston, oval gear, nutating-disc, roots, CVM, diaphragm, wet gas |
| Type 4—turbine flowmeters |
| Axial turbine, dual-rotor axial turbine, cylindrical rotor, impeller, Pelton wheel, Hoverflo, propeller |
| Type 5—oscillatory flowmeters |
| Vortex shedding, swirlmeter, fluidic |
| Type 6—electromagnetic flowmeters |
| AC magnetic, pulsed DC magnetic, insertion |
| Type 7—ultrasonic flowmeters |
| Doppler, single path transit-time, multi-path transit-time, cross-correlation, drift |
| Type 8—mass flowmeters |
| Coriolis, thermal |
| Type 9—miscellaneous flowmeters |
| Laser anemometer, hot-wire anemometers, tracer dilution, nuclear magnetic resonance |

The following sections will consider the most popular types of flowmeter from each of the eight main categories in [Table 19.3](#). For information on other flowmeters and those in the miscellaneous group see one of the many textbooks on flow measurement such as [3–6].

Differential Pressure Flowmeter

The basic principle of nearly all differential pressure flowmeters is that if a restriction is placed in a pipeline, then the pressure drop across this restriction is related to the volumetric flowrate of fluid flowing through the pipe.

The orifice plate is the simplest and cheapest type of differential pressure flowmeter. It is simply a plate with a hole of specified size and position cut in it, which can then be clamped between flanges in a pipeline ([Fig. 19.53](#)). The volumetric flowrate of fluid Q in the pipeline is given by Eq. (19.66):

$$Q = \frac{C}{\sqrt{1-\beta^4}} \varepsilon \frac{\pi}{4} d^2 \sqrt{\frac{2(p_1-p_2)}{\rho}} \quad (19.66)$$

where p_1 and p_2 are the pressures on each side of the orifice plate, ρ is the density of the fluid upstream of the orifice plate, d is the diameter of the hole in the orifice plate, and β is the diameter ratio d/D where D is the upstream internal pipe diameter. The two empirically determined correction factors are C the discharge coefficient, and ε the expansibility factor. C is affected by changes in the diameter ratio, Reynolds number, pipe roughness, the sharpness of the leading edge of the orifice, and the points at which the differential pressure across the plate are measured. However, for a fixed geometry it has been shown that C is only dependent on the Reynolds number and so this coefficient can be determined for a particular application. ε is used to account for the compressibility of the fluid being monitored. Both C and ε can be determined from equations and tables in a number of internationally recognized

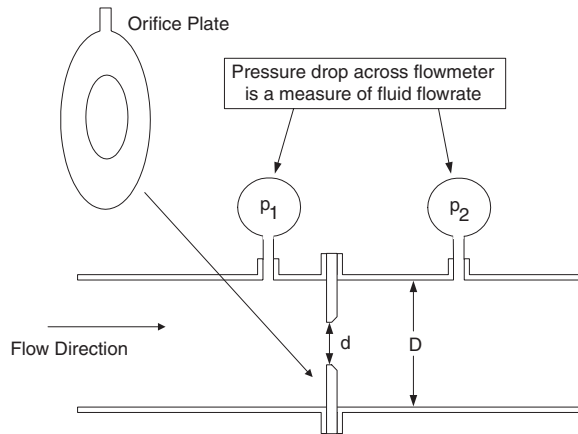

FIGURE 19.53 Flowrate measurement using an orifice plate.

documents known as standards. These standards not only specify C and ϵ , but also the geometry and installation conditions for the square-edged orifice plate, and two other common types of differential pressure flowmeters, the Venturi tube and nozzle. Installation recommendations are intended to ensure that fully developed turbulent flow conditions exist within the measurement section of the flowmeter. The most commonly used standard in Europe is ISO 5167-1 [7], while in the USA, API 2530 is the most popular [8]. Thus, one of the major reasons for the continued use of the orifice plate flowmeter is that measurement uncertainty (typically $\pm 2\%$ of reading) can be predicted without the need for calibration, as long as it is manufactured and installed in accordance with one of these international standards.

The major disadvantages of the orifice plate are its limited range and sensitivity to changes in the flow's velocity profile. The fact that fluid flow rate is proportional to the square root of the measured differential pressure limits the range of a one plate/one differential pressure transmitter combination to about 3:1. The required diameter ratio (also known as beta ratio) of the plate depends on the maximum flow rate to be measured and the range of the differential pressure transducer available.

Equation (19.66) assumes a fully developed and stable flow velocity profile, and so installation of the device is critical, particularly the need for sufficient straight pipework, upstream and downstream of the meter. Wear of the leading edge of the orifice plate can also severely alter measurement accuracy and so this device is normally only used with clean fluids.

The other two differential pressure flowmeters covered by international standards are the Venturi tube and nozzle. The Venturi tube has a lower permanent pressure loss than the orifice plate, and is less sensitive to erosion and upstream disturbances. Major disadvantages are its size and cost. It is more difficult, and therefore more expensive, to manufacture than the orifice plate.

Nozzles have pressure losses similar to orifice plates but because of their smooth design they retain their calibration over a long period. However, these devices are more expensive to manufacture than the orifice plate but cheaper than the Venturi tube. The two most common nozzle designs of nozzle are covered by international Standards, with the ISA-1932 nozzle being preferred in Europe and the ASME long radius nozzle being preferred in the U.S.

There are many other types of differential pressure flowmeter, such as the segmental wedge, V-cone, elbow, and Dall tube. Each of these has advantages over the orifice plate, Venturi tube, and nozzle for specific applications. For example, the segmental wedge can be used with flows having a low Reynolds number, and a Dall tube has a lower permanent pressure loss than a Venturi tube. However, none of these instruments are yet covered by international standards and so calibration is needed to determine their accuracy.

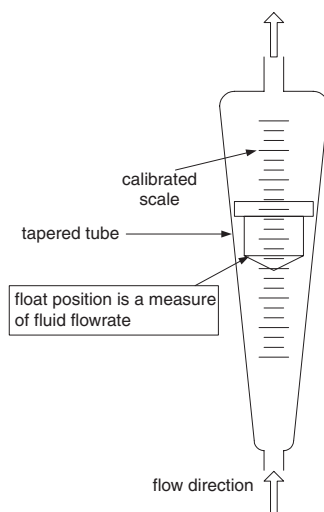

FIGURE 19.54 Tapered tube and float variable area flowmeter.

The Variable Area Flowmeter

Variable area flowmeters are also based on using an obstruction in the flow to create a differential pressure principle, except in this case the differential pressure is constant and the area of the obstruction varies as the flowrate being measured changes. Probably the best known type of variable area flowmeter is the taper tube and float flowmeter, known almost universally as a rotameter (Fig. 19.54). This type of flowmeter consists of a vertical tapered tube into which a float or bob is fitted. The fluid being metered enters the tube at the bottom and forces the float up the tube, which also increases the cross-sectional area available around the float for the fluid to pass through. Increasing the flowrate will move the float further up the tube, and so the position at which the float comes to rest is a direct function of flowrate.

Rotameters are extremely simple and reliable, and have an output which changes linearly with flowrate (unlike differential pressure flowmeters) and a typical range of 10:1 (compared to 3:1 for differential pressure flowmeters). Accuracy is typically $\pm 2\%$ of full scale, but will depend on range and cost of the device. In addition, the flowmeter's calibration is insensitive to changes in the velocity profile of the flow. Since the tube can be made of glass or clear plastic, a visual indication of flowrate is directly available and, of course, the flowmeter requires no external power supply in order to function. As a result such flowmeters are commonly found in many process and laboratory applications where gases or liquids need to be metered. If high temperature, high pressure, or corrosive fluids need to be metered, the rotameter's tube can be made of metal. In such cases a mechanism for detecting and displaying the position of the float is required.

A major limitation of the rotameter is that it can usually only be used vertically and so causes installation difficulties if the pipeline being metered is horizontal. Some manufacturers produce spring loaded rotameters, which can be used in any position; however, in general these have poorer accuracy than standard rotameters. Other limitations are that the calibration of the meter is dependent on the viscosity and density of the fluid being metered, and producing an electrical output signal suitable for transmission requires extra complexity. However, the use of optical or magnetic limit switches to enable the flowmeter to be used in high or low flow alarm applications is common.

The Positive Displacement Flowmeter

Positive displacement flowmeters are based on a simple measurement principle. The flow being measured is "displaced" or moved from the inlet side of the flowmeter to the outlet side using a series of compartments of known volume. The number of compartments of fluid that have been transferred are counted to determine the total volume that has passed through the flowmeter, and if time is also measured then

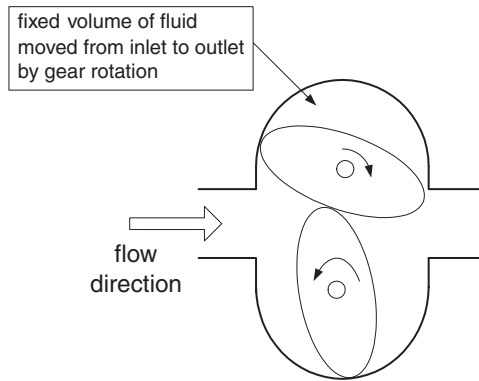

FIGURE 19.55 The oval-gear positive displacement flowmeter.

volumetric flowrate can be measured. There are many designs of positive displacement flowmeters commercially available. For liquids the most common designs are piston, sliding vane, oval-gear, bi-rotor, tri-rotor, and disc types of flowmeter while for gases roots, bellows (or diaphragm), or CVM flowmeters are popular. Despite this wide range of design all are based on the same principle and all are predominantly mechanical devices.

The advantages of positive displacement flowmeters are that they are capable of high accuracy measurement (typically $\pm 0.5\%$ of reading for liquids and $\pm 1\%$ of reading for gases) over a wide range of flowrates. They can be used to meter fluids with a wide range of viscosity and density. In addition, unlike most other flowmeters, they are insensitive to changes in flow velocity profile and so do not require long lengths of straight pipe work before and after the flowmeter.

Figure 19.55 shows the principle of the oval-gear flowmeter and illustrates the limitations of positive displacement flowmeters. They are relatively complex mechanical devices, with moving parts which of course wear with time. Their measurement accuracy depends both on the initial quality of manufacture and a regular maintenance schedule once in use. Fluids being metered should also be free of solid particles so as to reduce wear of the seals and reduce the need for excessive maintenance. Positive displacement flowmeters can also be heavy and expensive for larger pipe sizes and some designs can result in a complete blockage of the pipeline if the flowmeter seizes up.

The Turbine Flowmeter

Like the positive displacement flowmeter, turbine (or vane) flowmeters are mechanical devices capable of achieving high measurement accuracy. The principle of operation of this type of flowmeter is that a multi-bladed rotor is placed in the flow and rotates as fluid passes through it. The rotor's speed of rotation is detected using a sensor (rf, magnetic, and mechanical types being the most common), and is proportional to the velocity of the fluid flowing through the meter. These flowmeters measure the average velocity of fluid in a pipeline, and since the pipe diameter is known, volumetric flowrate can be determined.

Despite the fact that the turbine flowmeter is a mechanical device which may appear to be old fashioned when compared to many other technologies available, it is still one of the most accurate and repeatable flowmeters available today. Measurement accuracy of better than $\pm 0.1\%$ of reading for liquids, and better than $\pm 0.25\%$ of reading for gases, is possible using this type of flowmeter. For this reason the turbine flowmeter is one of the most commonly used instruments in custody transfer applications. These flowmeters have a linear output and a range of at least 10:1, with 100:1 possible in some applications.

The main limitation of the turbine flowmeter is the fact that key mechanical components such as the rotor bearings will wear with use, and in doing so degrade the instrument's repeatability and alter its calibration. Regular maintenance and recalibration are therefore necessary with this type of flowmeter. Care should also be taken to ensure that the fluid being metered is clean, since solid particles in the flow

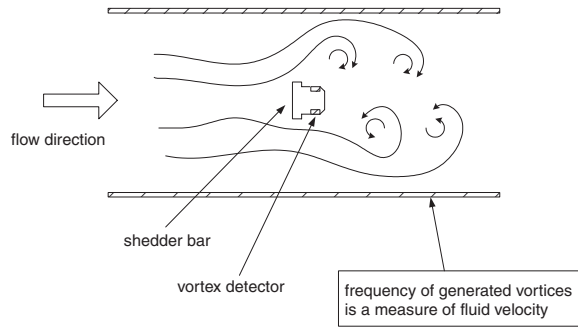

FIGURE 19.56 Principle of the vortex shedding flowmeter.

will cause more rapid bearing wear. The flowmeter's calibration is also sensitive to changes in fluid viscosity and upstream flow velocity profile.

Other types of flowmeters which use the turbine principle include the Pelton wheel and propeller meter, although they have poorer measurement accuracy than axial designs.

The Vortex Shedding Flowmeter

The vortex shedding flowmeter, now more commonly known as the vortex flowmeter, relies on the phenomena of vortex shedding, which was first experimentally studied by Strouhal in 1878. [Figure 19.56](#) shows the principle of the vortex flowmeter. A nonstreamlined obstruction known as a shedder bar or bluff body is placed across the middle of the flow stream. As the fluid stream in the pipe hits this obstacle it must separate to pass around it, with fluid layers nearer the surface of the bar moving slower than those further away. As a result, when these fluid layers recombine after passing the bar, vortices are generated and shed alternately from either side of the shedder bar. The frequency of generated vortices is related to the upstream velocity of the fluid and the width of the shedder bar and is defined by the K factor of the flowmeter. For a given geometry of shedder bar the K factor of a flowmeter is relatively constant over a wide range of pipe Reynolds number, and so in these circumstances the volumetric flowrate of the fluid is linearly related to the vortex shedding frequency.

The frequency of generated vortices is usually detected using sensors integrated into the sides of the shedder bar. Pressure, capacitance, thermal, and ultrasonic are the most common types of sensor used for this purpose.

The vortex flowmeter is capable of accurate measurement of liquid or gas (typically $\pm 1\%$ of reading) over a minimum flow range of 30:1. The flowmeter can also be used over a wide range of fluid temperatures and so is commonly used for metering process fluids at the extreme ends of the temperature range, such as liquid nitrogen and steam. The instrument's calibration is also insensitive to changes in fluid density, and so a meter's calibration holds for any fluid as long as the flowmeter is used within the Reynolds number range specified by the manufacturer. The vortex flowmeter has a simple and reliable construction and so can be used with flows containing small amounts of particles, although more extreme multiphase flows such as slurries will cause rapid wear of the shedder bar and so a change in calibration. The relatively small obstruction that the shedder bar causes results in a permanent pressure loss of about half that of an orifice plate over the same range of flowrate.

The main limitation of the vortex flowmeter is that it can only be used in turbulent flow conditions. It is, therefore, not usually suitable for use in large pipe diameters, or in applications where the flow velocity is low or the fluid viscosity high. Most manufacturers set a minimum Reynolds number of typically 10,000 at which the specified flowmeter performance can be achieved. While many flowmeters will continue operating at Reynolds numbers less than this, the generated vortex stream becomes less stable and so accuracy is reduced. At a Reynolds of less than around 3000, vortices will not be generated

at all and so the flowmeter will stop operating. The vortex flowmeter is also sensitive to changes in upstream flow velocity profile and other disturbances such as swirl, and so should be installed with a sufficient straight length of pipe upstream and downstream of the measurement point. The flowmeter should not be used in applications where pipe vibration or local sources of electrical interference are high, since this will corrupt the vortex signal being detected and possibly give false readings under no-flow conditions.

The Electromagnetic Flowmeter

The operation of the electromagnetic flowmeter is based on Faraday's law of induction, i.e., when a conductor is moving perpendicular to a magnetic field, the voltage induced across the conduction is proportional its velocity. In the case of the electromagnetic flowmeter, the conductor is the fluid being metered, while the induced voltage is measured using electrodes in the pipe wall. Since in most applications the pipe wall of the flowmeter is made from a conductive material such as a stainless steel, an inner nonconducting liner is required to insulate the electrodes and prevent the generated voltage signal being dissipated into the pipe wall. Coils on the outside of the pipe are used to generate a magnetic field across the fluid, with simpler AC coil excitation methods which suffer from zero drift problems being increasingly replaced by pulsed DC excitation techniques which do not.

The electromagnetic flowmeter has a number of advantages over traditional flow measurement techniques, and some characteristics of an ideal flowmeter. The flowmeter has no moving parts, does not obstruct the pipe at all, is available in a very wide range of pipe sizes, and may be used to measure bidirectional flows. A measurement accuracy of typically $\pm 0.5\%$ of reading over a range of at least 10:1 is possible. The flowmeter's accuracy is also unaffected by changes in fluid viscosity and density, and may be used to meter difficult mixtures such as slurries and paper pulp.

The major limitation of the electromagnetic flowmeter is that it can only be used with fluids with a conductivity of typically greater than $5 \mu\text{S}/\text{cm}$, although special designs are available for use with liquids with conductivities of as low as $0.1 \mu\text{S}/\text{cm}$. The flowmeter is, therefore, not suitable for use with gases, steam, or nonconducting liquids such as oil. The flowmeter's calibration is also sensitive to changes in flow velocity profile although requiring a shorter straight length of pipe upstream of the meter than the orifice plate or turbine meter. Although electromagnetic flowmeters do not require significant maintenance, care must be taken during operation to ensure that the liner does not become damaged, and that significant deposits do not build-up on the electrodes, since these can cause changes in the calibration or in some cases cause the flowmeter to stop functioning altogether. Even if these effects are minimized, electromagnetic flowmeters will require periodic recalibration using either traditional techniques or an electronic calibrator now available as an accessory from most manufacturers.

The Ultrasonic Flowmeter

The dream of producing a universal non-invasive flowmeter has been the catalyst for the many different ultrasonic flowmeter configurations, which have been investigated over the last 40 years [9]. However, most ultrasonic flowmeters commercially available today can be placed into one of two categories—Doppler and transit-time.

The ultrasonic Doppler flowmeter is based on the Doppler shift principle. Ultrasound at a frequency of typically 1 MHz is transmitted at an angle into the moving fluid being monitored. Some of this energy will be reflected back by acoustic discontinuities such as particles, bubbles, or turbulent eddies. The difference in frequency between the transmitted and received signals (the Doppler frequency shift) is directly proportional to the velocity of the flow.

The ultrasonic transducers, which are used to transmit and receive the ultrasound, are usually located in a single housing that can be fixed onto the outside of the pipe, and so a simple clamp-on flowmeter, which is easy to install and completely noninvasive, is possible.

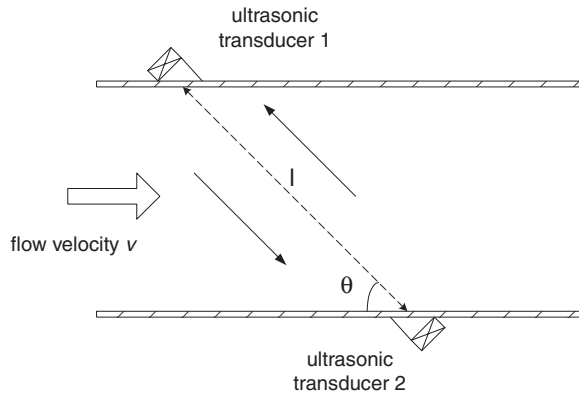

FIGURE 19.57 Principle of the transit-time ultrasonic flowmeter.

The reflected ultrasound does not consist of a single frequency, but a spread of frequencies resulting from reflections from a range of different sized discontinuities, which may also be travelling at different velocities travelling through the detection area. For liquids the frequency of the transmitted ultrasound may lie in the range from 500 kHz up to a few megahertz. At 500 kHz discontinuities must have a diameter of approximately $50 \mu\text{m}$ in order to reflect ultrasound back to the receiver. Increase in the operating frequency will allow the detection of smaller particles, but at the cost of reducing the penetration of the transmitted signal into the fluid. The flowmeter is also sensitive to changes in flow velocity profile and the spatial distribution of discontinuities in the flow. As a result the accuracy of Doppler flowmeters is poor, typically $\pm 5\%$ of full scale. However, this can be improved by calibrating the flowmeter on-line. Since there is a large acoustic mismatch between steel and air, clamp-on Doppler flowmeters cannot be used for metering gas flows or, of course, totally clean liquids where there are insufficient reflecting particles or bubbles to produce a reliable Doppler signal.

Figure 19.57 illustrates the basic principle of the ultrasonic transit-time flowmeter. Two ultrasonic transducers are mounted on either side of the pipe, so that ultrasound can be transmitted across the fluid flowing in the pipe. The difference in the time it takes for a pulse of ultrasound to travel between transducer 1 and 2 (with the flow) and transducer 2 and 1 (against the flow) is given by

$$\Delta T = \frac{2lv \cos \theta}{c^2 - v^2 \cos^2 \theta} \quad (19.68)$$

Since the velocity of sound in the fluid c is much greater than the velocity of the fluid v , then

$$\Delta T \approx \frac{2lv \cos \theta}{c^2} \quad (19.69)$$

Therefore, if the velocity of sound in the fluid is constant, then there is a linear relationship between ΔT and v .

Although this method is elegant and straightforward in principle, in practice there are difficulties since ΔT can be small, and the change in ΔT that occurs with changing fluid velocity is even smaller (typically fractions of microsecond per meter). In addition, as Eq. (19.68) shows, if the temperature of the fluid changes then c will change. Measurement of, and correction for, changes in the fluid temperature are usually needed. Transit-time flowmeters, therefore, require the measurement complex signal conditioning and processing.

The flow velocity v , which is calculated using Eq. (19.68), is the average velocity along the transmission path between the two transducers, and so the flowmeter's calibration will be very dependent on the flow velocity profile. The problem of flow regime dependency can be significantly reduced by using a configuration of several parallel ultrasonic beams and averaging the measured mean velocity along each beam to calculate the overall fluid velocity. This is analogous to numerical integration, and a wide range of multibeam configurations have been proposed, each with their own advantages.

Single path ultrasonic transit-time flowmeters have a typical accuracy of $\pm 2\%$ of reading over a range of at least 100:1. Although this type of flowmeter can be used with liquids or gases, clamp-on designs can only be used with liquids. Multibeam flowmeters have an improved accuracy, but are more expensive. However, they are finding increased use in high value applications like the custody transfer of natural gas. Unlike most other flowmeters, the cost of transit-time flowmeters does not increase significantly with pipe diameter. Transit-time flowmeters are intended for use with clean fluids, although most can still operate if there are a small amount of impurities present in the flow.

The Coriolis Flowmeter

The Coriolis flowmeter can be used to measure the mass flowrate of a fluid directly. As the name suggests, the principle of operation makes use of the Coriolis effect discovered by Gustave Coriolis in 1835. The fluid being metered passes through a vibrating tube, and as a result of the Coriolis force acting on it, the fluid will accelerate as it moves towards the point of maximum vibration and decelerate as it moves away. This will result in flexure of the tube, the amount of flexure being directly proportional to the mass flowrate of the fluid.

The first commercial Coriolis flowmeter used a U-shaped tube, but now many different configurations exist, including dual loops and straight through designs. Each design has its own advantages, with factors such as accuracy, repeatability, and pressure drop varying from design to design.

Whichever design is used, the Coriolis flowmeter is a high accuracy instrument, which may be used to meter gas or liquid with an accuracy of typically $\pm 0.25\%$ of reading. Measurement range varies with design, but 100:1 is possible for U-tube designs and 50:1 for straight tube designs. Since the flowmeter measures mass directly, changes in density, viscosity, pressure, and temperature do not effect the calibration of the flowmeter. The flowmeter is also not affected by changes in flow velocity profile or other flow disturbances such as swirl. The flowmeter does not obstruct the flow at all, and can be used to meter flow in both directions. However, the pressure drop across U-tube designs can be a limitation with viscous fluids.

The major disadvantage of the Coriolis flowmeter is its cost, which is high in comparison to most other flowmeters. This cost may be justified in applications where the product cost is high, or where mass flowrate of the fluid is required. The cost and weight of the Coriolis flowmeter increase significantly with increasing pipe diameter, and as a result are usually limited to pipe diameters with diameters less than 100 mm.

Unlike most of the flowmeters discussed so far, the Coriolis flowmeter can meter some difficult two-phase flows. For example, reliable measurements of the mass flowrate of liquid/gas mixtures are possible if the gas component is small and well distributed, and therefore the mixture is acting like a pseudo-homogeneous fluid. The percentage of gas that can be tolerated by the flowmeter will depend on the viscosity of the liquid component. The less viscous the liquid the more likely the gas is to separate out and cause problems. Liquid/solids flows (slurries) may also be metered, although the user has to compromise between avoiding particle dropout and avoiding excessive fluid velocities which would result in accelerated wear of the flow tube.

Two-Phase Flow

There is a growing demand in areas such as the petroleum and food industries to be able to measure two-phase flows such as liquid with entrained gas, or liquid with solids. Yet the measurement of such flows nearly always presents difficulties to the process engineer.

For example, an ideal flowmeter would be able to directly measure the volumetric flowrate of a liquid whether it be all liquid or contain a second phase of gas. Unfortunately most of the flowmeters described above can usually only be used to meter two-phase flows when the second component is small. A review of the performance of conventional flowmeters in two-phase flows can be found in [10].

The alternative to direct flow measurement is to use an inferential method. An inferential method for liquid/gas flow would require the velocity of the gas and the liquid phases (v_g and v_l) and cross-sectional fraction of the gas phase (α) to be independently measured in order to calculate the volumetric flowrate of the mixture Q_m :

$$Q_m = v_l A(1 - \alpha) + v_g A \alpha \quad (19.69)$$

The overall uncertainty of the flowrate measurement would depend on the accuracy with which the independent measurements can be made. The velocity of the liquid and gas phases cannot be assumed to be the same, and the way the gas is distributed in the liquid (the flow regime) will change depending on factors such as gas content, individual phase velocity, and pressure. Even in a simple case such as this, it is clear that multiphase flow measurement is by no means straightforward. For this reason commercial multiphase flowmeters are generally expensive and targeted at very specific applications.

The most common two-phase flows are liquid/gas (e.g., gas in water), liquid/liquid (e.g., water in oil), gas/solid (pneumatically conveyed solids) and liquid/solids or slurries (e.g., coal in oil). Each presents its own measurement problems and it is not feasible to discuss all possible metering combinations for these types of flow in a overview article such as this. For further details of two-phase flow measurement techniques see [11].

Flowmeter Installation

No matter how good a flowmeter is, correct installation is essential if it is to measure with the uncertainty specified by the manufacturer. The calibration of most flowmeters is sensitive to changes in flow velocity profile and in such cases the flowmeter should be installed to ensure that a fully developed and stable velocity profile is present at the measurement point. Manufacturers' data sheets will contain recommendations for the minimum straight length of pipe required before and after a flowmeter to ensure that this is the case. Flow conditioners (or flow straighteners) can be used to correct a distorted velocity profile and remove swirl in applications where long straight lengths are not possible. However, the limitation of all flow conditioners is that they restrict the flow and so produce an unrecoverable pressure drop in the pipeline.

Installation should always ensure that the pipe is completely full at the metering point and that no unwanted second phase is present. In liquid flows entrained gas can be produced from a number of sources, including cavitation and leaking seals. While in a gas flow, an unwanted liquid phase can be produced by processes such as condensation. In most cases flowmeters will produce metering errors if a second phase is present in the flow. While it is possible to remove unwanted phases from the flow upstream of the metering point, it is better to take care with the process, pipework design, and flowmeter installation to ensure that this situation does not occur in the first place.

Flowmeter Selection

There is no such thing as a flowmeter which is equally good for all applications and given the large number of commercial flowmeters and the variety of data sheets available, the choice can sometimes appear bewildering. While at first sight more than one flowmeter may meet a particular application, selecting the most appropriate can be more difficult. In general the best flowmeter will be the one that can meet the performance specification at the lowest total cost (this is a combination of purchase price and cost of maintenance).

There are five factors which can be considered when trying to decide which flowmeter to use. These are the type of fluid to be metered, process conditions, installation conditions, performance requirements, and economic factors. Information required when considering the fluid to be metered are, whether it is a single phase fluid or whether it contains a second component such as gas or solids, the fluid viscosity and density, whether the fluid is corrosive, and if it is a gas whether it is dry or wet. Factors to be considered under process conditions include the pipeline temperature and pressure, and the ambient conditions outside of the pipeline. Installation conditions covers information such as the pipe diameter, the pipe Reynolds number, the orientation of pipework at the measurement point, the length of straight pipework available, whether the flow is pulsating, the need for any flow conditioning, whether an external power source is available, and if the measurement is being made in a hazardous environment. Performance requirements cover the accuracy, repeatability, range, and dynamic response required by the flowmeter. Finally, economic factors cover issues such as the initial cost of the flowmeter, installation cost, maintenance cost, and the type of training required.

Most flow measurement textbooks also contain flowmeter selection charts (for example, [3, 4, 6]), and an international standard is now available on the selection and application of flowmeters [12].

References

1. *Flow Measurement and Instrumentation*, Oxford: Elsevier Science.
2. Grant, D. M., Open channel flow measurement, in D. W. Spitzer (Ed.), *Flow Measurement: Practical Guides for Measurement and Control*, 2nd ed., Research Triangle Park, NC: ISA, 2001.
3. Miller, R. W., *Flow Measurement Engineering Handbook*, 3rd ed., New York: McGraw Hill, 1996.
4. Baker, R. C., *Flow Measurement Handbook*, Cambridge: Cambridge University Press, 2000.
5. Webster, J. G. (Ed.), *Mechanical Variables Measurement: Solid, Fluid, and Thermal*, Boca Raton: CRC Press, 2000.
6. Spitzer, D. W. (Ed.), *Flow Measurement: Practical Guides for Measurement and Control*, 2nd ed., Research Triangle Park, NC: ISA, 2001.
7. International Organisation for Standardization, ISO5167-1, Measurement of Fluid Flow by Means of Pressure Differential Devices—Part 1: Orifice plates, nozzles and Venturi tubes inserted in circular cross-section conduits running full, Geneva, Switzerland, 1991.
8. American Petroleum Institute, API 2530, Manual of Petroleum Measurement Standards Chapter 14—Natural Gas Fluids Measurement, Section 3—Orifice Metering of Natural Gas and Other Related Hydrocarbon Fluids, Washington, 1985.
9. Lynnworth, L. C., *Ultrasonic Measurements for Process Control: Theory, Techniques, Applications*, Boston: Academic Press, 1989.
10. National Engineering Laboratory, UK, *Effects of Two-Phase Flow on Single-Phase Flowmeters*, Flow Measurement Guidance Note No. 3, 1997.
11. Rajan, V. S. V., Ridley, R. K., and Rafa, K. G., Multiphase flow measurement techniques—a review, *Journal of Energy Resource Technology*, 115, 151–161, 1993.
12. British Standards Institution, BS7405, Guide to the Selection and Application of Flowmeters for Measurement of Fluid Flow in Closed Conduits, London, 1991.

19.6 Temperature Measurements

Pamela M. Norris and Bouvard Hosticka

Introduction

Temperature is often cited as the most widely monitored parameter in science and industry, yet the exact definition of temperature is elusive. The simplest definition would relate temperature to the average kinetic energy of the individual molecules that comprise the system. As the temperature increases, the molecular activity also increases, and thus the average kinetic energy increases. This is an adequate definition for

TABLE 19.4 Fixed Points Used in ITS₉₀^{*}

| | |
|----------------------------|------------|
| Triple point of hydrogen | 13.8033 K |
| Triple point of neon | 24.5561 K |
| Triple point of oxygen | 54.3584 K |
| Triple point of argon | 83.8058 K |
| Triple point of mercury | 234.3156 K |
| Triple point of water | 273.16 K |
| Melting point of gallium | 302.9146 K |
| Freezing point of indium | 429.7485 K |
| Freezing point of tin | 505.078 K |
| Freezing point of zinc | 692.677 K |
| Freezing point of aluminum | 933.573 K |
| Freezing point of silver | 1234.93 K |
| Freezing point of gold | 1337.33 K |
| Freezing point of copper | 1357.77 K |

^{*}Magnum (1990) includes the full definition of these points.

the discussion of temperature measuring techniques presented here. While this definition may help us understand the concept of temperature, it does not help us assign a numerical value to temperature or provide us with a convenient method for measuring temperature. The zeroth law of thermodynamics, formulated in 1931 more than half a century after the first and second laws, lays the foundation for all temperature measurement. It states that if two bodies are in thermal equilibrium with a third body, they are also in thermal equilibrium with each other. By replacing the third body with a thermometer, we can state that two bodies are in thermal equilibrium if both have the same temperature reading even if they are not in contact.

The zeroth law does not enable the assignment of a numerical value for temperature. For that we must refer to a standard scale of temperature. Two absolute temperature scales are defined such that the temperature at zero corresponds to the theoretical state of no molecular movement of the substance. This leads to the Kelvin scale for the SI system and the Rankine scale for the English system. There are other two-point scales derived by identifying two arbitrary defining points for temperature. These are usually defined as the temperature at which a pure substance undergoes a change in phase. Familiar defining points are the freezing and boiling point of water for 0°C and 100°C, respectively. A wide range of such phase changes, many of them triple points where all three phases are in equilibrium, have been accepted as the defining points of the International Practical Temperature Scale of 1990 (ITS₉₀) shown in [Table 19.4](#). These can be used directly as calibration points for temperature monitors as long as the substances are pure and the other conditions, such as pressure, which are included in the defining points are met. Within the ITS₉₀ guidelines are standard means of interpolating temperatures between the defined points. For example, platinum resistors are used in the range from 13.8 to 1235 K. The resistance is fitted to the temperature through a higher-order polynomial that may be simplified for more limited ranges between defined temperature points. The difference between a linear interpolation of resistance between the defined points and the higher-order polynomial interpolation never exceeds 2 mK (Magnum and Furukawa, 1990).

Another complication that is encountered in any discussion of temperature measurement is the fact that temperature is an intrinsic rather than an extrinsic property. Thus, temperature can not be added, subtracted, and divided in the same way that measured extrinsic properties such as length or voltage can be manipulated.

Any property that changes predictably in response to temperature can be used in a temperature sensor. The discussion of temperature measuring devices given here subdivides the devices based on the measuring principle. Discussion will begin with a series of thermometers that rely upon the differential expansion coefficients of the materials, be they solid, liquid, or gas. Mercury thermometers, perhaps the most well known and widely used of all temperature measuring devices, belong to this category. We will then move on to devices that rely upon phase change. Next we will discuss electrical temperature sensors and transducers. Included in this category are thermocouples, RTDs, and thermistors, as well as integrated

circuit temperature sensors. The final category of temperature sensors will be noncontact sensors. A separate discussion of temperature measurements on the microscale is provided at the end. Many of the techniques discussed in the microscale section will be derivatives of those introduced earlier in the discussion, but alterations, ranging from minor to quite major, must be made to enable small-scale and/or quick response temperature measurements.

Thermometers That Rely Upon Differential Expansion Coefficients

Thermometers that rely upon differential expansion coefficients are by far the most common and familiar direct reading temperature monitors. These thermometers can be divided into categories depending on the state of the materials used. Each of these deserves a separate discussion.

Gas vs. Solid

The gas bulb thermometer, which is used to determine absolute zero from extrapolation of the change in pressure of a simple gas in a metal sphere with a change in temperature, is an example of a gas vs. solid thermometer. If the metal bulb had the same expansion coefficient as the fill gas, the pressure inside would remain constant and it would not be a thermometer. Instead, the gas follows the ideal gas law, which indicates that, at a constant volume, the pressure is linearly related to the temperature and the vessel containing the gas changes linearly with the volumetric expansion coefficient of the metal making up the bulb. The thermal expansion coefficient of the metal is usually ignored unless very precise predictions of absolute zero are required.

While a large metal sphere with a pressure gage attached is not a very convenient means of measuring temperature, except as a demonstration or research tool, the bulb can be made quite small and connected via a small capillary tube to a remote pressure gage. In this miniaturized configuration the gas bulb thermometer becomes a practical means of measuring temperature. As long as the device operates in the ideal gas region, the pressure gage can be graduated to read temperature directly, since pressure is linearly related to temperature.

Some major limitations on gas bulb thermometers are that the instrument should be calibrated specifically for a particular installation since the length of the heated capillary, as well as the ambient pressure and temperature at the pressure gage, will influence the accuracy of the device. These limitations can be overcome at the expense of complication by using bimetallic elements in the pressure gage to compensate for the temperature at that point or by having a parallel capillary with no bulb follow the main capillary up to the point of measurement and have the parallel capillary equipped with a pressure gage linked to subtract its effects from the main gage. Also, any damage that changes the volume of the bulb, such as a dent, will shift the calibration. This style of instrument should not be confused with vapor pressure thermometers that can take on an identical exterior form, but instead of being filled with an ideal gas, they contain a two-phase fluid and the saturation pressure of the fluid is measured. This type of temperature sensor is discussed in further detail in another section.

Liquid vs. Solid

The common mercury and glass thermometer is an example of a liquid vs. solid temperature sensor. The thermal expansion of liquids, although not as great as gasses, is generally much greater than that of solids and for many applications the expansion coefficient of the glass can be ignored. However, for precision measurements, the expansion of the glass can introduce significant errors. There are two common means of dealing with the glass expansion coefficient. Thermometers intended for reading the temperature of a liquid bath might have a specified submergence depth indicated by a mark on the stem. It is assumed that the rest of the thermometer is at standard lab conditions. This is not always a good assumption, however, and a more precise way of handling the glass expansion coefficient compared to that of mercury is to use a pair of total submergence thermometers. One measures the temperature of the liquid and the other measures the temperature in the immediate vicinity of the exposed stem. A simple stem correction formula supplied by the thermometer manufacturer can then be applied to determine the temperature of the bath.

The ratio of the volume of the bulb to the bore of the capillary determines the resolution of the thermometer. The amount of liquid initially in the thermometer determines its range. The accuracy of the bore and graduation markings determines its precision. The temperature read from a liquid-glass thermometer is only valid if the liquid in the bore is continuous from the bulb to the point of reading. Separations can be eliminated by either contracting the fluid entirely into the bulb or, in some cases, by expanding it into a reservoir at the top of the thermometer. Mercury is useful from near its freezing temperature (about -40°C) to around 500°C . The boiling point of mercury is only 357°C at standard pressure, so mercury thermometers designed for very high temperatures must be pressurized with an inert cover gas when sealed. Alcohol or other liquids can be used in place of mercury, but the accuracy is generally not as great. The temperature range of alcohol extends from about -200°C to $+250^{\circ}\text{C}$.

An alternative means of using the difference in expansion coefficients of liquids and solids to measure temperature is to use a system filled completely with a liquid and to monitor the change in the volume of the liquid by the position of a bourdon tube or bellows. If the volume-measuring element has a high spring constant, the compressibility of the liquid might have to be considered (Doebelin, 1990). This scheme has the same disadvantages as the gas bulb thermometer discussed above, as well as the same compensation means for overcoming these disadvantages.

Gas, Liquid, and Solid

Some early thermometers consisted of a gas bulb connected to a sealed U-tube containing mercury or another liquid. This, in effect, is really a gas pressure thermometer using a mercury manometer to indicate pressure. To be accurate, the various coefficients of expansion of all three phases must be considered. These instruments are rarely used where accuracy is important. The only example still widely used is a style of minimum-maximum thermometer for ambient air measurements where a small metal fiber is displaced in either leg of the manometer by the mercury. The fiber has enough friction in the tube and is not wetted by the mercury so that it remains free in the glass tube after the mercury shifts. The indicator on the gas bulb side stays at the minimum temperature while the indicator on the other leg stays at the maximum temperature as the mercury recedes. Once the minimum and maximum temperatures are observed, the fibers can be repositioned to the top of the two mercury columns by either centrifugal force (slinging the whole thermometer) or with a magnet if iron fibers are used.

Solid vs. Solid

Bimetallic thermometers consist of two metals with differing temperature expansion coefficients bonded together. As the temperature varies from the temperature at which the metals were initially bonded, the metals expand by differing amounts and the composite experiences a shearing force. The most common means of monitoring the shearing is to allow the metal composite to bend in response to temperature changes. The form of the composite can take on many configurations varying in complexity from a simple leaf fixed at one end with a pointer on the other to a small helix fixed at one end and a turning shaft at the other that is linked to a pointer, possibly through a gear train. The shaft is supported on fine bearings with the pointer as much as a meter away from the bimetallic helix. Stick thermometers with a dial at one end are an example of the latter.

Since the temperature variations produce a force, there must always be some graded restoring force applied to the bimetallic strip. The most common application is to use the bimetallic strip itself as a restoring spring. The final position of the strip is a balance between the shear imposed by the differing temperature coefficients and the spring constant of the strip. There are instances when bimetallic thermometers are required to actuate a switch. In these cases the load imposed by the switch must be overcome by the shear forces in the strip and the designer must consider it as an external load. The temperature range of bimetallic thermometers is limited by the annealing temperature or phase transformation of the metals. Bimetallics are thus mainly used well below 700°C , and they can be permanently damaged if the metals change their properties or the bonding between the different metals fails. A common pair of metals is a nickel steel, such as Invar with a very low thermal expansion coefficient, bonded to a brass alloy with a high thermal expansion coefficient.

Thermometers That Rely Upon Phase Changes

Phase transitions of pure substances at specified pressures are used in the ITS₉₀ to define several of the temperature points. This concept of a phase change being a function of temperature, as well as pressure and the type of material, can be exploited in several forms as a means of determining the temperature of a system by observing either the phase change itself or the conditions at which the two phases are in equilibrium. Several useful applications of this are discussed below.

Liquid to Gas

A common remote thermometer consists of a bulb containing a liquid-gas two-phase fluid connected via a capillary tube to a pressure gage. As long as both phases are present, the pressure read on the gage yields the saturation pressure of the fluid. This arrangement overcomes many of the disadvantages of the gas vs. solid thermometers with the same outward appearance described in section “Gas vs. Solid” above. By monitoring the saturation pressure, the indicated temperature is independent of the temperature of the rest of the system and is insensitive to the actual volume of the bulb and capillary. The fluid is typically an organic solvent such as ethane selected for the particular temperature range desired. To keep the two-phase fluid entirely in the bulb, the pressure can be transmitted through the capillary using a single-phase fluid such as oil. Few fluids have a linear saturation curve. Therefore, most pressure gages have a notably nonlinear scale when graduated into units of temperature. Special compensation springs within the pressure gage can be used to allow for a nearly linear temperature scale, but the extra complication is rarely warranted.

The temperature range of liquid to gas thermometers is limited by the two phases of the fluid and they are typically useful from -40°C to 300°C , although a single instrument rarely will operate over more than about a 150°C span. If the saturation pressure of the fluid is very much greater than 100 kPa, a simple pressure gage referenced to atmospheric pressure can be used. Otherwise best accuracy is obtained using an absolute pressure gage. The volume of the bulb must be large compared to the change in volume of the capillary and bourdon tube in the pressure gage so that both phases are always present in the bulb. The size of the bulb keeps these thermometers from being used for point measurements.

Reversible Phase Change Thermostats

Fixed-point thermostats may be constructed based upon the phase change of a particular sensing element. An example is used in mechanical ice-point references where the sudden expansion of water as it freezes is sensed to cycle the cooling system to maintain a two-phase bath. The actual melting and freezing of the ice maintains the reference temperature. Waxes of various melting points can be used in a similar manner.

Another example is a magnetic switch held closed by a permanent magnet until the Curie temperature is reached at which point the magnet loses its magnetism, or more properly, changes from a ferromagnetic material to a paramagnetic material, and the switch opens. When the material cools, it regains its ferromagnetism, which closes the heater switch. The magnetic material can be selected to have the appropriate Curie temperature.

Fixed Temperature Indicators

Any substance that changes phase at a fixed temperature can be used as a temperature indicator. Numerous examples exist, the most common being a crayon made of a wax with a defined melting point. A mark is made on the object whose temperature needs to be monitored, and if the wax melts, its temperature is higher than the crayon point. These fixed temperature indicators are generally irreversible and can take on many forms in addition to crayons.

A variation that can be either reversible or irreversible is a paint containing suspended solids of the wax or similar material that melts at the desired indication temperature. As long as the particles are solid and scatter light, the paint appears opaque, but when they melt and turn into a liquid with a refractive index close to that of the base paint, it appears clear. These indicators can be made in a series of spots with varying temperature points to help monitor actual temperature attained rather than just

a go, no-go indication. The spots can be made reversible for real-time indications or irreversible to indicate the maximum temperature reached over the monitoring period, although the irreversible ones are much more common than the reversible kind.

Although waxes are widely used, any material that has a distinct phase change at a defined temperature can be used in such a monitor. Imaging techniques other than visual can also be used to determine the phase change. One such application involves using gadolinium or another element that readily absorbs neutrons in a suitable form and observing the melting within the interior of an assembly by means of neutron radiography. The temperature range for systems based upon observing melting solids ranges from near ambient to several thousand Kelvin.

Electrical Temperature Sensors and Transducers

A sensor in this context is an element that varies an electrical parameter as a function of temperature. This electrical parameter is then converted to a useful electrical function, such as linear voltage to temperature, with added electronics. The sensor and added electronics make up a transducer. The variation of electrical characteristics with temperature is both a source of measurement possibilities as well as the bane of all electrical measuring systems, since the unwanted change of such things as the gain of an amplifier with temperature causes thermal errors to occur. More effort is expended on eliminating temperature induced electrical variations than is spent exploiting them for temperature measurement.

Thermocouples

There is a relationship between the temperature of a conductor and the kinetic energy of the free electrons. Thus, when a metal is subjected to a temperature gradient, the free electrons will diffuse from the high temperature region to the low temperature region where they have a lower kinetic energy. The electron concentration gradient creates a voltage gradient since the lattice atoms that constitute the positive charges are not free to move. This voltage gradient will oppose the further diffusion of electrons in the wire and a stable equilibrium will be established with no current flow.

The “thermal power” of a material relates the balance of thermal diffusion of the electrons to the electrical conductivity of the metal and is unique for every conductor and usually varies with temperature. The electrical conductivity of the material has a strong influence on the thermal power since it defines the ability of a material to support a voltage gradient. Thus, a SINGLE conductor with its ends at differing temperatures will have a voltage difference between the ends. The trick is to be able to measure the voltage at both ends of the conductor and thus determine the temperature difference between those ends. If we use the same type of wire to measure the voltage across the original wire, the second wire will develop exactly the same voltage difference when its ends are exposed to the same temperatures as the original wire. Therefore, this effect cannot be measured with a pair of similar wires. But because the voltage gradient is a function of the thermal power, which is different for each type of metal, a second conductor of a different type of wire can be used to measure the original voltage gradient. Only a conductor with either no electron mobility or infinite conductivity could be used to measure the absolute voltage gradient associated with the temperature gradient of the original conductor. This is not a practical proposition, so only the difference in the temperature-induced electron gradient between two conductors can ever be measured. This is the basis of thermocouples.

In practical terms, whenever two metals are joined together and the junction is at a different temperature than the free ends of the conductors, the free ends will have a potential difference between them, that is a function of the absolute temperature at the junction and the temperature of the free ends. The relationship between voltage difference and temperature difference will be characteristic of the chosen pair of conductors. Rather than speak of the free ends of the two wires, it is normal to refer to a second junction in the circuit. This is valid and reminds us that there is always a second junction to consider even if the two wires from the thermocouple are attached to a metering circuit. Somewhere within the meter, the circuit is completed and the second junction is formed.

From the previous explanation, all of the classic thermocouple laws can be derived. These laws can be summarized and find application as follows:

Law 1. A third metal introduced in the circuit with both ends of the third metal at an isothermal point does not affect the thermally induced voltage of the original pair.

There are two important implications associated with this law. The first means that the nature of the electrical contact between the wires at the junction is not critical, and that the thermocouple itself can be made up of two wires that are soldered, brazed, welded, or swaged together. In all these cases, a third metal is present at the junction whether it is the filler in soldered and brazed connections, the intermediate alloy produced by welding dissimilar metals, or the metal swage holding the ends of the wire together. This does not mean that there are not other concerns involved with how the junction is formed. It will obviously not do to solder wires together and then use the junction above the melting point of the solder. Most commercially prepared thermocouples are welded for that reason. This law also allows for a metallic item whose temperature is being measured to serve as the actual junction by attaching the thermocouple leads directly to it. This might be done to avoid the time needed to transfer energy between the object and an independent thermocouple assembly. The second implication of this law allows a measuring circuit made of conductors other than those used in the thermocouple to be inserted in the circuit as long as both connections between the measuring circuit and the two thermocouple wires are at the same temperature.

Law 2. The temperatures along the wires do not affect the thermally induced voltage characteristic of the temperature of the two junctions.

This means that the thermocouple leads can be conveniently routed through various temperature regions, and that only the temperatures at the junction and the monitoring location are important in determining the voltage.

Law 3. Each metal has its own voltage gradient for a given temperature gradient independent of the wire used to monitor that voltage.

This means that each type of metal can be calibrated against a standard and that the calibration is valid for each type of thermocouple that can be made from this wire.

Thus far the discussion has been limited to open circuits because this avoids the complications of energy being carried away from a hot junction by the electrons or the I^2R losses in the conductors that both produce heat and reduce the measured voltage. Using high-impedance amplified voltmeters or differential voltmeters having infinite impedance when balanced, allows the practical open circuit voltage to be measured and eliminates these sources of error. However, since the wires used in thermocouples are usually metals with reasonable heat conduction, energy may be inadvertently removed from the measured system by simple heat conduction along the wires.

To actually use a thermocouple the temperature at one junction must be known and some sort of calibration table or polynomial curve fit must be used to convert the measured voltage to temperature at the junction. There are published tables and polynomials for common pairs of metals used in thermocouples referenced to the ice point of water (Croarkin et al., 1993). These are based upon an average alloy but the alloy actually purchased cannot be precisely the same as the one represented by the table. This unavoidable variation of alloy content and application of standard tables is the major source of error in thermocouple readings. Despite the best efforts of the manufacturers, this variation can lead to as much as 2% error in the reported voltage for a given temperature measurement. Individual spools of wire or assembled thermocouples can be calibrated to minimize this source of error.

The temperature of the reference junction must be known to determine the temperature of the measuring junction from the measured voltage. If the temperature of one of the reference junctions is not the same as the reference temperature of the calibration table, the voltage associated with the known temperature of the reference junction can be algebraically added to the measured voltage to determine the voltage that would have been measured if the reference junction were, in fact, at the defined temperature of the table. This is not as difficult as it first appears. If the reference junction is kept in an ice bath, no correction is needed when using the normal calibration tables. To make this easy, there are commercial

ice reference refrigerators specifically designed to be used for thermocouple measurements. There are also electronic sensors that give a voltage or current output that is proportional to its absolute temperature that can be incorporated in a measuring system. These can be used to measure the temperature of the isothermal terminal block of the instrument and then, by either analog circuitry or computer software, the thermocouple voltage associated with that temperature is added to the appropriate measured voltage. This scheme allows direct reading of the voltage associated with the unknown temperature. The requirement that the electronic sensor be at the same temperature as the terminals for the thermocouple cannot be over-emphasized. A multichannel scanner or strip chart recorder may have a terminal board extending over several hundred millimeters in length. If the temperature is electronically measured at one point along this length and a power supply or other heat source in the scanner causes a temperature gradient across the terminal board, serious errors might occur. Care must be taken to assure that what is called an isothermal block is truly isothermal. In the case of the scanner mentioned above, the terminal board and multiplexer had to be removed from its parent instrument and wrapped in insulation before accurate measurements could be obtained.

There are a wide variety of commercial thermocouples in various configurations and materials available depending upon the measuring requirements encountered. As well as thermocouples, a whole industry exists to provide readers, controllers, connectors, wires, and all else that is needed for use. Typical thermocouple readers will have an electronic reference temperature and accommodations for the nonlinear relation between voltage and temperature built in so that it is a simple matter to plug in the matching type of thermocouple and read the temperature. Wires for the standard types are color coded with the outer jacket indicating the wire pair and the color of the individual wires indicating polarity.

It is unfortunate that there is almost a perverse nonuniformity of standards across the world. For example, in the United States (ANSI/MC96-1, 1982) a yellow thermocouple wire sheath indicates a Chromel–Alumel pair with the red lead indicating the negative side when reading elevated temperatures. (In the U.S. system, red is uniformly the negative lead.) Whereas in Japan (JIS-C 1610, 1981), a yellow sheath indicates Iron–Constantan with the red lead representing the positive side.

Oxidation or contamination by unintentional alloying of the wire at high temperature can cause the calibration to shift. The calibration can also shift if the alloy changes along the length of the thermocouple after being subjected to steep temperature gradients at high temperature, which will allow the metals of the alloy to diffuse through one another. For normal uses, however, thermocouples are quite stable, easy to use, and reliable, with types suitable for use from near absolute zero to over 2000°C.

The physical size and thermal mass of the thermocouples define their spatial resolution and time constant, but they can be made with extremely fine wires or films to limit their size down to the micron range at the expense of ruggedness and actual power output. Unlike other electrical thermal sensors, thermocouples can be mounted in direct electrical contact with the measured surface, thereby further improving the time response of the measurement. This concept can be extended by having the actual junction formed by a third metal that is vapor deposited to bridge the insulation between the measuring wires. The junctions then consist of the thin film of metal, which can theoretically reduce the time constant to less than 1 μ s (Deobelin, 1990). The main disadvantages of thermocouples are their nonlinear voltage to temperature response, the requirement to know the reference temperature by means other than using a thermocouple, and their relatively low accuracy unless specifically calibrated.

Resistance Temperature Devices (RTDs)

Most materials show a variation in electrical resistance with temperature. For metals, the resistance goes up with temperature in nearly a linear manner. Platinum is the preferred metal for practical resistance temperature measurements and indeed is the specified means of interpolating between the many defined points on the ITS₉₀ scale. Metals other than platinum can be used for specific applications. For example, one way of measuring the temperature of the windings in motors or generators is to measure their resistance while operating under load. The copper windings themselves act as RTDs in this case. The discussion that follows is specifically for platinum RTDs, but the concepts apply to all metals.

For precise measurements over a wide temperature range, a higher order polynomial should be applied to determine temperature from resistance. For practical measurements over a narrow range of a few hundred degrees, the resistance can be treated as linear with temperature. The platinum resistors specified by ITS₉₀ are not the same as commercially available in probes. ITS₉₀ specifies pure, unstrained platinum wire made into sensors, typically with a resistance of 25.5 Ω at 0°C (Mangum and Furukawa, 1990). Most RTD elements use commercially pure platinum with a resistance of 100 Ω or 50 Ω at 0°C, although higher nominal values are sometimes used to minimize the effect of contact and lead resistances in the circuit and lower resistances are used at high temperatures. There are several differing standard platinum curves that reflect varying standard purity platinum alloys. While all alloys are nominally pure platinum, the first-order coefficient for temperatures from 0°C to 100°C of the European standard (DIN 43 760) is 3.85 mΩ/Ω-K, while the American standard is 3.92 mΩ/Ω-K. Besides these two common coefficients, there are several other coefficients listed for pure platinum. When purchasing RTDs and RTD reading equipment, the user should be aware of the standard that applies.

RTD elements can be fabricated as a wire wound onto insulated bobbins or films deposited on insulating substrates. The size of both the support and the wire, as well as any insulating encapsulation, will determine the response time of the element. Films are usually smaller than wire wound sensors and thus have a quicker time response. Due to the need to insulate the RTD from the measured surface, however, and also to avoid straining the element, even small thin film RTDs have time constants that are measured in tenths of seconds. In the special case of using a bare wire to measure gas temperatures, the time constant can be considerably reduced to the tens of microseconds; however, due to the self heating described below, this is more useful as a form of local anemometry rather than temperature measurement.

The measurement of temperature using a RTD is simply a matter of determining its resistance. The relation between resistance and temperature is absolute, so no reference temperature is needed, unlike with thermocouples. However, measuring the resistance of the element is not always simple. There are three conventional techniques, each of which has its own disadvantages, as will be discussed shortly.

Common to all techniques for measuring remote sensors is the complication of the lead wire resistance. As mentioned above, all metals have a variation in resistance with temperature and thus any lead wires will act as RTDs. Thus, if the temperature of the wires between the RTD and the reading mechanism varies, an error will be introduced in the temperature reading unless steps are taken to accommodate the lead temperature effects. For this reason, commercial RTDs are available with two, three, or four wires going to the actual terminals of the resistor, depending on the technique used to handle the lead effects as shown in Fig. 19.58. The arrangement of Fig. 19.58(a) is used where the lead lengths are short,

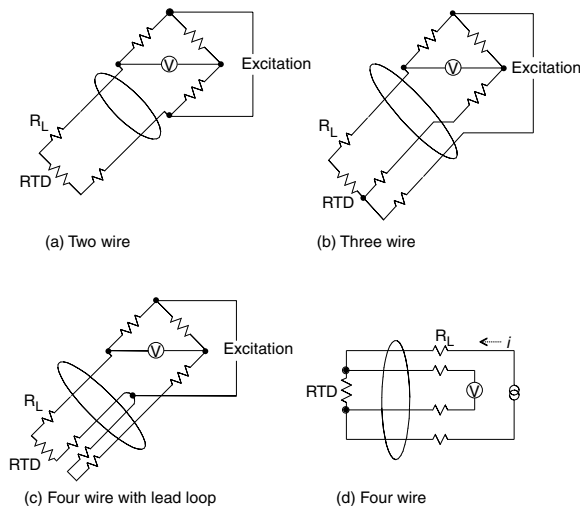

FIGURE 19.58 Various styles of commercial RTD probes and their application in reading circuits.

the resistance of the RTD is high compared to the lead resistance, or where high accuracy is not required. Three wire RTDs, Fig. 19.58(b), allow an equal length of lead wire to be included in each side of the bridge so that changes in lead resistances are felt equally on both sides and the balance of the bridge is not affected. It should be noted that four-wire RTDs of the type shown in Fig. 19.58(d) can be used with readers designed for two-, three-, or four-wire RTDs and unless expense or size is a concern, they are recommended to allow for future upgrades of the reader. A fairly rare alternate configuration of a four wire RTD probe is shown in Fig. 19.58(c) where two of the lead wires form a closed loop. This arrangement usually is needed only when multiple RTDs are in the bridge and should not be confused with the other type of four-wire RTD shown in Fig. 19.58(d), which has two wires going to each side of the resistor.

Another problem common to all reading schemes is that of self-heating of the RTD due to the measuring current through the resistor. This can be minimized by using small currents, having a high heat transfer coefficient between the sensor and the measured process, or by using low duty time pulsed measurements. Although steps can be taken to minimize it, self-heating can never be eliminated. It is such a ubiquitous characteristic of RTDs that it can be exploited as a means of determining the heat transfer coefficient of a system, such as when platinum resistors are used as anemometers.

As indicated above, the measurement of temperature using an RTD simply requires determining its resistance. The three conventional techniques are briefly discussed here.

Fully Balanced Bridges

A primitive but highly accurate means of determining the resistance of an RTD is to use it in one leg of a wheatstone bridge and have a calibrated variable resistor in the opposite leg such that when the bridge is brought to balance, as indicated by a null current on a galvanometer, the resistance of the RTD is the same as the calibrated variable resistor. There are several variations on this theme to eliminate most sources of error by splitting the error-forming device between legs of the bridge. For example, if the RTD is remote from the bridge, a three-wire lead configuration can be used to put an equal length of lead wire in both sides of the bridge with the “corner” of the bridge now defined at the remote RTD location as shown in Fig. 19.58(b). Ultimately the accuracy of the reading is limited by the accuracy of the resistances in the bridge, which can be made quite accurate. Since the variable resistor must be physically adjusted to null the bridge, this technique is not readily adapted to data loggers or temperature displays.

Unbalanced Bridges

If the calibrated variable resistor in the above scheme is replaced by a fixed resistor, the extent of the imbalance of the bridge can be measured with a voltmeter in place of the nulling galvanometer. This technique is fraught with errors since the imbalance of the bridge is not linear with the resistance of the RTD and the reading of the voltmeter is also proportional to the excitation current. Nevertheless, this can be a practical means of measuring temperatures over a narrow range if the values of the resistors in the far legs of the bridge are much higher than the RTD and the opposite leg resistance is close to that of the RTD. As with the other bridge techniques, three lead wires can be arranged in opposite legs of the bridge for remote sensors to compensate for lead resistance changes. If opposite legs of the bridge both consist of RTDs, then the bridge imbalance is proportional to the difference in the temperature of the two RTDs and the only way to keep equal lead lengths in both legs is to use the special four-wire type shown in Fig. 19.58(c).

Direct Voltage vs. Current Measurements

If a constant current is passed through a resistor, the voltage across it is proportional to resistance. This is a simple concept but had to await the advent of accurate constant current sources and high impedance voltage amplifiers to become a practical replacement to the bridge techniques. By using four lead wires, as shown in Fig. 19.58(d), the current circuit can be made independent of the voltage sensing circuit and the lead resistances have no effect on the reading.

Thermistors

Thermistors are bulk semiconductors made from an oxide of nickel, cobalt, manganese, or other metal. The oxide is ground to a fine powder and then sintered to produce the actual thermistor material that is then incorporated into a sensor. Thermistors are resistance temperature sensing devices with several notable differences from RTDs such as their large negative temperature coefficients, and extreme nonlinear response. The resistance of a thermistor is usually so large (several thousand ohms) that lead wire resistance is rarely a concern. Thus, they are inevitably two-wire devices unless multiple thermistors or components are included in the probe. There must be some means of electrical bonding between the wire leads and the thermistor semiconductor. This bonding and the typical epoxy encapsulation places a limit on the maximum usable temperature, even though the thermistor itself is a refractory material.

There are several schemes for dealing with the nonlinearity of thermistors, ranging from applying a correction curve with a computer to having multiple thermistors with differing characteristics complete with nonthermal resistors as a bridge within a single encapsulated probe. For moderate temperatures spanning 200 K, a simple external bridge can be used to linearize the signal.

Although not normally called thermistors, germanium, silicon, and carbon are semiconductors that can also be used to monitor temperatures by measuring their resistance. Germanium is used for very precise measurements at cryogenic temperatures down to less than 1 K. The change in resistance can be very large and very nonlinear, but still very repeatable with a typical unit going from 7000 Ω at 2 K to 6 Ω at 60 K (Doebelin, 1990). Silicon can be used at room temperature and, depending on its doping, can have a very steep temperature curve. It is rarely used as a temperature sensor since other methods work better over its useful range of -200°C to 200°C . Carbon resistors out of a parts drawer found in any laboratory can be used for cryogenic measurements from 1 to 20 K, but they must be individually calibrated.

Integrated Circuit Temperature Sensors

The base-to-emitter voltage drop of a transistor operating at a constant current is a simple function of absolute temperature. Thus, any transistor can be used as a temperature sensor. In reality, this is much more of a problem with building thermally stable electronics than a convenient means of measuring temperature. Integrated circuits are available that monitor the collector current, amplify, and linearize the base-to-emitter voltage to yield an output that is proportional to absolute temperature. Common integrated circuit temperature sensors are available with outputs of 10 mV/K, or 1 $\mu\text{A}/\text{K}$. The temperature range over which they may be used is limited to -50°C to 150°C by the construction techniques of integrated circuits. This makes them very useful for referencing one junction of the thermocouple and most ambient temperature measurements. Although not intrinsically water proof, the ICs are small metal cans or plastic cases resembling signal transistors and can be potted or used in thermowells.

The IC sensors with a voltage output are commonly two terminal devices, with a possible optional lead for trimming the response. When a small current of about 1 mA is allowed to pass through it, it will have a voltage drop directly proportional to the absolute temperature (National, 2000). Even simpler IC transducers are available with separate excitation and signal leads. These are usually calibrated to 10 mV/ $^{\circ}\text{F}$ or $^{\circ}\text{C}$. These have an inherent limitation of not being able to measure below a few degrees above 0°F or 0°C unless both positive and negative power supplies are available.

Voltage output ICs are very convenient where the temperature being monitored is local to the readout and the voltage drop across the lead wires is not a concern, but for remote sensors, which require long lines, current sensors are preferred. Current sensors are also two terminal devices that behave as high impedance current sources so whatever lead resistance present may increase the voltage, but will not affect the current through the sensor (Analog, 1997). Both types can be individually adjusted by trimming resistances on the chip with a laser during manufacture to provide the rated output or they can have an external adjustment lead. Even with trimming and calibration, the accuracy over the entire span from -50°C to $+150^{\circ}\text{C}$ is rarely better than two or three degrees. Several individual ICs may be hooked up to give minimum or average temperature. Voltage ICs are placed in parallel for minimum temperature and in

series for average temperature, while the current devices are connected in series for minimum and parallel for average. In addition to such simple applications of constant current or voltage sources based upon temperature, there are a wide variety of novel circuits to derive almost any function imaginable as a basis of temperature measurement.

Although there is a very small area on the silicon chip of the IC, which is temperature sensitive, it is convenient to regard the entire chip, its case, and the bonded lead wires as the sensor. This increase in thermal mass lowers the time response of the device to several seconds. Self-heating and heat transfer through the leads are also of concern and limit the applicability of these devices in critical measurements.

Noncontact Thermometers

All of the previously discussed temperature monitoring systems implied that the sensor of whatever type is in physical contact with the object being monitored, or in some special cases is the actual object being measured. Often times it is impractical to make this physical connection and noncontact modes of temperature measurement have been developed to overcome this objection. Almost all of these techniques require that the infrared emissions from the surface of the object be measured, but in a few special cases other surface optical properties such as reflectance can be exploited to determine the temperature remotely.

IR Emission Thermometers

Any object above absolute zero emits electromagnetic radiation whose spectrum is related to its surface temperature and surface emissivity. By characterizing the spectrum, the temperature of the object can be determined directly and absolutely. The microwave background of the universe at 3 K, and the temperature-dependent color of stars are extreme examples of this phenomena. Temperature can still be determined from the emitted surface without using a spectrometer. If two bodies are allowed to come into thermal equilibrium with each other and the temperature of one body is known, the temperature of the other is also known. This is the basis of all previously discussed temperature-measuring devices assuming conduction as the principle means of heat transfer. This can be extended to noncontact thermometers since radiation heat transfer is also a valid means of two bodies coming into thermal equilibrium. Many IR thermometers are based upon this phenomenon.

In its simplest form, an IR thermometer would consist of a temperature sensor for monitoring the temperature of an isolated object called the detector, and this detector would only be subject to radiative heat transfer with the surface whose temperature is to be measured. This would work assuming that both the surface and detector behave as black bodies, that there is no heat loss from the detector to the surroundings, and that the field of view of the detector is restricted to the object under measurement and otherwise totally unobstructed. Each one of these assumptions has to be considered when going from the ideal case to a real IR thermometer.

The concept of a black body is an idealization where all radiant energy is completely absorbed by the surface. Under this assumption, the radiant energy is a function only of the temperature of the surface. The only alternatives to being absorbed by the surface are to be reflected by the surface or transmitted through the material. The emissivity, which describes the deviation of a real surface from a black body, is then just one minus its reflectance minus its transmittance. If the emissivity is less than one but independent of wavelength, then it is a gray body. Few real materials are either black bodies or gray bodies, thus emissivity corrections must be made which will often be a function of the temperature being measured. If the surface behaves like a gray body over a limited range of wavelengths, the intensity at a few wavelengths in this range can be measured to estimate the entire spectral shape. It is fortunate that many real objects are close to gray over a narrow range of wavelengths around 750 nm and the spectral shape as a function of temperature for gray objects in the temperature range of 500–3000°C is well enough behaved at these wavelengths that the spectral shape, and thus the temperature, can be measured with just two points. The emissivity of a surface can be determined in conjunction with taking its

temperature by illuminating the surface with an IR laser and measuring the amount of the known laser light that is reflected. The total IR during illumination is the sum of the reflected laser light and the thermally emitted IR. If care is taken that only short pulses or low power laser light is used, to avoid heating the measured surface, this will yield the reflectance at the wavelength of the laser and thus its emissivity which, for opaque surfaces, is one minus reflectance.

Heat transfer to and from the detector by means other than thermal radiation exchange with the monitored surface will require that the temperature of the detector be regarded as only representing the temperature of the monitored surface rather than being the same as the monitored surface. Heat transfer from the detector to the instrument can be via conduction or radiation and is accommodated by calibrating the instrument against a black body of known temperature. When this is done, the temperature of the instrument is usually monitored and circuitry may be set up to have the reference junction for the detector monitor the instrument casing temperature. Alternatively the actual photon flux can be measured by electronic means using photodiodes, photoresistive cells, or other such electronic photon sensors sensitive to IR. When this is done, narrow band filters are often used to limit the response of the detector to a particular wavelength of IR radiation to avoid counting visible photons that may be reflected from the surface or to limit the response to a particular wavelength where atmospheric interferences are minimized.

Optical components are often employed to limit the field of view of the detector so that a defined portion of the surface to be measured is brought to focus on the detector. As long as the entire detector sees the surface of interest, the distance between the detector and the surface is not important, except as it relates to IR absorption by the H_2O , CO_2 , or other IR active gasses in the air.

A variation of the IR techniques discussed above is the disappearing filament pyrometer. This device superimposes the image of a tungsten filament whose temperature is a known function of current through the filament onto the view through a telescope. The walls of a furnace or other incandescent surface are observed through the telescope while adjusting the filament current until it just disappears in the background glow. The temperature of the filament then matches the temperature of the incandescent surface and can be determined from the current through the filament. A simple refinement is to put a narrow band red filter in the telescope so that the color is the same for both the target and the filament, and it becomes a single wavelength brightness comparison rather than radiation color comparison. If the emissivity of both the filament and the surface is unity, this can be very accurate. If not equal to one, when a monochromatic filter is used, only the emissivity at that one wavelength needs to be known for accurate temperature determinations.

Microscale Temperature Measurements

As the microelectronics industry surges forward with increasingly higher operating frequencies and increasingly smaller device dimensions, measurement techniques with high spatial and/or temporal resolution are becoming increasingly important. Few techniques are available that can actually measure temperature on a microscale, i.e., sub-micron spatial resolution and/or sub-microsecond temporal resolution. However, many techniques that are being developed concentrate on observing the differential temperature on a microscale. The transient thermoreflectance technique, for example, utilizes a femtosecond pulsed laser to heat and probe the transient reflectance of the sample to enable observation of thermal transport on a sub-picosecond time scale. The technique involves relating the measured reflectivity changes to temperature changes using the material's complex index of refraction (Rosei and Lynch, 1972).

The three most common methods of observing microscale thermal phenomena include thin film thermocouples, thin film microbridges, and optical techniques. Nanometer scale thermocouples are typically used in conjunction with an atomic force microscope (AFM). This technique is nondestructive since the AFM brings the probe into contact with the sample very carefully. Thin film microbridges are patterned metallic thin films, usually thinner than 100 nanometers with a width that depends on the application. This technique relies on the fact that the electrical resistance of the microbridge is a strong function of temperature. The microbridge must be deposited onto the sample surface, therefore the technique is neither noncontact nor nondestructive. Optical techniques typically use a laser as the heating source

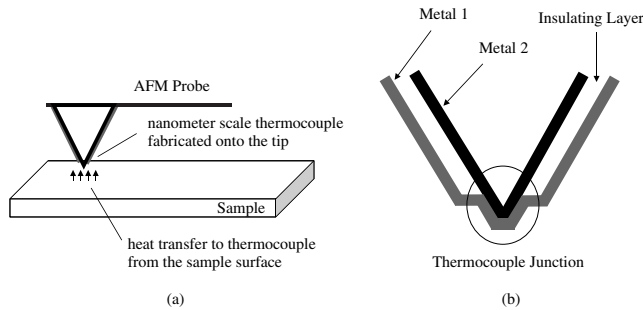

FIGURE 19.59 (a) Diagram showing the use of a scanning thermal microscope probe. (b) Schematic of a nanometer scale thermocouple manufactured onto the tip of a commercially available AFM cantilever.

and/or the thermal probe. The thermal effects can be observed optically in a number of different ways. Thermoreflectance techniques rely on the temperature dependence of reflectance (Paddock and Eesley, 1986), while photothermal techniques monitor the deflection of the probe beam by thermal expansion that results at the surface (Welsh and Ristau, 1995). “Mirage” techniques use the fact that the air just above the surface is also heated, which causes changes in the index of refraction that bends the probe beam by varying amounts depending on the change in temperature (Gonzales et al., 2000).

Scanning Thermal Microscopy (SThM)

The SThM is perhaps the best example of an actual temperature measurement on sub-micron length scales. The nanometer scale thermocouple is comprised of thin metallic films deposited directly onto commercially available AFM probes. Majumdar published a comprehensive review of SThM and includes a description of several methods for manufacturing these nanometer thermocouples (Majumdar, 1999). Figure 19.59(a) shows a diagram of a scanning thermal microscope probe and Fig. 19.59(b) is a schematic of a typical thermocouple junction. There are several factors that affect the spatial resolution of the measurement. These factors include the tip size of the thermocouple which can be on the order of 20 and 50 nm, the mean free path of the energy carrier of the material to be characterized, and the mechanism of heat transfer between the sample and the thermocouple, which is ultimately the limiting factor.

Operation of the AFM cantilever is identical to that of a standard AFM probe. Ideally, the thermocouple would quickly come to thermal equilibrium once in contact with the sample without affecting the temperature of the surface. Practically, a certain amount of thermal energy is transferred between the sample and the thermocouple, which affects the sample temperature, and there is also thermal resistance which delays the measurement and limits the spatial resolution. Once the sample and the thermocouple are brought into contact, there is solid–solid thermal conduction from the sample to the thermocouple. There is also thermal conduction through the gas surrounding the thermocouple tip and through a liquid layer that condenses in the small gap between the tip and the sample. Shi et al. (2000) demonstrated that conduction through this liquid layer dominates the heat transfer under normal atmospheric conditions.

Transient Thermoreflectance (TTR) Technique

The TTR, while not capable of monitoring temperature directly, is an optical technique that enables measurement of temperature changes with sub-picosecond temporal resolution. This technique is fully noncontact and relies on the fact that reflectivity is a function of temperature. The TTR experimental setup (Elsayed-Ali et al., 1991; Paddock and Eesley, 1986; Hostetler et al., 1997) shown in Fig. 19.60 can be employed to monitor the thermoreflectance response of a metallic sample after the absorption of an ultra-short laser pulse. The pulses from a femtosecond laser operating at 76 MHz are separated into two beams, an intense “pump” beam, which is used to heat the film, and a low power “probe” beam, which is used to monitor the reflectivity. The pump beam passes through an acousto-optic modulator that effectively chops

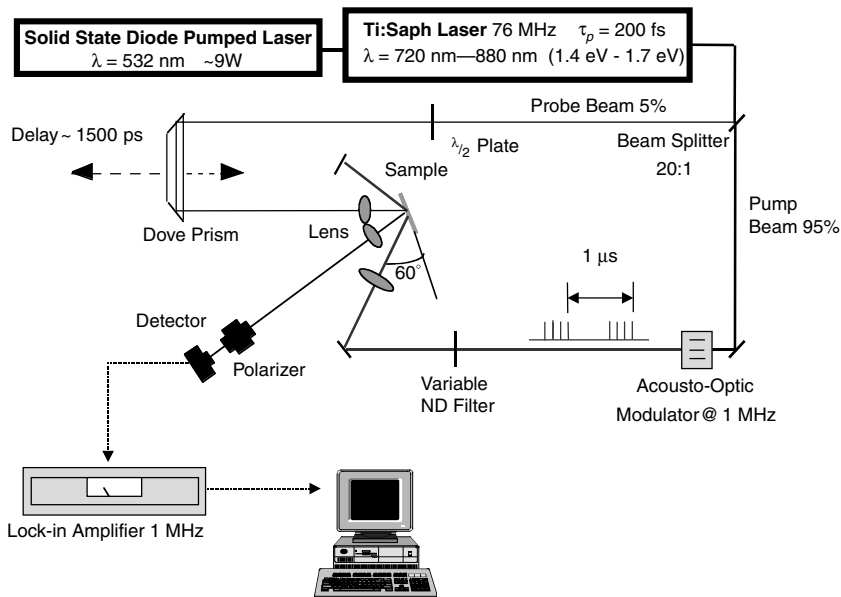

FIGURE 19.60 Experimental setup of the transient thermoreflectance technique.

the beam on and off at a frequency of 1 MHz, resulting in thermomodulation. The probe beam passes through a dovetail prism mounted on a movable stage, which is used to increase the optical path length of the probe beam and hence the time delay between the pump and probe pulses. The reflection of the probe beam, which is centered in the heated area, is monitored by a photodiode and sent to a lock-in amplifier set to the thermomodulation frequency of 1 MHz. This yields the temporal relaxation profile of the sample.

Employing the TTR method as a temperature probe involves relating the measured reflectivity changes to temperature changes using the material's complex index of refraction. In most metals and dielectrics, the complex index of refraction depends weakly on temperature (Price, 1947). In wavelength ranges where the reflection coefficient is large, the reflectivity can be described by the linear sum of a large static contribution and a small temperature-dependent modulated contribution. The corresponding change in reflectivity is $\sim 10^{-5}/K$. The lock-in detection at 1 MHz enables resolution of the small transient signal. By comparing the transient thermal response of a surface to the appropriate heat conduction model, thermophysical properties such as the thermal diffusivity and the thermal boundary resistance can be measured (Hostetler et al., 1997; Hostetler et al., 1998; Smith et al., 2000).

Closing Comments

A wide variety of sensors are available for monitoring the parameter we refer to as temperature. The choice of the appropriate sensor is highly dependent upon the actual physical configuration of the measured material, as well as the required precision, accuracy, and display or processing of the temperature. While thermocouples may be an excellent choice for situations involving electrical logging of a remote process, a gas-bulb thermometer may be adequate and more appropriate for monitoring remote temperatures divorced from electricity. The physical geometry, which often limits access to the area of interest, is another important consideration. It is also important to consider the accuracy requirement, as well as the spatial and temporal resolution desired. This discussion is meant to provide a cursory overview of a wide array of temperature-sensing techniques. There are many excellent, comprehensive references and the designer is referred to these for more details. Temperature measurement often resembles an art rather than a science, with new and creative techniques for monitoring thermal responses in continuous development.

As nanotechnology progresses, many more advances in the area of sub-micron/sub-microsecond temperature measurements will become vital, since many of the traditional means of measuring temperature are not easily adapted to small local temperature measurements.

References

- Analog Devices Data Sheet for AD590 Temperature Transducer, 1997.
- Croarkin, M.C., et al., 1993, "Temperature-electromotive force reference functions and tables for the letter-designated thermocouple types based on the ITS-90," National Institute of Standards and Technology, Monograph 175.
- Doebelin, E.O., *Measurement Systems, Application and Design*, McGraw-Hill, New York, 1990.
- Elsayed-Ali, H.E., Juhasz, T., Smith, G.O., and Bron, W.E., 1991, "Femtosecond thermorefectivity and thermotransmissivity of polycrystalline and single-crystalline gold films," *Phys. Rev. B*, Vol. 43, pp. 4488–4491.
- Gonzales, E.J., Bonevich, J.E., Stafford, G.R., White, G., and Josell, D., 2000, "Thermal transport through thin films: mirage technique measurements on aluminum/titanium multilayers," *J. Materials Res.*, Vol. 15, pp. 764–771.
- Hostetler, J.L., Smith, A.N., and Norris, P.M., 1998, "Simultaneous measurement of thermophysical and mechanical properties of thin films," *Int. J. Thermophys.*, Vol. 19, pp. 569–577.
- Hostetler, J.L., Smith, A.N., and Norris, P.M., 1997, "Thin-film thermal conductivity and thickness measurements using picosecond ultrasonics," *Micro. Thermophys. Eng.*, Vol. 1, pp. 237–244.
- Majumdar, A., 1999, "Scanning thermal microscopy," *Ann. Rev. Material Sci.*, Vol. 29, pp. 505–585.
- Mangum, B.W. and Furukawa, G.T., 1990, "Guidelines for realizing the international temperature scale of 1990 (ITS-90)," National Institute of Science and Technology, Technical Note 1265.
- National Semiconductor Data Sheet for LM135 series Temperature Sensors, DS005698, 2000.
- Paddock, C.A. and Eesley, G.L., 1986, "Transient thermorefectance from thin metal films," *J. Appl. Phys.*, Vol. 60, pp. 285–290.
- Price, D.J., 1947, "The temperature variation of the emissivity of metals in the near infrared," *Proc. Phys. Soc. (London)*, Vol. 59, pp. 131.
- Rosei, R. and Lynch, D.W., 1972, "Thermomodulation spectra of Al, Au, and Cu," *Phys. Rev. B*, Vol. 10, pp. 474–483.
- Shi, L., Plyasunov, S., Bachtold, A., McEuen, P.L., and Majumdar, A., 2000, "Scanning thermal microscopy of carbon nanotubes using batch-fabricated probes," *Appl. Phys. Lett.*, Vol. 77, pp. 4295–4297.
- Smith, A.N., Hostetler, J.L., and Norris, P.M., 2000, "Thermal boundary resistance measurements using a transient thermorefectance technique." *Micro. Thermophys. Eng.*, Vol. 4, No. 1, pp. 51–60.
- Welsh, E. and Ristau, D., 1995, "Photothermal measurements on optical thin films." *Appl. Opt.*, Vol. 34, pp. 7239–7253.

19.7 Distance Measuring and Proximity Sensors*

Jorge Fernando Figueroa and H. R. (Bart) Everett

Distance Measuring Sensors

Introduction

Range sensors are used to measure the distance from a reference point to an object. A number of technologies have been applied to develop these sensors, the most prominent being light/optics, computer vision, microwave, and ultrasonic. Range sensors may be of contact or noncontact types.

*Significant portions of this chapter were condensed from "Sensors for Mobile Robots", by H. R. Everett, with permission from A. K. Peters, Ltd., Natick, MA.

Noncontact Ranging Sensors

Sensors that measure the actual distance to a target of interest with no direct physical contact are referred to as noncontact ranging sensors. There are at least seven different types of ranging techniques employed in various implementations of such distance measuring devices (Everett et al., 1992):

- Triangulation
- Time of flight (pulsed)
- Phase-shift measurement (CW)
- Frequency modulation (CW)
- Interferometry
- Swept focus
- Return signal intensity

Noncontact ranging sensors can be broadly classified as either *active* (radiating some form of energy into the field of regard) or *passive* (relying on energy emitted by the various objects in the scene under surveillance). The commonly used terms *radar* (radio direction and ranging), *sonar* (sound navigation and ranging), and *lidar* (light direction and ranging) refer to *active* methodologies that can be based on any of several of the above ranging techniques. For example, *radar* is usually implemented using time-of-flight, phase-shift measurement, or frequency modulation. *Sonar* typically is based on time-of-flight ranging, since the speed of sound is slow enough to be easily measured with fairly inexpensive electronics. *Lidar* generally refers to laser-based schemes using time-of-flight or phase-shift measurement.

For any such active (reflective) sensors, effective detection range is dependent not only on emitted power levels, but also the following target characteristics:

- *Cross-sectional area*—determines how much of the emitted energy strikes the target.
- *Reflectivity*—determines how much of the incident energy is reflected versus absorbed or passed through.
- *Directivity*—determines how the reflected energy is redistributed (i.e., scattered versus focused).

Many noncontact sensors operate based on the physics of wave propagation. A wave is emitted at a reference point, and the range is determined by measuring either the propagation time from reference to target, or the decrease of intensity as the wave travels to the target and returns to the reference. Propagation time is measured using time-of-flight or frequency modulation methods.

Ranging by Time-of-Flight (TOF)

Time-of-flight (TOF) is illustrated in Figs. 19.61 and 19.62. A gated wave (a burst of a few cycles) is emitted, bounced back from the target, and detected at the receiver located near the emitter. The emitter and receiver may physically be both one sensor. The receiver may also be mounted on the target. The TOF is the time elapsed from the beginning of the burst to the beginning of the return signal. The distance is defined as $d = c \cdot \text{TOF}/2$ when emitter and receiver are at the same location, or $d = c \cdot \text{TOF}$ when the receiver is attached to the target. The accuracy is usually 1/4 of the wavelength when detecting the return signal, as its magnitude reaches a threshold limit. Gain is automatically increased with distance to maintain accuracy. Accuracy may be improved by detecting the maximum amplitude, as shown in Fig. 19.63. This makes detecting the time of arrival of the wave less dependent on the amplitude of the signal. Ultrasonic, RF, or optical energy sources are typically employed; the relevant parameters

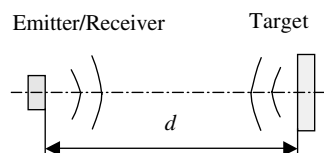

FIGURE 19.61 A wave is emitted and bounced from a target object. The distance d is determined from the speed of travel of the wave, c , and the time-of-flight, TOF as $d = (1/2) \cdot c \cdot \text{TOF}$.

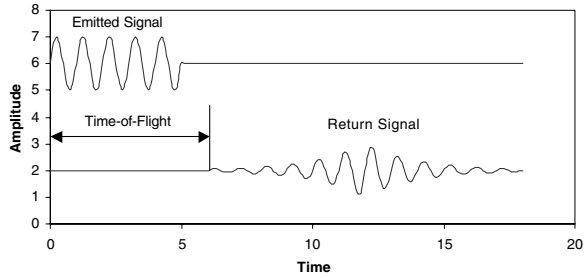

FIGURE 19.62 Definition of Time-of-Flight.

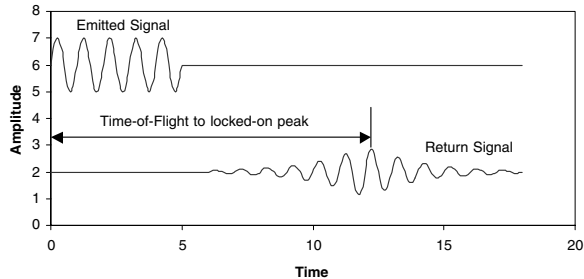

FIGURE 19.63 TOF to the maximum amplitude of the received signal for improved accuracy.

involved in range calculation, therefore, are the speed of sound in air (roughly 0.305 m/ms), and the speed of light (0.305 m/ns).

Potential error sources for TOF systems include the following:

- Variations in the speed of propagation, particularly in the case of acoustical systems
- Uncertainties in determining the exact time of arrival of the reflected pulse (Figuroa & Lamancusa, 1992)
- Inaccuracies in the timing circuitry used to measure the round-trip time of flight
- Interaction of the incident wave with the target surface

Propagation Speed—For most applications, changes in the propagation speed of electromagnetic energy are for the most part inconsequential and can basically be ignored, with the exception of satellite-based position-location systems. This is not the case, however, for acoustically based systems, where the speed of sound is markedly influenced by temperature changes, and to a lesser extent by humidity. (The speed of sound is actually proportional to the square root of temperature in degrees Rankine; an ambient temperature shift of just 30° can cause a 1-ft error at a measured distance of 35 ft.)

Detection Uncertainties—So-called *time-walk errors* are caused by the wide dynamic range in returned signal strength as a result of (1) varying reflectivity of target surfaces, and (2) signal attenuation to the fourth power of distance due to spherical divergence. These differences in returned signal intensity influence the rise time of the detected pulse, and in the case of fixed-threshold detection will cause the less reflective targets to appear further away (Lang et al., 1989). For this reason, *constant fraction timing discriminators* are typically employed to establish the detector threshold at some specified fraction of the peak value of the received pulse (Vuylsteke et al., 1990; Figuroa & Doussis, 1993).

Timing Considerations—The relatively slow speed of sound in air makes TOF ranging a strong contender for low-cost acoustically based systems. Conversely, the propagation speed of electromagnetic energy can place severe requirements on associated control and measurement circuitry in optical or RF implementations. As a result, TOF sensors based on the speed of light require sub-nanosecond timing circuitry to

measure distances with a resolution of about a foot (Koenigsburg, 1982). More specifically, a desired resolution of 1 mm requires a timing accuracy of 3 ps (Vuylsteke et al., 1990). This capability is somewhat expensive to realize and may not be cost effective for certain applications, particularly at close range where high accuracies are required.

Surface Interaction—When light, sound, or radio waves strike an object, any detected echo represents only a small portion of the original signal. The remaining energy reflects in scattered directions and can be absorbed by or pass through the target, depending on surface characteristics and the angle of incidence of the beam. Instances where no return signal is received at all can occur because of specular reflection at the object surface, especially in the ultrasonic region of the energy spectrum. If the transmission source approach angle meets or exceeds a certain critical value, the reflected energy will be deflected outside the sensing envelope of the receiver. Scattered signals can reflect from secondary objects as well, returning to the detector at various times to generate false signals that can yield questionable or otherwise noisy data. To compensate, repetitive measurements are usually averaged to bring the signal-to-noise ratio within acceptable levels, but at the expense of additional time required to determine a single range value.

Ultrasonic TOF Systems

Ultrasonic TOF ranging is today the most common noncontact technique employed, primarily due to the ready availability of low-cost systems and their ease of interface. Over the past few decades, much research has been conducted in investigating applications in mobile robotics for world modeling and collision avoidance, position estimation, and motion detection. Several researchers have assessed the effectiveness of ultrasonic sensors in exterior settings (Pletta et al., 1992; Langer & Thorpe, 1992; Pin & Watanabe, 1993; Hammond, 1994). In the automotive industry, BMW now incorporates four piezoceramic transducers (sealed in a membrane for environmental protection) on both front and rear bumpers in its Park Distance Control system (Siuru, 1994).

The Polaroid ranging module is an active TOF device developed for automatic camera focusing and determines the range to target by measuring elapsed time between transmission of an ultrasonic waveform and the detected echo (Biber et al., 1980). Probably the single most significant sensor development is from the standpoint of its catalytic influence on the robotics research community and industrial applications; this system is the most widely found in the literature (Koenigsburg, 1982; Moravec & Elfes, 1985; Everett, 1985; Kim, 1986; Arkin, 1989; Borenstein & Koren, 1990). Representative of the general characteristics of a number of such ranging devices, the Polaroid unit soared in popularity as a direct consequence of its extremely low cost (Polaroid offers both the transducer and ranging module circuit board for less than \$50), made possible by high-volume usage in its original application as a camera auto-focus sensor.

The most basic configuration consists of two fundamental components: (1) the ultrasonic transducer, and (2) the ranging module electronics. A choice of transducer types is now available. In the original instrument-grade electrostatic version (Fig. 19.64), a very thin metalized diaphragm mounted on a machined backplate forms a capacitive transducer (Polaroid, 1981). A smaller diameter electrostatic transducer (*7000-Series*) has also been made available, developed for the Polaroid *Spectra* camera (Polaroid, 1987). A ruggedized piezoelectric (*9000-Series environmental transducer*) introduced for applications that may be exposed to rain, heat, cold, salt spray, and vibration is able to meet or exceed guidelines set forth in the SAE J1455 January 1988 specification for heavy-duty trucks. The range of the Polaroid system runs from about 0.3 m (1 ft) out to 10.5 m (35 ft), with a half-power (−3 dB) beam dispersion angle of approximately 12° for the original instrument-grade electrostatic transducer. A typical operating cycle is as follows.

- The control circuitry fires the transducer and waits for an indication that transmission has begun.
- The receiver is blanked for a short period of time to prevent false detection due to residual transmit signal ringing in the transducer.
- The received signals are amplified with increased gain over time to compensate for the decrease in sound intensity with distance.

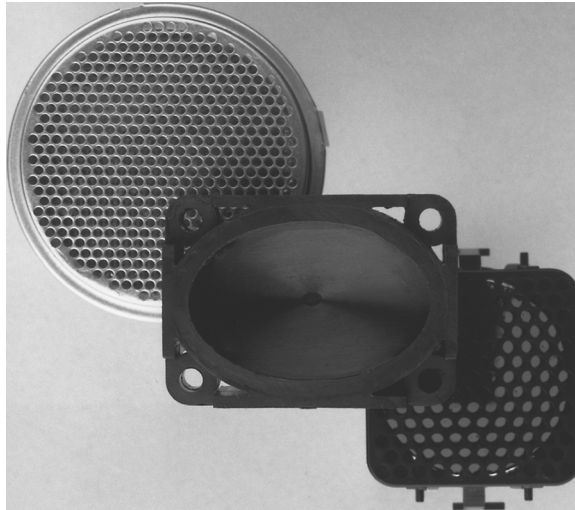

FIGURE 19.64 From left to right: (1) the original instrument grade electrostatic transducer, (2) 9000-Series environmental transducer, and (3) 7000 Series electrostatic transducer (courtesy Polaroid Corp.).

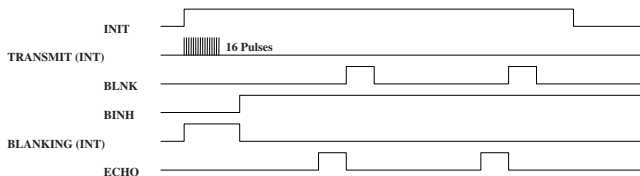

FIGURE 19.65 Timing diagrams for the 6500-Series Sonar Ranging Module executing a multiple-echo-mode cycle with blanking input (courtesy Polaroid Corp.).

- Returning echoes that exceed a fixed-threshold value are recorded and the associated distances calculated from elapsed time.

In the *single-echo* mode of operation for the 6500-series module, the *blank* (BLNK) and *blank-inhibit* (BINH) lines are held low as the *initiate* (INIT) line goes high to trigger the outgoing pulse train. The *internal blanking* (BLANKING) signal automatically goes high for 2.38 ms to prevent transducer ringing from being misinterpreted as a returned echo. Once a valid return is received, the echo (ECHO) output will latch high until reset by a high-to-low transition on INIT. For *multiple-echo* processing, the *blank* (BLNK) input must be toggled high for at least 0.44 ms after detection of the first return signal to reset the *echo* output for the next return, as shown in Fig. 19.65 (Polaroid, 1990).

Laser-Based TOF Systems

Laser-based TOF ranging systems, also known as *laser radar* or *lidar*, first appeared in work performed at the Jet Propulsion Laboratory, Pasadena, CA, in the 1970s (Lewis & Johnson, 1977). Laser energy is emitted in a rapid sequence of short bursts aimed directly at the object being ranged. The TOF of a given pulse reflecting off the object is used to calculate distance to the target based on the speed of light. Accuracies for early sensors of this type could approach a few centimeters over the range of 1–5 m (NASA, 1977; Depkovich & Wolfe, 1984).

Schwartz Electro-Optics, Inc. (SEO), Orlando, FL, produces a number of laser TOF rangefinding systems employing an innovative *time-to-amplitude-conversion* scheme to overcome the sub-nanosecond timing requirements necessitated by the speed of light. As the laser fires, a precision film capacitor begins discharging from a known set point at a constant rate, with the amount of discharge being proportional



FIGURE 19.66 The *LRF-200* series rangefinder (courtesy Schwartz Electro Optics, Inc.).



FIGURE 19.67 The Class 1 (eye-safe) *LD90-3 series* TOF laser rangefinder is a self-contained unit available in several versions with maximum ranges of 150–500 m under average atmospheric conditions (courtesy RIEGL USA).

to the round-trip time-of-flight (Gustavson & Davis, 1992). An analog-to-digital conversion is performed on the sampled capacitor voltage; at the precise instant a return signal is detected, whereupon the resulting digital representation is converted to range and time-walk corrected using a look-up table.

The *LRF-X* series rangefinder shown in Fig. 19.66 features a compact size, high-speed processing, and an ability to acquire range information from most surfaces (i.e., minimum 10% Lambertian reflectivity) out to a maximum of 100 m. The basic system uses a pulsed InGaAs laser diode in conjunction with an avalanche photodiode detector and is available with both analog and digital (RS-232) outputs.

RIEGL Laser Measurement Systems, Horn, Austria, offers a number of commercial products (i.e., laser binoculars, surveying systems, “speed guns,” level sensors, profile measurement systems, and tracking laser scanners) employing short-pulse TOF laser ranging. Typical applications include lidar altimeters, vehicle speed measurement for law enforcement, collision avoidance for cranes and vehicles, and level sensing in silos.

The RIEGL *LD90-3 series* laser rangefinder (Fig. 19.67) employs a near-infrared laser diode source and a photodiode detector to perform TOF ranging out to 500 m with diffuse surfaces, and to over 1000 m in the case of cooperative targets. Round-trip propagation time is precisely measured by a quartz-stabilized clock and converted to measured distance by an internal microprocessor, using one of two available algorithms. The *clutter suppression* algorithm incorporates a combination of range measurement averaging and noise rejection techniques to filter out backscatter from airborne particulates, and is, therefore, useful when operating under conditions of poor visibility (Riegel, 1994). The *standard measurement* algorithm, on the other hand, provides rapid range measurements without regard for noise suppression, and can subsequently deliver a higher update rate under more favorable environmental conditions.

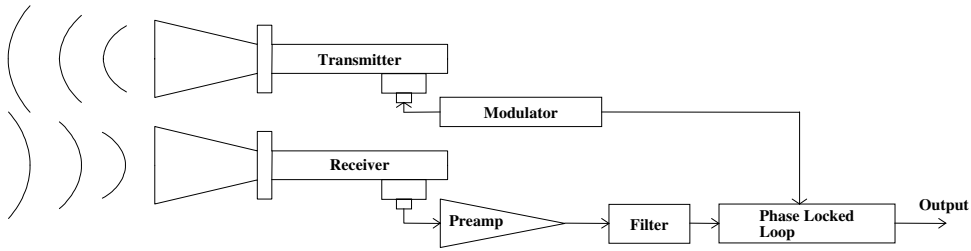

FIGURE 19.68 The microwave sensor, unlike the motion detector, requires a separate transmitter and receiver (adapted from Williams, 1989).

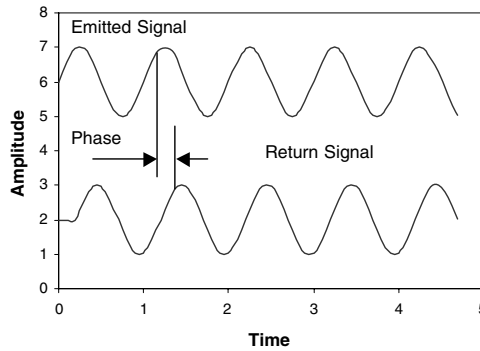

FIGURE 19.69 Range from phase measurement.

Worst-case range measurement accuracy is ± 5 cm, with typical values of around ± 2 cm. The pulsed near-infrared laser is Class-1 eye-safe under all operating conditions.

Microwave Range Sensors

Microwave technology may be used to measure motion, velocity, range, and direction of motion (Fig. 19.68). The sensors are rugged since they have no moving parts. They can be operated safely in explosive environments, because the level of energy used is very low (no risk for sparks). Their operating temperatures range from -55°C to $+125^{\circ}\text{C}$. They can work in environments with dust, smoke, poisonous gases, and radioactivity (assuming the components are hardened for radiation). Typically microwave sensors are used to measure ranges from 25 to 45,000 mm, but longer ranges are possible depending on power and object size. The reflected power returning to the receiver decreases as the fourth power of the distance to the object. Typical wavelength used ranges from 1 to 1000 mm.

Time-of-flight is in the order 2 ns per foot of range (reach the target and return). This translates into 10.56 ms per mile of range. Measuring short ranges may pose a problem. For 1 in. resolution, the circuit must resolve 167 ps. An alternate method more suitable to measure short distances is based on a frequency sweep of the signal generator. In this case, the return signal remains at the initial frequency (usually 10.525 GHz), and it is compared with the current frequency changed by a sweep rate. For example, to measure a range of 3 ft, one may sweep at 5 MHz/ms. After 6 ns, the frequency changes by 30 Hz ($6 \text{ ns} \times 5 \text{ MHz}/0.001 \text{ s}$). In this case, 0.0256 mm (0.001 in.) may be resolved easily. When using this method, a signal amplifier that increases gain with frequency is necessary. See section “Frequency Modulation” for more details on frequency modulation methods.

Phase Measurement

Time-of-flight (TOF) is defined as a phase shift between emitted and received signals when the distance is less than one wavelength (Fig. 19.69). Given a phase shift f , the distance is calculated as

$d = \phi\lambda/4\pi = \phi c/4\pi f$ if the emitter and receiver are at the same location, or $d = \phi\lambda/2\pi = \phi c/2\pi f$ if the receiver is attached to the target, where c is the speed of travel, ϕ is the measured phase, and f is the modulation frequency.

The phase shift between outgoing and reflected sine waves can be measured by multiplying the two signals together in an electronic mixer, then averaging the product over many modulation cycles (Woodbury et al., 1993). This integrating process can be relatively time consuming, making it difficult to achieve extremely rapid update rates. The result can be expressed mathematically as follows (Woodbury et al., 1993):

$$\lim_{T \rightarrow \infty} \frac{1}{T} \int_0^T \sin\left(\frac{2\pi c}{\lambda}t + \frac{4\pi d}{\lambda}\right) \sin\left(\frac{2\pi c}{\lambda}\right) dt \quad (19.70)$$

which reduces to

$$A \cos\left(\frac{4\pi d}{\lambda}\right) \quad (19.71)$$

where t is the time, T is the averaging interval, and A is the amplitude factor from gain of integrating amplifier.

From the earlier expression for ϕ , it can be seen that the quantity actually measured is in fact the *cosine* of the phase shift and not the phase shift itself (Woodbury et al., 1993). This situation introduces a so-called *ambiguity interval* for scenarios where the round-trip distance exceeds the modulation wavelength λ (i.e., the phase measurement becomes ambiguous once ϕ exceeds 360°). Conrad and Sampson (1990) define this ambiguity interval as the maximum range that allows the phase difference to go through one complete cycle of 360° :

$$R_a = \frac{c}{2f} \quad (19.72)$$

where R_a is the ambiguity range interval.

Referring to Eq. (19.73), it can be seen that the total round-trip distance $2d$ is equal to some integer number of wavelengths $n\lambda$ plus the fractional wavelength distance x associated with the phase shift. Since the cosine relationship is not single-valued for all of ϕ , there will be more than one distance d corresponding to any given phase-shift measurement (Woodbury et al., 1993):

$$\cos\phi = \cos\left(\frac{4\pi d}{\lambda}\right) = \cos\left(\frac{2\pi(x + n\lambda)}{\lambda}\right) \quad (19.73)$$

where

- $d = (x + n\lambda)/2 =$ true distance to target,
- $x =$ distance corresponding to differential phase ϕ ,
- $n =$ number of complete modulation cycles.

Careful re-examination of Eq. (19.73), in fact, shows that the cosine function is not single-valued even within a solitary wavelength interval of 360° . Accordingly, if only the cosine of the phase angle is measured, the ambiguity interval must be further reduced to half the modulation wavelength, or 180° (Scott, 1990). In addition, the slope of the curve is such that the rate of change of the nonlinear cosine function is not constant over the range of $0 \leq \phi \leq 180^\circ$, and is in fact zero at either extreme. The achievable accuracy of the phase-shift measurement technique thus varies as a function of target distance, from best-case

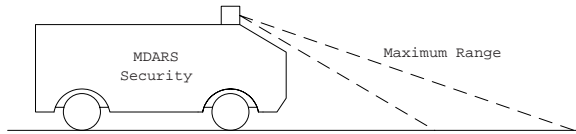

FIGURE 19.70 By limiting the maximum distance measured to be less than the range ambiguity interval R_a , erroneous distance measurements can be avoided.

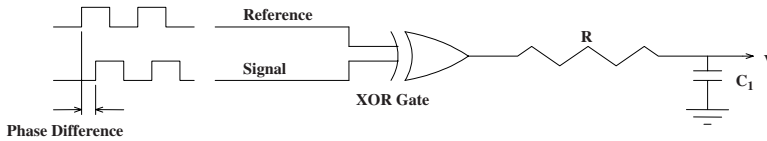

FIGURE 19.71 At low frequencies typical of ultrasonic systems, a simple phase-detection circuit based on an *exclusive-or* gate will generate an analog output voltage proportional to the phase difference seen by the inputs (adapted from Figueroa & Barbieri, 1991a).

performance for a phase angle of 90° to worst case at 0 and 180° . For this reason, the useable measurement range is typically even further limited to 90% of the 180° ambiguity interval (Chen et al., 1993).

A common solution to this problem involves taking a second measurement of the same scene but with a 90° phase shift introduced into the reference waveform, the net effect being the sine of the phase angle is then measured instead of the cosine. This additional information (i.e., both sine and cosine measurements) can be used to expand the phase angle ambiguity interval to the full 360° limit previously discussed (Scott, 1990). Furthermore, an overall improvement in system accuracy is achieved, as for every region where the cosine measurement is insensitive (i.e., zero slope), the complementary sine measurement will be at peak sensitivity (Woodbury et al., 1993).

Nevertheless, the unavoidable potential for erroneous information as a result of the ambiguity interval is a detracting factor in the case of phase-detection schemes. Some applications simply avoid such problems by arranging the optical path in such a fashion as to ensure the maximum possible range is always less than the ambiguity interval (Fig. 19.70). Alternatively, successive measurements of the same target using two different modulation frequencies can be performed, resulting in two equations with two unknowns, allowing both x and n (in the previous equation) to be uniquely determined. Kerr (1988) describes such an implementation using modulation frequencies of 6 and 32 MHz.

For square-wave modulation at the relatively low frequencies typical of ultrasonic systems (20–200 kHz), the phase difference between incoming and outgoing waveforms can be measured with the simple linear circuit shown in Fig. 19.71 (Figueroa & Barbieri, 1991a). The output of the *exclusive-or* gate goes high whenever its inputs are at opposite logic levels, generating a voltage across capacitor C_1 that is proportional to the phase shift. For example, when the two signals are in phase (i.e., $\phi = 0$), the gate output stays low and V is zero; maximum output voltage occurs when ϕ reaches 180° . While easy to implement, this simplistic approach is limited to very low frequencies and may require frequent calibration to compensate for drifts and offsets due to component aging or changes in ambient conditions (Figueroa & Lamancusa, 1992).

Extended Range Phase Measurement Systems

Figueroa and Barbieri (1991a; 1991b) report an interesting method for extending the ambiguity interval in ultrasonic phase-detection systems through frequency division of the received and reference signals. Since the span of meaningful comparison is limited (best case) to one wavelength, λ , it stands to reason that decreasing the frequency of the phase detector inputs by some common factor will increase λ by a similar amount. The concept is illustrated in Fig. 19.72. Due to the very short wavelength of ultrasonic energy (i.e., about 0.25 in. for the Polaroid system at 49.1 kHz), the total effective range is still only 4 in.

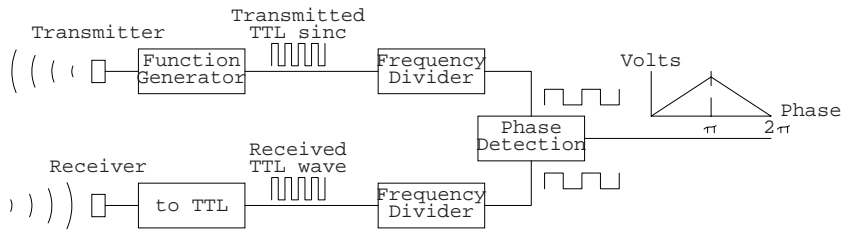

FIGURE 19.72 Dividing the input frequencies to the phase comparator by some common integer value will extend the ambiguity interval by the same factor, at the expense of resolution (adapted from Figueroa & Barbieri, 1991a).

after dividing the detector inputs by a factor of 16. Due to this inherent range limitation, ultrasonic phase-detection ranging systems are not extensively applied in mobile robotic applications, although Figueroa and Lamancusa (1992) describe a hybrid approach used to improve the accuracy of TOF ranging for three-dimensional position location.

An ingenious method to measure range using phase information was developed by Young and Li (1992). The method reconstructs the total range by piecing together multiple consecutive phase chunks that reset every 2π radians of phase difference between emitted and received signals. This is another method that overcomes the limitation of phase-based systems to ranges shorter than one acoustic wavelength. The discontinuities at every 2π radians are eliminated by first taking the derivative of the phase, resulting in a smooth signal with sharp pulses (impulses) at the location of each discontinuity. Subsequently, the pulses are ignored and the result is integrated and multiplied by a constant to reconstruct the overall range. The method was tested with an experiment that employed 40 kHz transducers. Distances from 40 to 400 mm were measured with errors from ± 0.1629 to ± 0.4283 mm.

Laser-based continuous-wave ranging originated out of work performed at the Stanford Research Institute in the 1970s (Nitzan et al., 1977). Range accuracies approach those achievable by pulsed laser TOF methods. Only a slight advantage is gained over pulsed TOF rangefinding, however, since the difficult time-measurement problem is replaced by the need for fairly sophisticated phase-measurement electronics (Depkovich & Wolfe, 1984). In addition, problems with the phase-shift measurement approach are routinely encountered in situations where the outgoing energy is simultaneously reflected from two target surfaces at different distances from the sensor, as for example when scanning past a prominent vertical edge (Hebert & Krotkov, 1991).

The system electronics are set up to compare the phase of a single incoming wave with that of the reference signal and are not able to cope with two superimposed reflected waveforms. Adams (1993) describes a technique for recognizing the occurrence of this situation in order to discount the resulting erroneous data.

Frequency Modulation

This is a method devised to improve the accuracy in detecting the time-of-arrival of the wave to the receiver. Instead of a single frequency wave, a frequency modulated wave of the form $f = f_0 + kt$ is emitted. The difference between the emitted and received frequency at any time is $\Delta f = kt - k(t - t_f) = kt_f$ (Fig. 19.73). The advantage of this method is that one does not need to know exactly when the wave arrived to the receiver. However, accurate real-time frequency measurement electronics must be used, and the transducers must respond within the frequency band sweep. Modulation other than linear is also possible in order to improve signal-to-noise ratio and hence accuracy.

The signal is reflected from a target and arrives at the receiver at time $t + T$:

$$T = \frac{2d}{c}$$

where T is the round-trip propagation time, d is the distance to target, and c is the speed of travel.

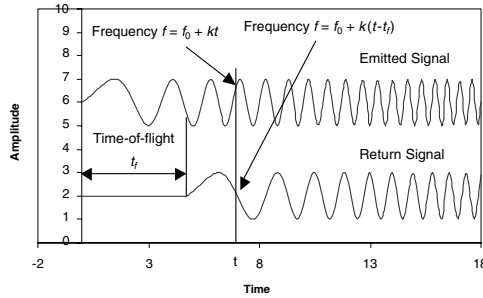

FIGURE 19.73 The frequency difference between the emitted signal and received signal is proportional to the time-of-flight at any given time.

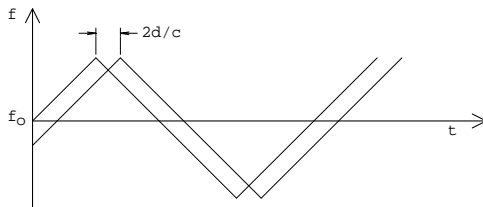

FIGURE 19.74 The received frequency curve is shifted along the time axis relative to the reference frequency.

The received signal is compared with a reference signal taken directly from the transmitter. The received frequency curve (Fig. 19.74) will be displaced along the time axis relative to the reference frequency curve by an amount equal to the time required for wave propagation to the target and back. (There might also be a vertical displacement of the received waveform along the frequency axis, due to the Doppler effect.) These two frequencies when combined in the mixer produce a beat frequency F_b :

$$F_b = f(t) - f(T + t) = kT$$

where k is a constant.

This beat frequency is measured and used to calculate the distance to the object:

$$d = \frac{F_b c}{4F_r F_d}$$

where

- d = range to target,
- c = speed of light,
- F_b = beat frequency,
- F_r = repetition (modulation) frequency,
- F_d = total FM frequency deviation.

Distance measurement is therefore directly proportional to the difference or beat frequency and is as accurate as the linearity of the frequency variation over the counting interval.

Advances in wavelength control of laser diodes now permit this ultrasonic and radar ranging technique to be used with lasers. The frequency or wavelength of a laser diode can be shifted by varying its temperature. Consider an example where the wavelength of an 850-nm laser diode is shifted by 0.05 nm in 4 μ s: the corresponding frequency shift is 5.17 MHz/ns. This laser beam, when reflected from a surface

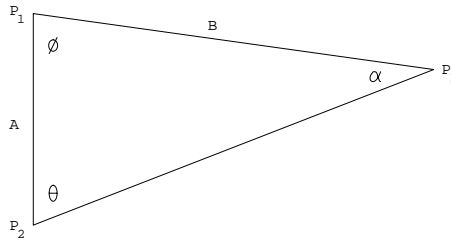

FIGURE 19.75 Triangulation ranging systems determine range B to target point P_3 by measuring angles f and q at points P_1 and P_2 .

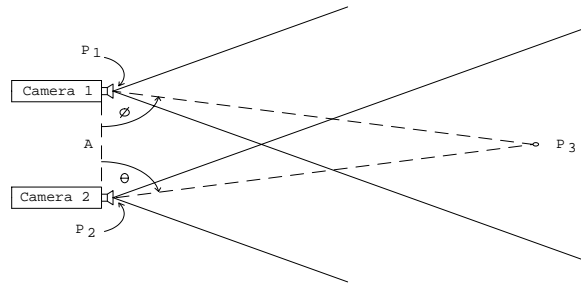

FIGURE 19.76 Passive stereoscopic ranging system configuration.

1 m away, would produce a beat frequency of 34.5 MHz. The linearity of the frequency shift controls the accuracy of the system.

The frequency-modulation approach has an advantage over the phase-shift measurement technique in which a single distance measurement is not ambiguous. (Recall that phase-shift systems must perform two or more measurements at different modulation frequencies to be unambiguous.) However, frequency modulation has several disadvantages associated with the required linearity and repeatability of the frequency ramp, as well as the coherence of the laser beam in optical systems. As a consequence, most commercially available FMCW ranging systems are radar based, while laser devices tend to favor TOF and phase-detection methods.

Triangulation Ranging

Triangulation ranging is based upon an important premise of plane trigonometry, which states that given the length of a side and two angles of a triangle, it is possible to determine the length of the other sides and the remaining angle. The basic *Law of Sines* can be rearranged as shown below to represent the length of side B as a function of side A and the angles θ and ϕ :

In ranging applications, length B would be the desired distance to the object of interest at point P_3 (Fig. 19.75) for known sensor separation baseline A .

Triangulation ranging systems are classified as either *passive* (use only the ambient light of the scene) or *active* (use an energy source to illuminate the target). Passive stereoscopic ranging systems position directional detectors (video cameras, solid-state imaging arrays, or position sensitive detectors) at positions corresponding to locations P_1 and P_2 (Fig. 19.76). Both imaging sensors are arranged to view the same object point, P_3 , forming an imaginary triangle. The measurement of angles θ and ϕ in conjunction with the known orientation and lateral separation of the cameras allows the calculation of range to the object of interest.

Active triangulation systems, on the other hand, position a controlled light source (such as a laser) at either point P_1 or P_2 , directed at the observed point P_3 . A directional imaging sensor is placed at the remaining triangle vertex and is also aimed at P_3 . Illumination from the source will be reflected by the

target, with a portion of the returned energy falling on the detector. The lateral position of the spot as seen by the detector provides a quantitative measure of the unknown angle ϕ , permitting range determination by the *Law of Sines*.

The performance characteristics of triangulation systems are to some extent dependent on whether the system is active or passive. Passive triangulation systems using conventional video cameras require special ambient lighting conditions that must be artificially provided if the environment is too dark. Furthermore, these systems suffer from a correspondence problem resulting from the difficulty in matching points viewed by one image sensor with those viewed by the other. On the other hand, active triangulation techniques employing only a single detector do not require special ambient lighting, nor do they suffer from the correspondence problem. Active systems, however, can encounter instances of no recorded strike because of specular reflectance or surface absorption of the light.

Limiting factors common to all triangulation sensors include reduced accuracy with increasing range, angular measurement errors, and a *missing parts* (also known as *shadowing*) problem. *Missing parts* refers to the scenario where particular portions of a scene can be observed by only one viewing location (P_1 or P_2). This situation arises because of the offset distance between P_1 and P_2 , causing partial occlusion of the target (i.e., a point of interest is seen in one view but otherwise occluded or not present in the other). The design of triangulation systems must include a tradeoff analysis of the offset: as this baseline measurement increases, the range accuracy increases, but problems due to directional occlusion worsen.

Stereo Disparity

The first of the triangulation schemes to be discussed, *stereo disparity* (also called *stereo vision*, *binocular vision*, and *stereopsis*) is a passive ranging technique modeled after the biological counterpart. When a three-dimensional object is viewed from two locations on a plane normal to the direction of vision, the image as observed from one position is shifted laterally when viewed from the other. This displacement of the image, known as *disparity*, is inversely proportional to the distance to the object. Humans subconsciously *verge* their eyes to bring objects of interest into rough registration (Burt et al., 1992). Hold up a finger a few inches away from your face while focusing on a distant object and you can simultaneously observe two displaced images in the near field. In refocusing on the finger, your eyes actually turn inward slightly to where their respective optical axes converge at the finger instead of infinity.

Most implementations use a pair of identical video cameras (or a single camera with the ability to move laterally) to generate the two disparity images required for stereoscopic ranging. The cameras are typically aimed straight ahead viewing approximately the same scene, but (in simplistic cases anyway) do not possess the capability to *verge* their center of vision on an observed point, as can human eyes. This limitation makes placement of the cameras somewhat critical because stereo ranging can take place only in the region where the fields of view overlap. In practice, analysis is performed over a selected range of disparities along the Z axis on either side of a perpendicular plane of zero disparity called the *horopter* (Fig. 19.77). The selected image region in conjunction with this disparity range defines a three-dimensional volume known as the *stereo observation window* (Burt et al., 1993).

More recently there has evolved a strong interest within the research community for dynamically reconfigurable camera orientation (Fig. 19.78), often termed *active vision* in the literature (Aloimonos et al., 1987; Swain & Stricker, 1991; Wavering et al., 1993). The widespread acceptance of this terminology is perhaps somewhat unfortunate in view of potential confusion with stereoscopic systems employing an active illumination source (see section 4.1.3). *Verging stereo*, another term in use, is perhaps a more appropriate choice. *Mechanical verging* is defined as the process of rotating one or both cameras about the vertical axis in order to achieve zero disparity at some selected point in the scene (Burt et al., 1992).

There are four basic steps involved in the stereo ranging process (Poggio, 1984):

- A point in the image of one camera must be identified (Fig. 19.79, left).
- The same point must be located in the image of the other camera (Fig. 19.79, right).
- The lateral positions of both points must be measured with respect to a common reference.
- Range Z is then calculated from the disparity in the lateral measurements.

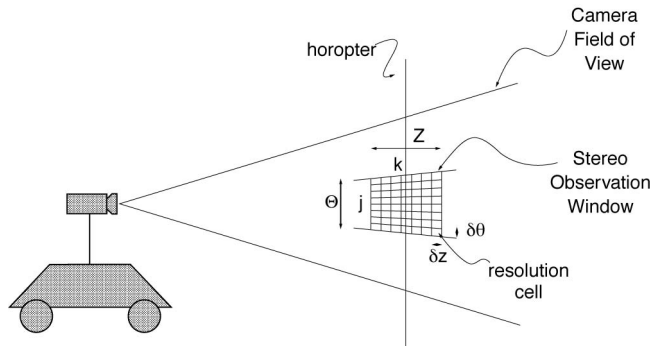

FIGURE 19.77 The *stereo observation window* is that volume of interest on either side of the plane of zero disparity known as the *horopter* (courtesy David Sarnoff Research Center).

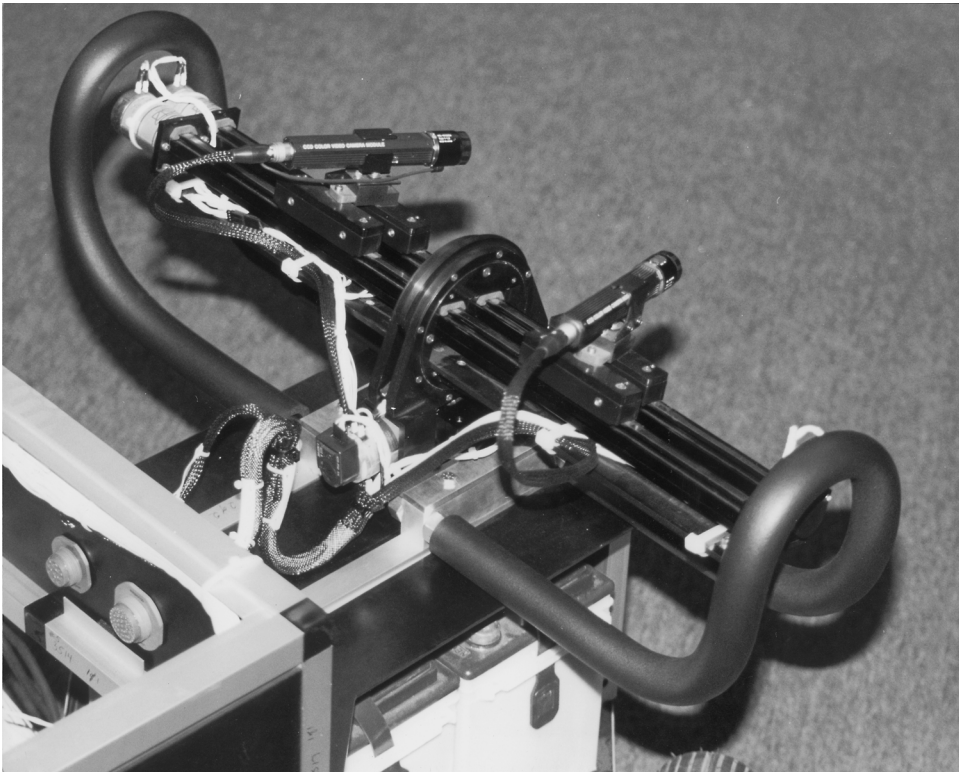

FIGURE 19.78 This stereoscopic camera mount uses a pair of lead-screw actuators to provide reconfigurable baseline separation and vergence as required (courtesy Robotic Systems Technology, Inc.).

On the surface this procedure appears rather straightforward, but difficulties arise in practice when attempting to locate the specified point in the second image (Fig. 19.79). The usual approach is to match “interest points” characterized by large intensity discontinuities (Conrad & Sampson, 1990). Matching is complicated in regions where the intensity and/or color are uniform (Jarvis, 1983b). Additional factors include the presence of shadows in only one image (due to occlusion) and the variation in image characteristics that can arise from viewing environmental lighting effects from different angles. The effort to match the two images of the point is called *correspondence*, and methods for minimizing this

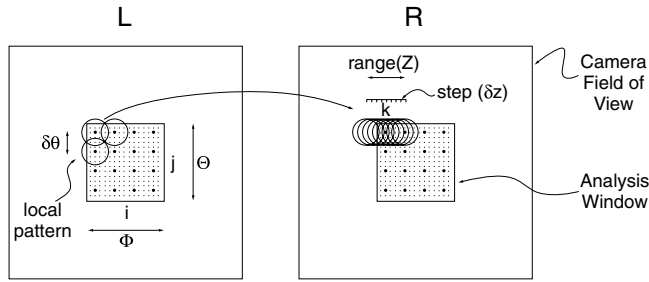

FIGURE 19.79 Range Z is derived from the measured disparity between interest points in the left and right camera images (courtesy David Sarnoff Research Center).

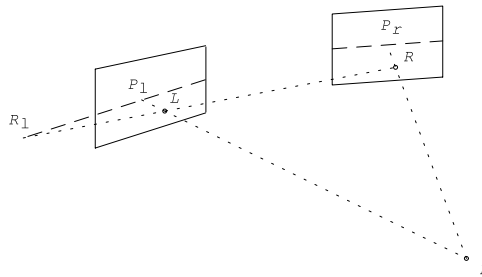

FIGURE 19.80 The *epipolar surface* is a plane defined by the lens centerpoints L and R and the object of interest at P (adapted from Vuylsteke et al., 1990).

computationally expensive procedure are widely discussed in the literature (Nitzan, 1981; Jarvis, 1983a; Poggio, 1984; Loewenstein, 1984; Vuylsteke et al., 1990; Wildes, 1991).

Probably the most basic simplification employed in addressing the otherwise overwhelming *correspondence* problem is seen in the *epipolar restriction* that reduces the two-dimensional search domain to a single dimension (Vuylsteke et al., 1990). The *epipolar surface* is a plane defined by the point of interest P and the positions of the left and right camera lenses at L and R , as shown in Fig. 19.80. The intersection of this plane with the left image plane defines the *left epipolar line* as shown. As can be seen from the diagram, since the point of interest P lies in the *epipolar plane*, its imaged point P_L must lie somewhere along the *left epipolar line*. The same logic dictates that the imaged point P_R must lie along a similar *right epipolar line* within the right image plane. By carefully aligning the camera image planes such that the *epipolar lines* coincide with identical scan lines in their respective video images, the correspondence search in the second image is constrained to the same horizontal scan line containing the point of interest in the first image. This effect can also be achieved with nonaligned cameras by careful calibration and rectification (resampling).

To reduce the image processing burden, most correspondence schemes monitor the overall scene at relatively low resolution and examine only selected areas in greater detail. A *foveal representation* analogous to the acuity distribution in human vision is generally employed as illustrated in Fig. 19.81, allowing an extended field-of-view without loss of resolution or increased computational costs (Burt et al., 1993). The high-resolution *fovea* must be shifted from frame to frame in order to examine different regions of interest individually. Depth acuity is greatest for small disparities near the horopter and falls off rapidly with increasing disparities (Burt et al., 1992).

Active Triangulation

Rangefinding by *active triangulation* is a variation on the *stereo disparity* method of distance measurement. In place of one camera is a laser (or LED) light source aimed at the surface of the object of interest.

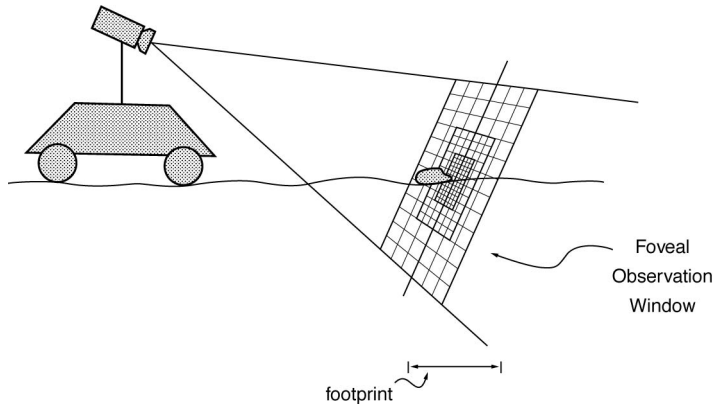

FIGURE 19.81 The *foveal* stereo representation provides high acuity near the center of the *observation window*, with decreasing resolution towards the periphery (Courtesy David Sarnoff Research Center).

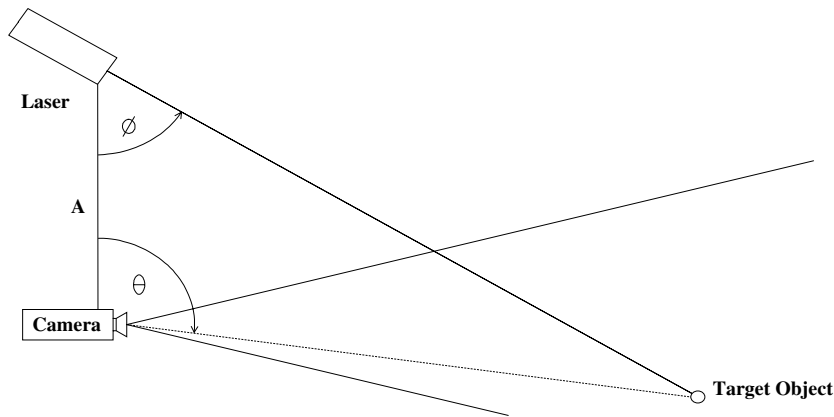

FIGURE 19.82 An *active triangulation-ranging* configuration employing a conventional CCD array as the detector.

The remaining camera is offset from this source by a known distance A and configured to hold the illuminated spot within its field of view (Fig. 19.82).

For one- or two-dimensional array detectors such as vidicon or CCD cameras, the range can be determined from the known baseline distance A and the relative position of the laser-spot image on the image plane. For mechanically scanned single-element detectors such as photodiodes or phototransistors, the rotational angles of the detector and/or source are measured at the exact instant the detector observes the illuminated spot. The trigonometric relationships between these angles and the baseline separation are used (in theory) to compute the distance. To obtain three-dimensional information for a volumetric region of interest, laser triangulators can be scanned in both azimuth and elevation. In systems where the source and detector are self-contained components, the entire configuration can be moved mechanically. In systems with movable optics, the mirrors and lenses are generally scanned in synchronization while the laser and detector remain stationary.

Drawbacks to active triangulation include the *missing parts* situation, where points illuminated by the light source cannot be seen by the camera and vice versa (Jarvis, 1983b), as well as surface absorption or specular reflection of the irradiating energy (see Chapter 9). On the positive side, however, point-source illumination of the image effectively eliminates the correspondence problem encountered in stereo disparity rangefinders. There is also no dependence on scene contrast, and reduced influence from ambient lighting effects. (Background lighting is effectively a noise source that can limit range resolution.)



FIGURE 19.83 HERMIES IIB employed an active stereoscopic ranging system with an external laser source that could be used to designate objects of interest in the video image (courtesy Oak Ridge National Laboratory).

Active Stereoscopic

Due to the computationally intensive complexities and associated resources required for establishing correspondence, passive stereoscopic methods were initially limited in practical embodiments to very simple scenes (Blais et al., 1988). One way around these problems is to employ an active source in conjunction with a pair of stereo cameras. This active illumination greatly improves system performance when viewing scenes with limited contrast. Identification of the light spot becomes a trivial matter; a video frame representing a scene illuminated by the source is subtracted from a subsequent frame of the same image with the light source deactivated. Simple thresholding of the resultant difference image quickly isolates the region of active illumination. This process is performed in rapid sequence for both cameras, and the lateral displacement of the centroid of the spot is then determined.

Alignment between the source and cameras is not critical in active stereoscopic ranging systems; in fact, the source does not even have to be located on board the robot. For example, Kilough and Hamel (1989) describe two innovative configurations using external sources for use with the robot HERMIES IIB, built at Oak Ridge National Laboratory. A pair of wide-angle black-and-white CCD cameras are mounted on a pan-and-tilt mechanism atop the robot's head, as shown in Fig. 19.83. Analog video outputs from the cameras are digitized by a frame grabber into a pair of 512 by 384-pixel arrays, with offboard image processing performed by a *Hypercube* at a scaled-down resolution of 256 by 256. The initial application of the vision system was to provide control of a pair of robotic arms (from the Heathkit *HERO-1* robot) employed on HERMIES.

To accomplish this task, a near-infrared LED is attached to the end of the *HERO-1* arm near the manipulator and oriented so as to be visible within the field of view of the stereo camera pair. A sequence of images is then taken by each camera, with the LED first *on* and then *off*. The *off* representations are subtracted from the *on* representations, leaving a pair of difference images, each comprised of a single bright dot representing the location of the LED. The centroids of the dots are calculated to

precisely determine their respective coordinates in the difference-image arrays. A range vector to the LED can then be easily calculated, based on the lateral separation of the dots as perceived by the two cameras. This technique establishes the actual location of the manipulator in the reference frame of the robot. Experimental results indicated a 2-in. accuracy with a 0.2-in. repeatability at a distance of approximately 2 ft (Kilough and Hamel, 1989).

A near-infrared solid-state laser mounted on a remote tripod was then used by the operator to designate a target of interest within the video image of one of the cameras. The same technique described above was repeated, only this time the imaging system toggled the laser power *on* and *off*. A subsequent differencing operation enabled calculation of a range vector to the target, also in the robot's reference frame. The difference in location of the gripper and the target object could then be used to effect both platform and arm motion. The imaging processes would alternate in near-real-time for the gripper and the target, enabling the HERMIES robot to drive over and grasp a randomly designated object under continuous closed-loop control.

Structured Light

Ranging systems that employ *structured light* are a further refined case of active triangulation. A pattern of light (either a line, a series of spots, or a grid pattern) is projected onto the object surface while the camera observes the pattern from its offset vantage point. Range information manifests itself in the distortions visible in the projected pattern due to variations in the depth of the scene. The use of these special lighting effects tends to reduce the computational complexity and improve the reliability of three-dimensional object analysis (Jarvis, 1983b; Vuylsteke et al., 1990). The technique is commonly used for rapid extraction of limited quantities of visual information of moving objects (Kent, 1985), and thus lends itself well to collision avoidance applications. Besl (1988) provides a good overview of *structured-light* illumination techniques, while Vuylsteke et al. (1990) classify the various reported implementations according to the following characteristics:

- The number and type of sensors
- The type of optics (i.e., spherical or cylindrical lens, mirrors, multiple apertures)
- The dimensionality of the illumination (i.e., point or line)
- Degrees of freedom associated with scanning mechanism (i.e., zero, one, or two)
- Whether or not the scan position is specified (i.e., the instantaneous scanning parameters are not needed if a redundant sensor arrangement is incorporated)

The most common *structured-light* configuration entails projecting a line of light onto a scene, originally introduced by P. Will and K. Pennington of IBM Research Division Headquarters, Yorktown Heights, NY (Schwartz, undated). Their system created a plane of light by passing a collimated incandescent source through a slit, thus projecting a line across the scene of interest. (More recent systems create the same effect by passing a laser beam through a cylindrical lens or by rapidly scanning the beam in one dimension.) Where the line intersects an object, the camera view will show displacements in the light stripe that are proportional to the depth of the scene. In the example depicted in Fig. 19.84, the lower the reflected illumination appears in the video image, the closer the target object is to the laser source. The exact relationship between stripe displacement and range is dependent on the length of the baseline

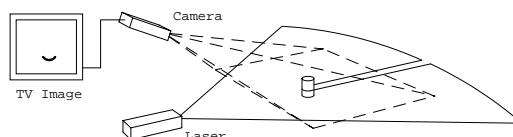

FIGURE 19.84 A common structured-light configuration used on robotic vehicles projects a horizontal line of illumination onto the scene of interest and detects any target reflections in the image of a downward-looking CCD array.

between the source and the detector. Like any triangulation system, when the baseline separation increases, the accuracy of the sensor increases, but the *missing parts* problem worsens.

Three-dimensional range information for an entire scene can be obtained in relatively simple fashion through striped lighting techniques. By assembling a series of closely spaced two-dimensional contours, a three-dimensional description of a region within the camera's field of view can be constructed. The third dimension is typically provided by scanning the laser plane across the scene. Compared to single-point triangulation, striped lighting generally requires less time to digitize a surface, with fewer moving parts because of the need to mechanically scan only in one direction. The drawback to this concept is that range extraction is time consuming and difficult due to the necessity of storing and analyzing many frames.

An alternative structured-light approach for three-dimensional applications involves projecting a rectangular grid of high-contrast light points or lines onto a surface. Variations in depth cause the grid pattern to distort, providing a means for range extraction. The extent of the distortion is ascertained by comparing the displaced grid with the original projected patterns as follows (LeMoigue & Waxman, 1984):

- Identify the intersection points of the distorted grid image.
- Label these intersections according to the coordinate system established for the projected pattern.
- Compute the disparities between the intersection points and/or lines of the two grids.
- Convert the displacements to range information.

The comparison process requires correspondence between points on the image and the original pattern, which can be troublesome. By correlating the image grid points to the projected grid points, this problem can be somewhat alleviated. A critical design parameter is the thickness of the lines that make up the grid and the spacing between these lines. Excessively thin lines will break up in busy scenes, causing discontinuities that adversely affect the intersection points labeling process. Thicker lines will produce less observed grid distortion resulting in reduced range accuracy (LeMoigue & Waxman, 1984). The sensor's intended domain of operation will determine the density of points required for adequate scene interpretation and resolution.

Magnetic Position Measurement Systems

Magnetic tracking uses a source element radiating a magnetic field (three axes) and a small sensor (three axes) that reports its position and orientation with respect to the source. Competing systems provide various multi-source, multi-sensor systems that will track a number of points at up to 100 Hz in ranges from 3 to 20 ft (Polhemus Incorporated, and Ascension Technologies). They are generally accurate to better than 0.1 in. in position and 0.1° in rotation. Magnetic systems do not rely on line-of-sight from source to object, as do optical and acoustic systems, but metallic objects in the environment will distort the magnetic field, giving erroneous readings. They require cable attachment to a central device (as do LEDs and acoustic systems). Current technology is quite robust and widely used for single or double hand-tracking, head-mounted devices, biomechanical analysis, graphics (digitization in 3D), stereotaxic localization, etc.

Magnetic field sources can be AC or DC. DC sources may emit pulses rather than continuous radiation in order to minimize interference from other magnetic sources. Using pulsed systems allows measurement of existing magnetic fields in the environment during the inactive period. Knowledge of these magnetic fields external to the system is used to improve accuracy and to overcome sensitivity to metals.

Figure 19.85 shows a typical transmitter-drive electronics (courtesy of Ascension Technologies). It provides DC current pulses to each antenna of the transmitter, one antenna at a time. The transmitter consists of a core about which the X, Y, and Z antennae are wound. While a given transmitter antenna is activated with current, readings are taken from all three antennae of the sensor. Initially the transmitter is shut off so that the sensor can measure the x , y , and z components of the earth's magnetic field. During operation, the computer sends to the digital-to-analog (D/A) converter a number that represents the amplitude of the current pulse to be sent to the selected transmitter antenna. The D/A converter converts

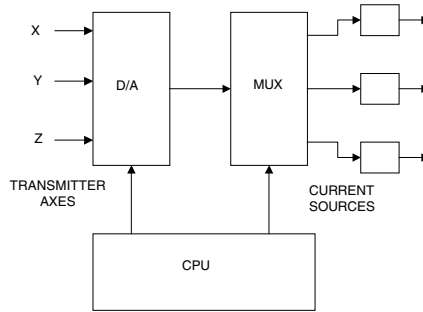

FIGURE 19.85 Magnetic Positioning System: Transmitting Circuit (Ascension Technologies).

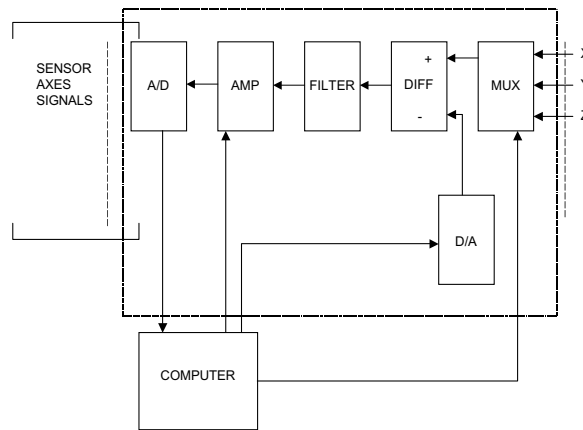

FIGURE 19.86 Magnetic Positioning System: Receiving Circuit (Ascension Technologies).

this amplitude to an analog control voltage. This control voltage goes to the multiplexer (MUX), which connects it to the X, Y, or Z transmitter current source.

The sensor consists of three orthogonal antennae sensitive to DC magnetic fields. Many technologies can be used to implement the DC sensor. The Flock (Ascension Technologies) uses a three-axis fluxgate magnetometer. The output from the sensor goes to the signal processing electronics. As detailed in Fig. 19.86, the sensor signal processing electronics consists of a multiplexer (MUX), which, on command from the computer, switches the desired X, Y, or Z sensor antenna signal, one at a time, to the differential amplifier (DIFF). The differential amplifier subtracts from this antenna signal the previously measured component of the earth's magnetic field. It outputs only that part of the received signal that is due to the transmitted field. The output from the differential amplifier is then filtered to remove noise and amplified. The analog-to-digital converter converts the DC signal to a digital format that can be read by the computer.

Other Distance Measuring Methods

The following methods are used to measure displacement, and thus can be used to infer distance travelled for certain applications.

Odometry

This is one of many methods to measure position and it is an indirect method of determining range. Range is determined by measuring the rotation of a wheel as it traverses from the reference to the target location. Wheel rotation is measured using angular encoders that may be digital or analog in nature.

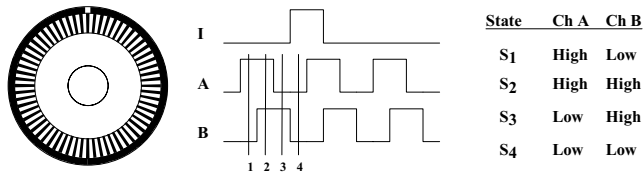

FIGURE 19.87 Optical Incremental Angular Encoder.

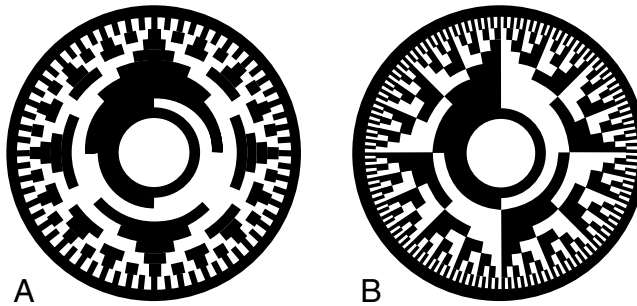

FIGURE 19.88 Absolute Optical Encoder.

Angular Optical Encoders

These devices encompass a light source, optics to shape and guide the light, a coded wheel with transparent and opaque sections, and a light detector array. There are two types of optical encoders: incremental and absolute.

Incremental Angular Optical Encoders. A schematic is shown in Fig. 19.87. The wheel is opaque except for the slots along the circumference. Two rows of slots displaced by a 90° phase are used to determine rotation and direction. As the wheel rotates, two pulse chains 90° out of phase with each other are generated (Channels A and B). Distance is determined by counting the number of pulses (and quarter pulses for increased resolution) from the initial arbitrary zero position. The reference is lost when power is interrupted. The direction of motion is defined by determining which pulse chain leads the other.

An index pulse that appears once per revolution is also usually available (Channel Z). The resolution depends upon the number of slots around the circumference. Larger wheels can accommodate higher resolution. The total distance traveled depends upon the system used to count pulses. Since pulse counting is done outside the sensor, distances in the meters may be measured.

Decoding of the pulses (Channels A, B, and Z) to obtain angular displacement is done using specialized chips (Hewlett Packard makes a family of chips), or full-fledged integrated circuit boards. Data acquisition boards with counters may also be programmed to decode range from these sensors.

Commercially available units have a maximum operating speed of about 6000 rpm, maximum counts per revolution of about 360,000, a maximum resolution of 0.001° , and a frequency response of up to 150 kHz.

Absolute Angular Optical Encoders. These encoders have a wheel which is coded in such a way that each angular slot represents a number of bits that may be either *on* (transparent) or *off* (opaque) (Fig. 19.88). Therefore, the angular position of the wheel has an absolute value given by the code of the angular slot currently aligned with the optics. Its position is known even after turning the power *off* and *on* again. When the optics crosses the line between two slots, the pattern changes to indicate an increment of one unit. However, the position is uncertain if the wheel stops with the optics right on the line. To decrease this uncertainty, the patterns are defined according to the Grey Code. In this coding scheme, only one bit of the pattern changes from one slot to the next. Thus, the uncertainty is minimized to one unit.

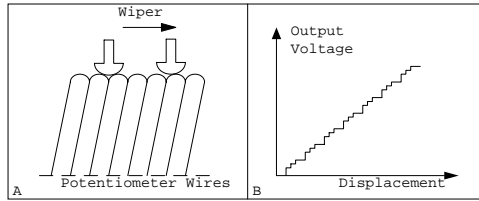

FIGURE 19.89 Potentiometer: Principle of Operation.

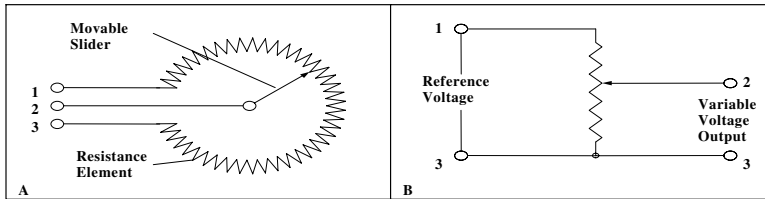

FIGURE 19.90 Potentiometer: Circuit Representation.

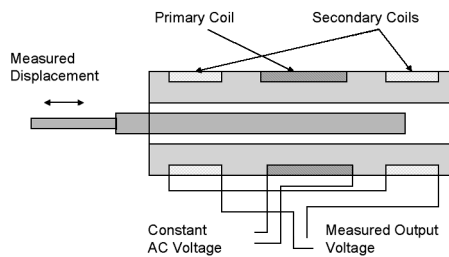

FIGURE 19.91 Linear Variable Differential Transformer.

These sensors are suitable to measure small ranges, in the order of hundreds of millimeters. Larger wheels can accommodate more slots and more bits per slot. Commercial units of 11 bits are available, with a resolution of $\pm 1/2$ of the least significant bit, and a frequency response of 100 K 11-bit words per second.

Linear Optical Encoders. These are the same as angular encoders, except that instead of a coded wheel, they have a coded bar and a slider that carries the optical and electronic components. Distance is measured along the bar. In commercial units, the maximum measuring distance is about 2.150 m, the maximum resolution 0.08 μm , and the maximum operating speed 508 mm/s.

Potentiometers

Potentiometers are variable electrical resistance transducers. They consist of a winding and a sliding contact. As the sliding contact moves along the winding, the resistance changes in linear relationship with the distance from one end of the potentiometer (Fig. 19.89). The variable resistance is wired as a voltage divider so that the output voltage is proportional to the distance traveled by the wiper (Fig. 19.90). The resolution is defined by the number of turns per unit distance, and loading effects of the voltage divider circuit should be considered.

Linear Variable Differential Transformers

The linear variable differential transformer (LVDT) generates an AC signal whose magnitude is related to the displacement of a moving core (Fig. 19.91). As the core changes position with respect to the coils, it changes the magnetic field, and thence the voltage amplitude in the secondary coil.

LVDT resolution depends on the instruments used to measure voltage. 25- μm resolution can be achieved. Stationary (low frequency) signals may be measured using an AC meter. High frequency signals require specialized electronics for demodulation or a data acquisition system to process the signal using a PC.

A rotary variable differential transformer (RVDT) operates under the same principle as the LVDT and is available with a range of approximately $\pm 40^\circ$.

Proximity Sensors

Proximity sensors, used to determine the presence (as opposed to actual range) of nearby objects, were developed to extend the sensing range beyond that afforded by direct-contact tactile or haptic sensors. Recent advances in electronic technology have significantly improved performance and reliability, thereby increasing the number of possible applications. As a result, many industrial installations that historically have used mechanical limit switches can now choose from a variety of alternative noncontact devices for their close (between a fraction of an inch and a few inches) sensing needs. Such *proximity sensors* are classified into several types in accordance with the specific properties used to initiate a switching action:

- Magnetic
- Inductive
- Ultrasonic
- Microwave
- Optical
- Capacitive

The reliability characteristics displayed by these sensors make them well suited for operation in harsh or otherwise adverse environments, while providing high-speed response and long service lives. Instruments can be designed to withstand significant shock and vibration, with some capable of handling forces over 30,000 Gs and pressures of nearly 20,000 psi (Hall, 1984). Burreson (1989) and Peale (1992) discuss advantages and tradeoffs associated with proximity sensor selection for applications in challenging and severe environments. In addition, proximity devices are valuable when detecting objects moving at high speed, when physical contact may cause damage, or when differentiation between metallic and nonmetallic items is required. Ball (1986), Johnson (1987), and Wojcik (1994) provide general overviews of various alternative proximity sensor types with suggested guidelines for selection.

Magnetic Proximity Sensors

The simplest form of magnetic proximity sensor is the *magnetic reed switch*, schematically illustrated in Fig. 19.92. A pair of low-reluctance ferromagnetic reeds are cantilevered from opposite ends of a hermetically sealed tube, arranged such that their tips overlap slightly without touching. The extreme ends of the reeds assume opposite magnetic polarities when exposed to an external magnetic flux, and the subsequent attractive force across the gap pulls the flexible reed elements together to make electrical contact (Hamlin, 1988).

Available in both *normally open* and *normally closed* configurations, these inexpensive and robust devices are commonly employed as door- and window-closure sensors in security applications. Some problems

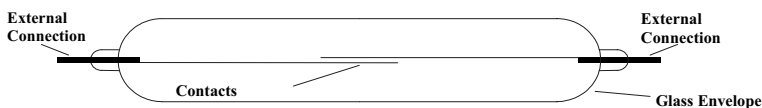

FIGURE 19.92 The hermetically sealed *magnetic reed switch*, shown here with normally open contacts, is filled with inert gas and impervious to dust and corrosion.

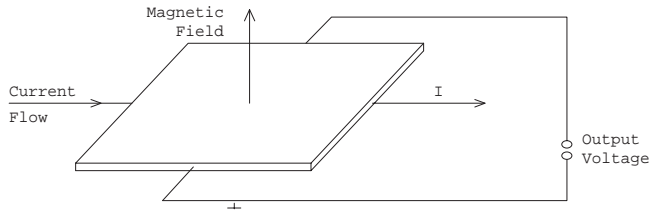

FIGURE 19.93 In 1879, E.H. Hall discovered a small transverse voltage was generated across a current-carrying conductor in the presence of a static magnetic field, a phenomenon now known as the *Hall effect* (adapted from Lenz, 1990).

can be encountered with this type of sensor due to contact bounce, structural vibration, and pitting of the mating surfaces in the case of inductive or capacitive loads (Burreson, 1989), prompting most designers to opt instead for the more reliable solid-state Hall-effect magnetic sensor.

The Hall effect, as it has come to be known, was discovered by E.H. Hall in 1879. Hall noted a very small voltage was generated in the transverse direction across a conductor carrying a current in the presence of an external magnetic field (Fig. 19.93), in accordance with the following equation (White, 1988):

$$V_h = \frac{R_h IB}{t}$$

where

V_h = Hall voltage,

R_h = material-dependent Hall coefficient,

I = current in amps,

B = magnetic flux density (perpendicular to I) in Gauss, and

t = element thickness in centimeters.

It was not until the advent of semiconductor technology (heralded by the invention of the transistor in 1948) that this important observation could be put to any practical use. Even so, early silicon implementations were plagued by a number of shortcomings that slowed popular acceptance, including high cost, temperature instabilities, and otherwise poor reliability (McDermott, 1969). Subsequent advances in integrated circuit technology (i.e., monolithic designs, new materials, and internal temperature compensation) have significantly improved both stability and sensitivity. With a 100-mA current flow through indium arsenide (InAs), for example, an output voltage of 60 mV can be generated with a flux density (B) of 10 kG (Hines, 1992). Large-volume applications in the automotive industry (such as distributor timing in electronic ignition systems) helped push the technology into the forefront in the late 1970s (White, 1988). Potential robotic utilization includes position and speed sensing, motor commutation (Manolis, 1993), guidepath following, and magnetic compasses.

The linear relationship of output voltage to transverse magnetic field intensity is an important feature contributing to the popularity of the modern *Hall-effect sensor*. To improve stability, *linear Hall-effect sensors* are generally packaged with an integral voltage regulator and output amplifier. The output voltage V_o fluctuates above and below a zero-field equilibrium position (usually half the power supply voltage V_{cc}), with the magnitude and direction of the offset determined by the field strength and polarity, respectively (White, 1988). (Note also that any deviation in *field direction* away from the perpendicular will also affect the magnitude of the voltage swing.) Frequency responses over 100 kHz are easily achieved (Wood, 1986).

The addition of a *Schmitt-trigger* threshold detector and an appropriate output driver transforms the linear Hall-effect sensor into a digital *Hall-effect switch*. Most commercially available devices employ transistor drivers that provide an open-circuit output in the absence of a magnetic field (Wood, 1986).

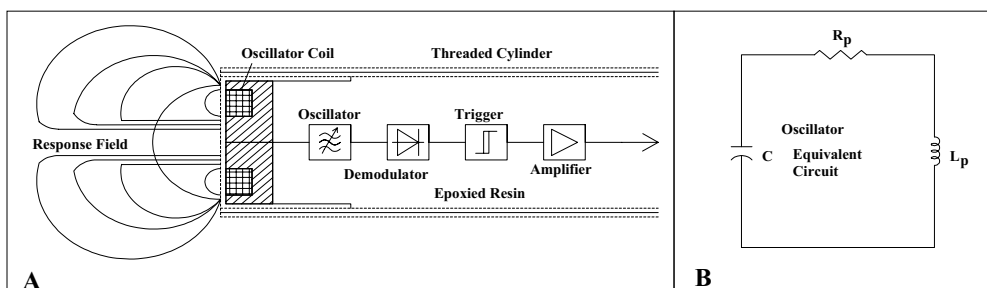

FIGURE 19.94 (A) Block diagram of a typical *ECKO*-type inductive proximity sensor (adapted from Smith, 1985), and (B) equivalent oscillator circuit (adapted from Carr, 1987).

The detector trip point is set to some nominal value above the zero-field equilibrium voltage, and when this threshold is exceeded, the output driver toggles to the *on* state (*source* or *sink*, depending on whether PNP or NPN transistor drivers are employed). A major significance of this design approach is the resulting insensitivity of the Hall-effect switch to reverse magnetic polarity. While the mere approach of the south pole of a permanent magnet will activate the device, even direct contact by the north pole will have no effect on switching action, as the amplified output voltage actually falls further away from the *Schmitt-trigger* setpoint. Switching response times are very rapid, typically in the 400-ns range (Wood, 1986).

Inductive Proximity Sensors

Inductive proximity switches are today the most commonly employed industrial sensors (Moldoveanu, 1993) for detection of ferrous and nonferrous metal objects (i.e., steel, brass, aluminum, copper) over short distances. Cylindrical configurations as small as 4 mm in diameter have been available for over a decade (Smith, 1985). Because of the inherent ability to sense through nonmetallic materials, these sensors can be coated, potted, or otherwise sealed, permitting operation in contaminated work areas, or even submerged in fluids. Frequency responses up to 10 kHz can typically be achieved (Carr, 1987).

Inductive proximity sensors generate an oscillatory RF field (i.e., 100 kHz to 1 MHz) around a coil of wire typically wound around a ferrite core. When a metallic object enters the defined field projecting from the sensor face, eddy currents are induced in the target surface. These eddy currents produce a secondary magnetic field that interacts with field of the probe, thereby loading the probe oscillator. The effective impedance of the probe coil changes, resulting in an oscillator frequency shift (or amplitude change) that is converted into an output signal proportional to the sensed gap between probe and target.

A block diagram of a typical inductive proximity sensor is depicted in Fig. 19.94(A). The oscillator comprises an active device (i.e., a transistor or IC) and the sensor probe coil itself. An equivalent circuit (Fig. 19.94(B)) representing this configuration is presented by Carr (1987), wherein the probe coil is modeled as an inductor L_p with a series resistor R_p , and the connecting cable between the coil and the active element shown as a capacitance C . In the case of a typical Collpitts oscillator, the probe-cable combination is part of a resonant frequency tank circuit.

As a conductive target enters the field, the effects of the resistive component R_p dominate, and resistive losses of the tank circuit increase, loading (i.e., damping) the oscillator (Carr, 1987). As the gap becomes smaller, the amplitude of the oscillator output continues to decrease, until a point is reached where oscillation can no longer be sustained. This effect gives rise to the special nomenclature of an eddy-current-killed oscillator (ECKO) for this type of configuration. Sensing gaps smaller than this minimum threshold (typically from 0.005 to 0.020 in.) are not quantified in terms of an oscillator amplitude that correlates with range, and thus constitute a dead-band region for which no analog output is available.

Monitoring the oscillator output amplitude with an internal threshold detector creates an *inductive proximity switch* with a digital *on/off* output (Fig. 19.95). As the metal target approaches the sensor face, the oscillator output voltage falls off as shown, eventually dropping below a preset *trigger level*, whereupon the threshold comparator toggles from an *off* state to an *on* state. Increasing the gap distance causes the

TABLE 19.4 Nominal Sensing Ranges for Material other than Mild Steel Must be Adjusted Using the Above Attenuation Factors (Smith, 1985)

| Material | Attenuation Factor |
|-----------------|--------------------|
| Cast Iron | 1.10 |
| Mild Steel | 1.00 |
| Stainless Steel | 0.70–0.90 |
| Brass | 0.45 |
| Aluminum | 0.40 |
| Copper | 0.35 |

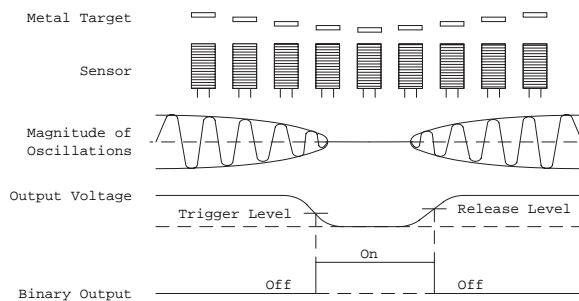

FIGURE 19.95 A small difference between the trigger and release levels (*hysteresis*) eliminates output instability as the target moves in and out of range (adapted from Moldoveanu, 1993).

voltage to again rise, and the output switches *off* as the *release level* is exceeded. The intentional small difference between the trigger level and the release level, termed *hysteresis*, prevents output instabilities near the detection threshold. Typical hysteresis values (in terms of gap distance) range from 3% to 20% of the maximum effective range (Damuck & Perrotti, 1993).

Effective sensing range is approximately equal to the diameter of the sensing coil (Koenigsburg, 1982) and is influenced by target material, size, and shape. The industry standard target (for which the nominal sensing distance is specified) is a 1-mm-thick square of mild steel of the same size as the diameter of the sensor, or three times the nominal sensing distance, whichever is greater (Flueckiger, 1992). For ferrous metals, increased target thickness has a negligible effect (Damuck & Perrotti, 1993). More conductive nonferrous target materials such as copper and aluminum result in reduced detection range, as illustrated in Table 19.4. For such nonferrous metals, greater sensing distances (roughly equivalent to that of steel) can be achieved with thin-foil targets having a thickness less than their internal field attenuation distance (Smith, 1985). This phenomenon is known as the *foil effect* and results from the full RF field penetration setting up additional surface eddy currents on the reverse side of the target (Damuck & Perrotti, 1993).

There are two basic types of inductive proximity sensors: (1) *shielded* (Fig. 19.96(A)) and (2) *unshielded* (Fig. 19.96(B)). If an unshielded device is mounted in a metal surface, the close proximity of the surrounding metal will effectively saturate the sensor and preclude operation altogether (Swanson, 1985). To overcome this problem, the shielded configuration incorporates a coaxial metal ring surrounding the core, thus focusing the field to the front and effectively precluding lateral detection (Flueckiger, 1992). There is an associated penalty in maximum effective range, as shielded sensors can only detect out to about half the distance of an unshielded device of equivalent diameter (Swanson, 1985).

Mutual interference between inductive proximity sensors operating at the same frequency can result if the units are installed with a lateral spacing of less than twice the sensor diameter. This interference typically manifests itself in the form of an unstable pulsing of the output signal, or reduced effective range, and is most likely to occur in the situation where one sensor is undamped and the other is in the hysteresis range (Smith, 1985). Half the recommended $2d$ lateral spacing is generally sufficient for elimination of mutual

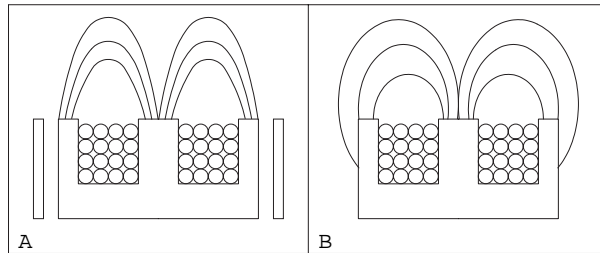

FIGURE 19.96 *Shielded* inductive sensors (A) can be embedded in metal without affecting performance, while the *unshielded* variety (B) must be mounted on nonmetallic surfaces only (Flueckiger, 1992).

interaction in the case of shielded sensors (Gatzios & Ben-Ari, 1986). When mounting in an opposed facing configuration, these minimal separation distances should be doubled.

Capacitive Proximity Sensors

The *capacitive proximity sensor* is very similar to the previously discussed *inductive proximity sensor*, except that the capacitive type can reliably detect dielectric materials in addition to metals. Effective for short-range detection out to a few inches, such sensors react to the variation in electrical capacitance between a probe (or plate) and its surrounding environment. As an object draws near, the changing geometry and/or dielectric characteristics within the sensing region cause the capacitance to increase. This change in capacitance can be sensed in a number of different ways: (1) an increase in current flow through the probe (Hall, 1984), (2) initiation of oscillation in an RC circuit (McMahon, 1987), or (3) a decrease in the frequency of an ongoing oscillation (Vranish et al., 1991). Typical industrial applications include level sensing for various materials (i.e., liquids, pellets, and powders) and product detection, particularly through nonmetallic packaging.

Ultrasonic Proximity Sensors

All of the preceding proximity sensors relied on target presence to directly change some electrical characteristic or property (i.e., inductance, capacitance) associated with the sense circuitry itself. The ultrasonic proximity sensor is an example of a *reflective* sensor that responds to changes in the amount of emitted energy returned to a detector after interaction with the target of interest. Typical systems consist of two transducers (one to transmit and one to receive the returned energy), although the relatively slow speed of sound makes it possible to operate in the transceiver mode with a common transducer. The transmitter emits a longitudinal wave in the ultrasonic region of the acoustical spectrum (typically 20–200 kHz), above the normal limits of human hearing.

Ultrasonic proximity sensors are useful over distances out to several feet for detecting most objects, liquid and solid. If an object enters the acoustical field, energy is reflected back to the receiver. As is the case with any reflective sensor, maximum detection range is dependent not only on emitted power levels, but also on the target cross-sectional area, reflectivity, and directivity. Once the received signal amplitude reaches a preset threshold, the sensor output changes state, indicating detection. Due in part to the advent of low-cost microcontrollers, such devices have for most situations been replaced by more versatile ultrasonic ranging systems that provide a quantitative indicator of distance to the detected object (section “Ultrasonic TOF Systems”).

Microwave Proximity Sensors

Microwave proximity sensors operate at distances of 5–150 ft or more (Williams, 1989) and are very similar to the ultrasonic units discussed above, except that electromagnetic energy in the microwave region of the RF energy spectrum is emitted. The FCC has allocated 10.50–10.55 GHz and 24.075–24.175 GHz for microwave field-disturbance sensors of this type (Schultz, 1993). When the presence of a suitable

target reflects sufficient energy from the transmitting antenna back to a separate receiving antenna (see Fig. 19.68 in section “Microwave Range Sensors”), the output changes state to indicate an object is present within the field of view. An alternative configuration employing a single transmit/receive antenna monitors the Doppler shift induced by a moving target to detect relative motion as opposed to presence. These sensors are usually larger than inductive and capacitive sensors, and they are best suited to detect larger objects.

Optical Proximity Sensors

Optical (photoelectric) sensors commonly employed in industrial applications can be broken down into three basic groups: (1) *opposed*, (2) *retroreflective*, and (3) *diffuse*. (The first two of these categories are not really “proximity” sensors in the strictest sense of the terminology.) Effective ranges vary from a few inches out to several hundred feet. Common robotic applications include floor sensing, navigational referencing, and collision avoidance. Industrial applications include sensing presence at a given maximum range (for counting, or to work on a part), sensing intrusion for safety systems, alignment, etc. Modulated near-infrared energy is typically employed to reduce the effects of ambient lighting, thus achieving the required signal-to-noise ratio for reliable operation. Visible-red wavelengths are sometimes used to assist in installation alignment and system diagnostics.

Actual performance depends on several factors. Effective range is a function of the physical characteristics (i.e., size, shape, reflectivity, and material) of the object to be detected, its speed and direction of motion, the design of the sensor, and the quality and quantity of energy it radiates or receives. Repeatability in detection is based on the size of the target object, changes in ambient conditions, variations in reflectivity or other material characteristics of the target, and the stability of the electronic circuitry itself. Unique operational characteristics of each particular type can often be exploited to optimize performance in accordance with the needs of the application.

Opposed Mode

Commonly called an “electric eye” at the time, the first of these categories was introduced into a variety of applications back in the early 1950s, to include parts counters, automatic door openers, annunciators, and security systems. Separate transmitting and receiving elements are physically located on either side of the region of interest; the transmitter emits a beam of light, often supplied in more recent configurations by an LED that is focused onto a photosensitive receiver. Any object passing between the emitter and receiver breaks the beam, disrupting the circuit. Effective ranges of hundreds of feet or more are routinely possible and often employed in security applications.

Retroreflective Mode

Retroreflective sensors evolved from the *opposed* variety through the use of a mirror to reflect the emitted energy back to a detector located directly alongside the transmitter. *Corner-cube retroreflectors* (Fig. 19.97) eventually replaced the mirrors to cut down on critical alignment needs. Corner-cube prisms have three mutually perpendicular reflective surfaces and a hypotenuse face; light entering through the hypotenuse face is reflected by each of the surfaces and returned back through the face to its source. A good retroreflective target will return about 3000 times as much energy to the sensor as would be reflected from a sheet of white typing paper (Banner, 1993). In most factory automation scenarios, the object of interest is detected when it breaks the beam, although some applications call for placing the retroreflector on the item itself.

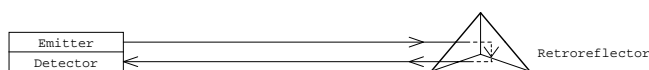

FIGURE 19.97 Corner-cube retroreflectors are employed to increase effective range and simplify alignment (adapted from Banner, 1993).

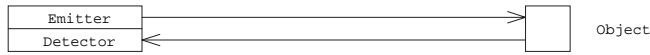

FIGURE 19.98 Diffuse-mode proximity sensors rely on energy reflected directly from the target surface.

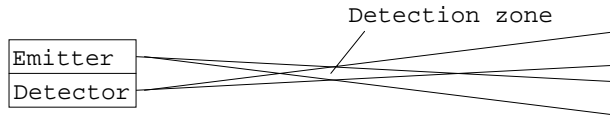

FIGURE 19.99 Diffuse proximity sensors configured in the convergent mode can be used to ascertain approximate distance to an object.

Diffuse Mode

Optical proximity sensors in the *diffuse* category operate in similar fashion to *retroreflective* types, except that energy is returned from the surface of the object of interest, instead of from a *co-operative reflector* (Fig. 19.98). This feature facilitates random object detection in unstructured environments.

There are several advantages of this type of sensor over ultrasonic ranging for close-proximity object detection. There is no appreciable time lag since optical energy propagates at the speed of light, whereas up to a full second can be required to update a sequentially fired ultrasonic array of only 12 sensors. In addition, optical energy can be easily focused to eliminate adjacent sensor interaction, thereby allowing multiple sensors to be fired simultaneously. Finally, the shorter wavelengths involved greatly reduce problems due to specular reflection, resulting in more effective detection of off-normal surfaces. The disadvantage, of course, is that no direct range measurement is provided, and variations in target reflectivity can sometimes create erratic results. One method for addressing this limitation is discussed in the next section.

Convergent Mode

Diffuse proximity sensors can employ a special geometry in the configuration of the transmitter with respect to the receiver to ensure more precise positioning information. The optical axis of the transmitting LED is angled with respect to that of the detector, so the two intersect only over a narrowly defined region as illustrated in Fig. 19.99. It is only at this specified distance from the device that a target can be in position to reflect energy back to the detector. Consequently, most targets beyond this range are not detected. This feature decouples the proximity sensor from dependence on the reflectivity of the target surface and is useful where targets are not well displaced from background objects.

References

- Adams, M.D., "Amplitude modulated optical range data analysis in mobile robotics," *IEEE International Conference on Robotics and Automation*, Atlanta, GA, pp. 8–13, 1993.
- Aloimonos, J., Weiss, I., Bandyopadhyay, A., "Active vision," *First International Conference on Computer Vision*, pp. 35–54, 1987.
- Arkin, R.C., "Motor-schema-based mobile robot navigation," *International Journal of Robotics Research*, Vol. 8., No. 4, pp. 92–112, Aug., 1989.
- Ascension Technologies, P.O. Box 527, Burlington, VT 05402, USA. www.ascension-tech.com.
- Ball, D., "Sensor selection guide," *Sensors*, pp. 50–53, April, 1986.
- Banner, *Handbook of Photoelectric Sensing*, Banner Engineering Corp., Minneapolis, MN, 1993.
- Besl, P.J., "Range imaging sensors," GMR-6090, General Motors Research Laboratory, 1988.
- Biber, C., Ellin, S., Shenk, E., "The polaroid ultrasonic ranging system," Audio Engineering Society, 67th Convention, New York, NY, Oct.–Nov., 1980.
- Blais, F., Rioux, M., Domey, J., Beraldin, J.A., "A very compact real time 3-D range sensor for mobile robot applications," SPIE Vol. 1007, Mobile Robots III, Cambridge, MA, Nov., 1988.

- Borenstein, J., Koren, Y., "Real-time obstacle avoidance for fast mobile robots in cluttered environments," *IEEE International Conference on Robotics and Automation*, Vol. CH2876-1, Cincinnati, OH, pp. 572–577, May, 1990.
- Burreson, B., "Magnetic proximity switches in severe environments," *Sensors*, pp. 28–36, June, 1989.
- Burt, P.J., Anadan, P., Hanna, K., van der Wal, G., "A front end vision processor for unmanned vehicles," *Advanced Image Processing Group*, David Sarnoff Research Center, Princeton, NJ, April, 1992.
- Burt, P.J., Anadan, P., Hanna, K., van der Wal, G., Bassman, R., "A front end vision processor for vehicle navigation," *International Conference on Intelligent Systems*, pp. 653–662, Feb., 1993.
- Carr, W.W., "Eddy current proximity sensors," *Sensors*, pp. 23–25, Nov., 1987.
- Chen, Y.D., Ni, J., Wu, S.M., "Dynamic calibration and compensation of a 3-D laser radar scanning system," *IEEE International Conference on Robotics and Automation*, Atlanta, GA, Vol. 3, pp. 652–664, May, 1993.
- Damuck, N., Perrotti, J., "Getting the most out of your inductive proximity switch," *Sensors*, pp. 25–27, Aug., 1993.
- Depkovich, T., Wolfe, W., "Definition of requirements and components for a robotic locating system," Final Report MCR-83-669, Martin Marietta Denver Aerospace, Denver, CO, Feb., 1984.
- Everett, H.R., "A multi-element ultrasonic ranging array," *Robotics Age*, pp. 13–20, July, 1985.
- Everett, H.R., DeMuth, D.E., Stitz, E.H., "Survey of collision avoidance and ranging sensors for mobile robots," *Technical Report 1194*, Naval Command Control and Ocean Surveillance Center, San Diego, CA, Dec., 1992.
- Figueroa, F., Barbieri, E., "Increased measurement range via frequency division in ultrasonic phase detection methods," *Acustica*, Vol. 73, pp. 47–49, 1991a.
- Figueroa, J.F., Barbieri, E., "An ultrasonic ranging system for structural vibration measurements," *IEEE Transactions on Instrumentation and Measurement*, Vol. 40, No. 4, pp. 764–769, Aug., 1991b.
- Figueroa, J.F., Lamancusa, J.S., "A method for accurate detection of time of arrival: analysis and design of an ultrasonic ranging system," *Journal of the Acoustical Society of America*, Vol. 91, No. 1, pp. 486–494, Jan., 1992.
- Fernando Figueroa and Evangelos Doussis, "A hardware-level method to improve the range and accuracy of an ultrasonic ranging system," *Acustica*, Vol. 78, No. 4, pp. 226–232, May, 1993.
- Flueckiger, N., "Inductive proximity sensors: theory and applications," *Sensors*, pp. 11–13, May, 1992.
- Gatzios, N.E., Ben-Ari, H., "Proximity control primer," *Sensors*, pp. 47–49, April, 1986.
- Gustavson, R.L., Davis, T.E., "Diode-laser radar for low-cost weapon guidance," *SPIE*, Vol. 1633, Laser Radar VII, Los Angeles, CA, pp. 21–32, Jan., 1992.
- Hall, D.J., "Robotic sensing devices," Report No. CMU-RI-TR-84-3, Carnegie-Mellon University, Pittsburgh, PA, March, 1984.
- Hamlin, "The versatile magnetic proximity sensor," *Sensors*, pp. 16–22, May, 1988.
- Hammond, W., "Vehicular use of ultrasonic systems," *Technical Report*, Cybermotion, Salem, VA, May, 1994.
- Hebert, M., Krotkov, E., "3-D measurements from imaging laser radars: how good are they?" *International Conference on Intelligent Robots and Systems*, pp. 359–364, 1991.
- Hines, R., "Hall effect sensors in Paddlewheel Flowmeters," *Sensors*, pp. 32–33, Jan., 1992.
- Jarvis, R.A., "A perspective on range finding techniques for computer vision," *IEEE Transactions on Pattern Analysis and Machine Intelligence*, Vol. PAMI-1, No. 2, pp. 122–139, March, 1983a.
- Jarvis, R.A., "A laser time-of-flight range scanner for robotic vision," *IEEE Transactions on Pattern Analysis and Machine Intelligence*, Vol. PAMI-5, No. 5, pp. 505–512, Sep., 1983b.
- Kent, E.W., et al., "Real-time cooperative interaction between structured light and reflectance ranging for robot guidance," *Robotica*, Vol. 3, pp. 7–11, Jan.–March, 1985.
- Kerr, J.R., "Real time imaging rangefinder for autonomous land vehicles," *SPIE*, Vol. 1007, Mobile Robots III, pp. 349–356, Nov., 1988.
- Kilough, S.M., Hamel, W.R., "Sensor capabilities for the HERMIES experimental robot," American Nuclear Society, Third Topical Meeting on Robotics and Remote Systems, Charleston, SC, CONF-890304, Section 4-1, pp. 1–7, March, 1989.

- Kim, E.J., "Design of a phased sonar array for a mobile robot," *Bachelor's Thesis*, MIT, Cambridge, MA, May, 1986.
- Koenigsburg, W.D., "Noncontact distance sensor technology," GTE Laboratories, 40 Sylvan Rd., Waltham, MA, pp. 519–531, March, 1982.
- Lang, S., Korba, L., Wong, A., "Characterizing and modeling a sonar ring," *SPIE Mobile Robots IV*, Philadelphia, PA, pp. 291–304, 1989.
- Langer, D., Thorpe, C., "Sonar based outdoor vehicle navigation and collision avoidance," *International Conference on Intelligent Robots and Systems, IROS'92*, Raleigh, NC, July, 1992.
- LeMoigue, J., Waxman, A.M., "Projected light grids for short range navigation of autonomous robots," *Proceedings, 7th IEEE Conference on Pattern Recognition*, Montreal, Canada, pp. 203–206, 30 July–2 Aug., 1984.
- Lenz, J.E., "A review of magnetic sensors," *Proceedings of the IEEE*, Vol. 78, No. 6, June, 1990.
- Lewis, R.A., Johnson, A.R., "A scanning laser rangefinder for a robotic vehicle," *5th International Joint Conference on Artificial Intelligence*, pp. 762–768, 1977.
- Loewenstein, D., "Computer vision and ranging systems for a ping pong playing robot," *Robotics Age*, pp. 21–25, Aug., 1984.
- Manolis, S., "Resolvers vs. rotary encoders for motor commutation and position feedback," *Sensors*, pp. 29–32, March, 1993.
- McDermott, J., "The hall effect: success at 90," *Electronic Design* 21, pp. 38–45, 11 Oct., 1969.
- McMahon, V.C., "Solutions from capacitive proximity switches," *Sensors*, pp. 31–33, May, 1987.
- Moldoveanu, A., "Inductive proximity sensors: fundamentals and standards," *Sensors*, pp. 11–14, June, 1993.
- Moravec, H.P., Elfes, A., "High resolution maps from wide angle sonar," *IEEE International Conference on Robotics and Automation*, St. Louis, MO, pp. 116–121, March, 1985.
- NASA, "Fast accurate rangefinder," *NASA Tech Brief*, NPO-13460, Winter, 1977.
- Nitzan, D., et al. "The measurement and use of registered reflectance and range data in scene analysis," *Proceedings of IEEE*, Vol. 65, No. 2, pp. 206–220, Feb., 1977.
- Nitzan, D., "Assessment of robotic sensors," *Proceedings of 1st International Conference on Robotic Vision and Sensory Controls*, pp. 1–11, 1–3 April, 1981.
- Peale, S., "Speed/Motion sensing in challenging environments," *Sensors*, pp. 45–46, Jan., 1992.
- Pletta, J.B., Amai, W.A., Klarer, P., Frank, D., Carlson, J., Byrne, R., "The remote security station (RSS) final report," Sandia Report SAND92-1947 for DOE under Contract DE-AC04-76DP00789, Sandia National Laboratories, Albuquerque, NM, Oct., 1992.
- Poggio, T., "Vision by man and machine," *Scientific America*, Vol. 250, No. 4, pp. 106–116, April, 1984.
- Polaroid, "Polaroid ultrasonic ranging system user's manual," Publication No. P1834B, Polaroid Corporation, Cambridge, MA, Dec., 1981.
- Polaroid, "Technical specifications for polaroid electrostatic transducer," 7000-Series Product Specification ITP-64, Polaroid Corporation, Cambridge, MA, June, 1987.
- Polaroid, "6500-series sonar ranging module," Product Specifications PID 615077, Polaroid Corporation, Cambridge, MA, 11 Oct., 1990.
- Polhemus Incorporated, a Rockwell Collins Company, 40 Hercules Drive, P.O. Box 560, Colchester, VT 05446 (www.polhemus.com).
- Schwartz, J.T., "Structured light sensors for 3-D robot vision," Technical Report No. 65, Courant Institute of Mathematical Sciences, New York University, undated.
- Scott, M.W., "Range imaging laser radar," US Patent 4,935,616, June 19, 1990.
- Siuru, B., "The smart vehicles are here," *Popular Electronics*, Vol. 11, No. 1, pp. 41–45, Jan., 1994.
- Smith, J.W., "Design and application of inductive proximity sensors," *Sensors*, pp. 9–14, Nov., 1985.
- Swain, M.J., Stricker, M., eds., *Promising Directions in Active Vision*, Report from the National Science Foundation Active Vision Workshop, University of Chicago, IL, 1991.
- Swanson, R., "Proximity switch application guide," *Sensors*, pp. 20–28, Nov., 1985.

- Vranish, J.M., McConnel, R.L., Mahalingam, S., "Capaciflector collision avoidance sensors for robots," Product Description, NASA Goddard Space Flight Center, Greenbelt, MD, Feb., 1991.
- Vuytsteke, P., Price, C.B., Oosterlinck, A., "Image sensors for real-time 3-D acquisition, part 1," in *Traditional and Non-Traditional Robotic Sensors*, T.C. Henderson, ed., NATO ASI Series, Vol. F63, Springer-Verlag, pp. 187–210, 1990.
- Wavering, A.J., Fiala, J.C., Roberts, K.J., Lumia, R., "TRICLOPS: a high-powered trinocular active vision system," *IEEE International Conference on Robotics and Automation*, pp. 410–417, 1993.
- White, D., "The hall effect sensor: basic principles of operation and application," *Sensors*, pp. 5–11, May, 1988.
- Wildes, R.P., "Direct recovery of 3-D scene geometry from binocular stereo disparity," *IEEE Transactions on Pattern Analysis and Machine Intelligence*, Vol. 13, No. 8, pp. 761–774, Aug., 1991.
- Williams, H., "Proximity sensing with microwave technology," *Sensors*, pp. 6–15, June, 1989.
- Wojcik, S., "Noncontact presence sensors for industrial environments," *Sensors*, pp. 48–54, Feb., 1994.
- Wood, T., "The hall effect sensor," *Sensors*, pp. 27–36, March, 1986.
- Woodbury, N., Brubacher, M., Woodbury, J.R., "Noninvasive tank gauging with frequency-modulated laser ranging," *Sensors*, pp. 27–31, Sep., 1993.
- Young, M.S., Li, Y.C., "A high precision ultrasonic system for vibration measurements," *Rev. Sci. Instrum.*, Vol. 63, No.11, pp. 5435–5441, Nov., 1992.

19.8 Light Detection, Image, and Vision Systems

Stanley S. Ipson

Introduction

Light detectors span a broad spectrum of complexity. The simplest are single sensors whose output signals are easy to interpret and to interface to other components like microprocessors. In contrast, the image sensors in video and digital cameras, incorporating arrays of up to several million detectors, produce output signals which are complicated to interface and require powerful processors to interpret. Regardless of complexity, the purpose of a light detector is to measure light, and the section "Basic Radiometry" introduces a number of radiometric terms that are employed in the characterization of light, light sources, and detectors. However, manufacturers often specify the performance of their devices using photometric units, which take into account the human visual response to light, and so it is necessary to understand both radiometric and photometric measures of light. Sources of light are briefly discussed in section "Light Sources." There are several types of light detector in common use and the principles of operation and characteristics of the most widely used, including pyroelectric, photoresistive, photodiode, and phototransistor are summarized in section "Light Detectors." Vision systems have optical components to form an image and an image sensor to convert the light image into an electrical signal. Image formation is reviewed in section "Image Formation," before introducing the most widely used detectors, based on charge-coupled device (CCD) technology and complementary metal oxide semiconductor (CMOS) technology, in section "Image Sensors." The elements required to complete a vision system are discussed briefly in the final section.

Basic Radiometry

Visible light is electromagnetic energy radiated with very short wavelengths in the range between about 400 and 700 nm. At shorter wavelengths, to about 30 nm, is invisible ultraviolet light and at longer wavelengths, up to about 0.3 mm, is invisible infrared radiation. Although electromagnetic radiation displays wave behavior including interference and diffraction, it can also behave like a stream of particles and is emitted and absorbed by matter in discrete amounts of energy called photons. The energy ϵ of a light

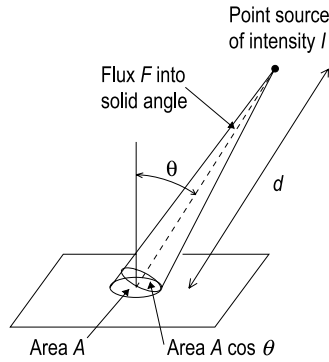

FIGURE 19.100 A point source of intensity I emits radiant power F into the solid angle subtended by the area A . The irradiance at distance d from the source is I/d^2 . When the dimensions of A are small compared with d , the solid angle can be approximated by $A \cos(\theta)/d^2$.

photon with wavelength λ is given by

$$\varepsilon = \frac{hc}{\lambda} \quad (19.74)$$

where h is Planck's constant (6.6×10^{-34} J s), c is the speed of light (3×10^8 m s⁻¹) [1]. The most fundamental concept in the measurement of light is radiant power, sometimes called radiant flux (F), which is the flow of energy (photons) per unit time across a specified region in space. It is measured in watts and applies equally to visible and invisible radiation. The corresponding photometric unit is the lumen (lm), which takes into account the varying sensitivity of the eye to light of different wavelengths. One watt of radiation with a wavelength of 555 nm is defined equal to 683 lm. At other wavelengths the number of lumens is reduced (half response at 510 and 610 nm) according to the bell-shaped CIE standard eye-response curve. The remaining radiometric terms, irradiance, intensity, and radiance, are measures of the concentration of light flux. Irradiance (E) is the total radiant power falling on unit area of a surface and is measured in W m⁻². The corresponding photometric quantity is illuminance, measured in lm m⁻² (lux). Radiant intensity (I) is a measure of a point source's ability to illuminate a surface, which decreases as the square of the distance d to the surface. It is measured in Wsr⁻¹ and its photometric equivalent is luminous intensity measured in candelas (lm sr⁻¹ or cd). The irradiance from a point source of intensity I , falling on a small area A of a surface at distance d with normal inclined at an angle θ to the source as shown in Fig. 19.100, is given by

$$E = \frac{F}{A} = \frac{I \cos \theta}{d^2} \quad (19.75)$$

Although few real sources would seem to be good approximations to a point source (stars in the night sky are exceptions), it is often a good approximation to calculate the irradiance of a surface (detector) by assuming the source has a specified intensity. The error caused by ignoring the spatial extent of the source is less than 1%, if the distance to the source is greater than ten times the largest dimension of the source [2]. When the distance is five (three) times the source size, the error is nearer 4% (9%). Radiant intensity is the most easily measured property of a light source and is often quoted as the performance parameter of a source. Some point sources radiate uniformly in all directions and have an intensity which is independent of direction. Other point sources emit nonuniformly. A Lambertian point source is a source whose intensity varies with direction as $I_0 \cos \theta$, where θ is the angle between the measurement direction and the direction of maximum intensity I_0 . Many light sources have an intensity which falls off with angle more rapidly than in the case of a Lambertian emitter, which has half intensity at an angle of 60° from the forward direction.

When a source has appreciable spatial extent, its radiance (R) in a given direction is defined as the radiant intensity of the source in that direction divided by the area of the source projected in the same direction, and is measured in W sr⁻¹ m⁻². Conversely, the intensity of a source is the product of its area

and radiance. Radiance is important in connection with optical systems. In particular, the radiance of the image produced by a lens is equal to that of the object, apart from losses due to absorption and reflection. This fact is used to calculate the image illuminance from an object of specified radiance using a specified lens. The photometric equivalent of radiance is luminance, sometimes loosely called brightness, and is measured in cd m^{-2} . Apart from color, brightness is the only property of light that we can perceive. Because it is normalized by size, the radiance of sources with different sizes can be compared. For example, the radiance of the sun is about $1.3 \times 10^6 \text{ W sr}^{-1} \text{ m}^{-2}$, the radiance of a 1000 W mercury arc lamp is about $10^7 \text{ W sr}^{-1} \text{ m}^{-2}$, and the radiance of a 1-mW He-Ne laser with beam diameter of 1 mm and a beam divergence of 1 mrad is about $1.6 \times 10^9 \text{ W sr}^{-1} \text{ m}^{-2}$. The radiance of most sources increases as the viewing direction approaches the direction normal to the source surface. An extended Lambertian source is an exception, the intensity and projected area vary in the same way with viewing direction, so the radiance is independent of viewing direction.

It is often necessary to estimate the response of a light detector to different light sources. Exact calculations are difficult because the required information may not be available, so it is often better to make a simple estimate and then adjust the equipment to produce the required response. If the source width is small compared with its distance d from the detector then the radiation falling on the detector can be estimated by assuming that the source is a Lambertian point source of intensity I equal to the product of its brightness B and its area S . The irradiance falling on the detector is then given by [2]

$$E = \frac{I \cos \phi}{d^2} = \frac{BS \cos \theta \cos \phi}{d^2} \quad (19.76)$$

where θ and ϕ are the angles between the normals of the source and detector, respectively, and the line connecting source and detector. If the source is circular, its solid angle S/d^2 can be approximated by $\pi\alpha^2$, providing α the angle in radians equal to the radius of the source divided by its distance from the detector is small. Light detectors have a directional response to radiation, which may be too wide or too narrow for the intended application. The extent of the angular response of a detector to light can be reduced using a collimating tube. Alternatively, if the detector is placed at the focal point of a lens the angular response can be decreased or increased using positive or negative lenses. If the source is effectively a point and all the light brought to focus by the lens falls on the detector, then there is the added advantage of the sensitivity increasing by a factor equal to the ratio of the lens-to-detector area.

Light Sources

The choice of a light detector should take into account the nature of the light source, which might be daylight, a tungsten filament lamp, a quartz halogen lamp, a fluorescent tube, a light emitting diode, etc. The distinct properties of light sources arise partly from their construction and partly from the physical processes which lead to the emission of light [3]. Many sources are thermal in nature; that is, their light emission is due to their high temperature. An object heated to incandescence, such as the filament in a tungsten filament lamp, emits a broad continuous spectrum of electromagnetic radiation, with an intensity that depends on the temperature and its surface emissivity. At any given temperature, no surface emits more radiation than a completely black surface, which has emissivity 1.0 at all wavelengths. It can be important when designing light detecting systems to be aware that the visible light from such lamps (and also fluorescent lamps) is often accompanied by significant amounts of invisible radiation, which detectors may be sensitive to, even if the eye is not. Many light sources operate at temperatures near room temperature and hence are not in thermal equilibrium. Luminescence is the general term used to describe the production of light at a greater rate than that due to the temperature of the body. Common examples of such sources are light-emitting diodes (LEDs), zinc-sulfide electroluminescent panels, and the electron-beam excited phosphors in computer monitor and TV screens. The major properties of sources include: total radiant or luminous power output; efficiency in converting electrical power into radiant power; spectral composition of the output; directionality of the output radiation; area of the

TABLE 19.5 The Characteristics of a Number of Different Types of Light Source

| Description | Size | Electrical Input | Light Output | View Angle | Spectral Type |
|----------------------------|-------------------|------------------|-------------------------|------------|----------------|
| Ultra-bright yellow LED | 10 mm dia. | 20 mA, 2.1 V | 14 cd | 4° | Peak at 590 nm |
| Infrared GaAlAs LED | 5 mm dia. | 0.1 A, 1.9 V | 16 mW sr ⁻¹ | 80° | Peak at 880 nm |
| Infrared LED | 5 mm dia. | 0.1 A, 1.9 V | 135 mW sr ⁻¹ | 8° | Peak at 880 nm |
| Small filament lamp | 11 mm dia. | 6 V, 0.3 A | 11 lm | 360° | Black body |
| Miniature fluorescent tube | 300 × 16 mm dia. | 8 W | 480 lm | 360° | White |
| Standard fluorescent tube | 1500 × 26 mm dia. | 58 W | 4800 lm | 360° | White |
| Tungsten halogen dichroic | 51 mm dia. | 12 V, 20 W | 3300 cd | 12° | 3000 K |
| Tungsten halogen dichroic | 51 mm dia. | 12 V, 20 W | 460 cd | 36° | 3000 K |

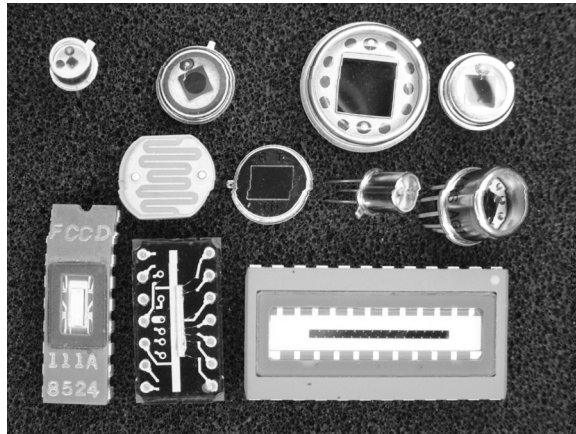

FIGURE 19.101 A collection of light detectors is shown. Along the top row from left to right are four silicon photodiodes with areas of 1, 5, 41.3, and 7.5 mm², the last with a photometric color correction filter. Along the middle row from left to right are a CdS photoresistor, a pyroelectric detector, a phototransistor, and a quadrant silicon photodiode containing four separate sensing elements. Along the bottom row from left to right are a 256-element linear CCD, a 64-element charge integrating CMOS array, and a 16-element linear silicon photodiode in a 24-pin d.i.l. package. The diode pitch is 1 mm.

emitting surface; lamp size and operating temperature. [Table 19.5](#) lists characteristics of a number of common types of light sources taken from the lamp suppliers data sheets.

Light Detectors

A light detector converts the radiant power it absorbs into a change of a device parameter such as resistance, surface charge, current, or voltage. A number of light detectors are shown in [Fig. 19.101](#). Some signal conditioning electronics may also be needed to convert the basic output from the detector into a more useful voltage signal, for example, for digitization by an analog-to-digital converter (ADC). This may be integrated into the detector or require external components. Light detectors can be divided into two main types, thermal or photon devices. In thermal detectors, the heating effect of the absorbed radiation results in a change in a temperature dependent parameter, such as electrical resistance (in bolometers) or thermoelectric emf (in thermopiles). The output of thermal detectors is usually proportional to the radiant power absorbed in the detector, and provided the absorption efficiency is the same at all wavelengths, the output is independent of wavelength. The most widely used type of thermal detector is the pyroelectric detector, which is discussed in the next section. Photon detectors, in contrast to thermal detectors, depend on the generation of free charge by the absorption of individual photons. This photon-induced charge causes a change in device resistance, in the case of photoresistors, or an

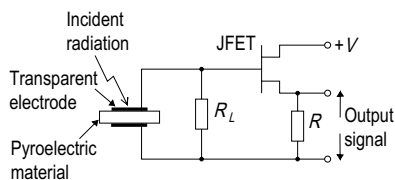

FIGURE 19.102 The basic components within a pyroelectric detector are indicated. An increase in radiation falling on the pyroelectric material causes its temperature to rise and the charge on its surface to change. A transient current flows through the resistor R_L which is of the order of $10^{11} \Omega$. The JFET reduces the output impedance to R .

output current or output voltage, in the case of photodiodes and transistors. All these photon detectors require a minimum photon energy to create mobile electrons and consequently have a maximum wavelength, dependent on the detector material, beyond which they do not operate. On the other hand, photon detectors generally respond faster to changes in radiation level than thermal detectors and are more sensitive.

Pyroelectric Detectors

Pyroelectric detectors employ a ferroelectric ceramic material (such as lead zirconate or lithium tantalate) which has molecules with a permanent electric dipole moment [4]. Below a critical temperature, known as the Curie temperature, the dipoles are partly aligned and give rise to a net electrical polarization for the whole crystal. As the material is heated and its temperature rises, increased thermal agitation of the molecules reduces the net polarization, which falls to zero at the Curie temperature. The basic detector, shown in Fig. 19.102, consists of a thin slab of ferroelectric material fabricated so that the polarization is normal to the large area faces on which transparent electrodes are evaporated. These are connected together via a load resistor (up to $10^{11} \Omega$). An increase in radiation falling on the detector makes its temperature rise and causes the captive surface charge, which is proportional to the polarization, to change. This causes a change in the charge induced in the electrodes and a current to flow in the load resistance. Because of the large value of the load resistor used in pyroelectric detectors, an impedance matching circuit, such as a JFET source following circuit, is usually built into the detector as shown in Fig. 19.102. Pyroelectric detectors only respond to changing irradiation and typically can detect radiation powers down to about 10^{-8} W at 1 Hz. Because they respond to the heating caused by absorption of the radiation, they have a wide spectral response. They are useful as low-cost infrared detectors, intruder alarms, and fire detectors.

Photon Detectors

The most widely used photon detectors are made from a semiconducting material. In semiconductors, the electrons fill the available energy levels in the material up to the top of the valence band (VB), which is separated from the bottom of the empty conduction band (CB) by an energy gap E_g , which is characteristic of the material. These energy bands are completely full or empty, respectively, only at a temperature of absolute zero (0 K). At a higher temperature, an equilibrium is reached between the thermal excitation of electrons across the gap (producing free electrons in the CB and positively charged free holes in the VB) and the recombination of pairs of free electrons and holes. The equilibrium number of free electrons and holes increases rapidly with temperature (T) according to the Boltzmann factor $\exp(-E_g/kT)$, where k is Boltzmann's constant ($1.38 \times 10^{-23} \text{ J/K}$). This equilibrium is disturbed when photons, with energy greater than E_g , are absorbed by electrons which are excited across the gap. When the radiation source is removed, the number of excess electrons and holes quickly falls back to zero over a time period governed by the recombination time of the material. While excess free charge is present there is a measurable change in the electrical conductivity and this is used in photoresistive (also called photoconductive) detectors. Alternatively, in junction detectors, the rate of generation of photocharge is converted to an output current, or voltage. All semiconductor photon detectors have a relatively narrow

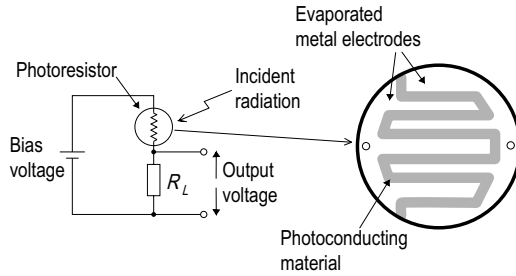

FIGURE 19.103 A simple light detector circuit employing a photoresistor is shown. An increase in light illumination causes the resistance of the photoresistor to decrease and the output voltage to increase. The comb-like pattern typically employed in photoresistors gives a relatively large active area of photoconducting material and a small electrode spacing resulting in high sensitivity.

spectral response, which peaks at a wavelength about hc/E_g . Photoresistors and junction detectors are discussed in more detail in the following sections.

Photoresistors

The electrical conductivity of a semiconductor is the sum of two terms [5], one contributed by electrons and the other by holes, as follows:

$$\sigma = ne\mu_n + pe\mu_p \tag{19.77}$$

Each term is proportional to $n(p)$ the number of electrons (holes) per unit volume in the conduction (valence) band, the electron (hole) mobility $\mu_n(\mu_p)$, and the magnitude of the charge of the electron e . The increase in conductivity, caused by the absorption of photons increasing n and p , is the basis for the operation of the photoresistive detector. This consists of a slab of semiconductor material on the faces of which electrodes are deposited to allow the resistance to be monitored, as illustrated in Fig. 19.103. The photon-induced current is proportional to the length of the electrodes and inversely proportional to their separation, hence the typical comb-like electrode geometry of photoresistors, shown in Fig. 19.73. Because the resistance R_C is inversely proportional to conductivity, the variation of R_C with incident power P_D is very nonlinear and is often expressed in the form

$$\log_{10} R_C = a - b \log P_D \tag{19.78}$$

where a and b are constants. Cadmium sulfide is commonly used as a detector of visible radiation because it is low cost and its response is similar to that of the human eye. Other photoconductive materials include lead sulfide, with a useful response from 1000 to 3400 nm, indium antimonide with a useful response out to 7000 nm, and mercury cadmium telluride with peak sensitivity in the range 5000–14,000 nm. The wavelength range 5000–14,000 nm is of importance because it covers the peak emission from bodies near and above ambient temperature and also corresponds to a region of good transmission through the atmosphere. Photoconductive devices used for the detection of long wavelength infrared radiation should be cooled because of the noise caused by fluctuations in the thermal generation of charge. As a rough rule of thumb, because of the Boltzmann factor, a detector with energy gap E_g should be cooled to a temperature less than $E_g/25k$.

Junction Detectors

In photoresistors, the rate of generation of electron–hole pairs by the absorption of radiation, combined with recombination at a rate characteristic of the device, results in an increase in free charge and therefore electrical conductivity. In junction photodetectors [6], such as photodiodes and phototransistors, newly generated electron–hole pairs separate before they can recombine so that a photon-induced electric

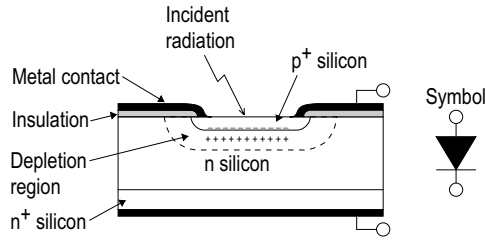

FIGURE 19.104 The basic structure of a typical silicon photodiode is illustrated. A space charge, or depletion region, is formed by the diffusion of mobile charge across the surface between the p-type and n-type silicon. It extends furthest into the n-type silicon because this is more lightly doped than the p-type silicon. Any electron hole pairs generated in this region are prevented from recombining by the presence of the electric field, which sweeps them apart, allowing them to contribute to the photon generated current. The p-type region is made thin to allow photons to penetrate into the depletion region.

current can be detected. The separation of electrons and holes takes place in the electric field associated with a P-N junction fabricated in a semiconductor material, which is usually silicon. The structure of a typical silicon photodiode is shown in Fig. 19.104. The substrate material is lightly doped n-type silicon, which is pure group IV silicon into which has been added a small amount of a group V impurity element. This contributes free electrons to the conduction band of the silicon leaving the impurity atoms ionized and with a positive charge. A region of heavily doped p-type silicon is formed on the top face of the substrate by adding a group III impurity element, by diffusion or ion implantation for example. The group III atoms contribute free holes to the valence band leaving negatively charged impurity ions. The P-N junction is the boundary surface between the p-type and n-type regions on which the opposite impurity concentrations are equal. The mobile electrons and holes diffuse across the boundary from the side where they are in the majority, to the side where they are in the minority. There they recombine leaving a region containing unscreened positive impurity ions on one side of the junction and a region containing unscreened negatively charged impurity ions on the other. The charged region is called the space charge or depletion region, because it is depleted of free charge. The movement of mobile charge continues until the diffusion driving force is balanced by the opposing electric field created in the depletion region by the separation of charge. When equilibrium has been established, the voltage across the depletion region, called the built-in voltage, is about 0.6 V (for silicon). The depletion region extends much further into the n-type silicon than into the p-type silicon for the photodiode shown in Fig. 19.104 because of the very different doping concentrations. The p-type region is made very thin, so that radiation can pass through it, and metallic contacts are made to the p-type and n-type materials. An ohmic contact forms between a metal and heavily doped silicon and to ensure a good ohmic contact to the lightly doped n-type material, an intermediate more heavily doped n-type region is included as shown.

Electron–hole pairs formed in the depletion region when light with wavelength less than hc/E_g is absorbed are separated by the electric field in this region and can be detected in two ways. If the photodiode is left open circuit, a voltage V_p appears across the diode, varying logarithmically with the incident irradiance P_D as follows:

$$V_p = \frac{kT}{e} \ln\left(\frac{\eta P_D A e \lambda}{h c i_0}\right) \quad (19.79)$$

where η is the probability of a photon being absorbed, A is the active area of the photodiode, and i_0 is the dark current due to thermal generation. This is the photovoltaic mode of operation. If the diode is operated with a reverse bias, a photon-generated current i_p flows given by the following expression:

$$i_p = \frac{\eta P_D A e \lambda}{h c} \quad (19.80)$$

TABLE 19.6 The Characteristics of a Number of Different Types of Light Detector

| Description | Active Region | Response | Spectral Response | Dark Current | Response Time | Acceptance Angle |
|-------------------------------------|---------------------------------|-----------------------------------|--------------------------------|--------------|---------------|------------------|
| Medium area silicon photodiode | 41.3 mm ² | 0.5 A W ⁻¹ peak | 800 nm peak, range 350–1100 nm | 4 nA | 25 ns | NA |
| Ultra high speed silicon photodiode | 0.5 mm ² | 0.35 A W ⁻¹ | 800 nm peak, range 400–1000 nm | 10 nA | 1 ns | NA |
| Filtered silicon photodiode | 7.5 mm ² | 7 nA lux ⁻¹ | 560 nm peak, range 460–750 nm | 2 nA | 3.5 μs | 100° |
| 16 photodiode array on 1 mm pitch | Each diode 0.66 mm ² | 0.6 A W ⁻¹ | 900 nm peak, range 400–1100 nm | 0.1 nA | 4 ns | NA |
| Silicon phototransistor | 0.7 mm ² | 9 μA lux ⁻¹ | 880 nm peak, range 450–1100 nm | 0.3 μA | 15 μs | 30° |
| Silicon phototransistor | 0.7 mm ² | 2 μA lux ⁻¹ | 880 nm peak, range 450–1100 nm | 0.3 μA | 15 μs | 80° |
| CdS photoconductor | 6.3 mm dia. | 9 kΩ at 10 lux, 400 Ω at 1000 lux | 530 nm peak | NA | 100 ms | NA |

FIGURE 19.105 A simple phototransistor light detector circuit is shown. Photon-generated current flowing in the base-collector diode may be amplified several hundred times by transistor action. Although the photon-generated current is much larger than in an equivalent photodiode, response time of the phototransistor is much longer.

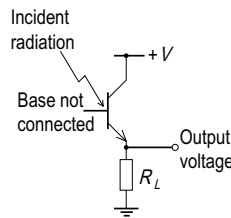

In this photoconductive mode, the current through the photodiode varies linearly with light irradiance. The dark current i_0 varies rapidly with temperature and limits the sensitivity of the device but the photoconductive mode generally has faster response, better stability, and wider dynamic range than the photovoltaic mode. The responsivity K_D of the detector is defined by the relation $i_p = K_D P_D$ and is less than 1 A W^{-1} for a silicon diode. In the ideal case, K_D varies linearly with wavelength, according to Eq. (19.80), up to the threshold value set by the energy gap. Photodiodes are available with a wide variety of characteristics differing in sensitivity (area), speed of response, spectral response, and acceptance angle. They are available with single devices or multiple devices (quad, linear array) in a single package.

The output signals from photodiodes needs amplification for many applications. This may be provided by a separate amplifier or by providing internal gain as in the phototransistor. This is constructed so that radiation can fall on the base region of the transistor and the resulting base current is then internally amplified. Often there is no external connection to the base and the amplified photocurrent is monitored using the simple circuit shown in Fig. 19.105. A typical phototransistor has a responsivity several hundred times higher than that of a photodiode but the frequency response is relatively poor. Phototransistors are often integrated with a spectrally matched LED into a single sensor package to act as a proximity sensor, as in end-of-tape sensors, coin detectors, and level sensors. For reference, the characteristics of several different types of discrete light detector are listed in Table 19.6.

By fabricating many small light detectors in a closely spaced array, it is possible to measure light intensity at an array of points over a region. This is ideal for electronic imaging applications involving video and still cameras. Image sensors designed for this purpose are discussed in the section titled “Image Sensors,” but first it is useful to consider the formation of the images which the detectors sense.

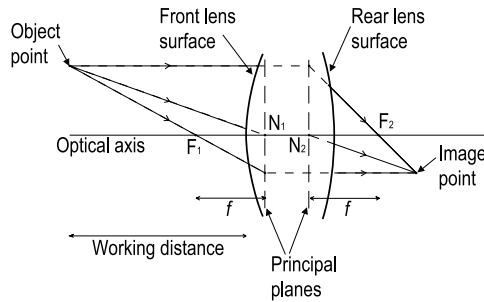

FIGURE 19.106 The cardinal points of a multi-element lens operating in a single medium (usually air) are indicated. The principal points and nodal points then coincide at N_1 and N_2 and the front and rear focal lengths are equal (f). Three rays from an object point are traced through the lens to the corresponding image point using the properties of the cardinal points. In the case shown the image magnification is 0.5, so the image is some distance behind the rear focal point F_2 . For distant objects the image plane would coincide with the plane transverse to the optical axis passing through F_2 . Lenses are normally corrected for aberrations assuming that the object distance will be greater than the image distance. In this case, for close-up work when the image distance is greater than the object distance, the image quality is improved by reversing the lens.

Image Formation

Although perfect images are formed by small pinholes, lenses are needed to form bright images and range from simple single-component lenses used to increase the amount of light falling on a single detector or in low-cost cameras to complex zoom lenses, with between 14 and 20 components, capable of producing high quality images of varying size. The two most important properties of a lens are its focal length f , which determines the imaging behavior, and its light-gathering power or speed, specified by an f-number $f_\#$. A lens has an optical axis passing through the central axis of each of its components along which a ray of light passes without deviation. A lens is characterized, regardless of its complexity, by six cardinal points [2] spaced along the optical axis as illustrated in Fig. 19.106, for a positive converging lens. The position and magnification of the image of an object can be determined using these cardinal points, which include two focal points, two nodal points, and two principal points. The nodal points have the property that a ray outside the lens travelling towards one nodal point emerges from the lens in a parallel direction, appearing to come from the other nodal point. The focal point is the point which a ray of light incident on the lens parallel and close to the optical axis converges to (positive lens) or diverges from (negative lens) after passing through the lens. The point where the lines colinear with the ray on the two sides of the lens intersect defines a point on the principal plane. The point where the optical axis intersects the principal plane is called the principal point. There are two nodal points, focal points and principal planes, because light can be incident on the lens from either side. The front and back focal lengths of the lens are the distances between the front and back focal points and their corresponding principal planes. In the normal situation, when the lens is operating in a single medium, such as air, the positions of the nodal points and principal points coincide and the front and back focal lengths are equal. In general, when the lens construction is asymmetric, the front and back focal points are at different distances from the corresponding external lens surface. In the case of an ideal thin lens, the principal planes coincide with the lens center but in multi-element lenses they may be separated by +20 to -10 mm, depending on the lens design. A lens of focal length f produces an image in best focus at a distance v when the object is at distance u where

$$\frac{1}{u} + \frac{1}{v} = \frac{1}{f} \quad (19.81)$$

and the distances are measured to the corresponding principal planes. The image magnification m , defined as the ratio of image to object sizes, is equal to the ratio of the image to object distances and is related to

the total distance between object and image D_T by

$$D_T = \frac{f(m+1)^2}{m} + D_N \quad (19.82)$$

where D_N is the separation between the principal planes. Lenses generally have a focusing range around 5–10% of the focal length giving a maximum magnification of 0.05–0.1. For larger magnifications extension rings can be fitted between the lens and sensor mounting. The extension size required, with the lens focused at infinity, is simply the product of the magnification and the focal length, since image distance is $f(m+1)$. When a lens is focused to produce an optimally sharp image for a particular object distance u , there is range of closer and further object distances over which the image is still acceptably sharp. This range is called the depth-of-field or depth-of-view F_o and its size depends on the f-number of the lens, the magnification, and the acceptable blur spot size C in the image plane [7]. The blur spot size depends on the image sensor and for 35 mm film C is usually assumed to be between 0.02 and 0.033 mm, while for an image sensor array C is the separation between the individual detector elements, typically about 0.01 mm. Depth-of-field decreases with magnification and for m greater than 0.1 is calculated using the following formula:

$$F_o = 2f_{\#} \frac{C(m+1)}{m^2} \quad (19.83)$$

The accuracy of alignment required of the image sensor depends on the depth-of-focus F_p , which is the longitudinal range of image positions over which the image is acceptably sharp. Sensor alignment is most critical when the lens f-number is small and the image magnification is also small. When m is small F_p reduces to $2Cf_{\#} v/f$ and equals $m^2 F_o$. When m is large, the depth-of-focus is not so critical.

It is frequently necessary to relate the lighting of a scene to the image irradiation falling on a sensor. As accurate calculations are difficult, it is usually best to make a simple estimate and then make fine adjustments to the lighting or lens aperture. When the object of interest in the scene is not a light source but is visible because it is reflecting light, then its luminance must be estimated from the radiation falling on it and the reflection coefficient R_o of its surface [3]. For example, if the object is a Lambertian surface, with illumination L_o , then its luminance is given by

$$B = L_o \frac{R_o}{\pi} \quad (19.84)$$

When a lens is used to form an image of the object, the illuminance on the optical axis in the image plane L_s in lux is related to the luminance of the object B in cd m^{-2} by

$$L_s = \frac{TB\pi}{[2f_{\#}(m+1)]^2} \quad (19.85)$$

where $f_{\#}$ is defined as the ratio of the focal length to diameter of the effective lens aperture and losses in the lens are characterized by a transmission coefficient T [7]. Due to a number of geometrical factors, the image illumination falls off with angle θ from the optic axis as $\cos^4\theta$. Near the axis, the illuminance varies only slowly with angle but at an angle of 30° it has fallen by 44%. Equation (19.85) is the basis for rating the speed of lenses by their f-numbers and indicates that the smaller the f-number, the greater the image illuminance. This formula is appropriate when the magnification is small, but for close-up work, when the image distance is significantly greater than the focal length, the f-number $f_{\#}$ should be replaced by $(m+1)f_{\#}$ when calculating image illuminance.

Lenses are manufactured to match standard image sizes such as the 36 mm × 24 mm 35 mm photographic format and the standard television sensor sizes 1", 2/3", 1/2", 1/3", and 1/4". These sizes are defined to be twice the horizontal dimension of a rectangular image with 4:3 aspect ratio so that, for example, a 1" sensor has a width of 12.7 mm, a height of 9.5 mm, and a diagonal length of 15.9 mm. Lens sizes are similarly specified to allow easy matching of lenses to sensors. The maximum angular field-of-view F_{OV} of a lens focused at infinity is given by

$$F_{OV} = 2 \tan^{-1} \left(\frac{C_F}{2f} \right) \quad (19.86)$$

where C_F is the diagonal of the sensor format. For example, a 35-mm lens with a focal length of 55 mm has a field of view of 43°. Because image distortion and sharpness worsen towards the edges of the field of view it is acceptable, for example, to use a 2/3" lens with a 1/2" sensor, but not the converse. A 35-mm camera lens generally performs much better, at relatively low cost, than a corresponding C-mount lens supplied for a TV camera but a C-mount to Pentax, Cannon, or Nikon mount converter is then required.

Image Sensors

The generation of an output signal from a standard image sensor involves up to four operations: the conversion of the spatial distribution of light irradiance in the image plane into a corresponding spatial distribution of charge; the accumulation and storage of this charge near the point where it is generated; the transfer or read-out of this charge; and the conversion of the charge to an output voltage signal. Each of these operations can be achieved in many ways. Vacuum tube sensors such as vidicons, for example, use a photoconductive detector material and a scanning electron beam for read-out while CMOS sensors use a photodiode detector and a readout bus. Solid state devices are currently the most widely used types, so only CCD and CMOS sensors are considered here. In these devices the image irradiance is measured on a one- or two-dimensional array of sample regions with positions fixed during fabrication. Each sample is called a picture element or pixel and the greater the number of pixels, the higher the resolution with which the image can be recorded. Area sensors are manufactured with numbers of pixels ranging from tens of thousands to several million. Color sensors are achieved by placing color filters over the individual pixels, in a mosaic or stripe pattern, and interpolating the color values at pixels where necessary from the neighboring values. In such color devices the color resolution is lower than the luminance resolution, but this is not important for many applications because the resolution of the human eye is worse for color than for luminance. More expensive color cameras use three precisely aligned sensors, one for each primary color. Cameras incorporating such sensors generally produce either a television standard signal [8] (RS-170 monochrome and NTSC color for 525 American television or CCIR monochrome and PAL color for European television) or a digital signal such as RS-423, USB or IEE 1394 Fire Wire, which can be readily connected to a computer.

Charge-Coupled Devices

In a charge-coupled device [9] an isolated packet of charge, of between 10 and 10^6 electrons, is moved through the semiconductor, from a position in one CCD cell to a position in an adjacent cell, by applying a sequence of voltage pulses to gate electrodes. In CCD-based light sensors, photon generated charge packets accumulate in photosites, which are modified CCD cells, and are then transported through other CCD cells to another modified cell with a readout amplifier attached. A CCD is fabricated on a single crystal wafer of P-type silicon and consists of a one- or two-dimensional array of charge storage cells, on centers typically about 10 μm apart. The operation of a 3-phase CCD cell is illustrated in Fig. 19.107. Each cell has three closely spaced electrodes (gates) on top, insulated from the silicon by a thin layer of silicon dioxide. A positive voltage applied to one of these gates will attract and store any free charge generated in the silicon due to light or thermal action while free holes are repelled and collected by the substrate electrode. Lower voltages on the adjacent gates isolate it from the neighboring cells, creating a

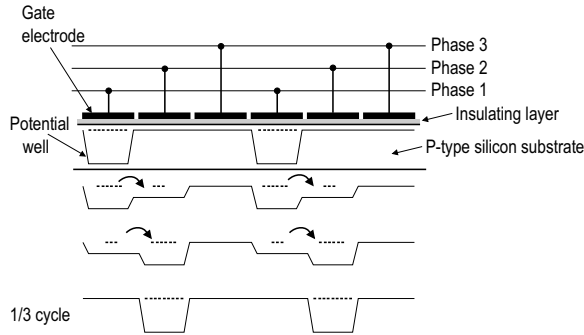

FIGURE 19.107 The movement of charge from one potential well to the next in a 3-phase CCD is illustrated. Each CCD cell has three gate electrodes. In the upper potential diagram, the well is formed under the first electrode in each CCD cell by voltage applied to the phase 1 line. As the voltage is reduced on the phase 1 line and increased on the phase 2 line, the original potential wells collapse and new ones form under the second gate in each cell, causing any charge present in the wells to move sideways as indicated. Two more cycles are required to complete the movement of charge into the first well of the next CCD cell.

localized potential well within the cell. A cell of size $8 \mu\text{m} \times 8 \mu\text{m}$ can hold about 200,000 electrons before saturating. Cells designed to be light sensitive have electrodes made of semitransparent polysilicon so that light can penetrate into the storage region, while cells intended only for charge transport are covered with a surface layer opaque to light. During operation, the voltages on the electrodes are held constant for a time (integration time) to allow packets of charge to accumulate on the photosites in proportion to the local irradiance. At the end of this time a sequence of voltage pulses are applied to the electrodes to transfer the packets of charge from one storage cell to the next until they reach a sensing amplifier, which generates a voltage which is about $0.6 \mu\text{V}$ per electron. The charge transfer efficiency (CTE) of real devices is less than 100% and between 99.95% and 99.999% of the stored charge is moved to the next cell, depending on the precise construction and clocking frequency. This allows devices to be manufactured with a line of many hundreds or thousands of storage cells feeding a single amplifier.

Although there are many variations in CCD construction, the basic characteristics of CCDs from different manufactures are similar. CCD light sensors have an inherently linear variation of output voltage with irradiance, from the minimum useful level set by noise to the maximum useful level set by saturation of the output amplifier or by the limited capacity of the charge storage cells. The dynamic range of the device is defined as the ratio of the maximum output signal to the output resulting from noise. Manufacturers sometimes quote noise figures as peak-to-peak or as root-mean-square values (typically five times smaller), but the former value is more relevant for imaging applications. Due to manufacturing limitations, the photosites do not have identical sensitivity and dark signal characteristics. For example, photoresponse nonuniformity (PRNU) is easy to measure using uniform sensor illumination and is typically 5–10%. Its effects can be removed, if necessary, by calibration. The basic spectral response of a silicon sensor extends from 200 to 1100 nm, with a maximum sensitivity of about $1 \mu\text{A}$ of generated charge per microwatt of incident radiation, but this is modified by the electrode structures formed on the surface of the silicon. Longer wavelength photons penetrate more deeply than shorter wavelength photons and the short wavelength response is typically worsened to 450 nm by absorption in the surface layers. Infrared photons may generate electrons some distance from the point of entry into the silicon, with the result that the charge may be collected by a different cell. This reduces the resolution of the device and if infrared operation is not required, but the illumination contains infrared (for example, from a tungsten lamp), an infrared reflecting filter (a hot-mirror filter) is often used. If the widest possible spectral response is required, devices have the substrate thinned and are operated with the illumination falling on the back surface, which is free of electrodes. Back illuminated devices are fragile and costly but are used in specialist low-light applications like astronomy and biology.

All CCD cells accumulate charge linearly with time due to thermally generated electrons produced within the cells and at electrode interfaces. Like the photoresponse, this dark signal varies from cell to cell and can be compensated for by calibration. These thermally generated contributions are most significant for low-light level applications and can be reduced by cooling the sensor using either a thermoelectric cooler, a Joule Thomson cooler, or a liquid nitrogen dewar. The dark signal reduces by 50% for every 7°C reduction in temperature and at -60°C, produced by a Peltier cooler, the dark signal is typically reduced to about one electron per pixel per second. Another important temperature dependent characteristic of the CCD sensor, which improves with cooling, is the noise floor of the output amplifier which is proportional to $T^{1/2}$ and typically equivalent to about 300 electrons at room temperature. A CCD device used in astronomy illustrates the performance achieved by cooling. Operated at about -110°C, this device has a readout noise of about 10 electrons, a dark current less than 0.3 electrons per minute, and a quantum efficiency for converting visible photons into electrons of between 70% and 80%. Light may be integrated for periods of hours compared with the approximately 1/8 s to 1/4 s integration period of the dark adapted eye. Compared with photographic film previously used for low-light level imaging in astronomy, cooled CCDs are from 10 to 100 times more sensitive, linear in response rather than nonlinear, and have a much greater dynamic range so that both faint and bright objects can be recorded in the same exposure.

The transfer of charge from one cell to the next takes time and the CTE worsens with increasing clocking speed and with cooler temperatures. This limits the number of cells which can be used to transport charge from a photosite to the readout amplifier. It also limits the rate at which data can be transferred out of the CCD and the resulting image transfer rate. However, there are many variations in CCD technology aiming to improve performance. For example, virtual-phase CCDs [10] have some of the electrodes replaced by ion-implanted regions resulting in improved blue response and higher sensitivity, because of the removal of some of the blocking surface gates and simpler drive circuitry due to the lower number of gates per cell. The biggest contribution to the dark signal is defects at interfaces and a manufacturing technique known as pinning can be used to passivate the interface states, producing an order of magnitude improvement in a dark signal as well as improved quantum efficiency and CTE. The readout noise performance can be improved by a signal-processing technique called correlated double sampling. This involves taking the output as the difference between two signals, one with the charge signal present and one without, so that major noise components are cancelled. A number of architectures are employed in CCD devices [11]. Several of these, including linear devices and area devices of the full-frame, frame transfer, and interline transfer types, are discussed in the following sections.

Linear Charge-Coupled Devices

A linear CCD sensor consists of a line of up to several thousand photosites and an adjacent parallel CCD shift register terminated by a sensing amplifier. Each photosite is separated from a shift register cell by a transfer gate. During operation a voltage is applied to each photosite gate to create empty storage wells, which then accumulate amounts of charge proportional to the integral of the light intensity over time. A transfer pulse at the end of the integration period causes all the accumulated charge packets to be transferred through the transfer gates to the shift register cells. The charges are clocked through the shift register to the sensing amplifier producing a sequence of voltage pulses with amplitudes proportional to the integrated light falling on the photosites. In practice it is common for shift registers to be placed on both sides of the photosites with alternate photosites connected by transfer gates to the right and left registers. These halve the time required to clock out all the data. There is a limit to the number of electrons (typically 1000–2000 times the area of the photosite in μm^2) which can be stored in a cell, before electrons start to spill over into adjacent cells. This blooming effect is a problem with images containing intense highlights. It is reduced by about a factor of 100 by adding antiblooming gates between adjacent photosites and transfer gates and channel stops between adjacent photosites. The voltage on the antiblooming gates is set at a value which allows surplus charge to drain away instead of entering the transfer gates and shift register. By clocking this voltage, variable integration times which are less than the frame pulse to frame pulse exposure time can also be attained.

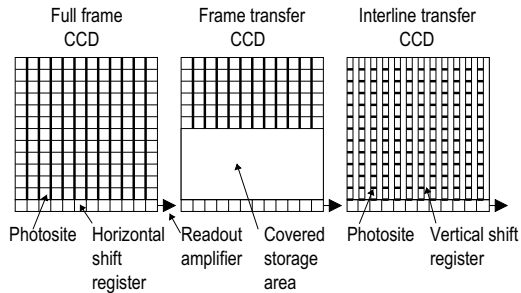

FIGURE 19.108 The three basic architectures used in area CCDs are illustrated. In the full-frame transfer CCD most of the device area is employed as photosites. Photon-generated charge is transferred down each column one cell at a time into the horizontal shift register where it must all be transferred to the readout amplifier before another vertical movement of charge can take place. The frame-transfer CCD reduces the need for a mechanical shutter to prevent charge smearing, which would otherwise occur, by providing a covered storage area into which all the photon-generated charge can be rapidly shifted vertically at the end of the integration period. The interline-transfer CCD allows all the photon-generated charge to be transferred to the covered vertical shift registers in one step, virtually eliminating this source of charge smearing.

Area Charge-Coupled Devices

Three basic architectures are used in area CCDs and are illustrated in Fig. 19.108. The full-frame CCD consists of an imaging area separated from a horizontal CCD shift register by a transfer gate. In the imaging area each photosite is one stage of a vertical shift register separated from neighboring shift registers by channel stops and anti-blooming structures. During the light integration period, the vertical clocks are stopped and the photosites collect photoelectrons. At the end of this period the charge is clocked out vertically, one row at a time into the horizontal shift register. The charge in the horizontal shift register is then very rapidly shifted towards the output amplifier by the application of a horizontal clock signal. For example, the RA1001J, 1024 × 1024 pixel full-frame CCD from EG&G Reticon achieves a readout rate of 30 frames per second. To avoid image smear during the readout period, full-frame sensors must be operated with external shutters or used in low-light level applications requiring very long integration times compared with the readout time, as in astronomy.

The frame-transfer CCD greatly reduces the need for an external shutter by providing a light-shielded storage section into which the entire image charge is shifted at a rate limited primarily by CTE considerations. The charge is read from the storage region during the next integration period without any further image smearing. In some devices, such as the EG&G Reticon RA1102, the storage area is split into two on opposite sides of the imaging area. This improves performance by halving the maximum number of transfers required to reach the nearest storage region. With sensors designed for interlaced operation, as opposed to the non-interlaced progressive scan readout mode, this reduction occurs automatically. Each integration period then corresponds to one video field and only half the number of rows in the frame is required at any one time. For example, to produce an interlaced video frame containing 576 image lines (CCIR standard), a frame transfer sensor with only 288 rows of storage is required. By changing the clock signals, the odd field can be displaced vertically by half a line width relative to the even field. This ensures that the odd and even lines contain different information and reduces aliasing because the cell width is twice the separation between the lines in the frame. Many companies produce frame-transfer CCD sensors and cameras including Cohu, Dalsa, EG&G Reticon, EEV, Kodak, Philips, and Thomson-CSF.

The interline-transfer (ILT) architecture virtually eliminates image smear by providing each column of photosites with an adjacent light-shielded vertical CCD shift register into which the charge is transferred by a transfer pulse. The contents of all the vertical shift registers are then shifted simultaneously one pixel at a time into a horizontal shift register where they are rapidly shifted to an output amplifier. This approach makes it easy to achieve short integration times and true “stop-motion” exposure control with progressive scan. It also increases the “dead space” between the active pixels reducing the sensitivity of

the image sensing area and increasing aliasing effects compared with frame-transfer sensors. For the latter, the fill factor, which is the percentage of the imaging area which is light sensitive, can be close to 100% whereas it is usually less than 50% for interline-transfer devices. Localized bright objects tend to produce vertical streaks in an ILT device because strong light can leak under the narrow light shield covering the vertical shift registers, causing image smearing similar to that in a full frame device. For interlaced operation, two adjacent pixels, for example, 1 and 2, 3 and 4, etc. are transferred to a single shift register cell on one field and in the next field pixels 2 and 3, 4 and 5, etc. are transferred together. This is rather similar to the interlaced operation of a frame transfer CCD. Many companies manufacture ILT CCD sensors and cameras including, Hitachi, NEC, Panasonic, Pulnix, and Sony.

CMOS Sensors

CMOS image sensors are based on a technology that is older than CCD technology [12]. However, CCD sensors originally offered better image quality than CMOS devices could match so they came to dominate the market. There is now renewed interest in the older technology because it potentially offers major advantages over CCDs. The CMOS process used in sensors is similar to that which has been highly developed in order to manufacture dynamic RAM and consequently should be able to produce cheap, small high-resolution, randomly addressed, low-power sensors. It is also possible to integrate image sensing, control, processing, and interfacing on the same chip, so that a camera on a chip is possible using CMOS technology, but not with CCD technology. As a result of recent research and development, several manufacturers are now claiming to have achieved CMOS sensors providing similar quality to that of mainstream CCDs. Manufacturers producing CMOS sensors include Fillfactory, National Semiconductor, Philips, ST Microelectronics, and Y Media.

A CMOS sensor consists of an array of photodiodes, which are connected to readout amplifiers by bus lines and MOS switches. The principle of readout is illustrated in Fig. 19.109. Each pixel is connected to an output amplifier by a switch whose control line is connected to a digital shift register. Shifting a bit through the register connects the photodiodes sequentially to the output amplifier. Random readout of the photodiodes can be achieved by replacing the shift register by an address decoder connected to an address bus. Two-dimensional arrays of photodiodes are connected in a configuration similar to a cross-point switching matrix with a switch and diode at each cross point and separate vertical and horizontal shift registers. To scan the array, the vertical shift register turns on a complete row of switches and the photodiodes in that row output their signals into vertical bus lines. These are connected, in turn, to an

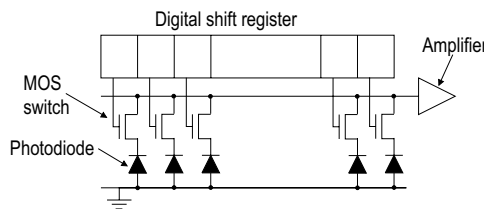
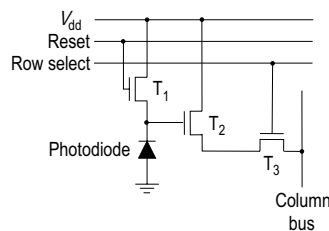

FIGURE 19.109 The principle of readout in a one-dimensional CMOS sensor is illustrated. Each pixel is connected to an output amplifier by a MOS switch whose control line is connected to the digital shift register. Shifting a bit through the register connects the photodiodes, in turn, to the output amplifier.

FIGURE 19.110 A typical CMOS three-transistor active pixel is shown. Transistor T_1 is connected to the reset line allowing the capacitance of the photodiode to be reset at the start of photo-current integration. In the continuous mode CMOS device this transistor is connected to act as high value resistor. Transistors T_2 and T_3 allow the signal to be transferred from the photodiode to the column amplifier, via the column bus line.



output amplifier by a set of switches connected to the horizontal shift register. Using two separate vertical shift registers and separating row select and row reset functions enables a rolling curtain type of electronic shutter to be implemented with an exposure ratio equal to the number of rows.

Photodiode arrays generally have less extensive electrode structures over each sensing element compared with CCD arrays and consequently the spectral response is smoother and extends further at the blue end of the spectrum, which is an advantage for color sensors. The peak quantum efficiency is also higher ranging from 60% to 80% compared with 10% to 60% for photogates, leading to almost twice the electrical output power for a given light input power. On the other hand, photodiodes have higher noise levels than CCDs because of the reverse-bias leakage current. The photodiode can be operated in integrating mode or in continuous mode. In the former, the photodiode capacitance is reset to a reference reverse bias and then allowed to float. The charge on the photodiode capacitance is then discharged by photon-generated current and leakage currents. After a specified integration time, the remaining charge can be read and the difference from the reference value is proportional to the diode irradiance if the leakage sources are negligible. Both passive and active pixel devices have been developed. In the latter, the charge on the photodiode is read out through a MOS field effect transistor (MOSFET), which converts charge to voltage and provides gain. Figure 19.110 illustrates a typical three-transistor active pixel. Transistor T1 resets the photodiode and after an integration period the pixel signal is read out through the source-follower transistor T2 and the selection transistor T3. Two disadvantages of this approach are a low fill-factor, because of the pixel area used by the amplifying transistor, and the increased pixel nonuniformity because of variations in transistor characteristics. In the *ibis* range of CMOS sensors designed by FillFactory, a small area photodiode is used which reduces dark current and kTC noise while also increasing the charge-to-voltage conversion factor ($9 \mu\text{V}$ per electron at output in *ibis1*). The pixel architecture introduces a small potential barrier, which prevents photon-induced electrons from being collected by structures in the pixel other than the photodiode. This allows the photodiode to collect most of the electrons generated in the substrate beneath the pixel effectively increasing the fill-factor [13]. In integrating devices, the fixed pattern noise resulting from variations in MOSFET thresholds can be reduced by correlation double sampling. The pixel is sampled at the end of the integration period and the pixel is reset and sampled again. The difference in the two samples is the measure of the light intensity and is free of pixel offsets. Photoresponse nonuniformity is harder to control. It is caused by variations in the photodiode collection volume, junction capacitance, and gate capacitance of the MOSFET amplifier. In the *ibis4* 1280×1024 pixel sensor, PRNU is quoted as less than 10% peak-to-peak with half saturation in the neighborhood.

A light sensor with a continuous pixel response has the advantage that pixels can be accessed in any order without an integration time so an image processing algorithm could decide, on-the-fly, which pixel or group of pixels to read next. In the *Fuga* range of sensors designed by FillFactory, continuous mode operation is achieved by passing the photon-generated current through a series resistance [14]. Because the photon-induced current is very small, the series resistance must be very large and it is realized by a MOSFET operated in weak inversion. The resulting current-to-voltage conversion is logarithmic and the devices have a very wide dynamic range (six orders of magnitude or 120 dB) with a quoted dark limit of 10^{-4} W m^{-2} . The output signal of an individual pixel cannot respond instantaneously to a change in irradiance because of the RC time constant of the photodiode capacitance and the series resistance. A typical value for this time constant is a fraction of a millisecond. The fixed pattern noise of these devices due to pixel nonuniformity is very large, around 50–100%, and cannot be reduced by correlated double sampling because of the continuous response. However, it is static and can be greatly reduced using correction values stored in a look-up table implemented in PROM, so that fully corrected monochrome or color cameras with 1024×1024 pixels are available with *Fuga* sensors.

Vision Systems

Machine vision is used in a wide variety of applications including manufacturing operations, measurements in science and engineering, remote surveillance, and robotic guidance. In machine vision systems the principal imaging component is not just a sensor chip, but a complete camera, like those shown in



FIGURE 19.111 Three solid state cameras are shown. The nearest is an inexpensive single board camera with a CMOS sensor and 4-mm lens. The middle one is a miniature CCIR interline frame-transfer CCD camera, dwarfed by the 9.5- to 75-mm C-mount zoom lens. The rear camera is a high quality Cohu 4712 monochrome frame-transfer CCD camera fitted with a 16-mm C-mount lens and 20-mm extension tube.

Fig. 19.111, including sensing array, associated electronics, output signal format, and lens. Depending on the application the camera could be RS-170/CCIR monochrome, NTSC/PAL color, progressive scan, variable scan, or line scan. Five major system parameters which govern the choice of camera are field of view, resolution, working distance, depth of field, and image data acquisition rate. Color may also be important to the application, but otherwise monochrome images are preferred because they require less memory and process faster. As a rule of thumb, for size measurement applications, the sensor should have a number of pixels at least equal to twice the ratio of the largest to smallest object sizes of interest. Lighting should be arranged to illuminate the objects of interest so that the best possible images can be acquired. Lighting might be ambient, high-frequency fluorescent, LED, incandescent, or quartz halogen.

A frame grabber or video capture card, usually in the form of a plug-in board which is installed in the computer, is often required to interface the camera to a host computer. Camera suppliers can recommend compatible frame grabbers. The frame grabber will store the image data from the camera in on-board, or system memory, sampling and digitizing analog data as necessary. In some cases the camera may output digital data, which is compatible with a standard computer interface like USB 2.0 or IEE-1394 Fire Wire, so a separate frame grabber may not be needed. The computer is often a PC or Macintosh and should be as fast as possible to keep the time needed to process each image as short as possible, or to allow more processing to be done in the time available. Machine vision software is needed to create the program which processes the image data. This may come in many forms, including C libraries of device drivers and functions, ActiveX controls, and point and click programming environments which allow easy assembly of image processing operations. When an image has been analyzed the system must be able to communicate the result to control the process or to pass information to a database. This requires a digital I/O interface or network connection. The human eye and brain can identify objects and interpret scenes under a wide variety of conditions. Machine vision systems are far less versatile so the creation of a successful system requires careful consideration of all elements of the system and precise identification of the goals to be accomplished, which should be kept as simple as possible.

References

1. Wilson, J. and Hawkes, J. F. B., *Optoelectronics: An Introduction*, Prentice-Hall International, London, 1983.
2. Jenkins, F. A. and White, H. E., *Fundamentals of Physical Optics*, 4th ed., McGraw-Hill, New York, 1981.

3. Hewitt, H. and Vause, A. S., *Lamps and Lighting*, Edward Arnold, London, 1966.
4. Fraden, J., Pyroelectric thermometers, in *The Measurement, Instrumentation and Sensors Handbook*, Webster, J. G., Ed., CRC Press, 1999, chap. 32.
5. Schuermeyer, F. and Pickenpauh, T., Photoconductive sensors, in *The Measurement, Instrumentation and Sensors Handbook*, Webster, J. G., Ed., CRC Press, 1999, chap. 56
6. Sze, S. M., *Semiconductor Devices*, John Wiley and Sons, New York, 1985.
7. Ray, S. F., *Applied Photographic Optics*, 2nd. ed., Focal Press, Oxford, 1994
8. CCIR, *Characteristics of Monochrome and Colour Television Systems*, Recommendations and Reports of the CCIR, Vol. XI, Part 1: Broadcasting Service (Television), Section IIA, 1982.
9. Amelio, G. F., Charge coupled devices, *Scientific American*, 176, 1974.
10. Sheu, L. and Kadekodi, N., Linear CCDs, Advances in linear solid-state sensors, *Electronic Imaging*, August, 72, 1984.
11. Rutherford, D. A., A new generation of cameras tackles tomorrow's challenges, *Photonics Spectra*, September, 119, 1989.
12. Asano, A., MOS sensors continue to improve their image, *Advanced Imaging*, 42-44f, 1989.
13. Dierickx, B., Meynants, G., and Scheffer, D., Near 100% fill factor in CMOS active pixels, in *Proc. IEEE Workshop on Charge-Coupled & Advanced Image Sensors*, Brugge, Belgium, P1, 1997.
14. Ricquier, N. and Dierickx, B., Pixel structure with logarithmic response for intelligent and flexible imager architectures, *Microelectronics Engineering*, 19, 631, 1992.

19.9 Integrated Microsensors

Chang Liu

Introduction

The purpose of this section is to provide the general audience in the mechatronics field with information about micro-integrated sensors. It is my wish that an avid reader interested in the sensors area would be able to understand common fabrication techniques and sensing principles, and develop rudimentary background to guide the selection of commercialized sensors and development of custom sensors in the future.

Contents for this section are organized as follows. First, the general history of microsensors is discussed. This is followed by a brief discussion about major fabrication methods for microsensors. Commonly used principles for sensors are reviewed next. Sensing of a physical parameter of interest can be achieved using various structures and under different sensing principles. Examples of sensors, along with their structures and fabrication techniques, are provided to familiarize the readers with the configurations and fabrication methods for each.

The microsensors research area covers diverse disciplines such as materials, microfabrication, electronics, and mechanics. A comprehensive coverage of all aspects is beyond the scope of this book. We will focus on a few primary sensing principles and frequently used sensors examples. A reader would be able to grasp a glimpse of the sensors field from the perspectives of sensing principles and of application areas. References for further in-depth studies are provided when appropriate.

Definition of Integrated Microsensors

Integrated microsensors refer to sensors or arrays of sensors that are developed using microfabrication technology. The characteristic length scale of individual microsensors ranges between 1 μm and 1 mm. Nanosensors refer to sensors with characteristic length scale on the order of 1 nm to 1 μm . In this text, we are mainly concerned about sensors for detecting physical variables such as force, pressure, tactile contact, acceleration, rotation, temperature, and acoustic waves. Chemical sensors, used for sensing the concentration of chemicals or pH values, are beyond the scope of this book.

A brief historical overview of microsensors development is presented here. The microsensors are made possible by using integrated microfabrication technology, first developed for making integrated circuits. Since the invention of the first transistor in 1947 and the successful demonstration of the integrated circuits in 1971, technologies and equipment for building integrated and miniature circuit components on semiconductor substrates (e.g., silicon and GaAs) have improved rapidly. The integration density doubles every 12–18 months following the empirical Moore's law. The integrated circuit technology revolutionized the modern society by enabling low cost analog signal processors, digital logical units, computer memories, and CCD cameras. These achievements should serve as evidence of the power of integration and miniaturization technology.

Advanced signal processors such as analog ASIC (application specific integrated circuits) and CPU (central processing units) are merely one aspect of a highly intelligent mechnronics system. Sensors are of critical importance for mechantronics systems to interact with the physical world. In the 1970s, a few researchers experimented with using IC fabrication technology to realize mechanical transduction elements on a silicon chip. H. Nathansan [1] developed floating gate transistors where the gate is made of a suspended cantilever beam and its distance to the conducting channel can be adjusted using electrostatic forces. Work by several pioneering researchers resulted in the first commercial pressure sensors [2], accelerometers [3], integrated gas chromatometers, as well as the ink jet printer nozzle array [4,5].

There are several important advantages associated with integrated microsensors compared with conventional macroscopic sensors. Miniaturization of sensors means that such sensors offer better spatial resolution. In many cases, reduced inertia and thermal mass translate into higher mechanical resonant frequency and lower thermal time constants. Since such sensors are fabricated using photolithography methods, their costs can be low, as many identical units are made in parallel (if the demand is sufficiently large). Further, since the geometric features of sensor components are defined by precision photolithography, the uniformity and repeatability of the performance of such sensors are significantly improved over conventional sensors. The capability to monolithically integrate sensors and integrated circuits reduces the path length between sensors and circuits and increases the signal-to-noise ratio.

Fabrication Process of Integrated Microsensors

As mentioned previously, the microfabrication technology for microsensors was developed based on integrated circuits-compatible platforms. As a result, silicon has historically been a predominant material for microintegrated sensors. In other words, a majority of sensors are now made with silicon wafer as a substrate. However, in recent years, new materials such as polymers are being applied to microfabrication. Polymer materials offer lower costs than single crystal silicon wafers and, in some cases, simpler processability, compared with semiconducting silicon. There are few examples of sensors that are entirely based on polymer these days, because certain key sensing elements are not yet available in polymer format. However, with the advancement of polymer microfabrication technology and organic semiconductors, all-polymer sensors can be predicted for future use.

Microsensors and mechanical elements (notably cantilevers and diaphragms) can be made from silicon substrates in a variety of ways. The two primary categories of fabrication methods are called bulk micromachining and surface micromachining. In bulk machining, a portion of the silicon substrate is removed using chemical wet etch or plasma-assisted dry etch to render freestanding mechanical members. For silicon substrates, the following wet chemical etchants are frequently used: potassium hydroxide (KOH), ethylene-diamine pyrocatecol (EDP), or tetramethyl ammonium hydroxide (TMAH). Dry etching methods use AC-excited plasma as an energetic source to selectively and anisotropically remove the substrate materials. A review of etching solutions commonly used in the silicon microfabrication industry and their respective etch rates on various materials can be found in [6].

In surface micromachining methods, a freestanding structure typically resides within a thin region near the substrate surface. The fabrication process involves only layers on the surface of a substrate, hence the name surface micromachining. The fabrication process is typically referred to as a sacrificial etching method as well. First, a thin-film solid layer called the sacrificial layer is placed on the wafer surface. This is followed by the deposition of a structural layer, which constitutes the mechanical structure (e.g.,

cantilever or membrane). An etchant that selectively etches the sacrificial layer with a much greater rate than the structural layer is used to remove the sacrificial layer without damaging the structure layer, leaving the structural material freestanding.

In the ensuing section, the fabrication process related to specific examples of sensors will be discussed to illustrate specific uses of bulk and surface micromachining methods. Both surface and bulk micromachining techniques offer advantages and disadvantages. For example, the surface micromachining process is generally compatible with established integrated circuit foundries because no substrate etching is involved. The bulk micromachining also involves somewhat lengthy substrate removal. However, a bulk silicon micromachining process is capable of realizing single crystal silicon structures with extremely low intrinsic mechanical stress and bending. For development of custom sensors, the selection of a fabrication process must be done carefully to achieve desired device characteristics and fabrication yield and to reduce overall sensor costs.

Resources Regarding Sensors

The community that develops microfabrication methods and microintegrated sensors frequently publishes archival results in the *Journal of Microelectromechanical Systems (MEMS)*, *Journal of Sensors and Actuators*, and the *Journal of Micromechanics and Microengineering*. Major conferences in this area include: (1) the IEEE workshop on solid-state sensors and actuators (held biannually at the Hilton Head island, South Carolina); (2) the International Conference on Solid-State Sensors and Actuators (held biannually at international venues); and (3) International Conference on Micro-Electro-Mechanical Systems (held annually at international venues).

Interested readers can find more in-depth discussions on microsensors in a number of reference books [7,8] and websites [9].

Examples of Micro- and Nanosensors

Basic Sensing Principles

Microsensors are based on a number of transduction principles, including electrostatic, piezoresistive, piezoelectric, and electromagnetic (including optical sensing). The fundamental principles of these sensing methods are discussed in the following.

Electrostatic Sensing

In electrostatic sensing, a physical variable of interest, such as force or vibration, is transduced into mechanical displacement of a cantilever beam or a membrane. A schematic diagram of a typical transduction structure is shown below (Fig. 19.112). The moving cantilever or membrane forms a capacitor with a reference, typically immobile, electrode. For the structure shown in the diagram below, the displacement of the top plate induces changes of the capacitance. The electrostatic sensing is also commonly referred to as capacitive sensing. The changes in capacitance are used to provide information about the parameter of interests. The electrostatic sensing principle can be used for accelerometers, acoustic sensors, rotation gyros, pressure sensors, tactile sensors, and infrared sensors. Respectively in these examples, the external excitations responsible for member movements are inertia force, air mass vibration, Coriolis force, pressure, contact force, and thermal bimetallic bending due to absorbed energy and increased temperature.

The electromechanical model of a simple capacitive sensor shown in Fig. 19.112(a) is illustrated in Fig. 19.112(b). The top electrode is supported by two suspension beams with a combined equivalent force constant (spring constant) of k . The capacitance value of a parallel plate capacitor is expressed as

$$C = \frac{\epsilon_r \epsilon_0 A}{d}$$

where A is the area of the electrode, d is the distance between two electrodes, ϵ_r and ϵ_0 are the relative permittivity of the media and the permittivity of vacuum, respectively. When the distance between the

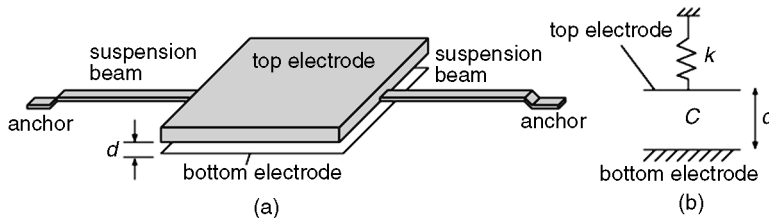

FIGURE 19.112 Schematic diagram of a parallel plate capacitor: (a) perspective view, (b) electromechanical model.

two electrodes changes by Δd , the first-order estimate of the change in capacitance is

$$\Delta C = \frac{C}{d} \Delta d$$

When a force F is applied to the top plate, the change of capacitance value is

$$\Delta C = \frac{C F}{d k}$$

Piezoresistive Sensing

In a piezoresistive sensor, the magnitude of a mechanical displacement is measured by the amount of stress it induces in a mechanical member. A stress-sensitive resistor (called a piezoresistor) located strategically on the mechanical member experiences a change of resistance as a result of the applied stress. Many materials, including metals, alloys, and doped silicon, exhibit piezoresistive characteristics. The applied stress causes the lattice of a material to deform, thereby inducing changes in the resistivity as well as the dimensions of a resistor. The change of resistance (ΔR) as a function of applied strain ε is

$$\frac{\Delta R}{R_0} = G \varepsilon$$

where R_0 is the value of the resistor in the unstressed state, and G is the piezoresistive gauge factor.

Using doped silicon as a piezoresistive sensor, the overall footprint of the sensor can be made quite small and yet have a respectable value, i.e., 1 k Ω . Unlike the capacitive sensor method, which requires significant plate area to achieve significant capacitance value, the piezoresistive sensor is more area efficient. As a result, the piezoresistive sensing is more likely to be used for sensors with characteristic length below 10 μm . However, the capacitive measurement method is more generally applicable, whereas the optimal piezoresistive sensors involve silicon with proper doping concentration.

Piezoelectric Sensing

A piezoelectric material is one that produces electrical polarization (internal electric field) when an external mechanical strain is applied. A piezoelectric material also exhibits reverse piezoresistivity. Namely, a mechanical strain (or displacement) will result when a voltage (or electric field) is applied on the material itself. The reverse piezoelectricity is commonly used as an actuation principle for producing mechanical movement or force.

One advantage of piezoelectric sensing over piezoresistive sensing lies in the fact that piezoelectric sensors are self-generating, i.e., a potential difference will be created without external power supply. However, high quality piezoelectric films with consistent and uniform performance characteristics require dedicated machinery and calibrated processes. Such a technical barrier prevents thin film piezoelectric materials to be as widely used as piezoresistive elements. However, high quality piezoelectric films are

increasingly becoming available through commercial services. Commonly used piezoelectric materials in microfabricated sensors include sputtered zinc oxide and lead zirconate titanate (PZT).

Temperature Sensing

Temperature sensing is used not only for measuring the temperature of the ambient but also for inferring heat transfer. Temperature sensors can be made of thermal resistors or thermal couples. A thermal resistor is a thin film resistive element whose resistance changes as a function of the temperature. This is explained by changes in resistivity as well as dimensions. Doped semiconductor materials (e.g., single crystal silicon or polycrystalline silicon) exhibit temperature coefficients of resistors (TCR, denoted α) on the order of $-0.1\%/^{\circ}\text{C}$ to $5\%/^{\circ}\text{C}$. For a thermal resistor, the normalized changes in resistance (R) are related to the change in temperature (T) by

$$\frac{\Delta R}{R} = \alpha T$$

Thermal couples are made of two different materials with different Seebeck coefficients. The voltage induced by a single thermal couple junction is proportional to the difference in temperatures at the junction and of the ambient. For more information about thermal couples, readers can refer to references.

Temperature sensing is also commonly achieved using a thermal bimetallic beam. A composite beam made of two materials with different thermal expansion coefficients will bend as the two parts expand with different speed. The amount of mechanical bending, sensed electrostatically or using piezoresistors, corresponds to the applied temperature. Such sensing principle has been used for making uncooled infrared sensors.

Pressure Sensors

Pressure sensors are important for industrial and automotive control and monitoring. Existing micro-pressure sensors consist of diaphragms that deform in response to pressure differences. Using micromachining technology, the diaphragms can be made very thin, hence greatly increasing the sensitivity of sensors over conventional pressure sensors with thick diaphragms. Integrated microfabrication technology also enables sensors to be made in conjunction with signal-processing circuits. Since the distance between the sensor diaphragm and the signal processors are close, the noise is generally much lower compared with conventional sensors.

The diaphragm is a critical element in a pressure sensor. It can be made by either surface micromachining or bulk micromachining techniques. Hence, we classify micropressure sensors according to the methods of forming the diaphragms. In each category of pressure sensors, the displacement of the diaphragm can be determined by using piezoresistive sensing or capacitive sensing.

Over the past two decades, many micromachined pressure sensors have been developed, some commercialized successfully for automotive and machinery applications. The intent of this section is not to present an exhaustive summary of all the work that has been accomplished, but rather discuss several representative devices with the purpose of (1) providing the readers with a general overview of the available technologies; and (2) providing leads to the existing body of literature in this area.

Bulk Micromachined Pressure Sensors

The schematic diagram of a bulk micromachined pressure sensor is illustrated in the diagram below. The diaphragm will bend when a differential pressure is applied across it. A common technique for sensing the diaphragm displacement is by using piezoresistors embedded in the diaphragms. However, it should be noted that other sensing principles are also feasible.

In the diagram below (Fig. 19.113), four piezoresistors are embedded near the edge of the diaphragm. The locations of sensors are selected carefully such that under a given displacement at the center of the diaphragm, the magnitude of the stress is the greatest at the sensor locations. There are a number of choices for the diaphragms and the piezoresistors. A number of possible materials and their relative merits are summarized in the Table 19.7. Three distinct pressure sensor architectures and their respective fabrication processes are discussed in the following paragraphs.

TABLE 19.7 A List of Possible Materials for Diaphragm and the Piezoresistive Sensors

| Diaphragm material | Piezoresistor material | Relative merits |
|---------------------------|------------------------------|--|
| Single crystal silicon | Doped single crystal silicon | Relatively difficult to control the thickness of the diaphragm |
| Silicon nitride thin film | Polycrystalline silicon | Easy to form thin diaphragms; involved LPCVD polysilicon |

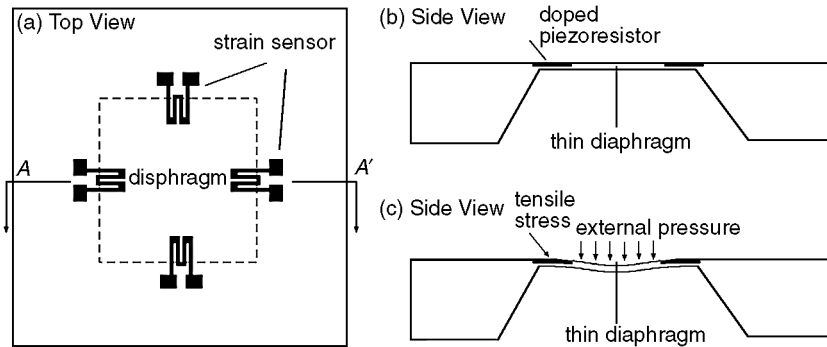

FIGURE 19.113 Schematic diagram of a bulk micromachined pressure sensor.

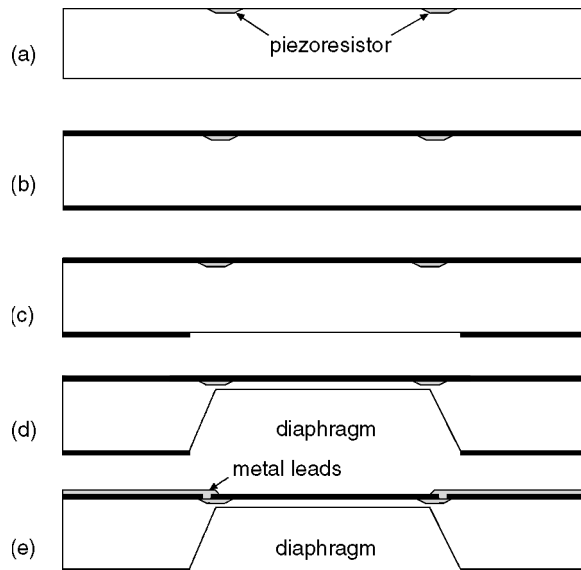

FIGURE 19.114 Schematic diagram illustrating major steps in the microfabrication process of a bulk micromachined pressure sensor.

The fabrication process for a pressure sensor using plain silicon wafer as the substrate is shown in Fig. 19.114. In the first step, the wafer is selectively doped with boron or phosphorous atoms to create piezoresistors on the front side (a). The wafer is then passivated with a thermally grown silicon dioxide thin film (b). In the ensuing step, the silicon dioxide film on the backside is patterned and selectively etched to expose the silicon (c). The exposed silicon material will be etched when the wafer is immersed in an anisotropic silicon etchant (d). In order to form the silicon diaphragm with desired thickness,

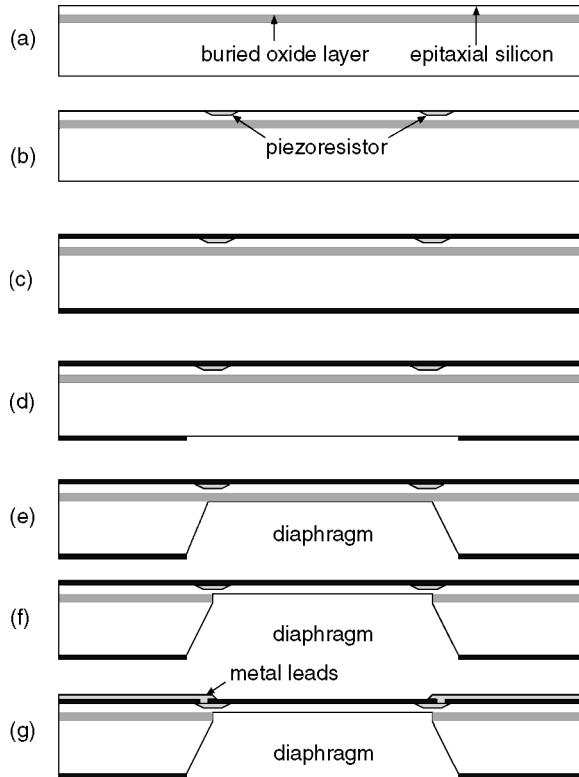

FIGURE 19.115 Schematic diagram of an alternative process for realizing bulk micromachined pressure sensors.

workers resort to timed etch with precise knowledge of calibrated wafer thickness and etch rates. However, this step must be performed with caution as the etch rate may vary with time and locations on a wafer. Typically, the resultant thickness of the diaphragm is large ($30\text{--}50\ \mu\text{m}$) to ensure sufficient yield of devices. In the final step, the oxide on the front side of the wafer is patterned to provide contact vias for metal lead wires (e).

To circumvent the problem of process uncertainty of the aforementioned process, wafers with barrier layers can be used (Fig. 19.115). For example, it is possible to use a silicon-on-insulator (SOI) wafer with a thin film of silicon on top of a silicon dioxide layer. The silicon and the oxide layers lie on top of the bulk silicon substrate (a). Following steps similar to the ones discussed above, one can form piezoresistors (b) and open windows in silicon oxide on the backside of the wafer (d). The anisotropic etchant of silicon has minimal etch rate on the silicon oxide, hence the through-wafer etch will automatically stop when the buried oxide layer is exposed. This allows a professional engineer to perform adequate overetch to ensure that diaphragms on all devices reach the same thickness (e). This self-limiting etching behavior reduces the complexity of process control and is conducive to reducing the process costs. The oxide layer is then selectively removed using hydrofluoric acid, which does not etch silicon. Hence a thin silicon diaphragm, with the thickness defined by the thickness of the epitaxial silicon layer specified during the SOI wafer manufacturing, can be formed efficiently. Finally, via holes are opened on the frontside and metal leads are deposited and patterned (g).

Although this process is advantageous over the one introduced earlier, it has a few shortcomings. For example, although the process discussed above is much more efficient in terms of controlling the diaphragm thickness, the SOI wafers used in the process are more expensive than ordinary silicon wafers. Even with SOI wafers, the thickness of the silicon diaphragm is typically $2\text{--}10\ \mu\text{m}$. In order to further

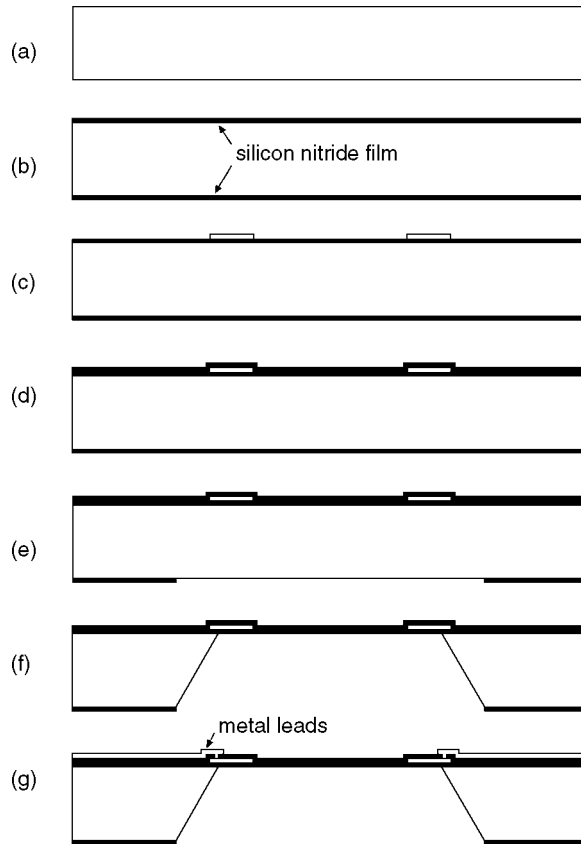

FIGURE 19.116 Schematic diagram of major process steps for realizing a bulk micromachined pressure sensor with a silicon nitride diaphragm.

increase the pressure sensitivity, it is advantageous to reduce the thickness of the diaphragm further. However, this would be difficult to achieve if silicon is the diaphragm material. In the following, a process of using silicon nitride thin film will be discussed.

An alternative sensor structure uses silicon nitride thin film as the diaphragm and deposited and doped polycrystalline silicon as the piezoresistive sensor. The process is described in Fig. 19.116. Starting with a bare silicon wafer (a), a layer of silicon nitride film is deposited using LPCVD methods (b). The wafer is then coated with a layer of polysilicon with suitable doping concentration (c). The polysilicon is patterned and defined. This is followed by the deposition of yet another thin film silicon nitride to protect the polysilicon film during the ensuing silicon etching (d). The thickness of the two LPCVD silicon nitride layers is the thickness of the finished diaphragm. A window is opened on the backside of the wafer to expose the silicon material. The silicon is etched in an anisotropic etchant, which does not attack the silicon nitride film. In other words, the selectivity between silicon and silicon nitride is high. Following the formation of the diaphragm, the silicon nitride on top of the polysilicon resistors is selectively patterned and metal leads are formed (g).

Surface Micromachined Pressure Sensors

The surface micromachining process does not require the removal of silicon substrate, which is time-consuming and not fully compatible with integrated circuit processes at the present because of the silicon etchants used. For producing low-cost, high-performance integrated sensors, surface micromachining

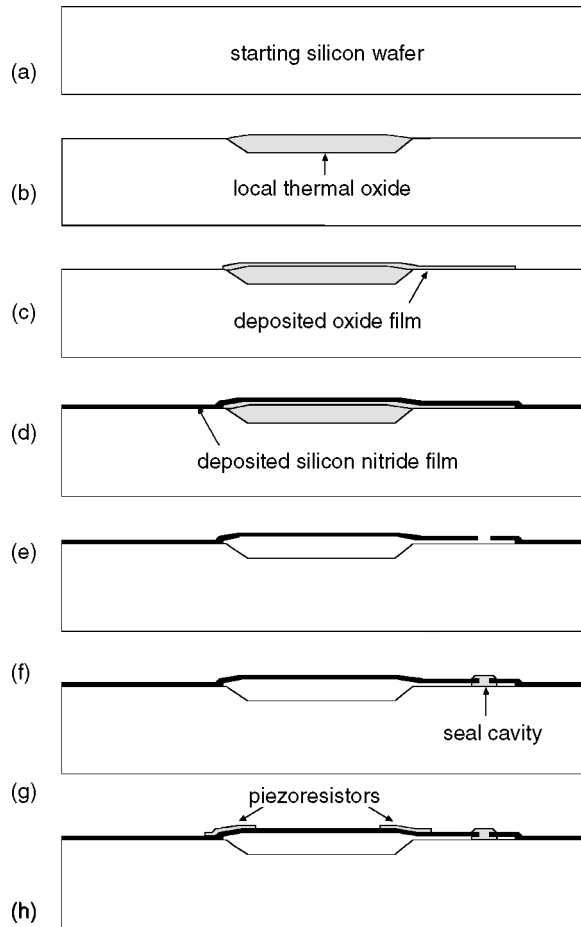

FIGURE 19.117 Schematic diagram of major steps for making a surface micromachined pressure sensor with silicon nitride diaphragm.

offers important advantages. An exemplary surface micromachining process is described in the following paragraph.

The fabrication process for a surface micromachined pressure sensor is shown in Fig. 19.117. It starts with a silicon substrate (a) with the front side polished. A local thermal oxidation process is performed first to form a silicon oxide well with a typical thickness of $1.3\ \mu\text{m}$. The thermal oxide is part of the sacrificial layer that will be removed at a later stage. Using a process called low-pressure chemical vapor deposition (LPCVD), a thin layer of oxide is again deposited over the wafer surface. This oxide layer is patterned using the photolithography method (c). The entire wafer is coated with a silicon nitride thin film deposited by LPCVD technique as well (d). The silicon nitride film is patterned and etched to produce an access hole on top of the underlying oxide layer (e). Through this access hole, hydrofluoric acid removes the oxide materials inside the cavity. The etch rate of the acid on silicon nitride is negligible (f). After the cavity is emptied and dried, another layer of LPCVD silicon nitride is deposited to seal the opening in the original silicon nitride layer (g). Following this step, polycrystalline silicon with suitable doping concentration is deposited on top of the wafer and patterned to form the piezoresistors (h).

It should be noted that piezoresistive sensing, though dominant in the methods reviewed, is not the only sensing mechanism available. Capacitive sensing and piezoelectric sensing are also feasible and have been demonstrated in the past. However, discussions of these methods are beyond the scope of this text.

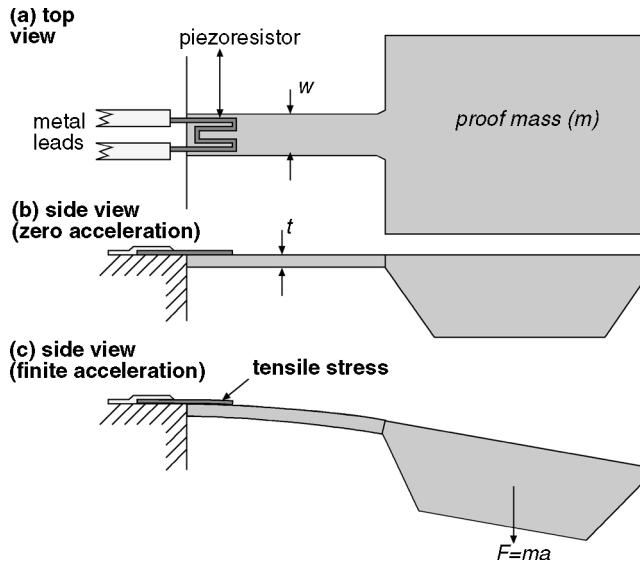

FIGURE 19.118 Schematic diagram of a bulk micromachined accelerometer.

Pressure Sensors Made of Non-Silicon Materials

For certain applications such as monitoring of internal combustion engine, pressure sensors are required to sustain high temperature of operation. In such cases, silicon is not the optimal material because high temperature causes doped silicon junctions to fail.

Work has also been done to implement polymer materials for pressure sensors. Though such devices are relatively few, they represent an important development trend for future sensors.

Accelerometers

Bulk Micromachined Accelerometers

Acceleration sensors (or so-called inertial measurement units, IMU) are important for monitoring acceleration and vibration experienced by a subject, such as an automobile, a machine, or a building. Low-cost accelerometers used in automobile airbag deployment systems can reduce the costs and enhance driver safety. Micromachined sensors can be made small and sufficiently low-cost to be used in smart projectiles, for example, concrete penetrating bombs. Small, multi-axial accelerometers can also be applied in writing instruments (smart pens) for handwriting recognition.

A representative bulk micromachined accelerometer is illustrated in Fig. 19.118. A SEM micrograph of a prototype sensor is shown in Fig. 19.119. A silicon proof mass is attached to the end of a cantilever beam. At the base of the cantilever beam lies a piezoresistive element. Supposing the mass of the proof mass is m , and the magnitude of the acceleration is a , one can estimate the sensor output following a few simple analysis steps. First, a concentrated force with a magnitude of $F = ma$ is applied in the center of the proof mass according to Newton's first law. Secondly, the force translates into a torque loading at the base of the cantilever with the magnitude being

$$M = F\left(l + \frac{L}{2}\right) = ma\left(l + \frac{L}{2}\right)$$

The magnitude of the strain experienced at the surface of the cantilever beam, where the piezoresistors are located, is

$$\varepsilon = \frac{Mt}{2EI}$$

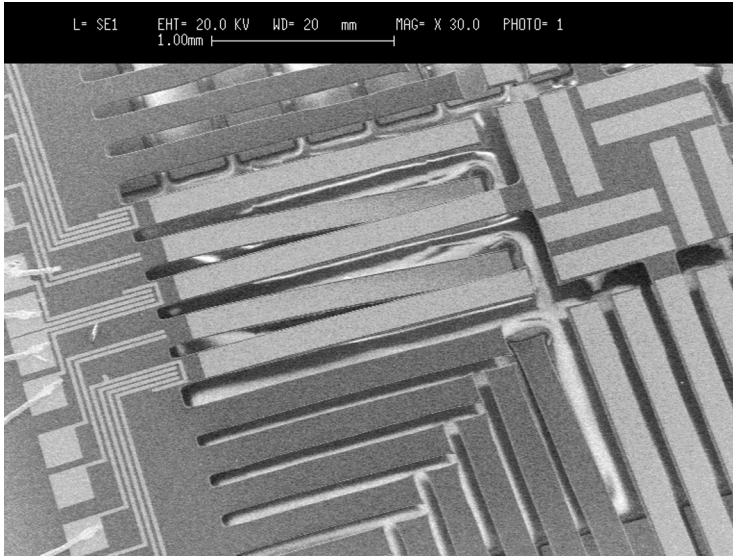

FIGURE 19.119 A SEM micrograph of a prototype bulk micromachined pressure sensor (Junjun Li).

Here, the term t is the thickness of the beam, E is the modulus of elasticity of the cantilever beam material, and I is the momentum of inertia associated with the beam cross section. Supposing the cross section of the cantilever beam is a rectangle with a width w and a thickness t , the moment of inertia is

$$I = \frac{wt^3}{12}$$

Note that the moment of inertia is strongly related to the thickness of the beam. If the thickness of beam is reduced to half, the magnitude of I is reduced by eight times, and the sensitivity of the sensor increases by eight fold.

Surface Micromachined Accelerometers

Surface micromachined accelerometers offer the potential advantage of ready integration with signal processing circuits. As a result, various types of surface micromachined versions have been made in the past decade. A successful commercial product has been made by analog devices for sensing automobile acceleration to deploy airbags in the events of collision. The structure, operational principle, and fabrication process for such a sensor is briefly discussed in this section.

The sensor consists of two sets of interdigitated comb-finger-shaped electrodes as shown in Fig. 19.120. One set of fingers is stationary and fixed to the substrate. Another set is suspended by cantilever springs to the substrate. Capacitors are formed between each pair of comb-like fingers. When an external acceleration is applied along the horizontal axis, an inertia force is applied to the moving set of fingers and causes the moving fingers to displace. The amount of displacement is related to the magnitude of the acceleration and the force constant of the supporting springs. The relative motion of the two sets of fingers result in changes of the overall capacitance value between the two sets of fingers. The minute capacitance change is sensed and processed by a signal-processing circuit consisting of an $\Sigma - \Delta$ A/D conversion stage [10].

The fabrication process for such a sensor according to the A-A cross-section is illustrated in Fig. 19.121. First, transistors for signal processing circuits are first made on a silicon substrate (a). A sacrificial silicon dioxide layer is deposited onto the wafer surface (b), followed by the deposition of a polycrystalline silicon

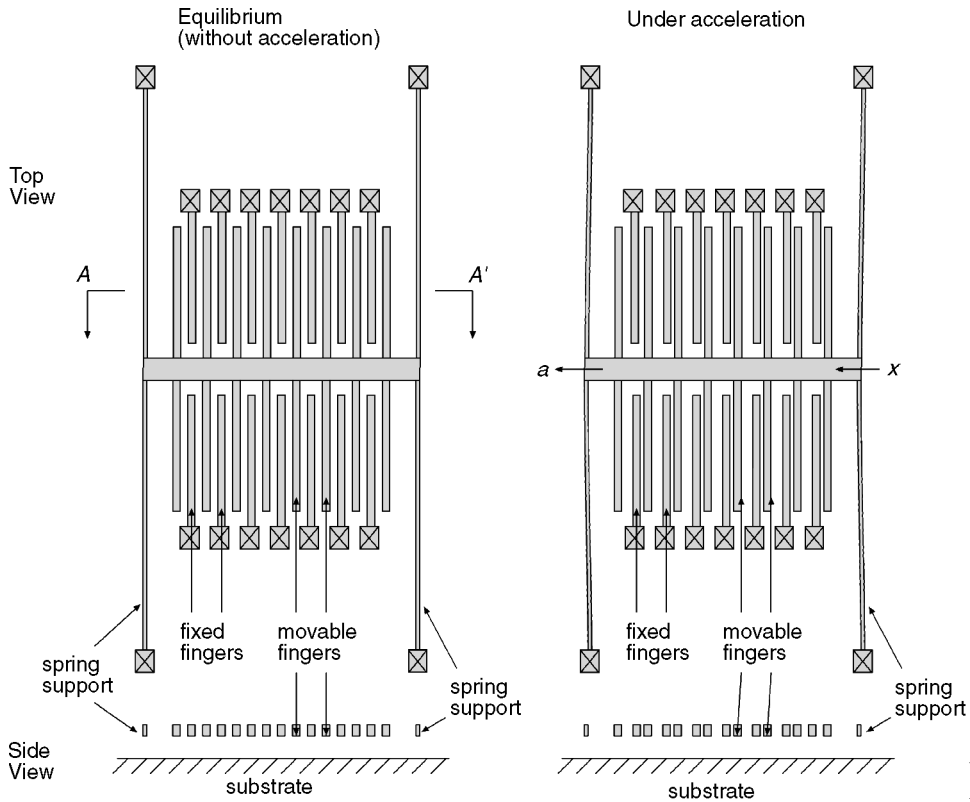

FIGURE 19.120 Schematic diagram illustrating the operation principle of a surface micromachined accelerometer.

layer (c). The polycrystalline silicon is patterned and etched to form the comb fingers (e). Subsequently, the oxide layer is removed by using a wet etchant (hydrofluoric acid) that etches polycrystalline with negligible rates. In areas where the polysilicon is anchored to the substrate, a via hole is patterned and etched in the sacrificial layer before step (c).

Tactile Sensors

Tactile sensors are most widely used for robotics applications to provide tactile sensations for object handling. The sensor density on a human fingertip is on the order of $100/\text{cm}^2$. Such a high sensor density can be achieved using microfabrication technology.

An arrayed tactile sensor is illustrated in Fig. 19.122. A two-dimensional array of individual sensor elements provides two-dimensional mapping of contact force and shear force. The schematic cross-sectional diagram of an array in contact with an arbitrary object is shown in Fig. 19.122(b). As an object contacts a sensor beam, the amount of displacement corresponds to the contact force as well as the surface topology.

The fabrication process of the tactile sensor is discussed in the following and illustrated in Fig. 19.123. Starting with a silicon wafer (a), a local ion implantation is first conducted to produce piezoresistors (b). A thermal oxide film is grown to provide passivation to the entire wafer. The oxide layer on the bottom of the wafer is patterned and etched to expose silicon substrates (c). An anisotropic silicon etch is performed to remove silicon from the backside of the wafer (d). The oxide film on the front of the wafer is then patterned and etched using plasma anisotropic etch to create free-standing cantilever beams (e and f). Metal thin film is then deposited and patterned to provide lead wires (g).

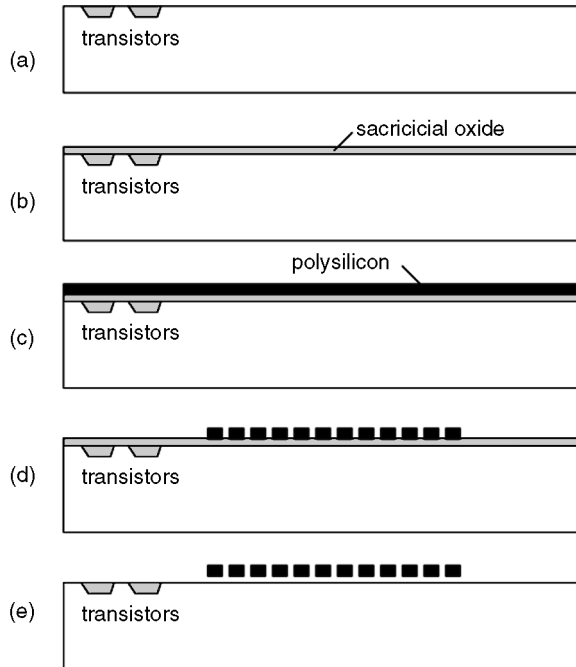

FIGURE 19.121 Schematic diagram of the fabrication process for a surface micromachined accelerometer illustrated in the previous figure.

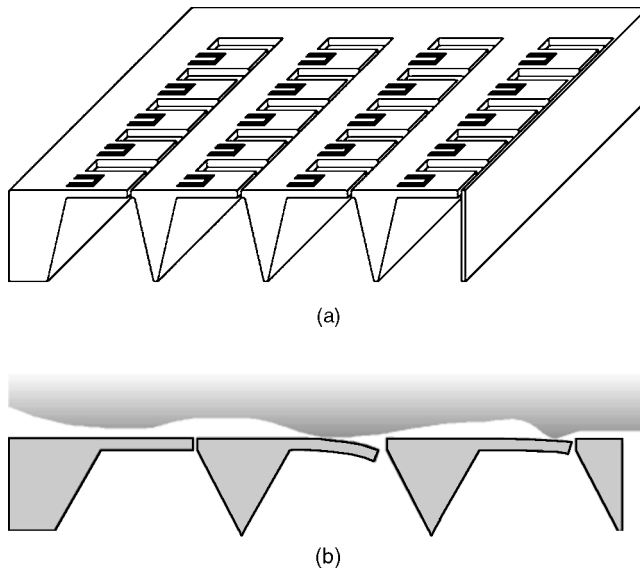

FIGURE 19.122 Schematic diagram of an array tactile sensor: (a) perspective view, (b) cross-sectional view.

Flow Sensors

Sensors for monitoring the flow rate of fluid (air or liquid) and for measuring the drag force exerted on an object moving in a fluid have important applications in robotics applications. Existing flow sensors are based on a number of principles, notably thermal and momentum transfer principles.

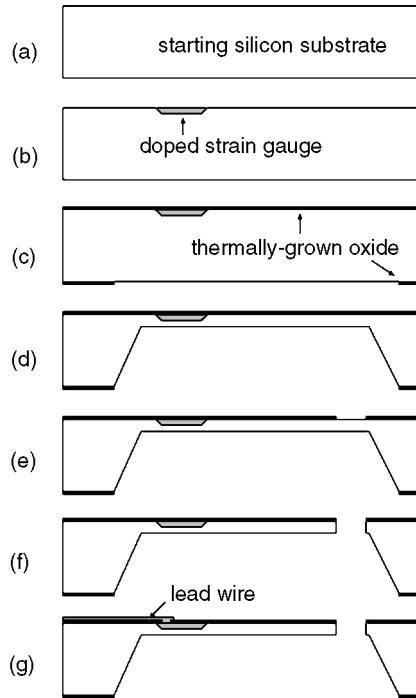

FIGURE 19.123 Schematic diagram of the microfabrication process for realizing a tactile sensor.

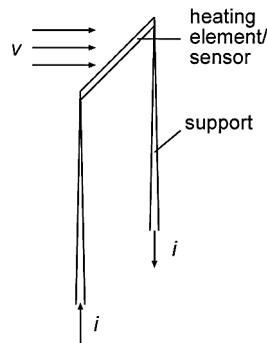

FIGURE 19.124 Perspective diagram of a thermal-transfer based flow sensor (anemometer).

Flow Sensors Based on Heat Transfer Principles

For sensors based on thermal transfer principles, a heated element is used with temperature slightly above the temperature of the ambient fluid (Fig. 19.124). The heat is generally created by passing current through a resistive element. An ideal element to serve as the heating element is doped polysilicon resistor. The resistivity is generally lower than what can be achieved using metal resistors of the same dimension, hence the resistance value is greater and the heating element can be made smaller.

The movement of the fluid creates velocity-dependant forced convection of heat, thereby reducing the temperature of the heated element accordingly. The temperature of the element is therefore used to provide information about the flow rate and direction. Such sensors are commonly referred to as hot-wire anemometers. Micromachined hot-wire anemometers have been demonstrated by several groups [11,12].

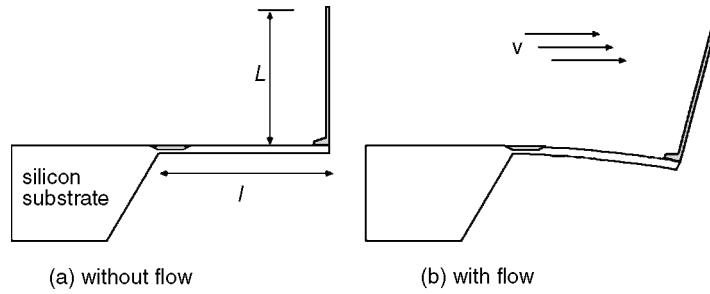

FIGURE 19.125 Schematic diagram illustrating the operation principle of a momentum-transfer based flow sensor.

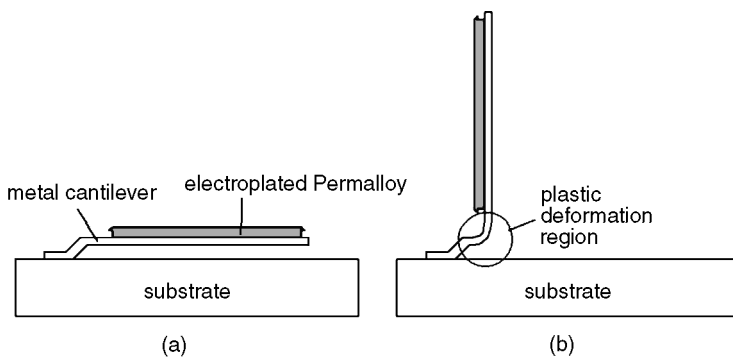

FIGURE 19.126 Schematic diagram of the plastic deformation magnetic assembly (PDMA) process.

Flow Sensors Based on Momentum Transfer Principles

For sensors based on momentum transfer principles, a mechanical member is bent by the momentum imparted by a moving fluid (Fig. 19.125). The amount of the bending is used to decipher the strength of the fluid flow. The schematic diagram of an exemplary flow sensor is shown in the figure below. It consists of a vertical shaft attached to the end of a cantilever beam (a). When an external flow is exerted, it will apply a distributed force onto the vertical shaft, hence causing the cantilever to bend. The extent of the bending, as sensed by the embedded piezoresistor, is proportional to the average flow rate.

The fabrication process is similar to the tactile sensor except for the attachment of the integrated vertical shaft. A number of techniques for assembling three-dimensional microstructures using efficient integrated processes have been developed in the past. For example, three-dimensional structures can be realized using hinged microstructures and using solder joints or polymer joints. Recently, a process called the plastic deformation magnetic assembly (PDMA) has been developed. In the following paragraph the PDMA process is briefly discussed.

The PDMA technique is discussed using a simple surface micromachined cantilever as an example. As shown in the diagram below (Figs. 19.126 and 19.127), a single-clamped cantilever made of a ductile metal (e.g., gold or aluminum) is suspended from the substrate. A piece of Permalloy, a ferromagnetic alloy made by electrodeposition, is attached to the cantilever. When a magnetic field is applied from underneath the wafer, the magnetic piece will be magnetized and will experience a magnetic torque M . The torque lifts the cantilever beam away from the substrate. If the amount of bending is significant, the ductile metal will be displaced permanently due to plastic deformation at the hinge region.

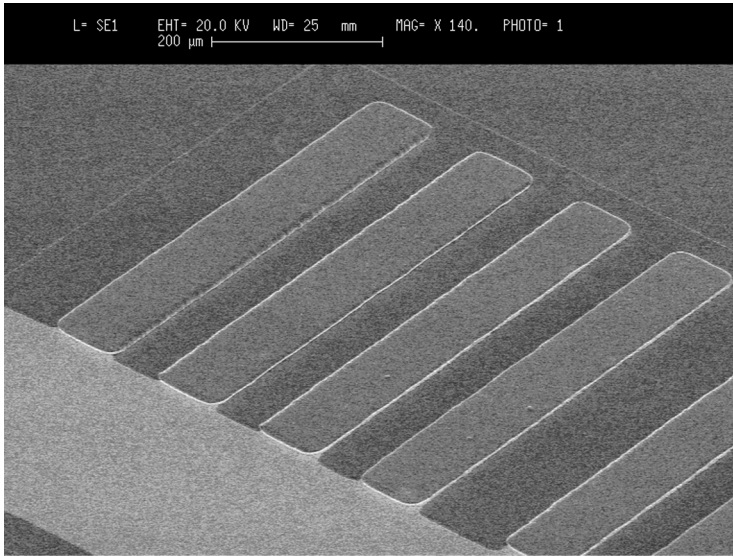

(a)

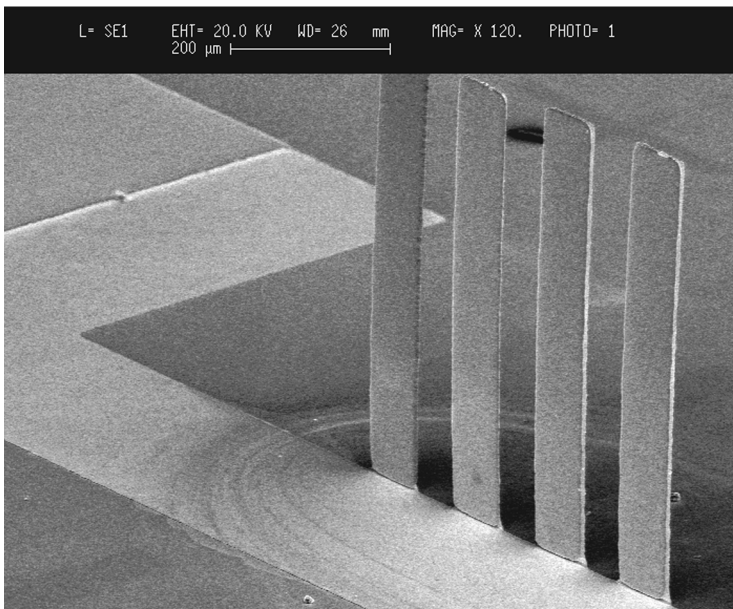

(b)

FIGURE 19.127 SEM micrographs of cantilever beams (a) while in plane, and (b) after PDMA assembly.

Future Development Trends

Miniaturization and integration of circuits has resulted in revolution in the society so far. It drastically reduces the costs and increased the performance of circuits. Without the integrated circuits technology, the information age would not have dawned on the human society.

It is conjectured that integrated microsensors are likely to produce as broad and deep an impact on the society as the integrated circuits. Sensors can be used for robotics sensing, smart buildings, smart

toys, automotive safety and control, and industrial control. However, in order to realize the advantages of integrated sensors, a number of technical barriers must be overcome. Two important barriers are (1) high R&D costs of integrated sensors and (2) reliable and robust packaging of sensors.

The development of microintegrated sensors involves high development costs and long time-to-market. The surface micromachined accelerometer developed by analog devices costs tens of millions of dollars and took more than 5 years to produce. Why do integrated sensors cost so much to build? Sensors are developed using a group-up approach. The development cycle of a sensor begins at the level of physical principles. The cost of sensor development includes expertise for material selection, design generation, prototype process development, and characterization.

Such a development cost and speed is not tolerable in applications where only a small amount of custom sensors is required. Standard sensing modules, low-cost, flexible foundry fabrication processes, and advanced computer simulation and prototyping tools are required to advance the state-of-the-art of microintegrated sensors.

Future sensors will involve more non-silicon materials. For example, polymer materials can be used to reduce the costs while high-temperature materials may be used for high-temperature sensing applications (e.g., monitoring of conditions in engines).

Conclusions

A brief historical overview of the development of microfabrication technology and microintegrated sensors is presented. Common sensing principles, including capacitive, piezoresistive, and piezoelectric sensing, are discussed. Four important case studies of sensors are undertaken. For each type of sensor applications—pressure sensors, acceleration sensors, tactile sensors, and flow sensors—the sensor architectures and fabrication processes are reviewed. Interested readers may find more in-depth information in the references provided in this section.

References

1. Nathanson, H.C., Newell, W.E., Wickstrom, R.A., and Davis J.R. Jr., "The resonant gate transistor," *IEEE Transactions on Electron Devices*, Vol. ED-14, No. 3, pp. 117–113, March 1967.
2. Petersen, K.E., "Silicon as a mechanical material," *Proceedings of the IEEE*, Vol. 70, No. 5, pp. 420–457, May 1982.
3. Angell, J.B., Terry, S.C., and Barth, P.W., "Silicon micromechanical devices," *Scientific American*, Vol., 248, pp. 44–55, April 1983.
4. Siewell, G.L., Boucher, W.R., and McClelland, P.H., "The ThinkJet orifice plate: a part with many functions," *Hewlett-Packard Journal*, May 1985, pp. 33–37.
5. Allen, R.R., Meyer, J.D., and Knight, W.R., "Thermodynamics and hydrodynamics of thermal ink jets," *Hewlett-Packard Journal*, May 1985, pp. 21–27.
6. Williams, K.R., and Muller, R.S., "Etch rates for micromachining processing," *Journal of Microelectromechanical Systems*, Vol. 5, No. 4, pp. 256–268, December 1996.
7. Kovacs, G.T.A., *Micromachined transducers sourcebook*, McGraw-Hill, 1998.
8. Trimmer, W.S., *Micromechanics and MEMS—Classics and seminal papers to 1990*, IEEE Press, 1997.
9. WWW site <http://mems.isi.edu>.
10. Yun, W., Howe, R.T., and Gray, P.R., "Surface micromachined, digitally force-balanced accelerometer with integrated CMOS detection circuitry," *Technical Digest, IEEE Solid-State Sensor and Actuator Workshop*, pp. 21–25, Hilton Head, SC, June 1992.
11. Jiang, F., Tai, Y.C., Ho, C.M., Karan, R., and Garstener, M., "Theoretical and experimental studies of micromachined hot-wire anemometers," *Technical Digest, International Electron Devices Meeting 1994*, San Francisco, CA, pp. 139–142, December 1994.
12. Ebefors, T., Kalvesten, E., and Stemme, G., "Three dimensional silicon triple-hot-wire anemometer based on polyimide joints," *Proceedings of the 11th International Workshop on MEMS*, pp. 93–98, January 1998.

20

Actuators

George T.-C. Chiu

Purdue University

C. J. Fraser

University of Abertay Dundee

Ramutis Bansevicius

Kaunas University of Technology

Rymantas Tadas Tolocka

Kaunas University of Technology

Massimo Sorli

Politecnico di Torino

Stefano Pastorelli

Politecnico di Torino

Sergey Edward Lyshevski

Purdue University Indianapolis

- 20.1 Electromechanical Actuators
Introduction • Type of Electromechanical Actuators—Operating Principles • Power Amplification and Modulation—Switching Power Electronics
- 20.2 Electrical Machines
The dc Motor • Armature Electromotive Force (emf) • Armature Torque • Terminal Voltage • Methods of Connection • Starting dc Motors • Speed Control of dc Motors • Efficiency of dc Machines • AC Machines • Motor Selection
- 20.3 Piezoelectric Actuators
Piezoeffect Phenomenon • Constitutive Equations • Piezomaterials • Piezoactuating Elements • Application Areas • Piezomotors (Ultrasonic Motors) • Piezoactuators with Several Degrees of Freedom
- 20.4 Hydraulic and Pneumatic Actuation Systems
Introduction • Fluid Actuation Systems • Hydraulic Actuation Systems • Modeling of a Hydraulic Servosystem for Position Control • Pneumatic Actuation Systems • Modeling a Pneumatic Servosystem
- 20.5 MEMS: Microtransducers Analysis, Design, and Fabrication
Introduction • Design and Fabrication • Analysis of Translational Microtransducers • Single-Phase Reluctance Micromotors: Microfabrication, Modeling, and Analysis • Three-Phase Synchronous Reluctance Micromotors: Modeling and Analysis • Microfabrication Aspects • Magnetization Dynamics of Thin Films • Microstructures and Microtransducers with Permanent Magnets: Micromirror Actuator • Micromachined Polycrystalline Silicon Carbide Micromotors • Axial Electromagnetic Micromotors • Conclusions

20.1 Electromechanical Actuators

George T.-C. Chiu

Introduction

As summarized in the previous sections, a mechatronics system can be partitioned into function blocks illustrated in Fig. 20.1. In this chapter, we will focus on the actuator portion of the system. Specifically, we will present a general discussion of the types of electromechanical actuators and their interaction

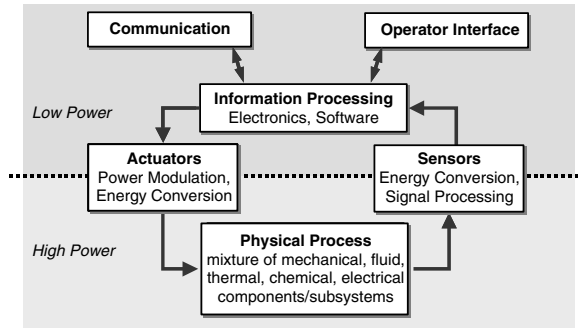

FIGURE 20.1 Mechatronic system.

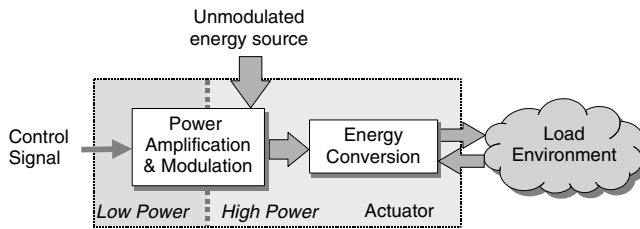

FIGURE 20.2 Actuator functional diagram.

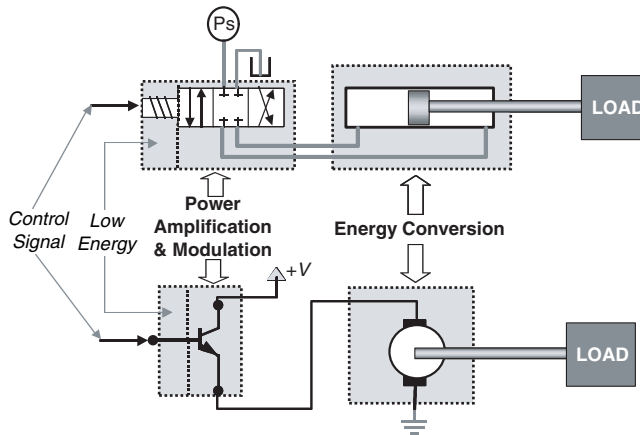

FIGURE 20.3 Electrohydraulic and electromechanical actuators.

with the load or physical environment. In addition, we will look at the electronic components that are essential for modulating the necessary electrical energy.

From an energy perspective, a mechatronic system can be separated into a relatively higher energy (power) portion that interacts with the physical world and a relatively low energy (power) portion that process the data, see Fig. 20.1. Sensor and actuators are the interfacing devices that accomplish the tasks of energy modulation and energy conversion. Therefore, an actuator can be viewed as having the structure depicted in Fig. 20.2. Typically, actuators are considered only as energy conversion devices. However, with the proliferation of power electronics, we will take a more inclusive view of actuators that also includes power amplification. An electrohydraulic linear actuator, see Fig. 20.3, can also be similarly classified, where the spool valve is the power amplification/modulation block with spool position as the

control signal and the hydraulic pressure/flow is the energy source. The hydraulic cylinder acts as the energy conversion device that converts fluidic energy to mechanical energy. For a typical electromechanical actuator, such as a DC motor (Fig. 20.3), the power amplification block is the motor driver that amplifies signal level (low current/power) control signal to the higher power (large current) signal that is used to convert electrical energy to mechanical energy through the electromagnetic principle.

In this chapter, we will first present an overview of common types of electromechanical actuators. They will be classified by the respective energy conversion mechanism. The power electronic components, such as diodes, thyristors, and transistors, which are used for power amplification and modulation, will be presented followed by discussion of common power amplification building blocks. We will conclude by discussing some issues related to interfacing with electromechanical actuators.

Type of Electromechanical Actuators—Operating Principles

Converting electrical energy to mechanical energy is the common thread among different electromechanical actuators. Physics provided us with many different mechanisms either through direct conversion such as piezoelectric or through an intermediate medium such as a magnetic field. We will present an overview of the more common electromechanical actuators by their energy conversion mechanism: electromagnetic, electrostatic, and piezoelectric. The following discussion is intended to provide introductory information about the types of electromechanical actuation and is by no means exhaustive. Detailed discussion of each can be found in subsequent chapters, where they will be discussed in more detail.

Electromagnetics—Magnetic Field

Electromagnetic is the most widely utilized method of energy conversion for electromechanical actuators. One of the reasons for using magnetic fields instead of electric fields is the higher energy density in magnetic fields. The air gap that separates a stationary member (stator) and a moving member of an electromechanical actuator is where the electromechanical energy conversion takes place. The amount of energy per unit volume of air gap for magnetic fields can be five orders of magnitude higher than that of electric fields.

Lorentz's law of electromagnetic forces and Faraday's law of electromagnetic induction are the two fundamental principles that govern electromagnetic actuators. Before going into the detail of electromagnetics, we will first introduce the concept of magnetic field and flux.

Magnetic flux ϕ exists due to the presence of a magnetic field. The magnetic field strength \vec{H} (in A/m) and the magnetic flux density \vec{B} (in tesla [T]) are related by the permeability of the material. In a vacuum, the magnetic flux density is directly proportional to the magnetic field strength and is expressed by

$$\vec{B} = \mu_0 \cdot \vec{H} \quad (20.1)$$

where $\mu_0 = 4\pi \times 10^{-7} \text{ T m/A}$ is the *permeability constant*. For other magnetic or ferromagnetic materials the relationship is given by

$$\vec{B} = \mu_r(\vec{H}) \cdot \mu_0 \cdot \vec{H} \quad (20.2)$$

where $\mu_r(\vec{H})$ is the *relative permeability* of the material. Figure 20.4 shows typical B - H and μ - H curves.

Lorentz's Law of Electromagnetic Force

When a current carrying conductor is placed in a magnetic field, it will be subjected to an induced force given by

$$\vec{F} = \vec{i} \times \vec{B} \quad (20.3)$$

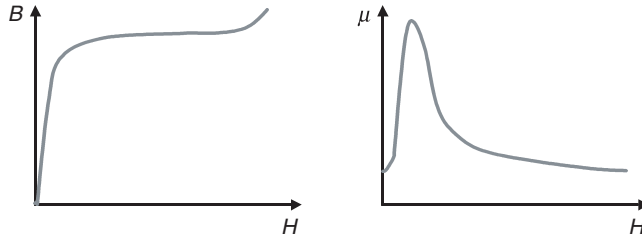

FIGURE 20.4 μ - H diagram and B - H diagram.

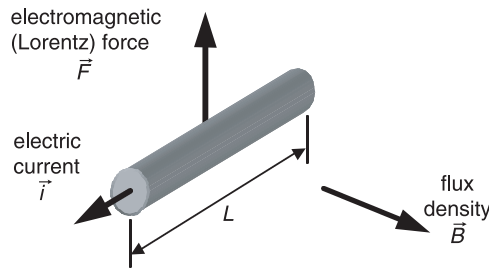

FIGURE 20.5 Lorentz's electromagnetic force.

where \vec{F} is the force vector, \vec{i} is the current vector, and \vec{B} is the magnetic flux density. The force is called the *electromagnetic force* or the Lorentz force. If a conductor of length L carrying constant current i is placed in a constant (independent of location) field B , as shown in Fig. 20.5, the magnitude of the resultant Lorentz force \vec{F} exerted by the field B on the conductor is

$$F = |\vec{F}| = BLi \quad (20.4)$$

Faraday's Law of Electromagnetic Induction

The motion of a conductor in a magnetic field will produce an electromotive force (emf), or electric potential, across the conductor given by

$$\text{emf} = E = -\frac{d\phi}{dt} \quad (20.5)$$

where $\phi = \oint \vec{B} \cdot d\vec{A}$ is the magnetic flux. For a conductor of length L moving at a constant speed v in a constant (independent of location) magnetic field that is perpendicular to the area A , as shown in Fig. 20.6, the magnitude of the induced electromotive force (electric potential) is

$$\text{emf} = E = BLv \quad (20.6)$$

There are two methods to generate a desired magnetic field \vec{H} , or equivalently, a desired magnetic flux density \vec{B} . One is to use a permanent magnet and the other is to utilize the Biot-Savart law.

Biot-Savart Law

A long (infinite), straight, current carrying conductor induces a magnetic field around the conductor, see Fig. 20.7. The flux density at a perpendicular distance r from the conductor is

$$B = \frac{\mu_r \mu_0}{2\pi r} \cdot i \quad (20.7)$$

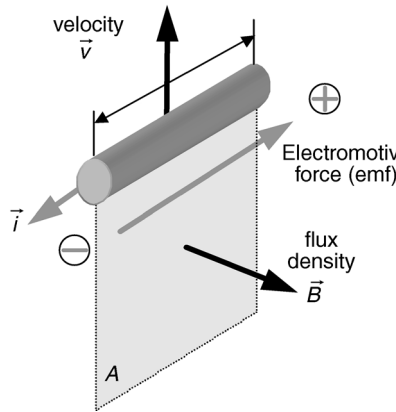

FIGURE 20.6 Motion induced electromotive force.

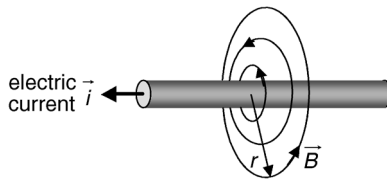

FIGURE 20.7 Magnetic field generated by current carrying conductor.

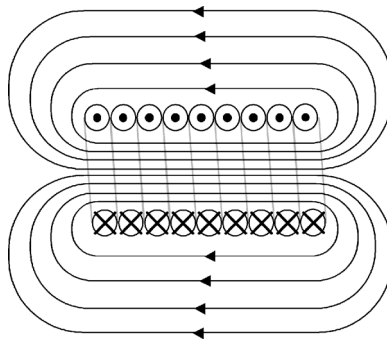

FIGURE 20.8 Coil (solenoid) induced magnetic field.

where i is the electric current. If we bend the straight current carrying conductor into a helical coil (solenoid) with N turns, it will induce a corresponding magnetic field as depicted in Fig. 20.8. If the length of the coil L is much greater than its diameter D , the flux density follows the right-hand rule and the magnitude inside the coil is approximately

$$B = \mu \frac{N}{L} \cdot i \quad (20.8)$$

where $\mu = \mu_r \cdot \mu_0$ is the permeability of the material inside the coil and i is the current through the winding. This field can be intensified by inserting a ferromagnetic core into the solenoid by increasing the permeability. Coil induced magnetic fields is widely utilized in electromagnetic devices for generating controlled magnetic fields and are often referred to as *electromagnets*.



FIGURE 20.9 Assorts of solenoid actuators. (Courtesy of Shih Hsing Industrial Co., Ltd.)

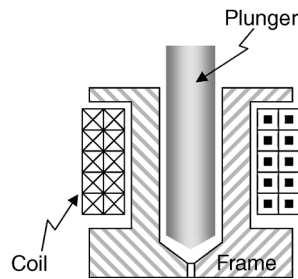

FIGURE 20.10 A typical solenoid.

Solenoid Type Devices

Solenoids, see Fig. 20.9, is the simplest electromagnetic actuators that are used in linear as well as rotary actuations for valves, switches, and relays. As the name indicates, a solenoid consists of a stationary iron frame (stator), a coil (solenoid), and a ferromagnetic plunger (armature) in the center of the coil, see Fig. 20.10.

As the coil is energized, a magnetic field is induced inside the coil. The movable plunger moves to increase the flux linkage by closing the air gap between the plunger and the stationary frame. The magnetic force generated is approximately proportional to the square of the applied current i and is inverse proportional to the square of the air gap δ , which is the stroke of the solenoid, i.e.,

$$F \propto \frac{i^2}{\delta^2} \quad (20.9)$$

As shown in Fig. 20.11, for strokes less than 0.060 in., the flat face plunger is recommended with a pull or push force three to five times greater than 60° plungers. For longer strokes up to 0.750 in., the 60° plunger offers the greatest advantage over the flat face plunger. When the coil is de-energized, the field decreases and the plunger will return to the original location either by the load itself or through a return spring.

All linear solenoids basically pull the plunger into the coil when energized. Push-type solenoids are implemented by extending the plunger through a hole in the back-stop, see Fig. 20.12. Therefore, when energized, the plunger is still pulled into the coil, but the extended producing a pushing motion from the back end of the solenoid. Return motion, upon de-energizing the coil, is provided by the load itself (i.e., the weight of the load) and/or by a return spring, which can be provided as an integral part of the solenoid assembly.

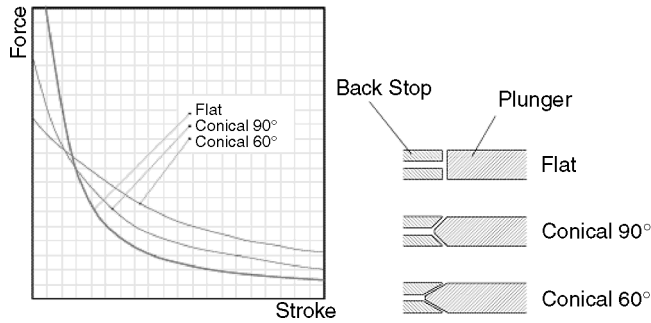

FIGURE 20.11 Typical force-stroke curve of solenoids. (Courtesy of Magnetic Sensor Systems.)

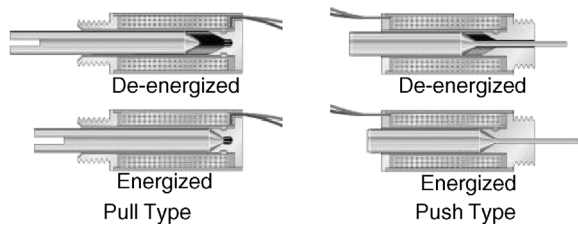

FIGURE 20.12 Push and pull type solenoids. (Courtesy of Ledex® & Dormeyer® Products.)

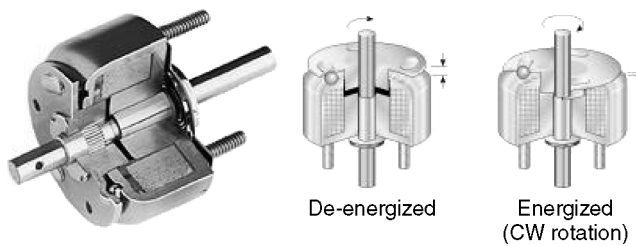

FIGURE 20.13 Rotary solenoid. (Courtesy of Ledex® & Dormeyer® Products.)

Rotary solenoids utilize ball bearings that travel down inclined raceways to convert linear motion to rotary motion. When the coil is energized, the plunger assembly is pulled towards the stator and rotated through an arc determined by the coining of the raceways, see Fig. 20.13. An *electromechanical relay (EMR)* is a device that utilizes a solenoid to close or open a mechanical contact (switch) between high power electrical leads. A relay performs the same function as a power transistor in that relatively small electrical energy is used to switch a large amount of currents. The difference is that a relay has the capability of controlling much larger current level. Variations on this mechanism are possible: some relays have multiple contacts, some are encapsulated, some have built-in circuits that delay contact closure after actuation, and some, as in early telephone circuits, advance through a series of positions step by step, as they are energized and de-energized.

Design/Selection Considerations. Force, stroke, temperature, and duty cycle are the four major design/selection considerations for solenoids. A linear solenoid can provide up to 30 lb of force from a unit less than 2¼ in. long. A rotary solenoid can provide well over 100 lb of torque from a unit also less than 2¼ in. long. As shown in Fig. 20.11, the relationship between force and stroke can be modified by changing the design of some internal components. Higher performance, e.g., force output, can be

TABLE 20.1 Temperature Rating For Electrical Insulations

| Insulation Classification | | Temperature Rating | |
|---------------------------|-----------|--------------------|-------|
| Class A | Class 105 | 105°C | 221°F |
| Class E | Class 120 | 120°C | 248°F |
| Class B | Class 130 | 130°C | 266°F |
| Class F | Class 155 | 155°C | 311°F |
| Class H | Class 180 | 180°C | 356°F |
| Class N | Class 200 | 200°C | 392°F |

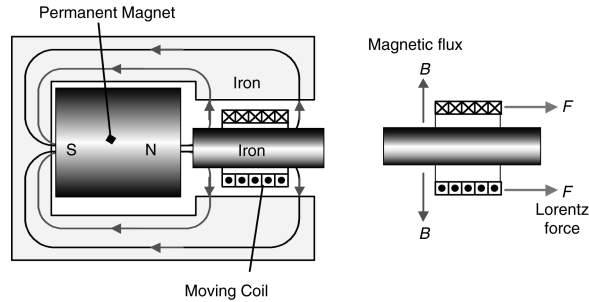

FIGURE 20.14 Voice-coil motor.

achieved by increasing the current to the coil winding. However, higher current tends to increase the winding temperature. As the winding temperature increases, the wire resistance increases. This will reduce the output force level. Solenoids are often rated as operating under continuous duty cycle or intermittent duty cycle. A solenoid rated for 100% duty cycle may be energized at its rated voltage continuously because its total coil temperature will not exceed maximum allowable ratings, while an intermittent duty cycle solenoid has an associated allowable “on” time which must not be exceeded. Intermittent duty coils provide considerably higher forces than continuous duty solenoids. The maximum operating temperature for a solenoid is determined by the rated temperature of the insulation material used in the winding (see Table 20.1).

Voice-Coil Motors (VCMs)

As the name indicates, the voice-coil motor was originally developed for loudspeakers. It is now extensively used in moving read/write heads in hard disk drives. Since the coil is in motion, VCM is also referred to as a *moving-coil* actuator. The VCM consists of a moving coil (armature) in a gap and a permanent magnet (stator) that provides the magnetic field in the gap, see Fig. 20.14. When current flows through the coil, based on the Lorentz law, the coil experiences electromagnetic (Lorentz) force F

$$\vec{F} = \vec{i} \times \vec{B}$$

Since most voice-coils are designed so that the flux is perpendicular to the current direction, the resultant Lorentz force can be written as

$$F_{\text{VCM}} = \gamma B N l \cdot i = K_F \cdot i \Rightarrow F_{\text{VCM}} \propto i \quad (20.10)$$

where l is the coil length per turn, B is the flux density, N is the number of turns in the coil, i is the current, and γ is a coil utilization factor. It is important to know that the force is proportional to the applied current amplitude and the proportional constant K_F is often called the *force constant*.

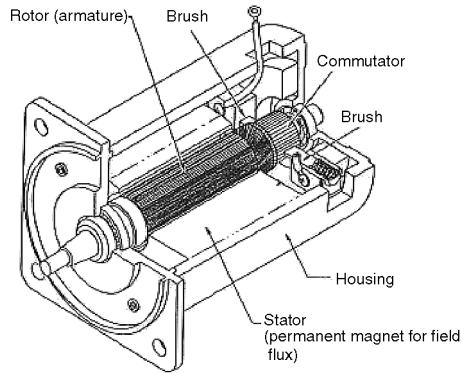

FIGURE 20.15 Permanent magnet DC motor. (T. Keujo and S. Nagamori, *Permanent-Magnet and Brushless DC Motors*, 1985, by permission of Oxford University Press.)

The coil is usually suspended in the gap by springs and attached to the load such as the diaphragm of an audio speaker, the spool of a hydraulic valve, or the read/write head of the disk drive. The linear relationship between the output force and the applied current and the bidirectional capability makes the voice coil more attractive than solenoids. However, since the controlled output of the voice coil is force, some type of closed loop control or some type of spring suspension is needed.

Design/Selection Consideration. From Eq. (20.10) we see that the force constant depends on the flux density and the amount of wires that can be packed into the gap. There are two options to increase the force constant. One is to increase the flux density, which can be achieved by using stronger magnetic material and the other is to increase either N or l , i.e., to pack more turns and/or make a larger diameter coil.

Given a fixed gap volume, using higher gauge (thinner) wires is the only way to increase the number of turns. However, higher gauge wires have larger resistance, which will increase the resistive heating of the winding and limit the allowable current. In addition, the additional insulation will also occupy more volume and tends to reduce the effect of increasing N . In summary, to improve the performance of the voice coil, a designer can either choose a better magnetic material or to make the motor bigger by either making the coil wider (increase D) or longer (increase N).

Electric Motors

Electric motors are the most widely used electromechanical actuators. They can either be classified based on functionality or electromagnetic characteristics. The differences in electric motors are mainly in the rotor design and the method of generating the magnetic field. Figure 20.17 shows the composition of a permanent magnet DC motor. Some common terminologies for electric motors are:

Stator is the stationary outer or inner housing of the motor that supports the material that generates the appropriate stator magnetic field. It can be made of permanent magnet or coil windings.

Field coil (system) is the portion of the stator that is responsible for generating the stator (field) magnetic flux.

Rotor is the rotating part of the motor. Depending on the construction, it can be a permanent magnet or a ferromagnetic core with coil windings (armature) to provide the appropriate armature field to interact with the stator field to create the torque.

Armature is the rotor winding that carries current and induces a rotor magnetic field.

Air gap is the small gap between the rotor and the stator, where the two magnetic fields interact and generate the output torque.

Brush is the part of a DC motor through which the current is supplied to the armature (rotor). For synchronous AC motors, this is done by *slip rings*.

Commutator is the part of the DC motor rotor that is in contact with the brushes and is used for controlling the armature current direction. Commutation can be interpreted as the method to control the current directions in the stator and/or the armature coils so that a desired relative stator and rotor magnetic flux direction is maintained. For AC motors, commutation is done by the AC applied current as well as the design of the winding geometry. For stepping motors and brushless DC (BLDC) motors, commutations are done in the drive electronics and/or motor commands.

Torque generation in an electric motor is either through the interaction of the armature current and the stator magnetic field (Lorentz Law) or through the interaction of the stator field and the armature field. [Table 20.2](#) summarizes the common classification of electric motors. The next chapter will give a detailed discussion of the operation of various electric motors and the associated design considerations.

TABLE 20.2 Electric Motor Classification

| Classification | | | Description | |
|---------------------|---------------------|--|---|---|
| Command Input | Magnetic Field | | | |
| DC motors | Permanent magnet | | Permanent magnets are used to generate the stator magnetic field. Electrical current is supplied directly into the armature winding of the rotor through the brushes and commutators. | |
| | | Electro-magnets | Shunt wound | A stator (field) winding is used as electromagnet. Stator winding is connected in parallel with the armature winding. |
| | | | Series wound | A stator (field) winding is used as electromagnet. Stator winding is connected in series with the armature winding. |
| | | | Compound wound | Two stator (field) windings are used as electromagnet. The stator windings are connected, one in series and one in parallel, with the armature winding. |
| | Separate wound | A stator (field) winding is used as electromagnet. Both the stator and armature fields are individually energized. | | |
| AC motors | Single-phase | Induction | Single stator winding with squirrel-cage rotor. No external connection to the rotor. Torque generation is based on the electromagnetic induction between the stator and rotor. AC current provides the commutation of the fields. Rotor speed is slightly slower than the rotating stator field (slip). | |
| | | Synchronous | Permanent magnet rotor or rotor winding with slip ring commutation. Rotating speed is synchronized with the frequency of the AC source. | |
| | Poly-phase | Induction | Similar to single-phase induction motor but with multiple stator windings. Self-starting. | |
| | | Synchronous | Similar to single-phase synchronous motor but with multiple stator windings for smoother operation. | |
| | Universal | Essentially a single-phase AC induction motor with similar electrical connection as a <i>series wound</i> DC motor. Can be driven by either AC or DC source. | | |
| Stepper Motors | Permanent magnet | | Permanent magnet rotor with stator windings to provide matching magnetic field. By applying different sequence (polarity) of coil current, the rotor PM field will align to match induced stator field. | |
| | Variable reluctance | | Teethed ferromagnetic rotor with stator windings. Rotor motion is the result of the minimization of the magnetic reluctance between the rotor and stator poles. | |
| | Hybrid | | Multi-toothed rotor with stator winding. The rotor consists of two identical teethed ferromagnetic armatures sandwiching a permanent magnetic. | |
| Brushless DC motors | Poly-phase | Synchronous | Essentially a poly-phased AC synchronous motor but using electronic commutation to match rotor and stator magnetic fields. Electronic commutation enables using a DC source to drive the synchronous motor. | |

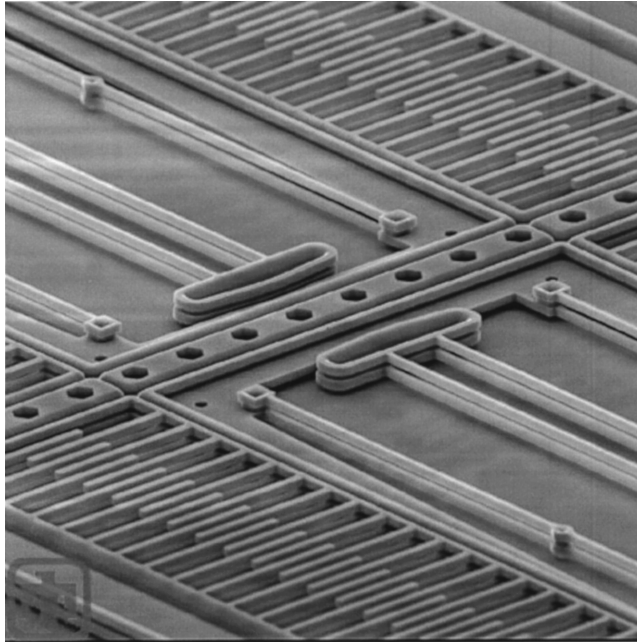

FIGURE 20.16 MEMS comb actuator uses electrostatic actuation. (Courtesy of Sandia National Laboratories, MEMS and Novel Si Science and Technology Department, SUMMIT Technologies, www.mems.sandia.com.)

Electrostatics—Electrical Field

Since electrical fields have lower energy density than magnetic fields, typical applications of electrical field forces are limited to measurement devices and accelerating charge particles, where the required energy density is small. Recently, with the proliferation of microfabrication technology, it is possible to apply the small electrostatic forces to microelectromechanical actuators, such as comb actuators (see Fig. 20.16). The advantage of electrostatic actuation is the higher switching rate and less energy loss as compared to the electromagnetic actuation. However, the limitation in force, travel, and high operating voltage still needs to be addressed. Electrostatic actuation is the main actuation for moving charged toner particles in electrophotographic (xerographic) processes, e.g., laser printers.

Piezoelectric

Piezoelectric is the property of certain crystals that produces a voltage when subjected to mechanical deformation, or undergoes mechanical deformation when subjected to a voltage. When a piezoelectric material is under mechanical stress, it produces an asymmetric displacement in the crystal structure and in the charge center of the affected crystal ions. The result is charge separation. An electric potential proportional to the mechanical strain can be measured. This is called the *direct piezoelectric effect*. Conversely, the material will have deformation without volume change when electric potential is applied. This *reciprocal piezoelectric effect* can be used to produce mechanical actuation. There are two categories of piezoelectric materials: sintered ceramics, such as lead-zirconate-titanate (PZT), and polymers, such as polyvinylidene fluoride (PVDF). Piezoceramics have a larger force output and are used more as actuators. PVDFs tend to generate larger deformation and are used more for sensor applications.

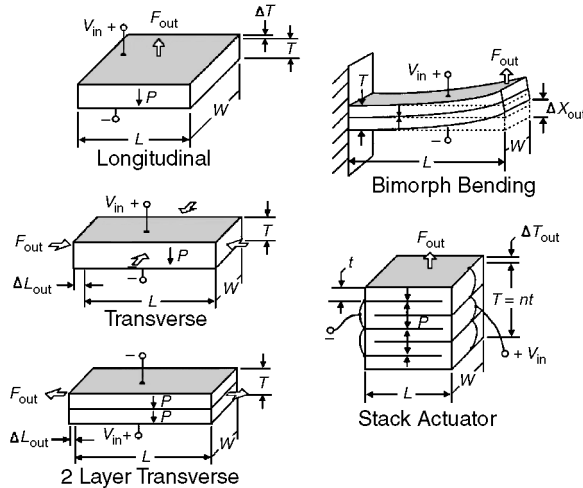

FIGURE 20.17 Common piezoelectric actuation geometries. (Courtesy of Piezo Systems, Inc.)

The coupling between the electrical and mechanical property of the material can be modeled by the following sets of linear constitutive equations:

$$\begin{cases} S = s^E \cdot T + d \cdot E \\ D = d \cdot T + \epsilon^T \cdot E \end{cases} \Leftrightarrow \begin{cases} E = -g \cdot T + (\epsilon^T)^{-1} \cdot D \\ S = s^D \cdot T + g \cdot D \end{cases} \quad (20.11)$$

where

- E = electric field strength [V/m]
- D = charge-density (dielectric) displacement [C/m^2]
- T = stress [N/m^2]
- S = strain
- s = compliance
- ϵ = permittivity [F/m]
- d, g = piezoelectric coupling coefficients

Design/Selection Considerations

Figure 20.17 shows the common orientation for piezoelectric actuation. With a typical strain of less than 0.3%, the amount of deflection or deformation is usually the limited factor for piezoelectric actuators. The most common architectures are the stacked and bending actuation. Piezoelectric actuators are most suited for high bandwidth, large force, and small stroke/deflection applications. They are widely used in noise and acoustical applications, as well as optical applications, where precision motion is critical.

Piezoelectric actuators are usually specified in terms of their free deflection and blocked force. Free deflection (X_f) refers to displacement attained at the maximum recommended voltage level when the actuator is completely free to move and is not asked to exert any force. Blocked force (F_b), refers to the force exerted at the maximum recommended voltage level when the actuator is totally blocked and not allowed to move. Figure 20.18 shows the static performance curve of a typical piezoelectric actuator (force vs. deflection). Generally, a piezo actuator must deform a specified amount and exert a specified force, which determines its operating point on the force vs. deflection line. An actuator is considered optimized for a particular

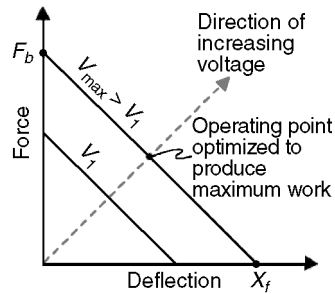

FIGURE 20.18 Static performance curve of a typical piezoelectric actuator. (Courtesy of Piezo Systems, Inc.)

application if it delivers the required force at one half its free deflection. High operating voltage, hysteresis, creep, and fatigue are the main mechanical design considerations.

Efficiency

Efficiency is one of the major considerations for any energy conversion process. In most cases, the wasted energy is converted to heat and increases the device temperature. For electromechanical actuators, heat (temperature) is one of the most prominent performance-limiting factor as well as failure mode. As device temperature increases, the underlying conversion efficiency will suffer and dump more energy into heat, which further increases the device temperature. This is often referred to as *thermal runaway*. Therefore, it is very important when designing electromechanical actuators to prevent thermal runaway and guarantee that under normal operating condition the actuator system achieves thermal equilibrium. The equilibrium temperature should be maintained below the lowest rated temperature of the components, such as the electrical insulation for the windings. The temperature rating for electrical insulations are listed in [Table 20.1](#).

Power Amplification and Modulation—Switching Power Electronics

As described in the previous section and depicted in [Fig. 20.2](#), there are two main functions in an extended definition of an actuator for mechatronics systems. We have introduced a few energy conversion mechanisms and the associated actuators. In the second part of this chapter, we will focus on the power amplification and modulation portion of the actuator. This part of the actuator is traditionally called the *power amplifier* or the *driver* for the corresponding actuator. However, as miniaturization and system integration become more pervasive, power electronics are being embedded into either the controller (information processing unit) or the actuator. It is also the portion where intelligence and additional functionality/feature can be incorporated. For electromechanical actuators, the unmodulated energy source is electricity. The power amplifier acts as a buffer between the low energy part of the system, where actuation command is given in low energy electrical signals, and the high energy density electrical signal that will be converted.

Power amplification can roughly be categorized into two methods, linear and switching. The main advantage of linear power amplification is the “cleanness” of the signal as compared to the switching amplifiers. The main drawback is in efficiency, where linear amplifiers tend to run hotter than similar sized switching amplifiers. However, as with any engineering design, this is only a rule-of-thumb; the designer needs to analyze the application and select or design the appropriate driver.

Switching amplifiers are made of semiconductor components such as diodes and transistors. These semiconductor devices either function as a switching element that controls the current flow to the energy conversion element such as a winding coil, or as an amplification element that modulates the amount of current flowing into the winding coil. Another advantage of using switching type power amplifiers is that, with switching, the amplifier stage can be directly controlled by a digital signal from an information processing device (see [Fig. 20.1](#)) such as a microcontroller or a microprocessor. This eliminates the need

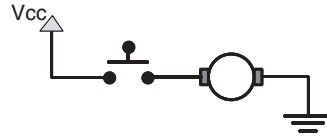

FIGURE 20.19 DC motor under switching control.

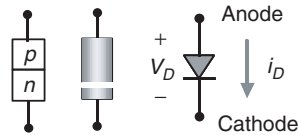

FIGURE 20.20 Diode.

for an ADC, which reduces the cost and size of the required electronics. Pulse-width modulation (PWM) is one good example using binary signal to control electromechanical actuators. Figure 20.19 shows one simple example of using a switching device to interface with a PMDC motor. As discussed in the previous section, torque is generated when current is flowing into the armature winding of a PMDC motor. To turn the motor on and off, we can connect the motor with a DC power source in series with a switch. When the switch is closed, current flows through the motor and the motor turns. If the switch is opened, current stops and the motor will eventually stop. Of course, more sophisticated circuit and switching design is needed for actual implementation.

Nevertheless, this example illustrates the fundamentals of switching power amplification. In this section, we will focus on switching amplifiers by introducing the fundamental building blocks.

Semiconductors

Semiconductors are typically materials consisting of elements from group IV of the periodic table, e.g., silicon (Si), germanium (Ge), and cadmium sulfide. Unlike conductors and insulators, semiconductors' current-carrying capability is significantly affected by the temperature and the amount of incident photons and the type and amount of impurities in the material. By introducing carefully controlled group V or III elements (called *dopants*) into the semiconductors, we can increase or decrease the number of valence electrons in the semiconductors, respectively. Depending on the type of the dopants, semiconductors can be separated into:

- *n-type semiconductors*: semiconductors doped with *donor* elements (e.g., arsenic or phosphor group V elements) that result in one additional electron freed (*free electron*) from the crystal lattice as a charge carrier that is available for conducting.
- *p-type semiconductors*: semiconductors doped with *acceptor* elements (e.g., boron or gallium group III elements) that results in a missing electron in the lattice structure, which is called a *hole*. Holes can be viewed as positive charge carriers or places that accept free electrons.

As will be discussed shortly, the interaction between the n-type and p-type semiconductors under different orientation forms the basis for all the semiconductor electronic devices. One of the more interesting aspects of modern electronics is the variety of features that can be obtained with a simple switching device that opens or closes a connection in a controlled manner. We will discuss a few electronic elements that are widely used, mainly as a controlled switching element, in power electronics for constructing power amplifiers/drivers for electromechanical actuators.

Diodes

A diode is a two-terminal electronic device that is constructed by joining a p-type and an n-type semiconductor together to form a *pn junction*. Figure 20.20 shows the schematic symbol of a generic diode. The terminal associated with the p-type material is called the *anode* and the terminal associated with the n-type material is called the *cathode*. If the anode has higher electrical potential (>0.7 V) than

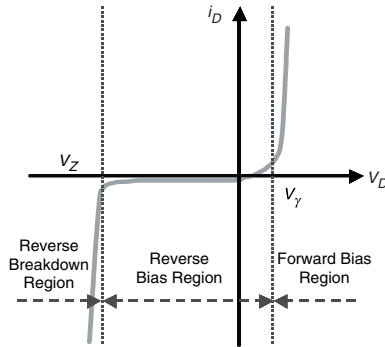

FIGURE 20.21 Diode characteristics.

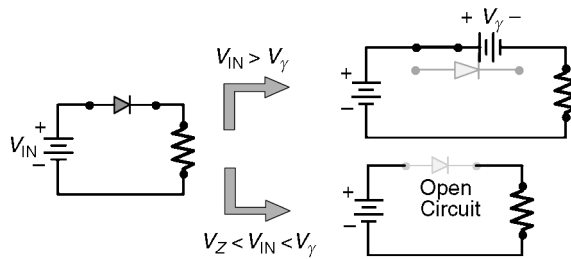

FIGURE 20.22 Approximating a diode in a circuit.

the cathode, the diode is said to be *forward biased*, i.e., $V_D > 0.7$ V. Conversely, if $V_D < 0.7$ V, the diode is *reverse biased*.

As shown in Fig. 20.21, depending on the applied voltage, a diode can operate in three different regions:

- *Forward biased region:* $V_D > V_Y$, where V_Y is called the *forward bias voltage* and is typically around 0.7 V for silicon and 0.3 V for germanium. The diode acts as a closed switch, and the anode and cathode become short-circuited with a slight reverse potential (forward voltage drop) that is equal to V_Y , see Fig. 20.22.
- *Reverse biased region:* $V_Z < V_D < V_Y$, where V_Z is the *reverse breakdown voltage* of the diode. The diode acts as an opened switch and the circuit is open, see Fig. 20.22.
- *Breakdown region:* $V_D < V_Z$. The diode again acts as a closed switch and a large current flows through the diode. This is called the *avalanche effect*. If the magnitude of the reverse current i_D is larger than the critical reverse bias current, the device will fail.

A diode is analogous to a fluid check valve, which allows fluid (current) to flow in only one direction if the forward pressure is sufficient to overcome the spring force, see Fig. 20.23. Table 20.3 summarizes properties of some typical diodes.

Maximum allowable current through a diode and the reverse breakdown voltage are the two major design considerations for diodes. The voltage across a diode times the current it carries is the power loss across the diode that is completely converted into heat. The temperature of a diode can rise rapidly due to its small size and mass. For safe operation, the temperature of the diode junction should not exceed 200°C. To improve heat transfer, diodes are commonly mounted on metallic *heat sinks*. Signal diodes are rated between $1/2$ and 1 W. Power diodes can be rated as high as several hundred kilowatts.

TABLE 20.3 Typical Diode Properties

| Relative Power | Maximum Average Forward Current [A] | Voltage Drop at Maximum Average Forward Current [V] | Maximum Peak Forward Current [A] | Reverse Breakdown Voltage [V] | Maximum Junction Temperature [°C] |
|----------------|-------------------------------------|---|----------------------------------|-------------------------------|-----------------------------------|
| Low | 1 | 0.8 | 30 | 1000 | 175 |
| Medium | 12 | 0.6 | 240 | 1000 | 200 |
| High | 100 | 0.6 | 1600 | 1000 | 200 |
| Very High | 1000 | 1.1 | 10,000 | 2000 | 200 |

Source: T. Wildi, *Electrical Machines, Drivers and Power Systems*, Prentice Hall, 2000.

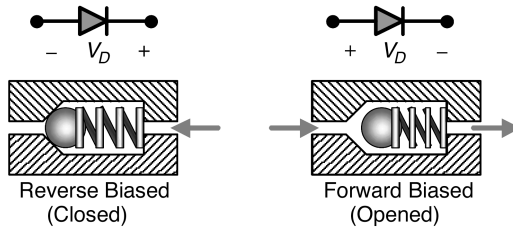

FIGURE 20.23 Analogy between diodes and check valves.

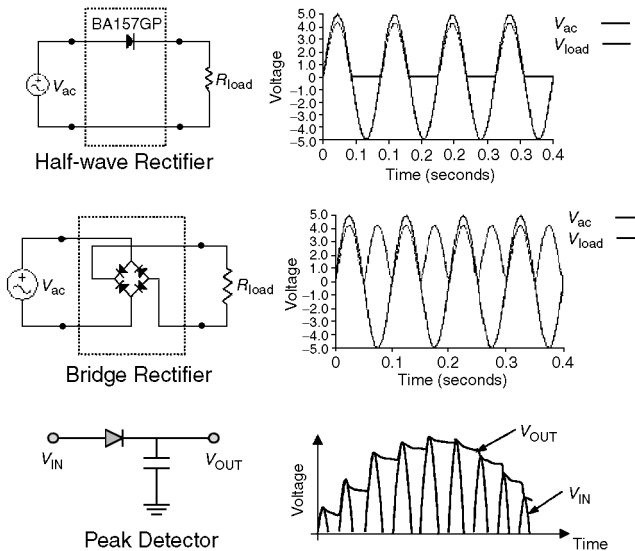

FIGURE 20.24 Common diode applications.

For switching applications, the *reverse-recovery time* is another important design parameter. The reverse-recovery time imposes an upper bound on the frequency at which the diode can be switched on and off. Attempts to operate a diode above this frequency will result in a decrease in switching efficiency and may cause severe overheating.

Diodes are widely used in electronic power circuits. They are most widely used for rectification and peak detection. [Figure 20.24](#) illustrates some of the common diode applications. If multiple diodes are to be

used, diode array can be used. In general, the term diode array implies four or more diodes in a single package. The most efficient packaging scheme is typically eight diodes or more in a dual inline package (DIP). Other packages are the single inline package (SIP), the flat pack, and even a surface mount diode array. Although multiple diode arrays can incorporate different type diodes, the most popular arrays incorporate a fast, small signal diode such as the 1N4148, and the core driver arrays, which employ a fast switching, higher current, 100-mA diode.

Zener Diode

Recall the current–voltage curve of a diode shown in Fig. 20.21. If a diode is reverse biased to the breakdown region, a large reverse current will flow through the diode. For most diodes, this voltage is usually larger than 50 V and may exceed kilovolts. Zener (Avalanche) diodes are a class of diodes that exhibit a steep breakdown curve with a well-defined reverse breakdown voltage V_Z . This unique breakdown characteristic makes Zener diodes good candidates for building *voltage regulators*, since they can maintain a stable source voltage under variable supply as well as varying load impedance. Figure 20.25 shows the special symbol that represents a Zener diode.

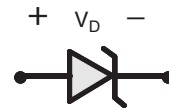

FIGURE 20.25 Zener (avalanche) diode.

To use the Zener diode as a voltage regulator, it should be reverse biased with a supply voltage higher than the rated reverse breakdown voltage V_Z , see Fig. 20.26. For an ideal Zener diode, in Fig. 20.26, $V_S > V_Z$, the voltage across the load will equal to V_Z ; hence the load current i_{load} and the Zener diode current can be written as

$$i_{load} = \frac{V_Z}{R_{load}} \quad \text{and} \quad i_Z = \frac{V_S - V_Z}{R_S}$$

Zener diodes are often rated by their power dissipation, which is

$$P_{Zmax} = i_{Zmax} \cdot V_Z$$

Therefore, when selecting Zener diode for voltage regulation applications, it is important to ensure that i_{Zmax} does not exceed the allowable limit. The most common range of the reverse breakdown voltage for Zener diodes is from 3.3 V to 75 V. However, voltages out of this range are available. Some typical power ratings for Zener diodes are 1/4, 1/2, 1, 5, 10, and 50 W.

Thyristors

A thyristor, or a *silicon-controlled rectifier (SCR)*, is a 4-layer semiconductor switch, similar to a diode, but with an additional terminal to control the instant of conduction. A thyristor has three terminals: an anode, a cathode, and a gate, see Fig. 20.27. One can think of a thyristor as a controllable diode that the gate terminal provides as a mean of precise control of the instance when the thyristor is to be turned on, i.e., it is a controlled switch.

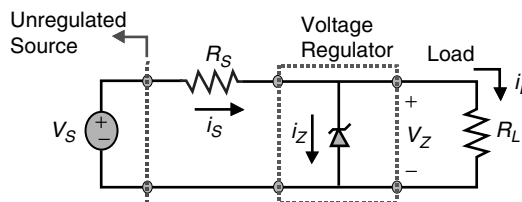

FIGURE 20.26 Use zener diode as simple voltage regulator.

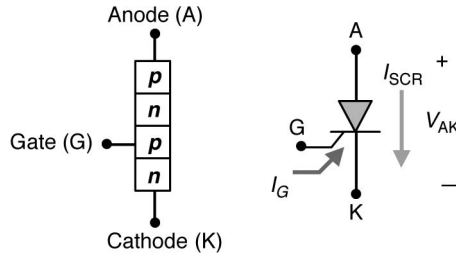

FIGURE 20.27 Thyristor and its schematic symbol.

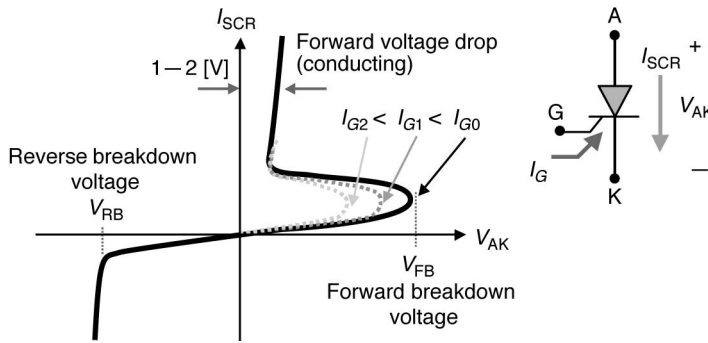

FIGURE 20.28 Thyristor (SCR) characteristics.

Figure 20.28 shows the current–voltage characteristics of a thyristor. To turn on (short or conduct) a thyristor, two conditions have to be satisfied:

1. The anode (A) and cathode (K) terminal has to be forward biased, i.e., the anode voltage needs to be higher than the cathode voltage.
2. A gate current I_G has to flow into the gate for a sufficient amount of time, typically, a few microseconds. The gate current can be generated by a short positive voltage pulse applied across the gate (G) and cathode (K) terminal. The minimum amount of gate current that is required to turn on a thyristor is called the *latching current*.

When the thyristor is turned on, the amount of current flowing through the device I_{SCR} is limited by the rest of the circuit impedance. Once the thyristor is turned on, the gate terminal loses control of the device, i.e., we cannot use the gate to turn off the device. The thyristor will only turn off if the anode current I_{SCR} goes to zero, after which the gate terminal can assert control to turn on the device again. Obviously, the thyristor can also be switched on by exceeding the forward breakdown voltage V_{FB} . However, this is usually considered a design limitation and switching is normally controlled with a gate voltage. If the gate (G) terminal is shorted with the cathode (K), the thyristor cannot be turned on, even if V_{AK} is forward biased. One can think of the thyristor as a normally opened switch with a detent. Once the switch is closed, no additional control is needed. Figure 20.29 shows the operation of a thyristor driving a simple resistive load under a sinusoidal bipolar source voltage V_s . In Fig. 20.31, the gate voltage V_G will be the command or control input.

When the thyristor is reverse biased, the gate (G) to cathode (K) terminals should not be forward biased to prevent reverse breakdown of the first pn junction of the thyristor, see Fig. 20.27. The reverse breakdown voltage V_{RB} , the latching current, the current and power rating, and the rate of rise of voltage are the more important design parameters for selecting a thyristor. When the voltage across the thyristor is suddenly applied or increased rapidly, the thyristor may turn on even if the gate current (voltage) is

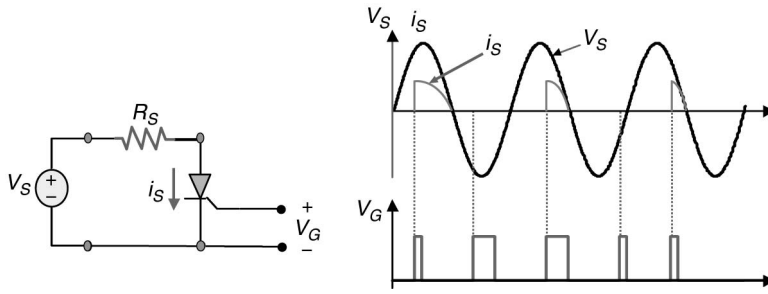

FIGURE 20.29 Thyristor driving a resistive load.

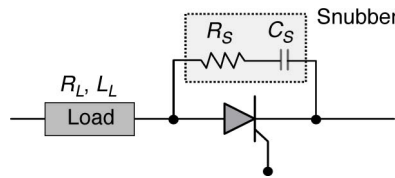

FIGURE 20.30 Snubber circuit.

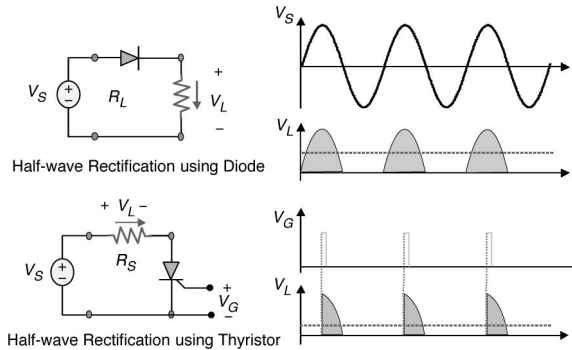

FIGURE 20.31 Controlled (thyristor) and uncontrolled (diode) rectifications.

zero. A typical rate of voltage change that will induce thyristor turn-on is about $50 \text{ V}/\mu\text{s}$. To prevent undesired conduction due to a large rate (high frequency) of voltage variation, a *snubber circuit*, see Fig. 20.30, is often connected in parallel with the thyristor to filter out the high frequency voltage variations. The snubber circuit is essentially a passive RC low-pass filter. The selection of the snubber resistance R_s and capacitance C_s can use the following formula:

$$C_s = \frac{V_{A\max}^2}{L_L (dV/dt)_{\max}^2} \quad \text{and} \quad R_s = 2 \sqrt{\frac{L_L}{C_s}} - R_L \quad (20.12)$$

where R_L and L_L are the load inductance and load resistance, respectively. $V_{A\max}$ is the maximum anode voltage and $(dV/dt)_{\max}$ is the maximum expected rate of raise of voltage across the anode and cathode.

Unlike diodes used in rectifier circuits that can only rectify the input AC voltage to an average DC voltage, thyristors can be used to build controlled rectifiers that can rectify AC sources and modulate the average output DC voltage by modulating the firing timing of the gate voltage/current, see Fig. 20.31.

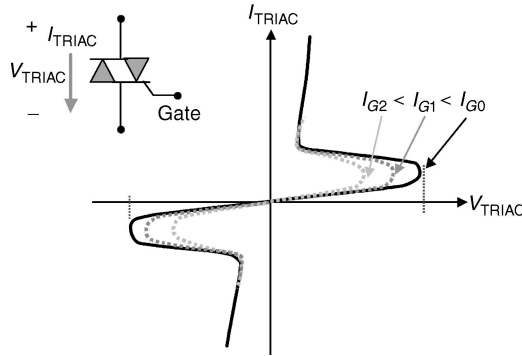

FIGURE 20.32 Triac characteristic.

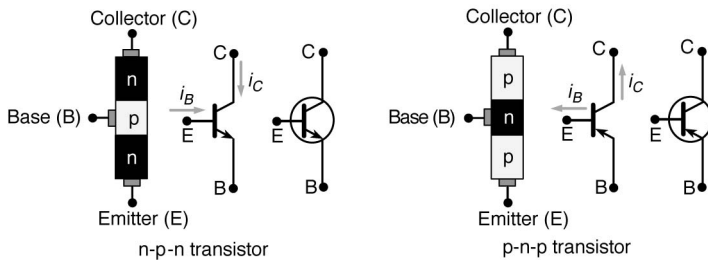

FIGURE 20.33 Bipolar junction transistors (BJTs).

Triac

The thyristor can only be turned on in the forward biased direction. A *triac* is a controlled switch that is equivalent to a pair of thyristors that are connected in an anti-parallel configuration, see Fig. 20.32. As depicted in Fig. 20.32, a triac can be turned on in both the reverse and forward directions.

Transistors

A *transistor* is a semiconductor device that has three or more terminals and can provide power amplification and switching. As we have seen in the previous discussions, electronic switching can be accomplished through either diodes or thyristors. Diode switching does not provide any control freedom. A thyristor is a three-terminal device and the third (gate) terminal can be used to control and switching instant. However, one drawback of thyristor switching is that the switching control is only in one direction, i.e., the gate terminal can only be used to turn on the device. The thyristor switch can only be turned off by dropping the anode current to zero.

A transistor is a special semiconductor device that can be used for *power amplification* by modulating a relatively large current between or voltage across two terminals using a small control current or voltage, and *switching* by effectively opening and closing the connection between two terminals using a controlled signal on the third terminal.

Transistors form the basis of modern electronics and are the fundamental building blocks for digital electronics, operational amplifiers, and power electronics. There are three common types of transistors, bipolar junction transistors (BJTs), metal-oxide field effect transistors (MOSFETs), and insulated gate bipolar transistors (IGBTs).

Bipolar Junction Transistors (BJTs)

A bipolar junction transistor is a three-layer device that is made of the p-n-p or the n-p-n combinations of semiconductors, see Fig. 20.33. BJTs have three terminals connected to each of the three layers called

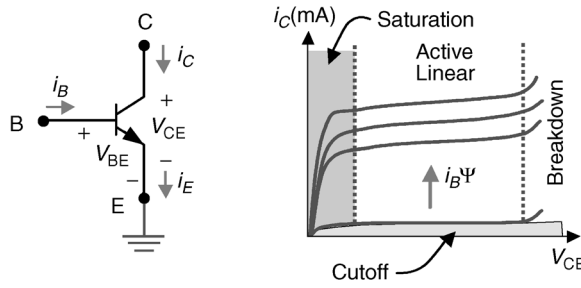

FIGURE 20.34 Characteristics of a common emitter n-p-n BJT.

collector (C), emitter (E), and base (B). Figure 20.34 shows the operation of an n-p-n type BJT under a common emitter type connection. BJTs can operate in three regions:

1. *Cutoff*—When the base-emitter voltage is less than the turn-on voltage V_γ , the base current i_B will be negligible. The transistor is in the *cutoff* region and no current will flow through the collector and emitter terminal, i.e.,

$$\begin{cases} V_{BE} < V_\gamma \\ i_B = 0 \end{cases} \Rightarrow \begin{cases} i_C \approx 0 \\ V_{CE} \geq 0 \end{cases}$$

Typically, $V_\gamma = 0.6 - 0.7$ V. In this mode, the transistor from C to E can be viewed as an open connection. This is analogous to the closed flow control valve.

2. *Active Linear*—When $V_{BE} = V_\gamma$, the transistor is in the *active linear* region, where

$$V_{BE} = V_\gamma \quad \text{and} \quad \begin{cases} i_C = \beta \cdot i_B \\ V_{CE} > V_\gamma \end{cases}$$

In this mode, the transistor can be viewed as a current-controlled current amplifier, where the collector current i_C is proportional to the base current i_B . The proportionality constant (current amplification factor or current gain) $\beta = 20 \sim 200$, is often denoted as h , h_f , or h_{FE} in the data sheets. In this mode, the connection between the terminals C and E can be viewed as closed. This is analogous to a partially opened flow control valve, where the amount of the fluid (current) flow is proportional to the size of the valve opening (base current magnitude). The power dissipation across the transistor P_{BJT} is

$$P_{BJT} = i_C \cdot V_{CE}$$

3. *Saturation*—When the base current i_B is larger than the maximum available collector current i_C , the transistor is in the *saturation* region, where

$$\begin{cases} i_B > i_C / \beta \\ V_{BE} = V_\gamma \end{cases} \quad \text{and} \quad V_{CE} = V_{SAT} \approx 0.2 \text{ V} \quad (20.13)$$

In this mode, the transistor can be viewed as a closed switch between the terminals C and E. The collector current i_C is controlled (determined) by the collector circuit. This is analogous to a completely opened flow control valve, where the flow is determined by the source and the load. Note also that when the transistor is in saturation, the collector-emitter voltage drop is maintained at a small value called the saturation voltage V_{SAT} .

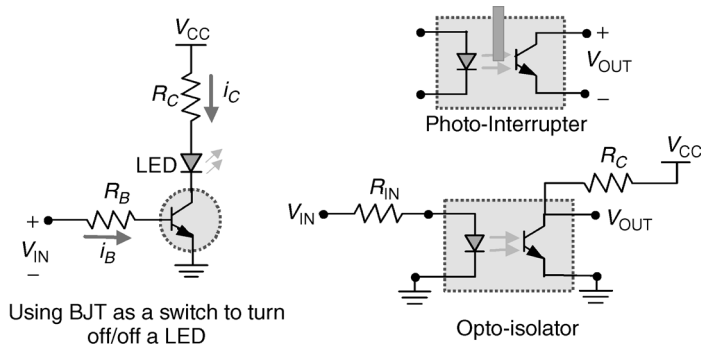

FIGURE 20.35 Some examples of using BJT.

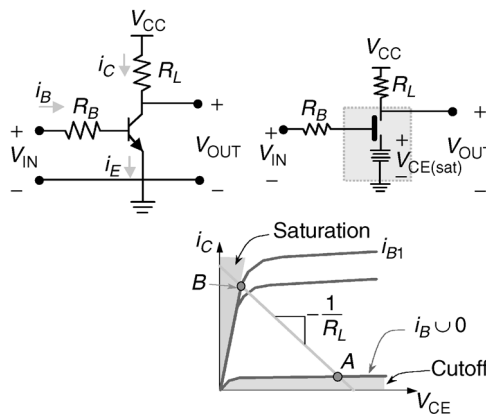

FIGURE 20.36 BJT as a current controlled switch.

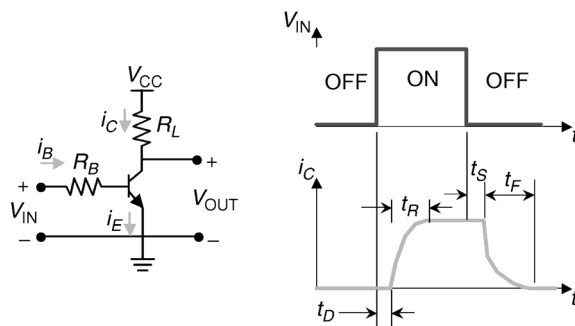

FIGURE 20.37 BJT switching characteristics.

In summary, when the transistor is saturated, it acts as a closed switch. When a transistor is in the cutoff region, it acts as an open switch. When it is in the active region, it acts as a current (i_B) controlled current (i_C) amplifier. Although this is a very simplistic approximation, it is very useful for designing and understanding power electronics and interfacing electromechanical systems. Figure 20.35 illustrates some examples of BJT devices and applications.

When carefully controlling the base-emitter voltage V_{BE} and base current i_B , the transistor can be made to operate between the cutoff and the saturation region, which act as a switch, see Fig. 20.38. Realistically, transistor switching is not instantaneous (see Fig. 20.37). The turn-on time t_{ON} of the transistor is the

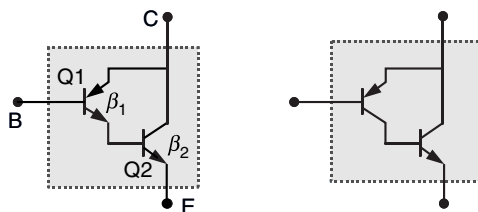

FIGURE 20.38 Two type of Darlington transistor pairs.

sum of the delay time t_D and the rise time t_R . Similarly, the turn-off time t_{OFF} is the sum of the storage time t_S and the fall time t_F . The turn-on and turn-off time of a transistor limits the maximum switching frequency. Typical switching frequency for a power BJT is between 2 and 20 kHz. Generally speaking, BJTs can switch at a higher frequency than thyristors but can handle less power. Power BJTs can handle currents up to several hundred amperes and V_{CE} up to about 1 kV.

Power dissipation is a key design constraint for BJTs. Recall that if the BJT is used in the active linear region (linear amplifier), the power dissipation is $P_{BJT} = i_C \cdot V_{CE}$ with $V_{CE} > V_{\gamma}$. With a large collector current and considering the small volume and thermal mass of the device, the transistor is not very efficient when operating in the active linear region. On the other hand, when the BJT is switching between saturation and cutoff, the collector current will be small (during cutoff) and V_{CE} will be small (during saturation). The switching power dissipation is much smaller compared with the active linear mode of operation. This makes switching much more efficient.

One design consideration working with BJT is to supply adequate base current, especially when the transistor is to operate in the saturated region, see Eq. (20.13). This may require large input power and may overload the input stage. As will be discussed later, this is also the main reason that BJTs are less used in switching power electronics and are being replaced by devices such as MOSFET and IGBT, which require much less control current. One solution to this constraint is to increase the current gain β . A simple and elegant implementation to increase the effective current gain of a BJT is the Darlington pair configuration.

Darlington Transistor Pairs

A *Darlington transistor pair* connects two BJT transistors to form an effective three terminal device that has increased current gain, see Fig. 20.38. In Fig. 20.38, let β_1 and β_2 be the current gains of the two transistors, then the relationship between the base current of transistor Q1 and the collector current of transistor Q2 is

$$i_{C2} = \beta_2 \cdot i_{B2} = \beta_2 \cdot (\beta_1 \cdot i_{B1}) = (\beta_2 \cdot \beta_1) \cdot i_{B1} = \beta_D \cdot i_{B1}$$

Therefore, the effective current gain for the Darlington transistor pair is the product of the two individual current gains, i.e., $\beta_D = \beta_1 \cdot \beta_2$. For a typical Darlington pair, this can be in the range of 500–10,000. The trade-off for using Darlington pair configuration is the additional space (real estate) needed for two transistors instead of one.

Metal-Oxide-Semiconductor Field Effect Transistor (MOSFET)

MOSFET is a type of field effect transistor (FET). FETs are voltage controlled three terminal devices respectively called drain (D), source (S), and gate (G). The terms come from the analogy of overhead tank system that uses a gate valve to control the water flow from source to drain. MOSFET uses a metal plate as the gate terminal and it is insulated from the p- or n-type silicon substrate by a thin layer of oxide (see Fig. 20.39). When a gate voltage V_G is applied to the gate plate, an electrostatic field induces reverse charges at the gate and the substrate. The charges at the substrate initiate transistor type characteristics by forming either an n-type channel or a p-type channel. Hence, the n- or p-type MOSFET classifications (see Fig. 20.39).

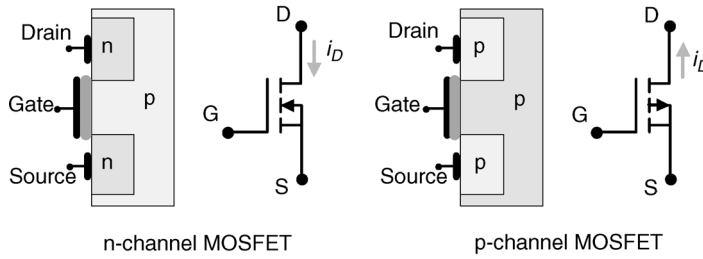

FIGURE 20.39 Metal-oxide-semiconductor (MOS) field effect transistor (FET).

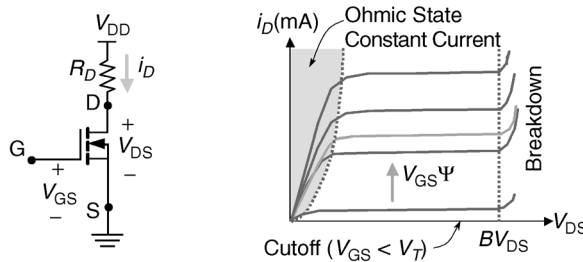

FIGURE 20.40 Enhancement mode MOSFET characteristic.

For a majority of the power amplification and modulation applications, MOSFETs are designed to operate in the *enhancement* mode. Figure 20.42 illustrates the *enhancement* mode characteristic of an n-channel MOSFET:

1. *Cutoff*—When the potential across the gate and the substrate (source) V_{GS} is less than the turn-on (threshold) voltage V_T , the MOSFET is in the *cutoff* region and there is negligible current flow through the drain (D) terminal, i.e.,

$$\begin{cases} V_{GS} < V_T \\ i_G = 0 \end{cases} \Rightarrow \begin{cases} i_D \approx 0 \\ V_{DS} \approx V_{DD} \end{cases}$$

Typically, $V_T \approx 1\text{--}2$ V. In this mode, the transistor from D to S can be viewed as an open connection.

2. *Active Region*—When the $V_{GS} > V_T$, the MOSFET is in the *active* region, where

$$V_{GS} > V_T \quad \text{and} \quad \begin{cases} i_D \propto (V_{GS} - V_T)^2 \\ V_{DS} > V_{GS} - V_T \end{cases}$$

In this mode, the transistor can be viewed as a voltage-controlled current amplifier, where the drain current i_c is proportional to square of the difference between the gate-source voltage and the threshold voltage. The drain current is controlled by the gate-source voltage V_{GS} . The power dissipation across the transistor P_{FET} is

$$P_{FET} = i_D \cdot V_{DS}$$

3. *Ohmic State*—When V_{GS} is large enough so that the drain current is determined by the drain source circuit, the MOSFET is in *saturation* and

$$V_{GS} \gg V_T \quad \text{and} \quad \begin{cases} i_D = V_{DD}/R_D \\ V_{DS} \approx i_D \cdot R_{ON}(V_{DS}) < V_{GS} - V_T \end{cases} \quad (20.14)$$

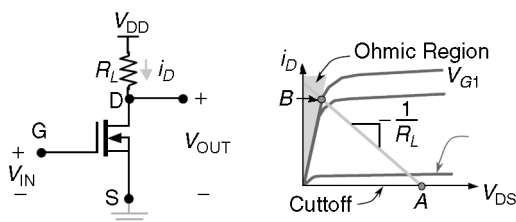

FIGURE 20.41 MOSFET as a voltage controlled switch.

In this mode, the transistor can be viewed as a closed switch between the terminals D and S with a voltage controlled resistance R_{ON} . The drain current i_D is controlled (determined) by the drain circuit. At rate current, the V_{DS} drop during saturation ranges from 2 to 5 V.

When operating in the enhancement mode, a MOSFET behaves very similar to a BJT. Instead of base current, the MOSFET behavior is determined by the gate voltage. When carefully controlling the gate voltage of a MOSFET, the transistor can be made to operate as a voltage controlled switch (Fig. 20.41) that operates between the cutoff (point A) and the Ohmic (point B) region.

One advantage of a MOSFET device is that the MOSFET has significantly larger input impedance as compared to BJT. This simplifies the circuit that is needed to drive the MOSFET since the magnitude of the gate current is not a factor. This also implies that a MOSFET is much more efficient than BJTs as well as it can be switching at a much higher frequency. Typical MOSFET switching frequency is between 20 and 200 kHz, which is an order of magnitude higher than BJTs. Power MOSFETs can carry drain currents up to several hundreds of amperes and V_{DS} up to around 500 V.

Field effect is one of the key reasons why MOSFET has better switching performance than BJT. However, static field is also one of its main failure modes. MOSFETs are very sensitive to static voltage. Since the oxide insulating the gate and the substrate is only a thin film (in the order of a fraction to a few micrometer), high static voltage can easily break down the oxide insulation. A typical gate breakdown voltage is about 50 V. Therefore, static electricity control or insulation is very important when handling MOSFET devices.

Comparing BJT with MOSFET, we can conclude the following:

- Both can be used as current amplifiers.
 - BJT is a current-controlled amplifier where the collector current i_C is proportional to the base current i_B .
 - MOSFET is a voltage-controlled amplifier where the drain current i_D is proportional to the square of the gate voltage V_G .
- Both can be used as three terminal switches or voltage inverters.
 - BJT: switching circuit give rise to TTL logics.
 - MOSFET: switching circuit give rise to CMOS logics.
- BJT usually has larger current capacity than similar sized MOSFET.
- MOSFET has much higher input impedance than BJT and is normally off, which translates to less operating power.
- MOSFETs are more easily fabricated into integrated circuit.
- MOSFETs are less prone to go into thermal runaway.
- MOSFETs are susceptible to static voltage (exceed gate breakdown voltage ~ 50 V).
- BJT has been replaced by MOSFET in low-voltage (< 500 V) applications and is being replaced by IGBT in applications at voltages above 500 V.

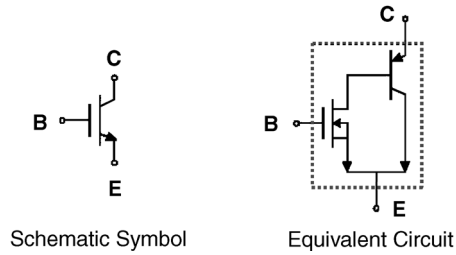

FIGURE 20.42 Insulated gate bipolar transistor (IGBT).

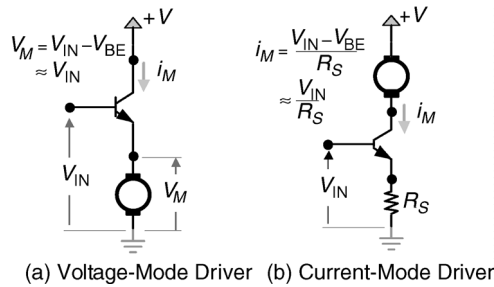

FIGURE 20.43 Two basic linear motor amplifiers.

Insulated Gate Bipolar Transistor (IGBT)

IGBT is a voltage-controlled transistor that has the terminals identified in the same way as BJTs. IGBT is a four-layer device that has the similar construction of a MOSFET with an additional p layer. Figure 20.42 shows the schematic symbol and equivalent circuit for an IGBT. IGBT has the combined characteristics of the BJT and MOSFET. Similar to MOSFET, it has high input impedance and high switching frequency. It also has high power handling capacity like the BJT.

Typical Power Amplifiers for Electromechanical Actuators

Power amplification and modulation for electromechanical actuators are classified into two basic categories, based on the methods the respective power electronics are driven. Linear amplifiers drive the BJTs in their active linear region. Switching amplifiers drive the transistors in on-off switch mode. Depending on the control objective, the command signal (Fig. 20.2) to the amplifier can be either a voltage or current command that intends to modulate the electric energy delivered to the energy conversion device. Since most of the electromechanical actuator involves driving an inductance load such as a coil winding of an electromagnet or the rotor of a DC motor, in the following discussion, we will use the DC motor as an example of an inductance load for the power amplifier.

Linear Amplifiers

Figure 20.43 shows the basic drive circuit for linear voltage and current control amplifiers. Both schemes have the following commonalities:

1. The input command voltage $V_i(t)$ is applied to the base of the transistor.
2. The electric power needed to driver the load is provided by a DC supply.
3. The transistors are driven in the active linear region.

Voltage Control (Mode) Amplifier

In Fig. 20.43(a), the motor is driven as a load of an emitter circuit. If the base-emitter voltage is ignored, the voltage across the motor V_M is directly controlled by the input voltage V_{IN} and the current is supplied by the power supply. The amount of current, on the other hand, depends on the applied voltage, speed, and the motor parameter.

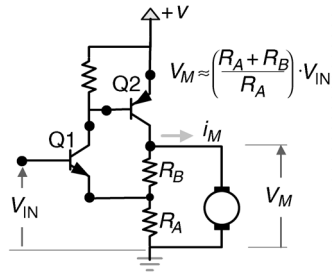

FIGURE 20.44 Variable gain voltage-mode amplifier.

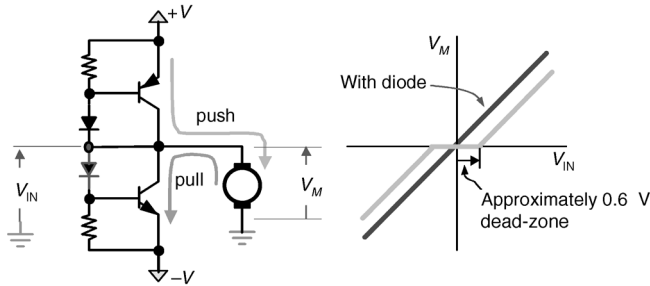

FIGURE 20.45 Bipolar voltage-mode amplifier.

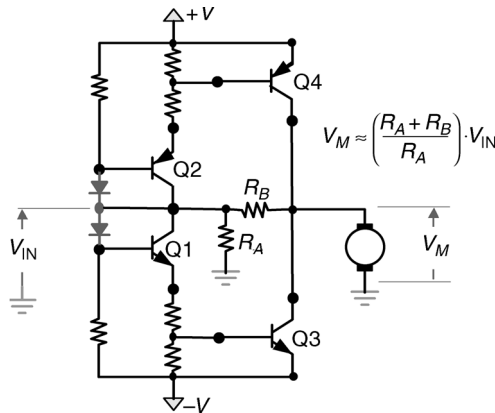

FIGURE 20.46 Bipolar variable gain voltage-mode amplifier.

To provide adjustable voltage gain, Fig. 20.44 shows a variable gain voltage-mode amplifier, where the apparent amplifier gain from the command input V_{IN} to the applied motor (winding) voltage V_M can be approximated by $(R_A + R_B)/R_A$, which can be adjusted by proper selection of the resistors R_A and R_B . If a large motor current is required, transistor Q2 can be replaced by a Darlington transistor pair.

The amplifiers shown in Fig. 20.43 and Fig. 20.44 can only drive the current through the motor (load) in one direction. Hence, they are also called *unipolar* amplifiers. To provide bidirectional current flow, two transistors can be connected with the motor in a *push-pull* type configuration, as shown in Fig. 20.45. The two diodes in the circuit are used to eliminate the dead-zone created by the base-emitter voltage drop for the transistors. Notice that a bipolar voltage source is needed for this configuration. Figure 20.46 shows a bipolar voltage-mode driver with variable gain $(R_A + R_B)/R_A$. Similarly, if larger motor current is required, transistors Q3 and Q4 can be replaced by Darlington transistor pairs.

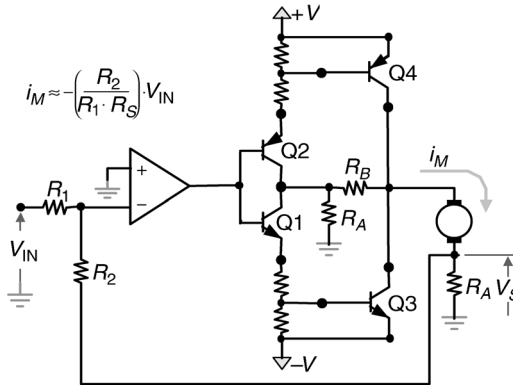

FIGURE 20.47 Bipolar variable gain current-mode amplifier.

Current Control (Mode) Amplifier

As previously discussed, in many electromagnetic actuators, the output force or torque of the device has strong correlation with the winding current, e.g., for a permanent magnet DC motor and a voice coil actuator, the output torque and force are proportional to the input current. Therefore, in many motion control applications, it is more desirable to have a voltage-to-current conversion (*current-mode amplifier*) at the power stage, where the input voltage command is proportional to the current flowing into/out of the motor (winding). Figure 20.43(b) shows a basic circuit for a current-mode amplifier. The relationship between the emitter (motor) current i_M and the input voltage command V_{IN} is

$$i_M = \frac{V_{IN} - V_{BE}}{R_S}$$

If the base-emitter voltage is ignored, the voltage across the motor current i_M is proportional to the input voltage V_{IN} , i.e., $i_M \approx (1/R_S) \cdot V_{IN}$.

Figure 20.47 shows a basic bipolar current-mode amplifier. An Op-Amp is used to close the current loop. The resistor R_S , often called the *sensing resistor*, is used to sense the motor current for feedback to the Op-Amp. Depending on the desired current magnitude, the sensing resistor needs to have adequate power rating to dissipate the heat ($i_M^2 \cdot R_S$) generated by flowing current through the resistor. For a zeroth order approximation, at steady state, the Op-Amp will try to equalize the potential at the positive and the negative terminals, i.e., it will try to make

$$V_S \approx -\left(\frac{R_2}{R_1}\right) \cdot V_{IN}$$

which implies

$$i_M \approx -\left(\frac{R_2}{R_S \cdot R_1}\right) \cdot V_{IN}$$

Although a current amplifier tends to have a linear relationship between the command input and the winding current, there is practical limitation due to the limited source voltage. In Fig. 20.47, the supply voltage is $\pm V$. Assuming that the motor winding has resistance R_M , the maximum current i_{MAX} the voltage source can supply is upper bounded by

$$i_{MAX} < \frac{V}{R_M + R_S}$$

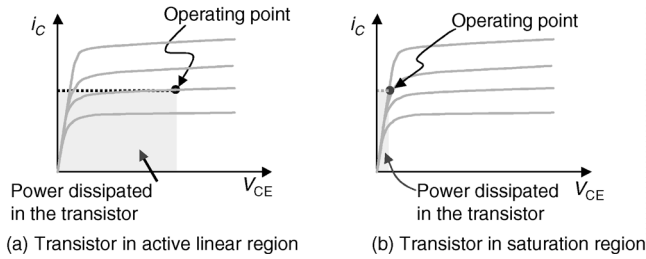

FIGURE 20.48 Power dissipation in transistors.

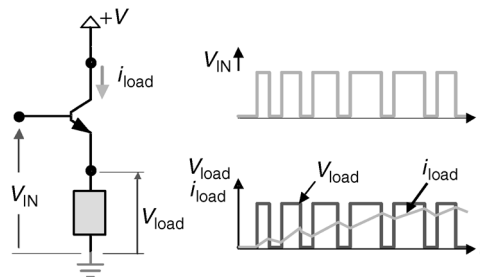

FIGURE 20.49 Simple switching amplifier with switching input.

The above bound has not considered the effect of the back-emf that will be induced in the winding if the winding is moving. Hence, the amount of current available for a current-mode amplifier is limited and needs to be considered when working with a current-mode amplifier.

Switching Amplifiers

Linear amplifiers are simple and do not generate electrical noises. However, since the final stage transistors are operating in the active linear region, significant power is dissipated into heat; this reduces the efficiency of the device as well as requires large heat sinks to protect the components. However, as shown in Fig. 20.48, when operating in the saturation region, if the collector-emitter voltage drop is in the order of 1 V or less, the power loss across the transistor is significantly less, given the same amount of current flow. The trade-off is that additional circuits are needed to provide the modulation for current or voltage control.

Figure 20.49 shows a simple switching amplifier that is simply a transistor connecting a load. It is essentially the same as the basic linear amplifier shown in Fig. 20.43(a). The difference is in the way the transistor is controlled. For a switching amplifier, the input (base) voltage only takes on two values (states), high and low. When the base (input) voltage is high, the transistor is turned on in the saturation mode and current will flow through the load. If we neglect the collector-emitter voltage drop, the voltage across the load is approximately the supply voltage. When the base voltage is low, the transistor is turned off in the cutoff state and no voltage is applied to the load. If the load has a low pass characteristic, the average current/voltage across the load will be proportional to the turn-on time. Therefore, if the switching frequency is sufficiently high (relative to the load impedance), the effective voltage/current across the load can be modulated by the percent high input voltage, e.g., if the V_{IN} is high 80% of the time, the average voltage across the load will be close to 80% of the supplied voltage V . This is the so-called *pulse-width modulation (PWM)*. Another benefit of using switching amplifiers is that V_{IN} can be directly interfaced with a digital device without the need for a DAC.

Push-Pull (Class B) Power Amplifier

The switching amplifier shown in Fig. 20.49 is unipolar, i.e., it can only drive current through the load in one direction. Figure 20.52 shows a simple *push-pull (Class B)* type power stage to supply bi-directional current to the load. The circuit in Fig. 20.50 is very similar to the bipolar voltage-mode amplifier shown

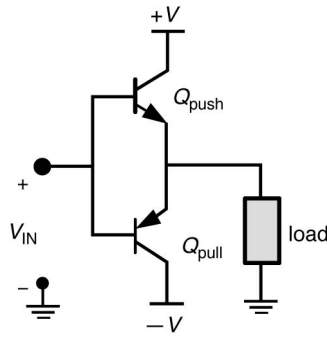

FIGURE 20.50 Switching push-pull amplifier.

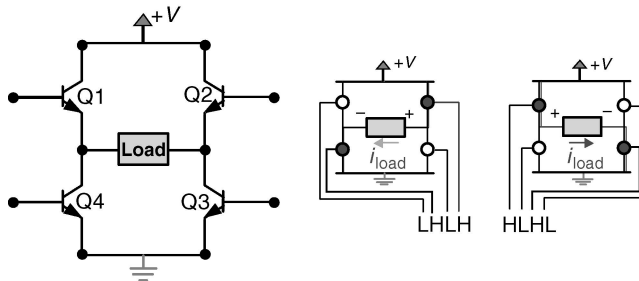

FIGURE 20.51 H-bridge driver.

in Fig. 20.45. The difference is also in the way the transistors are controlled. When the base voltage V_{IN} is sufficiently positive ($+V$), the push transistor Q_{push} will be turned on and the pull transistor Q_{pull} will be turned off. This results in a load current flowing from positive supply to ground. If the base voltage is sufficiently negative ($-V$), Q_{push} will be turned off and Q_{pull} will be turned on, which results in a current flow from ground to the negative supply. To modulate the load voltage/current, PWM can also be used. This configuration is also called a *half H-bridge* driver or half-bridge driver for short. From an implementation perspective, this device requires both a positive supply and a negative supply, which tends to increase the complexity and cost of the circuit.

H-Bridge Driver

H-bridge configuration is a neat solution to achieve bipolar operation with unipolar supply. Figure 20.51 shows a simple H-bridge circuit driving a load. An H-bridge consists of four transistors that are connected in a Wheatstone bridge configuration. By turning on/off different pairs of transistors (Q1-Q3) or (Q2-Q4), bipolar voltage across the load can be achieved using a unipolar supply, see Fig. 20.51. In many applications, the transistors pairs in the H-bridge can be directly driven by the output of a digital device (TTL or CMOS). The n-p-n or n-channel transistors can be turned on to saturation by a high output from the digital port and turned off by a low output. If large amount of current is required for the load, Darlington pairs can be used in place of the individual transistors. Since MOSFETs have larger input impedance and faster switching characteristics, they are replacing BJTs in almost all switching applications.

Pulse-Width Modulation (PWM)

PWM is one of the more common ways of encoding analog information using digital signal. A PWM signal is a wave of fixed frequency and varying duty cycle (pulse width). The duty cycle in PWM context refers to the percentage of time that the signal is in the active state—usually this means a state of logic 1, see Fig. 20.52. In essence, PWM encodes (modulates) the information in the time domain rather than the voltage domain as with analog signals.

PWM actuation has several advantages over the use of D/A converters and linear components. One is the efficiency where the switching amplifiers are more efficient than their linear counter parts. Another

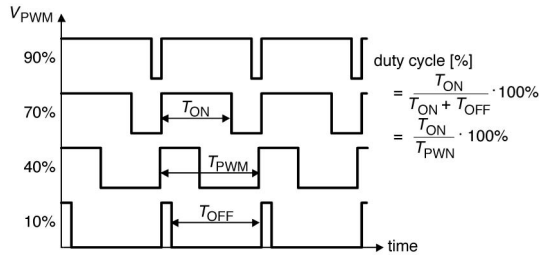

FIGURE 20.52 Pulse-width modulation signals.

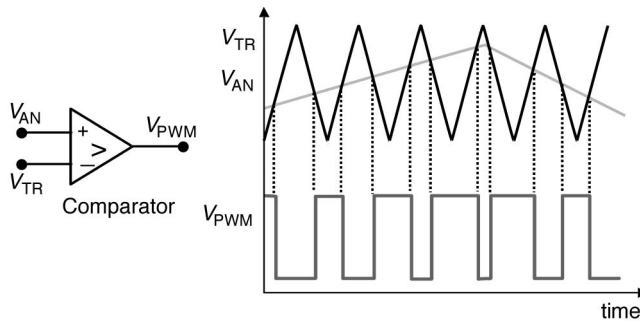

FIGURE 20.53 Generating PWM signal from analog signal.

advantage is there is no need for D/A conversion. Digital signal is maintained from the microprocessor/microcontroller to the power amplifier. In addition to having better noise rejection capability, this also reduces the need for a DAC and tends to make the circuit simpler and more cost effective. One drawback for using PWM and switching amplifiers as a whole is that the high frequency switching induces radio frequency interference (RFI) and electromagnetic interference (EMI).

The fixed PWM carrier frequency is one main design consideration. Ideally, the PWM frequency should be high enough to avoid generating audible switching noise, which mean that it should be greater than 20 kHz. However, there are a few factors that put an upper bound on the carrier frequency. Switching losses of switching devices tends to increase as the switching frequency increases. This reduces the efficiency of switching components and amplifiers. Higher PWM carrier frequency requires faster switching components that cost more. The amount of current going through the device also limits the switching rate. In general, sub-horsepower devices and office/desktop equipments usually use PWM at 20–40 kHz. For larger scale industrial applications, the PWM frequency tends to be less than 500 Hz. Another commonly specified design parameter is the PWM resolution. This is required for generating PWM from a digital source. The PWM resolution is equivalent to the quantization resolution for ADC. An 8-bit PWM means that there are $2^8 = 256$ different pulse widths per PWM carrier signal period.

PWMs are widely adopted in the field and almost all microcontrollers and microprocessors have at least one PWM output port. PWM signal can be easily generated from analog signal by comparing the analog signal with a periodic triangular signal through a comparator, see Fig. 20.53.

Interfacing Considerations

We will conclude this section by discussing some issues relating to interfacing between the electromechanical actuator and the power amplification device.

Driving Inductive Load

A majority of the electromechanical actuators use coils (windings) to convert electrical energy to magnetic energy. From a power driver viewpoint, windings are resistive and inductive loads. Inductors are energy

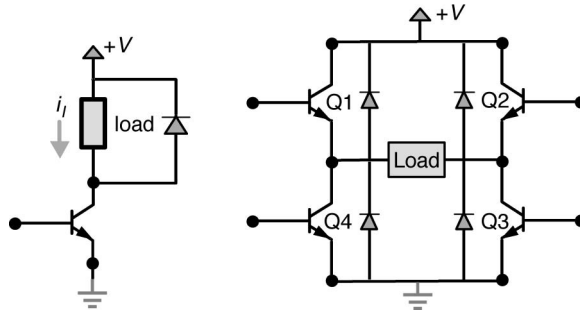

FIGURE 20.54 Using diodes to reduce switching voltage when driving inductive loads.

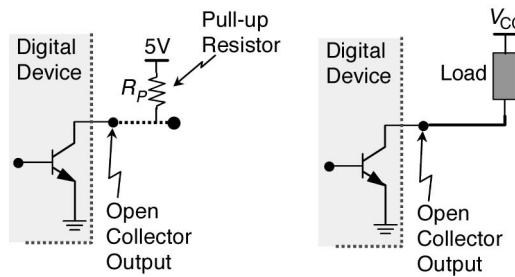

FIGURE 20.55 Open-collector output.

storage elements, where the energy is stored in the induced magnetic field. The voltage across an ideal inductor $V_L(t)$ is

$$V_L(t) = L \cdot \frac{d}{dt} i_L(t) \quad (20.15)$$

where $i_L(t)$ is the current going through the inductor and L is the inductance. When the current to the inductor is suddenly switched off, e.g., by switching off a driving transistor, Equation (20.15) indicates that there will be a large transient voltage build-up across the inductor. If not properly suppressed this transient voltage can shorten or even damage the driving transistor. This is sometimes called *inductor kickback*.

A simple method of reducing the instantaneous switching voltage surge is to create a loop for the excess energy to flow. This can be done by placing diodes in parallel with the load, see Fig. 20.54. Figure 20.54 illustrates two methods of using *flyback* or *free-wheeling* diodes to suppress switching voltage surge when driving inductive loads.

Open-Collector Output

For some digital devices, the output stage (pin) is simply the collector of a transistor. This is called an *open-collector* output, see Fig. 20.55. Since the output of the device is only the collector of a transistor, it has no output drive capacity. The output value can be measured through a pull-up resistor, see Fig. 20.55. Open-collector output is convenient for driving electromechanical devices if the output transistor can sink adequate current, see Fig. 20.57.

Isolation

Recall that the power amplification/modulation part of an electromechanical actuator contains both low- and high-energy signals, see Fig. 20.2. For safety and reliability reasons, it is desired to prevent transients or noise spikes in the high power side of the system from the signal processing (low power) side of the circuit. Mechanical relay is one option. *Optoisolators* or *optocouplers* use light to couple the high and low

energy side of the device. Typically, an LED source is combined with either a phototransistor or photothyristor, see Fig. 20.35. In addition to signal isolation, optoisolators also help to reduce ground loop issues between the logic and power side of the circuit.

Grounding

It is important to provide common ground among the different devices. For electromechanical actuators, the high energy side is often switching at high frequency; if the ground point of the high energy side of the circuit is directly connected to the ground of the low energy side of the circuit, switching noise may propagate through the ground wire and negatively affect the operation of the low energy side of the system. It is recommended that separate common grounds are established for the high and low energy side and the two grounds are then connected at the power supply. In addition, an adequate-sized ground plane needs to be provided to minimize the possibility of differences among grounding points.

20.2 Electrical Machines

C. J. Fraser

The utilization of electric motors as the power source in a mechatronic application is substantial. Electric motors, therefore, often feature as the prime mover in a variety of driven systems. It is usually the mechanical features of the application that determines the type of electric motor to be employed. The torque–speed characteristics of the motor and the driven system are therefore very important. It is perhaps then a paradox that while the torque–speed characteristics of the motor are readily available from the supplier, the torque–speed characteristics of the driven system are often quite obscure.

The dc Motor

All conventional electric motors consist of a stationary element and a rotating element, which are separated by an air gap. In dc motors, the stationary element consists of salient “poles,” which are constructed of laminated assemblies with coils wound round them to produce a magnetic field. The function of the laminations is to reduce the losses incurred by eddy currents. The rotating element is traditionally called the “armature” and this consists of a series of coils located between slots around the periphery of the armature. The armature is also fabricated in laminations, which are usually keyed onto a location shaft. A very simple form of dc motor is illustrated in Fig. 20.56.

The single coil is located between the opposite poles of a simple magnet. When the coil is aligned in the vertical plane, the conventional flow of electrons is from the positive terminal to the negative terminal. The supply is through the brushes, which make contact with the commutator segments. From Faraday’s laws of electromagnetic induction, the “left-hand rule,” the upper part of the coil will experience a force acting from right to left. The lower section will be subject to a force in the opposite direction. Since the

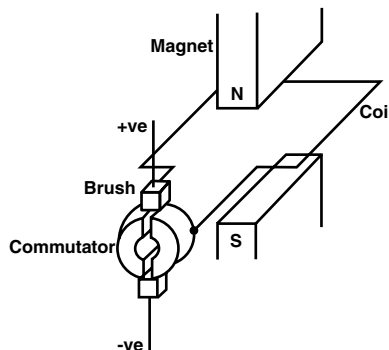

FIGURE 20.56 Single-coil, 2-pole dc motor.

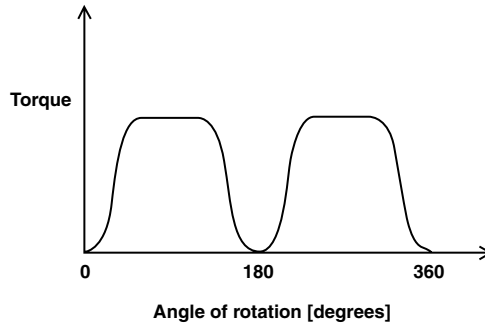

FIGURE 20.57 Torque variation through one revolution.

coil is constrained to rotate, these forces will generate a torque, which will tend to make the coil turn in the anti-clockwise direction. The function of the commutator is to ensure that the flow of electrons is always in the correct direction as each side of the coil passes the respective poles of the magnet. The commutator incorporates brass segments, separated by insulating mica strips. The carbon brushes make sliding contact with the commutator.

When the coil lies in the horizontal direction, there is maximum magnetic flux linking the coil but a minimum rate of change of flux linkages. On the other hand, when the coil is in the vertical plane, there is zero flux linking the coil but the rate of change of flux linkages is a maximum. The resultant change in torque acting on the coil through one revolution is as shown in Fig. 20.57.

If two coils physically displaced by 90° are used in conjunction with two separate magnets, also displaced by 90° , then the output torque is virtually constant. With the introduction of a second coil, the commutator needs to have four separate segments. In a typical dc machine there may be as many as 36 coils, which would require a 72-segment commutator.

The simple dc motor of Fig. 20.56 can be improved in perhaps three obvious ways. Firstly, the number of coils can be increased, the number of turns in each coil can be increased, and finally the number of magnetic poles can be increased. A typical dc machine would therefore normally incorporate four poles, wired in such a way that each consecutive pole has the opposite magnetic polarity to each of its immediate neighboring poles. If the torque generated in the armature coils are to assist one another then while one side of the coil is passing under a north pole, the other side must be passing under a south pole. With a two-pole machine the armature coils are wound with one side of the coil diametrically opposite the other. In a four-pole machine the coils are wound such that one side of the coil is displaced 90° from the other. The size of the machine will generally determine how many coils and the number of turns on each coil which can be accommodated.

Armature Electromotive Force (emf)

If a conductor cuts a magnetic flux, a voltage of 1 V will be induced in the conductor if the flux is cut at the rate of 1 Wb/s. Denoting the flux per pole as Φ and the speed (in rev/s), as N , for a single turn coil and two-pole machine, the emf induced in the coil is given as

$$E_{\text{coil}} = \frac{\text{flux per pole}}{\text{time for half rev}} = \frac{\Phi}{1/2N} = 2N\Phi \quad (20.15)$$

For a machine having Z_s armature conductors connected in series, i.e., $Z_s/2$ turns, and $2p$ magnetic poles, the total induced emf is

$$E = \frac{2N\Phi Z_s 2p}{2} = 2N\Phi Z_s p \quad (20.16)$$

The induced emf or back emf will oppose the applied voltage. Since the emf is directly proportional to the motor speed then on startup, there will be no back emf generated. This will have consequences on the current, which will be drawn by the coils, and some measures will have to be taken to counteract this effect. This topic will be considered later.

Armature Torque

The force on a current carrying conductor is given as

$$F = BLI \quad (20.17)$$

where B is the magnetic flux density under a pole, I is the current flowing in the conductor, and L is the axial length of the conductor.

The torque on one armature conductor is, therefore,

$$T = Fr = B_{av} LI_a r \quad (20.18)$$

where r is the radius of the armature conductor about the center of rotation, I_a is the current flowing in the armature conductor, L is the axial length of the conductor, and B_{av} is the average flux density under a pole.

Given that $B_{av} = \Phi / [(2\pi rL)/2p]$, the resultant torque per conductor is

$$T = \frac{\Phi 2p LI_a r}{2\pi rL} = \frac{\Phi p I_a}{\pi} \quad (20.19)$$

For Z_s armature conductors connected in series, the total torque (in Nm) on the armature is given by

$$T = \frac{\Phi p I_a Z_s}{\pi} \quad (20.20)$$

Terminal Voltage

Denoting the terminal voltage by V , in normal running conditions we have a balanced electrical system where:

$$V = E + I_a R_a \quad (20.21)$$

Since the number of poles and number of armature conductors are fixed, then from Eq. (20.16) we have a proportionality relationship between the speed, the induced emf, and the magnetic flux, i.e.,

$$N \propto \frac{E}{\Phi} \quad (20.22)$$

Using Eq. (20.21)

$$N \propto \frac{(V - I_a R_a)}{\Phi} \quad (20.23)$$

Since the value of $I_a R_a$ is normally less than about 5% of the terminal voltage then to a reasonable approximation

$$N \propto \frac{V}{\Phi} \quad (20.24)$$

Similarly Eq. (20.19) provides a proportionality relationship between the torque, the armature current, and the magnetic flux, i.e.,

$$T \propto I_a \Phi \quad (20.25)$$

Equation (20.24) shows that the speed of the motor is directly proportional to the applied voltage and inversely proportional to the magnetic flux. All methods of speed control for dc motors are based on this proportionality relationship.

Equation (20.25) indicates that the torque of a given dc motor is directly proportional to the product of the armature current and the flux per pole. It is obvious therefore that speed control methods which are based on altering the magnetic flux will also have an effect on the output torque.

Methods of Connection

The Shunt-Wound Motor

The shunt-wound motor (Fig. 20.58) is wired such that the armature and field coils are connected in parallel with the supply.

Under normal operating conditions, the field current will be constant. As the armature current increases, the armature reaction effect will weaken the field and the speed will tend to increase. However, the induced voltage will decrease due to the increasing armature voltage drop and this will tend to decrease the speed. The two effects are not self cancelling and overall the motor speed will fall slightly as the armature current increases.

The motor torque increases approximately linearly with the armature current until the armature reaction starts to weaken the field. These general characteristics are shown in Fig. 20.59 where it can also be seen that no torque is developed until the armature current is large enough to overcome the constant losses in the machine. Figure 20.60 shows the derived torque-speed characteristic.

Since the torque increases dramatically for a slight decrease in speed, the shunt-wound motor is particularly suitable for driving equipment like pumps, compressors, and machine tool elements where the speed must remain “constant” over a wide range of load conditions.

The Series-Wound Motor

The series-wound motor is shown in Fig. 20.61. As the load current increases, the induced voltage, E , will decrease due to the armature and field resistance drops. Because the field winding is connected in series with the armature, the flux is directly proportional to the armature current. Equation (20.24) therefore

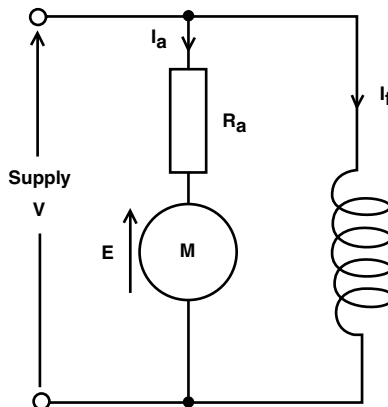

FIGURE 20.58 The shunt-wound motor.

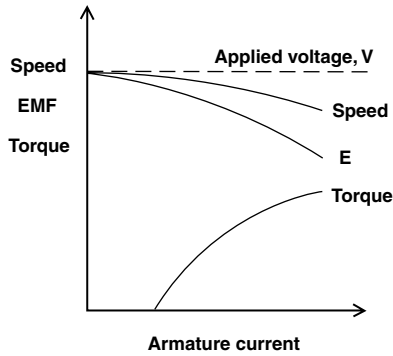

FIGURE 20.59 The shunt-wound motor load characteristics.

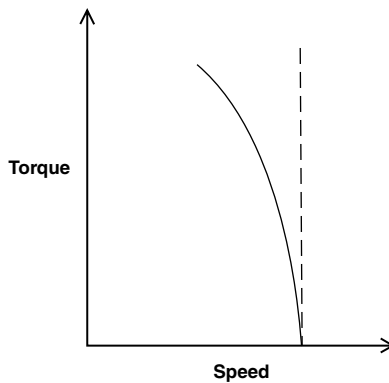

FIGURE 20.60 The shunt-wound torque–speed characteristics.

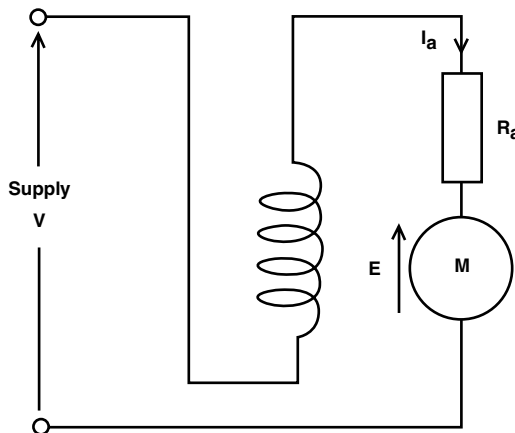

FIGURE 20.61 The series-wound motor.

suggests that the speed–armature current characteristic will take the form of a hyperbola. Similarly, Eq. (20.25) indicates that the torque–armature current characteristic will be approximately parabolic. These general characteristics are illustrated in Fig. 20.62, along with the derived torque–speed characteristic in Fig. 20.63. The general characteristics indicate that if the load falls to a particularly low value

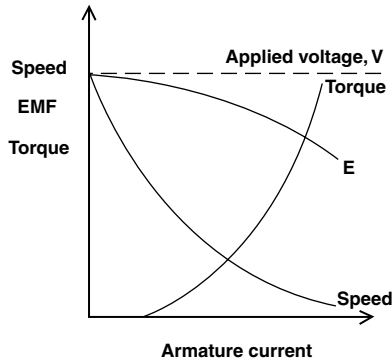

FIGURE 20.62 The series-wound motor load characteristics.

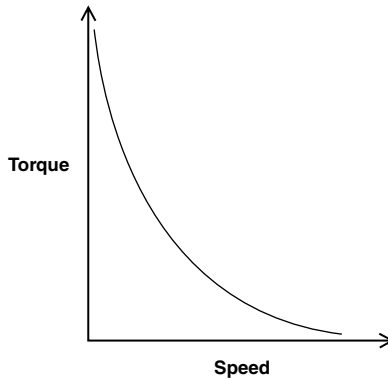

FIGURE 20.63 The series-wound motor torque-speed characteristics.

then the speed may become dangerously high. A series-wound motor should never be used, therefore, in situations where the load is likely to be suddenly relaxed.

The main advantage of the series-wound motor is that it provides a large torque at low speeds. Series-wound motors are eminently suitable, therefore, for applications where a large starting torque is required. This includes, for example, lifts, hoists, cranes, and electric trains.

The Compound-Wound Motor

Compound-wound motors are produced by including both series and shunt fields. The resulting characteristics of the compound-wound motor fall somewhere in between those of the series-wound and the shunt-wound machines.

Starting dc Motors

With the armature stationary, the induced emf is zero. If while at rest, the full voltage is applied across the armature winding then the current drawn would be massive. A typical 40-kW motor might have an armature resistance of about 0.06Ω . If the applied voltage is 240 V, the current drawn is 4000 A. This current would undoubtedly blow the fuses and thereby cut off the supply to the machine. To limit the starting current a variable external resistance is connected in series with the armature. On start-up the full resistance is connected in series. As the machine builds up speed and increases the back emf, the external resistance can be reduced until at rated speed the series resistance is disconnected. Alternatively, a series resistance can be momentarily activated in conjunction with the starter switch.

Speed Control of dc Motors

Equation (20.24) shows that the speed of a dc motor is influenced both by the applied voltage and the magnetic flux. A change in either one of these parameters will therefore effect a change in the motor speed.

Field Regulator

For shunt-wound and compound-wound motors a variable resistor, called a “field regulator,” can be incorporated in series with the field winding to reduce the flux. For the series-wound motor the variable resistor is connected in parallel with the field winding and is called a “diverter.” Figures 20.64–20.66 show the various methods of weakening the field flux for shunt-, compound-, and series-wound motors.

In all of the above methods, the flux can only be reduced and from Eq. (20.24) this implies that the speed can only be increased above the rated speed. The speed may in fact be increased to about three or four times the rated speed. The increased speed, however, is at the expense of reduced torque since the torque is directly proportional to the flux which is being reduced.

Variable Armature Voltage

Alternatively, the speed can be increased from standstill to rated speed by varying the armature voltage from zero to rated value. Figure 20.67 illustrates one method of achieving this.

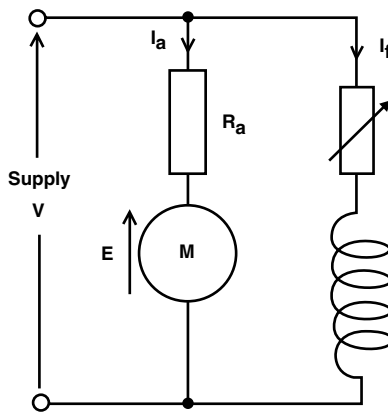

FIGURE 20.64 Speed control by flux reduction: shunt-wound motor.

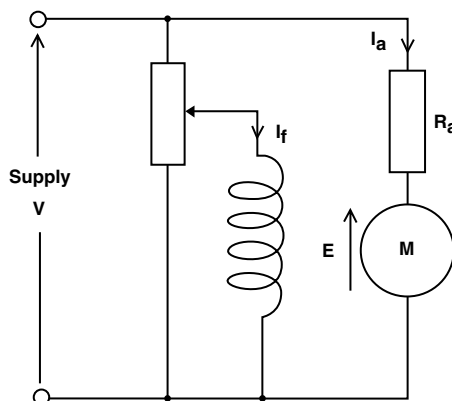

FIGURE 20.65 Speed control by flux reduction: compound-wound motor.

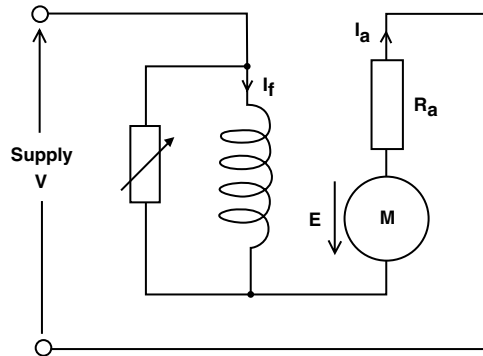

FIGURE 20.66 Speed control by flux reduction: series-wound motor.

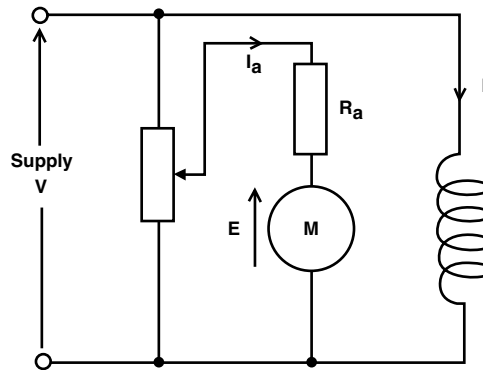

FIGURE 20.67 Speed control by varying the armature voltage.

The potential divider carries the same current as the motor, and this limits this method of speed control to small machines. Additionally much of the input energy is dissipated in the variable resistance, which consequently renders the system inefficient.

Ward Leonard Drive

In this case the variable dc voltage for the speed controlled motor is obtained from a separate dc generator, which is in itself driven by an induction motor.

The field coil for the dc generator is supplied from a center-zero potential divider. When the wiper arm is in the center position, the speed controlled motor is at a standstill. By moving the wiper arm away from the center position the speed of the motor is increased in either clockwise or anti-clockwise direction. The Ward Leonard drive is smooth and accurate in either direction and also provides for very responsive braking. The complexity, however, makes it a very expensive system, and it is only used in high quality applications.

Chopper Control

Figure 20.68 shows a thyristor circuit connected in series with the armature of a dc motor. The thyristor circuit is triggered such that it operates essentially as a high speed ON/OFF switch. The output waveform across the armature terminals is depicted in Fig. 20.69. The ratio of time on to time off, i.e., the “mark/space ratio,” can be varied with the result that the average voltage supplied to the armature is effectively varied between zero and fully on. The frequency of the signal may be up to about 3 kHz and the timing circuit is quite complex. Speed control of dc motors using thyristors, however, is effective and relatively inexpensive.

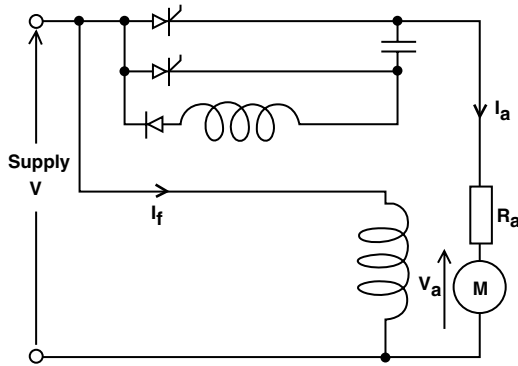

FIGURE 20.68 Speed control using thyristors.

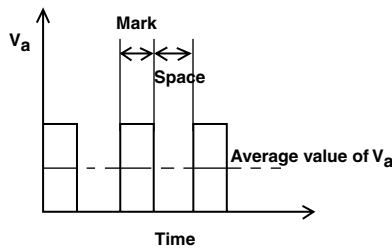

FIGURE 20.69 Voltage across armature terminals.

Efficiency of dc Machines

The losses in dc machines can be generally classified as

1. **Armature losses:** This is the I^2R loss in the armature winding, often referred to as the “copper loss.”
2. **Iron loss:** This loss is attributable to magnetic hysteresis and eddy currents in the armature and field cores.
3. **Commutator losses:** This loss is related to the contact resistance between the commutator brushes and segments. The total commutator loss is due to both mechanical friction and a voltage loss across the brushes.
4. **Excitation loss:** In shunt-wound machines, this power loss is due to the product of the shunt current and the terminal voltage.
5. **Bearing friction and windage:** Bearing friction is approximately proportional to the speed, but windage loss varies with the cube of the speed. Both of these losses are fairly minor unless the machine is fitted with a cooling fan, in which case the windage loss can be quite significant.

Despite the variety and nature of the losses associated with dc machines, they have nonetheless a very good performance with overall efficiencies, often in excess of 90%.

AC Machines

Synchronous Motors

Synchronous motors are so called because they operate at only one speed, i.e., the speed of a rotating magnetic field. The production of the rotating magnetic field may be actioned using three, 120° displaced, stator coils supplied with a three-phase current. The rotational speed of the field is related to the frequency

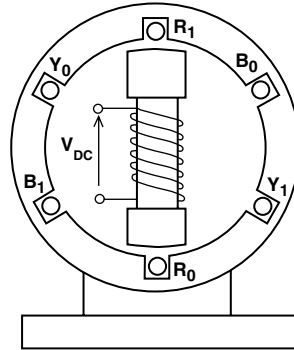

FIGURE 20.70 Simple synchronous motor.

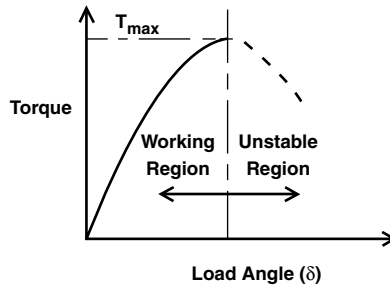

FIGURE 20.71 Torque characteristic for a synchronous motor.

of the currents.

$$N_s = \frac{60f}{\text{number of pole pairs}} \quad (20.26)$$

where N_s is the speed of the field in revolutions per minute and f is the frequency of the supply currents.

The mechanical construction is shown in Fig. 20.70. The rotor field is supplied from a dc source and the stator coils are supplied with a three-phase current. The rotating magnetic field is induced by the stator coils and the rotor, which may be likened to a permanent bar magnet, aligns itself to the rotating flux produced in the stator. When a mechanical load is driven by the shaft, the field produced by the rotor is pulled out of alignment with that produced by the stator. The angle of misalignment is called the “load angle.” The characteristics of synchronous motors are normally presented in terms of torque against load angle, as shown in Fig. 20.71.

The torque characteristic is basically sinusoidal with

$$T = T_{\max} \sin \delta \quad (20.27)$$

where T_{\max} is the maximum rated torque and δ is the load angle.

It is evident from Eq. (20.27) that synchronous motors have no starting torque and the rotor must be run up to synchronous speed by some alternative means. One method utilizes a series of short-circuited copper bars inserted through the outer extremities of the salient poles. The rotating magnetic flux induces currents in these “grids” and the machine accelerates as if it were a cage-type induction motor, see following section. A second method uses a wound rotor similar to a slip-ring induction motor. The machine is run up to speed as an induction motor and is then pulled into synchronism to operate as a synchronous motor.

The advantages of the synchronous motor are the ease with which the power factor can be controlled and the constant rotational speed of the machine, irrespective of the applied load. Synchronous motors,

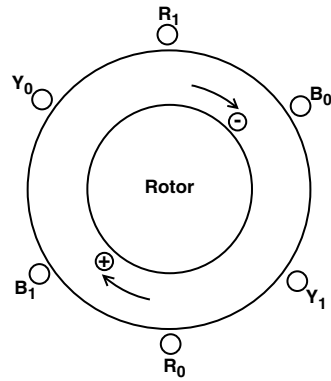

FIGURE 20.72 Schematic representation of an induction motor.

however, are generally more expensive and a dc supply is a necessary feature of the rotor excitation. These disadvantages coupled with the requirement for an independent starting mode make synchronous motors much less common than induction motors.

Induction Motors

The stator of an induction motor is much like that of an alternator and in the case of a machine supplied with three-phase currents, a rotating magnetic flux is produced. The rotor may be either of two basic configurations, which are the “squirrel cage” or the slip-ring type. In the squirrel cage motor the rotor core is laminated and the conductors consist of uninsulated copper, or aluminium, bars driven through the rotor slots. The bars are brazed or welded at each end to rings or plates to produce a completely short-circuited set of conductors. The slip-ring machine has a laminated core and a conventional three-phase winding, similar to the stator, and connected to three slip-rings on the locating shaft. [Figure 20.72](#) shows a schematic representation of an induction motor having three stator coils displaced by 120°.

If the stator coils are supplied with three-phase currents, a rotating magnetic field is produced in the stator. Consider the single rotor coil shown in the figure. At standstill the rotating field will induce a voltage in the rotor coil since there is a rate of change of flux linking the coil. If the coil forms a closed circuit, the induced emf will circulate a current in the coil. The resultant force on the current carrying conductor is a consequence of Eq. (20.17) and this will produce a torque, which will accelerate the rotor. The rotor speed will increase until the electromagnetic torque is balanced by the mechanical load torque. The induction motor will never attain synchronous speed because if it did there would be no relative motion between the rotor coils and the rotating field. Under these circumstances there would be no emf induced in the rotor coils and subsequently no electromagnetic torque. Induction motors, therefore, always run at something less than synchronous speed. The ratio of the difference between the synchronous speed and the rotor speed to the synchronous speed is called the “slip”; i.e.,

$$s = \frac{N_s - N}{N_s} \quad (20.28)$$

The torque–slip characteristic is shown in [Fig. 20.73](#). With the rotor speed equal to the synchronous speed, i.e., $s = 0$, the torque is zero. As the rotor falls below the synchronous speed the torque increases almost linearly to a maximum value dictated by the total of the load torque and that required to overcome the rotor losses. The value of slip at full load varies between 0.02 and 0.06. The induction motor may be regarded as a constant speed machine. The difficulties, in fact, of varying the speed constitute one of the induction motor’s main disadvantages.

On start-up, the slip is equal to unity and the starting torque is sufficiently large enough to accelerate the rotor. As the rotor runs up to its full load speed the torque increases in essentially inverse proportion to the slip. The start-up and running curves merge at the full load position.

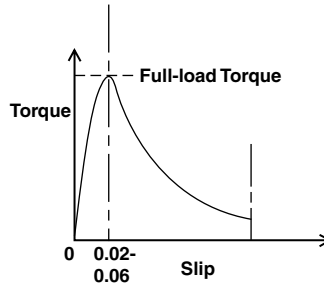

FIGURE 20.73 Torque–slip characteristic for an induction motor.

Starting Induction Motors

As with dc motors, the current drawn during starting of ac motors is very large, up to about five times full load current. A number of devices are therefore employed to limit the starting current but they all involve the use of auxiliary equipment, which is usually quite expensive.

Star-Delta Starter

With the machine at standstill and the starter in the “start” position, the stator coils are connected in the star pattern. As the machine accelerates up to running speed, the switch is quickly moved over to the “run” position, which reconnects the stator windings in the delta pattern. By this simple expedient, the starting supply current is reduced to about one third of what it would have been had the stator windings been connected up in the delta pattern on start-up.

Autotransformer Starter

The autotransformer represents an alternative method of reducing the starting current drawn by an induction motor. The autotransformer incorporates a star connection, which is supplied from a mid-point tapping on each phase. The voltage supplied to the stator is, therefore, one half of the supply voltage. With such an arrangement the supply current and the starting torque are both only one quarter of the values, which would be applied to the motor when the full voltage is supplied. After the motor has accelerated, the starter device is moved to the “run” position thereby connecting the motor directly across the supply and opening the star-connection of the autotransformer. Unfortunately, the starting torque is also reduced and the device is generally expensive since it has to have the same rating as the motor.

Rotor Resistance

With slip-ring induction motors, it is possible to include additional resistance in series with the rotor circuit. The inclusion of extra resistance in the rotor provides for reduced starting current and improved starting torque.

Braking Induction Motors

Induction motors may be brought to a standstill by either “plugging” or by “dynamic braking.”

1. **Plugging:** This is a technique where the direction of the rotating magnetic field is reversed. This is brought about by reversing any two of the supply leads to the stator. The current drawn during plugging is very large, and machines which are regularly plugged must be specially rated.
2. **Dynamic braking:** In this braking method the stator is disconnected from the ac supply and reconnected to a dc source. The direct current in the stator produces a stationary unidirectional field and as the rotor will always tend to align itself with the field, it will therefore come to a standstill.

Speed Control of Induction Motors

Under normal circumstances, the running speed of an induction motor will be about 94–98% of the synchronous speed, depending on the load. With the synchronous speed given by Eq. (20.26), it is clear that the speed may be varied either by changing the frequency of the supply current, or by changing the number of poles.

Change of Supply Current Frequency

Solid state variable-frequency drives first began to appear in 1968. They were originally applied to the control of synchronous ac motors in the synthetic fiber industry and rapidly gained acceptance in that particular market. In more recent times they have been used in applications to pumping, synchronized press lines, conveyor lines, and to a lesser extent in the machine-tool industry as spindle drives. Modern ac variable-frequency motors are available in power ratings ranging from 1 to 750 kW and with speed ranges from 10/1 to 100/1.

The synchronous and squirrel cage induction motors are the types most commonly used in conjunction with solid-state, adjustable frequency inverter systems. In operation the motor runs at, or near, the synchronous speed determined by the input current frequency. The torque available at low speed, however, is decreased and the motor may have to be somewhat oversized to ensure adequate performance at the lower speeds. The most advanced systems incorporate a digital tachogenerator to supply a corrective feedback signal which is compared against a reference frequency. This gives a speed regulation of about 3%. Consequently, the ac variable-frequency drive is generally used only for moderate to high power velocity control applications, where a wide range of speed is not required. The comparative simplicity of the ac induction motor is usually sacrificed to the complexity and cost of the control electronics.

Change of Number of Poles

By bringing out the ends of the stator coils to a specially designed switch it becomes possible to change an induction motor from one pole configuration to another. To obtain three different pole numbers, and hence three different speeds, a fairly complex switching device would be required.

Changing the number of poles gives a discrete change in motor speed with little variation in speed over the switched range. For many applications, however, two discrete speeds are all that is required and changing the number of poles is a simple and effective method of achieving this.

Changing the Rotor Resistance

For slip-ring induction motors additional resistance can be coupled in series with the rotor circuit. It has already been stated that this is a common enough method used to limit the starting current of such machines. It can also be used as a method of marginal speed control. Figure 20.74 shows the torque characteristics of a slip-ring induction motor for a range of different resistances connected in series with the rotor windings.

As the external resistance is increased from R_1 to R_3 , a corresponding reduction in speed is achieved at any particular torque. The range of speeds is increased at the higher torques.

The method is simple and therefore inexpensive, but the reduction in speed is accompanied with a reduction in overall efficiency. Additionally, with a large resistance in the rotor circuit, i.e., R_3 , the speed changes considerably with variations in torque.

Reduced Stator Voltage

By reducing the applied stator voltage a family of torque-speed characteristics are obtained, as shown in Fig. 20.75. It is evident that as the stator voltage is reduced from V_1 to V_3 , a change in speed is effected

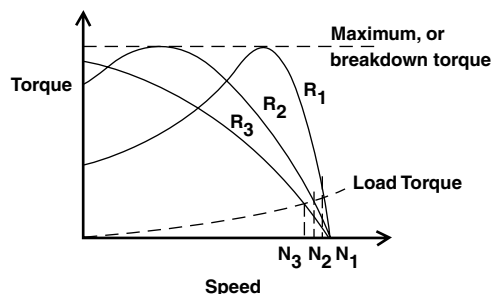

FIGURE 20.74 Torque-speed characteristics for various rotor resistances.

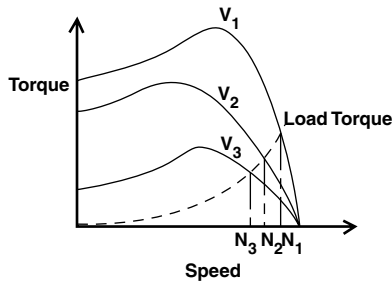

FIGURE 20.75 Torque–speed characteristics for various stator voltages.

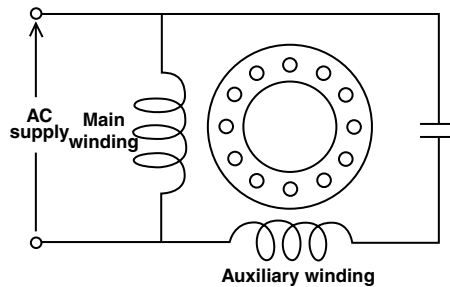

FIGURE 20.76 Capacitor motor.

at any particular value of torque. This is provided, of course, that the torque does not exceed the maximum load torque available at the reduced stator voltage. This latter point is obviously a limiting factor, which places a constraint on this method of speed control. Generally only very small speed ranges can be obtained using variable stator supply voltage.

Single-Phase Induction Motors

The operation of an induction motor depends upon the creation of a rotating magnetic field. A single stator coil cannot achieve this and all of the so-called single-phase induction motors use some or other external means of generating an approximation to a two-phase stator supply. Two stator coils are, therefore, used and these are displaced by 90° . Ideally the currents which supply each coil should have a phase difference of 90° . This then gives the two-phase equivalent of the three-phase induction motor.

The Shaded Pole Motor

The stator of the shaded pole motor consists of a salient pole single-phase winding and the rotor is of the squirrel cage type. One half of the stator features a copper “shading ring.” When the exciting coil is supplied with alternating current, the flux produced induces a current in the shading ring. The phase difference between the currents in the exciting coil and the shading ring is relatively small and the rotating field produced is far from ideal. In consequence the shaded pole motor has a poor performance and an equally poor efficiency due to the continuous losses in the shading rings. Shaded pole motors have a low starting torque and are used only in light duty applications such as small fans and blowers or other easily started equipment. Their advantage lies in their simplicity and low cost of manufacture.

The Capacitor Motor

The stator has two windings physically displaced by 90° . A capacitor is connected in series with the auxiliary winding such that the currents in the two windings have a large phase displacement (see Fig. 20.76). The current phase displacement can be made to approach the ideal 90° , and the performance of the capacitor motor closely resembles that of the three-phase induction motor.

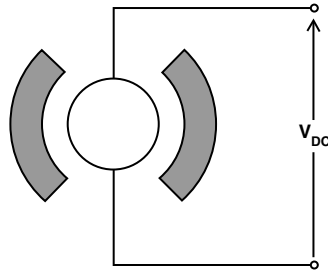

FIGURE 20.77 A dc permanent magnet motor.

The Universal Motor

These are small dc series-wound motors that operate at about the same speed and power on direct current, or on single-phase current with approximately the same root mean square voltage. If alternating current is supplied, the stator and rotor field strengths vary sinusoidally in magnitude but with the same phase relationship. As the applied voltage changes polarity, so do the armature and field currents. Equation (20.25) suggests that under these conditions the applied torque will not reverse polarity and will remain at all times positive. The universal, or plain-series motor, is used mainly in small domestic appliances such as hair dryers, electric drills, vacuum cleaners, hedge trimmers, etc.

The dc Permanent Magnet (PM) Motor

The dc permanent magnet (PM) motor is a continuous rotation electromagnetic actuator that can be directly coupled to its load. Figure 20.77 shows the schematic representation of a PM motor. The PM motor consists of an annular brush ring assembly, a permanent magnet stator ring, and a laminated wound rotor. They are particularly suitable for servo systems where size, weight, power, and response times must be minimized and where high position and rate accuracies are required.

The response times for PM motors are very fast and the torque increases directly with the input current, independently of the speed or the angular position. Multiple pole machines maximize the output torque per watt of rotor power. Commercial PM motors are available in many sizes from 35 mN m at about 25 mm diameter to 13.5 N m at about 3 m diameter.

Direct drive rate and position systems using PM motors utilize dc tachogenerators and position sensors in various forms of closed-loop feedback paths for control purposes.

The Stepper Motor

A stepper motor is a device that converts a dc voltage pulse train into a proportional mechanical rotation of its shaft. In essence, stepper motors are a discrete version of the synchronous motor. The discrete motion of the stepper motor makes it ideally suited for use with a digitally based control system such as a microcontroller. The speed of a stepper motor may be varied by altering the rate of the pulse train input. Thus, if a stepper motor requires 48 pulses to rotate through one complete revolution, then an input signal of 96 pulses per second will cause the motor to rotate at 120 rev/min. The rotation is actually carried out in finite increments of time; however, this is visually indiscernible at all but the lowest speeds.

Stepper motors are capable of driving a 2.2-kW load with stepping rates from 1000 to 20,000 per second in angular increments from 180° down to 0.75°.

There are three basic types of stepper motor, viz.

1. **Variable reluctance:** This type of stepper motor has a soft iron multi-toothed rotor with a wound stator. The number of teeth on the rotor and stator, together with the winding configuration and excitation determines the step angle. This type of stepper motor provides small to medium sized step angles and is capable of operation at high stepping rates.
2. **Permanent magnet:** The rotor used in the PM type stepper motor consists of a circular permanent magnet mounted onto the shaft. PM stepper motors give a large step angle ranging from 45° to 120°.

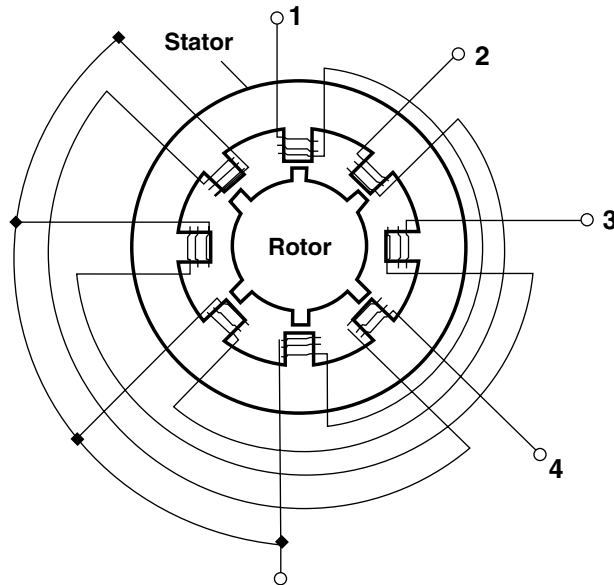

FIGURE 20.78 Variable reluctance stepper motor.

3. **Hybrid:** The hybrid stepper motor is a combination of the previous two types. Typically the stator has eight salient poles, which are energized by a two-phase winding. The rotor consists of a cylindrical magnet, which is axially magnetized. The step angle depends on the method of construction and is generally in the range 0.9° – 5° . The most popular step angle is 1.8° .

The principle of operation of a stepper motor can be illustrated with reference to a variable reluctance, four-phase machine. This motor usually has eight stator teeth and six rotor teeth, see Fig. 20.78.

If phase 1 of the stator is activated alone, two diametrically opposite rotor teeth align themselves with the phase 1 teeth of the stator. The next adjacent set of rotor teeth in the clockwise direction are then 15° out of step with those of the stator. Activation of the phase 2 winding on its own, would cause the rotor to rotate a further 15° in the anti-clockwise direction to align the adjacent pair of diametrically opposite rotor teeth. If the stator windings are excited in the sequence 1, 2, 3, 4, then the rotor will move in consecutive 15° steps in the anti-clockwise direction. Reversing the excitation sequence will cause a clockwise rotation of the rotor.

Stepper Motor Terminology

Pull-out torque: The maximum torque that can be applied to a motor, running at a given stepping rate, without losing synchronism.

Pull-in torque: The maximum torque against which a motor will start, at a given pulse rate, and reach synchronism without losing a step.

Dynamic torque: The torque developed by the motor at very slow stepping speeds.

Holding torque: The maximum torque that can be applied to an energized stationary motor without causing spindle rotation.

Pull-out rate: The maximum switching rate at which a motor will remain in synchronism while the switching rate is gradually increased.

Pull-in rate: The maximum switching rate at which a loaded motor can start without losing steps.

Slew range: The range of switching rates between pull-in and pull-out in which a motor will run in synchronism but cannot start or reverse.

The general characteristics of a typical stepper motor are given in Fig. 20.79.

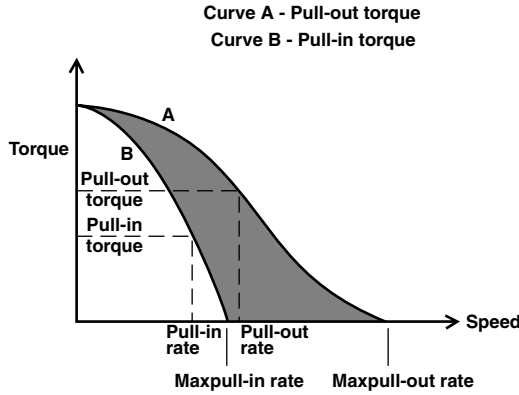

FIGURE 20.79 Stepper motor characteristics.

During the application of each sequential pulse, the rotor of a stepper motor accelerates rapidly towards the new step position. However, on reaching the new position there will be some overshoot and oscillation unless sufficient retarding torque is provided to prevent this happening. These oscillations can cause rotor resonance at certain pulse frequencies resulting in loss of torque, or perhaps even pull-out conditions. As variable reluctance motors have very little inherent damping, they are more susceptible to resonances than either of the permanent magnet, or the hybrid types. Mechanical and electronic dampers are available, which can be used to minimize the adverse effects of rotor resonance. If at all possible, the motor should be selected such that its resonant frequencies are not critical to the application under consideration.

Owing to their unique characteristics, stepper motors are widely used in applications involving positioning, speed control, timing, and synchronized actuation. They are prevalent in X-Y plotters, floppy disc head drives, printer carriage drives, numerically controlled machine tool slide drives, automatic teller machines, and camera iris control mechanisms.

By far the most severe limitation on the purely electric stepper motor is its power handling capability. Currently this is restricted to about 2.25 kW.

Brushless dc Motors

These motors have position feedback of some kind so that the input waveforms can be kept in the proper timing with respect to the rotor position. Solid-state switching devices are used to control the input signals and the brushless dc motor can be operated at much higher speeds with full torque available at those speeds. The brushless motor can normally be rapidly accelerated from zero to operating speed as a PM motor. On reaching operating speed, the motor can then be switched over to synchronous operation.

The brushless motor system consists of a wound stator, a permanent magnet rotor, a rotor position sensor, and a solid state switching assembly. The wound stator can be made with two or more input phases. Figure 20.80 gives the schematic representation of a two-phase brushless motor.

The torque output of phase A is

$$T_A = I_A(Z\Phi/2\pi) \sin(p\theta/2) = I_A K_T \sin(p\theta/2) \quad (20.29)$$

where

- I_A = current in phase A,
- $K_T = (Z\Phi/2\pi)$ = torque constant of the motor,
- p = number of poles, and
- θ = angular position of the rotor.

In the expression for the torque constant, Z is the total number of conductors, and Φ is the magnetic flux.

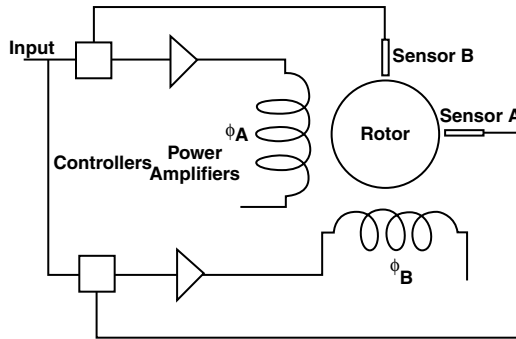

FIGURE 20.80 Two-phase brushless motor.

In a similar manner, the torque output of phase B is

$$T_B = I_B K_T \cos(p\theta/2) \tag{20.30}$$

If the motor currents are arranged to be supplied in the following relationships

$$I_A = I \sin(p\theta/2) \quad \text{and} \quad I_B = I \cos(p\theta/2)$$

then the total torque for a two-pole motor becomes

$$T = T_A + T_B = IK_T [\sin^2(p\theta/2) + \cos^2(p\theta/2)] = IK_T \tag{20.31}$$

Equation (20.31) shows that if all of the above conditions are satisfied then the brushless dc motor operates in a similar manner to the conventional dc motor, i.e., the torque is directly proportional to the armature current. Note that the armature current in this context refers to the stator windings. Excitation of the phases may be implemented with sinusoidal, or square wave inputs. The sine wave drive is the most efficient but the output transistors in the drive electronics must be capable of dissipating more power than that dissipated in square wave operation. Square wave drive offers the added advantage that the drive electronics can be digitally based. The brushless dc motor will duplicate the performance characteristics of a conventional dc motor only if it is properly commutated. Proper commutation involves exciting the stator windings in a sequence that keeps the magnetic field produced by the stator approximately 90 electrical degrees ahead of the rotor field. The brushless dc motor therefore relies heavily on the position feedback system for effective commutation. It might also be apparent that the brushless motor as described is not strictly a dc machine, but a form of ac machine with position feedback.

Motor Selection

For the mechatronics engineer the main concerns regarding electric motors will be those of selection for purpose. At the very least the motor must be capable of matching the power requirements of the driven load. In all cases, therefore, the motor power available should be enough to cope with the anticipated demands of the load. Other requirements are the need for the motor to have enough torque available on start-up to overcome the static friction, accelerate the load up to the working speed, and be able to handle the maximum overload. Too much excess motor torque on start-up might result in a violent initial acceleration. Some systems therefore require a “soft start” whereby the motor torque is gradually increased to allow the load to accelerate gently.

The operating speed of the motor will be fixed by the point at which the torque supplied by the motor is just balanced by the torque requirements of the load. At any other condition, the motor and load will be either accelerating or decelerating. Correct matching of a motor to a driven machine can only be confidently accomplished if both the motor and the load torque–speed characteristics are known. The motor torque–speed characteristics are usually provided by the supplier. The driven machine torque–speed characteristics can be something of an enigma.

Friction devices like industrial sanders, buffers, and polishing machines have a torque–speed characteristic that is initially very high, but drops sharply once motion is established. Continued acceleration usually sees the torque requirement of the load decrease further but at a slower rate than that at start-up. The difference between the static and dynamic friction accounts for this behavior.

Fans and blowers have a torque–speed characteristic that increases parabolically from zero as the speed increases. Such machines do not, therefore, need much motor torque to enable them to start.

High inertia devices like machine tool drives, rolling mills, and electric lifts require a large torque on start-up to overcome the inertia. Once motion is established the torque requirements tend to decrease with increasing speed. The series-wound dc motors are ideal for these types of loads.

This brief discussion of rotating electrical machines is in no way comprehensive. A fuller discourse on ac and dc machines is given both by Gray [1] and Sen [2]. Orthwein [3] presents an interesting practical discussion on the mechanical applications of ac and dc motors and Kenjo & Nagamori [4] provide a detailed in-depth study of permanent-magnet dc motors.

References

1. Gray, C. B. (1989), *Electrical Machines and Drive Systems*, Longmans Scientific and Technical, Harlow.
2. Sen, P. C. (1989), *Principles of Electric Machines and Power Electronics*, Wiley, Chichester.
3. Orthwein, W. (1990), *Machine Component Design*, West Publishing, St Paul, Minnesota.
4. Kenjo, T. & Nagamori, S. (1985), *Permanent Magnet and Brushless dc Motors*, Monographs in Electrical & Electronic Engineering, Clarendon Press, Oxford.

20.3 Piezoelectric Actuators

Ramutis Bansevicius and Rymantas Tadas Tolocka

Piezoeffect Phenomenon

Piezoelectric effect was discovered by brothers Curie in 1880 [1]. The direct piezoelectric effect consists in ability of certain materials to generate electric charge in proportion to externally applied force. The inverse piezoelectric effect of these materials consists in their expansion under the action of electric field parallel to the direction of polarization. Effects are lasting if force or electric field is acting. Effects have been used for actuating/sensing functions in engineering applications.

Constitutive Equations

Coupled electric and mechanical constitutive equations of piezoelectric materials for one dimension medium are

$$S = s^E T + dE \quad (20.31)$$

$$D = \epsilon^T E + dT \quad (20.32)$$

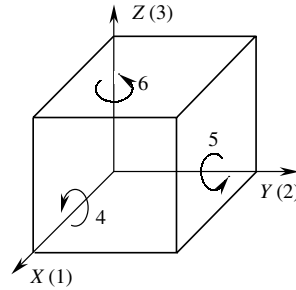

FIGURE 20.81

here S is strain (m), T is stress (N/m^2), E is electric field (V/m), D is dielectric displacement (charge per unit area (C/m^2)), s^E is the compliance of the material (m^2/N) when electric field is constant, ϵ^T is the permittivity (F/m) under constant stress, and d is piezoelectric constant (m/V or C/N).

First members on the right side of the equations refer to the mechanical properties of an elastic body (Eq. (20.31)) and to electric properties of a dielectric medium (Eq. (20.32)). Artificial piezoelectric materials obtain remnant polarization in the process of poling. Polarization direction coincides with one of the poling electric fields. This direction is referred by convention to the axis Z of orthogonal axes X , Y , Z system. Indexes 1, 2, and 3 are prescribed to these axes, respectively. Piezoelectric properties of piezoelectric materials depend on directions of electrical and mechanical inputs/outputs and are identical along axes 1 and 2. Thus these properties are described by constants with two subscripts, first of which is related to electrical and second to mechanical direction. Subscripts 4, 5, and 6 are used additionally for describing shear distortions in respect to the directions 1, 2, and 3 (Fig. 20.81). Indexes show possible piezo materials operation mode—thickness expansion, transverse expansion, thickness shear, and face shear. The mode of motion depends on the shape and orientation of the body relative to crystal axes and the location of electrodes. Poling electric field direction causes elongation in this direction and contraction in the perpendicular ones. The reverse field causes contraction along the electric field direction and elongation in perpendicular directions. Mode d_{33} gives three times larger displacement than mode d_{31} . Main constants characterizing the piezoeffect are:

- d_{ij} (piezoelectric constant)—strain or charge coefficients expressed in M/V or C/N (according to sensor/actuator piezomaterial properties). They relate to the strain developed by electric field E in the absence of mechanical stress (Eq. (20.31)), and to the electric charge per unit area by the applied stress under zero electric field (Eq. (20.32)). Example: symbol d_{31} means that electrodes are perpendicular to the axis 3 (electric field along it) and stress or strain is along axis 1.
- g_{ij} —voltage or field output coefficients relate to open circuit electric field developed per applied mechanical stress or strain developed per applied charge density and is expressed in $\text{V m}/\text{N}$. The relation between d_{ij} and g_{ij} is as follows:

$$g_{ij} = \frac{d_{ij}}{\epsilon^T} \quad (20.33)$$

- k_{ij} (coupling factors)—energy ratios describing conversion from mechanical to electrical energy and vice versa. Factor k^2 is the ratio of stored converted energy to input energy at operating frequencies far from resonant.

$$k^2 = \frac{d^2}{s^E \epsilon^T} \quad (20.34)$$

Factor k_p refers to the plane mode operation (strain or stress is equal in all directions perpendicular to axis 3).

TABLE 20.4 Properties of Piezomaterials

| Parameter | Units | Pz26 | Pz27 | Pz29 |
|--|-------------------|------------------------|------------------------|------------------------|
| Relative dielectric constant, K_{33}^T | — | 1.300 | 1.800 | 2.900 |
| Dielectric dissipation factor, $\tan \delta$ | — | 0.003 | 0.017 | 0.019 |
| Curie temperature, T_c | °C | 330 | 350 | 235 |
| Coupling factor, k_p | — | 0.57 | 0.59 | 0.64 |
| Coupling factor, k_{31} | — | 0.33 | 0.33 | 0.37 |
| Coupling factor, k_{33} | — | 0.68 | 0.71 | 0.75 |
| Charge coefficient, d_{31} | m/V | -130×10^{-12} | -170×10^{-12} | -240×10^{-12} |
| Charge coefficient, d_{33} | m/V | 290×10^{-12} | 425×10^{-12} | 575×10^{-12} |
| Voltage coefficient, g_{31} | V m/N | -11×10^{-3} | -11×10^{-3} | -10×10^{-3} |
| Voltage coefficient, g_{33} | V m/N | 28×10^{-3} | 27×10^{-3} | 23×10^{-3} |
| Frequency constant, N_p | Hz m | 2.230 | 2.010 | 1.970 |
| Frequency constant, N_t | Hz m | 2.040 | 1.950 | 1.960 |
| Elastic compliance, s_{11}^E | m ² /N | 13×10^{-12} | 17×10^{-12} | 17×10^{-12} |
| Elastic compliance, s_{33}^E | m ² /N | 20×10^{-12} | 23×10^{-12} | 23×10^{-12} |
| Elastic compliance, s_{11}^D | m ² /N | 12×10^{-12} | 15×10^{-12} | 15×10^{-12} |
| Elastic compliance, s_{33}^D | m ² /N | 11×10^{-12} | 12×10^{-12} | 10×10^{-12} |
| Young modulus | Pa | 4.5×10^{-12} | 4.5×10^{-12} | 4.7×10^{-12} |
| Poison ratio | — | 0.33 | 0.39 | 0.34 |

Other important constants are the Young modulus, relative dielectric constant (ratio of the dielectric permittivity of the material to the dielectric permittivity in vacuum), dielectric dissipation factor (the dielectric loss factor in the material, expressed as tangent of loss angle), Curie temperature (the temperature at which a piezomaterial becomes completely depolarized), etc.

Piezomaterials

Materials that exhibit a significant and useful piezoelectric effect fall into three main groups: natural (quartz, Rochelle salt) and synthetic crystals (lithium sulfate, ammonium dihydrogen phosphate), polarized ferroelectric ceramics, and certain polymer films. The main piezomaterial for engineering applications is ferroelectric ceramics, Lead Zirconate Titanate (PZT) especially. The latter is characterized by high coupling factors, and piezoelectric and dielectric constants over extended temperature and stress ranges. Barium titanate, lead magnesium niobate, modified lead titanate, and bismuth titanate compounds are used as well as other special compositions. Because of their natural asymmetric structure, crystal materials exhibit the effect without further processing. However, ferroelectric ceramics must be artificially polarized by a strong electric field while the material is heated above its Curie point and then slowly cooled with field applied. Remnant polarization being retained, the material exhibits the piezoeffect. Piezopolymers—polyvinylidene fluorides (PVDF or PVF2)—are a special class of fluoropolymer that exhibit a high degree of piezoelectric activity. They are used for manufacturing piezofilms of low thickness (less than 30 μm), which may be laminated on the structural materials.

Table 20.4 shows some properties of typical PZT bulk piezomaterials produced by Ferroperm Piezoceramics [6].

Piezoactuating Elements

Piezoactuating elements in a wide range of sizes are produced as squares, rectangles, rings, discs, spheres, hemispheres, bars and cylinders, and special elements. Typical thickness is from 20 μm to 15 mm and up to 100 mm length or external diameter. Due to unique properties of the material—quick response, high stiffness, low power consumption, and high electromechanical conversion efficiency—they can be used directly as actuators. The piezoeffect is linearly dependant on the applied electric field; its strength in the range 1–2 kV/mm is available and depends on piezomaterial short circuit resistance. Control voltage

TABLE 20.5 Resonant Frequency Expressions for Various Piezoelements

| Operating Mode | Expression (L , length; D , diameter; T , width) |
|---------------------------|---|
| Transverse mode, thin bar | $N_1 = f_r \times L$ |
| Radial mode, disc | $N_p = f_r \times D$ |
| Thickness mode, disc | $N_t = f_r \times T$ |
| Length mode, cylinder | $N_s = f_r \times L$ |
| Shear mode, plate | $N_s = f_r \times T$ |

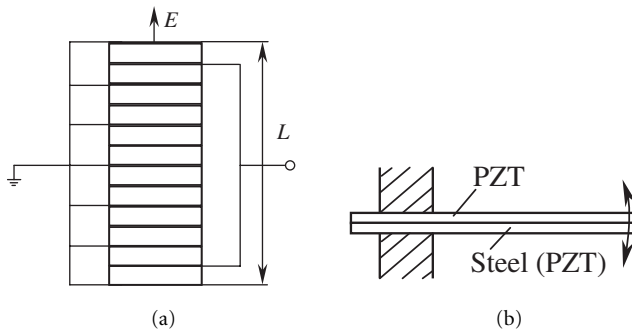

FIGURE 20.82

depends on the thickness of the layer of piezomaterial. Maximum possible relative change in length is up to 0.13%. The shortest time of expansion is one third of the period at resonant frequency oscillations of the mechanical system containing piezoelement. Piezoelement resonant properties are described by frequency constant N_f , which is the resonance frequency f_r multiplied by the linear dimension governing the resonance. Table 20.5 shows the expressions for various operating modes.

Voltage being changed (V remains constant after the change), piezomaterial continues to expand/contract in the same direction, decaying exponentially towards stability. This drift, known as creep, can be estimated by

$$\Delta L(t) = \Delta L(1 + \gamma \lg 0.1) \quad (20.35)$$

where ΔL is 0.1 s expansion after the positioning process, γ is the drift factor. It depends on the design and mechanical load and lies between 0.01 and 0.02. Hysteresis is common in the piezomaterials as well. PZT hysteresis is a fairly constant fraction of the stroke and the width of the hysteresis curve for it can be as large as 20% of the stroke. Due to compensation strategies hysteresis errors decrease up to 3%. Piezoelement with electrodes laminated on to it is electrical capacitor. Because of extremely high piezomaterial internal resistance (more than 100 M Ω) only a small discharge current flows if piezomaterial remains static in the expanded state. Thus, the piezoelement being separated from the source of high voltage, its expansion is decreasing slowly. This, in turn, causes a change in the charge, which results in a current:

$$i = \frac{dQ}{dt} = C \frac{dV}{dt} \quad (20.36)$$

where Q is the charge, C is the capacity, and V is the voltage.

Table 20.6 shows different piezoelement sensing/actuating possibilities for some shape cases. Basic types of piezoactuators used are stacked and of laminar design. Laminar design actuators consist of piezoelectric strips with electrodes bonded onto them. Stacked (multilayer) actuators consist of some thin wafers of piezoactive material between metallic electrodes in parallel connection (Fig. 20.82(a)).

TABLE 20.6 Piezoelement Sensing/Actuators Possibilities

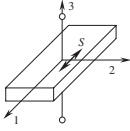
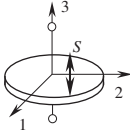
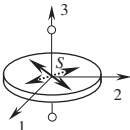
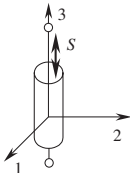
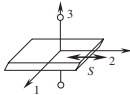
| Action Mode (L , length; W , width; T , thickness; D , diameter) | Generated Voltage, V | Displacement, ΔL (ΔT) | Capacitance, C |
|---|-----------------------------------|---|--|
| Transverse length mode: $L > 3W > 3T$ | $V = \frac{g_{31} F}{W}$ | $\Delta l = \frac{d_{31} L}{T} V$ | $C = \frac{\epsilon_3^T L W}{T}$ |
|  | | | |
| Thickness extension mode: $D > 5T$ | $V = \frac{4T g_{33} F}{\pi D^2}$ | $\Delta T = d_{33} V$ | $C = \frac{\pi \epsilon_3^T D^2}{4T}$ |
|  | | | |
| Radial mode: $D > 5T$ | Not applied | $\Delta D = \frac{d_{31} D}{T} V$ | $C = \frac{\pi}{4} K_3^T \epsilon_0 \frac{D^2}{T}$ |
|  | | | |
| Longitudinal mode: $L > 3D$ | $V = \frac{4L}{\pi D^2} g_{33} F$ | $\Delta L = d_{33} V$ | $C = \frac{\pi D^2}{4L} K_3^T \epsilon_0$ |
|  | | | |
| Thickness shear mode: $W > 5T, L > 5T$ | $V = \frac{g_{15} F}{W}$ | $\Delta x = d_{15} V$ | $C = \frac{LW}{T} K_1^T \epsilon_0$ |
|  | | | |

Note: F is the force and ϵ_3^T is dielectric permittivity of the material at constant stress in direction 3, K_i^T is relative dielectric constant ($K_i^T = \epsilon_i^T / \epsilon_0$), and ϵ_0 is dielectric permittivity in vacuum.

This way of connection allows greater travel at lower voltage. Usually these wafers are 0.3–1 mm thick. The stack is often referred to operating mode d_{33} . Total travel up to 200 μm can be achieved, and in this case it is in proportion to the number of wafers, if no external load is applied:

$$\Delta l = V n d_{33} \tag{20.37}$$

where n is the number of elements.

TABLE 20.7 Properties of Some Stacked (Multilayer) Actuators

| Standard Part No. | Material | Shape | Length × Width × Thickness (mm) | V_{\max} (V) | Stroke (μm) | F_{\max} (kN) |
|-------------------|----------|-----------|--|----------------|--------------------------|-----------------|
| | | | or Ext. Diam. × Intern. Diam. × Thickness (mm) | | | |
| A01 | Pz26 | Rectangle | 2.5 × 2.0 × 2.0 | 200 | 1.8 | 0.5 |
| A06 | Pz26 | Square | 10 × 10 × 2.0 | 200 | 2.0 | 10 |
| A16 | Pz27 | Square | 10 × 10 × 2.0 | 200 | 3.2 | 5.0 |
| A21 | Pz26 | Ring | 6.0 × 2.0 × 2.0 | 200 | 1.7 | 2.5 |
| A27 | Pz26 | Ring | 25 × 15 × 2.0 | 200 | 2.2 | 31 |
| A37 | Pz27 | Ring | 25 × 15 × 2.0 | 200 | 3.4 | 16 |

Due to stacked design, strong pushing force is developed:

$$F = \frac{\Delta l A}{L s_{33} Y} \quad (20.38)$$

where L is the length of the stack, A is the area of elements, and s_{33} , Y are compliance and Young's modulus, respectively.

For reference, Ferroperm Piezoceramics' multilayer actuator supply catalog [6] extract is presented in Table 20.7.

If long travel is required, piezoelement expansion can be amplified by using bimorph or levers. Bimorph is a composite cantilever of two layers (Fig. 20.82(b)). One of them is of structural material and the other of piezomaterial. Piezomaterials can be used for both layers. In this case, first layer will expand, the second one contract. However, this results in low stiffness.

Application Areas

Due to inherent properties in piezomaterials, actuators with a lot of engineering advantages can be developed. Some examples are compact and lightweight, large force, broad operating frequency range, high stability, solid state, displacement proportional to applied voltage, 50% energy conversion efficiency.

They are used in micromanipulation, noise and vibration suppression systems, valves, laser and optics, ultrasonic motors, positioning devices, relays, pumps, in automotive industry, industrial automation systems, telecommunications, computers, etc. Some of the applications are shown in Fig. 20.83.

- Suppression of oscillations.* Piezoactive materials-based dampers convert mechanical oscillations into electrical energy. Generated energy is then shunted to dissipate the energy as heat, i.e., oscillation energy is eliminated. The principle scheme is given in [2].
- Microrobot.* Robot platform legs are piezoactuators. By applying voltage to the electrodes, piezo-legs are lengthened, shortened, or bent in any direction in a fine movement.
- Micropump.* Diaphragm is actuated by piezoactuator, input and output check valves are subsequently opened for liquid or gas pumping. Advantages are fast switching and high compression rate.
- Microgripper.* Piezoactuator works on contraction for gripping motion based on the compliant mechanism. Gripper is of very small size and almost any required geometrical shape.
- Micromanipulator.* Due to the unlimited resolution, piezoactuators are used in numerous positioning applications.
- Microdosage device.* Piezoactuators allow high precision dosage of a wide variety of liquids in a range of nanoliters for various applications.

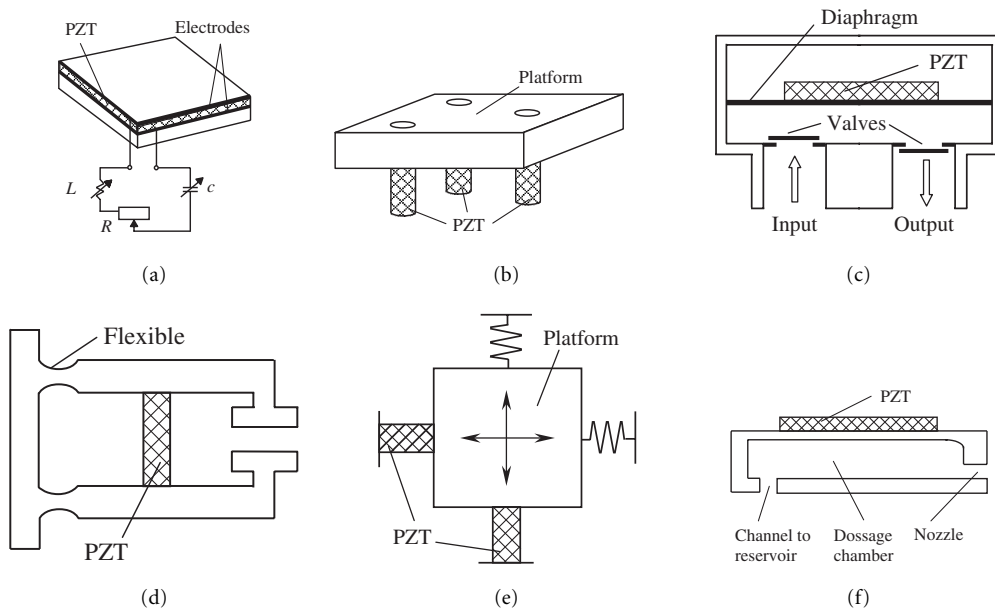

FIGURE 20.83

Piezomotors (Ultrasonic Motors)

Vibromotors [4] find wider and wider application as actuators based on the conversion of high frequency mechanical oscillations (dozens of kHz) into continuous motion [7,8]. Piezoactivating elements can be used as oscillators, and in this case vibromotors are called piezomotors [5,7,8]. Advantages of piezomotors are large torque, high resolution, excellent controllability, small time constant, compactness, high efficiency, silent operation, and no electromagnetic induction.

Main Types of Piezomotors

Piezomotors differ with respect to the methods of oscillations conversion into continuous motion. Basic ideas are given in Table 20.8.

Piezomotors producing elliptical motion in the contact area between input and output links are mainly used. For this purpose oblique impact upon the output link or traveling wave is made use of.

In piezomotors, making use of oblique impact, friction force transmits motion and energy between input and output links. This may be realized by two oscillatory motions (normal and tangential components) u_y and u_x in the contact area with phase difference φ , which is used to change output link motion direction. Both motions can be realized by one or two active links oscillating resonantly. Various oscillations offer possibilities to develop different kinds of piezomotors: longitudinal, transversal, shear, and torsional. Piezomotors employing oblique impacts possess a very wide frequency range. Its lower limit is at lower ultrasound frequencies (for elimination of acoustic action), 16–20 kHz, and its upper limit is at several megahertz. Traveling wave motion piezomotors are based on frictional interaction between the traveling wave motion in the elastic body and the output link, i.e., its principle of operation is similar to the harmonic traction transmission. Wave propagating along the surface (Rayleigh wave) of the input link forms the elliptical motion in the contact area. Rayleigh wave is a coupled wave of longitudinal and shear waves; thus each surface point in elastic medium moves along an elliptical locus. Flexural, shear, torsional, and longitudinal waves are used in piezomotors. Traveling wave in piezoceramic is excited by electrical field.

Traveling wave motion piezomotor characteristics (ABB Corporate Research ITCRC/AS) are shown in the Table 20.9.

TABLE 20.8 Piezomotors Operating Principles

| Basic Idea | Schematic of Realization | Remarks |
|--|---|--|
| <p>A. Elliptic motion in the contact: two motion components with phase difference</p> | <p>1. One active link</p>  | $u_y = u_{y0} \sin(\omega t + \varphi)$ $u_x = u_{x0} \sin \omega t$ |
|   | <p>2. Two active links</p>  | $u_y = u_{y0} \sin(\omega t + \varphi)$ $u_x = u_{x0} \sin \omega t$ <p>where u_{y0}, u_{x0}, ω, and φ are amplitudes, angular frequency, and phase of oscillatory motions of piezoelements, respectively</p> |
| <p>B. Elliptic motion in the contact area: traveling wave</p>  |  | $u = u_0 \cos 2\pi/\lambda(u^* - ct)$ <p>where u_0, λ, and c are amplitude, length, and velocity of wave, respectively</p> |
| <p>C. Frictional anisotropy of contact</p>  | <p>a)</p>  <p>b)</p>  <p>c)</p>  | <p>Usually $\frac{\tau_c}{T} \geq 0.05$</p> <p>where τ_c and T are the duration of contact and oscillation period, respectively</p> |

TABLE 20.8 Piezomotors Operating Principles (Continued)

| Basic Idea | Schematic of Realization | Remarks |
|-------------------------------------|---|---------|
| D. Asymmetrical oscillations cycles | <p>a)</p>  <p>b)</p>  | |

TABLE 20.9 Properties of Some Traveling Wave Piezomotors

| Motor | Unit | USR60 | USR45 | USR30 |
|--------------------------|------------------|----------|----------|----------|
| Operating frequency | kHz | 40 | 43 | 42 |
| Operating voltage | V _{rms} | 100 | 100 | 100 |
| Rated torque | Nm | 0.38 | 0.15 | 0.04 |
| Rated output | W | 4 | 2.3 | 1.0 |
| Rated rotational speed | rpm | 100 | 150 | 250 |
| Mechanical time constant | ms | 1 | 1 | 1 |
| Weight | g | 175 | 69 | 33 |
| Rotation irregularity | % | 2 | 2 | 2 |
| Lifetime | h | 1000 | 1000 | 1000 |
| Operating temp. range | °C | -10 + 50 | -10 + 50 | -10 + 50 |

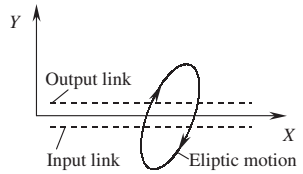
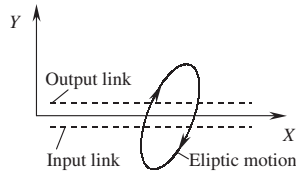
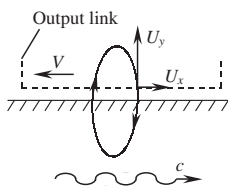
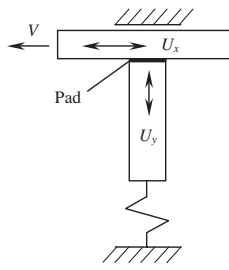
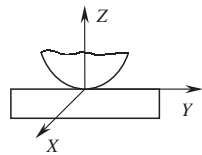
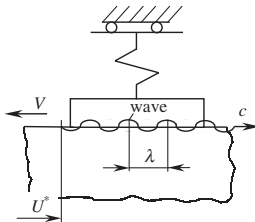
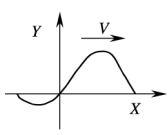
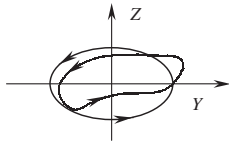
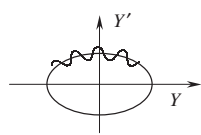
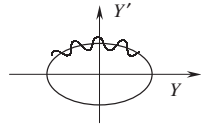
Traveling wave excitation is achieved simultaneously by exciting different phase oscillations of the same frequency and mode. This is accomplished by dividing the electrodes of the converters into n equal parts and connecting them to the n -phase generator of electrical vibrations, where $n \geq 3$ phases are shifted between adjacent electrodes being $2\pi/n$, or by using discrete converters.

Piezomotors with frictional anisotropy of contact are based on oscillatory motion variations in normal active links contact direction in the cycle of oscillations. This is achieved by superposing additional periodic actions in the contact. The distinguishing feature is time τ_c/T ratio of the reduced duration of the contact to the oscillations period in contact parameter. The contact anisotropy can be achieved in two ways: (a) by locking the active link in a specified segment of the trajectory (Table 20.8, case C, a), (b) by superimposing oscillations of higher frequencies (Table 20.8, case C, b), in the direction of basic oscillations, or in perpendicular direction of basic oscillations (Table 20.8, case C, c) normal or tangential plane.

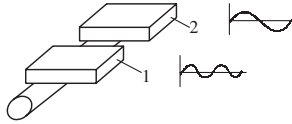
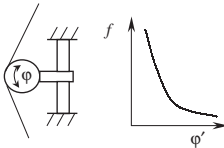
Piezomotors with asymmetrical oscillations are based on the asymmetry of inertia forces in nonharmonic high frequency oscillations, multiple frequency oscillations (Table 20.8, case D, a), or forces of dry friction with nonlinear relationship between force and velocity (Table 20.8, case D, b). Asymmetric cycles of oscillations are generated by summing harmonics of multiple frequencies. The amplitude of each harmonic is chosen by varying electrode shape and area of divided electrodes or varying amplitude of the voltage supplied. Shift in voltage supply phases is used. Piezomotor efficiency in this case is lower, but designs of devices are characterized by higher—up to $0,002 \mu\text{m}$ —resolution in translational drive. Besides, this permits piezomotors of limited dimensions in both coordinates, which, in turn, is very important in a number of applications.

Piezomotors are easily miniaturized; thus, micromotors are successfully developed. The rotational motor [5] of this type is a good example. It is 2 mm in diameter, 0.3 mm in height, and its volume is 0.49 mm^3 . The motor stably rotates at any posture and the starting torque is about $3.2 \mu\text{Nm}$.

Piezoactuators with Several Degrees of Freedom

Piezoelectric actuators with several degrees of freedom allow new class of mechanisms, capable of changing their parameters or kinematic structure under control. If one or both links of the kinematic pair are made from piezoelectric material, it is possible to generate static displacement of its elements and quasi-static or resonant oscillations, resulting in generating forces or torque in contact area of links. Motion of one link relative to the other is obtained. Such kinematic pairs can be defined as active. Active kinematic pairs are characterized by

- Control of number of degrees of freedom. The simplest one is to control friction in the pair, usually when the elements of the pair are closed by force. Here either the friction coefficient or magnitude of the force executing the closure can be varied. This is achieved by excitation of high frequency tangential or normal vibrations in the contact area of the pair.
- Generation of forces or torque in the contact area between links. The direction of generated forces or torque is controlled by special shift of oscillations, e.g., by activating specific by sectioned electrodes of the transducer.
- Possibilities to realize additional features: self-diagnostics, multifunctionality, self-repair, self-adaptation.

The example is a robot's eye (Fig. 20.84(a)) in which miniature CCD camera 1 is fixed in the passive sphere 2, contacting with piezoelectric ring 3. Constant pressure in the contact zone is realized by

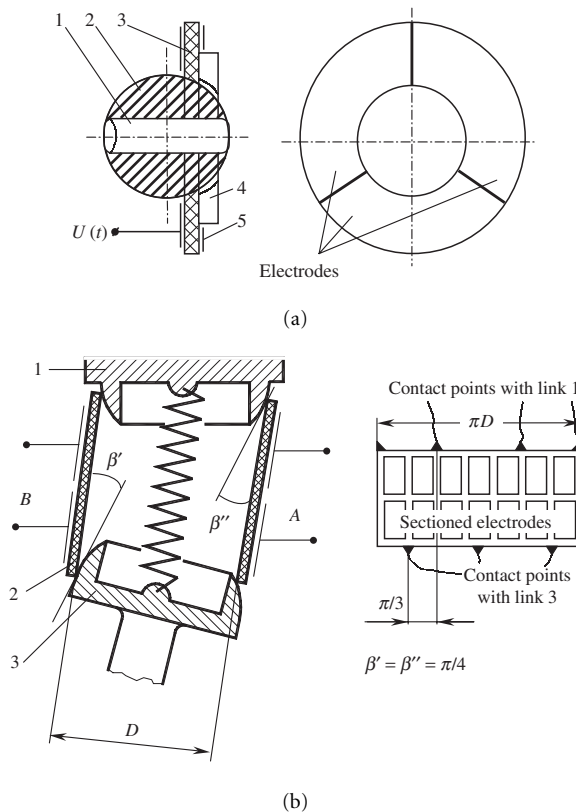

FIGURE 20.84

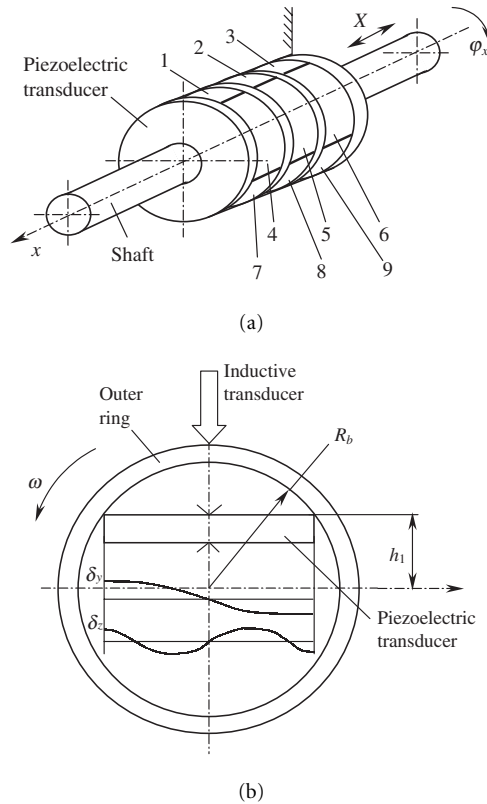

FIGURE 20.85

permanent magnet 4. The system is a kinematic pair possessing three degrees of freedom. Electrodes 5 in the piezoelectric ring are sectioned (in this case - into three symmetric parts); activating any of them with AC of resonant frequency results in the rotation of the sphere around its axis, position of which is controlled by changing the activated electrode. Traveling wave oscillations generated in the ring (by applying three-phase AC to all three electrodes) result in the rotation of the sphere around the axis of the ring. Such type actuators possess approximately two angular seconds resolution in every direction—higher than the requirements for robot vision systems.

The existing methods to control types and forms of resonant oscillations make it possible to design mechanisms with the same active link being used in two kinematic pairs to increase redundancy in the system. A piezoelectric robot, based on active kinematic pairs, is shown in the Figure 20.84(b). It consists of passive material (e.g., steel) spheres 1 and 3, with piezoelectric transducer 2 between them. Springs ensure contact between all links. A robot with two spherical kinematic pairs possess six degrees of freedom. Kinematic pairs move due to piezomotor design methods. The electrodes on active links are sectioned. Figure 20.84(b) shows their form and the distribution of the three component oscillations in the contact area. High frequency multicomponent oscillations generated at the contact points (certain electrodes “A” of link 2 are actuated) rotate link 2 in relation to link 1. A $\pi/3$ change in the position of oscillation pattern (a change of position of vibration nodes in contact points) results in the rotation of link 3 in relation to link 2. Using direct piezoeffect, it is possible to extract additional information (with the help of electrodes “B”) on forces and torque, acting on link 2 and on the state of contacting surfaces. This information is used to reduce positioning errors and to correct motion trajectory.

Classically, by increasing accuracy and stiffness of system elements, static and dynamic errors in bearings, supports, and guides are decreased or eliminated completely. By integrating unique properties of piezoactive transducers and actuators in the control system it is possible to sharply reduce or even fully

eliminate most errors in bearings, supports, and guides used in high precision measuring devices. This is due to active bearings and supports possessing several degrees of freedom, in which one or both contacting elements are made from piezoelectric material with predetermined excitation zones. Radial or axial play, backlash and dead zones—traditional errors—are minimized in these devices. The schematic of active bearing is shown in Fig. 20.85(a) where number of axial n and radial m electrode sectors is $n = m = 3$. Active bearings are used in precision component surface and profile measuring systems to scan the surface. The example is outer ring errors evaluation in high precision ball bearings. Here rotating the component simultaneous measurements of profile and surface are obtained. This is possible due to piezoelectric transducers (Fig. 20.85(b)) contacting with the component in two areas with the same pattern of oscillation distribution and phase shift between normal and tangential components of oscillations. There being no external forces, it is evident that errors caused by torque, generated in the contact zone, are negligible.

References

1. Cady, W. G., *Piezoelectricity*, Dover Publications, New York, 1964.
2. Volkov, V., Some Theoretical Problems in Modern Techniques of Diagnostics in Mechanical Systems, in *Proc. Int. AMSE Conf. Systems Analysis, Control and Design*, Lyon, France, 205.
3. Uchino, K., *Piezoelectric Actuators and Ultrasonic Motors*, Kluwer Academic Publishers, MA, 1997, 349.
4. Ragulskis, K., Bansevicius, R., Barauskas, R., Kulvietis, G., *Vibromotors for Precision Microrobots*, Hemisphere Publishing Corporation, 1988, 310.
5. Suzuki, Y., Tani, K., Sakuhara, T., Development of new type piezoelectric micromotor, *J. Sensors & Actuators*, 83, 244, 2000.
6. Catalog Ceramic Multilayer Actuator CMA d_{33} & d_{31} , July 2000.
7. Sashida, T., Kenjo T., *An Introduction to Ultrasonic Motors*, Oxford Science Publications, 1993, Oxford University Press, New York, 242.
8. Ueha S., Tomikawa Y., *Ultrasonic Motors, Theory and Application*, Oxford Science Publications, Oxford Press, Oxford, 1993, 298.

20.4 Hydraulic and Pneumatic Actuation Systems

Massimo Sorli and Stefano Pastorelli

Introduction

The primary function of an actuation system is to influence the controlled system so as to obtain the desired movement or action. This objective is made possible by the actuation system, which converts the primary energy with which the actuator operates into the final mechanical energy.

There are three main types of power with which actuation systems work: electric power, hydraulic power, and pneumatic power. The first envisages the use of electric actuators such as motors, solenoids, and electromagnets. The remaining two envisage the use of cylinders (linear motors) and rotary motors, substantially similar in form and dimensions, the motion of which is respectively governed by a fluid considered incompressible in an initial approximation (a hydraulic liquid, mineral oil generally, or a liquid with lower viscosity) and by a compressible fluid (compressed air or a generic gas).

Other types of energy are available but are fairly unusual in automatic systems. Chemical energy and thermal energy, which cause a change of phase in a material or the thermodynamic expansion of the systems into a mechanical movement, can be considered in this category.

The characteristics of fluid servosystems are examined below, with particular reference to systems which permit continuous control of one of the two physical magnitudes which express the fluid power: pressure and flow rate. In general, pressure control is carried out in cases in which it is necessary to create a determined force or torque law, while flow rate control is used to carry out controls on kinematic magnitudes such as position, speed, and acceleration.

Continuous control of a force or of a speed can be effectively realized with a fluid actuation device, with evident advantages compared with electric actuation, such as the possibility of maintaining the system under load without any limitation and with the aid of adequate control devices, the possibility of carrying out linear movements directly at high speeds, without devices for transforming rotary motion to linear, and the possibility of having high bandwidths, in particular in hydraulic systems, as these have limited dimensions and therefore low inertia.

Fluid Actuation Systems

An actuation system, which is part of an automatic machine, consists of a power part and a control part as illustrated in Fig. 20.86. The power part comprises all the devices for effecting the movements or actions. The control part provides for the processing of the information and generates the automated cycle and the laws of variation of the reference signals, in accordance with the governing procedures implemented and with the enabling and feedback signals arriving from the sensors deployed on the operative part. The order signals coming from the control part are sent to the operative part by means of the interface devices which convert and amplify the signals, where necessary, so that they can be used directly by the actuators. These interfaces can be the speed drives or the contactors of the electric motors, the distributor valves in hydraulic and pneumatic actuators.

Figure 20.87 illustrates a fluid actuation system. The power part consists of the actuator—a double-acting cylinder in the case in the figure—the front and rear chambers of which are fed by a 4/2 distributor valve, which constitutes the fluid power adjustment interface.

The valve switching command is the order from the control part. This order is sent in accordance with the movement strategy, determined by the desired operating cycle of the cylinder in the control part, on the basis of the feedback signals from the sensors in the cylinder, represented in the figure by the limit switches.

Then there are discontinuous actuation systems and continuous actuation systems, depending on the type of automation realized, while retaining the control part and the actuation part. The first are effective when used in discontinuous automation, typical of assembly lines and lines for the alternating handling of machine parts or components; on the other hand, continuous actuation systems are found in continuous process plants and as continuous or analog control devices for the desired magnitudes, and constitute fluid servosystems.

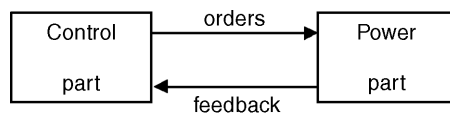

FIGURE 20.86 Actuation system.

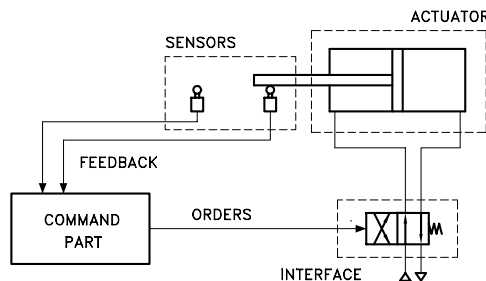

FIGURE 20.87 Fluid power actuation system.

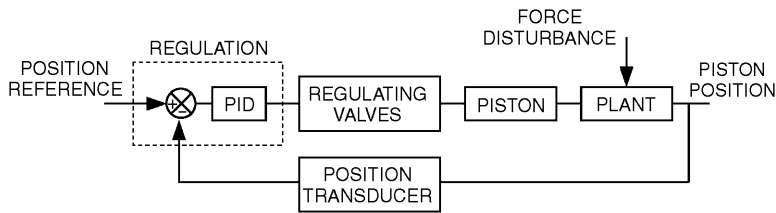

FIGURE 20.88 Scheme of a fluid power servosystem.

Fluid actuators, whether they are linear (cylinders) or rotary (motors) are continuous systems as they can determine the positioning of the mobile component (of the rod with respect to the cylinder liner; of the shaft with respect to the motor casing) at any point in the stroke. Performance of the usual cylinders and motors is currently highly influenced by the action of friction (static and dynamic) developed by contacts between mobile parts. This action, in pneumatic systems in particular, gives rise to the well-known phenomenon of stick-slip, or intermittent motion at very low movement speeds, due to the alternation of conditions of friction and adherence in the motion of the mobile element in the actuator. Given the nature of the friction itself, the presence of devices suitable for sustaining the mobile components of the actuator and maintaining the correct pressure conditions, such as supports and gaskets, gives rise to nonlinear conditions in the equilibrium of the actuator, increasing the level of difficulty in obtaining high precision in positioning the system. To overcome these problems in specific applications it is necessary to use actuators without seals, for example, with fluid static and/or fluid dynamic bearings.

The interface element, indicated as a distributor in the figure, takes on a crucial role in the definition of the operating mode of the actuator. Indeed, in the case in which it is only necessary to create reciprocating movements, with positioning of the actuator at the end of its stroke, it is only necessary to use a two- or three-position distributor valve, with digital operation. This is the solution shown in Fig. 20.87.

If, on the other hand, it is necessary to have continuous control of the position and force transmitted, it is necessary to use devices which are not digital now, but which are continuous, such as proportional valves and servovalves, or it is necessary to use digital devices operating with control signal modulation, for example those of the PWM (Pulse Width Modulation) type.

The actuation system therefore becomes a fluid servosystem, such as the one outlined in Fig. 20.88, for example. A practical construction of a hydraulic linear servoactuator having the same working scheme of Fig. 20.88 is shown in Fig. 20.89. It consists of a cylinder, a valve, and a position transducer integrated in a single device.

A controlled, fluid-actuated system is a classical mechatronic system, as it combines mechanical and fluid components, and control and sensing devices, and normally requires a simulation period for defining the size and characteristics of the various elements so as to comply with the desired specifications.

The standardized symbols for the different components of hydraulic and pneumatic fluid systems, and the definitions of the associated circuits, are defined in the standard, ISO 1219 “Fluid power systems and components—Graphic symbols and circuit diagrams; Part 1: Graphics symbols, Part 2: Circuit diagrams.”

Fluid Servosystems

Fluid servosystems are devices for controlling a generically mechanical output power, either by controlling a kinematic magnitude (servosystems for controlling position or speed) or by controlling an action (servosystems for controlling the force, torque, or pressure).

The output magnitude control action is obtained by controlling the fluid power, that is, by the power of the fluid passing through the components of the servosystem.

Two large classes of fluid servosystems are usually present in current applications: hydraulic servosystems, in which the operating fluid is a liquid, and pneumatic servosystems, in which the fluid used is compressed air. The working pressure in hydraulic servosystems is typically comprised between 150 and 300 bar, while in the case of pneumatic systems, the pressure values are generally below 10 bar.



FIGURE 20.89 Hydraulic servocylinder (Hanchen).

The first group obviously includes hydraulic oils, that is, fluid with high viscosity, now traditionally used in servosystems in which a high controlled pressure is requested, but also combustible fluids, such as automotive or aeronautical petrols (JPA, JPB,...), used in all the applications found in the fuel circuits of combustion engines. Other servosystems include those which use both industrial and seawater as the working fluid. The latter solution has unquestionable advantages in all naval and off-shore applications.

Pneumatic servosystems include all the industrial applications for automation of production and process automation, and also the vehicular applications on means of air, sea, road, and rail transport. The compressed air in these applications is generated by compressors using air drawn in from the environment. Further applications include those in which the working fluid is not compressed air but a particular gas. In this regard, there are servosystems with refrigerant fluids in the gaseous stage, in both vehicular and industrial cryogenic systems, with fuel gases (LPG, methane, propane) in domestic applications, and with nitrogen in high-pressure applications.

It can be seen from this preliminary analysis that fluid servosystems are present both in the realization of a product, being integral parts of the automated production process, along with the electric servo-mechanisms, and as controlled actuation devices integrated in the product itself; in this regard we can mention generic servoactuators installed on aeroplanes and increasingly in road vehicles today.

Hydraulic Actuation Systems

The components of a hydraulic actuation system are:

- the pump, that is, the hydraulic power generation system;
- the actuator, that is, the element which converts hydraulic power into mechanical power;
- the valve, that is, the hydraulic power regulator;
- the pipes for connecting the various components of the actuation system;
- the filters, accumulators, and reservoirs;
- the fluid, which transfers the power between the various circuit elements;
- the sensors and transducers;
- the system display, measurement, and control devices.

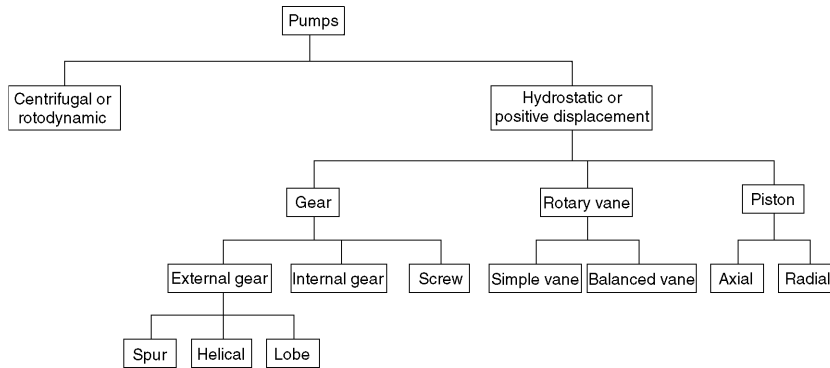

FIGURE 20.90 Pumps classification.

Pumps

Pumps transform electrical or mechanical energy into hydraulic energy. They constitute the fluid flow generator of the hydraulic system, as the pressure is determined by the fluid resistance downstream from the generator. The main types of pumps are shown in Fig. 20.90.

Centrifugal pumps permit high deliveries with low pressures. They do not have internal valves but have a large clearance between the rotary part and stator part and guarantee a sufficiently stationary flow. Vice versa, hydrostatic or positive displacement pumps, which are those most commonly used, guarantee high pressures with limited deliveries. They have elements such as valves and caps, which permit separation of the delivery zone from the intake zone, and they may introduce pulses in the flow in the delivery line and generally require the use of a fluid with sufficient lubricating properties and load capacity, so as to reduce the friction between the sliding parts of the pump. There are constant displacement and variable displacement pumps.

The main positive displacement pumps belong to the gear, rotary vane, and piston types.

Gear Pumps

Gear pumps are subdivided into pumps with external gears, pumps with internal gears, and screw pumps. In all cases, the pump is made up of two toothed wheels inserted into a casing with little slack so as to minimize leakage.

Figure 20.91 is a photograph of a pump with external gears. The opposed rotation of the wheels causes the transfer of the oil trapped in the space between the teeth and walls of the gear from the intake to the outlet. Depending on the form of the teeth, there are external gear pumps of the spur gear, helical gear, and lobe gear types.

Pumps with internal gears are functionally similar to the above, but in this case the gears rotate in the same direction. Figure 20.92 is a section plane of a two-stage pump. In screw pumps, which may have one or more rotors, the elements have helical toothing similar to a threaded worm screw. Transfer of the fluid takes place in an axial direction following rotation of the screw. These types of pump guarantee very smooth transfer of the flow, with reduced pulsation and low noise levels.

The usual rotation speeds are between 1000 and 3000 rpm, with powers between 1 and 100 kW. Delivery pressures can reach 250 bar, with higher values in the case of the pumps with external gears. The flow transferred is a function of the pump displacement and the angular input speed, with values comprised between 0.1 and 1000 cm²/rev. Double pumps can be used to increase these values. Gear pumps have high performance levels, with values around 90%.

Rotary Vane Pumps

Vane pumps (Fig. 20.93) generally consist of a stator and a rotor, which can rotate eccentrically with respect to one another. Vanes can move in special slits placed radially in the stator or in the rotor and



FIGURE 20.91 External spur gear pump (Casappa).

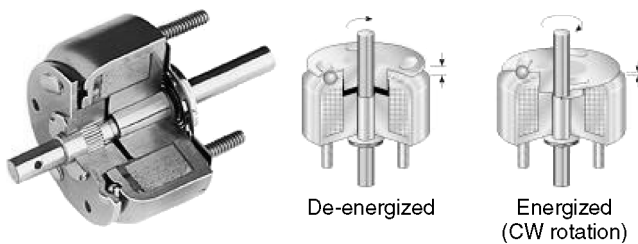

FIGURE 20.92 Internal gear pump (Truninger).

delimit appropriate variable volumes. In Fig. 20.93, as in most constructions, the vanes are borne by the rotor which can rotate inside the stator. Rotation leads to the displacement of volumes of fluid enclosed between two consecutive vanes from the intake environment to input into the delivery environment. This type of pump permits a range of working pressures up to 100 bar and, compared with gear pumps, guarantees lower pulsing of the delivery flow and greater silence.

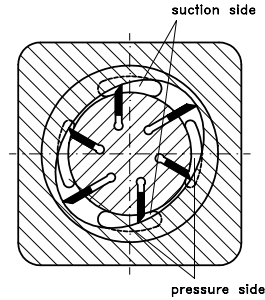

FIGURE 20.93 Rotary vane pump.

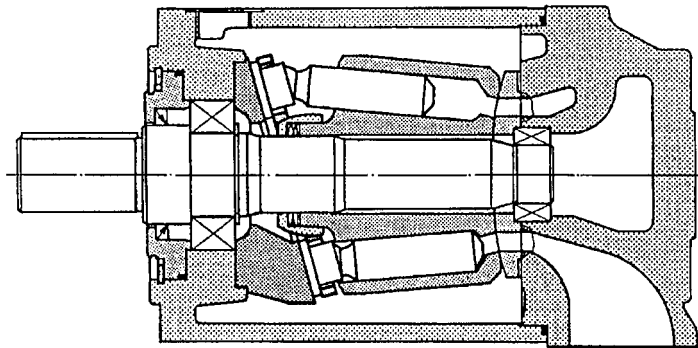

FIGURE 20.94 Axial piston swash plate pump (Bosch Rexroth).

Piston Pumps

Volumetric piston pumps can have one or more cylinders; that is, there may be one or more cylinders with a piston sliding in each of them. Transfer of the volume of fluid from intake to delivery is determined by the displacement of the piston inside the cylinder, which is provided with input and output valves or shutters. Depending on the geometrical arrangement of the cylinders with respect to the rotating motor shaft, piston pumps are subdivided into axial pumps (bent axis type and swash plate type) and radial pumps. Figure 20.94 shows the plan of a fixed-displacement axial piston pump, of the swash plate type. The working pressure range available with the aid of piston pumps is greater than in the previous cases, being able to reach pressures in the order of 400–500 bar but with the disadvantage of more uneven flow.

Motion Actuators

Motion actuators convert the hydraulic energy of the liquid under pressure into mechanical energy. These actuators are therefore volumetric hydraulic motors and are distinguished, on the basis of the type of movement generated, similar to what has been said about pumps, into rotary motors, semi-rotary motors or oscillating ones, which produce limited rotation by the output shaft, and into linear reciprocating motors, that is hydraulic cylinders.

Rotary and Semi-rotary Motors

In construction terms, rotary motors are identical to rotary pumps. Therefore gear, vane, and piston motors, radial or axial, are available. Obviously, the operating principle is the opposite of what has been said for pumps. The symbols of hydraulic rotary motors are shown in Fig. 20.95. Semi-rotary motors generate the oscillating motion either directly, by means of the rotation of a vane connected to the output shaft, or indirectly, by coupling with a rack, driven by a piston, with a toothed wheel connected to the output shaft, as in the example in Fig. 20.96. The semi-rotary vane motors produce high instantaneous torsional torque on the output shaft; for this reason they are also called hydraulic torque-motors.

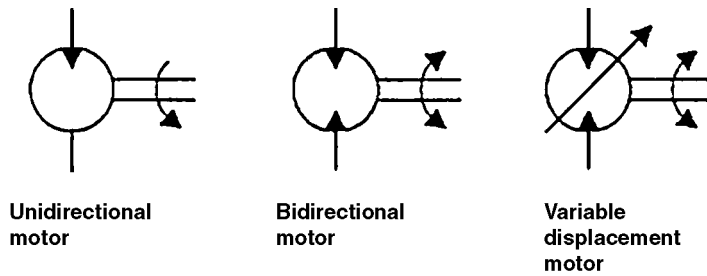

FIGURE 20.95 Symbols of hydraulic rotary motors.

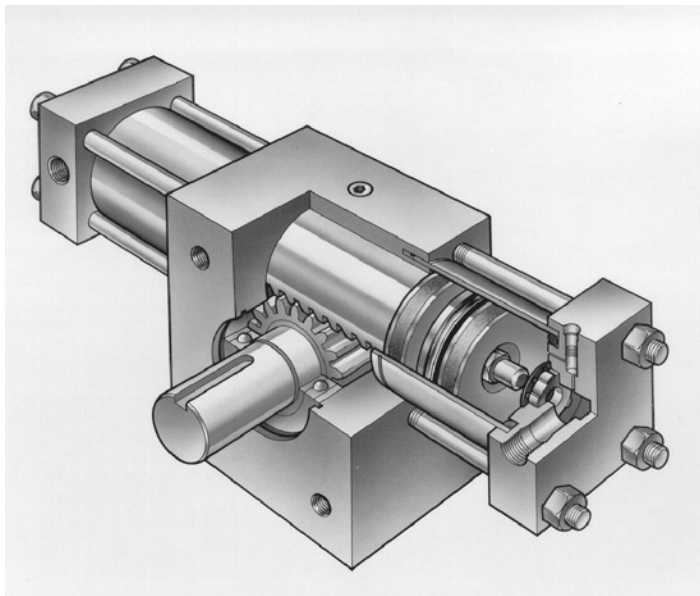

FIGURE 20.96 Hydraulic rotary actuator (Parker Hannifin).

Linear Actuators

Linear hydraulic motors constitute the most commonly used type of actuator. They provide a rectilinear movement realized by the stroke of a rod connected to a piston sliding inside the cylinder. A distinction is made between single acting and double acting cylinders. The former only permit a single work stroke and therefore the pressure of the fluid is exerted on the surface of the piston in one single direction; the retract stroke is made by means of the force applied externally to the cylinder rod, or with the aid of a helical spring incorporated with the actuator inside a chamber. The latter permit both strokes, so that the fluid acts alternately on both faces of the piston, generating both the advance and retract strokes. Double acting cylinders may have a single rod or a double through rod. These are composed of a tube closed at the ends by two heads, and a mobile piston inside the barrel bearing one or two rods connected externally to the load to move. As it is fitted with sealing gaskets, the piston divides the cylinder into two chambers. By sending the oil under pressure into one of the chambers through special pipes in the heads, a pressure difference is generated between the two surfaces of the piston and a thrust transmitted to the outside by the rod. [Figure 20.97](#) shows the constructional solution of a hydraulic double acting cylinder with a single rod. Single rod actuators are also known as asymmetrical cylinders because the working area on the rod side is smaller than the area of the piston, as it is reduced by the section of the rod itself.

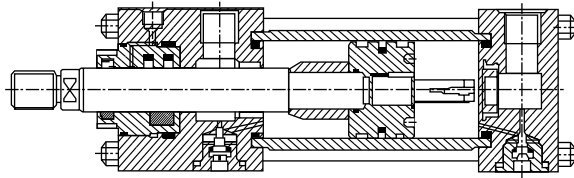

FIGURE 20.97 Single rod double-acting piston actuator (Atos).

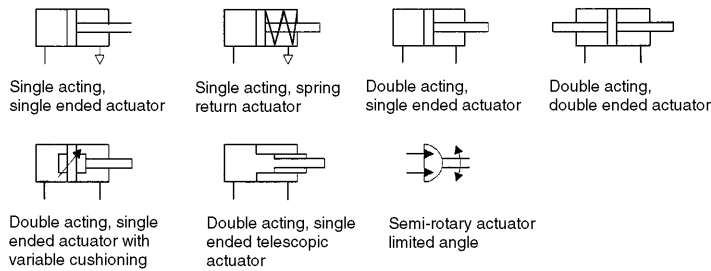

FIGURE 20.98 Actuators symbols.

This involves actuating forces and feed speeds which are different in the two directions, with the same feed pressure in the two thrust chambers.

Hydraulic actuators are able to support external overloads, as, if the load exceeds the available thrust force, the rod stops or reverses, but generally does not suffer any damage. Cylinders may get damaged however, or at least suffer a drop in performance, when they have to support loads which are not applied along the axis of the rod, that is, with components in the radial direction, as reactions are generated on the rod supports and piston bearings, which leads to fast wear of the same and reduces the tightness with oil leakage as a result.

The main features of a linear actuator are its bore, its stroke, its maximum working pressure, the type of working fluid, and the way its connections are fitted.

The symbols of the different types of actuators can be seen in [Fig. 20.98](#).

Valves

Valves are the components in hydraulic circuits that carry out the task of regulating the hydraulic power sent to the actuator. Their role is to turn the oil flow on or off or to divert it according to needs, thereby permitting adjustment of the two fundamental physical magnitudes of fluid transmission: pressure and flow rate. They are subdivided as follows on the basis of the operations they carry out:

- directional valves
- on-off valves
- pressure regulator valves
- flow-rate regulator valves

In servomechanism applications valves with the continuous positioning of the moving components in them, said flow proportional valves or servovalves, and pressure proportional valves are used.

Directional Valves

Directional valves determine the passage and the flow direction of the oil current by means of the movement of appropriate moving parts contained in them, actuated from outside. Directional valves,

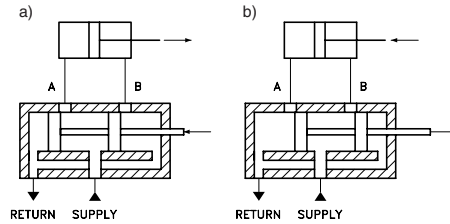

FIGURE 20.99 Scheme of four-way two-position valve.

also known as distributors, are distinguished according to the type of mobile element and therefore of their internal structure, by the number of possible connections with external pipes and by the number of switching positions.

The mobile element can be a poppet type or a spool type. Poppet valves are indifferent to fluid type and are not affected by impurities in the fluid, but require high actuating forces as it is not possible to compensate for the hydraulic forces of the oil pressure. Spool valves permit simultaneous connection to several ways and different switching schemes and therefore are more common because of their variability. The number of possible connections is defined by the number of hydraulic connections or ways present on the external body of the valve. The number of switching positions corresponds to the number of connection schemes which a valve makes it possible to obtain by means of appropriate movements of the mobile element.

Figure 20.99 shows the operating scheme of a four-way, two-position spool valve (indicated as 4/2) connected to a double acting linear actuator. In the first position (Fig. 20.99(a)) the supply is in communication through output A with the rear chamber of the cylinder, while the front chamber discharges through port B. In this configuration, the piston effects an advance stroke with the rod coming out. In the second position, (Fig. 20.99(b)), the result of the movement of the slide valve is that the feed and discharge conditions of the two chambers are inverted, and therefore, a retract stroke is effected.

A directional valve with several positions is represented symbolically by means of quadrants side by side depicting the connections made by each position. Figure 20.100, for example, shows some directional valve symbols in accordance with ISO standards. The central configuration of the three-position valves, which is normally the rest position, is linked with the geometry of the valve spool and of the associated seats.

Directional valves can be controlled in various ways (Fig. 20.100): manually, by applying muscle power; mechanically, by means of devices such as cams, levers, etc.; hydraulically and pneumatically, by means of fluids under pressure; and electromagnetically, directly or piloted, depending on whether the positioning force is generated directly by the electromagnet placed in line with the slide valve, or by means of a hydraulic fluid, the direction of which is managed by a pilot valve which is smaller than the main controlled valve.

On-Off Valves

On-off valves are unidirectional valves, which permit the fluid to flow in one direction only. Because they impede flow in the opposite direction they are also called nonreturn or check valves. On-off valves are normally placed in the hydraulic circuit between the pump and the actuator so that, when the generator stops, the fluid contained in the system is not discharged into the reservoir but remains in the piping. This prevents a waste of energy for subsequent refilling and guarantees positioning of the actuator under load.

Constructively, check valves consist of an actuator, with ball or piston, which in the impeded flow configuration is maintained in contact against its seat by the thrust of a spring (nonreturn valve), or by the pressure difference between inlet and outlet (unidirectional valve).

Pressure Regulator Valves

There are essentially two types of pressure regulator valves: pressure limiter valves or relief valves, and pressure reduction valves.

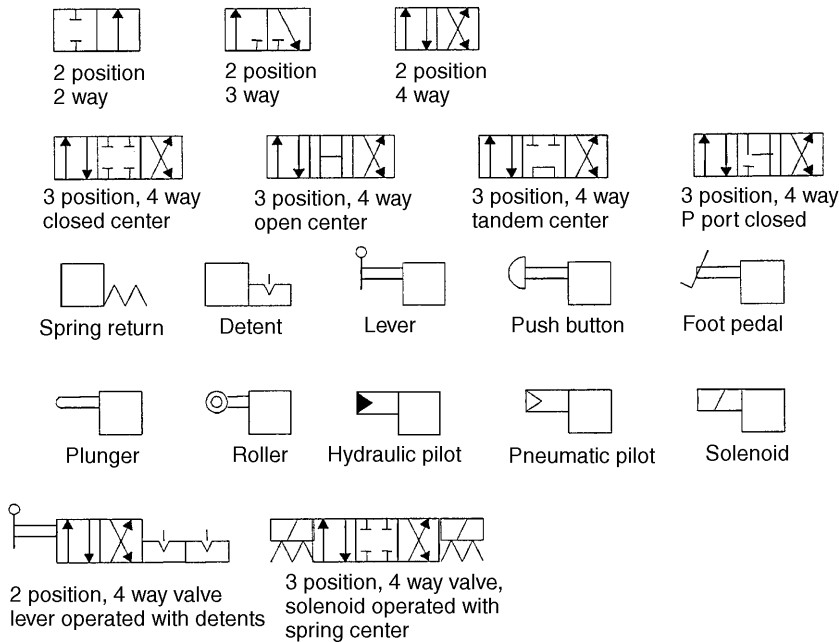

FIGURE 20.100 Valves symbols.

Relief valves guarantee correct operation of the system, preventing the pressure from exceeding danger levels in the system itself. There is always one maximum pressure valve in a hydraulic circuit to discharge any excess flow not used by the system back towards the reservoir. This is because the generator, or positive-displacement pump, provides a continuous flow of fluid which, if not absorbed by the user and in the absence of a relief or maximum pressure valve, would let the pressure in the system increase to unacceptable values. Pressure limiter valves can be direct-acting or piloted. The first provides the force of a spring with a fixed preload as the force contrasting the pressure of an obturator or an adjustable one, which guarantees the maximum opening pressure. The latter replaces the action of the spring with that of the hydraulic control fluid managed by a pilot valve.

The function of the pressure regulator valves is to maintain a constant pressure valve downstream from them, independently from variations in the upstream pressure. The regulated pressure value can be set manually, by means of a pilot signal, or by an electrical analog command. In the latter case, pressure regulator valves may operate in closed electrical loops, as they have an internal transducer to measure the controlled pressure.

Flow-rate Regulator Valves

A flow-rate regulator valve makes it possible to control the intensity of the flow of fluid passing through it. Functionally it operates as a simple restriction, similar to an orifice, with a variable area. The flow passing through a restriction is a function of the area of passage and of the difference in the pressures upstream and downstream from the component. The simple restriction is therefore sensitive to the load, as the flow rate also depends on the pressure drop at its ends, which is established by the other components in the circuit.

In the case of a pressure-compensated flow regulator valve, the flow rate is found to be maintained sufficiently constant above a minimum pressure stage (typically 10 bar) as an exclusive function of the external manual or electrical set-point. In this case, the valve has two restrictions in series, one of which is fixed and the other automatically variable, so as to maintain the pressure drop constant on the fixed restriction and guarantee the constancy of the flow rate.

The symbols for flow regulator valves in accordance with ISO standards are given in [Fig. 20.101](#).

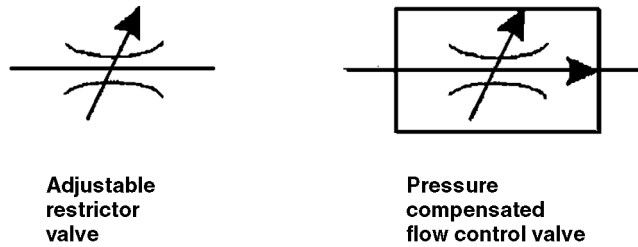

FIGURE 20.101 Symbols of flow control valves.

Proportional Valves and Servovalves

Servovalves began to appear at the end of the 1930s and were mainly used in the military and aeronautical fields. The first commercial versions appeared in the mid-50s. Servovalves and proportional valves are widely used today in the civil field, in the aeronautical, aerospace, automotive, and industrial sectors. In general, they are used for the continuous control of the displacement, speed, and force of a hydraulic actuator from which high performance is requested in terms of positioning precision, or accuracy in up and running conditions, and of working frequency bandwidth amplitude, both in open and closed loop control configurations.

A servovalve or proportional valve is a fluid component capable of producing a controlled output as a function of an input of electrical type. The device converting the electric signal into an action of the spool or poppet of the valve is electromagnetic, of the torque motor or proportional solenoid type. The torque motor converts a small DC current into torque acting on the rotor plate, in bipolar mode. Proportional solenoids produce a unidirectional force on the mobile armature function of the current circulating in the winding, with the characteristic of maintaining this force approximately constant within the cursor work displacement range. The torque motor, with lower current and inductance values, has shorter response times than the servosolenoid, which operates with notably higher currents, but generates lower mechanical power outputs. The torque motor, therefore, constitutes the pilot stage usually found in servovalves, while the servosolenoid used in proportional valves acts directly on the valve spools.

The magnitude directly controlled by the servovalve or proportional valve can be a flow rate or a pressure difference, depending on the type.

Servovalves and proportional valves are usually distinguished on the basis of the following characteristics:

- input signals
- precision
- hysteresis
- linearity between input and output
- dead band
- bandwidth

Input signals are characterized by the type of signal and range of variation. Current signals (± 10 mA or 4–20 mA) or voltage ones (0–10 V) are typical. Precision is intended as the difference between the desired value and the value effectively achieved. It is provided as a percentage of the full scale value. The hysteresis derives from the different behavior shown by the component with ascending settings and corresponding points descending. Its value expresses the percentage ratio between the maximum deviation and the full scale value. Linearity by nature is a characteristic that can be assessed over the entire working range. It can be expressed in an absolute manner as the maximum percentage deviation of the input/output relation of its linear regression. In general, better linearity is requested in position control compared with the cases of speed, pressure, or force controls. The dead band determines the minimum input value at which an output variation is obtained. Unlike the above, bandwidth is a

TABLE 20.11 Main Typical Differences Between Servovalves and Proportional Hydraulic Valves

| | Servovalve | Proportional Valve |
|-------------------------------|---|--|
| Electromechanical converter | Bidirectional torque motor (0.1 ÷ 0.2 W) with nozzle-flapper or jet pipe | Unidirectional servosolenoid (10 ÷ 20 W) |
| Input current | 100 ÷ 200 mA | <3 A |
| Flow rate | 2 ÷ 200 l/min (two stage type) with valve pressure drop = 70 bar | 10 ÷ 500 l/min (single stage type) with valve pressure drop = 10 bar |
| Hysteresis | <3% (<1% with dither) | <6% (<2% with electric feedback) |
| Bandwidth | >100 Hz depending on the amplitude of the input and of the supply pressure | <100 Hz depending on the amplitude of the input |
| Radial clearance of the spool | 1 μm (aerospace) 4 μm (industrial) | 2 ÷ 6 μm |
| Dead band of the spool | <5% of the stroke | Overlap 10–20% of the stroke, less if compensated |

characteristic of the dynamic type. This is because it refers to a frequency diagram of the component and defines the frequency at which the response drops by 3 dB below the low frequency value. Normally, a bandwidth two to five times greater is required for continuous control valves compared with that required by the system.

The main differences between servovalves and proportional valves are shown in [Table 20.11](#). Except for the traditional difference in the electromechanical conversion device, there are overlaps in the static and dynamic characteristics in many components available on the market.

On the basis of the generically superior static and dynamic characteristics, servovalves are commonly used in closed loop controls while proportional valves are used in open loop systems.

Servovalves

Two-stage models are very common in the context of servovalves, where a first pilot stage converts a low power electric signal into a pressure difference capable of acting on the slide valve of the second stage, usually four-way and symmetrical. Flow rate control servovalves are divided into two categories on the basis of how they make the electric–hydraulic conversion:

- nozzle-flapper,
- jet-pipe.

An example of nozzle flapper servovalves is shown in [Fig. 20.102](#). It comprises two stages: the former consists of a torque motor, the flapper, and a system of nozzles and chokes, while the latter consists mainly of the spool valve and output ports. The torque motor, constituted by the motor coil, the magnet, the armature, and the polepiece, is capable of transmitting a torque to the flapper which undergoes an angular displacement, thereby obstructing one of more calibrated nozzles to a greater degree. This operation causes a pressure difference at the ends of the spool, thereby causing the latter to move until the feedback wire, which connects the spool and the flapper, returns the flapper to the central position. Through the flow metering slot carried out in the bushing, the spool thereby permits communication between the various ports. The feedback wire is an elastic flexional element that provides the feedback between the main power stage (spool valve) and the first stage (torque motor).

This type of valve usually requires a greater degree of oil filtration, as nozzle-flappers are more sensitive to contaminants compared with the jet-pipe system.

[Figure 20.103](#) shows a schematic section of an example of a servovalve of the jet-pipe type. It is connected to orifice P (supply) of the servovalve by means of a filter and flexible hose. It should be noted that, unlike the nozzle-flapper valve, it is not necessary to filter the entire incoming oil flow, but only what is called the control flow (the one going through the jet-pipe); this is certainly an advantage in terms of economic running and sensitivity to solid contamination. Starting with a standardized input voltage, the amplifier produces a voltage increase in one torque motor coil and an identical reduction in

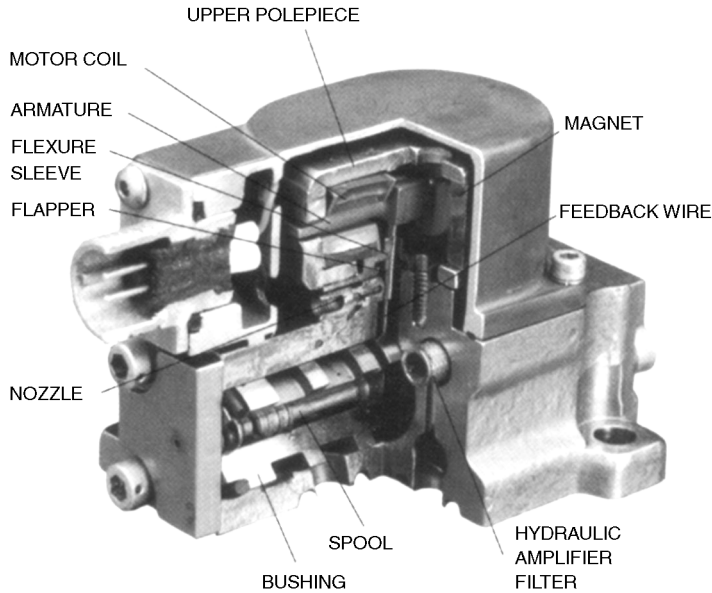

FIGURE 20.102 Nozzle-flapper servovalve (Moog).

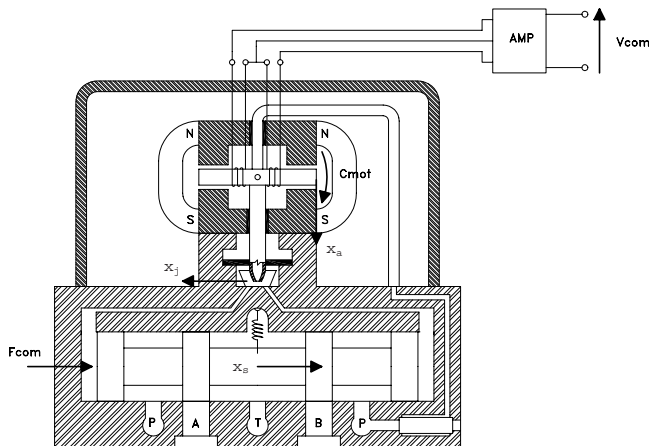

FIGURE 20.103 Jet-pipe servovalve scheme.

the other. This provokes an imbalance of the forces at the ends of the motor armature, generating a torque which tends to make the armature itself rotate and the jet-pipe with it. The displacement of the nozzle involves a different distribution of the control flow between the two pipes below it and, as a result, a pressure difference is created at the ends of the spool with a consequent net force on it, which causes its displacement. A spring element connects the spool and the jet-pipe, creating position feedback. The displacement of the spool and jet-pipe deforms the feedback spring, giving rise to a force proportional to it, and this makes it possible to balance the torque applied to the jet-pipe and the force generated at the ends of the spool. In this way, the system finds an equilibrium position, proportional to the input voltage. The feedback spring also produces centering of the slide valve at rest, making the presence of centering springs superfluous. Figure 20.104 shows the block diagram of the jet-pipe servovalve components with annotations of the physical magnitudes present in Fig. 20.103.

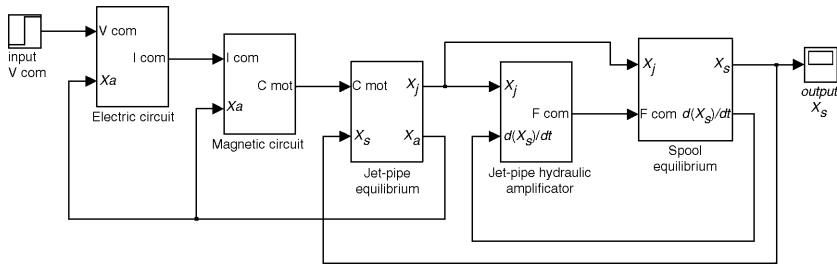

FIGURE 20.104 Block diagram of a jet-pipe servovalve.

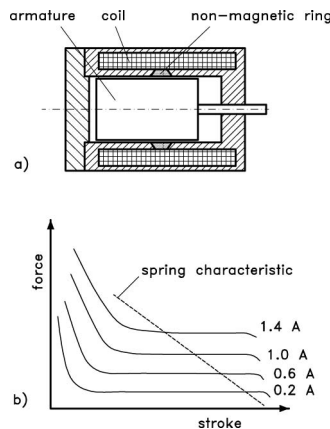

FIGURE 20.105 Proportional servosolenoid: (a) solenoid section scheme, (b) solenoid characteristics.

Proportional Valves

Proportional valves can be subdivided into proportional in flow and proportional in pressure (relief and pressure reduction) valves. In the first case, the action of the servosolenoid armature (Fig. 20.105(a)) displaces the main spool of the valve, which is checked by a spring on the valve body.

The characteristics of the force generated by the servosolenoid, along the entire possible stroke of the spool, is a function of the input current only, as indicated in Fig. 20.105(b). For all possible values of the input current, the equilibrium of the magnetic force supplied by the solenoid and of the feedback forces of the spring is determined by reaching a certain position value.

In cases in which precise positioning of the slide valve is requested, position feedback is introduced. The photograph of a proportional valve of this type is shown in Fig. 20.106. The input signal to the servosolenoid, sent by the feedback module, is the error compensated by a PID network between the reference signal and the feedback signal from the position transducer LVDT. The valve's accuracy and repeatability is improved by using the position feedback, as the hysteresis errors and those due to friction between the moving parts are partially compensated.

Flow proportional valves can have two stages. In this case, the outputs of the pilot proportional valve feed the end chambers of a spool valve of greater size, permitting greater controlled flows to be obtained while reducing dynamic performance at the same time. An example of a two-stage flow proportional valve is shown in Fig. 20.107.

In pressure regulator proportional valves, the action of the servosolenoid acts on a conical needle in such a way so as to regulate the pressure in the chamber upstream from the needle itself. Figure 20.108 shows the plan of a pilot operated proportional relief valve.

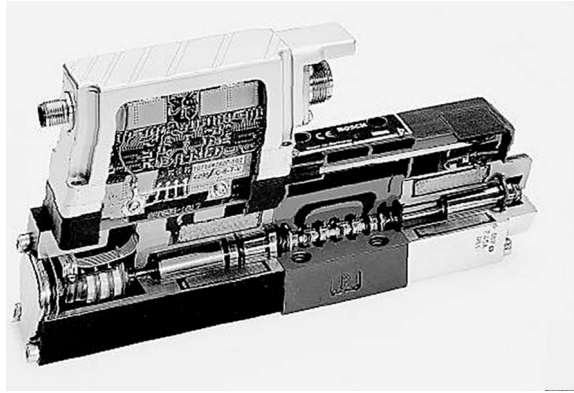

FIGURE 20.106 Flow proportional valve (Bosch Rexroth).

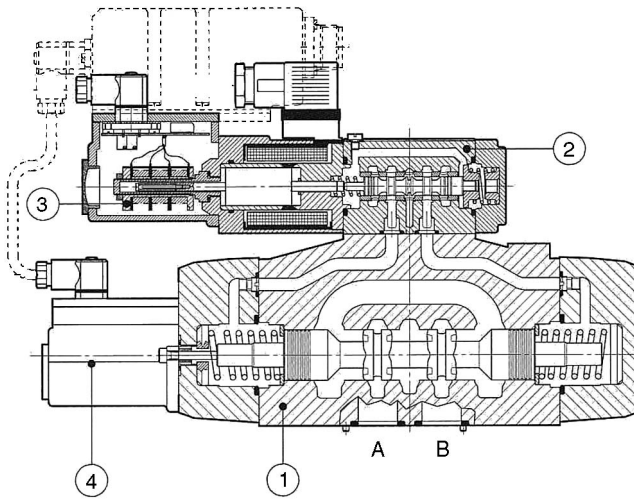

FIGURE 20.107 Double stage flow proportional valve: (1) main spool valve stage, (2) pilot stage, (3) LVDT of the pilot stage, (4) LVDT of the main stage (Atos).

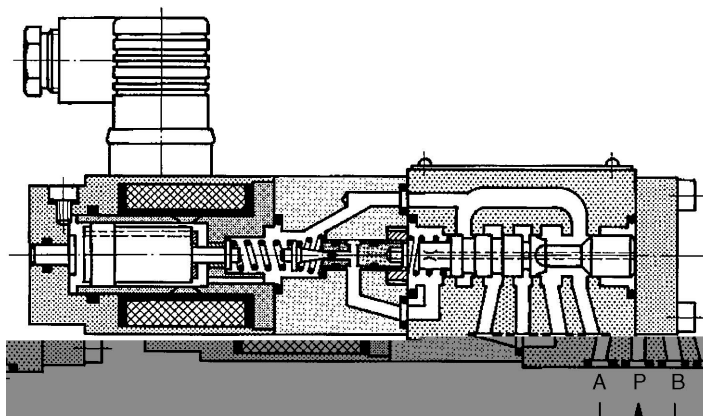

FIGURE 20.108 Proportional pressure relief valve (Bosch Rexroth).

Modeling of a Hydraulic Servosystem for Position Control

Figure 20.109 shows the scheme of a hydraulic servo system for position control constituted by a double acting, double ended actuator controlled in closed loop by a four-way servovalve. The x position of the piston is determined by the equilibrium of the forces acting on it: external force, thrust due to the pressures P_1 and P_2 acting in the chambers of the ram, friction force, and force of inertia. The pressures P_1 and P_2 are determined by the oil flows Q_{C1} and Q_{C2} entering and leaving the chambers. Flow rate Q_{FI} represents the oil leakage flow between the piston and the barrel. The flow proportional valve controls the oil flow on the basis of the reference signal ref from a compensator G_C . The input to the compensator is the error e_V between the signal V_{SET} , corresponding to the desired rod position x_{SET} , and the feedback signal $V_{F/B}$, corresponding to the effective rod position x measured by a position transducer LVDT.

The actuator is modeled by considering the equations of flow continuity in the chambers and the dynamic equilibrium equation for the rod. The continuity equation is expressed in a general form:

$$\rho \left(\sum Q_{IN} - \sum Q_{OUT} \right) = \frac{d(\rho V)}{dt} = \rho \frac{dV}{dt} + V \frac{d\rho}{dt} \quad (20.39)$$

where

- $\sum Q_{IN}$ = sum of the flows in volume entering
- $\sum Q_{OUT}$ = sum of the flows in volume leaving
- ρ = density
- V = volume
- t = time

From the definition of the compressibility modulus of the oil β , P being the pressure in the chamber considered:

$$\frac{dV}{V} = -\frac{d\rho}{\rho} = -\frac{dP}{\beta} \quad (20.40)$$

We obtain

$$\sum Q_{IN} - \sum Q_{OUT} = \frac{dV}{dt} + \frac{V}{\beta} \frac{dP}{dt} \quad (20.41)$$

The continuity equation for chamber 1 is

$$Q_{C1} - Q_{FI} = A_c \dot{x} + \frac{V_0 + A_c x + V_{sm}}{\beta} \frac{dP_1}{dt} \quad (20.42)$$

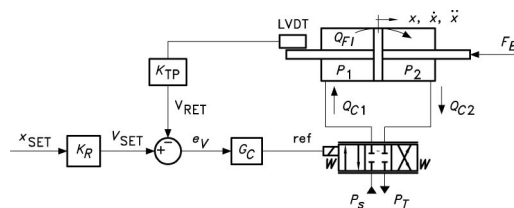

FIGURE 20.109 Scheme of a hydraulic servosystem with position control.

The continuity equation for chamber 2 is

$$Q_{F1} - Q_{C2} = A_c \dot{x} + \frac{V_0 - A_c x + V_{sm}}{\beta} \frac{dP_2}{dt} \quad (20.43)$$

where

Q_{C1} = flow entering chamber 1

Q_{C2} = flow leaving chamber 2

Q_{F1} = leakage flow between piston and barrel

A_c = thrust section = $(D_{al}^2 - D_{st}^2)\pi/4$

D_{al} = bore diameter

D_{st} = rod diameter

V_0 = volume of the chambers with piston centered = $A_c L/2$

L = stroke

x = piston displacement ($x = 0$ in centered position)

V_{sm} = dead band volume

The dynamic equilibrium equation of the piston is

$$P_1 A_c - P_2 A_c - F_e - M\ddot{x} - F_A = 0 \quad (20.44)$$

where

M = translating mass

F_e = external force

F_A = force of friction = $\gamma\dot{x} + F_{ATT} \text{sign}(\dot{x})$

γ = coefficient of viscous friction

F_A = force of coulomb friction

Leaks can be modeled as resistances in laminar and steady-state conditions of the following type:

$$R = \frac{\Delta P}{Q} \quad (20.45)$$

where

R = resistance

Q = flow rate

ΔP = pressure difference

In the case of an annular pipe, we get

$$Q = \frac{\pi D h^3 (1 + 1.5 \epsilon^2)}{12 \mu l} \Delta P \quad (20.46)$$

where

D = seat diameter

h = meatus thickness = $(D - d)/2$

d = spool diameter

ϵ = eccentricity = $2e/(D - h)$

e = distance between seat axis and spool axis

μ = dynamic viscosity

l = meatus length

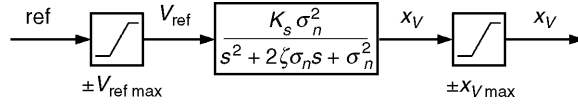

FIGURE 20.110 Block diagram of the valve.

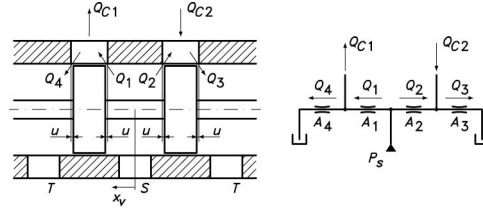

FIGURE 20.111 Reference scheme of the flow rates through the proportional valve.

The dynamic behavior of the electromechanical converter and of the spool valve can be identified with a linear model of the second order between the reference ref and the slide valve position x_v , as indicated in Fig. 20.110, where K_s (m/V) is the static gain of the valve, σ_n (rad/s) the natural frequency of the valve, and ζ the damping factor of the valve.

The flows regulated by the proportional valves are indicated in detail in the plan in Fig. 20.111. Having defined the areas A_1, A_2, A_3, A_4 , functions of the spool displacement x_v , on the basis of the geometry, the flows transiting through the valve as a function of the pressures are given by

$$Q_1 = A_1 C_d \text{sign}(P_s - P_1) \sqrt{\frac{2}{\rho} |P_s - P_1|} \quad (20.47)$$

$$Q_4 = A_4 C_d \text{sign}(P_1 - P_T) \sqrt{\frac{2}{\rho} |P_1 - P_T|} \quad (20.48)$$

$$Q_2 = A_2 C_d \text{sign}(P_s - P_2) \sqrt{\frac{2}{\rho} |P_s - P_2|} \quad (20.49)$$

$$Q_3 = A_3 C_d \text{sign}(P_2 - P_T) \sqrt{\frac{2}{\rho} |P_2 - P_T|} \quad (20.50)$$

where P_s is the supply pressure, P_T is the pressure of the discharge reservoir, and C_d is the flow coefficient of the metering ports.

Therefore we get

$$Q_{C1} = Q_1 - Q_4 \quad (20.51)$$

$$Q_{C2} = Q_3 - Q_2 \quad (20.52)$$

The system of equations given above can be linearized in a working neighborhood, defined by the passage area of the valve A_{V0} , load pressure drop $P_{L0} = P_1 - P_2$, and piston position x_0 . In the hypothesis

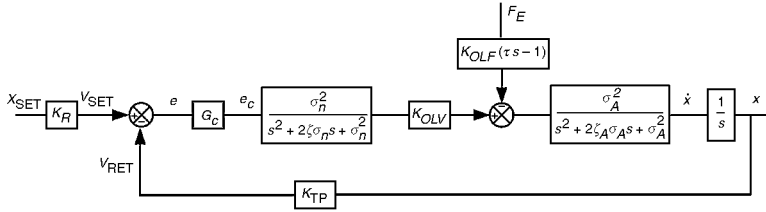

FIGURE 20.112 Block diagram of the linearized model of an hydraulic servosystem with position control.

that the leaks are negligible, the diagram of the linearized system is shown in Fig. 20.112, which indicates:

| | |
|--|--|
| G_C | compensator transfer function [V/V] |
| $K_{OLV} = \frac{K'_S K_Q A_C}{A_C^2 - K_{PQ}\gamma}$ | static speed gain $\left[\frac{\text{m/s}}{\text{V}}\right]$ |
| $K_{TP} = K_R$ | static gain of the position transducer [V/m] |
| $K_{OLF} = \frac{K_{PQ}}{A_C^2 - K_{PQ}\gamma}$ | force constant $\left[\frac{\text{m}}{\text{sN}}\right]$ |
| σ_n | natural frequency of the proportional valve [rad/s] |
| ζ | proportional valve damping factor |
| $\sigma_A = \sqrt{\frac{C_0}{M}[1 - (K_{PQ}\gamma/A_C^2)]}$ | hydraulic resonance frequency [rad/s] |
| $\zeta_A = \frac{\gamma - (MK_{PQ}C_0/A_C^2)}{2\sqrt{C_0M}[1 - (K_{PQ}\gamma/A_C^2)]}$ | hydraulic damping factor |
| $\tau = \frac{A_C^2}{C_0K_{PQ}}$ | force disturbance time constant [s] |

where, in the above expressions:

| | |
|---|---|
| $K'_S = \frac{A_{V\max}}{V_{\max}}$ | proportional valve static gain $\left[\frac{\text{m}^2}{\text{V}}\right]$ |
| $K_Q = \frac{\partial Q}{\partial A_V} \Big _{A_{V0}, P_{L0}}$ | proportional valve flow gain $\left[\frac{\text{m}^3}{\text{s m}^2}\right]$ |
| A_C | piston area [m ²] |
| $K_{PQ} = \frac{\partial Q}{\partial P_L} \Big _{A_{V0}, P_{L0}}$ | proportional valve flow-pressure gain $\left[\frac{\text{m}^3}{\text{s Pa}}\right]$ |
| γ | coefficient of viscous friction $\left[\frac{\text{N}}{\text{s/m}}\right]$ |
| $C_0 = \frac{4\beta A_C^2}{V_T}$ | hydraulic stiffness in centred position [N/m] |
| V_T | total volume of the two chambers [m ³] |
| M | mass of the moving parts [kg] |

The open loop transfer function is

$$G_{OL} = \frac{V_{RET}}{e} = G_C \cdot K_{OLV} \cdot K_{TP} \frac{\sigma_n^2}{s^2 + 2\zeta\sigma_n s + \sigma_n^2} \cdot \frac{\sigma_A^2}{s^2 + 2\zeta_A\sigma_A s + \sigma_A^2} \cdot \frac{1}{s} \quad (20.53)$$

Supposing G_C to be constant, the static gain in open loop is

$$K_0 = G_C \cdot K_{OLV} \cdot K_{TP} = \frac{G_C K'_S K_Q A_C K_{TP}}{A_C^2 - K_{PQ} \gamma} \quad (20.54)$$

The closed loop transfer function is

$$\begin{aligned} G_{CL} &= \frac{x}{X_{set}} = \frac{K_R G_C K_{OLV} \sigma_n^2 \sigma_A^2}{(s^2 + 2\zeta\sigma_n s + \sigma_n^2)(s^2 + 2\zeta_A\sigma_A s + \sigma_A^2)s + G_C K_{OLV} \sigma_n^2 \sigma_A^2 K_{TP}} \\ &= \frac{1}{a_5 s^5 + a_4 s^4 + a_3 s^3 + a_2 s^2 + a_1 s + 1} \end{aligned} \quad (20.55)$$

where

$$\begin{aligned} a_5 &= \frac{1}{\sigma_n^2 \sigma_A^2 K_0}, \quad a_4 = \frac{2}{\sigma_n \sigma_A K_0} \left(\frac{\zeta_A}{\sigma_n} + \frac{\zeta}{\sigma_A} \right) \\ a_3 &= \frac{1}{K_0} \left(\frac{1}{\sigma_n^2} + \frac{4\zeta_A \zeta}{\sigma_n \sigma_A} + \frac{1}{\sigma_A^2} \right), \quad a_2 = \frac{2}{K_0} \left(\frac{\zeta}{\sigma_n} + \frac{\zeta_A}{\sigma_A} \right), \quad a_1 = \frac{1}{K_0} \end{aligned}$$

The transfer function between output and disturbance, said dynamic compliance, is

$$G_{FCL} = \frac{x}{F_e} = \frac{K_{OLF}(\tau s - 1)(s^2 + 2\zeta\sigma_n s + \sigma_n^2)\sigma_A^2}{(s^2 + 2\zeta\sigma_n s + \sigma_n^2)(s^2 + 2\zeta_A\sigma_A s + \sigma_A^2)s + G_C K_{OLV} \sigma_n^2 \sigma_A^2 K_{TP}} \quad (20.56)$$

Static compliance is

$$\left. \frac{x}{F_e} \right|_{s=0} = \frac{K_{OLF}}{G_C K_{OLV} K_{TP}} = \frac{K_{PQ}}{G_C K'_S K_Q A_C K_{TP}} = \frac{1}{G_C K'_S K_P A_C K_{TP}} \quad (20.57)$$

having put

$$K_{PQ} = \frac{K_Q}{K_P}, \quad K_P = \left. \frac{\partial P_L}{\partial A_V} \right|_{A_{V0}, P_{L0}} \quad \text{pressure gain} \left[\frac{\text{Pa}}{\text{m}^2} \right]$$

Finally, a static stiffness is defined equal to

$$\left. \frac{F_e}{x} \right|_{s=0} = G_C K_S' K_P A_C K_{TP} \quad (20.58)$$

The predominant time constant, which is obtainable from the closed loop transfer function, is the coefficient $a_1 = 1/K_0$.

In conclusion, the following general considerations can be drawn:

- The speed gain K_{OLV} , and therefore the open loop static gain K_0 , depend to a considerable degree on the flow gain K_Q and increase with increases in K_Q . K_Q increases as P_S increases, decreases as ΔP_{L0} increases, and does not vary with A_{V0} . In the hypothesis of γ below 1000 Ns/m, the effect of K_{PQ} is modest, practically negligible.
- The force constant K_{OLF} depends on the flow-pressure gain K_{PQ} and increases with it. $|K_{PQ}|$ increases with A_{V0} and with ΔP_{L0} , while it decreases as P_S increases; therefore $|K_{OLF}|$ decreases as P_S increases. Leaks lead to an increase in K_{OLF} .
- Static stiffness depends considerably on the pressure gain of the valve and increases with it. Given that K_P decreases with the leaks, these lead to a reduction in static stiffness. Furthermore, given that $|K_{PQ}|$ increases with A_{V0} while K_Q does not vary with A_{V0} , the pressure gain decreases with the increase in A_{V0} , and therefore static stiffness decreases if the valve is working in greater opening conditions.

Furthermore, given that $|K_{PQ}|$ decreases as P_S increases, while K_Q increases as P_S increases, the pressure gain increases as P_S increases and therefore, the static stiffness increases with P_S .

- The hydraulic resonance frequency increases with the increase in hydraulic stiffness C_0 and decreases with the increase of the mass M . It is practically uninfluenced by the flow-pressure gain K_{PQ} if $\gamma < 1000$ Ns/m.
- The predominant time constant is inversely proportional to the speed gain, decreases as K_Q increases, that is it decreases as P_S increases, increases as ΔP_{L0} increases, and is indifferent to variations in A_{V0} .

Pneumatic Actuation Systems

Just as described for the hydraulic system, the components of a pneumatic actuation system are:

- the compressed air generation system, consisting of the compressor, the cooler, possibly a dryer, the storage tank, and the intake and output filters;
- the compressed air treatment unit, usually consisting of the FRL assembly (filter, pressure regulator, and possibly a lubricifier), which permits filtration and local regulation of the supply pressure to the actuator valve;
- the valve, that is, the regulator of the pneumatic power;
- the actuator, which converts the pneumatic power into mechanical power;
- the piping;
- the sensors and transducers;
- the system display, physical magnitude measurement, and control devices.

Some of the components of the pneumatic actuation system such as the compressors, treatment units, and some valves used in pneumatic servosystems are described below. The actuators are similar in function and construction to hydraulic ones, though they are built slightly lighter because of the lower working pressure.

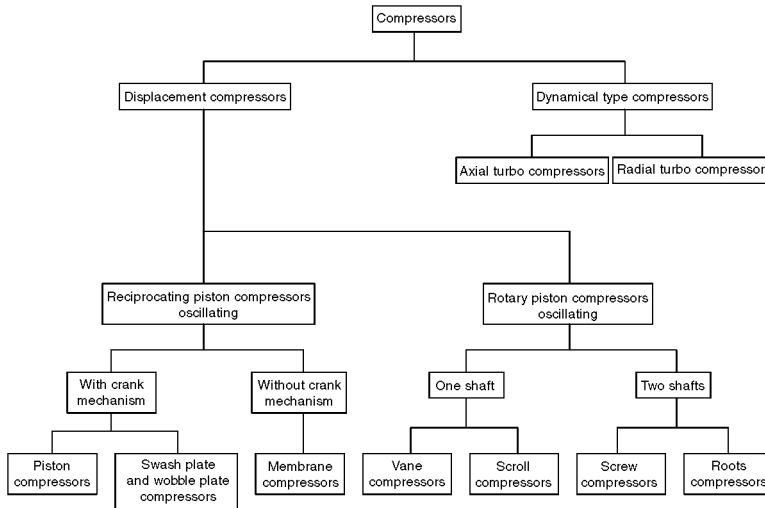

FIGURE 20.113 Classification of pneumatic compressors.

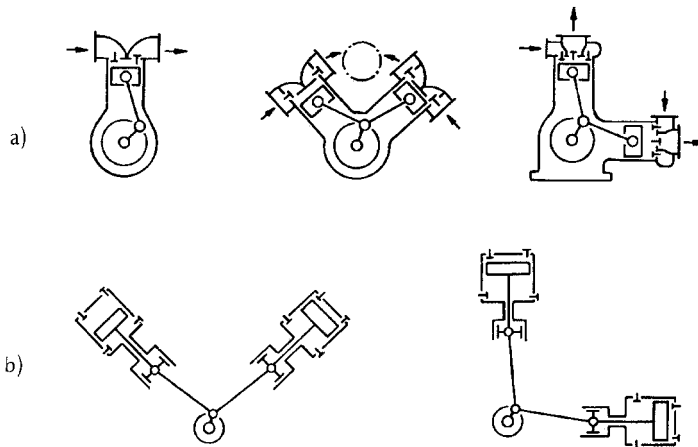

FIGURE 20.114 Piston compressors: (a) single action, (b) double action.

Compressors

The types of compressors used to produce compressed air are summarized in Fig. 20.113. In volumetric compressors, the air or gas is sucked in by means of a valve in the compression chamber where its volume is reduced to cause compression of the gas. Opening of the delivery valve, when a predetermined pressure has been reached, results in the distribution of the air mass to the user.

Vice versa, in dynamic compressors or turbocompressors, the kinetic energy is converted into pressure energy transferred to the gas as a result of the rotary motion of the impeller.

Alternating piston compressors determine the compression of the gas as an effect of the motion of the piston, moved by a connecting rod and crank mechanism, inside a gas-tight cylinder. They can be single and double acting, with one or more pistons and one or more stages (Fig. 20.114). They make it possible to obtain pressures of hundreds bar, where there are several stages, and flow rates of thousands of cubic meters per hour, in the case of several cylinders. Vane compressors (Fig. 20.115) have a rotor, fitted eccentrically with respect to the axis of the cylinder in which it rotates, which leads to a certain

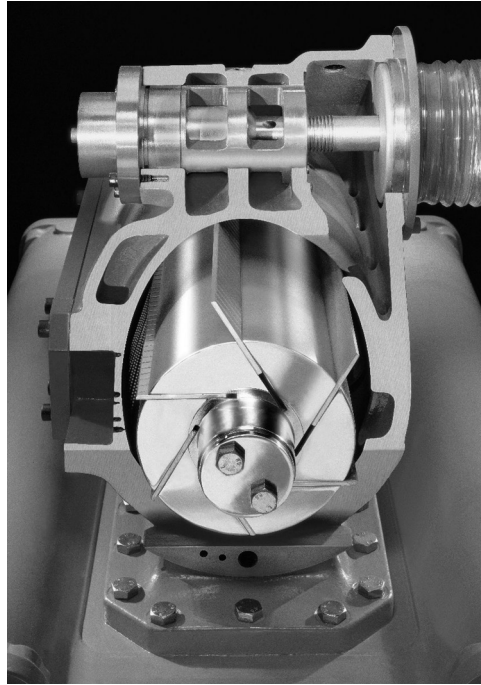

FIGURE 20.115 Rotary vane compressor (Pneumofore).

number of vanes which can move radially with respect to its axis. In the continuous rotation motion of the rotor, the vanes are centrifuged in contact with the seat of the stator, isolating chambers whose volume varies progressively with the angular stroke, guaranteeing input suction on the one hand, and a compressed gas output on the other. The compression pressures are below 15 bar, with maximum flow rates of $500 \text{ m}^3/\text{h}$. Compared with reciprocating piston compressors, they have less flow pulsation, fewer vibrations, and are more compact.

Screw compressors have two rotors rotating in opposite directions inside a stator, one with convex lobes and the other with concave lobes. The coupling of the profiles of the two rotors leads to a reduction of the volume during the angular stroke and consequent compression of the gas. With pressures typically below 15 bar, they provide a sufficiently continuous flow, up to values of about $3000 \text{ m}^3/\text{h}$.

In the same way, Roots compressors, also known as superchargers, are made up of two figure-of-eight-shaped rotors counter-rotating inside a stator in such a way as to transport volumes of gas from suction to delivery. Their efficiency is low because of the leakage between the rotors themselves and between the lobes and the casing, and they are, therefore, used for low compression pressures, below 2 bar. However, they do permit operation without lubrication, like screw compressors, so that oil-free air can be obtained.

Both axial and radial dynamic compressors are used to obtain high compressed air flow rates from a few thousand to $100,000 \text{ m}^3/\text{h}$.

Compressed Air Treatment Units

Pneumatic supply to a servosystem is generally provided by a local gas treatment unit, consisting of a filter, connected to a compressed gas distribution and generation network, a pressure regulator, and in case a lubricator *L*. [Figure 20.116](#) shows an example of an integrated filter device and pressure regulator. The air first passes through the filter and is filtered by the deflector while the solid and liquid impurities in contact with the walls are deposited on the bottom of the cup, also as an effect of the conical bottom screen, located below the porous cylindrical element in sintered bronze or fabric. The filtered air then flows into the inlet of the pressure regulator, made up of an obturator in equilibrium between pressure

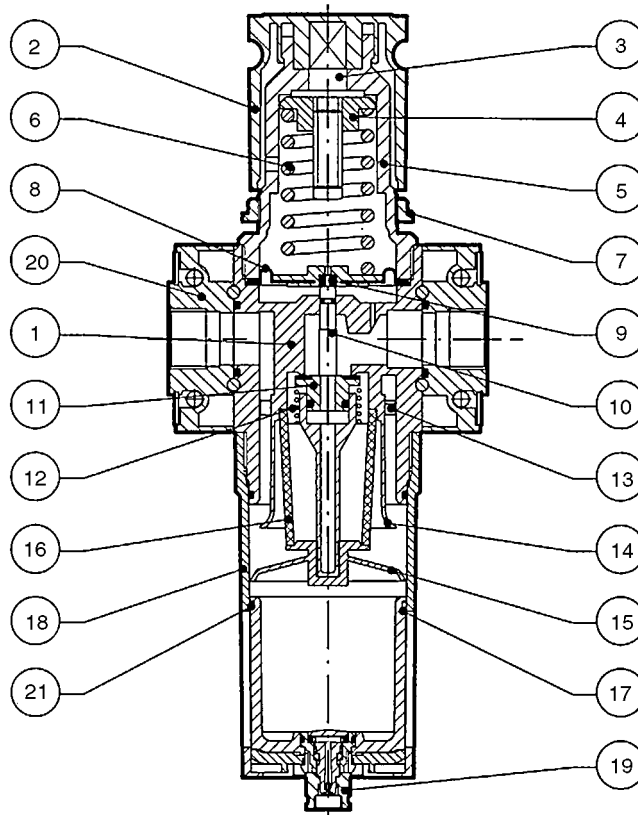

FIGURE 20.116 Pneumatic filter/pressure reducer (Metal Work).

forces. Control of the downstream pressure is determined by the position of the main obturator, which regulates the flow towards the outlet. The passage aperture is closed when the force due to the downstream pressure, acting on a diaphragm and on a translating piston, is in equilibrium with the force of the top spring, the preload of which is set by the rotation of the control knob. Vice versa, if the pressure force is below the desired value, the flow sent to the user tends to compensate for the pressure error with consequent closing of the obturator again when the set point has been reached. The opposite situation occurs if the regulated pressure is above the requested value, so that an aperture passage opens between the user and discharge.

Pneumatic Valves

Pneumatic valves are functionally similar to those used in hydraulic systems, so that reference should be made to the general considerations described above. In particular, this is also valid for the directional valves of the digital and proportional types. Even in pneumatic systems, there are digital spool or poppet two-, three-, or four-way distributors, with two or three working positions, and actuated manually, mechanically, pneumatically, and electrically.

Flow proportional valves are substantially similar to hydraulic ones and are available both with the torque motor electromechanical converter (servovalve), and with servosolenoid acting directly on the spool.

As well as these components for controlling the gas flow, digital electrically controlled two- or three-way valves are also used, and their control signals are modulated using PWM (pulse width modulation), PFM (pulse frequency modulation), PCM (pulse code modulation), PNM (pulse number modulation), or a combination of these.

As far as pressure regulation valves are concerned, three-way pressure proportional valves are available for pneumatic actuation which convert an electrical reference signal with standardized input into a controlled output pressure with good dynamics and high precision.

PWM (Pulse Width Modulation) Valves

The structure of PWM valves is similar to the corresponding electrically controlled unistable digital valves, but uses a technique for modulating the width of the pulses sent to the solenoid for supplying proportional control of the flow rate. This technique envisages that the input voltage reference analog signal V_{REF} (for example 0–10 V) is converted by a special driver into a digital V_{PWM} (ON/OFF) signal with pulse duration proportional to the input signal. Alternatively, the modulated signal can be generated directly by a digital controller, such as a PLC.

Figure 20.117 shows the PWM operating principle. The digital voltage signal sent to the valve solenoid is made up of a pulse train, with a constant amplitude, with a constant period T , but with the duration t of every pulse being a linear function of the analog value of the reference voltage. The average valve opening value, and therefore an initial approximation of the generated flow, is a function of the duration t of the pulse, in particular of the duty cycle t/T , and increases as the latter increases.

PWM valves generally do not have any feedback, so that the value of the downstream pressure, and therefore of the flow rate, depends on the type of pneumatic circuit present.

Figure 20.118 shows two plans which depict operation of the two-way, two-position valves, with PWM, used as a flow regulator (Fig. 20.118(a)) and as a pressure regulator (Fig. 20.118(b)). In plan a, the valve proportionally controls the flow which transits between the two points at pressure P_S (feed pressure) and at pressure P_V (downstream pressure) maintained constant. In this case, this flow is only a function of the aperture of the valve and therefore the proportionality is of the linear type. In plan b, the cross-fitted valves control the pressure P_R , for example, within a fluid capacity of volume V , respectively regulating the mass flow rate G_1 and discharge flow G_2 . The time gradient for the controlled pressure P_R corresponds to the resulting flow G entering the reservoir.

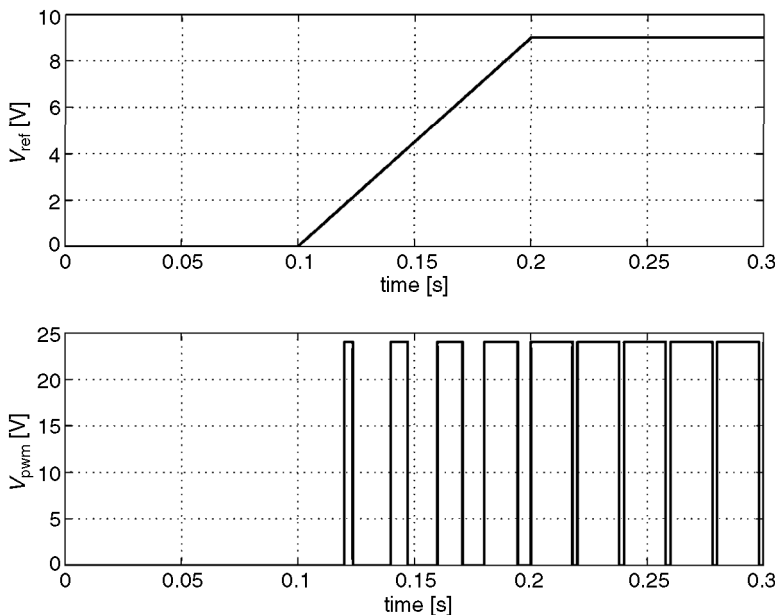

FIGURE 20.117 PWM (pulse width modulation) input and output signals.

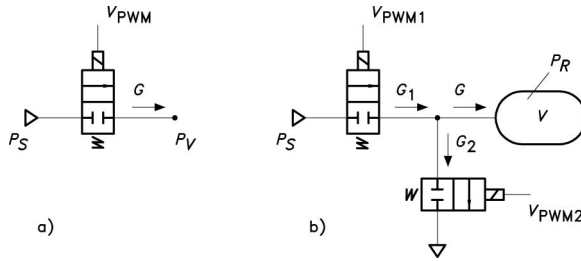

FIGURE 20.118 PWM (pulse width modulation) digital valves: (a) flow regulator, (b) pressure regulator.

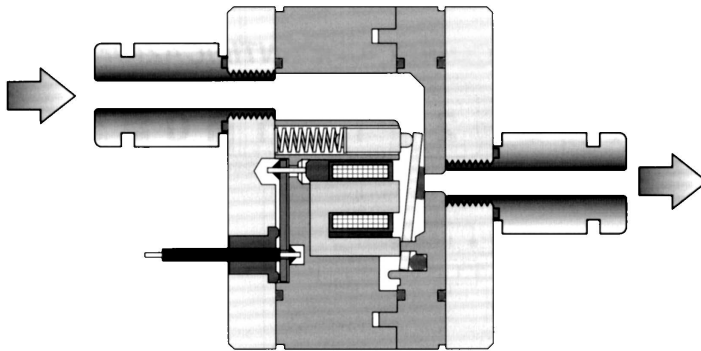

FIGURE 20.119 Two-way digital poppet valve (Matrix).

The parameters affecting the performance of a regulation made by a PWM on/off valve are as follows:

- valve opening and closing times
- dependence on the opening/closing times of the upstream and downstream pressures
- valve size
- period T or modulation carrier frequency $f = 1/T$
- working life of the valve

While small opening/closing times and high flow capacity are always antithetical characteristics in an on/off valve, when designing the system it is always necessary to find a compromise between the need for good control resolution and linearity and a high response dynamic.

In pneumatic servosystem applications, typical carrier frequency values $f = 1/T$ range between 20 and 100 Hz, so that valves with opening/closing times of $1 \div 5$ ms are used.

An example of a normally closed 2/2 valve that guarantees minimum opening times (below 1 ms with speed-up command) can be seen in Fig. 20.119. These characteristics are obtained by reducing the mass of the moving parts, with the use of a poppet connected to a small oscillating bar, while practically eliminating the friction between the parts in relative motion.

Proportional Pressure Regulator Valves

These valves are normally three-way, with double poppets or with spool. Poppet valves operate in a similar way to pressure regulator valves. In the same way as with pressure regulators, the poppet which separates the high pressure environment from the regulated pressure one is in equilibrium between the force due to the regulated pressure and that exerted by the action of the control block. The latter can directly be the force of the servosolenoid armature, or that due to a pressure controlled by the control block which acts on a piston or on a diaphragm linked with the poppet.

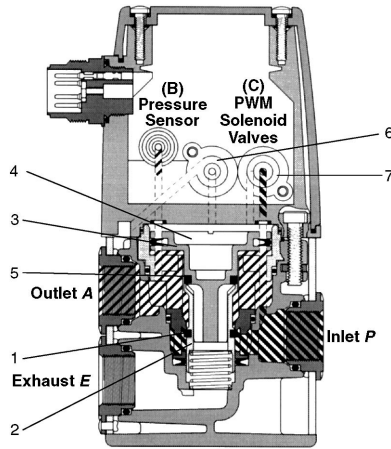

FIGURE 20.120 Pressure proportional valve (Parker).

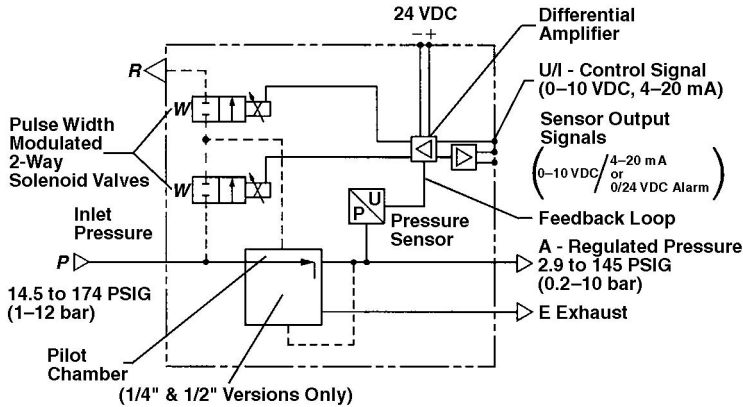

FIGURE 20.121 Pneumatic control scheme of the pressure proportional valve.

Figure 20.120 shows an example of a pressure proportional valve with double poppets. The ports at supply pressure, controlled pressure, and discharge are respectively indicated by P , A , and E . In the position indicated in the figure, the supply poppet 2 is at the top end of its stroke, as the seal 1 is against the fixed seat. In the same way, the regulating poppet 3 is in contact with the poppet 2 by means of the seal 5. The opening of the feed aperture, between the port P and the port A , is determined by the equilibrium of the forces acting on the piston of poppet 3, in particular the force F_R of the regulation pressure P_R in the servo chamber 4 directed downwards, and the force F_C due to the action of the regulated pressure P_C on the outlet, directed upwards. If $F_R = F_C$, the moving bodies in the valve are in the positions shown in the figure, so that the chamber at controlled pressure P_C is isolated both from supply and discharge. If $F_R > F_C$, then the two poppets move downwards and the feed aperture is opened so as to convey the air mass towards the output and rebalance the pressure P_C at the desired value. In the opposite case, if $F_R < F_C$, the regulating poppet moves upwards, but while remaining at the top end of its stroke, the seal 5 opens and permits the passage of the masses from port A to the exhaust E .

In Fig. 20.120, 6 and 7 indicate the PWM on/off valves, which regulate the pressure P_R of the servo chamber 4.

The pneumatic control plan of the valve is shown in Fig. 20.121. The two 2-way PWM valves receive the modulated control signal from the regulation block. These are fitted in such a way that one controls

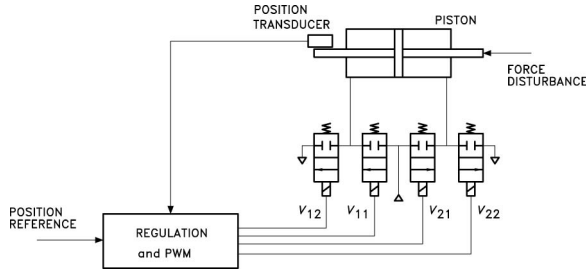

FIGURE 20.122 Scheme of a pneumatic servosystem with two-ways digital valves.

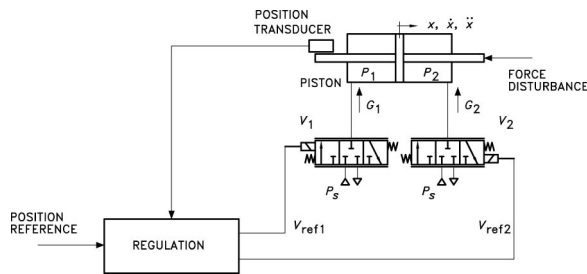

FIGURE 20.123 Scheme of a pneumatic servosystem with three-ways proportional valves.

a flow entering the servochamber 4 (see Fig. 20.120) while the other controls the flow exiting towards discharge. By means of appropriate action, the control signal is converted into a pressure proportional signal.

Modeling a Pneumatic Servosystem

The circuitry plan of a pneumatic servosystem capable of controlling the position, speed, or force can be similar to that shown in Fig. 20.109 for hydraulic actuation. The signal of the transducer of the desired magnitude must be specially fed back in a closed loop on the regulator depending on the controlled magnitudes.

In the plan in Fig. 20.122, the axial position of the piston, fed back by means of the position transducer, is determined by controlling the pressure in thrust chambers 1 and 2 by means of the flow proportional interfaces. The position reference is compared with the feedback signal and the error is compensated in a control regulator. On the basis of the valve opening strategy used, the signal is sent to the regulating valves which feed the chambers of the piston, hypothesized to be symmetrical. The pressure forces acting on the thrust surfaces of the piston oppose the external force disturbance. The circuitry plan hypothesizes the use of four digital valves each with two unstable ways, electrically controlled. This solution makes it possible to use small-sized valves, with resulting high bandwidth, which must be compatible with the overall bandwidth requested by the pneumatic servosystem. In this solution, the proportionality of the opening of the valves is obtained by pulse width modulation of the digital signal. Each pair of valves V_{11} , V_{12} and V_{21} , V_{22} constitutes a three-way valve the output of which is connected to a piston chamber, so that the scheme in Fig. 20.122 can be equivalent to that in Fig. 20.123 with the three-way analogically controlled valves V_1 and V_2 .

The cylinder model envisages a system with three-differential equations, two of continuity of the air mass in the chambers and one of dynamic translation equilibrium.

The following magnitudes are differentiated (the subscripts 1 and 2 refer, respectively, to the rear 1 and front 2 chambers of the pistons):

| | |
|-----------|---|
| A | piston thrust section |
| F_e | disturbance of force acting on the piston rod |
| G | mass flow rate of air entering the chamber |
| M | mass of the translating parts of the piston |
| n | air polytropic coefficient |
| P | cylinder chamber pressure |
| P_i | initial cylinder chamber pressure |
| P_{amb} | ambient pressure |
| R | air constant |
| T_i | initial cylinder chamber air temperature |
| x | rod position measured starting from x_0 |
| x_0 | piston half stroke |
| x_m | dead band |
| γ | coefficient of viscous friction |

The continuity and equilibrium equations are given by:

$$\frac{dP_1}{dt} = \frac{G_1 n R T_{1i}}{A_1 (x_0 + x_{m1} + x) (P_1/P_{1i})^{(1-n)/n}} - \frac{P_1 n}{(x_0 + x_{m1} + x)} \frac{dx}{dt} \quad (20.58)$$

$$\frac{dP_2}{dt} = \frac{G_2 n R T_{2i}}{A_2 (x_0 + x_{m2} - x) (P_2/P_{2i})^{(1-n)/n}} + \frac{P_2 n}{(x_0 + x_{m2} - x)} \frac{dx}{dt} \quad (20.59)$$

$$\frac{d^2 x}{dt^2} = \frac{(P_1 - P_{amb})A_1 - (P_2 - P_{amb})A_2 - F_e - \gamma dx/dt}{M} \quad (20.60)$$

The flow proportional valve V_1 is modeled as a variable section pneumatic resistance. The equations used for calculating mass flow rate G through a pneumatic resistance, characterized by a conductance C and by a critical ratio b , in accordance with ISO 6358, which connects two environments A and B , with respective pressures of P_A and P_B , taken to be positive in the $A \rightarrow B$ direction, are

$$\text{sonic flow: } G = \rho_0 P_A C \quad \text{for } 0 < \frac{P_B}{P_A} \leq b \quad (20.61)$$

$$\text{subsonic flow: } G = \rho_0 P_A C \sqrt{1 - \left(\frac{P_B/P_A - b}{1 - b}\right)^2} \quad \text{for } b < \frac{P_B}{P_A} \leq 1 \quad (20.62)$$

$$\text{sonic flow: } G = -\rho_0 P_B C \quad \text{for } 0 < \frac{P_A}{P_B} \leq b \quad (20.63)$$

$$\text{subsonic flow: } G = -\rho_0 P_B C \sqrt{1 - \left(\frac{P_A/P_B - b}{1 - b}\right)^2} \quad \text{for } b < \frac{P_A}{P_B} \leq 1 \quad (20.64)$$

Hypothesizing a bipolar reference signal, it can be assumed that the range $V_{\text{ref}} > 0$ corresponds to the supply–user connection, while the field $V_{\text{ref}} < 0$ corresponds to the user–discharge connection. The appropriate equation of flow above must be rewritten in the same way.

Calculation of the conductance of the flow proportional valve is made considering the static and dynamic link between the reference voltage V_{ref} and the opening of the passage aperture A_V in accordance with modeling of the second order of the type:

$$\frac{d^2 A_V}{dt^2} + 2\zeta\sigma_n \frac{dA_V}{dt} + \sigma_n^2 A_V = K_s \sigma_n^2 V_{\text{ref}} \quad (20.65)$$

where ζ is the damping factor, σ_n is the valve's natural frequency, and K_s is its area static gain.

Assuming a static relation of the linear type between the opening A_V and the conductance C , as an initial approximation, we get

$$C = K_c A_V = K_c K_s V_{\text{ref}} = K_V V_{\text{ref}} \quad (20.66)$$

where K_V is the flow static gain of the valve, function of the maximum conductance C_{max} , and of the maximum value of the reference voltage $V_{\text{ref max}}$:

$$K_V = \frac{C_{\text{max}}}{V_{\text{ref max}}} \quad (20.67)$$

The complete dynamic relation between reference voltage and conductance is, therefore,

$$\frac{d^2 C}{dt^2} + 2\zeta\sigma_n \frac{dC}{dt} + \sigma_n^2 C = K_c \sigma_n^2 V_{\text{ref}} \quad (20.68)$$

The nonlinear model of the pneumatic servosystem with the position reference x_{set} and the force disturbance F_e as inputs, is made up of a nonlinear system of nine equations, of order eight overall, of the type:

- | | | | |
|----|---|---------|--|
| a) | $C_1 = C_1(V_{\text{ref } 1}, t)$ | order 2 | conductance of valve V_1 (see (20.68)) |
| b) | $C_2 = C_2(V_{\text{ref } 2}, t)$ | order 2 | flow rate of valve V_1 (see (20.68)) |
| c) | $G_1 = G_1(C_1, P_1)$ | order 0 | flow rate of valve V_1 (see (20.61)–(20.64)) |
| d) | $G_2 = G_2(C_2, P_2)$ | order 0 | flow rate of valve V_2 (see (20.61)–(20.64)) |
| e) | $G_1 = G_1(P_1, \dot{P}_1, x, \dot{x})$ | order 1 | continuity chamber 1 (see (20.58)) |
| f) | $G_2 = G_2(P_2, \dot{P}_2, x, \dot{x})$ | order 1 | continuity chamber 2 (see (20.59)) |
| g) | $\ddot{x} = \ddot{x}(F_e, P_1, P_2, \dot{x})$ | order 2 | piston equilibrium (see (20.60)) |
| h) | $V_{\text{ref } 1} = V_{\text{ref } 1}(x_{\text{set}}, x_{\text{ret}})$ | order 0 | V_1 valve control |
| i) | $V_{\text{ref } 2} = V_{\text{ref } 2}(x_{\text{set}}, x_{\text{ret}})$ | order 0 | V_2 valve control |

If we want to carry out a linear analysis, it can be assumed that the equations *a*), *b*), *g*), *h*), *i*) are already written in linear form.

As far as the flow rates of valves *c*) and *d*) are concerned, it is hypothesized that the flow rate for each of them is subsonic in feed, with $V_{\text{ref}} > 0$, and sonic in discharge, with $V_{\text{ref}} < 0$. This means that for valve V_1 , for example, the pressure P_1 must be within the range $bP_s < P_1 \leq P_s$ in feed and in the range $P_1 \geq P_{\text{amb}}/b$

in discharge. This hypothesis is physically acceptable; hypothesizing $b = 0.3$, $P_s = 10$ bar, $P_{amb} = 1$ bar, we get that P_1 can vary between 3.33 bar and 10 bar. It is the same for P_2 .

Linearizing the subsonic feed flow rate curve with a secant passing through the points $P_1 = P_s$, $G_1 = 0$ and $P_1 = b_1^* P_s$, $G_1 = G_{1 \text{sonic}}$ of angular coefficient K_{L1} , we get

$$G_1 = K_{L1}(P_s - P_1) \quad (20.69)$$

where

$$K_{L1} = \frac{G_{1 \text{sonic}}}{P_s - b_1^* P_s} = \frac{\rho_n C_1 P_s}{P_s(1 - b_1^*)} = \frac{\rho_n C_1}{1 - b_1^*} \quad (20.70)$$

or

$$G_1 = \frac{\rho_n(P_s - P_1)}{(1 - b_1^*)} C_1 \quad (20.71)$$

In the neighborhood $P_1 = P_{1r}$ and $C_1 = C_{1r} = 0$ (the subscript r indicates *of reference*), we get

$$G_1 = \frac{\rho_n(P_s - P_{1r})}{(1 - b_1^*)} C_1 = K_{11} C_1 \quad (20.72)$$

Equation (20.72) is valid for $V_{\text{ref1}} > 0$, to which $C_1 > 0$ corresponds analytically. The flow rate discharge is expressed by

$$G_1 = \rho_n C_1 P_1 \quad (20.73)$$

which in the neighborhood $P_1 = P_{1r}$ becomes

$$G_1 = \rho_n P_{1r} C_1 = K_{12} C_1 \quad (20.74)$$

Equation (20.74) is valid for $V_{\text{ref1}} < 0$, to which $C_1 < 0$ corresponds analytically. Calculating a mean of slopes K_{11} and K_{12} we get a mean slope K_{mean} given by

$$K_{\text{mean}} = \frac{K_{11} + K_{12}}{2} = \frac{\rho_n(P_s - b_1^* P_{1r})}{2(1 - b_1^*)} \quad (20.75)$$

The linearized flow rate as a function of C_1 therefore becomes

$$G_1 = \frac{\rho_n(P_s - b_1^* P_{1r})}{2(1 - b_1^*)} C_1 = K_1 C_1 \quad (20.76)$$

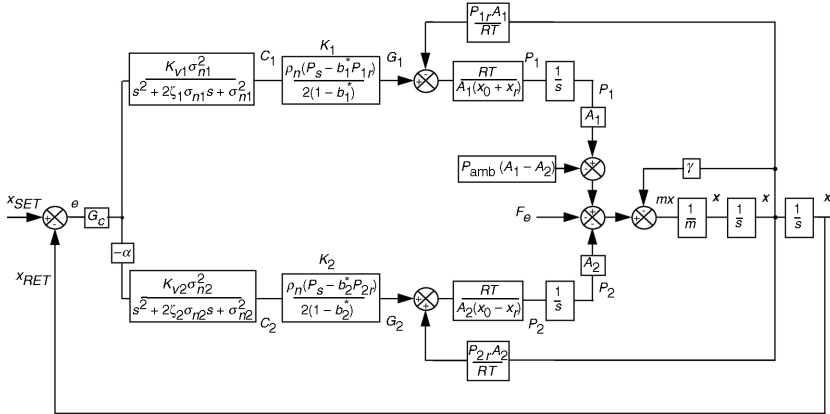

FIGURE 20.124 Block diagram of the linearized model of a pneumatic servosystem with position control.

In the same way for the valve V_2 we get

$$G_2 = \frac{\rho_n(P_s - b_2^* P_{2r})}{2(1 - b_2^*)} C_2 = K_2 C_2 \quad (20.77)$$

The continuity equations of the mass in the piston chambers e) and f), linearized in the reference neighborhood defined by

$$\begin{aligned} x &= x_r, & P_1 &= P_{1r}, & P_2 &= P_{2r}, \\ \dot{P}_1 &= \dot{P}_{1r} = 0, & \dot{P}_2 &= \dot{P}_{2r} = 0, & \dot{x} &= \dot{x}_r = 0 \\ x_{m1} &= x_{m2} = 0, & n &= 1 \end{aligned}$$

become

$$G_1 = \frac{P_{1r} A_1}{RT} \dot{x} + A_1 \frac{x_0 + x_r}{RT} \dot{P}_1 \quad (20.78)$$

$$G_2 = -\frac{P_{2r} A_2}{RT} \dot{x} + A_2 \frac{x_0 - x_r}{RT} \dot{P}_2 \quad (20.79)$$

The block diagram of the linearized model is shown in Fig. 20.124.

By applying the Laplace transforms of the system of linearized equations, assuming identical valves, we get:

$$\bar{\ddot{x}} = \frac{\sigma_n^2}{(s^2 + 2\zeta\sigma_n s + \sigma_n^2)} \frac{\sigma_A^2}{(s^2 + 2\zeta_A\sigma_A s + \sigma_A^2)} G_c K_{OLV} \bar{e} - \frac{\sigma_A^2}{(s^2 + 2\zeta_A\sigma_A s + \sigma_A^2)} K_{OLF} s \bar{F}_e + \text{C.I.} \quad (20.80)$$

where C.I. indicates the initial conditions, K_{OLV} is the static gain in speed, K_{OLF} is the gain of the force disturbance, σ_A and ζ_A are, respectively, the actuator's natural frequency and the damping factor, and G_c is the compensator law.

This result is shown in the block diagram in Fig. 20.125. Figure 20.126, on the other hand, shows the closed loop block diagram with position feedback. Obvious similarities can be seen when this plan is

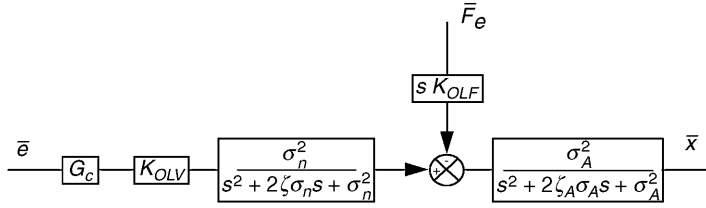

FIGURE 20.125 Block diagram of the open loop model.

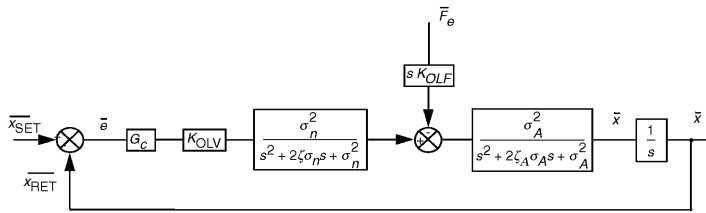

FIGURE 20.126 Block diagram of the closed loop model.

compared with that for a hydraulic servosystem.

In particular, hypothesizing that:

- $P_{1r} = P_{2r} = \delta P_s$ with $\delta \in 0.6 - 0.9$
- $A_1 = A_2 = A$ double ended actuator
- $n = 1$ isothermal transformation

we can express the significant parameters of the pneumatic servosystem:

$$K_{OLV} = \frac{RT\rho_n K_V}{2} \frac{1}{(1-b^*)} \frac{1}{A} \frac{(1/\delta - b^*)}{(1-b^*)} \quad (20.81)$$

$$K_{OLF} = \frac{x_0 [1 - (x_r/x_0)^2]}{2\delta P_s A} \quad (20.82)$$

$$\sigma_A = \sqrt{\frac{2\delta P_s A}{x_0 m [1 - (x_r/x_0)^2]}} \quad (20.83)$$

$$\zeta_A = \gamma \sqrt{\frac{x_0 [1 - (x_r/x_0)^2]}{8\delta P_s A m}} \quad (20.84)$$

On the basis of the design specifications, it is possible to choose the size and characteristics of the servosystem components, operating first on the linearized model, and then checking the complete effectiveness of the choice made with a complete nonlinear system model.

References

- Andersen, B. W., *The analysis and design of pneumatic systems*, Wiley, New York, 1967.
- Bouteille, D., Belforte, G., *Automazione flessibile, elettropneumatica e pneumatica*, Tecniche Nuove, Milano, 1987.

- Belforte, G., D'Alfio, N., *Applicazioni e prove dell'automazione a fluido*, Levrotto & Bella, Torino, 1997.
- Belforte, G., Manuello Bertetto, A., Mazza, L., *Pneumatica: corso completo*, Tecniche Nuove, Milano, 1998.
- Blackburn, J. F., Reethof, G., Shearer, J. L., *Fluid power control*, MIT Press, Cambridge, 1960.
- Dransfield, P., *Hydraulic control systems—design and analysis of their dynamics*, Springer, Berlin, 1981.
- Esposito, A., *Fluid power with applications*, 5th ed., Prentice-Hall, Upper Saddle River, NJ, 2000.
- Gotz, W., *Hydraulics. Theory and applications*, Robert Bosch Automation Technology Division Training, Ditzingen, 1998.
- Hehn, A. H., *Fluid power troubleshooting*, 2nd ed., Dekker, New York, 1995.
- Introduction to hydraulic circuits and components*, The University of Bath, Bath, 2000.
- Introduction to control for electrohydraulic systems*, The University of Bath, Bath, 1999.
- Jacazio, G., Piombo, B., *Meccanica applicata alle macchine 3: Regolazione e servomeccanismi*, Levrotto & Bella, Torino, 1994.
- Johnson, J. E., *Electrohydraulic servo systems*, 2nd ed., Penton IPC, Cleveland, 1977.
- Johnson, J. L., *Design of electrohydraulic systems for industrial motion control*, Penton IPC, Cleveland, 1991.
- Johnson, J. L., *Basic electronics for hydraulic motion control*, Penton IPC, Cleveland, 1992.
- Lewis, E. E., Stern, H., *Design of hydraulic control systems*, McGraw-Hill, New York, 1962.
- Mang, T., Dresel, W., *Lubricants and lubrications*, Wiley-VCH, Weinheim, 2001.
- McCloy, D., Martin, H. R., *The control of fluid power*, Longman, London, 1973.
- Merritt, H. E., *Hydraulic control systems*, Wiley, New York, 1967.
- Moog, *Technical Bulletins*, 101–152, Moog, New York.
- Muller, R., *Pneumatics. Theory and applications*, Robert Bosch Automation Technology Division Training, Ditzingen, 1998.
- Nervegna, N., *Oleodinamica e Pneumatica*, Politeko, Torino, 1999.
- Parr, A., *Hydraulics and pneumatics: a technician's and engineer's guide*, 2nd ed., Butterworth Heinemann, Oxford, 1998.
- Shetty, D., Kolk, R. A., *Mechatronics system design*, PWS publishing company, Boston, 1997.
- Tonyan, M. J., *Electronically controlled proportional valves: selection and application*, Dekker, New York, 1985.
- Viersma, T. J., *Analysis, synthesis and design of hydraulic servosystems and pipelines*, Elsevier, Amsterdam, 1980.
- Yeaple, F., *Fluid power design handbook*, 3rd ed., Dekker, New York, 1996.

20.5 MEMS: Microtransducers Analysis, Design, and Fabrication*

Sergey Edward Lyshevski

Introduction

In many applications (from medicine and biotechnology to aerospace and security), the use of nano- and microscale structures, devices, and systems is very important [1–4]. This chapter discusses the analysis, modeling, design, and fabrication of electromagnetic-based microscale structures and devices (microtransducers controlled by ICs). It is obvious that to attain our objectives and goals, the synergy of multidisciplinary engineering, science, and technology must be utilized. In particular, electromagnetic

* This section is a part of the book: S. E. Lyshevski, *MEMS and NEMS: Systems, Devices, and Structures*, CRC Press, Boca Raton, FL, 2001.

theory and mechanics comprise the fundamentals for analysis, modeling, simulation, design, and optimization, while fabrication is based on the micromachining and high-aspect-ratio techniques and processes, which are the extension of the CMOS technologies developed to fabricate ICs. For many years, the developments in microelectromechanical systems (MEMS) have been concentrated on the fabrication of microstructures adopting, modifying, and redesigning silicon-based processes and technologies commonly used in integrated microelectronics. The reason for refining of conventional processes and technologies as well as application of new materials is simple: in general, microstructures are three-dimensional with high aspect ratios and large structural heights in contrast to two-dimensional planar microelectronic devices. Silicon structures can be formed from bulk silicon micromachining using wet or dry processes, or through surface micromachining. Metallic micromolding techniques, based upon photolithographic processes, are also widely used to fabricate microstructures. Molds are created in polymer films (usually photoresist) on planar surfaces, and then filled by electrodepositing metal (electrodeposition plays a key role in the fabrication of the microstructures and microdevices, which are the components of MEMS). High-aspect ratio technologies use optical, e-beam, and x-ray lithography to create trenches up to 1 mm deep in polymethylmethacrylate resist on the electroplating base (called seed layer). Electrodeposition of magnetic materials and conductors, electroplating, electroetching, and lift-off are extremely important processes to fabricate microscale structures and devices. Though it is recognized that the ability to use and refine existing microelectronics fabrication technologies and materials is very important, and the development of novel processes to fabricate MEMS is a key factor in the rapid growth of affordable MEMS, other emerging areas arise. In particular, devising, design, modeling, analysis, and optimization of novel MEMS are extremely important. Therefore, recently, the MEMS theory and microengineering fundamentals have been expanded to thoroughly study other critical problems such as the system-level synthesis and integration, synergetic classification and analysis, modeling and design, as well as optimization. This chapter studies the fabrication, analysis, and design problems for electromagnetic microstructures and microdevices (microtransducers with ICs). The descriptions of the fabrication processes are given, modeling and analysis issues are emphasized, and the design is performed.

Design and Fabrication

In MEMS, the fabrication of thin film magnetic components and microstructures requires deposition of conductors, insulators, and magnetic materials. Some available bulk material constants (conductivity σ , resistivity ρ at 20°C, relative permeability μ_r , thermal expansion t_e , and dielectric constant—relative permittivity ϵ_r) in SI units are given in [Table 20.12](#).

TABLE 20.12 Material Constants

| Material | σ | ρ | μ_r | $t_e \times 10^{-6}$ | ϵ_r |
|--------------------------------|--------------------|------------------------|----------------|----------------------|--------------|
| Silver | 6.17×10^7 | 0.162×10^{-7} | 0.9999998 | NA | |
| Copper | 5.8×10^7 | 0.172×10^{-7} | 0.999999 | 16.7 | |
| Gold | 4.1×10^7 | 0.244×10^{-7} | 0.999999 | 14 | |
| Aluminum | 3.82×10^7 | 0.26×10^{-7} | 1.00000065 | 25 | |
| Tungsten | 1.82×10^7 | 0.55×10^{-7} | NA | NA | |
| Zinc | 1.67×10^7 | 0.6×10^{-7} | NA | NA | |
| Cobalt | NA | NA | 250 | NA | |
| Nickel | 1.45×10^7 | 0.69×10^{-7} | 600 nonlinear | NA | |
| Iron | 1.03×10^7 | 1×10^{-7} | 4000 nonlinear | NA | |
| Si | | | | 2.65 | 11.8 |
| SiO ₂ | | | | 0.51 | 3.8 |
| Si ₃ N ₄ | | | | 2.7 | 7.6 |
| SiC | | | | 3.0 | 6.5 |
| GaAs | | | | 6.9 | 13 |
| Ge | | | | 2.2 | 16.1 |

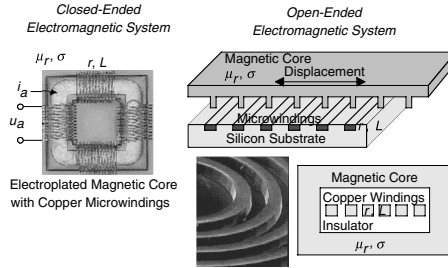

FIGURE 20.127 Closed-ended and open-ended electromagnetic systems in microtransducers (toroidal microstructures with the insulated copper circular conductors wound around the magnetic material and linear micromotor) with magnetic cores (stator and rotor electroplated thin films).

Although MEMS topologies and configurations vary (see the MEMS classification concept [2]), in general, electromagnetic microtransducers have been designed as the closed-ended, open-ended, and integrated electromagnetic systems. As an example, Fig. 20.127 illustrates the microtoroid and the linear micromotor with the closed-ended and open-ended electromagnetic systems, respectively. The copper windings and magnetic core (microstructures) can be made through electroplating, and Fig. 20.129 depicts the electroplated circular copper conductors which form the windings (10 μm wide and thick with 10 μm spacing) deposited on the insulated layer of the magnetic core.

The comprehensive electromagnetic analysis must be performed for microscale structures and devices. For example, the torque (force) developed and the voltage induced by microtransducers depend upon the inductance, and the microdevice's efficiency is a function of the winding resistance, resistivity of the coils deposited, eddy currents, hysteresis, etc. Studying the microtoroid, consider a circular path of radius R in a plane normal to the axis. The magnetic flux intensity is calculated using the following formula:

$$\oint_s \mathbf{H} \cdot d\mathbf{s} = 2\pi R H = Ni$$

where N is the number of turns. Thus, one has

$$H = \frac{Ni}{2\pi R}$$

The value of H is a function of R , and therefore, the field is not uniform.

Microwindings must guarantee the adequate inductance in the limited footprint area with the minimal resistance. For example, in the microtransducers and low power converters, 0.5 μH (or higher) inductance is required at high frequency (1–10 MHz). Compared with the conventional minidevices, the thin film electromagnetic microtransducers have lower efficiency due to higher resistivity of thin films, eddy currents, hysteresis, fringing effect, and other undesirable phenomena, which usually have the secondary (negligible) effect in the miniscale and conventional electromechanical devices. The inductance can be increased by ensuring a large number of turns, using core magnetic materials with high relative permeability, increasing the cross-sectional core area, and decreasing the path length. In fact, at low frequency, the formula for inductance is

$$L = \frac{\mu_0 \mu_r N^2 A}{l}$$

where μ_r is the relative permeability of the core material, A is the cross-sectional area of the magnetic core, and l is the magnetic path length.

Using the reluctance $\mathfrak{R} = l/(\mu_0\mu_r A)$, one has $L = N^2/\mathfrak{R}$. For the electromagnetic microtransducers, the flux is a very important variable, and using the *net* current, one has $\Phi = Ni/\mathfrak{R}$.

It is important to recall that the inductance is related to the energy stored in the magnetic field, and

$$L = \frac{2W_m}{i^2} = \frac{1}{i^2} \int_v \mathbf{B} \cdot \mathbf{H} \, dv.$$

Thus, one has

$$L = \frac{1}{i^2} \int_v \mathbf{B} \cdot \mathbf{H} \, dv = \frac{1}{i^2} \int_v \mathbf{H} \cdot (\nabla \times \mathbf{A}) \, dv = \frac{1}{i^2} \int_v \mathbf{A} \cdot \mathbf{J} \, dv = \frac{1}{i} \oint_l \mathbf{A} \cdot d\mathbf{l} = \frac{1}{i} \oint_s \mathbf{B} \cdot d\mathbf{s} = \frac{\Phi}{i}$$

or

$$L = \frac{N\Phi}{i}$$

We found that the inductance is the function of the number of turns, flux, and current.

Making use of the equation

$$L = \frac{\mu_0\mu_r N^2 A}{l}$$

one concludes that the inductance increases as a function of the squared number of turns. However, a large number of turns requires the high turn density (small track width and spacing so that many turns can be fitted in a given footprint area). However, reducing the track width leads to an increase in the conductor resistance, decreasing the efficiency. Therefore, the design trade-off between inductance and winding resistance must be studied. To achieve low resistance, one must deposit thick conductors with the thickness in the order of tens of micrometers. In fact, the dc resistance is found as $R = \rho_c l_c/A_c$, where ρ_c is the conductor resistivity, l_c is the conductor length, A_c is the conductor cross-sectional area. Therefore, the most feasible process for deposition of conductors is electroplating. High-aspect-ratio processes ensure thick conductors and small track widths and spaces (high-aspect-ratio conductors have a high thickness to width ratio). However, the footprint area is limited not allowing to achieve a large conductor cross-sectional area. High inductance value can also be achieved by increasing the magnetic core cross-sectional area using thick magnetic cores with large A . However, most thin film magnetic materials are thin film metal alloys, which generally have characteristics not as good as the bulk ferromagnetic materials. This results in the eddy current and undesirable hysteresis effects, which increase the core losses and decrease the inductance. It should be emphasized that eddy currents must be minimized.

As illustrated, magnetic cores and microwindings are key components of microstructures, and different magnetic and conductor materials and processes to fabricate microtransducers are employed. Commonly, the *permalloy* (nickel_{80%}-iron_{20%} alloy) thin films are used. It should be emphasized that *permalloy* as well as other materials (e.g., amorphous cobalt-phosphorous) are soft magnetic materials that can be made through electrodeposition. In general, the deposits have nonuniform thickness and composition due to the electric current nonuniformity over the electrodeposition area. Furthermore, hydrodynamic effects in the electrolyte also usually increase nonuniformity (these nonuniformities are reduced by choosing a particular electrochemicals). The inductance and losses remain constant up to a certain frequency (which is a function of the layer thickness, materials used, fabrication processes, etc.), and in the high frequency operating regimes, the inductance rapidly decreases and the losses increase due to the eddy current and hysteresis effects. For example, for the *permalloy* (Ni_{80%}Fe_{20%}) thin film magnetic core and copper winding,

the inductance decreases rapidly above 1, 3, and 6 MHz for the 10, 8, and 5 μm thick layers, respectively. It should be emphasized that the skin depth of the magnetic core thin film as a function of the magnetic properties and the frequency f is found as $\delta = \sqrt{1/(\pi f \mu \sigma)}$, where μ and σ are the permeability and conductivity of the magnetic core material, respectively. The total power losses are found using the Pointing vector $\Xi = \mathbf{E} \times \mathbf{H}$, and the total power loss can be approximately derived using the expression for the power crossing the conductor surface within the area, e.g.,

$$P_{\text{average}} = \int_s \Xi_{\text{average}} ds = \frac{1}{4} \int_s \sigma \delta E_0^2 e^{-2/\delta \sqrt{\pi f \mu \sigma}} ds$$

It is important to emphasize that the skin depth (depth of penetration) is available, and for the bulk copper $\delta_{\text{cu}} = 0.066/\sqrt{f}$.

In general, the inductance begins to decrease when the ratio of the lamination thickness to skin depth is greater than one. Thus, the lamination thickness must be less than skin depth at the operating frequency f to attain the high inductance value. In order to illustrate the need to comprehensively study microinductors, we analyze the toroidal microinductor (1 mm by 1 mm, 3 μm core thickness, 2000 permeability). The inductance and winding resistances are analyzed as the functions of the operating frequency. Modeling results indicate that the inductance remains constant up to 100 kHz and decreases for the higher frequency. The resistance increases significantly at frequencies higher than 150 kHz (the copper microconductor thickness is 2 μm , and the dc winding resistance is 10 Ω). The decreased inductance and increased resistance at high frequency are due to hysteresis and eddy current effects.

The skin depth in the magnetic core material depends on the permeability and the conductivity. The $\text{Ni}_{x\%}\text{Fe}_{100-x\%}$ thin films have a relative permeability in the range from 600 to 2000, and the resistivity is in the order of 20 $\mu\Omega\text{ cm}$. It should be emphasized that the materials with high resistivity have low eddy current losses and allow one to deposit thicker layers as the skin depth is high. Therefore, high resistivity magnetic materials are under consideration, and the electroplated FeCo thin films have 100–130 $\mu\Omega\text{ cm}$ resistivity. Other high resistivity materials, which can be deposited by sputtering, are FeZrO and CoHfTaPd (sputtering has advantages for the deposition of laminated layers of magnetic and insulating materials because magnetic and insulating materials can be deposited in the same process step). Electroplating, as a technique for deposition of laminated multilayer structures, in general, requires different processes to deposit magnetic and insulating materials (layers).

The major processes involved in the electromagnetic microtransducer fabrication are etching and electroplating magnetic vias and through-holes, and then fabricating the inductor-type microstructures on top of the through-hole wafer using multilayer thick photoresist processes [5–7]. For example, let us use the silicon substrate (100-oriented n -type double-sided polished silicon wafers) with a thin layer of thermally grown silicon dioxide (SiO_2). Through-holes are patterned on the topside of the Si– SiO_2 wafer (photolithography process) and then etched in the KOH system (different etch rate can be attained based upon the concentration and temperature). Then, the wafer is removed from the KOH solution with 20–30 μm of silicon remaining to be etched. A seed layer of Ti–Cu or Cr–Cu (20–40 nm and 400–500 nm thickness, respectively) are deposited on the backside of the wafer using electron beam evaporation. The copper acts as the electroplating seed layer, while a titanium (or chromium) layer is used to increase adhesion of the copper layer to the silicon wafer. On the copper seed layer, a protective NiFe thin film layer is electroplated directly above the through-holes to attain protection and stability. The through-holes are fully etched again (in the KOH system), and then the remaining SiO_2 is stripped (using the BHF solution) to reveal the backside metal layers. Then, the titanium adhesion layer is etched in the HF solution (chromium, if the Cr–Cu seed layer is used, can be removed using the $\text{K}_3\text{Fe}(\text{CN})_6$ –NaOH solution). This allows the electroplating of through-holes from the exposed copper seed layer. The empty through-holes are electroplated with NiFe thin film. This forms the magnetic vias. Because the KOH-based etching process is crystallographically dependent, the sidewalls of the electroplating mold are the 111-oriented crystal planes (54.7° angular orientation to the surface). As a result of these 54.7°-angularly

oriented sidewalls, the electroplating can be nonuniform. To overcome this problem, the through-holes can be over-plated and polished to the surface level [5–7]. After the through-hole plating and polishing, the seed layer is removed, and 10–20 μm coat (e.g., polyimide PI2611) is spun on the backside and cured at 300°C to cover the protective NiFe layer. Now, the microinductor can be fabricated on the topside of the wafer. In particular, the microcoils are fabricated on top of the through-hole wafer with the specified magnetic core geometry (e.g., plate- or horseshoe-shaped) parallel to the surface of the wafer. The microcoils must be wound around the magnetic core to form the electromagnetic system. Therefore, the additional structural layers are needed (for example, the first level is the conductors that are the bottom segments of each microcoil turn, the second level includes the magnetic core and vertical conductors which connect the top and bottom of each microcoil turn segment, and the third level consists of the top conductors that are connected to the electrical vias, and thus form microcoil turns wound around the magnetic core). It is obvious that the insulation (dielectric) layers are required to insulate the magnetic core and microcoils. The fabrication can be performed through the electron beam evaporation of the Ti-Cu seed layer, and then, 25–35 μm electroplating molds are formed (AZ-4000 photoresist can be used). The copper microcoils are electroplated on the top of the mold through electroplating. After electroplating is completed, the photoresist is removed with acetone. Then, the seed layer is removed (copper is etched in the H_2SO_4 solution, while the titanium adhesion layer is etched by the HF solution). A new layer of the AZ-4000 photoresist is spun on the wafer to insulate the bottom conductors from the magnetic core. The vias' openings are patterned at the ends of the conductors, and the photoresist is cured forming the insulation layer. In addition to insulation, the hard curing leads to reflow of the photoresist serving the planarization purpose needed to pattern additional layers. Another seed layer is deposited from which electrical vias and magnetic core are patterned and electroplated. This leads to two lithography sequential steps, and the electrical vias (electroplated Cu) and magnetic core (NiFe thin film) are electroplated using the same seed layer. After the vias and magnetic core are completed, the photoresist and seed layers are removed. Then, the hard curing is performed. The top microconductors are patterned and deposited from another seed layer using the same process as explained above for the bottom microconductors. The detailed description of the processes described and the fabricated microtransducers are available in [5–7]. We have outlined the fabrication of microinductors because these techniques can be adopted and used to fabricate microtransducers. It also must be emphasized that the analysis and design can be performed using the equations given.

Analysis of Translational Microtransducers

Figure 20.128 illustrates a microelectromechanical device (translational microtransducer) with a stationary member (magnetic core with windings) and movable member (microplunger), which can be fabricated using the micromachining technology. Our goal is to perform the analysis and modeling of the microtransducer developing the lumped-parameter mathematical model. That is, the goal is to derive the differential equations which model the microtransducer steady-state and dynamic behavior.

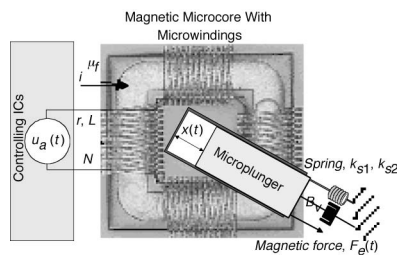

FIGURE 20.128 Schematic of the translational microtransducer with controlling ICs.

Applying Newton's second law for translational motion, we have

$$F(t) = m \frac{d^2 x}{dt^2} + B_v \frac{dx}{dt} + (k_{s1}x + k_{s2}x^2) + F_e(t)$$

where x denotes the microplunger displacement, m is the mass of a movable member (microplunger), B_v is the viscous friction coefficient, k_{s1} and k_{s2} are the spring constants, and $F_e(t)$ is the magnetic force

$$F_e(i, x) = \frac{\partial W_c(i, x)}{\partial x}$$

It should be emphasized that the restoring/stretching force exerted by the spring is given by $(k_{s1}x + k_{s2}x^2)$.

Assuming that the magnetic system is linear, the coenergy is found to be $W_c(i, x) = \frac{1}{2}L(x)i^2$ and the electromagnetic force developed is given by

$$F_e(i, x) = \frac{1}{2}i^2 \frac{dL(x)}{dx}$$

In this formula, the analytic expression for the term $dL(x)/dx$ must be found. The inductance is

$$L(x) = \frac{N^2}{\mathfrak{R}_f + \mathfrak{R}_g} = \frac{N^2 \mu_f \mu_0 A_f A_g}{A_g l_f + 2A_f \mu_f (x + 2d)}$$

where \mathfrak{R}_f and \mathfrak{R}_g are the reluctances of the magnetic material and air gap; A_f and A_g are the cross-sectional areas; l_f and $(x + 2d)$ are the lengths of the magnetic material and the air gap.

Thus

$$\frac{dL}{dx} = -\frac{2N^2 \mu_f^2 \mu_0 A_f^2 A_g}{[A_g l_f + 2A_f \mu_f (x + 2d)]^2}$$

Using Kirchhoff's law, the voltage equation for the electric circuit is

$$u_a = ri + \frac{d\psi}{dt}$$

where the flux linkage ψ is $\psi = L(x)i$.

Thus, one obtains

$$u_a = ri + L(x) \frac{di}{dt} + i \frac{dL(x)}{dx} \frac{dx}{dt}$$

Therefore, the following nonlinear differential equation results:

$$\frac{di}{dt} = -\frac{r}{L(x)}i + \frac{2N^2 \mu_f^2 \mu_0 A_f^2 A_g}{L(x)[A_g l_f + 2A_f \mu_f (x + 2d)]^2}iv + \frac{1}{L(x)}\mu_a$$

Augmenting this equation with the differential equation and the *torsional-mechanical* dynamics

$$F(t) = m \frac{d^2 x}{dt^2} + B_v \frac{dx}{dt} + (k_{s1} x + k_{s2} x^2) + F_e(t)$$

three nonlinear differential equations for the considered translational microtransducer are found to be

$$\begin{aligned} \frac{di}{dt} &= -\frac{r[A_g l_f + 2A_f \mu_f(x + 2d)]}{N^2 \mu_f \mu_0 A_f A_g} i + \frac{2\mu_f A_f}{A_g l_f + 2A_f \mu_f(x + 2d)} i v + \frac{A_g l_f + 2A_f \mu_f(x + 2d)}{N^2 \mu_f \mu_0 A_f A_g} u_a \\ \frac{dv}{dt} &= \frac{N^2 \mu_f^2 \mu_0 A_f^2 A_g}{m[A_g l_f + 2A_f \mu_f(x + 2d)]^2} i^2 - \frac{1}{m}(k_{s1} x + k_{s2} x^2) - \frac{B_v}{m} v \\ \frac{dx}{dt} &= v \end{aligned}$$

The derived differential equations represent the lumped-parameter mathematical model of the microtransducer. Although, in general, the high-fidelity modeling must be performed integrating nonlinearities (for example, nonlinear magnetic characteristics and hysteresis) and secondary effects, the lumped-parameter mathematical models as given in the form of nonlinear differential equations have been validated for microtransducers. It is found that the major phenomena and effects are modeled for the current, velocity, and displacement (secondary effects such as Coulomb friction, hysteresis and eddy currents, fringing effect and other phenomena have not been modeled and analyzed). However, the lumped-parameter modeling provides one with the capabilities to attain reliable preliminary steady-state and dynamic analysis using primary circuitry and mechanical variables. It is also important to emphasize that the voltage, applied to the microwinding, is regulated by ICs. The majority of ICs to control microtransducers are designed using the pulse-width-modulation topologies. The switching frequency of ICs is usually 1 MHz or higher. Therefore, as was shown, it is very important to study the microtransducer performance at the high operating frequency. This can be performed using Maxwell's equations, which will lead to the high-fidelity mathematical models [2].

Single-Phase Reluctance Micromotors: Microfabrication, Modeling, and Analysis

Consider the single-phase reluctance micromachined motors as illustrated in Fig. 20.129.

The emphases are concentrated on the analysis, modeling, and control of reluctance micromotors in the rotational microtransducer applications. Therefore, mathematical models must be found. The lumped-parameter modeling paradigm is based upon the use of the circuitry (voltage and current) and mechanical (velocity and displacement) variables to derive the differential equations using Newton's and Kirchhoff's laws. In these differential equations, the micromotor parameters are used. In particular, for the studied micromotor, the parameters are the stator resistance r_s , the magnetizing inductances in the *quadrature* and *direct* axes L_{mq} and L_{md} , the average magnetizing inductance \bar{L}_m , the leakage inductance L_l , the moment of inertia J , and the viscous friction coefficient B_m .

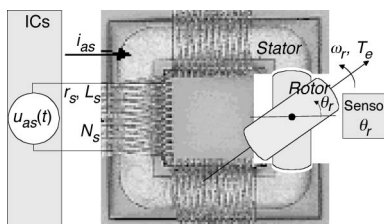

FIGURE 20.129 Single-phase reluctance micromotor with ICs and rotor displacement (position) sensor.

The expression for the electromagnetic torque was derived in [8]. In particular,

$$T_e = L_{\Delta m} i_{as}^2 \sin 2\theta_r$$

where $L_{\Delta m}$ is the half-magnitude of the sinusoidal magnetizing inductance L_m variations,

$$L_m(\theta_r) = \bar{L}_m - L_{\Delta m} \cos 2\theta_r$$

Thus, to develop the electromagnetic torque, the current i_{as} must be fed as a function of the rotor angular displacement θ_r . For example, if $i_{as} = i_M \text{Re}(\sqrt{\sin 2\theta_r})$, then

$$T_{\text{average}} = \frac{1}{\pi} \int_0^\pi L_{\Delta m} i_{as}^2 \sin 2\theta_r d\theta_r = \frac{1}{4} L_{\Delta m} i_M^2$$

The micromotor under our consideration is the synchronous micromachine, and the obtained expression for the phase current is very important to control the microtransducer. In particular, the Hall-effect position sensor should be used to measure the rotor displacement, and the ICs must feed the phase current as a nonlinear function of θ_r . Furthermore, the electromagnetic torque is controlled by changing the current magnitude i_M .

The mathematical model of the single-phase reluctance micromotor is found using Kirchhoff's and Newton's second laws. In particular, we have

$$u_{as} = r_s i_{as} + \frac{d\psi_{as}}{dt} \quad (\text{circuitry equation—Kirchhoff's law})$$

$$T_e - B_m \omega_r - T_L = J \frac{d^2 \theta_r}{dt^2} \quad (\text{torsional-mechanical equation—Newton's law})$$

Here, the electrical angular velocity ω_r and displacement θ_r are used as the mechanical system variables. From $u_{as} = r_s i_{as} + \frac{d\psi_{as}}{dt}$ and the flux linkage equation $\psi_{as} = (L_{ls} + \bar{L}_m - L_{\Delta m} \cos 2\theta_r) i_{as}$, using the *torsional-mechanical* dynamics, one obtains a set of three first-order nonlinear differential equations which models single-phase reluctance micromotors. In particular, we have

$$\frac{di_{as}}{dt} = -\frac{r_s}{L_{ls} + \bar{L}_m - L_{\Delta m} \cos 2\theta_r} i_{as} - \frac{2L_{\Delta m}}{L_{ls} + \bar{L}_m - L_{\Delta m} \cos 2\theta_r} i_{as} \omega_r \sin 2\theta_r + \frac{1}{L_{ls} + \bar{L}_m - L_{\Delta m} \cos 2\theta_r} u_{as}$$

$$\frac{d\omega_r}{dt} = \frac{1}{J} (L_{\Delta m} i_{as}^2 \sin 2\theta_r - B_m \omega_r - T_L)$$

$$\frac{d\theta_r}{dt} = \omega_r$$

As the mathematical model is found and the micromotor parameters are measured, nonlinear simulation and analysis can be straightforwardly performed to study the dynamic responses and analyze the micromotor efficiency. In particular, the resistance, inductances, moment of inertia, viscous friction coefficient, and other parameters can be directly measured or identified based upon micromotor testing. The steady-state and dynamic analysis based upon the lumped-parameter mathematical model is straightforward. However, the lumped-parameter mathematical models simplify the analysis, and thus, these models must be compared with the experimental data to validate the results.

The disadvantage of single-phase reluctance micromotors are high torque ripple, vibration, noise, low reliability, etc. Therefore, let us study three-phase synchronous reluctance micromotors.

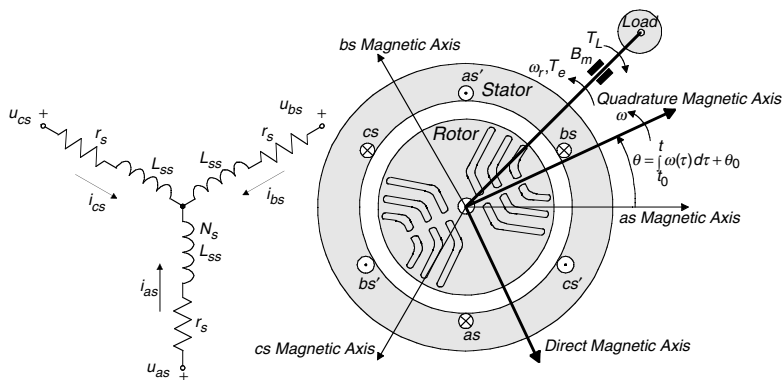

FIGURE 20.130 Three-phase synchronous reluctance micromotor.

Three-Phase Synchronous Reluctance Micromotors: Modeling and Analysis

Our goal is to address and solve a spectrum of problems in analysis, modeling, and control of synchronous reluctance micromachines. The electromagnetic features must be thoroughly analyzed before attempt to control micromotors. In fact, electromagnetic features significantly restrict the control algorithms to be applied. Depending upon the conceptual methods employed to analyze synchronous reluctance micromachines, different control laws can be designed and implemented using ICs. Analysis and control of synchronous reluctance micromotors can be performed using different modeling, analysis, and optimization concepts. Complete lumped-parameter mathematical models of synchronous reluctance micromotors in the *machine* (abc) and in the *quadrature*, *direct*, and *zero* ($qd0$) variables should be developed in the form of nonlinear differential equations. In particular, the circuitry lumped-parameters mathematical model is found using the Kirchhoff's voltage law. We have, see Fig. 20.130,

$$\mathbf{u}_{abc} = \mathbf{r}_s \mathbf{i}_{abc} + \frac{d\boldsymbol{\psi}_{abc}}{dt}$$

where u_{as} , u_{bs} , and u_{cs} are the phase voltages; i_{as} , i_{bs} , and i_{cs} are the phase currents; ψ_{as} , ψ_{bs} , and ψ_{cs} are the flux linkages,

$$\boldsymbol{\psi}_{abc} = \mathbf{L}_s \mathbf{i}_{abc}, \quad \mathbf{r}_s = \begin{bmatrix} r_s & 0 & 0 \\ 0 & r_s & 0 \\ 0 & 0 & r_s \end{bmatrix}$$

$$\mathbf{L}_s = \begin{bmatrix} L_{ls} + \bar{L}_m - L_{\Delta m} \cos(2\theta_r) & -\frac{1}{2}\bar{L}_m - L_{\Delta m} \cos 2\left(\theta_r - \frac{1}{3}\pi\right) & -\frac{1}{2}\bar{L}_m - L_{\Delta m} \cos 2\left(\theta_r + \frac{1}{3}\pi\right) \\ -\frac{1}{2}\bar{L}_m - L_{\Delta m} \cos 2\left(\theta_r - \frac{1}{3}\pi\right) & L_{ls} + \bar{L}_m - L_{\Delta m} \cos 2\left(\theta_r - \frac{2}{3}\pi\right) & -\frac{1}{2}\bar{L}_m - L_{\Delta m} \cos 2(\theta_r + \pi) \\ -\frac{1}{2}\bar{L}_m - L_{\Delta m} \cos 2\left(\theta_r + \frac{1}{3}\pi\right) & -\frac{1}{2}\bar{L}_m - L_{\Delta m} \cos 2(\theta_r + \pi) & L_{ls} + \bar{L}_m - L_{\Delta m} \cos 2\left(\theta_r + \frac{2}{3}\pi\right) \end{bmatrix}$$

$$\bar{L}_m = \frac{1}{3}(L_{mq} + L_{md}) \quad \text{and} \quad L_{\Delta m} = \frac{1}{3}(L_{md} - L_{mq})$$

The micromachine parameters are the stator resistance r_s , the magnetizing inductances in the *quadrature* and *direct* axes L_{mq} and L_{md} , the average magnetizing inductance \bar{L}_m , the leakage inductance L_{ls} , the moment of inertia J , and the viscous friction coefficient B_m .

The expressions for inductances are nonlinear functions of the electrical angular displacement θ_r . Hence, the *torsional-mechanical* dynamics must be used. Taking note of the Newton's second law of rotational motion, and using ω_r and θ_r (electrical angular velocity and displacement) as the state variables (mechanical variables), one obtains

$$T_e - B_m \frac{2}{P} \omega_r - T_L = J \frac{2}{P} \frac{d\omega_r}{dt}, \quad \frac{d\theta_r}{dt} = \omega_r$$

where T_e and T_L are the electromagnetic and load torques.

Torque Production Analysis—Using the coenergy, the electromagnetic torque, which is a nonlinear function of the micromotor variables (phase currents and electrical angular position) and micromotor parameters (number of poles P and inductance $L_{\Delta m}$), is found to be [8],

$$T_e = \frac{P}{2} L_{\Delta m} \left[i_{as}^2 \sin 2\theta_r + 2i_{as}i_{bs} \sin 2\left(\theta_r - \frac{1}{3}\pi\right) + 2i_{as}i_{cs} \sin 2\left(\theta_r + \frac{1}{3}\pi\right) \right. \\ \left. + i_{bs}^2 \sin 2\left(\theta_r - \frac{2}{3}\pi\right) + 2i_{bs}i_{cs} \sin 2\theta_r + i_{cs}^2 \sin 2\left(\theta_r + \frac{2}{3}\pi\right) \right]$$

To control the angular velocity, the electromagnetic torque must be regulated. To maximize the electromagnetic torque, ICs must feed the following phase currents as functions of the angular displacement measuring or observing (sensorless control) θ_r

$$i_{as} = \sqrt{2}i_M \sin\left[\theta_r + \frac{1}{3}\varphi_i\pi\right] \\ i_{bs} = \sqrt{2}i_M \sin\left[\theta_r - \frac{1}{3}(2 - \varphi_i)\pi\right] \\ i_{cs} = \sqrt{2}i_M \sin\left[\theta_r + \frac{1}{3}(2 + \varphi_i)\pi\right]$$

Thus, for $\varphi_i = 0.3245$, one obtains

$$T_e = \sqrt{2}PL_{\Delta m}i_M^2$$

That is, T_e is maximized and controlled by changing the magnitude of the phase currents i_M . Furthermore, it is no torque ripple (in practice, based upon the experimental results, and performing the high-fidelity modeling integrating nonlinear electromagnetics using Maxwell's equations, one finds that there exists the torque ripple which is due to the cogging torque, eccentricity, bearing, pulse-width-modulation, and other phenomena).

The majority of ICs are designed to control the phase voltages u_{as} , u_{bs} , and u_{cs} . Therefore, the three-phase balance voltage set is important. We have

$$u_{as} = \sqrt{2}u_M \sin\left[\theta_r + \frac{1}{3}\varphi_i\pi\right] \\ u_{bs} = \sqrt{2}u_M \sin\left[\theta_r - \frac{1}{3}(2 - \varphi_i)\pi\right] \\ u_{cs} = \sqrt{2}u_M \sin\left[\theta_r + \frac{1}{3}(2 + \varphi_i)\pi\right]$$

where u_M is the magnitude of the supplied voltages.

The mathematical model of synchronous reluctance micromotors in the abc variables is found to be

$$\begin{aligned} \frac{di_{as}}{dt} = & \frac{1}{L_D} \left\{ (r_s i_{as} - u_{as}) (4L_{ls}^2 + 3\bar{L}_m^2 - 3L_{\Delta m}^2 + 8\bar{L}_m L_{ls} - 4L_{ls} L_{\Delta m} \cos 2\theta_r) \right. \\ & + (r_s i_{bs} - u_{bs}) \left[3\bar{L}_m^2 - 3L_{\Delta m}^2 + 2\bar{L}_m L_{ls} + 4L_{ls} L_{\Delta m} \cos 2\left(\theta_r - \frac{1}{3}\pi\right) \right] \\ & + (r_s i_{cs} - u_{cs}) \left[3\bar{L}_m^2 - 3L_{\Delta m}^2 + 2\bar{L}_m L_{ls} + 4L_{ls} L_{\Delta m} \cos 2\left(\theta_r + \frac{1}{3}\pi\right) \right] \\ & + 6\sqrt{3}L_{\Delta m}^2 L_{ls} \omega_r (i_{cs} - i_{bs}) + (8L_{\Delta m} L_{ls}^2 \omega_r + 12L_{\Delta m} \bar{L}_m L_{ls} \omega_r) \\ & \left. \times \left(\sin 2\theta_r i_{as} + \sin 2\left(\theta_r - \frac{1}{3}\pi\right) i_{bs} + \sin 2\left(\theta_r + \frac{1}{3}\pi\right) i_{cs} \right) \right\} \end{aligned}$$

$$\begin{aligned} \frac{di_{bs}}{dt} = & \frac{1}{L_D} \left\{ (r_s i_{as} - u_{as}) \left[3\bar{L}_m^2 - 3L_{\Delta m}^2 + 2\bar{L}_m L_{ls} + 4L_{ls} L_{\Delta m} \cos 2\left(\theta_r - \frac{1}{3}\pi\right) \right] \right. \\ & + (r_s i_{bs} - u_{bs}) \left[4L_{ls}^2 + 3\bar{L}_m^2 - 3L_{\Delta m}^2 + 8\bar{L}_m L_{ls} - 4L_{ls} L_{\Delta m} \cos 2\left(\theta_r + \frac{1}{3}\pi\right) \right] \\ & + (r_s i_{cs} - u_{cs}) \left[3\bar{L}_m^2 - 3L_{\Delta m}^2 + 2\bar{L}_m L_{ls} + 4L_{ls} L_{\Delta m} \cos 2\theta_r \right] \\ & + 6\sqrt{3}L_{\Delta m}^2 L_{ls} \omega_r (i_{as} - i_{cs}) + (8L_{\Delta m} L_{ls}^2 \omega_r + 12L_{\Delta m} \bar{L}_m L_{ls} \omega_r) \\ & \left. \times \left(\sin 2\left(\theta_r - \frac{1}{3}\pi\right) i_{as} + \sin 2\left(\theta_r + \frac{1}{3}\pi\right) i_{bs} + \sin 2\theta_r i_{cs} \right) \right\} \end{aligned}$$

$$\begin{aligned} \frac{di_{cs}}{dt} = & \frac{1}{L_D} \left\{ (r_s i_{as} - u_{as}) \left[3\bar{L}_m^2 - 3L_{\Delta m}^2 + 2\bar{L}_m L_{ls} + 4L_{ls} L_{\Delta m} \cos 2\left(\theta_r + \frac{1}{3}\pi\right) \right] \right. \\ & + (r_s i_{bs} - u_{bs}) (3\bar{L}_m^2 - 3L_{\Delta m}^2 + 2\bar{L}_m L_{ls} + 4L_{ls} L_{\Delta m} \cos 2\theta_r) \\ & + (r_s i_{cs} - u_{cs}) \left[4L_{ls}^2 + 3\bar{L}_m^2 - 3L_{\Delta m}^2 + 8\bar{L}_m L_{ls} - 4L_{ls} L_{\Delta m} \cos 2\left(\theta_r - \frac{1}{3}\pi\right) \right] \\ & + 6\sqrt{3}L_{\Delta m}^2 L_{ls} \omega_r (i_{bs} - i_{as}) + (8L_{\Delta m} L_{ls}^2 \omega_r + 12L_{\Delta m} \bar{L}_m L_{ls} \omega_r) \\ & \left. \times \left[\sin 2\left(\theta_r + \frac{1}{3}\pi\right) i_{as} + \sin 2\theta_r i_{bs} + \sin 2\left(\theta_r - \frac{1}{3}\pi\right) i_{cs} \right] \right\} \end{aligned}$$

$$\begin{aligned} \frac{d\omega_r}{dt} = & \frac{P^2}{4J} L_{\Delta m} \left[i_{as}^2 \sin 2\theta_r + 2i_{as} i_{bs} \sin 2\left(\theta_r - \frac{1}{3}\pi\right) + 2i_{as} i_{cs} \sin 2\left(\theta_r + \frac{1}{3}\pi\right) \right. \\ & \left. + i_{bs}^2 \sin 2\left(\theta_r - \frac{2}{3}\pi\right) + 2i_{bs} i_{cs} \sin 2\theta_r + i_{cs}^2 \sin 2\left(\theta_r + \frac{2}{3}\pi\right) \right] - \frac{B_m}{J} \omega_r - \frac{P}{2J} T_L \end{aligned}$$

$$\frac{d\theta_r}{dt} = \omega_r$$

Here

$$\bar{L}_m = \frac{1}{3}(L_{mq} + L_{md}), \quad L_{\Delta m} = \frac{1}{3}(L_{md} - L_{mq}) \quad \text{and} \quad L_D = L_{ls}(9L_{\Delta m}^2 - 4L_{ls}^2 - 12\bar{L}_m L_{ls} - 9\bar{L}_m^2)$$

The mathematical model can be simplified. In particular, in the rotor reference frame, we apply the Park transformation [8]

$$\mathbf{u}_{qd0s}^r = \mathbf{K}_s^r \mathbf{u}_{abc}, \quad \mathbf{i}_{qd0s}^r = \mathbf{K}_s^r \mathbf{i}_{abc}, \quad \boldsymbol{\psi}_{qd0s}^r = \mathbf{K}_s^r \boldsymbol{\psi}_{abc}$$

$$\mathbf{K}_s^r = \frac{2}{3} \begin{bmatrix} \cos \theta_r & \cos\left(\theta_r - \frac{2}{3}\pi\right) & \cos\left(\theta_r + \frac{2}{3}\pi\right) \\ \sin \theta_r & \sin\left(\theta_r - \frac{2}{3}\pi\right) & \sin\left(\theta_r + \frac{2}{3}\pi\right) \\ \frac{1}{2} & \frac{1}{2} & \frac{1}{2} \end{bmatrix}$$

where u_{qs} , u_{ds} , u_{0s} , i_{qs} , i_{ds} , i_{0s} , and ψ_{qs} , ψ_{ds} , ψ_{0s} are the $qd0$ voltages, currents, and flux linkages.

Using the circuitry and *torsional-mechanical* dynamics, one finds the following nonlinear differential equations to model synchronous reluctance micromotors in the rotor reference frame:

$$\begin{aligned} \frac{di_{qs}^r}{dt} &= -\frac{r_s}{L_{ls} + L_{mq}} i_{qs}^r - \frac{L_{ls} + L_{md}}{L_{ls} + L_{mq}} i_{ds}^r \omega_r + \frac{1}{L_{ls} + L_{mq}} u_{qs}^r \\ \frac{di_{ds}^r}{dt} &= -\frac{r_s}{L_{ls} + L_{md}} i_{ds}^r + \frac{L_{ls} + L_{mq}}{L_{ls} + L_{md}} i_{qs}^r \omega_r + \frac{1}{L_{ls} + L_{md}} u_{ds}^r \\ \frac{di_{0s}^r}{dt} &= -\frac{r_s}{L_{ls}} i_{0s}^r + \frac{1}{L_{ls}} u_{0s}^r \\ \frac{d\omega_r}{dt} &= \frac{3P^2}{8J} (L_{md} - L_{mq}) i_{qs}^r i_{ds}^r - \frac{B_m}{J} \omega_r - \frac{P}{2J} T_L \\ \frac{d\theta_r}{dt} &= \omega_r \end{aligned}$$

One can easily observe that this model is much simpler compared with the lumped-parameter mathematical model derived using the abc variables.

To attain the balanced operation, the *quadrature* and *direct* currents and voltages must be derived using the *direct* Park transformation $\mathbf{i}_{qd0s}^r = \mathbf{K}_s^r \mathbf{i}_{abc}$, $\mathbf{u}_{qd0s}^r = \mathbf{K}_s^r \mathbf{u}_{abc}$. Hence, the $qd0$ voltages u_{qs}^r , u_{ds}^r , and u_{0s}^r are found using the three-phase balance voltage set. In particular, we have

$$u_{qs}^r = \sqrt{2} u_M, \quad u_{ds}^r = 0, \quad u_{0s}^r = 0$$

We derived the mathematical models of three-phase synchronous reluctance micromotors. Based upon the differential equations obtained, nonlinear analysis can be performed, and the phase currents and voltages needed to guarantee the balance operating conditions can be found. The results reported can be straightforwardly used in nonlinear simulation.

Microfabrication Aspects

The fabrication of electromechanical microstructures and microtransducers can be made through deposition of the conductors (coils and windings), magnetic core, insulating layers, as well as other microstructures (movable and stationary members and their components). The order of the processes,

materials, and sequential steps are different depending on the MEMS which must be devised, designed, analyzed, and optimized first.

Conductor Thin Films Electrodeposition

The conductors (microcoils to make windings) in microstructures and microtransducers can be fabricated by electrodepositing the copper and other low resistivity metals. Electrodeposition of metals is made by immersing a conductive surface in a solution containing ions of the metal to be deposited. The surface is electrically connected to an external power supply, and current is fed through the surface into the solution. In general, the reaction of the metal ions (Metal^{x+}) with x electrons ($x\text{e}^-$) to form metal (Metal) is $\text{Metal}^{x+} + x\text{e}^- = \text{Metal}$.

To electrodeposit copper on the silicon wafer, the wafer is typically coated with a thin conductive layer of copper (seed layer) and immersed in a solution containing cupric ions. Electrical contact is made to the seed layer, and current is flowed (passed) such that the reaction $\text{Cu}^{2+} + 2\text{e}^- \rightarrow \text{Cu}$ occurs at the wafer surface. The wafer, which is electrically interacted such that the metal ions are changed to metal atoms, is the cathode. Another electrically active surface (anode) is the conductive solution to make the electrical path. At the anode, the oxidation reaction occurs that balances the current flow at the cathode, thus maintaining the electric neutrality. In the case of copper electroplating, all cupric ions removed from solution at the wafer cathode are replaced by dissolution from the copper anode. According to the Faraday law of electrolysis, in the absence of secondary reactions, the current delivered to a conductive surface during electroplating is proportional to the quantity of the metal deposited. Thus, the metal deposited can be controlled varying the electroplating current (current density) and the electrodeposition time.

The hydrated Cu ions reaction is

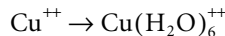

and the cathode reactions are

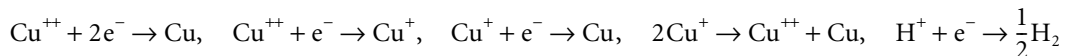

The copper electroplating solution commonly used is $\text{CuSO}_4 \cdot 5\text{H}_2\text{O}$ (250 g/l) and H_2SO_4 (25 ml/l).

The basic processes are shown in Fig. 20.131, and the brief description of the sequential steps and equipment that can be used are given.

It must be emphasized that commonly used magnetic materials and conductors do not adhere well to silicon. Therefore, as was described, the adhesion layers (e.g., titanium Ti or chromium Cr) are deposited on the silicon surface prior to the magnetic material electroplating.

The electrodeposition rate is proportional to the current density and, therefore, the uniform current density at the substrate seed layer is needed to attain the uniform thickness of the electrodeposit. To achieve the selective electrodeposition, portions of the seed layer are covered with the resist (the current density at the mask edges nonuniform degrading electroplating). In addition to the current density, the deposition rate is also a nonlinear function of temperature, solution (chemicals), pH, direct/reverse current or voltage waveforms magnitude, waveform pulses, duty ratio, plating area, etc. In the simplest form, the thickness and electrodeposition time for the specified materials are calculated as

$$\text{Thickness}_{\text{material}} = \frac{\text{Time}_{\text{electroplating}} \times \text{Current}_{\text{density}} \times \text{Weight}_{\text{molecular}}}{\text{Faraday}_{\text{constant}} \times \text{Density}_{\text{material}} \times \text{Electron}_{\text{number}}}$$

$$\text{Time}_{\text{electroplating}} = \frac{\text{Thickness}_{\text{material}} \times \text{Faraday}_{\text{constant}} \times \text{Density}_{\text{material}} \times \text{Electron}_{\text{number}}}{\text{Current}_{\text{density}} \times \text{Weight}_{\text{molecular}}}$$

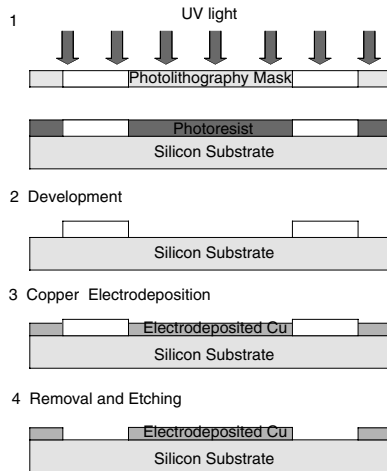

FIGURE 20.131 Electrodeposition of copper and basic processes: silicon, kapton, and other substrates, can be used. After clearing, the silicon substrate is covered with a 5–10 nm chromium or titanium and 100–200 nm copper seed layer by sputtering. The copper microcoils (microstructures) are patterned using the UV photolithography. The AZ-4562 photoresist can be spincoated and prebaked on a ramped hot plate at 90–100°C (ramp 30–40% with initial temperature 20–25°C) for one hour. Then, the photoresist is exposed in the Karl Suss Contact Masker with the energy 1200–1800 mJ cm². The development is released in 1:4 diluted alkaline solution (AZ-400) for 4–6 min. This gives the photoresist thickness 15–25 μm. Copper is electroplated with a three-electrode system with a copper anode and a saturated calomel reference electrode (the current power supply is the Perkin Elmer Current Source EG&G 263). The Shipley sulfate bath with the 5–10 ml/l brightener to smooth the deposit can be used. The electrodeposition is performed at 20–25°C with magnetic stirring and the dc current density 40–60 mA/cm² (this current density leads to smooth copper thin films with the 5–10 nm rms roughness for the 10 μm thickness of the deposited copper thin film). The resistivity of the electrodeposited copper thin film (microcoils) is 1.6–1.8 μΩ cm (close to the bulk copper resistivity). After the deposition, the photoresist is removed.

It was emphasized that electroplating is used to deposit thin-film conductors and magnetic materials. However, microtransducers need the insulation layers, otherwise the magnetic core and coils as well as multilayer microcoils themselves will be short-circuited. Furthermore, the seed layers are embedded in microfabrication processes. As the magnetic core is fabricated on top of the microcoils (or microcoils are made on the magnetic core), the seed layer is difficult to remove because it is at the bottom or at the center of the microstructure. The mesh seed layer can serve as the electroplating seed layer for the lower conductors, and as the microstructure is made, the edges of the mesh seed layer can be exposed and removed through plasma etching [6]. Thus, the microcoils are insulated. It should be emphasized that relatively high aspect ratio techniques must be used to fabricate the magnetic core and microcoils, and patterning as well as surface planarization issues must be addressed.

NiFe Thin Films Electrodeposition

Magnetic cores in microstructures and microtransducers must be made. For example, the electroplated Ni_{x%}Fe_{100-x%} thin films, such as *permalloy* Ni_{80%}Fe_{20%}, can be deposited to form the magnetic core of microtransducers (actuators and sensors), inductors, transformers, switches, etc. The basic processes and sequential steps used are similar to the processes for the copper electrodeposition and the electroplating is done in the electroplating bath. The windings (microcoils) must be insulated from magnetic cores, and therefore, the insulation layers must be deposited. The insulating materials used to insulate the windings from the magnetic core are benzocyclobutene, polyimide (PI-2611), etc. For example, the cyclo-tene 7200-35 is photosensitive and can be patterned through photolithography. The benzocyclobutene,

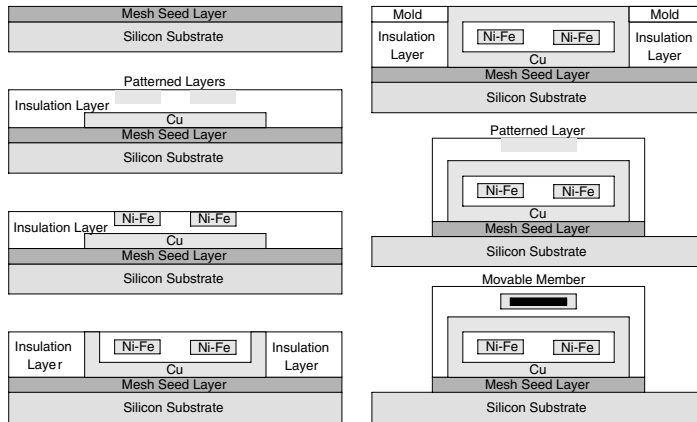

FIGURE 20.132 Basic fabrication sequential steps for the microtransducer fabrication.

used as the photoresist, offers good planarization and pattern properties, stability at low temperatures, and exhibits negligible hydrophilic properties.

The sketched fabrication process with sequential steps to make the electromagnetic microtransducer with a movable member is illustrated in Fig. 20.132. On the silicon substrate, the chromium–copper–chromium (Cr–Cu–Cr) mesh seed layer is deposited (through electron-beam evaporation) forming a seed layer for electroplating. The insulation layer (polyimide Dupont PI-2611) is spun on the top of the mesh seed layer to form the electroplating molds. Several coats can be done to obtain the desired thickness of the polyimide molds (one coat results in 8–12 μm insulation layer thickness). After coating, the polyimide is cured (at 280–310°C) in nitrogen for 1 h. A thin aluminum layer is deposited on top of the cured polyimide to form a hard mask for dry etching. Molds for the lower conductors are patterned and plasma etched until the seed layer is exposed. After etching the aluminum (hard mask) and chromium (top chromium–copper–chromium seed layer), the molds are filled with the electroplated copper, applying the described copper electroplating process. One coat of polyimide insulates the lower conductors and the magnetic core (thus, the insulation is achieved). The seed layer is deposited, mesh-patterned, coated with polyimide, and hard-cured. The aluminum thin layers (hard mask for dry etching) are deposited, and the mold for the magnetic cores is patterned and etched until the seed layer is exposed. After etching the aluminum (hard mask) and the chromium (top chromium–copper–chromium seed layer), the mold is filled with the electroplated $\text{Ni}_{x\%}\text{Fe}_{100-x\%}$ thin films (electroplating process). One coat of the insulating layer (polyimide) is spin-cast and cured to insulate the magnetic core and upper conductors. The via holes are patterned in the sputtered aluminum layer (hard mask) and etched through the polyimide layer using oxygen plasma. The vias are filled with the electroplated copper (electroplating process). A copper–chromium seed layer is deposited and the molds for the upper conductors are formed using thick photoresist. The molds are filled with the electroplated copper and removed. Then, the gap for the movable member is made using the conventional processes. After removing the seed layer, the passivation layer (polyimide) is coated and cured to protect the top conductors. The polyimide is masked and etched to the silicon substrate. The bottom mesh seed layer is wet etched and the microtransducer (with the ICs to control it) is diced and sealed.

Electroplated aluminum is the needed material to fabricate microstructures. In particular, aluminum can be used as the conductor to fabricate microcoils as well as mechanical microstructures (gears, bearing, pins, reflecting surfaces, etc.). Advanced techniques and processes for the electrodeposition of aluminum are documented in [9].

As was reported, the magnetic core of microstructures and microtransducers must be fabricated. Two major challenges in fabrication of high-performance microstructures are to make electroplated magnetic thin films with good magnetic properties as well as planarize microstructures (stationary and movable

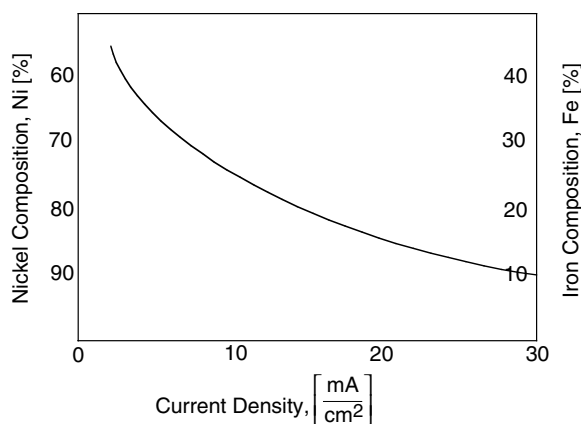

FIGURE 20.133 Nickel and iron compositions in $\text{Ni}_x\text{Fe}_{100-x}$ thin films as the functions of the current density.

members) [10]. Electroplating and micromolding techniques and processes are used to deposit NiFe alloys ($\text{Ni}_x\text{Fe}_{100-x}$ thin films), and $\text{Ni}_{80}\text{Fe}_{20}$ is called *permalloy*, while $\text{Ni}_{50}\text{Fe}_{50}$ is called *orthonol*.

Let us document the deposition process. To deposit $\text{Ni}_x\text{Fe}_{100-x}$ thin films, the silicon wafer is covered with a seed layer (for example, 15–25 nm chromium, 100–200 nm copper, and 25–50 nm chromium) deposited using electron beam evaporation. The photoresist layer (e.g., 10–20 μm Shipley STR-1110) is deposited on the seed layer and patterned. Then, the electrodeposition of the $\text{Ni}_x\text{Fe}_{100-x}$ is performed at 20–30°C using a two-electrode system, and the current density is in the range from 1 to 30 mA/cm^2 . The temperature and pH should be maintained within the recommended values. High pH causes highly stressed NiFe thin films, and the low pH reduces leveling and cause chemical dissolving of the iron anodes resulting in disruption of the bath equilibrium and nonuniformity. High temperature leads to hazy deposits, and low temperature causes high current density burning. For deposition, the pulse-width-modulation (with varied waveforms, different forward and reverse magnitudes, and controlled duty cycle) can be used applying commercial or in-house made pulsed power supplies. Denoting the duty cycle length as T , the forward and reverse pulses lengths are denoted as T_f and T_r . The pulse length T can be 5–20 μs , and the duty cycle (ratio T_f/T_r) can be varied from 1 to 0.1. The ratio T_f/T_r influences the percentage of Ni in the $\text{Ni}_x\text{Fe}_{100-x}$ thin films, e.g., the composition of $\text{Ni}_x\text{Fe}_{100-x}$ can be regulated based upon the desired properties, which will be discussed later. However, varying the ratio T_f/T_r , the changes of the Ni are relatively modest (from 85% to 79%), and therefore, other parameters must vary to attain the desired composition.

It must be emphasized that the nickel (and iron) composition is a function of the current density, and Fig. 20.133 illustrates the nickel (iron) composition in the $\text{Ni}_x\text{Fe}_{100-x}$ thin films.

The $\text{Ni}_{80}\text{Fe}_{20}$ thin films of different thickness (which is a function of the electrodeposition time) are usually made at the current density 14–16 mA/cm^2 . This range of the current density can be used to fabricate a various thickness of *permalloy* thin films (from 500 nm to 50 μm). The rms value of the thin film roughness is 4–7 nm for the 25 μm thickness. It should be emphasized that to guarantee good surface quality, the current density should be kept at the specified range, and usually to change the composition of the $\text{Ni}_x\text{Fe}_{100-x}$ thin films, the reverse current is controlled.

To attain a good deposit of the *permalloy*, the electroplating bath contains NiSO_4 (0.7 mol/l), FeSO_4 (0.03 mol/l), NiCl_2 (0.02 mol/l), saccharine (0.016 mol/l) as leveler (to reduce the residual stress allowing the fabrication of thicker films), and boric acid (0.4 mol/l).

The air agitation and saccharin were added to reduce internal stress and to keep the Fe composition stable. The deposition rate varies linearly as a function of the current density (the Faraday law is obeyed), and the electrodeposition slope is 100–150 $\text{nm}/\text{cm}^2/\text{min}/\text{mA}$. The *permalloy* thin films' density is 9 g/cm^3 (as for the bulk *permalloy*).

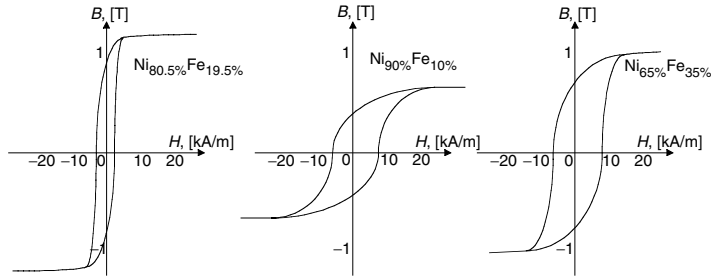

FIGURE 20.134 B - H curves for different $\text{Ni}_{x\%}\text{Fe}_{100-x\%}$ permalloy thin films.

The magnetic properties of the $\text{Ni}_{80\%}\text{Fe}_{20\%}$ (permalloy) thin films are studied, and the field coercivity (H_c) is a function of the thickness. For example, $H_c = 650$ A/m for 150 nm thickness and $H_c = 30$ A/m for 600 nm films.

Other $\text{Ni}_{80\%}\text{Fe}_{20\%}$ (deposited at 25°C) and $\text{Ni}_{50\%}\text{Fe}_{50\%}$ (deposited at 55°C) electroplating solutions are:

- $\text{Ni}_{80\%}\text{Fe}_{20\%}$: $\text{NiSO}_4\text{-}6\text{H}_2\text{O}$ (200 g/l), $\text{FeSO}_4\text{-}7\text{H}_2\text{O}$ (9 g/l), $\text{NiCl}_2\text{-}6\text{H}_2\text{O}$ (5 g/l), H_3BO_3 (27 g/l), saccharine (3 g/l), and pH (2.5–3.5);
- $\text{Ni}_{50\%}\text{Fe}_{50\%}$: $\text{NiSO}_4\text{-}6\text{H}_2\text{O}$ (170 g/l), $\text{FeSO}_4\text{-}7\text{H}_2\text{O}$ (80 g/l), $\text{NiCl}_2\text{-}6\text{H}_2\text{O}$ (138 g/l), H_3BO_3 (50 g/l), saccharine (3 g/l), and pH (3.5–4.5).

To electroplate $\text{Ni}_x\%\text{Fe}_{100-x\%}$ thin films, various additives and components (available from M&T Chemicals and other suppliers) can be used to control the internal stress and ductility of the deposit, keep the iron content solubilized, obtain bright film and leveling of the process, attain the desired surface roughness, and most importantly to guarantee the desired magnetic properties.

In general, the permalloy thin films have optimal magnetic properties at the following composition: 80.5% of Ni and 19.5% of Fe. For $\text{Ni}_{80.5\%}\text{Fe}_{19.5\%}$ thin films, the material magnetostriction has zero crossing. Films with minimal magnetostriction usually have optimal coercivity and permeability properties, and, in general, the coercivity (depending on the films thickness) is 20 A/m (and higher as the thickness decreases), and permeability is from 600 to 2000. Varying the composition of Fe and Ni, the characteristics of the $\text{Ni}_x\%\text{Fe}_{100-x\%}$ thin films can be changed. The composition of the $\text{Ni}_x\%\text{Fe}_{100-x\%}$ thin films is controlled by changing the current density, T_f/T_r ratio (duty cycle), bath temperature (varying the temperature, the composition of Ni can be varied from 75 to 92%), reverse current (varying the reverse current in the range 0–1 A, the composition of Ni can be changed from 72 to 90%), air agitation of the solution, paddle frequency (0.1–1 Hz), forward and reverse pulses waveforms, etc. The B - H curves for three different $\text{Ni}_x\%\text{Fe}_{100-x\%}$ thin films are illustrated in Fig. 20.134. The $\text{Ni}_{80.5\%}\text{Fe}_{19.5\%}$ thin films have the saturation flux density 1.2 T, remanence $B_r = 0.26$ T-A/m, and the relative permeability 600–2000.

It must be emphasized that other electroplated permanent magnets (NiFeMo, NiCo, CoNiMnP, and other) and micromachined polymer magnets exhibit good magnetic properties and can be used as the alternative solution to the $\text{Ni}_x\%\text{Fe}_{100-x\%}$ thin films widely used.

NiFeMo and NiCo Thin Films Electrodeposition

To attain the desired magnetic properties (flux density, coercivity, permeability, etc.) and thickness, different thin film alloys can be used based upon the microstructure's and microtransducer's design, applications, and operating envelopes (temperature, shocks, radiation, humidity, etc.). As was discussed, the $\text{Ni}_x\%\text{Fe}_{100-x\%}$ thin films can be effectively used, and the desired magnetic properties can be readily achieved varying the composition of Ni and Fe. For sensors, the designer usually maximizes the flux density and permeability and minimizes the coercivity. The $\text{Ni}_x\%\text{Fe}_{100-x\%}$ thin films have the flux density up to 1.2 T, coercivity 20 (permalloy) to 500 A/m, and permeability 600–2000 (it was emphasized that

the magnetic properties also depend upon the thickness). Having emphasized the magnetic properties of the $\text{Ni}_x\text{Fe}_{100-x}$ thin films, let us perform the comparison. It was reported in the literature that [11]:

$\text{Ni}_{79\%}\text{Fe}_{17\%}\text{Mo}_{4\%}$ thin films have the flux density 0.7 T, coercivity 5 A/m, and permeability 3400, $\text{Ni}_{85\%}\text{Fe}_{14\%}\text{Mo}_{1\%}$ thin films have the flux density 1–1.1 T, coercivity 8–300 A/m, and permeability 3000–20000, $\text{Ni}_{50\%}\text{Co}_{50\%}$ thin films have the flux density 0.95–1.1 T, coercivity 1200–1500 A/m, and permeability 100–150 ($\text{Ni}_{79\%}\text{Co}_{21\%}$ thin films have the permeability 20).

In general, high flux density, low coercivity, and high permeability lead to high-performance MEMS. However, other issues (affordability, compliance, integrity, operating envelope, fabrication, etc.) must be also addressed while making the final choice. It must be emphasized that the magnetic characteristics, in addition to the film thickness, are significantly influenced by the fabrication processes and chemicals (materials) used.

The magnetic core in microstructures and microtransducers must be made. Two major challenges in fabrication of high-performance microstructures and microtransducers are to make electroplated magnetic thin films with good magnetic properties as well as planarize the stationary and movable members. Electroplating and micromolding techniques and processes are used to deposit NiFe, NiFeMo, and NiCo thin films. In particular, the $\text{Ni}_{80\%}\text{Fe}_{20\%}$, NiFeMo, and NiCo (deposited at 25°C) electroplating solutions are:

- $\text{Ni}_{80\%}\text{Fe}_{20\%}$: $\text{NiSO}_4-6\text{H}_2\text{O}$ (200 g/l), $\text{FeSO}_4-7\text{H}_2\text{O}$ (9 g/l), $\text{NiCl}_2-6\text{H}_2\text{O}$ (5 g/l), H_3BO_3 (27 g/l), and saccharine (3 g/l). The current density is 10–25 mA/cm² (nickel foil is used as the anode);
- NiFeMo: $\text{NiSO}_4-6\text{H}_2\text{O}$ (60 g/l), $\text{FeSO}_4-7\text{H}_2\text{O}$ (4 g/l), $\text{Na}_2\text{MoO}_4-2\text{H}_2\text{O}$ (2 g/l), NaCl (10 g/l), citric acid (66 g/l), and saccharine (3 g/l). The current density is 10–30 mA/cm² (nickel foil is used as the anode);
- $\text{Ni}_{50\%}\text{Co}_{50\%}$: $\text{NiSO}_4-6\text{H}_2\text{O}$ (300 g/l), $\text{NiCl}_2-6\text{H}_2\text{O}$ (50 g/l), $\text{CoSO}_4-7\text{H}_2\text{O}$ (30 g/l), H_3BO_3 (30 g/l), sodium lauryl sulfate (0.1 g/l), and saccharine (1.5 g/l). The current density is 10–25 mA/cm² (nickel or cobalt can be used as the anode).

The most important feature is that the $\text{Ni}_x\text{Fe}_{100-x}$ -NiFeMo-NiCo thin films (multiplayer nanocomposites) can be fabricated shaping the magnetic properties of the resulting materials to attain the desired performance characteristics through design and fabrication processes.

Micromachined Polymer Permanent Magnets

Electromagnetic microactuators can be devised and fabricated using micromachined permanent magnet thin films including polymer magnets (magnetically hard ceramic ferrite powder imbedded in epoxy resin). Different forms and geometry of polymer magnets are available. Thin-film disks and plates are uniquely suitable for microactuator applications. For example, to actuate the mirrors in optical devices and optical MEMS, permanent magnets are used in rotational and translational (linear) microtransducers, microsensors, microswitches, etc. These polymer magnets have thickness ranging from hundreds of micrometers to several millimeters. Excellent magnetic properties can be achieved. For example, the micromachined polymer permanent-magnet disk with 80% strontium ferrite concentration (4 mm diameter and 90 μm thickness), magnetized normal to the thin-film plane (in the thickness direction), has the intrinsic coercivity $H_{ci} = 320,000$ A/m and a residual induction $B_r = 0.06$ T [12]. Permanent-magnet polymer magnets with thickness up to several millimeters can be fabricated by the low-temperature processes. To make the permanent magnets, the Hoosier Magnetics Co. strontium ferrite powder (1.1–1.5 μm grain size) and Shell epoxy resin (cured at 80°C for 2 h) can be used [12]. The polymer matrix contain a bisphenol-A-based epoxy resin diluted with cresylglycidyl ether and the aliphatic amidoamine is used as for curing. To prepare the polymer magnet composites, the strontium ferrite powder is mixed with the epoxy resin in the ball-mill rotating system (0.5 rad/s for many hours). After the aliphatic amidoamine is added, the epoxy is deposited and patterned using screen-printing. Then, the magnet is cured at 80°C for 2 h and magnetized in the desired direction.

It must be emphasized that magnets must be magnetized. That is, in addition to fabrication processes, one should study other issues, for example, the magnetization dynamics. The magnetic field in thin films are modeled, analyzed, and simulated solving differential equations, and the analytic and numerical results will be covered.

Magnetization Dynamics of Thin Films

The magnetic field, including the magnetization distribution, in thin films are modeled, analyzed, and simulated solving differential equations. The dynamic variables are the magnetic field density and intensity, magnetization, magnetization direction, wall position domain, etc. The thin films must be magnetized. Therefore, let us study the magnetization dynamics for thin films. To attain high-fidelity modeling, the magnetization dynamics in the angular coordinates is described by the Landay–Lifschitz–Gilbert equations [13]:

$$\begin{aligned}\frac{d\psi}{dt} &= -\frac{\gamma}{M_s(1+\alpha^2)}\left(\sin^{-1}\psi\frac{\partial E(\theta,\psi)}{\partial\theta} + \alpha\frac{\partial E(\theta,\psi)}{\partial\psi}\right) \\ \frac{d\theta}{dt} &= -\frac{\gamma\sin^{-1}\psi}{M_s(1+\alpha^2)}\left(\alpha\sin^{-1}\psi\frac{\partial E(\theta,\psi)}{\partial\theta} - \frac{\partial E(\theta,\psi)}{\partial\psi}\right)\end{aligned}$$

where M_s is the saturation magnetization; $E(\theta, \psi)$ is the total Gibb's thin film free energy density; γ and α are the gyromagnetic and phenomenological constants.

The total energy consists the magnetocrystalline anisotropy energy, the exchange energy, and the magnetostatic self-energy (stray field energy) [14]:

$$E = \int_v \left(\frac{k_{\text{exh}}}{J_s^2} \sum_{j=1}^3 (\nabla J_j)^2 - \frac{k_j}{J_s^2} (\mathbf{a}_j \cdot \mathbf{J})^2 - \frac{1}{2} \mathbf{J} \cdot \mathbf{H}_D - \mathbf{J} \cdot \mathbf{H}_{\text{ex}} \right) dv \quad (\text{Zeeman energy})$$

$$\frac{\partial \mathbf{J}}{\partial t} = -|\gamma| \mathbf{J} \times \mathbf{H}_{\text{eff}} + \frac{\alpha}{J_s} \mathbf{J} \times \frac{\partial \mathbf{J}}{\partial t} \quad (\text{Gilbert equation})$$

where \mathbf{J} is the magnetic polarization vector, \mathbf{H}_D and \mathbf{H}_{ex} are the demagnetizing and external magnetic fields, \mathbf{H}_{eff} is the effective magnetic field (sum of the applied, demagnetization, and anisotropy fields), k_{exh} and k_j are the exchange and magnetocrystalline anisotropy constants, \mathbf{a}_j is the unit vector parallel to the uniaxial easy axis.

Using the vector notations, we have

$$\frac{d\mathbf{M}}{dt} = -\frac{\gamma}{1+\alpha^2} \left(\mathbf{M} \times \mathbf{H}_{\text{eff}} + \frac{\alpha}{M_s} \mathbf{M} \times (\mathbf{M} \times \mathbf{H}_{\text{eff}}) \right)$$

Thus, using the nonlinear differential equations given, the high-fidelity modeling and analysis of nanostructured nanocomposite permanent magnets can be performed using field and material quantities, parameters, constants, etc.

Microstructures and Microtransducers with Permanent Magnets: Micromirror Actuator

The electromagnetic microactuator (permanent magnet on the cantilever flexible beam and spiral planar windings controlled by ICs fabricated using CMOS-MEMS technology) is illustrated in [Fig. 20.135](#).

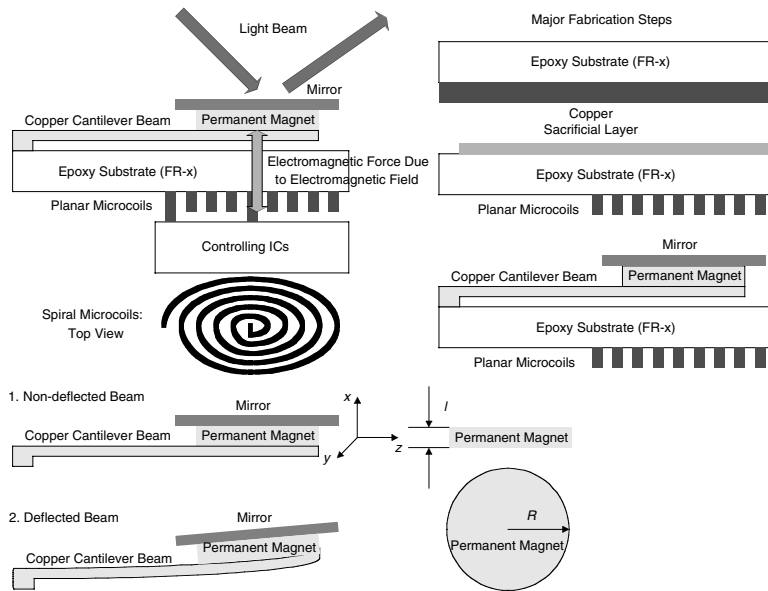

FIGURE 20.135 Electromagnetic microactuator with controlling ICs.

The electromagnetic microactuators can be made using conventional surface micromachining and CMOS fabrication technologies through electroplating, screen printing, lamination processes, sacrificial layer techniques, photolithography, etching, etc. In particular, the electromagnetic microactuator studied can be made on the commercially available epoxy substrates (e.g., FR series), which have the one-sided laminated copper layer (the copper layer thickness, which can be from $10\ \mu\text{m}$ and higher, is defined by the admissible current density and the current value needed to establish the desired magnetic field to attain the specified mirror deflection, deflection rate, settling time, and other steady-state and dynamic characteristics). The spiral planar microcoils can be made on the one-sides laminated copper layer using photolithography and wet etching in the ferric chloride solution. The resulting $x\text{-}\mu\text{m}$ thick N -turn microwinding will establish the magnetic field (the number of turns is a function of the footprint area available, thickness, spacing, outer-inner radii, geometry, fabrication techniques and processes used, etc.). After fabrication of the planar microcoils, the cantilever beam with the permanent magnet and mirror is fabricated on other side of the substrate. First, a photoresist sacrificial layer is spin-coated and patterned on the substrate. Then, a Ti–Cu–Cr seed layer is deposited to perform the copper electroplating (if the copper is used to fabricate the flexible cantilever structure). The second photoresist layer is spun and patterned to serve as a mold for the electroplating of the copper-based cantilever beam. The copper cantilever beam is electroplated in the copper-sulfate-based plating bath. After the electroplating, the photoresist plating mold and the seed layer are removed releasing the cantilever beam structure. It must be emphasized that depending upon the permanent magnet used, the corresponding fabricated processes must be done before or after releasing the beam. The permanent-magnet disk is positioned on the cantilever beam free end (for example, the polymer magnet can be screen-printed, and after curing the epoxy magnet, the magnet is magnetized by the external magnetic field). Then, the cantilever beam with the fabricated mirror is released by removing the sacrificial photoresist layer using acetone. It must be emphasized that the studied electromagnetic microactuator is fabricated using low-cost (affordable), high-yield micromachining—CMOS technology, processes, and materials. The most attractive feature is the application of the planar microcoils, which can be easily made. The use of the polymer permanent magnets (which have good magnetic properties) allows one to design high-performance electromagnetic microactuators. It must be emphasized that the polysilicon can be used to fabricate the cantilever beam and other permanent magnets can be applied.

In the article [12], the vertical electromagnetic force F_{ze} , acting on the permanent-magnet, is given by

$$F_{ze} = M_z \int_v \frac{dH_z}{dz} dv,$$

where M_z is the magnetization; H_z is the vertical component of the magnetic field intensity produced by the planar microwindings (H_z is a nonlinear function of the current fed or voltage applied to the microwindings, number of turns, microcoils, geometry, etc.; therefore, the thickness of the microcoils must be derived based on the maximum value of the current needed and the admissible current density).

The magnetically actuated cantilever microstructures were studied also in articles [15,16], and the expressions for the electromagnetic torque are found as the functions of the magnetic field using assumptions and simplifications which, in general, limit the applicability of the results. The differential equations which model the electromagnetic and *torsional-mechanical* dynamics can be derived. In particular, the equations for the electromagnetic field are found using electromagnetic theory, and the electromagnetic field intensity H_z is controlled changing the current applied to the planar microwindings. The steady-state analysis, performed using the small-deflection theory [17], is also valuable. The static deflection of the cantilever beam x can be straightforwardly found using the force and beam quantities. In particular, $x = (l^3/3EJ)F_n$, where, l is the effective length of the beam; E is the Young's (elasticity) modulus; J is the equivalent moment of inertia of the beam with permanent magnet and mirror, and for the stand-alone cantilever beam with the rectangular cross section $J = \frac{1}{12} wh^3$; w and h are the width and thickness of the beam; F_n is the net force, which is normal to the cantilever beam.

In general, assuming that the magnetic flux is constant through the magnetic plane (loop), the torque on a planar current loop of any size and shape in the uniform magnetic field is

$$\mathbf{T} = i\mathbf{s} \times \mathbf{B} = \mathbf{m} \times \mathbf{B}$$

where i is the current and \mathbf{m} is the magnetic dipole moment [Am^2].

Thus, the torque on the current loop always tends to turn the loop to align the magnetic field produced by the loop with the permanent-magnet magnetic field causing the resulting electromagnetic torque.

For example, for the current loop shown in Fig. 20.136, the torque (in Nm) is found to be

$$\mathbf{T} = i\mathbf{s} \times \mathbf{B} = \mathbf{m} \times \mathbf{B} = 1 \times 10^{-3} [(1 \times 10^{-3})(2 \times 10^{-3})\mathbf{a}_z] \times (-0.5\mathbf{a}_y + \mathbf{a}_z) = 1 \times 10^{-9} \mathbf{a}_x$$

The electromagnetic force is found as

$$\mathbf{F} = \oint_l i d\mathbf{l} \times \mathbf{B}$$

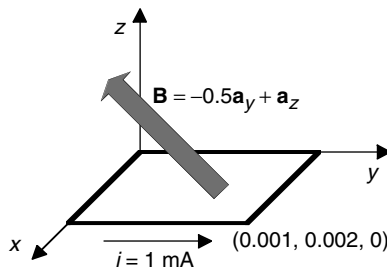

FIGURE 20.136 Rectangular planar loop in a uniform magnetic field with flux density $\mathbf{B} = -0.5\mathbf{a}_y + \mathbf{a}_z$.

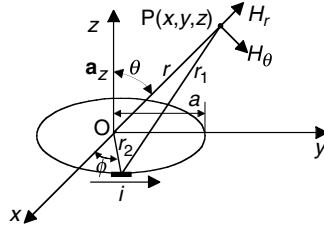

FIGURE 20.137 Planar current loop.

In general, the magnetic field quantities are derived using

$$\mathbf{B} = \frac{\mu_0}{4\pi} i \oint_l \frac{d\mathbf{l} \times \mathbf{r}_0}{r^2} \quad \text{or} \quad \mathbf{H} = \frac{1}{4\pi} i \oint_l \frac{d\mathbf{l} \times \mathbf{r}_0}{r^2}$$

and the Ampere circuital law gives

$$\oint_l \mathbf{H} \cdot d\mathbf{l} = i_{\text{total}} \quad \text{or} \quad \oint_l \mathbf{H} \cdot d\mathbf{l} = Ni$$

Making use of these expressions and taking note of the variables defined in Fig. 20.137, we have

$$\mathbf{H} = \frac{1}{4\pi} i \oint_l \frac{d\mathbf{l} \times \mathbf{r}_1}{r_1^3} \quad \text{and} \quad \mathbf{B} = \frac{\mu_0}{4\pi} i \oint_l \frac{d\mathbf{l} \times \mathbf{r}_1}{r_1^3}$$

where $d\mathbf{l} = \mathbf{a}_\phi a d\phi = (-\mathbf{a}_x \sin\phi + \mathbf{a}_y \cos\phi)a d\phi$ and $\mathbf{r}_1 = \mathbf{a}_x(x - a\cos\phi) + \mathbf{a}_y(y - a\sin\phi) + \mathbf{a}_z z$. Hence,

$$d\mathbf{l} \times \mathbf{r}_1 = [\mathbf{a}_x z \cos\phi + \mathbf{a}_y z \sin\phi - \mathbf{a}_z(y \sin\phi + x \cos\phi - a)]a d\phi.$$

Then, neglecting the small quantities ($a^2 \ll r^2$), we have

$$r_1^3 = (x^2 + y^2 + z^2 + a^2 - 2ax \cos\phi - 2ay \sin\phi)^{3/2} \approx r^3 \left(1 - \frac{2ax}{r^2} \cos\phi - \frac{2ay}{r^2} \sin\phi \right)^{3/2}$$

Therefore, one obtains

$$\frac{1}{r_1^3} = \frac{1}{r^3} \left(1 + \frac{3ax}{r^2} \cos\phi + \frac{3ay}{r^2} \sin\phi \right)$$

Thus,

$$\begin{aligned} \mathbf{B} &= \frac{\mu_0 a}{4\pi} i \int_0^{2\pi} [\mathbf{a}_x z \cos\phi + \mathbf{a}_y z \sin\phi - \mathbf{a}_z(y \sin\phi + x \cos\phi - a)] a \frac{1}{r^3} \left(1 + \frac{3ax}{r^2} \cos\phi + \frac{3ay}{r^2} \sin\phi \right) d\phi \\ &= \frac{\mu_0 a^2}{4\pi r^3} i \left[\mathbf{a}_x \frac{3xz}{r^2} + \mathbf{a}_y \frac{3yz}{r^2} - \mathbf{a}_z \left(\frac{3x^2}{r^2} + \frac{3y^2}{r^2} - 2 \right) \right] \end{aligned}$$

Furthermore, using the coordinate transformation equations, in the spherical coordinate system one has

$$\mathbf{B} = \frac{\mu_0 a^2}{4\pi r^3} i(2\mathbf{a}_r \cos \theta + \mathbf{a}_\theta \sin \theta)$$

We have the expressions for the far-field components

$$B_r = \frac{\mu_0 a^2 \cos \theta}{2\pi r^3} i, \quad B_\theta = \frac{\mu_0 a^2 \sin \theta}{4\pi r^3} i, \quad B_\phi = 0$$

(due to the symmetry about the z axis, the magnetic flux density does not have the B_ϕ component).

Using the documented technique, one can easily find the magnetic vector potential. In particular, in general

$$\mathbf{A} = \frac{\mu_0}{4\pi} i \oint \frac{d\mathbf{l}}{r_1}$$

Assuming that $a^2 \ll r^2$, gives the following expression:

$$\frac{1}{r_1} = \frac{1}{r} \left(1 + \frac{ax}{r^2} \cos \phi + \frac{ay}{r^2} \sin \phi \right)$$

Therefore,

$$\begin{aligned} \mathbf{A} &= \frac{\mu_0 a}{4\pi} i \int_0^{2\pi} (-\mathbf{a}_x \sin \phi + \mathbf{a}_y \cos \phi) \frac{1}{r} \left(1 + \frac{ax}{r^2} \cos \phi + \frac{ay}{r^2} \sin \phi \right) d\phi \\ &= \frac{\mu_0 a}{4\pi r^3} i (-\mathbf{a}_x y + \mathbf{a}_y x) \end{aligned}$$

Hence, in the spherical coordinate system, we obtain

$$\begin{aligned} \mathbf{A} &= (\mathbf{A} \cdot \mathbf{a}_r) \mathbf{a}_r + (\mathbf{A} \cdot \mathbf{a}_\phi) \mathbf{a}_\phi + (\mathbf{A} \cdot \mathbf{a}_\theta) \mathbf{a}_\theta \\ &= \frac{\mu_0 a}{4\pi r^2} i \mathbf{a}_\phi \sin \theta = A_\phi \mathbf{a}_\phi \end{aligned}$$

It should be emphasized that the equations derived can be expressed using the magnetic dipole.

However, in the microtransducer studied, high-fidelity analysis should be performed. Hence, let us perform the comprehensive analysis.

The vector potential is found to be

$$A_\phi(r, \theta) = \frac{\mu_0 a i}{4\pi} \int_0^{2\pi} \frac{\cos \phi d\phi}{\sqrt{a^2 + r^2 - 2ar \sin \theta \cos \phi}}$$

and

$$B_r = \frac{1}{r \sin \theta} \frac{\partial(\sin \theta A_\phi)}{\partial \theta}, \quad B_\theta = -\frac{1}{r} \frac{\partial(r A_\phi)}{\partial r}, \quad B_\phi = 0$$

Making use of the following approximation:

$$A_\phi(r, \theta) = \frac{\mu_0 a i}{4\pi} \int_0^{2\pi} \frac{\cos \phi \, d\phi}{\sqrt{a^2 + r^2 - 2ar \sin \theta \cos \phi}} \approx \frac{\mu_0 a^2 r \sin \theta i}{4(a^2 + r^2)^{3/2}} \left(1 + \frac{15a^2 r^2 \sin^2 \theta}{8(a^2 + r^2)^2} + \dots \right)$$

one finds

$$B_r(r, \theta) = \frac{\mu_0 a^2 \cos \theta i}{2(a^2 + r^2)^{3/2}} \left(1 + \frac{15a^2 r^2 \sin^2 \theta}{4(a^2 + r^2)^2} + \dots \right)$$

$$B_\theta(r, \theta) = -\frac{\mu_0 a^2 \sin \theta i}{4(a^2 + r^2)^{5/2}} \left(2a^2 - r^2 + \frac{15a^2 r^2 \sin^2 \theta (4a^2 - 3r^2)}{8(a^2 + r^2)^2} + \dots \right)$$

$$B_\phi = 0$$

One can specify three regions:

- near the axis $\theta \ll 1$,
- at the center $r \ll a$,
- in far-field $r \gg a$.

The electromagnetic torque and field depend upon the current in the microwindings and are nonlinear functions of the displacement.

The expression for the electromagnetic forces and torques must be derived to model and analyze the *torsional-mechanical* dynamics. Newton's laws of motion can be applied to study the mechanical dynamics in the Cartesian or other coordinate systems (e.g., previously for the translational motion in the x -axis, we used

$$\frac{dv}{dt} = \frac{1}{m} (F_e - F_L) \quad \text{and} \quad \frac{dx}{dt} = v$$

to model the translational *torsional-mechanical* dynamics of the electromagnetic microactuators using the electromagnetic force F_e and the load force F_L).

For the studied microactuator, the rotational motion can be studied, and the electromagnetic torque can be approximated as

$$T_e = 4R^2 t_{if} M H_p \cos \theta$$

where R and t_{if} are the radius and thickness of the permanent-magnet thin-film disk; M is the permanent-magnet thin film magnetization; H_p is the field produced by the planar windings; θ is the displacement angle.

Then, the microactuator rotational dynamics is given by

$$\frac{d\omega}{dt} = \frac{1}{J} (T_e - T_L) \quad \text{and} \quad \frac{d\theta}{dt} = \omega$$

where T_L is the load torque, which integrates the friction and disturbances torques.

It should be emphasized that more complex and comprehensive mathematical models can be developed and used integrating the nonlinear electromagnetic and six-degree-of-freedom rotational-translational motions (*torsional-mechanical* dynamics) of the cantilever beam. As an illustration we consider the high-fidelity modeling of the electromagnetic system.

Electromagnetic System Modeling in Microactuators with Permanent Magnets: High-Fidelity Modeling and Analysis

In this section we focus our efforts to derive the expanded equations for the electromagnetic torque and force on cylindrical permanent-magnet thin films, see Fig. 20.135. The permanent-magnet thin film is assumed to be uniformly magnetized and the equations are developed for two orientations of the magnetization vector (the orientation is parallel to the axis of symmetry, and the orientation is perpendicular to this axis). Electromagnetic fields and gradients produced by the planar windings should be found at a point in inertial space, which coincides with the origin of the permanent-magnet axis system in its initial alignment. Our ultimate goal is to control microactuators, and thus, high-fidelity mathematical models (which will result in viable analysis, control, and optimization) must be derived. To attain our objective, the complete equations for the electromagnetic torque and force on a cylindrical permanent-magnet thin films are found.

The following notations are used: A , R , and l are the area, radius, and length of the cylindrical permanent magnet; \mathbf{B} is the magnetic flux density vector; \mathbf{B}_e is the expanded magnetic flux density vector; $[\partial \mathbf{B}]$ is the matrix of field gradients [T/m]; $[\partial \mathbf{B}_e]$ is the matrix of expanded field gradients [T/m]; \mathbf{F} and \mathbf{T} are the total force and torque vectors on the permanent-magnet thin film; i is the current in the planar microwinding; \mathbf{m} is the magnetic moment vector [$A \text{ m}^2$]; \mathbf{M} is the magnetization vector [A/m]; \mathbf{r} is the position vector (x , y , z are the coordinates in the Cartesian system),

$$\mathbf{r} = \begin{bmatrix} x \\ y \\ z \end{bmatrix}$$

T_r is the inertial coordinate vector-transformation matrix; W and Π are the work and potential energy; θ is the Euler orientation for the 3-2-1 rotation sequence; ∇ is the gradient operator; subscript ij represents partial derivative of i component in j -direction; subscript $(ij)k$ represents partial derivative of ij partial derivative in k -direction; $\bar{}$ (bar over a variable) indicates that it is referenced to the microactuator coordinates.

Electromagnetic Torques and Forces: Preliminaries

The equations for the electromagnetic torque and force on a cylindrical permanent-magnet thin film are found by integrating the equations for torques and forces on an incremental volume of the permanent-magnet thin film with magnetic moment $\mathbf{M}dV$ over the volume. Figure 20.135 illustrates the microactuator with the cylindrical permanent-magnet thin film in the coordinate system, which consists of a set of orthogonal body-fixed axes that are initially aligned with a set of orthogonal x -, y -, z -axes fixed in the inertial space.

The equations for the electromagnetic torque and force on an infinitesimal current can be derived using the fundamental relationship for the force on a current-carrying-conductor element in a uniform magnetic field. In particular, for a planar current loop (planar microwinding) with constant current i in the uniform magnetic field \mathbf{B} (vector \mathbf{B} gives the magnitude and direction of the flux density of the external field), the force on an element $d\mathbf{l}$ of the conductor is found using the Lorentz force law

$$\mathbf{F} = \oint_l i d\mathbf{l} \times \mathbf{B}$$

Assuming that the magnetic flux is constant through the magnetic loop, the torque on a planar current loop of any size and shape in the uniform magnetic field is

$$\mathbf{T} = i \oint_l \mathbf{r} \times (d\mathbf{l} \times \mathbf{B}) = i \oint_l \left((\mathbf{r} \cdot \mathbf{B}) d\mathbf{l} - \mathbf{B} \oint_l \mathbf{r} \cdot d\mathbf{l} \right)$$

Using Stokes's theorem, one has

$$\mathbf{T} = i \left(\oint_s d\mathbf{A} \times \nabla(\mathbf{r} \cdot \mathbf{B}) - \mathbf{B} \oint_s (\nabla \times \mathbf{r}) \cdot d\mathbf{A} \right) = i \oint_s d\mathbf{A} \times \mathbf{B}$$

or

$$\mathbf{T} = i\mathbf{A} \times \mathbf{B} = \mathbf{m} \times \mathbf{B}$$

The electromagnetic torque \mathbf{T} acts on the infinitesimal current loop in a direction to align the magnetic moment \mathbf{m} with the external field \mathbf{B} , and if \mathbf{m} and \mathbf{B} are misaligned by the angle θ , we have

$$\mathbf{T} = \mathbf{mB} \sin \theta$$

The incremental potential energy and work are found as

$$dW = d\Pi = \mathbf{T} \cdot d\boldsymbol{\theta} = mB \sin \theta \, d\theta \quad \text{and} \quad W = \Pi = -mB \cos \theta = -\mathbf{m} \cdot \mathbf{B}$$

Using the electromagnetic force, we have

$$dW = -d\Pi = \mathbf{F} \cdot d\mathbf{r} = -\nabla\Pi \cdot d\mathbf{r}$$

and

$$\mathbf{F} = -\nabla\Pi = \nabla(\mathbf{m} \cdot \mathbf{B}) = (\mathbf{m} \cdot \nabla)\mathbf{B}$$

Coordinate Systems and Electromagnetic Field

The transformation from the inertial coordinates to the permanent-magnet coordinates is

$$\bar{\mathbf{r}} = T_r \mathbf{r} = \begin{bmatrix} \cos \theta_y \cos \theta_z & \cos \theta_y \sin \theta_z & -\sin \theta_y \\ \sin \theta_x \sin \theta_y \cos \theta_z - \cos \theta_x \sin \theta_z & \sin \theta_x \sin \theta_y \sin \theta_z + \cos \theta_x \sin \theta_z & \sin \theta_x \cos \theta_y \\ \cos \theta_x \sin \theta_y \cos \theta_z + \sin \theta_x \sin \theta_z & \cos \theta_x \sin \theta_y \sin \theta_z - \sin \theta_x \cos \theta_z & \cos \theta_x \cos \theta_y \end{bmatrix} \begin{bmatrix} x \\ y \\ z \end{bmatrix}$$

$$\mathbf{r} = \begin{bmatrix} x \\ y \\ z \end{bmatrix}, \quad \bar{\mathbf{r}} = \begin{bmatrix} \bar{x} \\ \bar{y} \\ \bar{z} \end{bmatrix}$$

We use the transformation matrix

$$T_r = \begin{bmatrix} \cos \theta_y \cos \theta_z & \cos \theta_y \sin \theta_z & -\sin \theta_y \\ \sin \theta_x \sin \theta_y \cos \theta_z - \cos \theta_x \sin \theta_z & \sin \theta_x \sin \theta_y \sin \theta_z + \cos \theta_x \sin \theta_z & \sin \theta_x \cos \theta_y \\ \cos \theta_x \sin \theta_y \cos \theta_z + \sin \theta_x \sin \theta_z & \cos \theta_x \sin \theta_y \sin \theta_z - \sin \theta_x \cos \theta_z & \cos \theta_x \cos \theta_y \end{bmatrix}$$

If the deflections are small, we have

$$T_{rs} = \begin{bmatrix} 1 & \theta_z & -\theta_y \\ -\theta_z & 1 & \theta_x \\ \theta_y & -\theta_x & 1 \end{bmatrix}$$

It should be emphasized that we use the 3-2-1 orthogonal transformation matrix for the z-y-x Euler rotation sequence, and $\theta_x, \theta_y, \theta_z$ are the rotation Euler angle about the x, y, and z axes.

The field \mathbf{B} and gradients of \mathbf{B} produced by the microcoils fixed in the inertial frame and expressed assuming that the electromagnetic fields can be described by the second-order Taylor series. Expanding \mathbf{B} about the origin of the x, y, z system as a Taylor series, we have [18]

$$\mathbf{B}_e = \mathbf{B} + (\mathbf{r} \cdot \nabla)\mathbf{B} + \frac{1}{2}(\mathbf{r} \cdot \nabla)^2\mathbf{B}$$

or

$$B_{ei} = B_i + \frac{\partial B_i}{\partial \mathbf{r}}\mathbf{r} + \frac{1}{2}\mathbf{r}^T \frac{\partial^2 B_i}{\partial \mathbf{r}^2}\mathbf{r}$$

where

$$\frac{\partial B_i}{\partial \mathbf{r}} = \begin{bmatrix} \frac{\partial B_i}{\partial x} & \frac{\partial B_i}{\partial y} & \frac{\partial B_i}{\partial z} \end{bmatrix} \quad \text{and} \quad \frac{\partial^2 B_i}{\partial \mathbf{r}^2} = \begin{bmatrix} \frac{\partial^2 B_i}{\partial x^2} & \frac{\partial^2 B_i}{\partial x \partial y} & \frac{\partial^2 B_i}{\partial x \partial z} \\ \frac{\partial^2 B_i}{\partial x \partial y} & \frac{\partial^2 B_i}{\partial y^2} & \frac{\partial^2 B_i}{\partial y \partial z} \\ \frac{\partial^2 B_i}{\partial x \partial z} & \frac{\partial^2 B_i}{\partial y \partial z} & \frac{\partial^2 B_i}{\partial z^2} \end{bmatrix}$$

We denote

$$B_{ij} = \frac{\partial B_i}{\partial j} \quad \text{and} \quad B_{(ij)k} = \frac{\partial^2 B_i}{\partial j \partial k}$$

Then,

$$\frac{\partial B_i}{\partial \mathbf{r}} = [B_{ix} \quad B_{iy} \quad B_{iz}] \quad \text{and} \quad \frac{\partial^2 B_i}{\partial \mathbf{r}^2} = \begin{bmatrix} B_{(ix)x} & B_{(ix)y} & B_{(ix)z} \\ B_{(iy)x} & B_{(iy)y} & B_{(iy)z} \\ B_{(iz)x} & B_{(iz)y} & B_{(iz)z} \end{bmatrix}$$

Hence, the first-order gradients are given as

$$B_{eij} = B_{ij} + \frac{\partial^2 B_i}{\partial \mathbf{r}}\mathbf{r} = B_{ij} + [B_{(ij)x} \quad B_{(ij)y} \quad B_{(ij)z}]\mathbf{r}$$

The expanded field is expressed in the permanent-magnet coordinates as

$$\bar{\mathbf{B}}_e = \bar{\mathbf{B}} + (\bar{\mathbf{r}} \cdot \bar{\nabla})\bar{\mathbf{B}} + \frac{1}{2}(\bar{\mathbf{r}} \cdot \bar{\nabla})^2\bar{\mathbf{B}}$$

where $\bar{\mathbf{B}} = T_r\mathbf{B}$ and $\bar{\nabla} = T_r\nabla$.

Using $\mathbf{r} = T_r^T \bar{\mathbf{r}}$, one has

$$B_{ei} = B_i + \frac{\partial B_i}{\partial \mathbf{r}} T_r^T \bar{\mathbf{r}} + \frac{1}{2} \bar{\mathbf{r}}^T T_r \frac{\partial^2 B_i}{\partial \mathbf{r}^2} T_r^T \bar{\mathbf{r}}$$

and

$$\bar{\mathbf{B}}_e = T_r \begin{bmatrix} B_x + \frac{\partial B_x}{\partial \mathbf{r}} T_r^T \bar{\mathbf{r}} + \frac{1}{2} \bar{\mathbf{r}}^T T_r \frac{\partial^2 B_x}{\partial \mathbf{r}^2} T_r^T \bar{\mathbf{r}} \\ B_y + \frac{\partial B_y}{\partial \mathbf{r}} T_r^T \bar{\mathbf{r}} + \frac{1}{2} \bar{\mathbf{r}}^T T_r \frac{\partial^2 B_y}{\partial \mathbf{r}^2} T_r^T \bar{\mathbf{r}} \\ B_z + \frac{\partial B_z}{\partial \mathbf{r}} T_r^T \bar{\mathbf{r}} + \frac{1}{2} \bar{\mathbf{r}}^T T_r \frac{\partial^2 B_z}{\partial \mathbf{r}^2} T_r^T \bar{\mathbf{r}} \end{bmatrix}$$

Electromagnetic Torques and Forces

Now let us derive the fields and gradients at any point in the permanent magnet using the second-order Taylor series approximation. To eliminate the transformations between the inertial and permanent magnet coordinate systems and simplify the second-order negligible small components, we assume that the relative motion between the magnet and the reference inertial coordinate is zero and the T_{rs} transformation matrix is used (otherwise, the second-order gradient terms will lead to cumbersome results).

The magnetization (the magnetic moment per unit volume) is constant over the volume of the permanent-magnet thin films, and $\mathbf{m} = M\mathbf{v}$.

Assuming that the magnetic flux is constant, the total electromagnetic torque and force on a planar current loop (microwinding) in the uniform magnetic field is

$$\begin{aligned} \bar{\mathbf{T}} &= \int_v (\bar{\mathbf{M}} \times \bar{\mathbf{B}}_e + \bar{\mathbf{r}} \times (\bar{\mathbf{M}} \cdot \nabla) \bar{\mathbf{B}}_e) dv \\ \bar{\mathbf{F}} &= \int_v (\bar{\mathbf{M}} \cdot \nabla) \bar{\mathbf{B}}_e dv \end{aligned}$$

where

$$(\bar{\mathbf{M}} \cdot \nabla) \bar{\mathbf{B}}_e = [\partial \bar{\mathbf{B}}_e] \bar{\mathbf{M}} = \begin{bmatrix} B_{exx} & B_{exy} & B_{exz} \\ B_{eyx} & B_{eyy} & B_{eyz} \\ B_{ezx} & B_{ezy} & B_{ezz} \end{bmatrix} \begin{bmatrix} M_{\bar{x}} \\ M_{\bar{y}} \\ M_{\bar{z}} \end{bmatrix}$$

Case 1: Magnetization Along the Axis of Symmetry

For orientation of the magnetization vector along the axis of symmetry (x -axis) of the permanent-magnet thin films, we have

$$(\bar{\mathbf{M}} \cdot \nabla) \bar{\mathbf{B}}_e = [\partial \bar{\mathbf{B}}_e] \bar{\mathbf{M}} = M_{\bar{x}} \begin{bmatrix} B_{exx} \\ B_{exy} \\ B_{exz} \end{bmatrix}$$

Thus, in the expression $\bar{\mathbf{T}} = \int_v (\bar{\mathbf{M}} \times \bar{\mathbf{B}}_e + \bar{\mathbf{r}} \times (\bar{\mathbf{M}} \cdot \nabla) \bar{\mathbf{B}}_e) dv$,

the terms are

$$\bar{\mathbf{r}} \times (\bar{\mathbf{M}} \cdot \nabla) \mathbf{B}_e = M_{\bar{x}} \begin{bmatrix} -B_{exy}\bar{z} + B_{exz}\bar{y} \\ B_{exx}\bar{z} - B_{exz}\bar{x} \\ -B_{exx}\bar{y} + B_{exy}\bar{x} \end{bmatrix} \quad \text{and} \quad \bar{\mathbf{M}} \times \mathbf{B}_e = M_{\bar{x}} \begin{bmatrix} 0 \\ -B_{ez} \\ B_{ey} \end{bmatrix}$$

Therefore,

$$T_{\bar{x}} = M_{\bar{x}} \int_{\nu} (B_{exz}\bar{y} - B_{exy}\bar{z}) d\nu$$

$$T_{\bar{y}} = -M_{\bar{x}} \int_{\nu} B_{ez} d\nu + M_{\bar{x}} \int_{\nu} (B_{exx}\bar{z} - B_{exz}\bar{x}) d\nu$$

and

$$T_{\bar{z}} = M_{\bar{x}} \int_{\nu} B_{ey} d\nu + M_{\bar{x}} \int_{\nu} (B_{exy}\bar{x} - B_{exx}\bar{y}) d\nu$$

The terms in the derived equations must be evaluated.

Let us find the analytic expression for the electromagnetic torque $T_{\bar{x}}$. In particular, we have

$$\int_{\nu} B_{exz}\bar{y} d\nu = B_{xz} \int_{\nu} \bar{y} d\nu + B_{(xx)z} \int_{\nu} \bar{x}\bar{y} d\nu + B_{(xy)z} \int_{\nu} \bar{y}^2 d\nu + B_{(xz)z} \int_{\nu} \bar{z}\bar{y} d\nu$$

where

$$\int_{\nu} \bar{y} d\nu = 0, \quad \int_{\nu} \bar{x}\bar{y} d\nu = 0, \quad \int_{\nu} \bar{z}\bar{y} d\nu = 0$$

and

$$\int_{\nu} \bar{y}^2 d\nu = \int_{-\frac{l}{2}}^{\frac{l}{2}} \int_{-R}^R \int_{-\sqrt{R^2-\bar{z}^2}}^{\sqrt{R^2-\bar{z}^2}} \bar{y}^2 d\bar{y} d\bar{z} d\bar{x} = \frac{1}{4} \pi l R^4 = \frac{1}{4} \nu R^4$$

Therefore,

$$M_{\bar{x}} \int_{\nu} B_{exz}\bar{y} d\nu = M_{\bar{x}} \frac{1}{4} B_{(xy)z} \nu R^4$$

Furthermore,

$$M_{\bar{x}} \int_{\nu} B_{exy}\bar{z} d\nu = M_{\bar{x}} \frac{1}{4} B_{(xy)z} \nu R^4$$

Thus, for $T_{\bar{x}}$, one has

$$T_{\bar{x}} = M_{\bar{x}} \int_{\nu} (B_{exz}\bar{y} - B_{exy}\bar{z}) d\nu = M_{\bar{x}} \left(\frac{1}{4} B_{(xy)z} \nu R^4 - \frac{1}{4} B_{(xy)z} \nu R^4 \right) = 0$$

Then, for $T_{\bar{y}}$, we obtain

$$\begin{aligned}
 T_{\bar{y}} &= -M_{\bar{x}} \int_{\nu} B_{ez} d\nu + M_{\bar{x}} \int_{\nu} (B_{exx}\bar{z} - B_{exz}\bar{x}) d\nu \\
 &= M_{\bar{x}} \left[- \left(B_z + B_{(zx)x} \frac{1}{24} l^2 + B_{(zy)y} \frac{1}{8} R^2 + B_{(zz)z} \frac{1}{8} R^2 \right) \nu + B_{(xx)z} \left(\frac{1}{4} R^2 - \frac{1}{12} l^2 \right) \nu \right] \\
 &= -\nu M_{\bar{x}} \left[B_z + B_{(xx)z} \left(\frac{1}{4} R^2 - \frac{1}{8} l^2 \right) + B_{(yy)z} \frac{1}{8} R^2 + B_{(zz)z} \frac{1}{4} R^2 \right]
 \end{aligned}$$

Finally, we obtain the expression for T_z as

$$\begin{aligned}
 T_{\bar{z}} &= M_{\bar{x}} \int_{\nu} B_{ey} d\nu + M_{\bar{x}} \int_{\nu} (B_{exy}\bar{x} - B_{exx}\bar{y}) d\nu \\
 &= \nu M_{\bar{x}} \left[B_y + B_{(xx)y} \left(\frac{1}{8} l^2 - \frac{1}{4} R^2 \right) - B_{(yy)y} \frac{1}{8} R^2 - B_{(yz)z} \frac{1}{8} R^2 \right]
 \end{aligned}$$

Thus, the following electromagnetic torque equations result:

$$\begin{aligned}
 T_{\bar{x}} &= 0 \\
 T_{\bar{y}} &= -\nu M_{\bar{x}} \left[B_z + B_{(xx)z} \left(\frac{1}{4} R^2 - \frac{1}{8} l^2 \right) + B_{(yy)z} \frac{1}{8} R^2 + B_{(zz)z} \frac{1}{4} R^2 \right] \\
 T_{\bar{z}} &= \nu M_{\bar{x}} \left[B_y + B_{(xx)y} \left(\frac{1}{8} l^2 - \frac{1}{4} R^2 \right) - B_{(yy)y} \frac{1}{8} R^2 - B_{(yz)z} \frac{1}{8} R^2 \right]
 \end{aligned}$$

The electromagnetic forces are found as well. In particular, from

$$\begin{aligned}
 F_{\bar{x}} &= M_{\bar{x}} \int_{\nu} B_{exx} d\nu \\
 F_{\bar{y}} &= M_{\bar{x}} \int_{\nu} B_{exy} d\nu
 \end{aligned}$$

and

$$F_{\bar{z}} = M_{\bar{x}} \int_{\nu} B_{exz} d\nu$$

using the expressions for the expanded magnetic fluxes, e.g.,

$$\int_{\nu} B_{exx} d\nu = \int_{\nu} (B_{xx} + B_{(xx)x}\bar{x} + B_{(xx)y}\bar{y} + B_{(xx)z}\bar{z}) d\nu$$

and performing the integration, one has the following expressions for the electromagnetic forces as the function of the magnetic field:

$$F_{\bar{x}} = \nu M_{\bar{x}} B_{xx}, \quad F_{\bar{y}} = \nu M_{\bar{x}} B_{xy}, \quad F_{\bar{z}} = \nu M_{\bar{x}} B_{xz}$$

Case 2: Magnetization Perpendicular to the Axis of Symmetry

For orientation of the magnetization vector perpendicular to the axis of symmetry, the following equation is used to find the electromagnetic torque:

$$\bar{\mathbf{T}} = \int_v (\bar{\mathbf{M}} \times \mathbf{B}_e + \bar{\mathbf{r}} \times (\bar{\mathbf{M}} \cdot \nabla) \mathbf{B}_e) dv$$

where

$$(\bar{\mathbf{M}} \cdot \nabla) \mathbf{B}_e = [\partial \mathbf{B}_e] \bar{\mathbf{M}} = M_z \begin{bmatrix} B_{exz} \\ B_{eyz} \\ B_{ezz} \end{bmatrix} \quad \bar{\mathbf{r}} \times (\bar{\mathbf{M}} \cdot \nabla) \mathbf{B}_e = M_z \begin{bmatrix} -B_{eyz} \bar{z} + B_{ezz} \bar{y} \\ B_{exz} \bar{z} - B_{ezz} \bar{x} \\ B_{exz} \bar{y} + B_{eyz} \bar{x} \end{bmatrix}$$

and

$$\bar{\mathbf{M}} \times \mathbf{B}_e = M_z \begin{bmatrix} -B_{ey} \\ B_{ex} \\ 0 \end{bmatrix}$$

Thus,

$$\begin{aligned} T_{\bar{x}} &= -M_z \int_v B_{ey} dv + M_z \int_v (B_{exz} \bar{y} - B_{eyz} \bar{z}) dv \\ T_{\bar{y}} &= M_z \int_v B_{ex} dv + M_z \int_v (B_{ezz} \bar{z} - B_{ezz} \bar{x}) dv \\ T_{\bar{z}} &= M_z \int_v (B_{eyz} \bar{x} - B_{exz} \bar{y}) dv \end{aligned}$$

Expressing the fluxes and performing the integration, we have the following expressions for the torque components as the function of the magnetic field:

$$\begin{aligned} T_{\bar{x}} &= -\nu M_z \left(B_y + B_{(xx)y} \frac{1}{24} l^2 + B_{(yy)y} \frac{1}{8} R^2 + B_{(yz)z} \frac{1}{8} R^2 \right) \\ T_{\bar{y}} &= \nu M_z \left[B_x + B_{(xz)y} \left(\frac{3}{8} R^2 - \frac{1}{12} l^2 \right) + B_{(xx)x} \frac{1}{24} l^2 + B_{(xy)y} \frac{1}{8} R^2 \right] \\ T_{\bar{z}} &= \nu M_z B_{(xy)y} \left(\frac{1}{12} l^2 - \frac{1}{4} R^2 \right) \end{aligned}$$

The electromagnetic forces are found to be

$$\begin{aligned} F_{\bar{x}} &= M_z \int_v B_{exz} dv = \nu M_z B_{xz} \\ F_{\bar{y}} &= M_z \int_v B_{eyz} dv = \nu M_z B_{yz} \\ F_{\bar{z}} &= M_z \int_v B_{ezz} dv = \nu M_z B_{zz} \end{aligned}$$

Thus, the expressions for the electromagnetic force and torque components are derived. These equations provide one with a clear perspective on how to model, analyze, and control the electromagnetic forces and torques changing the applied magnetic field because the terms

$$B_{ij} = \frac{\partial B_i}{\partial j} \quad \text{and} \quad B_{(ij)k} = \frac{\partial^2 B_i}{\partial j \partial k}$$

can be viewed as the control variables. It must be emphasized that the electromagnetic field (B_{ij} and $B_{(ij)k}$) is controlled by regulating the current in the planar microwindings and designing the microwindings (or other radiating energy microdevices). As was discussed, the derived forces and torques must be used in the torsional-mechanical equations of motion for the microactuator, and, in general, the six-degree-of-freedom microactuator mechanical dynamics results. These mechanical equations of motion are easily integrated with the derived electromagnetic equations, and closed-loop systems can be designed to attain the desired microactuator performance. These equations guide us to the importance of electromagnetic features in the modeling, analysis, and design of microactuators.

Some Other Aspects of Microactuator Design and Optimization

In addition to the electromagnetic-mechanical (electromechanical) analysis and design, other design and optimization problems are involved. As an example, let us focus our attention on the planar windings. The ideal planar microwindings must produce the maximum electromagnetic field, minimizing the footprint area, taking into consideration the material characteristics, operating conditions, applications, power requirements, and many other factors. Many planar winding parameters and characteristics can be optimized, for example, the dc resistance must be minimized to improve the efficiency, increase the flux, decrease the losses, etc. To attain good performance, in general, microwindings have the concentric circular current path and no interconnect resistances. For N -turn winding, the total dc resistance r_t is found to be

$$r_t = \frac{2\pi\rho}{t_w} \sum_{k=1}^N \frac{1}{\ln(r_{Ok}/r_{Ik})}$$

where ρ is the winding material resistivity, t_w is the winding thickness, r_{Ok} and r_{Ik} are the outer and inner radii of the k -turn winding, respectively.

To achieve the lowest resistance, the planar winding radii can be optimized by minimizing the resistance, and the minimum resistance is denoted as $r_{t\min}$. In particular, making use of first- and second-order necessary conditions for minimization, one has

$$\frac{dr_t}{dr_w} = 0 \quad \text{and} \quad \frac{d^2 r_t}{dr_w^2} > 0$$

where r_w is the inner or outer radius of an arbitrary turn of the optimized planar windings from the standpoint of minimizing the resistance.

Then, the minimum value of the microcoil resistance is given by

$$r_{t\min} = \frac{2\pi\rho}{t_w} \frac{N}{(r_{OR}/r_{IR})}$$

where r_{OR} and r_{IR} are the outer and inner radii of the windings (i.e., $r_{O\ N\text{th microcoil}}$ and $r_{I\ 1\text{st microcoil}}$), respectively.

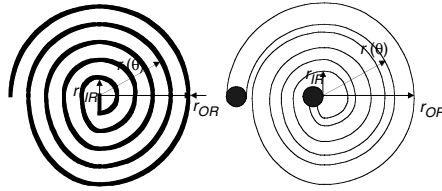

FIGURE 20.138 Planar spiral microwinding.

Thus, using the number of turns and turn-to-turn spacing, the outer and inner radii of the k -turn winding are found as

$$\frac{r_{Ok}}{r_{Ik}} = \left(\frac{r_{OR}}{r_{IR}} \right)^{1/N}$$

For spiral windings, the *averaging (equivalency)* concept should be used because the outer and inner radii are the functions of the planar angle, see Fig. 20.138. Finally, it should be emphasized that the width of the N th microcoil is specified by the rated voltage current density versus maximum current density needed, fabrication technologies used, material characteristics, etc.

Micromachined Polycrystalline Silicon Carbide Micromotors

Articles [19,20] report the silicon-based fabrication of reluctance micromotors. This section is focused on a new enabling technology to fabricate microtransducers. Multilayer fabrication processes at low temperature and micromolding techniques were developed to fabricate SiC microstructures and salient-pole micromotors, which can be used at a very high temperature (400°C and higher) [21,22]. This was done through the SiC surface micromachining. Advantages of the SiC micromachining and SiC technologies (high temperature and ruggedness) should be weighted against fabrication drawbacks because new processes must be designed and optimized. Reactive ion etching is used to pattern SiC thin films; however, many problems, such as masking, low etch rates, and poor etch selectivity, must be addressed and resolved. Articles [21,22] report two single-layer reactive ion etching-based polycrystalline SiC surface micromachining processes using polysilicon or SiO₂ as the sacrificial layer. In addition, the micromolding process, used to fabricate polysilicon molds in conjunction with polycrystalline SiC film deposition and mechanical polishing to pattern polycrystalline SiC films, are introduced. The micromolding process can be used for single- and multilayer SiC surface micromachining.

The micromotor fabrication processes are illustrated in Fig. 20.139. A 5–10 μm thick sacrificial molding polysilicon is deposited through the LPCVD on a 3–5 μm sacrificial thermal oxide. The rotor-stator mold formation can be made on the polished (chemical-mechanical polishing) polysilicon surface, enabling the 2 μm fabrication features using standard lithography and reactive ion etching. After the mold formation and delineation, the SiC is deposited on the wafer using atmospheric pressure chemical vapor deposition reactor. In particular, the phosphorus-doped (n -type) polycrystalline SiC films are deposited on the SiO₂ sacrificial layers at 1050°C with 0.5–1 μm/h rate (deposition is not selective, and SiC will be deposited on the surfaces of the polysilicon molds as well). Mechanical polishing of SiC is needed to expose the polysilicon and planarize the wafer surface (in [21,22], the polishing was done with 3 μm diameter diamond suspension, 360 N normal force, and 15 rad/sec pad rotation—the removal rate of SiC was reported to be 100 nm/min). The wafers are polished until the top surface of the polysilicon mold is exposed (polishing must be stopped at once due to the fast polishing rate). The flange mold is fabricated through the polysilicon and the sacrificial oxide etching (using the KOH and BHF, respectively). The 0.5 μm bearing clearance low-temperature oxide is deposited and annealed at 1000°C. Then, the 1 μm polycrystalline SiC film is deposited and patterned by reactive ion etching to make the bearing.

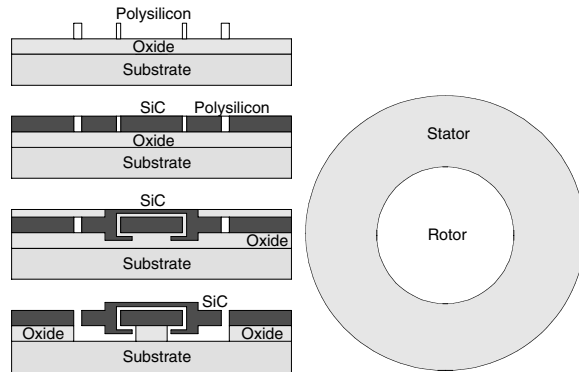

FIGURE 20.139 Fabrication of the SiC micromotors: cross-sectional schematics.

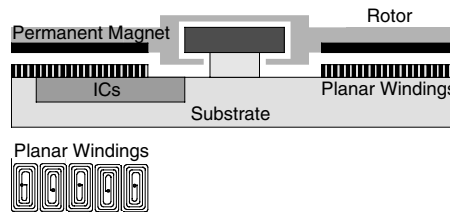

FIGURE 20.140 Slotless axial electromagnetic micromotor (cross-sectional schematics) with controlling ICs.

The release begins with the etching (BHF solution) to strip the left-over bearing clearance oxide. The sacrificial mold is removed by etching (KOH system) the polysilicon. It should be emphasized that the SiC and SiO are not etched during the mold removal step. Then, the moving parts of the micromotor were released. The micromotor is rinsed in water and methanol, and dried with the air jet.

Using this fabrication process, the micromotor with the 100–150 μm rotor diameter, 2 μm airgap, and 21 μm bearing radius, was fabricated and tested in [21, 22]. The rated voltage was 100 V and the maximum angular velocity was 30 rad/s. For silicon and polysilicon micromotors, two of the most critical problems are the bearing and ruggedness. The application of SiC reduces the friction and improves the ruggedness. These contribute to the reliability of the SiC-based fabricated micromachines.

Axial Electromagnetic Micromotors

The major problem is to devise novel microtransducers in order to eliminate fabrication difficulties and guarantee affordability, efficiency, reliability, and controllability of MEMS. In fact, the electrostatic and planar micromotor fabricated and tested to date are found to be inadequate for a wide range of applications due to difficulties associated and the cost. Therefore, this section is devoted to devising novel affordable rotational micromotors.

Figure 20.140 illustrates the devised axial topology micromotor, which has the *closed-ended* electromagnetic system. The stator is made on the substrate with deposited microwindings (printed copper coils can be made using the fabrication processes described as well as using a double-sided substrate with one-sided deposited copper thin films through conventional photolithography processes). The bearing post is fabricated on the stator substrate and the bearing hold is a part of the rotor microstructure. The rotor with permanent-magnet thin films rotates due to the electromagnetic torque developed. It is important to emphasize that the stator and rotor are made using conventional well-developed processes and materials.

It is evident that conventional silicon and SiC technologies can be used. The documented micromotor has a great number of advantages. The most critical benefit is the fabrication simplicity. In fact, axial

micromotors can be straightforwardly fabricated and this will enable their wide applications as microactuators and microsensors. However, the axial micromotors must be designed and optimized to attain good performance. The optimization is based upon electromagnetic, mechanical, and thermal design. The micromotor optimization can be carried out using the steady-state concept (finite element analysis) and dynamic paradigms (lumped-parameters models or complete electromagnetic-mechanical-thermal high-fidelity mathematical models derived as a set of partial differential equations using Maxwell's, *torsional-mechanical*, and heat equations). In general, the nonlinear optimization problems are needed to be addressed, formulated, and solved to guarantee the superior microtransducer performance. In addition to the microtransducer design, one must concentrate the attention on the ICs and controller design. In particular, the circuitry is designed based upon the converter and inverter topologies (e.g., hard- and soft-switching, one-, two-, or four-quadrant, etc.), filters and sensors used, rated voltage and current, etc. From the control perspective, the electromagnetic features must be thoroughly examined. For example, the electromagnetic micromotor studied is the synchronous micromachine. Therefore, to develop the electromagnetic torque, the voltages applied to the stator windings must be supplied as the functions of the rotor angular displacement. Therefore, the Hall-effect sensors must be used, or the so-called sensorless controllers (the rotor position is observed or estimated using the directly measured variables) must be designed and implemented using ICs. This brief discussion illustrates a wide spectrum of fundamental problems involved in the design of integrated microtransducers with controlling and signal processing ICs.

Conclusions

The critical focus themes in MEMS development and implementation are rapid synthesis, design, and prototyping through synergetic multi-disciplinary system-level research in electromechanics. In particular, MEMS devising, modeling, simulation, analysis, design and optimization, which is relevant to cognitive study, classification, and synthesis must be performed. As microtransducers and MEMS are devised, the fabrication techniques and processes are developed and carried out. Devising microtransducers is the closed evolutionary process to study possible system-level evolutions based upon synergetic integration of microscale structures and devices in the unified functional core. The ability to devise and optimize microtransducers to a large extent depends on the validity and integrity of mathematical models. Therefore, mathematical models for different microtransducers were derived and analyzed. It is documented that microtransducer modeling, analysis, simulation, and design must be based on reliable mathematical models which integrate nonlinear electromagnetic features. It is important to emphasize that the secondary phenomena and effects, usually neglected in conventional miniscale electromechanical motion devices (modeled using lumped-parameter models and analyzed using finite element analysis techniques) cannot be ignored. The fabrication processes were described to make high-performance microtransducers.

References

1. Campbell, S. A., *The Science and Engineering of Microelectronic Fabrication*, Oxford University Press, New York, 2001.
2. Lyshevski, S. E., *Nano- and Micro-Electromechanical Systems: Fundamental of Micro- and Nano-Engineering*, CRC Press, Boca Raton, FL, 2000.
3. Lyshevski, S. E., *MEMS and NEMS: Systems, Devices, and Structures*, CRC Press, Boca Raton, FL, 2001.
4. Madou, M., *Fundamentals of Microfabrication*, CRC Press, Boca Raton, FL, 1997.
5. Kim, Y.-J. and Allen, M. G., "Surface micromachined solenoid inductors for high frequency applications," *IEEE Trans. Components, Packaging, and Manufacturing Technology*, part C, vol. 21, no. 1, pp. 26–33, 1998.
6. Park, J. Y. and Allen, M. G., "Integrated electroplated micromachined magnetic devices using low temperature fabrication processes," *IEEE Trans. Electronics Packaging Manufacturing*, vol. 23, no. 1, pp. 48–55, 2000.

7. Sadler, D. J., Liakopoulos, T. M., and Ahn, C. H., "A universal electromagnetic microactuator using magnetic interconnection concepts," *Journal Microelectromechanical Systems*, vol. 9, no. 4, pp. 460–468, 2000.
8. Lyshevski, S. E., *Electromechanical Systems, Electric Machines, and Applied Mechatronics*, CRC Press, Boca Raton, FL, 1999.
9. Frazier, A. B. and Allen, M. G., "Uses of electroplated aluminum for the development of microstructures and micromachining processes," *Journal Microelectromechanical Systems*, vol. 6, no. 2, pp. 91–98, 1997.
10. Guckel, H., Christenson, T. R., Skrobis, K. J., Klein, J., and Karnowsky, M., "Design and testing of planar magnetic micromotors fabricated by deep x-ray lithography and electroplating," *Technical Digest of International Conference on Solid-State Sensors and Actuators, Transducers 93*, Yokohama, Japan, pp. 60–64, 1993.
11. Taylor, W. P., Schneider, M., Baltes, H., and Allen, M. G., "Electroplated soft magnetic materials for microsensors and microactuators," *Proc. Conf. Solid-State Sensors and Actuators, Transducers 97*, Chicago, IL, pp. 1445–1448, 1997.
12. Lagorce, L. K., Brand, O., and Allen, M. G., "Magnetic microactuators based on polymer magnets," *Journal Microelectromechanical Systems*, vol. 8, no. 1, pp. 2–9, 1999.
13. Smith, D. O., "Static and dynamic behavior in thin permalloy films," *Journal of Applied Physics*, vol. 29, no. 2, pp. 264–273, 1958.
14. Suss, D., Schreft, T., and Fidler, J., "Micromagnetics simulation of high energy density permanent magnets," *IEEE Trans. Magnetics*, vol. 36, no. 5, pp. 3282–3284, 2000.
15. Judy, J. W. and Muller, R. S., "Magnetically actuated, addressable microstructures," *Journal Microelectromechanical Systems*, vol. 6, no. 3, pp. 249–256, 1997.
16. Yi, Y. W. and Liu, C., "Magnetic actuation of hinged microstructures," *Journal Microelectromechanical Systems*, vol. 8, no. 1, pp. 10–17, 1999.
17. Gere, J. M. and Timoshenko, S. P., *Mechanics of Materials*, PWS Press, 1997.
18. Groom, N. J. and Britcher, C. P., "A description of a laboratory model magnetic suspension test fixture with large angular capability," *Proc. Conf. Control Applications, NASA Technical Paper – 1997*, vol. 1, pp. 454–459, 1992.
19. Ahn, C. H., Kim, Y. J., and Allen, M. G., "A planar variable reluctance magnetic micromotor with fully integrated stator and coils," *Journal Microelectromechanical Systems*, vol. 2, no. 4, pp. 165–173, 1993.
20. O'Sullivan, E. J., Cooper, E. I., Romankiw, L. T., Kwietniak, K. T., Trouilloud, P. L., Horkans, J., Jahnes, C. V., Babich, I. V., Krongelb, S., Hegde, S. G., Tornello, J. A., LaBianca, N. C., Cotte, J. M., and Chainer, T. J., "Integrated, variable-reluctance magnetic minimotor," *IBM Journal Research and Development*, vol. 42, no. 5, 1998.
21. Yasseen, A. A., Wu, C. H., Zorman, C. A., and Mehregany, M., "Fabrication and testing of surface micromachined polycrystalline SiC micromotors," *IEEE Trans. Electron Device Letters*, vol. 21, no. 4, pp. 164–166, 2000.
22. Yasseen, A. A., Zorman, C. A., and Mehregany, M., "Surface micromachining of polycrystalline silicon carbide films microfabricated molds of SiO and polysilicon," *Journal Microelectromechanical Systems*, vol. 8, no. 1, pp. 237–242, 1999.

IV

Systems and Controls

- 21 The Role of Controls in Mechatronics** *Job van Amerongen*
Introduction • Key Elements of Controlled Mechatronic Systems • Integrated Modeling, Design and Control Implementation • Modern Examples of Mechatronic Systems in Action • Special Requirements of Mechatronics that Differentiate from “Classic” Systems and Control Design
- 22 The Role of Modeling in Mechatronics Design** *Jeffrey A. Jalkio*
Modeling as Part of the Design Process • The Goals of Modeling • Modeling of Systems and Signals
- 23 Signals and Systems** *Momoh-Jimoh Eyiomika Salami, Rolf Johansson, Kam Leang, Qingze Zou, Santosh Devasia, and C. Nelson Dorny*
Continuous and Discrete-Time Signals • z Transform and Digital Systems • Continuous- and Discrete-Time State-Space Models • Transfer Functions and Laplace Transforms
- 24 State Space Analysis and System Properties** *Mario E. Salgado and Juan I. Yuz*
Models: Fundamental Concepts • State Variables: Basic Concepts • State Space Description for Continuous-Time Systems • State Space Description for Discrete-Time and Sampled Data Systems • State Space Models for Interconnected Systems • System Properties • State Observers • State Feedback • Observed State Feedback
- 25 Response of Dynamic Systems** *Raymond de Callafon*
System and Signal Analysis • Dynamic Response • Performance Indicators for Dynamic Systems
- 26 The Root Locus Method** *Hitay Özbay*
Introduction • Desired Pole Locations • Root Locus Construction • Complementary Root Locus • Root Locus for Systems with Time Delays • Notes and References
- 27 Frequency Response Methods** *Jyh-Jong Sheen*
Introduction • Bode Plots • Polar Plots • Log-Magnitude Versus Phase plots • Experimental Determination of Transfer Functions • The Nyquist Stability Criterion • Relative Stability
- 28 Kalman Filters as Dynamic System State Observers** *Timothy P. Crain II*
The Discrete-Time Linear Kalman Filter • Other Kalman Filter Formulations • Formulation Summary and Review • Implementation Considerations

- 29 Digital Signal Processing for Mechatronic Applications** *Bonnie S. Heck and Thomas R. Kurfess*
 Introduction • Signal Processing Fundamentals • Continuous-Time to Discrete-Time Mappings • Digital Filter Design • Digital Control Design
- 30 Control System Design Via H^2 Optimization** *Armando A. Rodriguez*
 Introduction • General Control System Design Framework • H^2 Output Feedback Problem • H^2 State Feedback Problem • H^2 Output Injection Problem • Summary
- 31 Adaptive and Nonlinear Control Design** *Maruthi R. Akella*
 Introduction • Lyapunov Theory for Time-Invariant Systems • Lyapunov Theory for Time-Varying Systems • Adaptive Control Theory • Nonlinear Adaptive Control Systems • Spacecraft Adaptive Attitude Regulation Example • Output Feedback Adaptive Control • Adaptive Observers and Output Feedback Control • Concluding Remarks
- 32 Neural Networks and Fuzzy Systems** *Bogdan M. Wilamowski*
 Neural Networks and Fuzzy Systems • Neuron Cell • Feedforward Neural Networks • Learning Algorithms for Neural Networks • Special Feedforward Networks • Recurrent Neural Networks • Fuzzy Systems • Genetic Algorithms
- 33 Advanced Control of an Electrohydraulic Axis** *Florin Ionescu, Crina Vlad, and Dragos Arotaritei*
 Introduction • Generalities Concerning Robi_3, A Cartesian Robot With Three Electrohydraulic Axes • Mathematical Model and Simulation of Electrohydraulic Axes • Conventional Controllers Used in Order to Control the Electrohydraulic Axis • Control of Electrohydraulic Axis with Fuzzy Controllers • Neural Techniques Used to Control the Electrohydraulic Axis • Neuro-Fuzzy Techniques Used to Control the Electrohydraulic Axis • Software Consideration • Conclusions
- 34 Design Optimization of Mechatronic Systems** *Tomas Brezina, Ctirad Kratochvil, and Cestmir Ondrusek*
 Introduction • Optimization Methods • Optimum Design of Induction Motor (IM) • The Use of a Neuron Network for the Identification of the Parameters of a Mechanical Dynamic System

21

The Role of Controls in Mechatronics

- 21.1 Introduction
- 21.2 Key Elements of Controlled Mechatronic Systems
- 21.3 Integrated Modeling, Design and Control Implementation
Modeling • Control System Design Methodologies
• Servo System Design • Design of a Mobile Robot
- 21.4 Modern Examples of Mechatronic Systems in Action
Rudder Roll Stabilization of Ships • Compensation of Nonlinear Effects in a Linear Motor
- 21.5 Special Requirements of Mechatronics that Differentiate from “Classic” Systems and Control Design

Job van Amerongen
University of Twente

21.1 Introduction

“Mechatronic design deals with the integrated and optimal design of a mechanical system and its embedded control system.” This definition implies that the mechanical system is enhanced with electronic components in order to achieve a better performance, a more flexible system, or just reduce the cost of the system. In many cases the electronics are present in the form of a computer-based embedded (control) system. This does not imply that every controlled mechanical system is a mechatronic system because in many cases the control is just an add-on to the mechanical system in a sequential design procedure. A real mechatronics approach requires that an optimal choice be made with respect to the realization of the design specifications in the different domains. In control engineering the design of an optimal control system is well understood and for linear systems standard methods exist. The optimization problem is formulated as: given a process to be controlled, and given a performance index (cost function), find optimal controller parameters such that the cost function is minimized. With a state feedback controller and a quadratic cost function, solutions for the optimal controller gains can be found with standard controller design software, such as Matlab¹ (Fig. 21.1).

Mechatronic design on the contrary requires that not only the controller be optimized. It requires optimization of the system as a whole. In the ideal case all the components in the system: the process itself, the controller, as well as the sensors and actuators, should be optimized simultaneously (Fig. 21.2).

In general this is not feasible. The problem is ill defined and has to be split into smaller problems that can be optimized separately. Later on the partial solutions have to be combined and the performance of the complete system has to be evaluated. After eventually readjusting some parts of the system this leads to a sub-optimal solution.

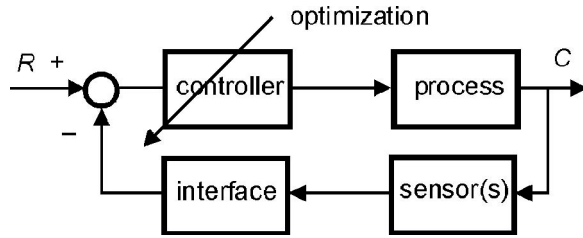

FIGURE 21.1 Optimization of the controller.

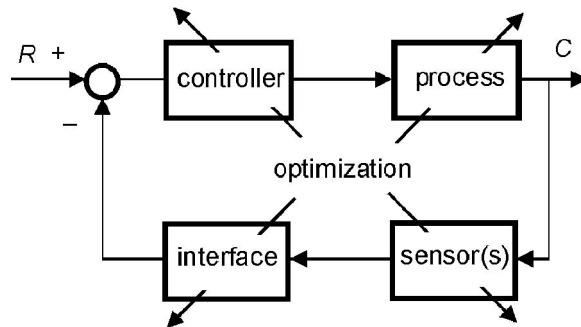

FIGURE 21.2 Optimization of the all system components simultaneously.

In the initial conceptual design phase it has to be decided which problems should be solved mechanically and which problems electronically. In this stage decisions about the dominant mechanical properties have to be made, yielding a simple model that can be used for controller design. Also a rough idea about the necessary sensors, actuators, and interfaces has to be available in this stage. When the different partial designs are worked out in some detail, information about these designs can be used for evaluation of the complete system and be exchanged for a more realistic and detailed design of the different parts.

Although the word mechatronics is new, mechatronic products have been available for some time. In fact, all electronically controlled mechanical systems are based on the idea of improving the product by adding features realized in another domain. Good mechatronic designs are based on a *real systems approach*. But mostly, control engineers are confronted with a design in which major parameters are already fixed, often based on static or economic considerations. This prohibits optimization of the system as a whole, even when optimal control is applied.

In the last days of gramophones, the more sophisticated designs used tacho feedback in combination with a light turntable to achieve a constant number of revolutions. But a really new design was the compact disc player. Instead of keeping the number of revolutions of the disc constant, it aims for a constant speed of the head along the tracks of the disc. This means that the disc rotates slower when tracks with a greater diameter are read. The bits read from the CD are buffered electronically in a buffer that sends its information to the DA converter, controlled by a quartz crystal. This enables the realization of a very constant bit rate and eliminates all audible speed fluctuations. Such a performance could never be obtained from a pure mechanical device only, even if it were equipped with a good speed control system. In fact, the control loop for the disc speed does not need to have very strict specifications. It should only prevent overflow or underflow of the buffer. The high accuracy is obtained in an open loop mode, steered by a quartz crystal (Fig. 21.3).

The flexibility introduced by the combination of precision mechanics and electronic control has allowed the development of CD-ROM players, running at speeds more than 50 times faster than the original audio CDs. A new way of thinking was necessary to come to such a new solution. On the other hand, the CD player is still a sophisticated piece of precision mechanics. No solid-state electronic memory

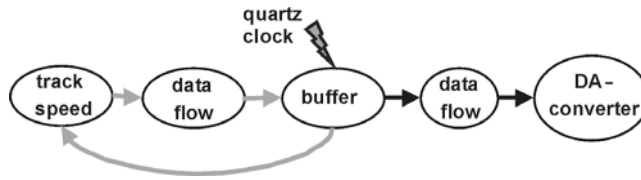

FIGURE 21.3 Combination of closed-loop and open-loop control in a CD player.

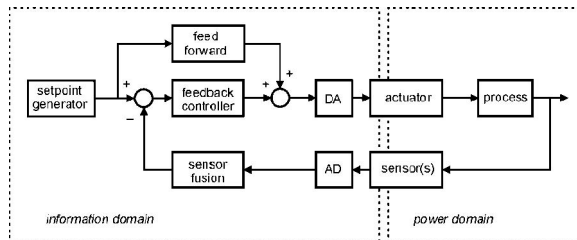

FIGURE 21.4 Mechatronic system.

device can compete yet economically with the opto-mechanical storage capabilities of the CD and its successor the DVD. But this may change rapidly.

21.2 Key Elements of Controlled Mechatronic Systems

A mechatronic system consists by definition of a mechanical part that has to perform certain motions and an electronic part (in many cases an embedded computer system) that adds intelligence to the system. In the mechanical part of the system power plays a major role. This in contrast to the electronic part of the system where information processing is the main issue. Sensors convert the mechanical motions into electrical signals where only the information content is important or even into pure information in the form of numbers (if necessary, through an AD converter). Power amplifiers convert signals into modulated power. In most cases the power supply is electrical, but other sources such as hydraulic and pneumatic power supplies are possible as well. A controlled mechanical motion system thus typically consists of a mechanical construction, one or more actuators to generate the desired motions, and a controller that steers the actuators based on feed-forward and sensor-based feedback control (Fig. 21.4).

21.3 Integrated Modeling, Design and Control Implementation

Modeling

During the design of mechatronic systems it is important that changes in the construction and the controller be evaluated simultaneously. Although a proper controller enables building a cheaper construction, a badly designed mechanical system will never be able to give a good performance by adding a sophisticated controller. Therefore, it is important that during an early stage of the design a proper choice can be made with respect to the mechanical properties needed to achieve a good performance of the controlled system. On the other hand, knowledge about the abilities of the controller to compensate for mechanic imperfections may enable that a cheaper mechanical construction be built. This requires that in an early stage of the design a simple model is available that reveals the performance limiting factors of the system. Still there is a gap between modeling and simulation software used for evaluation of mechanical constructions and software used for controller design. Mechanical engineers are used to

finite element packages to examine the dynamic properties of mechanical constructions. It is only after reduction to low-order models (modal analysis) that these models can be used for controller design. On the other hand, typical control-engineering software does not directly support the mechatronic design process either; in the modeling process the commonly used transfer functions and state space descriptions often have lost the relation with the physical parameters of the mechanical construction. Tools are required that allow modeling of mechanical systems in a way that the dominant physical parameters (like mass and dominant stiffness) are preserved in the model and simultaneously provide an interface to the controller design and simulation tools control engineers are used to (Coelingh;² Coelingh, De Vries, and Van Amerongen³).

Simulation is an important tool to evaluate the design of mechatronic systems. Most simulation programs like Simulink¹ use block diagram representations and do not support physical modeling in a way that direct tuning of the physical parameters of the mechanical construction and those of the controller is possible as required in the design of mechatronic systems. Recently, programs that allow physical modeling in *various physical domains* became available. They use an object-oriented approach that allows hierarchical modeling and reuse of models. The order of computation is only fixed after combining the subsystems. Examples of these programs are 20-sim,⁴ described by Broenink⁵ as CAMAS and Dymola.⁶

In this section the modeling and simulation program 20-sim (pronounced Twente Sim) will be used to illustrate the simultaneous design of construction and controller in a mechatronic system. 20-sim supports object-oriented modeling. Power and signal ports to and from the outside world determine each object (Weustink, De Vries, and Breedveld⁷). Inside the object there can be other objects or, on the lowest level, equations. Various *realizations* of an object can contain different or more detailed descriptions as long as the interface (number and type of ports) is identical. Modeling can start by a simple interconnection of (empty) submodels. Later they can be filled with realistic descriptions with various degrees of complexity. De Vries⁸ refers to this as *polymorphic* modeling. Submodels can be constructed from other submodels in hierarchical structures. Proper physical modeling is achieved by coupling the submodels by means of the *flow of energy*, rather than by *signals* such as voltage, current, force, and speed. This way of modeling is well suited for mechatronics system design. It will be illustrated with an example. We want to consider the design of a simple servo system, considering the use of a voltage source, a DC motor, and a mechanical load driven through a transmission (Fig. 21.5).

The transmission is disregarded for the time being. The belt is considered as infinitely stiff and the transformation ratio is taken care of by changing the motor constant. If a power amplifier driven by a signal generator describes the voltage source, we can draw the iconic diagram of Fig. 21.6. At this stage the different *components* in this model are still empty. But all components have electrical and/or mechanical “ports.” With the proper interfaces (ports) defined, the components can be connected to each other.

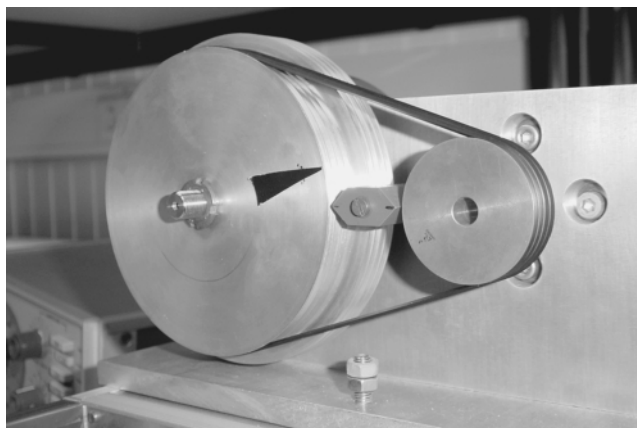

FIGURE 21.5 Simple DC-servo system.

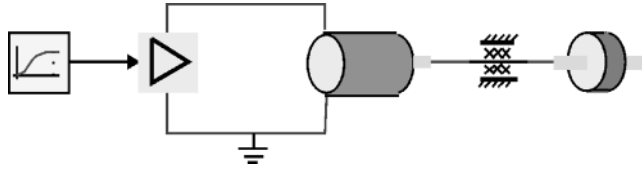

FIGURE 21.6 Iconic diagram of the simple servo system.

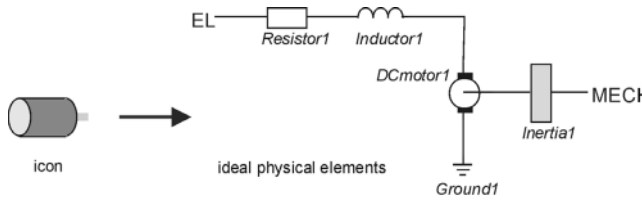

FIGURE 21.7 Icon of the motor expanded to ideal physical elements.

In the next step we can detail the description of the DC motor. One solution could be the description given in Fig. 21.7. The motor is now described by a number of *ideal physical elements*, each representing a basic physical relation. The motor has an electrical (EL) as well as a mechanical port (MECH).

Each of the *elements* in this figure can be described as an element with an electrical and/or mechanical port. The idea of ports is made more explicit in so-called bond graphs.^{9–12} For the electrical elements these are the voltage difference over the element and the current through the element. For the mechanical elements these are the torque and the (angular) velocity. The products of these conjugated variables ($P = ui$ or $P = T\omega$) represent power.

If we go down a step further into the hierarchy, we arrive at the level of equations. For instance, an electrical resistor can be described by the equation:

$$p \cdot u = R * p \cdot i \quad (21.1)$$

where the variables $p \cdot u$ and $p \cdot i$ indicate the conjugated variables u and i of the electrical port p . Note that this is an equation and not an assignment statement. It could have been written equally well in the form:

$$p \cdot i = 1/R * p \cdot u \quad (21.2)$$

In a similar way the inductance can be described by the equations:

$$p \cdot u = L * \text{ddt}(p \cdot i) \text{ or } (p \cdot i) = 1/L * \text{int}(p \cdot u) \quad (21.3)$$

where $\text{ddt}(p \cdot i)$ denotes di/dt and $\text{int}(p \cdot u)$ denotes $\int u dt$. In case of an R-element there is no preference for one of the two forms. For the I-element the integral form is preferred in the simulations. 20-sim determines the preferred causal form and derives the equations automatically.

The energy flow or *power* P is the product of *two conjugated signals*, called effort (e) and flow (f):

$$P = ef \quad (21.4)$$

Examples of this expression in the mechanical and electrical domain are

$$P = Fv \quad \text{or} \quad P = T\omega \quad (21.5)$$

$$P = ui \quad (21.6)$$

where F is force, v is velocity, T is torque, ω is angular velocity, u is voltage, and i is current.

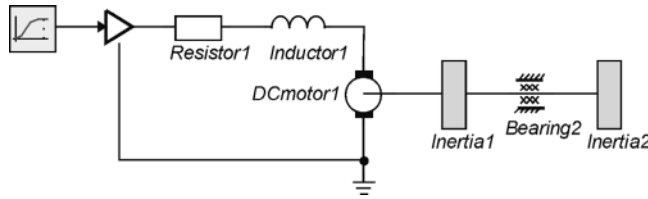

FIGURE 21.8 Complete model in the form of ideal physical elements.

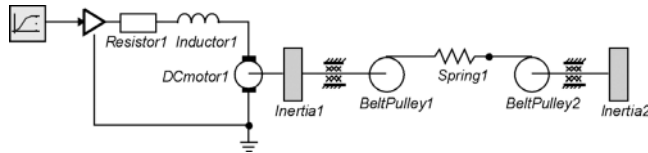

FIGURE 21.9 Model extended with transmission.

When we expand the complete Fig. 21.6 we obtain Fig. 21.8. When this model is processed a message pops up that indicates that inertia 2 has a dependent state. The two inertias in this model always have the same speed, and therefore, they are dependent. They cannot have independent initial conditions. The message indicates that this element can only be written in derivative form:

$$T = J \, d\omega/dt \tag{21.7}$$

There are several ways to deal with this problem.

1. The two inertias can be combined into one inertia (the program will do this automatically). A message pops up that the dependency of the two inertias has been solved symbolically.
2. Dealing with the derivative causality by means of an implicit integration algorithm.
3. The transmission can be added, including some flexibility in the belt.

If the flexibility is negligible, solution 1 leads to the simplest model. On the other hand, the warning raises the question whether the flexibility of the belt can be disregarded indeed. If not, the model has to be extended with a spring element. It should be noted that this should not be done for numerical reasons only. If the transmission were very stiff, this would result in high-frequency dynamics and lead to unnecessary slow simulations. On the other hand, if the flexibility is important, as it is in this system, the warning draws the designer's attention to the fact that the model may be oversimplified. In Fig. 21.9 the transmission, including a spring element, has been added. Processing of this model does not produce any warnings.

This example illustrates how modern software can help to come up with a model that has the complexity that is needed for a particular problem. Physical models, in the form of an iconic diagram, based on connecting elements by means of power ports, may help in this modeling process. The user can select the preferred view, whether this is a bond graph, an iconic diagram with ideal physical element, or a view using higher level submodels, like in Fig. 21.6. In the next section it will be shown how to use this model for the design of controllers.

Control System Design Methodologies

Many processes can be reasonably well controlled by means of PID controllers. This is due to the fact that these processes can be more or less accurately described by means of a second-order model. Tuning rules, like those of Ziegler Nichols, enable less experienced people to tune such controllers. Relatively simple

models can also describe many mechatronic systems. A mechatronic system mostly consists of an actuator, some form of transmission, and a load. A fourth-order model can properly describe such a system. The performance-limiting factor in these systems is the resonance frequency. A combination of position and tacho feedback (basically a PD controller) can be applied here as well. But due to the resonant poles proper selection of the signals to be used in the feedback is essential. Efforts have been made (Groenhuis;¹³ Coelingh;² Coelingh, De Vries, and Van Amerongen³) to derive recipes for tuning such systems, in addition to selecting the proper feedback signals. Computer support tools are essential to enable less experienced designers to use these recipes (Van Amerongen, Coelingh, and De Vries¹⁴). Coelingh² and Coelingh, De Vries, and Van Amerongen³ describe a structural design method for mechatronic systems. The method starts with reducing the conceptual design to a fourth-order model that represents the dominant properties of the system in terms of the total mass to be moved and the dominant stiffness. This model still has physical meaningful parameters. In this model appropriate sensors are chosen, as well as a path generator. In the conceptual design phase a simple controller is developed and mechanical properties are changed, if necessary. Then a more detailed design phase follows where also parameter uncertainties are taken into account.

Servo System Design

Here we will consider some simple aspects of the design of a servo system in order to illustrate the advantage of the use of physical models and to illustrate the need for an integrated design approach. We consider the model discussed before, a load driven by an electric motor, through a flexible transmission. The iconic diagram of this model was given in Fig. 21.9. In this example a current amplifier has replaced the voltage amplifier allowing the removal of the electrical resistor and the inductance. In the step responses of Fig. 21.10 the resonance due to the flexible transmission is clearly visible.

From the equations used for the simulation, 20-sim can automatically derive a model in a form suitable for controller design, such as a state-space description, a transfer function, or poles and zeros. An interface is provided to Matlab¹ enabling, for instance, to use Matlab algorithms to compute the gains of advanced controllers like an LQR (optimal state feedback) or LQG controller (with a Kalman filter for state estimation and optimal state feedback). The diagram of the process together with an LQG controller is given in Fig. 21.11 and some responses in Fig. 21.12.

A properly designed P(I)D controller is able to perform almost similarly, especially when the amount of noise is small. A first attempt could be to use only measurements of the load angle and load speed.

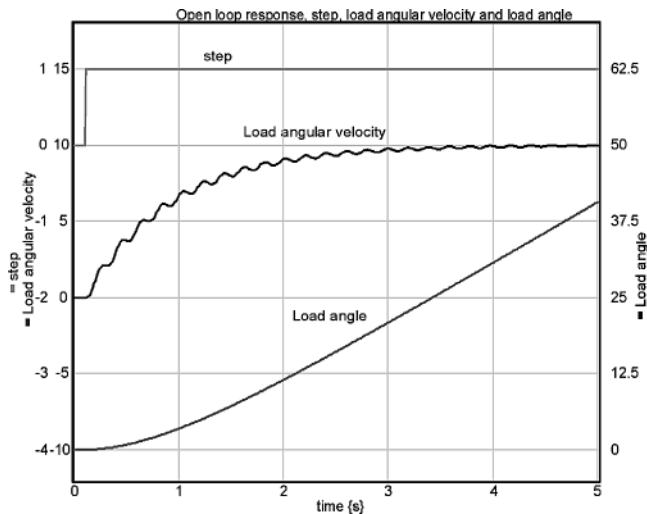

FIGURE 21.10 Open loop responses.

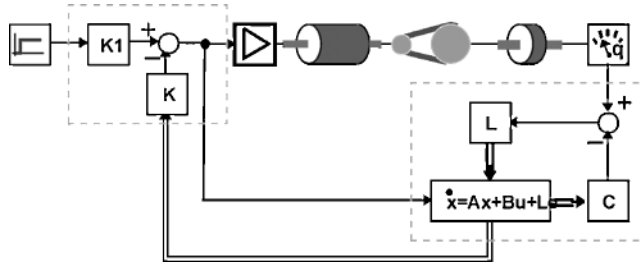

FIGURE 21.11 Process with Kalman filter and state feedback.

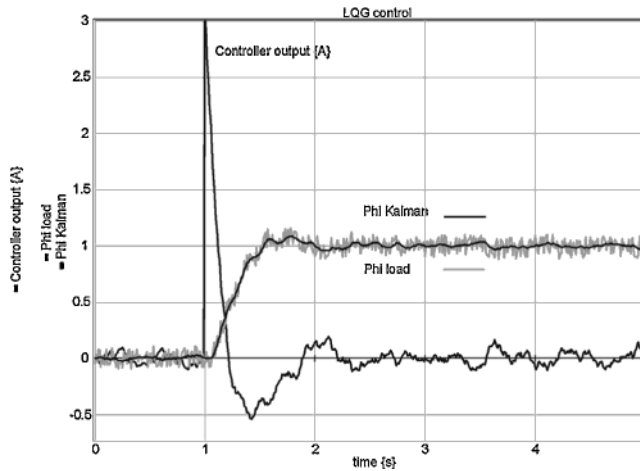

FIGURE 21.12 Response of the LQG-controlled system.

This attempt fails, because feedback of the load speed leads almost immediately to an unstable system as can be seen from the root locus for variations in the gain of the velocity feedback. From the responses of Fig. 21.10, 20-sim can easily determine the transfer function between the motor current and the load speed and plot the root locus (Fig. 21.13).

Figure 21.14 clearly shows that even a small amount of velocity feedback will lead to an unstable system. It is well known that feedback of the motor speed is a better solution. Using again the model of Figs. 21.9 and 21.10 to determine the transfer from input current to motor speed yields the root locus of Fig. 21.15.

Complex zeros now accompany the complex poles and because they are close together their influence on the response will be almost negligible. The branch of the root locus on the real axis now shows the desired behavior: moving the dominant pole to the left in the s -plane. Combining the feedback of the motor speed with feedback of the load angle yields the PD-controller structure of Fig. 21.15 and the responses of Fig. 21.16. Except for the noise there is not much difference in the responses of the system with the Kalman filter, although the PD-controlled system is simpler. The observations made here are generally applicable. A system with two resonant (complex) poles and no zeros, such as in Fig. 21.13, is difficult to control by means of a simple controller. If complex zeros accompany the resonant poles with an imaginary part smaller than that of the poles, stable control is easily achieved. In the frequency domain this is seen as an anti-resonance, followed by a resonance (type AR). On the contrary a type RA system, where the resonance frequency is lower than the anti-resonance frequency (the imaginary part of the poles is smaller than that of the zeros), is just as difficult to control as in the case of only resonant poles. The existence and location of resonant zeros is completely determined by the (geometrical) location of

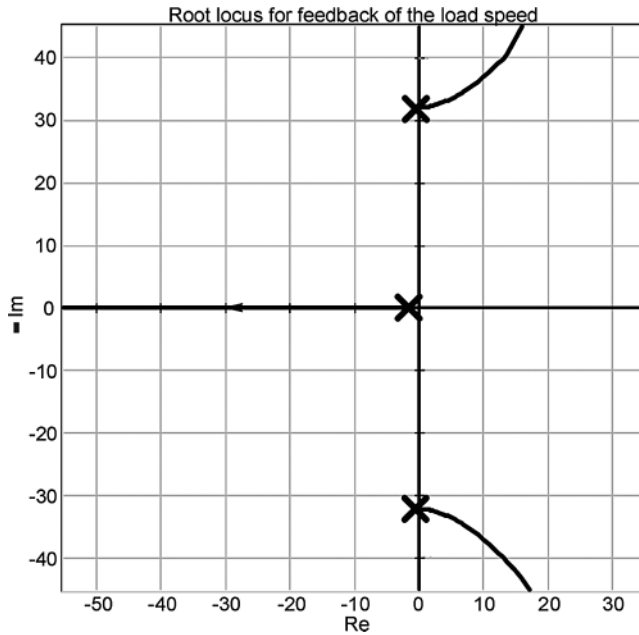

FIGURE 21.13 Root locus for velocity feedback of load axis.

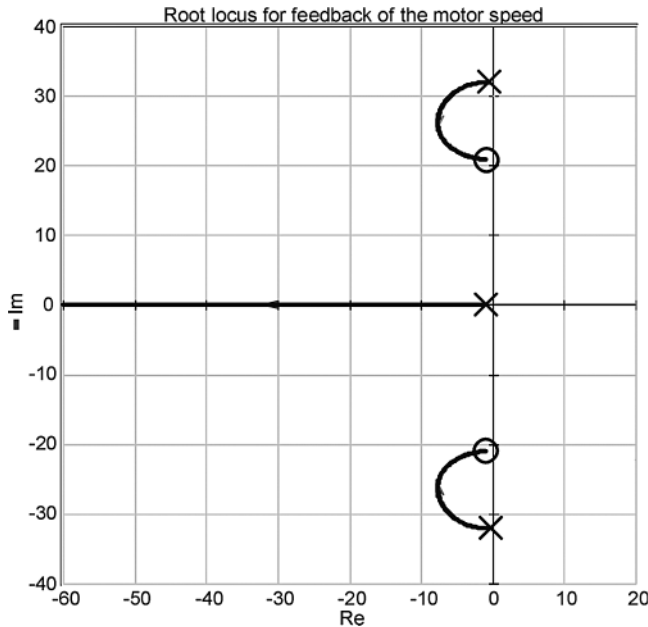

FIGURE 21.14 Root locus for velocity feedback of motor axis.

the sensors in the mechanical system. A careful choice of these sensor locations is therefore crucial for the successful application of a controller. It should be noted that using a properly designed set-point generator could prevent resonance, as seen in Fig. 21.10. The set point generator should not excite the resonance frequencies, for instance, by using a low pass filter with bandwidth lower than the resonance frequencies. However, such a set-point generator does not solve the above-mentioned stability problems.

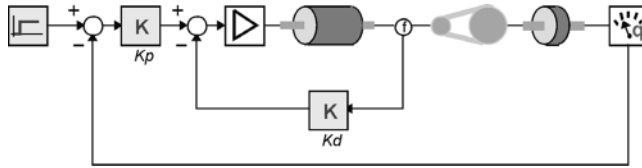

FIGURE 21.15 Servo system with PD-controller.

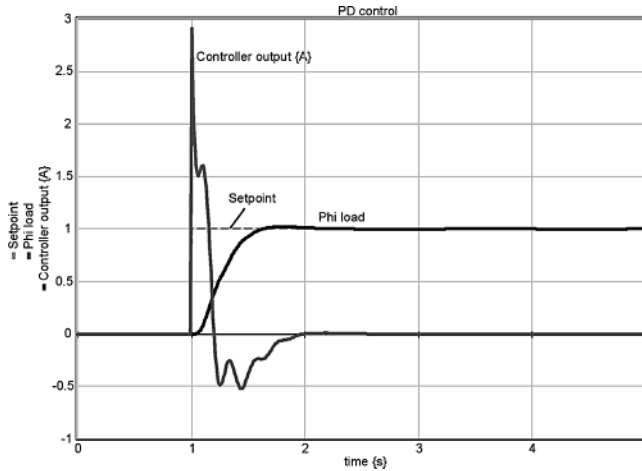

FIGURE 21.16 Responses of the system of Fig. 21.16.

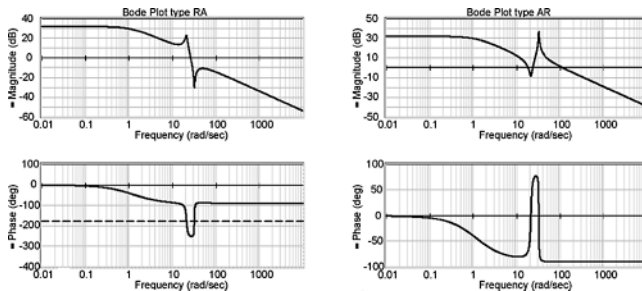

FIGURE 21.17 Bode plots of type RA and AR systems.

Design of a Mobile Robot

A typical example of the early design procedure is the conceptual design of a mobile assembly robot. Already in a very early stage of the design conflicting demands have to be resolved. Such a robot should be able to collect parts all around a production facility and do the assembly while driving. Because a high accuracy is required between the gripper of the robot and the surface where the parts are located, it is important that floor irregularities and vibration modes of the structure do not prevent proper assembly. On the other hand the path controller, partly based on dead reckoning (i.e., measuring of the wheel speed and orientation), requires that the wheels be very stiff. Damping of disturbances has to be realized by another means of suspension. This has led to the concept of an upper frame and a lower frame, connected by means of springs (Fig. 21.18).

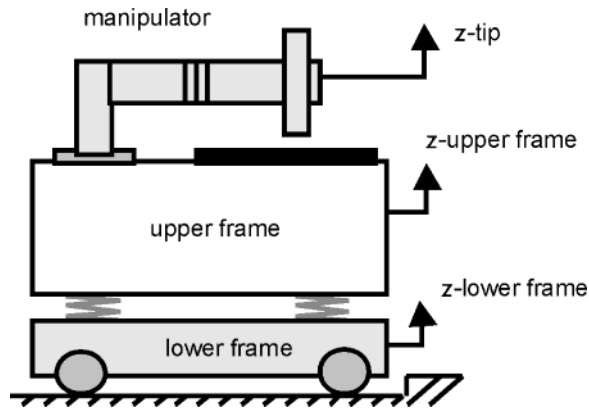

FIGURE 21.18 Conceptual design of the mobile robot.

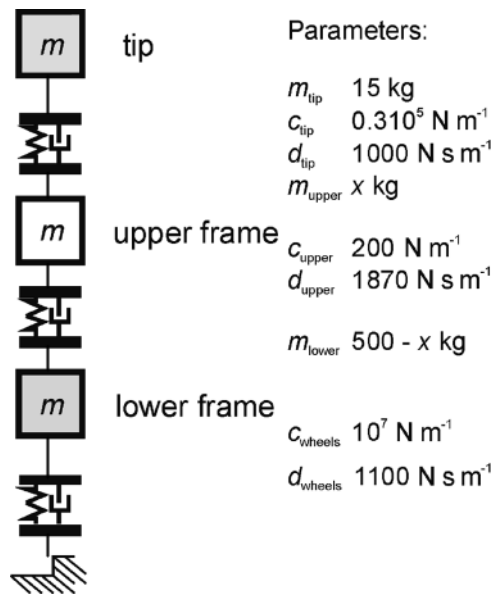

FIGURE 21.19 Simple model with ideal physical elements to compute the error e_{tip} .

The robot can be mounted at the upper frame and should have sufficient bandwidth such that the position error ($e_{tip} = z_{tip} - z_{upper \text{ frame}}$) between the tip of the robot (z_{tip}) and the upper frame ($z_{upper \text{ frame}}$) is small enough.

The next step is to derive a simple model, in order to have some parameters for the weight distribution and the stiffness and damping of the springs. In the model of Fig. 21.22 the robot is confronted with a bump in the floor at a speed of 1 m/s.

Based upon the payload—mainly the weight of the batteries—the total mass of the vehicle was estimated to be 500 kg. Stiffness and damping of the wheels follow from the demands for the accuracy of the position estimation. The mass and bandwidth of the controlled manipulator were already known from other studies, yielding the effective stiffness and damping for the robot tip. When also initial estimates of the stiffness and damping of the springs between the upper and lower frame are made, the only parameter to be varied is the weight distribution between the upper frame and lower frame. By using the optimization feature of 20-sim, the optimal weight distribution can easily be found. In order to minimize the error between the tip of the robot and the upper frame (Fig. 21.19), the weight has to be placed as much as possible in the

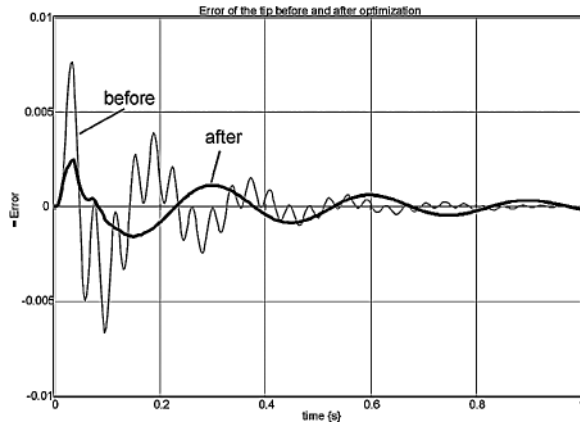

FIGURE 21.20 Error of the tip before and after optimization of the weight distribution between upper and lower frame.

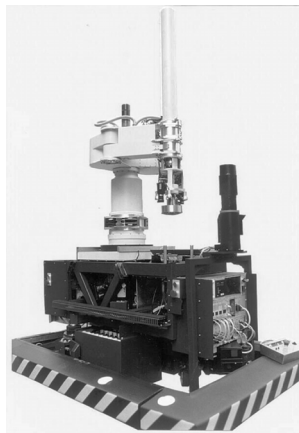

FIGURE 21.21 The mobile robot (MART) after completion.

upper frame (Fig. 21.20). This example illustrates how the mechanical configuration of the system is determined by the requirements for good path control and accurate control of the assembly task.

A next step could be to optimize the properties of the suspension between upper and lower frame. This will further improve the error. This decision made in a very early stage of the design directed other design decisions. After completion of the project it appeared that the different parameters of the final construction were close to these early estimates (Fig. 21.21).

21.4 Modern Examples of Mechatronic Systems in Action

A few examples have already been treated in the previous sections. In this section two more examples will be given.

Rudder Roll Stabilization of Ships

Nowadays most ships use an autopilot to control the heading of the ship. A rudder is the most commonly used actuator. Some ships, like ferries and naval ships, need also roll stabilization. This can be achieved passively by means of two connected tanks filled with water that generate stabilizing forces that should

be in counter phase with the forces of the waves. In order to make the system effective for varying frequencies of the waves, the water flow between the two tanks should be controlled. For fast ships mostly stabilizing fins are used. These are a kind of actively controlled “wings” that generate the moments needed to counteract the moments of the waves. The fins not only influence the roll motions but also have influence on the heading. On the other hand, the rudder not only influences the heading but also induces roll. In control engineering terms this leads to a multivariable system that requires a multivariable controller design for optimum performance. In practice such a multivariable system is seldom seen and two separate control systems are used.

Another approach is to use only one of the actuators (rudder or fins) to achieve course control and roll reduction. Because the frequencies of the roll motions are outside the bandwidth of the course-control system this is possible. The rudder is most suited as actuator. An additional advantage for naval ships is that removing the fins will reduce the underwater noise of the vessel.

Redesigning the course controller in order to stabilize the roll as well, demonstrates the feasibility of this approach, but also makes clear that the “process”—the ship—should be modified. The most important modification is needed for the steering machine. The maximum speed of the steering machine appears to be the limiting factor for such a system (it should increase from the commonly used values of 3–7∞/s to 20–25∞/s). By means of dynamic simulations the demands for the steering machine can be found in terms of the maximum speed of the steering machine and the maximum time constant that is allowed for reaching this speed. This requires reengineering of the hydraulic steering machine. A step further would be to consider also changes in the shape of the ship, in order to optimize the parameters that determine the effectiveness of the rudder roll stabilization system.

In order to decide whether this new solution is better, it should be evaluated whether the redesigned steering machine is less expensive than the original rudder and fin actuators. These design issues have to be solved in a very early stage of the design. Rudder roll stabilization has been successfully applied on naval as well as merchant marine ships (Van Amerongen, Van der Klugt, and Van Nauta Lemke¹⁵).

Compensation of Nonlinear Effects in a Linear Motor

Many mechanical systems suffer from nonlinear effects that limit the accuracy that can be achieved. Friction and cogging are two examples. A (linear) feedback controller can diminish the influence of nonlinearities, but complete compensation may be difficult. For systems that perform repetitive motions, an Iterative Learning Controller can help to further improve the performance (Arimoto;¹⁶ De Vries, Velthuis, and Van Amerongen¹⁷). The basic idea is explained in Fig. 21.22.

When only the feedback loop is present and under the assumption that there are no disturbances, the error signal and thus the controller signal U_C will be the same for each repetitive motion. It is obvious that the accuracy can be improved when in the next motion the controller signal from the former cycle is used as a feed-forward signal, U_F . The feedback will generate a signal that further compensates for the remaining error by updating the feed-forward signal U_F with the formula

$$U_F^{k+1} = U_F^k + LE^k \tag{21.8}$$

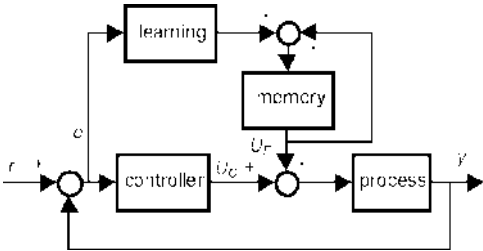

FIGURE 21.22 Principle of Iterative Learning Control.

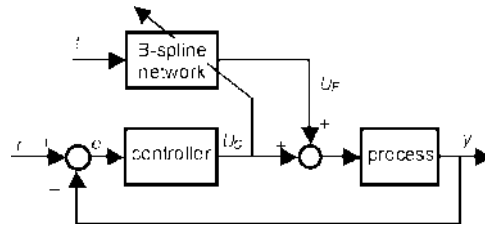

FIGURE 21.23 Learning feed-forward controller for repetitive motions.

where L is the transfer function of the learning filter. The superscript k denotes the k th repetitive motion. The signal U_F should converge to a feed-forward signal that compensates for all repetitive errors. An example of a situation where such errors are present is, for instance, a CD player that has to compensate for the eccentricity of the disk.

A variation on this idea and even more straightforward is the learning feed-forward controller (LFFC) setup of Fig. 21.23. When the feed-forward signal would be perfect, the output of the controller would be zero. This implies that this output can be used as a training signal for a neural network. An adaptive B-spline network enables learning of complex nonlinear characteristics. Also support vector machines have been used to implement the learning feed forward (De Kruif and De Vries¹⁸). The input of the B-spline network is the time t . It is reset each time a new motion starts. This is called a time-indexed LFFC. Instead of the time, also the reference signal and its derivatives—obtained from a path generator—could be used as index for the network (path-indexed LFFC). The advantage of this structure is that after proper training the LFFC can successfully be used for nonrepetitive motions as well. Velthuis¹⁹ has given a stability analysis for time-indexed as well as path-indexed LFFC-controllers. The stability analysis is relatively easy for the time-indexed case. For the path-indexed case it is more complex and some heuristics are required to guarantee a stable system. The main issue is that the number of B-splines should not be too large. On the other hand a sufficiently dense B-spline distribution is desired for an accurate approximation of the nonlinear process. LFFC has successfully been applied to compensate for cogging in an industrial Linear Motor (Otten et al.²⁰) and for compensation of (Coulomb) friction of a linear motor used in a flight simulator (Velthuis¹⁹). It has also been applied to the tracking control of the mobile robot described in the section Design of a Mobile Robot (Starrenburg et al.²¹).

The application to cogging compensation of a linear motor will be described in a little bit more detail. Such a motor is a commonly used element in assembly machines. Even with the best magnets and accurate assembly the error could not be made smaller than $100\ \mu$, with a PID controller in combination with nonlearning feed-forward control. The design goal was to improve the maximally achievable accuracy from $100\ \mu$ to less than $10\ \mu$. Figure 21.24 shows a picture of a linear motor.

According to the structure of Fig. 21.23 the linear motor is controlled by means of a PID controller, while a B-spline neural network is present to learn the inverse motor model, including the nonlinearity due to cogging. Cogging occurs in DC motors with permanent magnets. It causes more or less sinusoidal shaped forces that depend on the position of the translator with respect to the stator. If these forces really had a sinusoidal shape, they would be easy to compensate for by means of a feed-forward compensator. However, this would require magnets with completely similar magnetic properties and very accurate spacing of the magnets. An alternative is to design a controller that learns the disturbance pattern and compensates it by means of a learning feed-forward compensator. An additional advantage is that such a system can also be used to compensate for other nonlinear effects, such as friction. This has also been demonstrated in a part of a flight simulator (a control stick) where friction forces spoil the feeling of a realistic simulation especially at almost zero speed. Figure 21.25 shows that learning is almost completed after six training cycles.

Learning feed-forward control is an attractive method to compensate for nonlinearities that are present in mechatronic systems, such as cogging and friction. The use of B-spline neural networks results in fast convergence, relatively low computational effort, and a good generalizing ability. Because of recently obtained results with respect to the stability of such systems, robust control systems can be designed.

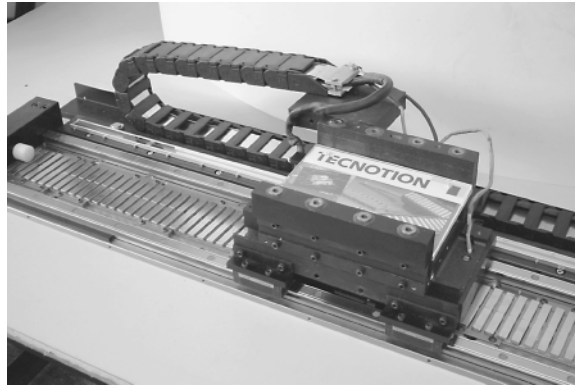

FIGURE 21.24 Linear motor. The magnets that cause the cogging are clearly visible.

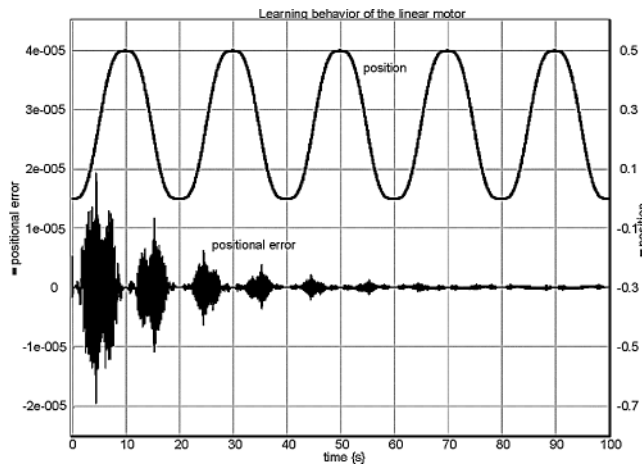

FIGURE 21.25 Position and error signal during learning of the LFFC.

A mechatronic view on this design problem raises the question whether it is possible to use the same techniques to build a less expensive linear motor, when maximum accuracy is not the main goal of the design. It has been demonstrated that a motor constructed with less expensive components and less demanding assembly specifications but with LFFC can compete well with the more expensive construction. The accuracy can typically be improved by a factor 10.

21.5 Special Requirements of Mechatronics that Differentiate from “Classic” Systems and Control Design

The main difference between “ordinary controller design” and mechatronic system design is that the latter deals with the design of the system as a whole. This approach can be considered as optimization of all components of the system simultaneously, although there are no algorithms to do this automatically. In practice the problem is often split into smaller problems that can be optimized. After integration of all the partial solutions a suboptimal system is achieved that can be further optimized by retuning the different parts, taking into account the already available intermediate design of the overall system. In order to achieve optimization of the system as a whole, it is desired that the mechanical part, where power plays a role, and the information processing part (the controller) can be simulated and adjusted simultaneously. This requires that mechanical parameters like masses and compliances be available in simulations of the

controlled system. Examples have been given of modeling and simulation with 20-sim that allows for such an approach.

Mechatronic designers should constantly be aware of the fact that solutions can be found in different domains. Not every mechanical deficiency can easily be solved by control. A good mechanical design may be easier and cheaper to achieve. On the other hand, a good controller may be able to achieve the desired performance much easier and cheaper than a complex mechanical construction. In some cases the combination can even achieve performances that would never have been possible without a mechatronic design.

The same holds for the design of sensors. Each sensor could be fitted with a filter to remove noise from the measurements. But if several sensors are being combined, sensor fusion in a Kalman filter algorithm will benefit from the availability of the raw data.

Communication between all the designers involved and transparency of the design decisions in the various domains are essential for the success of a true mechatronic design.

References

1. Mathworks (2001). *The Mathworks: Developers of Matlab and Simulink*, www.mathworks.com
2. Coelingh, H.J., *Design Support for Motion Control Systems*, Ph.D. thesis, University of Twente, 2000, also www.rt.el.utwente.nl/clh/
3. Coelingh, H.J., de Vries, T.J.A., van Amerongen, J., Design support for motion control systems—application to the Philips fast component mounter, in *Mechatronics Forum 7th Int. Conf., Mechatronics 2000*, Atlanta, Ga, USA.
4. Controllab Products, *20-sim*, www.20sim.com
5. Broenink, J.F., *Computer-Aided Physical-Systems Modeling and Simulation: a Bond-Graph Approach*, Ph.D. thesis, University of Twente, 1990.
6. Dynasim, *Dymola*, www.dynasim.se/
7. Weustink, P.B.T., de Vries, T.J.A., Breedveld, P.C., *Object Oriented Modeling and Simulation of Mechatronic Systems with 20-sim 3.0*, in *Mechatronics 98*, J. Adolfson and J. Karlsén (Eds.), Elsevier Science, 1998.
8. De Vries, T.J.A., *Conceptual Design of Controlled Electro-Mechanical Systems*, Ph.D. thesis, University of Twente, 1994.
9. Breedveld, P.C., Fundamentals of bond graphs, in *IMACS Annals of Computing and Applied Mathematics, Vol. 3: Modelling and Simulation of Systems*, Basel, 1989, pp. 7–14.
10. Cellier, F.E., Elmqvist, H., Otter, M., Modeling from physical principles, in *The Control Handbook*, W.S. Levine (Ed.), CRC Press, pp. 99–108, 1996.
11. Gawthrop, P., Lorcan Smith, L., *Metamodelling: Bond Graphs and Dynamic Systems*, Prentice-Hall, NJ, 1996.
12. Van Amerongen, J., Modelling, simulation and controller design for mechatronic systems with 20-sim 3.0, in *Proc. 1st IFAC Conf. on Mechatronic Systems*, Darmstadt, Germany, September 2000, pp. 831–836.
13. Groenhuis, H., *A Design Tool for Electromechanical Servo Systems*, Ph.D. thesis, University of Twente, 1991.
14. Van Amerongen, J., Coelingh, H.J., de Vries, T.J.A., “Computer support for mechatronic control system design,” *Robotics and Autonomous Systems*, vol. 30, no. 3, pp. 249–260, PII: SO921-8890 (99)00090-1, 2000.
15. Van Amerongen, J., van der Klugt, P.G.M., van Nauta Lemke, H.R., Rudder roll stabilization for ships, *Automatica*, vol. 26, no. 4, pp. 679–690.
16. Arimoto, S., A brief history of iterative learning control, in *Iterative Learning Control: Analysis, Design, Integration and Applications*, Kluwer Academic Publishers, pp. 3–7, 1988.
17. De Vries, T.J.A., Velthuis, W.J.R., van Amerongen, J., Learning feed-forward control: a survey and historical note, in *1st IFAC Conf. on Mechatronic Systems*, Darmstadt, Germany, September 2000, pp. 949–954.

18. De Kruif, Bas J., de Vries, T.J.A., On using a support vector machine in learning feed-forward control, in *Proc. 2001 IEEE/ASME Int. Conf. on Advanced Intelligent Mechatronics*, Como, Italy, 8–12 July, 2001.
19. Velthuis, W.J.R., *Learning Feed-Forward Control—Theory, Design and Applications*, Ph.D. thesis, University of Twente, 2000, also <http://www.rt.el.utwente.nl/vts/>
20. Otten, G., de Vries, T.J.A., van Amerongen, J., Rankers, A.M., Gaal, E., Linear motor motion control using a learning feedforward controller, *IEEE/ASME Transactions on Mechatronics*, vol. 2, no. 3, ISSN 1083-4435, pp. 179–187, 1997.
21. Starrenburg, J.G., van Luenen, W.T.C., Oelen, W., van Amerongen, J., Learning feed-forward controller for a mobile robot vehicle, *Control Engineering Practice*, vol. 4, no. 9, pp. 1221–1230, 1996.

22

The Role of Modeling in Mechatronics Design

- 22.1 Modeling as Part of the Design Process
Phase 1 • Phase 2 • Phase 3 • Phase 4
- 22.2 The Goals of Modeling
Documentation and Communication • Hierarchical
Framework • Insights • Analogies • Identification
of Ignorance
- 22.3 Modeling of Systems and Signals
Analytical vs. Numerical Models • Partial vs. Ordinary
Differential Equations • Stochastic vs. Deterministic
Models • Linear vs. Nonlinear

Jeffrey A. Jalkio
University of St. Thomas

If mechatronics design is more than just the combination of electronic, software, and mechanical design, the additional feature must lie in the ability of the mechatronic designer to optimize a design solution across these disparate fields. This requires a sufficient understanding of each of these fields to determine which portions of an engineering problem are best solved in each of these domains given the current state of technology. In turn, this requires the ability to model the problem and potential solutions using techniques that are domain independent or at least permit easy comparison of solutions and tools from different domains.

For example, the optical inspection system shown in Fig. 22.1 depends on optical components in precise alignment, mechanical elements capable of precise motion, transducers for sensing and providing mechanical power, electrical systems to control motion and filter sensor signals, and software for image analysis and motion control. Only by dividing these tasks appropriately among electronics, mechanical components, and software can the system be optimized. This requires an understanding of all the system requirements and limitations as well as the capabilities of each component in the various domains. Modeling of requirements and systems is crucial in determining whether a proposed solution is acceptable as well as in documenting these determinations for future use. In this article we shall examine the varieties of models used at different points in the design process, the diverse roles of these models and their relative strengths and weaknesses in each of these roles, and finally the specific tradeoffs involved in choosing dynamic models for signals and systems analysis.

22.1 Modeling as Part of the Design Process

Models serve different purposes at different points in the design process; so to decide which modeling tools are most effectively employed in different phases we must examine the design process itself. Many descriptions of the design process are available that have been developed by researchers around the world.¹⁻³ Typically these descriptions serve to systematize the process to improve the productivity of



FIGURE 22.1 An optical inspection system for printed circuit boards. (Used by permission " CyberOptics Corporation 2001, all rights reserved.)

designers or to describe techniques that provide improved product quality, lower cost, or other benefits. However, since our purpose is to examine the modeling needs of the design process, we can consider a simple model that distinguishes phases of the design process in terms of types of design activity rather than a more complex model that may be preferable for other purposes. For this purpose, we can consider a four-phase process consisting of requirements analysis, concept generation, analysis and selection, and detailed design. In the first phase of this process the designer focuses on analysis of the problem without considering possible solutions. In the second phase, conceptual solutions are generated with the hope that an acceptable solution can be found from these initial concepts via combination or modification of concepts or by variation of parameters present in one of the conceptual solutions. In the third phase, these concepts are evaluated and a design is chosen for implementation. The fourth phase consists of identifying design problems that need to be solved to implement the chosen concept and applying the design process to those smaller problems. We shall consider the activities of each of these phases in detail.

Phase 1

The requirements analysis phase consists in obtaining a sufficient understanding of the problem to be solved. The difficulty of this process varies with the scale of the problem, the designers' familiarity with the problem domain, the variability of market needs, and the presence of hidden requirements that are poorly articulated in the initial problem statement. Depending on the nature of the design problem, the requirements identified in this phase may be the needs of a single customer, the common needs of a group of potential customers identified via a market survey, or societal needs identified by government regulations. Most design problems include some combination of these as well as internal requirements such as design guidelines and company policies. The key objective of this phase is to obtain enough detail to know when a design has solved the problem satisfactorily. Models in this phase serve primarily as communication and documentation tools since the primary problem in this phase is the clear communication and documentation of the criteria for design success. Examples of models that aid in this process include specification listings, use case diagrams, sequence diagrams, and context diagrams. Many of these modeling tools have now been standardized as parts of the Unified Modeling Language (UML), which is becoming increasingly important as an analysis tool.⁴

Use case diagrams model the interactions between a system and its users at a very high level of abstraction in terms of purpose of the interaction. [Figure 22.2](#) gives an example of a use case diagram used to document the various operations required of a network printer. The use case diagram helps us avoid overlooking important but rare use cases such as maintenance. It is important to note that use case diagrams do not

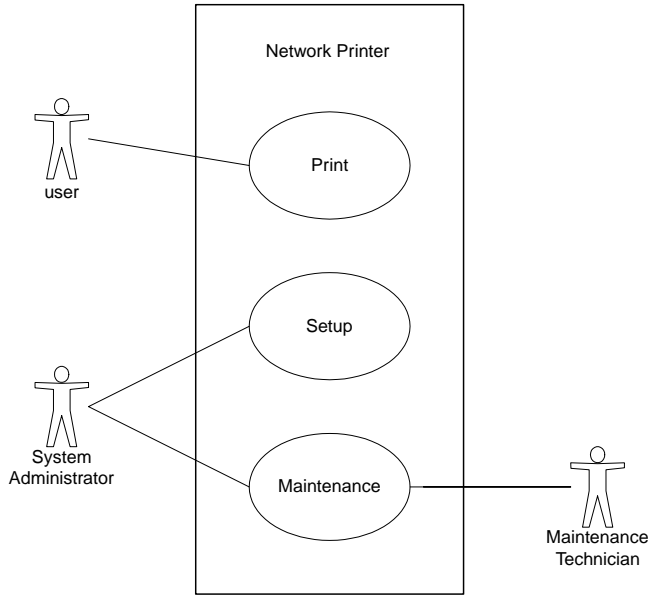

FIGURE 22.2 Use case diagram for a network printer.

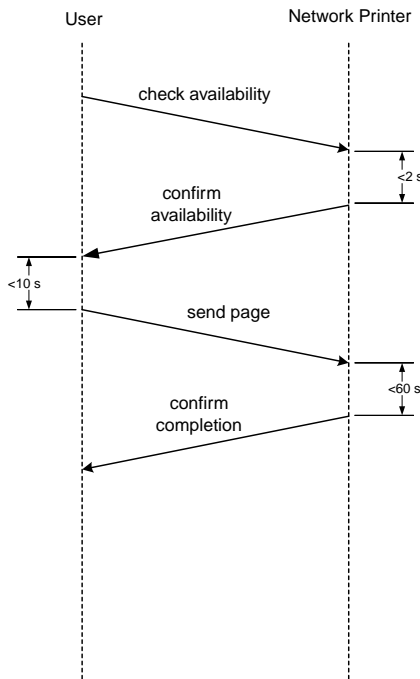

FIGURE 22.3 A sequence diagram for network printer use.

provide information about the nature of the transaction, but rather documents its existence. It serves as a top level model of a system only.

Sequence diagrams can be drawn to describe the details of individual use cases in order to clarify the interactions that must occur, timing constraints, and interactions between the system and multiple elements of the environment. Figure 22.3 shows an example of a sequence diagram for the “print” use case of Fig. 22.2.

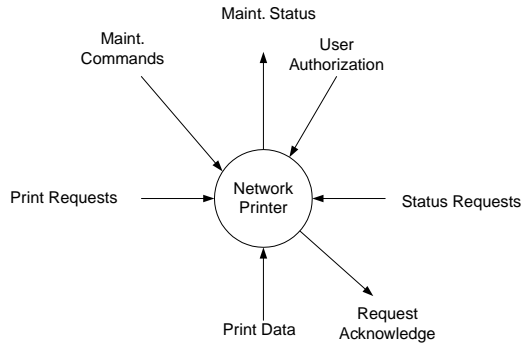

FIGURE 22.4 Context diagram for network printer.

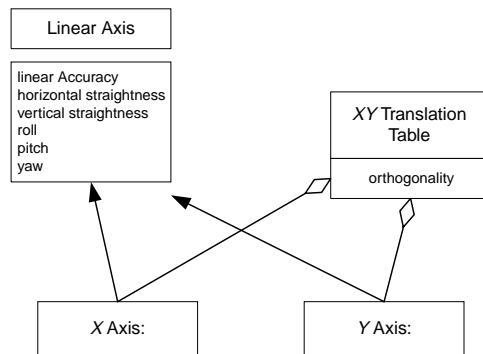

FIGURE 22.5 Class diagram for linear translation stages.

Note that the sequence diagram documents a particular instance of a particular use case. The sequence diagram can show both the direction of information flow and timing requirements. In this regard the sequence diagram and the traditional timing diagram serve similar purposes.

Context diagrams do not capture timing elements but capture the types of information that flow between the system and its environment.⁵ While use case diagrams focus attention on the scenarios of system use, context diagrams focus attention on information flows that must exist to enable those scenarios. Both serve useful and complementary purposes. Figure 22.4 shows a context diagram for an inspection system like the example mentioned above. Notice that the context diagram summarizes information flow shown in the various interaction diagrams for all use cases. Regulatory and safety requirements are often in the form of limits on the interactions the system may have with aspects of its environment. These requirements must all be captured for use in later design phases and communicated back to the source of the requirement for verification of accuracy. The context diagram is also used as the top level of a data flow diagram for a system if structured analysis is used.⁶

Just as the context diagram ties to structured analysis techniques, object oriented analysis techniques provides the class relationship diagram as a means of documenting the relationships between a system and its environment and between components of a system.⁷ Class relationship diagrams show how a system is composed of subsystems, how components are similar to one another, and how they differ. For example, Fig. 22.5 shows a class relationship diagram for a two-axis translation system consisting of two single axis subsystems. This diagram documents the existence of 13 error components that must be specified in the requirements phase. It does this by showing that the X and Y axis components are instances of a class of single axis translation stages, that each have six error components, and that they are components of a

system that adds a single additional error. By documenting relationships such as composition and inheritance, requirements and the interdependence of requirements can be represented in a compact and comprehensible way.

One key aspect of the requirements definition phase is the importance of defining requirements without specifying a preferred solution embodiment. Hence, modeling methods should be chosen to document these requirements and their intrinsic relationships without implying a particular solution.

Phase 2

In the concept generation phase, our objective is to generate multiple design concepts that might satisfy the requirements identified in phase 1. Here we need modeling techniques that allow us to describe possible solutions with varying levels of detail dependent on the degree of detail needed to document the key elements of the concept. Since individual concepts generated in this phase may only satisfy some portions of the design requirements, it is critical that modeling at this point allow for partial descriptions of embodiments and for the easy combination of design concepts. For this reason, our models must clearly document the portions of the requirements satisfied as well as any unspecified parameters or additional requirements introduced in the concept. For some problems, block diagrams showing interconnections between components solving portions of the problem are a useful modeling tool at this stage. Figure 22.6 shows two possible block diagrams describing a given design concept. The first specifies a particular control algorithm, sensor, and actuator, while the second leaves these particulars unspecified and simply describes a closed loop controller. Depending on the situation either of these may be appropriate descriptions. The first provides details and is closer to a complete design while the second, being more generic, is easier to combine with other concepts to generate hybrid solutions.

Block diagrams are not the only modeling tool appropriate at this stage. For other problems, schematics showing arrangements of components or equations or pseudocode of proposed algorithms may be employed. As this phase continues, design concepts are often combined to form potential solutions to the overall design problem; therefore, it is useful if the model of each concept can contain descriptions of preconditions for its use, results, and other parameters that help a design team determine how to combine concepts. Similarly, once potential solutions are formed by concatenating concepts, it is often useful to clean up the final concept by combining features from different component concepts or eliminating overlapping features that are no longer needed.⁸ This process is facilitated by modeling techniques that allow simultaneous modeling of mechanical, thermal, electrical, and software components and concepts. These techniques include the familiar linear graph and bond graph models.^{9,10}

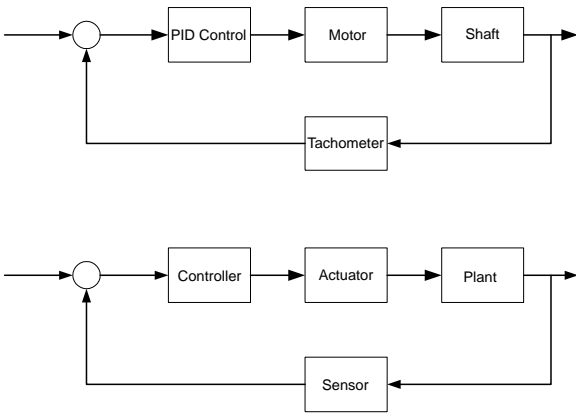

FIGURE 22.6 Block diagrams at two levels of detail.

Phase 3

In the third phase we evaluate potential solutions in terms of the problem requirements. This phase is eased if we have a model that allows us to compare problem requirements with design features. A particular design methodology may include various quality criteria in addition to those set by customer requirements and the regulatory environment, e.g., the design axioms of Suh prefer designs with minimum information content and which satisfy each requirement by independent features of the design.¹¹

One approach to evaluation is to attempt to find numerical criteria for all requirements and evaluate solutions via minimization of an overall cost function (or equivalently, the maximization of an overall value function). This approach has proven effective in certain types of problems where requirements are amenable to quantification (for example, the optimal solution being the one that meets requirements with minimal weight or economic cost). Even in these cases, it can be difficult to determine the relative importance of diverse requirements in the formulation of the value function. For example, it may be desirable for a design to have minimal parts cost and minimal weight. An appropriate cost function might be

$$\Psi = \sqrt[n]{\left(\frac{c}{c_0}\right)^p + \left(\frac{w}{w_0}\right)^q}$$

where c and w are the cost and weight, respectively, and c_0 and w_0 are scaling factors indicating when the two factors are of equal importance, while the exponents p , q , and n express the relative importance of minimizing the two factors. Clearly, there are many possible choices for these parameters and many other models that can be used. This highlights the difficulties of this method. An example of this difficulty in a relatively simple case is determining the cost of a component being out of tolerance. Models for this problem range from a step function of cost = 0 within tolerance and cost = C outside tolerance to Taguchi's quadratic cost function.¹² Needless to say, the "optimal" solution found is typically dependent on the cost function chosen. On the other hand, in some cases, the optimum found is not strongly dependent on precise choice of cost function and a satisfactory evaluation can be made without expending excessive effort to obtain an exact cost function. In fact, if there are relatively few design options from which to choose, it is possible to invert this problem. Rather than finding the design that minimizes a particular cost function, one can instead find the range of cost function parameters that result in any particular solution being optimal. It is often easy to determine which range of parameters is most realistic.

Phase 4

The fourth design phase is detailed design, in which the entire process is repeated to resolve open design details for the individual components of the resulting design. This is in keeping with the design heuristic "allocate resources as long as the cost of not knowing exceeds the cost of finding out."¹³ The process is inherently recursive, with each high level design decision producing a simpler design problem at a lower level of abstraction with simpler requirements. To accommodate this, we need to be able to model the design at multiple levels of abstraction and to allow the specification of interfaces between components. These models must allow us to define static as well as dynamic (behavioral) components of the interface.

In addition to this recursive aspect of design, there is of course iteration also possible, as dead ends are discovered in an otherwise promising chain of design decisions and as changes in the marketplace demand revisions of a product. To accommodate this iteration, design models should document not only decisions made, but also reasons for those decisions. Otherwise, the reasoning must be rediscovered in each iteration, or worse, may not be rediscovered until it is too late.

22.2 The Goals of Modeling

We have seen that models serve many purposes in mechatronics design. First, models serve to document concepts, assumptions, and requirements and allow the communication of these concepts to others in the design group and the various stakeholders of the design process. Second, models provide a hierarchical framework which allows division of labor in the design process and permits concurrent work on separate components.

Third, models can provide us with insights into the behavior of a system which might be obscured when we attempt to see the system in its full complexity. Fourth, they allow us to grasp similarities with other systems and use prior experience to help solve current problems. Fifth, models provide us a way of identifying and testing our ignorance of the actual behavior of the system by identifying unknown parameters and providing hypotheses worthy of testing. In this section, we shall consider these diverse purposes of modeling and examine the characteristics that cause a particular modeling methodology to be better or more poorly suited for each of these purposes.

Documentation and Communication

The first purpose of a model that we shall consider is documentation. We often forget that aside from the various purposes of modeling in the design process, our models are often our best tools for communicating with our colleagues, our customers, and our successors. Every document generated in the design process is a model of some part of the system. To the extent that we can avoid double documentation of the same concept, we not only reduce workload and decrease time to market, but we also reduce the likelihood of inconsistencies in our documentation. How do our models serve as documentation? Consider a circuit diagram. It is not the circuit, but documentation of the circuit's design. It is also a model of the behavior we are seeking from the circuit. Nonidealities and component variations will cause the actual circuit to behave differently from this model, but the model still serves its purpose. Earlier in the design process, requirements documents also document the product, but in terms of requirements rather than the features that satisfy them.

Design documentation is important for at least four distinct groups. The engineering team itself needs communication among its members to ensure that effort is not wasted on elements that do not interoperate or that do not contribute to the overall product meeting requirements. Communication is required between the design team and the customer to ensure that requirements are correctly understood and implemented in the design. Management needs to understand the status of the project in terms of outstanding risks, ongoing expenses, and tradeoffs that would affect market size. Finally, future design teams can benefit from documentation of earlier design concepts, analyses, and decisions. This role of documentation as a communication with future workers in the field has been recognized as a key part of all scientific disciplines¹⁴ but is often overlooked by engineers focused on meeting short-term deadlines.

What characteristics of a model lead to good documentation and clear communication? Clearly, the model must be understood by others. This requirement encourages the use of standardized modeling techniques whenever possible. It also encourages the use of modeling techniques that are interdisciplinary whenever feasible. When choosing models for documentation purposes, one must remember that each model highlights certain features of the design while hiding others. For example, the sequence diagram clearly documents communication between two objects while hiding details of how the objects generate outgoing messages or interpret incoming ones. If multiple models of the system are used to document the various aspects of the system, there should be some way to cross-reference items between models (e.g., determine that timing requirements documented in a sequence diagram model are met by the dynamics of a system described in a block diagram). Also, if the documentation is to be useful to future designers, it should be possible to cross reference design models based on a variety of criteria including system requirements and included components, so that future designs can benefit from current ones. Clearly, any modeling technique that serves some other purpose in design will also serve as documentation, but the model must be chosen so as to match the features one wishes to document.

Hierarchical Framework

Real mechatronic systems include a large number of components that interact in many ways. Our models simplify these complex interfaces and describe products and processes in terms of simply interacting components with well-defined interfaces and behaviors. This simplification allows us to subdivide complex problems into a set of simpler problems whose solutions can be easily integrated. In complex mechatronic systems where we must consider components that interact in several energy domains, this

simplification is essential. When we draw a block diagram of a system we are dividing the system's behavior into a set of defined elements with modeled behavior and a known set of interactions between those elements, which is itself amenable to analysis. This role of modeling would lead us to select modeling techniques that allow us to divide the model into portions that can be independently tackled by independent engineers. For example, systems of linear differential equations may give us great insight into the fundamental modes of a system, but give us little insight on how to divide a design problem among members of a team. However, a block diagram, a class diagram, or a data flow diagram provides clear interfaces between elements that allow for subdivision.

Insights

Regarding insights into the behavior of the system, different models provide different types of insights. Signal flow graphs of electromechanical systems show the presence of feedback loops that stabilize or destabilize the system. Differential equations provide insights regarding the time scales of various behaviors and the relative importance of various factors as well as providing estimates of the validity of simplifying assumptions. Similarly, sequence and timing diagrams can provide insight regarding the processing power required to meet timing requirements for various use cases. In each case the model provides insights into the problem or the characteristics of a proposed solution by bringing into focus certain aspects of the modeled system while hiding others from view.

Analogies

Related to the insights a model can give us regarding the system under consideration are the insights that a model can provide in allowing us to see similarities to other systems that we or others have seen before. In this regard, modeling techniques that use analogies between various domains can be useful. However, analogies must be chosen with care. Consider the common analogy between electrical and mechanical quantities shown in the left half of Fig. 22.7. In this analogy, velocity is analogous to voltage and force is analogous to current. However, as seen in the right half of Fig. 22.7, the equations for the electrical system are unchanged in the dual system, in which current and voltage are exchanged and the roles of inductance and resistance are exchanged with capacitance and conductance, respectively. This dual system results in a different mechanical analogy, in which velocity is analogous to current and force is analogous to voltage. Each of these analogies can prove useful in moving design parameters from one energy domain to another, as the duality between the two electrical models can prove useful in circuit design. With any of these analogies, it must be remembered that real components deviate substantially from their idealized models and that the analogies do not strictly hold. This can be both a bane and a blessing, since a design that suffers from component nonidealities might be replaced by an analogous design from a domain with different but less detrimental nonidealities.

| Element | Electrical | Mechanical | Electrical | Mechanical |
|-------------|----------------------------|-----------------------|----------------------------|-----------------------|
| Capacitance | $i = C \frac{dv}{dt}$ | $f = M \frac{dv}{dt}$ | $v = \frac{1}{C} \int idt$ | $f = k \int vdt$ |
| Inductance | $i = \frac{1}{L} \int vdt$ | $f = k \int vdt$ | $v = L \frac{di}{dt}$ | $f = M \frac{dv}{dt}$ |
| Resistance | $i = \frac{1}{R} v$ | | $v = Ri$ | $f = Bv$ |
| Conductance | $i = Gv$ | $f = Bv$ | $v = \frac{1}{G} i$ | |

FIGURE 22.7 Electrical–mechanical analogies.

Identification of Ignorance

The final role of modeling is to help us identify our ignorance. This takes two forms. First, the construction of the model often requires us to name parameters whose numerical value is unknown. This leads us to estimate the possible range of such parameters or to design experiments to determine the parameter's value. Identifying missing details is the first step in determining them. In this way models help us identify our ignorance of details of the problem or our proposed solution. Secondly, the predictions we make with the help of our models are testable. The adequacy of a model to describe system behavior can be determined by comparing actual system behavior with predictions based on that model. Differences between actual system performance and a model's predictions point to errors in the model that may be significant. By testing the validity of our models we identify aspects of the real system that are inadequately reproduced in our model or artifacts of the model that do not exist in the real system. These discrepancies may point to an inappropriate assumption or to a fundamental misunderstanding of the physical system. In either case, the source of these discrepancies should be understood in order to determine if our model is adequate for its intended purpose.

22.3 Modeling of Systems and Signals

In the area of systems and signals we typically deal with the modeling of system dynamics and information flows through the system and its environment. As can be seen from the discussion above, this is but a small part of the modeling needed for system design. However, there are a number of decisions that must be made in selecting a model for the behavior of a dynamic system. These include the choice between analytic and numerical modeling, the use of distributed or lumped parameters, the approach used to model random factors, and the choice between linear and nonlinear models. These issues are considered in the paragraphs below.

Analytical vs. Numerical Models

In this area both analytical and numerical tools are available to support our efforts, so we have a number of decisions to make regarding the level of complexity of the models we choose to use for various tasks. Analytical tools provide insights into overall system behaviors and can allow us to make comparisons between dissimilar systems based on a similarity in their models. These analogous systems often prove useful in the concept generation phase of design because they allow us to bring to bear solutions to diverse problems to the solution of the problem at hand. However, as described above, these analogies usually break down upon closer inspection. In the case of analogies in dynamics, they are typically based on systems described by equivalent differential equations (e.g., electronic and mechanical oscillators). However, these linear differential equations are but simplifications that ignore nonlinearities and time-dependent behavior that may greatly affect system behavior. Therefore, when applying analogies one must always be careful to explicitly state assumptions made in the modeling process.

Numerical tools, on the other hand, do not yield the same insights of analytical tools, but provide other and more detailed insights into real system behavior and performance. Typically these tools become most useful later in the design process, both for tradeoff analysis and for detailed design work. The availability of these tools opens many doors to modeling options that have in the past been closed and allows us to consider options that have historically been considered unwieldy. For example, numerical solution of nonlinear differential equations allows modeling of systems that had previously been approached only with linear approximations.

Partial vs. Ordinary Differential Equations

One modeling choice that must be made is whether we must model the dynamics of the system using ordinary or partial differential equations. Partial differential equations must be used whenever values of interest vary spatially as well as temporally. For example, if we are considering the design of a robot arm, we are free to use ordinary differential equations if we consider the arm to be rigid, partial differential

equations if we wish to describe the bending of a flexible arm in detail. However, what if we recognize a flexibility in the arm but do not need to know the details of its motion but only the effect of its flexure on the end effector? In this case we can make a lumped parameter model of the arm that summarizes its dynamics in terms of end effector motion and dynamic forces on the driver and end effector. When can this lumped parameter model be used? There are two restrictions. First, the details of the variation of behavior over space must be uninteresting to us. If we need to know these details (for example, to determine stress concentration, or temperature distribution) we cannot apply the simplified model. Secondly, the partial differential equation may not be amenable to forming a lumped form due to its complexity.

Stochastic vs. Deterministic Models

One choice that must be made in the modeling of system behavior is how uncontrolled variability will be represented in the model.¹⁵ The approach taken depends a great deal on the source and characteristics of the variability. For example, the values of some system parameters may not be precisely known, but may be constant over time. Others may vary slowly over time in unknown ways. In the first case, the sensitivity of the system to parameter value can be determined, using a variety of both analytical and numerical techniques. In the latter case, one must examine the speed of parameter variation to determine if the system can be analyzed in quasi-steady state or if the dynamics of the parameter variations are coupled with the dynamics of the system. For this purpose, it is often useful to write equations in dimensionless form where time and scale constants indicate critical speeds for coupling.

When the variation of parameters over time must be considered or when some inputs to a system have uncontrolled variability, we must choose whether to model the input as an arbitrary signal or a signal with known statistical parameters. In the first case, we have just another input and can analyze the system for sensitivity to this input. In the second case, we can characterize the system in terms of autocorrelation or equivalent spectral measures and use optimal filtering techniques to reduce uncertainty.¹⁶ A key point in the statistical modeling of a system is to base the model on the known variability of the process rather than assuming additive, white, Gaussian noise at every turn.¹⁷

Linear vs. Nonlinear

A wealth of techniques are available for the analysis of linear time invariant systems. Unfortunately, the world gives us nonlinear components. One advantage of modeling techniques that allow us to divide a complex system into simpler sub-components is that we can often isolate nonlinearities as individual elements and develop linear models for them. For small variations about a differentiable point on a nonlinear curve, we can always find a linear model, but the value of this model might be extremely limited depending on its accuracy over a reasonable range of input values. In the case of a discontinuous or nondifferentiable nonlinearity, there is a greater problem. A linear model can be found only when we are far from the discontinuity or when the discontinuity is small compared to the linear portion of the model.

However, nonlinearities also add essentially new behaviors to systems that are not possible in purely linear systems. For this reason alone, nonlinear models are needed in certain circumstances. As an example, for a linear system, stable oscillations are only theoretically possible for differential equations with purely imaginary eigenvalues. Positive real parts lead to growing oscillations, while negative real parts lead to damped oscillations. Clearly, the behavior of such a system is highly sensitive to system parameters. Small variations will either kill the oscillation or drive the system into nonlinear regions of operation. Furthermore, even for perfect oscillators, the amplitude of oscillations is unconstrained. However, a nonlinear system such as the Van der Pol equation:

$$\ddot{y} = -\omega^2 y + \alpha \left[1 - \left(\frac{y}{y_0} \right)^2 \right] \dot{y}$$

includes a damping term that increases with the magnitude of the oscillation. For oscillations small compared to y_0 the oscillations grow, while larger oscillations are damped. This and other essentially

nonlinear behavior cannot be modeled adequately with linear models. Although once this behavior is recognized through the use of a nonlinear model, the resulting steady-state system (a stable oscillator) can be modeled for many purposes using its linear (although physically unrealizable) equivalent.

When using differential equations to model a system, we must be particularly careful in our choice of units of measure and in how we group parameters. For example, in the Van der Pol equation above, we can choose an alternative scale for y such that y_0 is 1 and a time scale such that ω is 1. In this case we have

$$z'' = -z + \varepsilon(1 - z^2)z'$$

where $z = y/y_0$, $\tau = \omega t$, and $\varepsilon = \alpha/\omega$. This scaling provides a dimensionless equation as well as providing an indication of the system's natural time scale, the scale of y , and an indication that the size of α relative to ω is important. In general, we find that writing equations in dimensionless form provides three advantages. First, as mentioned above, the scaling factors provide a sense of time scale and magnitude of various features of the system's dynamic behavior. Second, the dimensionless parameters that result from combining physical system parameters provide a way of characterizing the behavior of a wide range of systems in terms of parameters that are easily mapped. Third, by putting the equation into dimensionless form, we are able to categorize it and recognize similar equations in different domains.

References

1. Hubka, V. and Eder, W.E., *Engineering Design—General Procedural Model of Engineering Design*, Heuista, Zurich, 1992.
2. Pahl, G. and Beitz, W., *Engineering Design: A Systematic Approach*, Springer-Verlag, Berlin, 1988.
3. Dym C.L., *Engineering Design—A Synthesis of Views*, Cambridge University Press, New York, 1994.
4. Booch, G., Jacobson, I., Rumbaugh, J., and Rumbaugh, J., *The Unified Modeling Language User Guide*, Addison-Wesley, New York, 1998.
5. Douglass, B., *Doing Hard Time: Developing Real-Time Systems with UML, Objects, Frameworks and Patterns*, Addison-Wesley, New York, 1999.
6. Demarco, T., *Structured Analysis and System Specification*, Yourdon Press, NJ, 1978.
7. Coad, P. and Yourdon, E., *Object-Oriented Analysis*, Yourdon Press, NJ, 1990.
8. Glegg, G.L., *The Design of Design*, Cambridge University Press, London, 1969.
9. Shearer, Murphy, and Richardson, *Introduction to Dynamic Systems*, Addison-Wesley, Reading, MA, 1967.
10. Karnopp, D. and Rosenberg, R., *System Dynamics: A Unified Approach*, Wiley, New York, 1975.
11. Suh, N.P., *Principles of Design*, Oxford University Press, NY, 1990.
12. Taguchi, G. and Yokoyama, Y., *Taguchi Methods: Design of Experiments*, American Supplier Institute, Dearborn MI, 1994.
13. Koen, B.V., *Definition of the Engineering Method*, American Society for Engineering Education, Washington, 1985.
14. Lonergan, B., *Method in Theology*, University of Toronto, Toronto, 1990.
15. Zhou, K., *Essentials of Robust Control*, Prentice-Hall, NJ, 1998.
16. Papoulis, A., *Probability, Random Variables, and Stochastic Processes*, McGraw-Hill, New York, 1991.
17. Law, A. and Kelton, W., *Simulation, Modeling and Analysis*, McGraw-Hill, New York, 1991.

23

Signals and Systems

Momoh-Jimoh Eyiomika
Salami

*International Islamic University
of Malaysia*

Rolf Johansson

Lund Institute of Technology

Kam Leang

University of Washington

Qingze Zou

University of Washington

Santosh Devasia

University of Washington

C. Nelson Dorny

University of Pennsylvania

- 23.1 Continuous- and Discrete-Time Signals
Signal Classification¹⁻⁴ • Singularity Functions • Basic
Continuous-Time Signals • Basic Discrete-Time
Signals • Analysis of Continuous-Time Signals • Fourier
Analysis of CT Signals • Fourier Transform • Sampled
Continuous-Time Signals • Frequency Analysis of Discrete-
Time Signals • The Discrete Fourier Transform^{6,8,13}
- 23.2 z Transform and Digital Systems
The z Transform • Digital Systems and Discretized
Data • The Discrete Fourier Transform • The Transfer
Function • State-Space Systems • Digital Systems
Described by Difference Equations (ARMAX Models) •
Prediction and Reconstruction • The Kalman Filter
- 23.3 Continuous- and Discrete-Time
State-Space Models
Introduction • States and the State-Space • Relationship
Between State Equations and Transfer-Functions •
Experimental Modeling Using Frequency-Response •
Discrete-Time State-Space Modeling • Summary
- 23.4 Transfer Functions and Laplace Transforms
Transfer Functions • The Laplace Transformation •
Transform Properties • Transformation and Solution of a
System Equation

23.1 Continuous- and Discrete-Time Signals

Signals are physical variables or quantities measured at various parts of a system, which when processed yield the desired information. A wide variety of signals are often encountered in describing many practical systems. Electrical signal, in form of current and voltage, is the most easily measured quantity, hence the need to use sensors and transducers to transform other non-electrical quantity into electrical signals. These signals must be processed by appropriate techniques if desirable results are to be obtained. Several methods of signal representation, suitable for effective signal processing in both time and frequency domains, are discussed in this section.

Signal Classification¹⁻⁴

Signals are broadly classified as either continuous-time (CT) or discrete-time (DT) signals, and each of these may in turn be categorized as deterministic or random signals. A deterministic signal can always be expressed mathematically, whereas the time of occurrence or value of a random signal cannot be predicted with certainty. A CT signal, $x(t)$, has a specified value for every value of time, t , while a DT signal, $x(n)$, has specified a value only at discrete points, that is, for integer values of n . Closely related

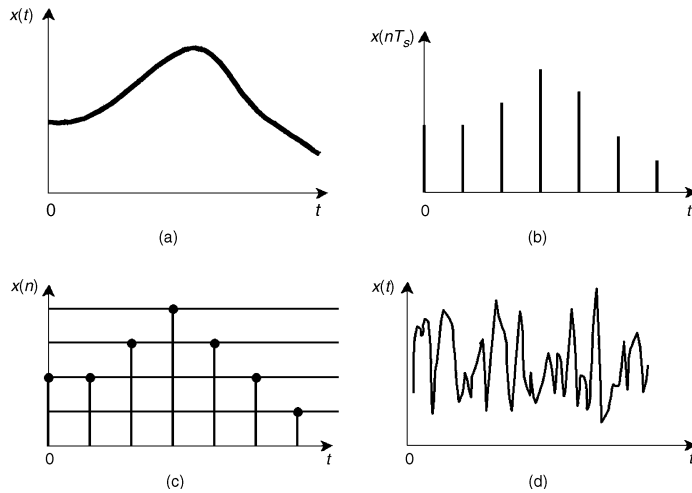

FIGURE 23.1 Description of some classes of signals: (a) continuous-time analog, (b) sampled-data, (c) digital signal, (d) random signal.

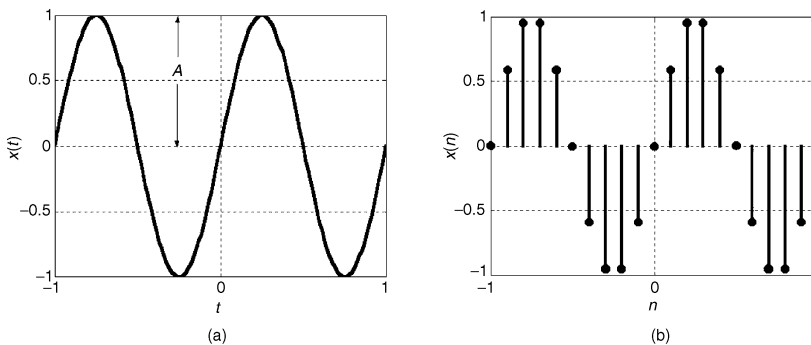

FIGURE 23.2 Description of periodic signals: (a) CT, (b) DT.

to CT and DT signals are analog and digital signals, respectively. If the amplitude of a signal can take on any value in a continuous range, then it is an analog signal. On the other hand, the amplitude of a digital signal can have only finite number of values at discrete points. Examples of continuous-time, discrete-time, digital, and random signals are shown in [Fig. 23.1](#).

Deterministic signals fall into two main categories, namely periodic and aperiodic signals. A periodic signal has the same values at times separated by one period, T , that is, $x(t)$ satisfies the relation, $x(t) = x(t + T)$, $-\infty < t < \infty$. An example of a CT periodic signal is a sinusoidal waveform of the form $x(t) = A \sin(\Omega t + \theta)$, where θ is the phase in radians, $\Omega = 2\pi F$ is the frequency in radians per second, and F is the frequency in hertz. It should be noted that the frequency range for the analog sinusoids is $-\infty < F < \infty$. A periodic DT signal is described by $x(n) = x(n + N)$, $-\infty < n < \infty$, where N represents the period. An example of this is the sinusoidal waveform $x(n) = A \sin(2\pi r n + \theta)$, $-\infty < n < \infty$, where r is the signal frequency per sample frequency and has values in the range $-\frac{1}{2} \leq r \leq \frac{1}{2}$. Samples of sinusoids having frequencies within this range are unique and distinct. However, DT sinusoids whose frequencies are separated by an integer multiple of 2π are identical. Examples of analog and DT sinusoids are depicted in [Fig. 23.2](#).

Any deterministic signal that is not periodic is referred to as aperiodic or nonperiodic. Damped sinusoids and exponential decaying signals are common examples of aperiodic signals. For some applications, it may

be quite useful to classify the signals according to their energy or power content. The total energy over the range $t \in (-\infty, \infty)$ for a CT signal is given by

$$E = \lim_{T \rightarrow \infty} \int_{-T/2}^{T/2} |x(t)|^2 dt \quad (23.1)$$

and the average power is defined as

$$P = \lim_{T \rightarrow \infty} \left[\frac{1}{T} \int_{-T/2}^{T/2} |x(t)|^2 dt \right] \quad (23.2)$$

Consequently, $x(t)$ is an energy signal if and only if $0 < E < \infty$, which implies that $P = 0$. Similarly, $x(t)$ is a power signal if and only if $0 < P < \infty$, indicating $E = \infty$. A signal that fails to satisfy either definition is, therefore, neither energy nor power signal. These definitions are also applicable to DT signals except that the integral in Eqs. (23.1) and (23.2) is replaced by summation. In general, periodic signals exist for all the time and as such have infinite energy. However, they have finite average power, hence they are power signals. On the other hand, bounded finite-duration signals are energy signals. The classification of a signal to finite energy, finite power, or neither is important so that appropriate and effective procedures can be selected for its analysis.

Singularity Functions

Singularity functions are useful for signal modeling, that is, they serve as basis for representing complex signals to simplify their analysis.

The Unit Impulse Function

The impulse or delta function is a mathematical model for representing physical phenomena that occurs within very small time duration; this time duration can be assumed to be equal to zero. The unit delta function is not a mathematical function in the usual sense; rather it is a distribution or a generalized function. Thus, the impulse function can be described by its effect on the *test function* $\phi(t)$, that is,

$$\int_{-\infty}^{+\infty} \phi(t) \delta(t) dt = \phi(0) \quad (23.3)$$

provided $\phi(t)$ is continuous at $t = 0$. This equation shows the shifting property of the delta function. A graphical plot of the delta function is shown in Fig. 23.3(a). Table 23.1 shows the operating properties of the delta function.

The Unit Step Function

The unit step function is particularly useful for the mathematical analysis of CT signals. This is depicted in Fig. 23.3(b), and is defined as

$$u(t) = \begin{cases} 1, & t > 0 \\ 0, & t < 0 \end{cases} \quad (23.4)$$

TABLE 23.1 Properties of the Delta Function

| Property | Mathematical Expression |
|-------------|---|
| Sampling | $\int_{-\infty}^{+\infty} x(t) \delta(t-a) dt = x(a)$ |
| Shifting | $x(t) \delta(t-a) = x(a) \delta(t-a)$ |
| Scaling | $\delta(at \pm b) \equiv \frac{1}{ a } \delta\left(t \pm \frac{b}{a}\right)$ |
| Convolution | $x(t) * \delta(t-a) = \int_{-\infty}^{+\infty} x(\tau) \delta(t-\tau-a) d\tau = x(t-a)$ |

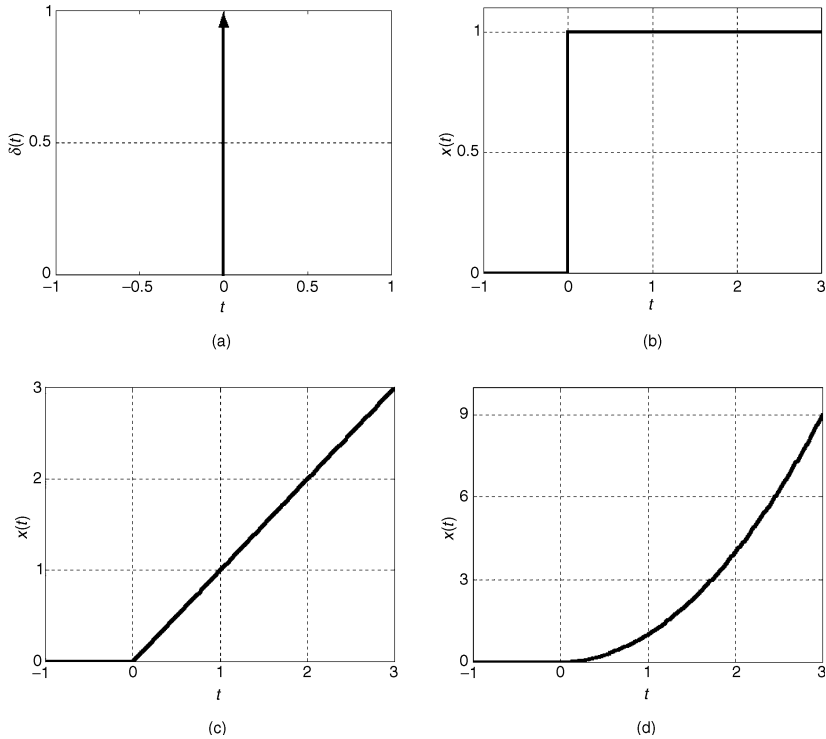

FIGURE 23.3 Description of singularity function: (a) impulse, (b) step, (c) ramp, (d) parabolic.

The signum function is derived from the step function according to

$$\text{sgn}(t) = 2u(t) - 1$$

The Ramp Function

Integrating (23.4) yields the ramp function shown in Fig. 23.3(c). The unit ramp function $r(t)$ is expressed as

$$r(t) = \begin{cases} t, & t \geq 0 \\ 0, & t < 0 \end{cases} \quad (23.5)$$

Furthermore, integrating $r(t)$ yields a unit parabolic signal of the form

$$a(t) = \begin{cases} \frac{t^2}{2}, & t \geq 0 \\ 0, & t < 0 \end{cases} \quad (23.6)$$

This is depicted in Fig. 23.3(d).

Basic Continuous-Time Signals

Figure 23.4 shows some of the elementary signals that are often encountered in signal analysis. Some of these signals can be derived directly from the singular functions discussed above. For example, the unit rectangular pulse signal that extends from $-\tau/2$ to $\tau/2$ can be expressed as

$$\Pi(t) = u\left(t + \frac{\tau}{2}\right) - u\left(t - \frac{\tau}{2}\right) \quad (23.7)$$

and this is depicted in Fig. 23.4(a).

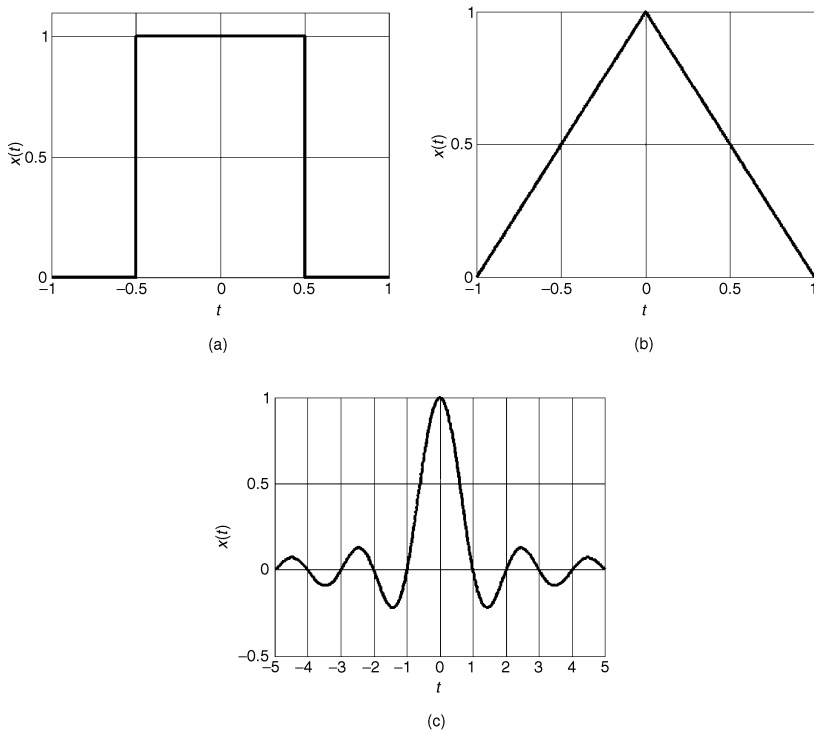

FIGURE 23.4 Description of basic CT signal: (a) rectangular pulse, (b) triangular pulse, (c) sinc function.

The triangular function, denoted as $\Lambda(t)$, is defined as

$$\Lambda(t) = \begin{cases} 1 - |t|, & |t| < 1 \\ 0, & \text{otherwise} \end{cases} \quad (23.8)$$

Using the convolution theorem, to be discussed in section “Analysis of Continuous-Time Signals”, it can be shown that

$$\Lambda(t) = \Pi(t) * \Pi(t)$$

The sinc signal is defined as

$$\text{sinc}(t) = \begin{cases} \frac{\sin(\pi t)}{\pi t}, & t \neq 0 \\ 1, & t = 0 \end{cases} \quad (23.9)$$

Both the triangular and sinc signals are shown in [Figs. 23.4\(b\)](#) and [23.4\(c\)](#), respectively.

Basic Discrete-Time Signals

The unit sample sequence, denoted as $\delta(n)$, is defined as

$$\delta(n) = \begin{cases} 1, & n = 0 \\ 0, & \text{otherwise} \end{cases}$$

It is also referred to as the unit impulse sequence or Kronecker delta function. The working properties of the unit sample sequence are analogous to that of $\delta(t)$ and these are shown here:

$$\sum_{n=-\infty}^{\infty} x(n)\delta(n-m) = x(m)$$

$$x(n)\delta(n-m) = x(m)\delta(n-m)$$

$$\delta(an \pm b) = \delta\left(n \pm \frac{b}{a}\right)$$

$$x(n) * \delta(n-m) = \sum_{r=-\infty}^{\infty} x(r)\delta(n-r-m) = x(n-m)$$

Note that the scaling property is only applicable when both a and b/a are integers. Two other basic signals that are useful for analysis are the unit step and unit ramp signals. The unit step sequence, $u(n)$, is defined as

$$u(n) = \begin{cases} 1, & n \geq 0 \\ 0, & n < 0 \end{cases} \quad (23.10)$$

whereas the unit ramp signal, denoted as $r(n)$, is given by

$$r(n) = \begin{cases} n, & n \geq 0 \\ 0, & n < 0 \end{cases}$$

The above three sequences are related as follows:

$$\delta(n-k) = u(n-k) - u(n-k-1)$$

$$u(n) = \sum_{m=-\infty}^n \delta(n-m)$$

$$r(n) = u(n) * u(n-1)$$

Figure 23.5 illustrates the above DT sequences.

Analysis of Continuous-Time Signals

Basic Operations on Signals

There are some important operations that are often performed on signals so as to understand either their characteristics or the physical phenomena generating them. The three most common operations are shifting, time scaling, and reflection. Examples of these operations are illustrated in Fig. 23.6, where $x(t)$ is expressed as

$$x(t) = \begin{cases} t+1, & -1 \leq t \leq 3 \\ 3, & 3 < t \leq 6 \\ 0, & \text{otherwise} \end{cases}$$

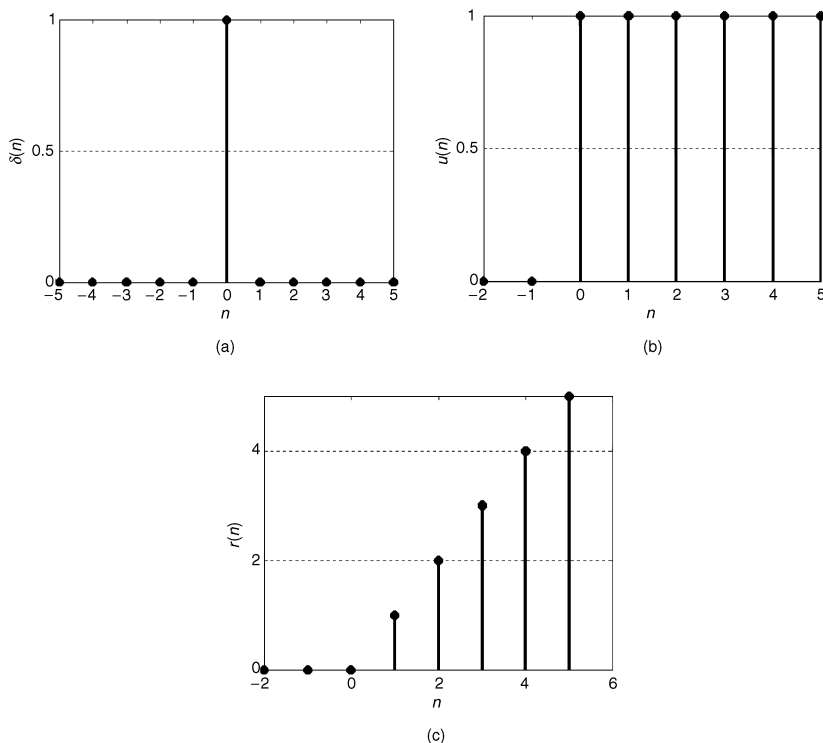

FIGURE 23.5 Description of basic DT signal: (a) unit pulse sequence, (b) unit step sequence, (c) ramp sequence.

The Convolution and Correlation Integrals²

Though the convolution operation is often associated with systems studies, occasionally this operation may be needed in analyzing signals obtained from a physical system. The convolution of two CT signals $x(t)$ and $y(t)$ yields $z(t)$, where

$$z(t) = x(t) * y(t) = \int_{-\infty}^{\infty} x(\tau)y(t - \tau)d\tau \tag{23.11}$$

Convolution is not limited to time-domain since it is also used to determine the frequency-domain spectrum associated with the product of two time-domain signals. The cross-correlation function between $x(t)$ and $y(t)$, denoted as $R_{xy}(t)$, is defined as

$$R_{xy}(t) = x(t) \oplus y(t) = \int_{-\infty}^{\infty} x(\tau)y^*(\tau - t)d\tau \tag{23.12}$$

Unlike the convolution there is no reflection operation here. Furthermore, the variable lag, t , is the scanning parameter that measures the degree of similarity between these two signals. If $x(t) = y(t)$, then (23.12) describes the autocorrelation function. Some properties of the correlation functions are given in Table 23.2.

Both convolution and correlation integrals are applicable to the energy as well as power signals. In the case of power signals, the integral is taken over the period T and the result is scaled by $1/T$. Correlation analysis is important as it leads to the computation of the energy spectral density for the transient signals, and power spectral density for both periodic and random signals.

TABLE 23.2 Properties of the Correlation Function

| Property | Autocorrelation | Crosscorrelation |
|--------------|--|--|
| Even/Reorder | $R_{xx}(t) = R_{xx}(-t)$ | $R_{xy}(t) = R_{yx}(-t)$ |
| Upper Bound | $R_{xx}(0) \geq R_{xx}(t)$, for any t | $ R_{xy}(t) \leq \sqrt{R_{xx}(0)R_{yy}(0)}$ |

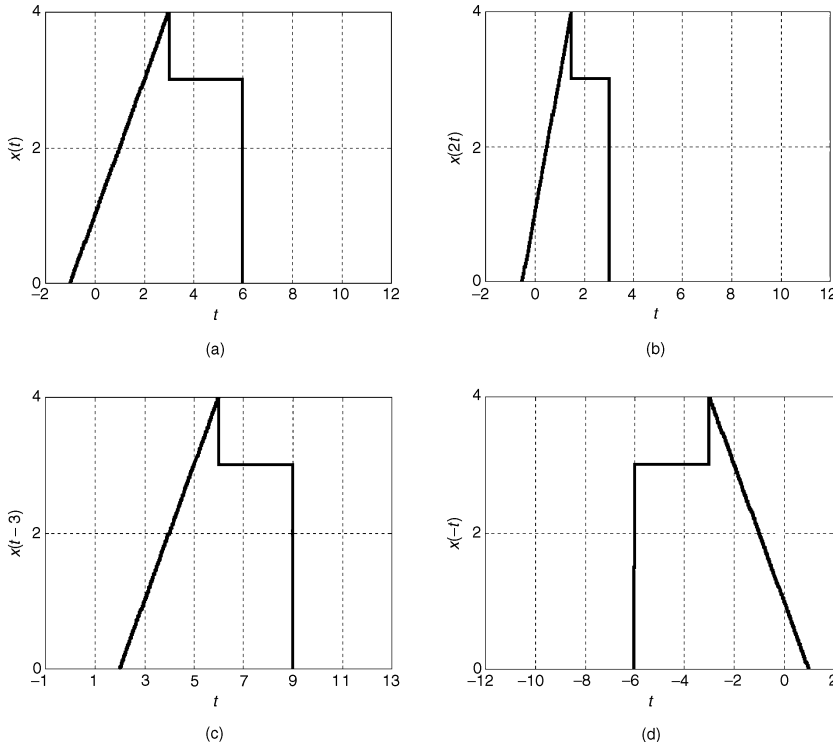

FIGURE 23.6 Basic operations on signal: (a) original signal, (b) scaling, (c) shifting, (d) reflection.

Fourier Analysis of CT Signals

So far we have discussed only the time-domain methods of analyzing CT signals. The convolution integral is of particular interest since this can be used to study how a signal is modified as it passes through a system. There is need to consider the frequency-domain methods of analysis since the convolution analysis can be laborious. Furthermore, the formulation of convolution integral is based on representing the signals by shifted δ -functions. In many applications, it is more appropriate and desirable to choose a set of orthogonal functions as the basic signals since this approach leads to a reduction in computational complexity as well as providing a graphical representation of the frequency components in a given signal.

Orthogonal Basis Functions^{2,3}

It is mathematically convenient to represent arbitrary signals as a weighted sum of orthogonal waveforms as this leads to a very much simplified signal analysis as well as showing the fundamental similarity between signals and vectors. Consider a set of basis function $\phi(t)$, $i = 0, \pm 1, \pm 2, \dots$. This is said to be orthogonal over an interval (t_1, t_2) if

$$\int_{t_1}^{t_2} \phi_m(t) \phi_k^*(t) dt = E_k \delta(m - k) \quad (23.13)$$

where $\phi_k^*(t)$ stands for the complex conjugate of the signal. If E_k is equal to unity for all values of k , then the $\phi(t)$ is an orthonormal set. It is relatively easy to approximate a given signal by an appropriate set of orthonormal functions as this leads to minimum error between the actual signal and its approximation. Thus, a given signal $x(t)$ with finite energy over the interval $t_1 < t < t_2$ can be expressed as

$$x(t) = \sum_{k=-\infty}^{\infty} c_k \phi_k(t) \quad (23.14)$$

where

$$c_k = \int_{t_1}^{t_2} x(t) \phi_k^*(t) dt, \quad k = 0, \pm 1, \pm 2, \dots$$

This equation is referred to as the generalized Fourier series of $x(t)$, and the constants c_k , $k = 0, \pm 1, \pm 2, \dots$, are called the Fourier series coefficients with respect to the orthogonal set $\{\phi(t)\}$.

Denoting the first M terms in Eq. (23.14) as $\hat{x}(t)$, the resulting error function is

$$e_M(t) = x(t) - \sum_{k=0}^M c_k \phi_k^*(t) \quad (23.15)$$

By computing the average power of this error function and setting its derivatives with respect to c_k to zero, yields an optimal set of $\{c_k\}$ that minimizes the error energy. Also, if $\lim_{M \rightarrow \infty} \hat{x}(t) = x(t)$, then the basis functions are said to be complete, that is, the error energy is equal to zero. When dealing with periodic signals, the time interval (t_1, t_2) is equal to the period, T , of the signal. In addition, $\phi_n(t) = \exp\{jn\omega_0\}$ is often selected as the set of basis functions, for $n = 0, \pm 1, \pm 2, \dots$, and $\omega_0 = 2\pi/T$. The methods of computing the Fourier series coefficients are subsequently discussed.

The Complex Exponential Fourier Series

Let the signal $x(t)$ be such that $x(t) = x(t + T)$ and that it satisfies the Dirichlet conditions:³

1. $x(t)$ is absolutely integrable over its period, that is,

$$\int_{t_1}^{t_1+T} |x(t)| dt < \infty$$

2. the number of maxima and minima of $x(t)$ in each period is finite,
 3. the number of discontinuities of $x(t)$ in each period is finite,
- then $x(t)$ can be expanded as

$$x(t) = \sum_{k=-\infty}^{\infty} c_k e^{jk\omega_0 t}, \quad \omega_0 = 2\pi f_0 \quad (23.16)$$

where

$$c_k = \frac{1}{T} \int_{t_1}^{t_1+T} x(t) e^{-jk\omega_0 t} dt \quad (23.17)$$

for any arbitrary value of t_1 .

The coefficients c_k are called the complex Fourier series coefficients for the signal $x(t)$, which, in general, may be complex numbers.

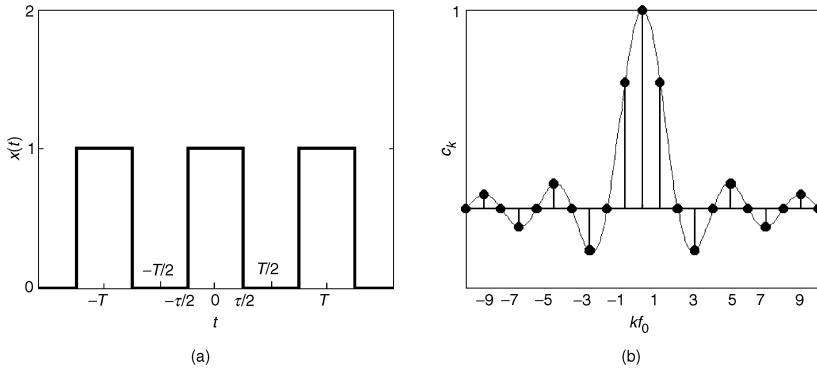

FIGURE 23.7 Rectangular periodic signal and its Fourier series coefficients.

The Dirichlet conditions are only sufficient conditions for the existence of the Fourier series expansion. The Fourier series expansion of signals, which does not satisfy these conditions, can still be obtained.

The complex Fourier series coefficients can be determined by either directly evaluating the integral in (23.17) or using the method of differentiation. The latter method relies on differentiating $x(t)$, for a certain number of times, to produce a train of impulses. These two methods of determining c_k will now be illustrated.

Consider the periodic signal shown in Fig. 23.7(a), which can be expressed as

$$x(t) = \frac{1}{T} \sum_{n=-\infty}^{\infty} \text{PI} \left(\frac{t - nT}{\tau} \right)$$

Substituting this in Eq. (23.17) we have

$$\begin{aligned} c_k &= \frac{1}{T} \int_{-T/2}^{T/2} x(t) e^{-j2\pi k f_0 t} dt \\ &= \frac{1}{T} \int_{-\tau/2}^{\tau/2} e^{-j2\pi k f_0 t} dt \\ &= \frac{1}{\pi k} \sin(k\pi f_0 \tau) \\ &= \tau f_0 \text{sinc}(k f_0 \tau) \end{aligned}$$

Thus,

$$x(t) = \sum_{k=-\infty}^{\infty} \tau f_0 \text{sinc}(k f_0 \tau) e^{j2\pi k f_0 t}$$

A graph of the magnitude and phase spectra of the complex Fourier series coefficients are shown in Fig. 23.7(b) for varied τ/T .

Consider the computation of the complex Fourier series coefficients of the signal shown in Fig. 23.8(a) using the method of differentiation. This signal is expanded according to Eq. (23.16). Differentiating this equation twice with respect to t yields

$$x''(t) = \sum_{k=-\infty}^{\infty} (j2\pi k f_0)^2 c_k e^{j2\pi k f_0 t}$$

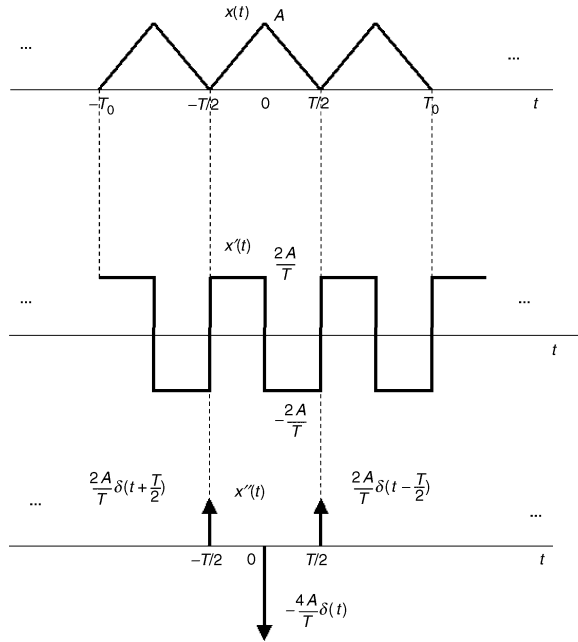

FIGURE 23.8 Illustration of the differentiation technique for Fourier series coefficient computation.

which can be written as

$$x''(t) = \sum_{k=-\infty}^{\infty} \beta_k e^{j2\pi k f_0 t}$$

Figure 23.8(c) shows the result of differentiating $x(t)$. It is noted that if a signal is periodic, its derivatives will also be periodic. This implies that β_k is the complex Fourier series coefficient of $x''(t)$ and can be computed from

$$\beta_k = \frac{1}{T} \int_{-T/2}^{T/2} x''(t) e^{-j2\pi k f_0 t} dt$$

where

$$x''(t) = \frac{2A}{T} \left[\delta\left(t + \frac{T}{2}\right) - 2\delta(t) + \delta\left(t - \frac{T}{2}\right) \right]$$

Thus,

$$\beta_k = -8 \frac{A}{T^2} \sin^2\left(\frac{\pi k T f_0}{2}\right) = (j2\pi f_0 k)^2 c_k$$

That is,

$$c_k = \begin{cases} \frac{2A}{\pi^2 k^2}, & k \text{ odd} \\ 0, & \text{otherwise} \end{cases}$$

and

$$c_0 = \frac{1}{T} \int_{-T/2}^{T/2} x(t) dt = \frac{A}{2}.$$

This method of determining c_k , where applicable, is less laborious than the direct method.

Fourier Series for Real Signals³

A real signal $x(t)$ that satisfies the Dirichlet conditions can be expanded by the following procedure. Recall Eq. (23.17) and replace k by $-k$, we obtain

$$c_{-k} = \frac{1}{T} \int_{t_1}^{t_1+T} x(t) e^{j2\pi k f_0 t} dt = \left[\frac{1}{T} \int_{t_1}^{t_1+T} x(t) e^{-j2\pi k f_0 t} dt \right]^* = c_k^* \quad (23.18)$$

That is, the positive and negative coefficients are complex conjugates of each other for real signals. For such signals, $|c_k|$ has even symmetry and $\angle c_k$ has odd symmetry with respect to $k = 0$. Denote $c_k = (a_k - jb_k)/2$, then $c_{-k} = (a_k + jb_k)/2$, so that

$$c_k e^{j2\pi k f_0 t} + c_{-k} e^{-j2\pi k f_0 t} = \frac{a_k - jb_k}{2} e^{j2\pi k f_0 t} + \frac{a_k + jb_k}{2} e^{-j2\pi k f_0 t}$$

Since c_0 is real and defined as $c_0 = a_0/2$, then we can write

$$x(t) = \frac{a_0}{2} + \sum_{k=1}^{\infty} [a_k \cos(2\pi k f_0 t) + b_k \sin(2\pi k f_0 t)] \quad (23.19)$$

This relationship, which only holds for a real periodic signal $x(t)$, is called the trigonometric Fourier series expansion. Since

$$\begin{aligned} c_k &= \frac{a_k - jb_k}{2} = \frac{1}{T} \int_{t_1}^{t_1+T} x(t) e^{-j2\pi k f_0 t} dt \\ &= \frac{1}{T} \int_{t_1}^{t_1+T} x(t) [\cos(2\pi k f_0 t) - j \sin(2\pi k f_0 t)] dt \end{aligned} \quad (23.20)$$

Hence

$$a_k = \frac{2}{T} \int_{t_1}^{t_1+T} x(t) \cos(2\pi k f_0 t) dt \quad (23.21a)$$

$$b_k = \frac{2}{T} \int_{t_1}^{t_1+T} x(t) \sin(2\pi k f_0 t) dt \quad (23.21b)$$

and

$$a_0 = \frac{2}{T} \int_{t_1}^{t_1+T} x(t) dt$$

The third method of Fourier series expansion of real signals is given by

$$x(t) = c_0 + \sum_{k=1}^{\infty} c_k \cos(2\pi k f_0 t + \theta_k) \quad (23.22)$$

TABLE 23.3 Fourier Series Symmetry Conditions

| Type of Symmetry | Real Fourier Series Coefficient | Complex Fourier Series Coefficients | Comments |
|---|---|--|--|
| Even periodic $x(t) = x(-t)$ | $a_k = \frac{4}{T} \int_0^{T/2} x(t) \cos(2\pi k f_0 t) dt$ $b_k = 0$ | $c_k = \frac{1}{2} a_k$ c_k has real value | Phase of c_k is either zero or π |
| Odd periodic $x(t) = -x(-t)$ | $a_k = 0$ $b_k = \frac{4}{T} \int_0^{T/2} x(t) \sin(2\pi k f_0 t) dt$ | $c_k = -j \frac{1}{2} b_k$ c_k has imaginary values | Phase of c_k is either $\pi/2$ or $-\pi/2$ |
| Half-wave even symmetry $x(t) = x\left(t + \frac{T}{2}\right)$ | a_{2k} and b_{2k} may have nonzero values but $a_{2k+1} = 0, b_{2k+1} = 0$ | $c_{2k} \neq 0$ $c_{2k+1} = 0$ | |
| Half-wave odd symmetry $x(t) = -x\left(t + \frac{T}{2}\right)$ | a_{2k+1} and b_{2k+1} may have nonzero values but $a_{2k} = 0, b_{2k} = 0$ | $c_{2k} = 0$ $c_{2k+1} \neq 0$ | |

TABLE 23.4 Properties of the Fourier Series

| Property | Signal Description | Fourier Series Coefficients, c_k |
|--------------------|--|---|
| Linearity | $ax(t) + by(t); a, b$ constants | $a\alpha_k + b\beta_k$ |
| Multiplication | $x(t)y(t)$ | $\alpha_k * \beta_k$ |
| Convolution | $x(t) * y(t)$ | $\alpha_k \beta_k$ |
| Parseval's theorem | $\frac{1}{T} \int_{t_1}^{t_1+T} x(t) ^2 dt$ | $\sum_{k=-\infty}^{\infty} \alpha_k ^2$ |
| Time shift | $x(t \pm \tau)$ | $\alpha_k e^{\pm j2\pi f_0 \tau}$ |
| Differentiation | $\frac{d^n}{dt^n} x(t)$ | $(j2\pi k f_0)^n \alpha_k$ |
| Integration | $\int_T x(\tau) d\tau$ | $(j2\pi k f_0)^{-1} \alpha_k, \alpha_0 = 0$ |

where c_0 is the dc component, c_k and θ_k represent the amplitude and phase angle of the k th harmonic, respectively. Equation (23.22) is called the harmonic form of Fourier series expansion of $x(t)$. The parameters c_k and θ_k are related to a_k and b_k according to

$$c_0 = \frac{a_0}{2}, \quad c_k = \sqrt{a_k^2 + b_k^2}, \quad \theta_k = \tan^{-1} \frac{b_k}{a_k}$$

Properties of the Fourier Series^{1,4}

Knowledge of signal symmetry can simplify its complex Fourier series coefficients computation. While many forms of symmetry can be established, the following important types of symmetry are more often encountered in signal analysis:

- even symmetry, $x(t) = x(-t)$
- odd symmetry, $x(t) = -x(t)$
- half-wave odd symmetry, $x(t) = -x(t + T/2)$

The effects of symmetry on the Fourier series computations are shown in [Table 23.3](#). The other properties on Fourier series are summarized in [Table 23.4](#), where α_k and β_k are the complex Fourier series coefficients of $x(t)$ and $y(t)$, respectively.

Fourier Transform

Frequency domain method of analyzing periodic CT signals has been presented in the previous section. A different technique, termed the Fourier transform, is used for the analysis of aperiodic signals. The development of the Fourier transform is based on Eqs. (23.16) and (23.17). Substituting (23.17) into (23.16) gives

$$x(t) = \sum_{k=-\infty}^{\infty} \left(\frac{1}{T} \int_{-T/2}^{T/2} x(\lambda) e^{-j2\pi k f_0 \lambda} d\lambda \right) e^{j2\pi k f_0 t} \quad (23.23)$$

Allowing $T \rightarrow \infty$, then $1/T \rightarrow df$, $k f_0 \rightarrow f$, and Eq. (23.23) becomes

$$X(f) = \int_{-\infty}^{\infty} x(t) e^{-j2\pi k f t} dt \quad (23.24a)$$

and

$$x(t) = \int_{-\infty}^{\infty} X(f) e^{j2\pi f t} df \quad (23.24b)$$

Properties of the Fourier Transform^{5,6}

Some of the basic properties of the Fourier transform that are often used in analysis are given in [Table 23.5](#).

The Fourier transform pairs of the following basic signals are also useful for analysis:

$$K \leftrightarrow K\delta(f)$$

$$\text{sgn}(t) \leftrightarrow \frac{1}{j\pi f}$$

$$u(t) \leftrightarrow \frac{1}{2}\delta(f) + \frac{1}{j2\pi f}$$

$$\cos(2\pi f_0 t) \leftrightarrow \frac{1}{2}\delta(f-f_0) + \frac{1}{2}\delta(f+f_0)$$

A two-step procedure is required in order to determine the Fourier transform of a periodic signal. If $x(t)$ is a periodic signal with period T , then $x(t)$ can be Fourier series expanded as

$$x(t) = \sum_{k=-\infty}^{\infty} c_k e^{j2\pi k f_0 t}, \quad f_0 = \frac{1}{T} \quad (23.25)$$

Applying the linearity property to this equation gives

$$X(f) = \sum_{k=-\infty}^{\infty} c_k \delta(f - k f_0) \quad (23.26)$$

as the Fourier transform of any periodic signal $x(t)$. Eq. (23.26) explains the difference between the frequency spectrum produced by the Fourier series analysis and the amplitude spectral density produced by the Fourier transformation. Thus, the frequency spectrum is a (discrete) display of c_k versus $k f_0$, whereas

TABLE 23.5 Properties of the Fourier Transform

| Property | Signal Description | Fourier Transform |
|---------------------------|---|---|
| Linearity | $ax(t) + by(t)$; a, b constants | $aX(f) + bY(f)$ |
| Evenness and oddness | $x(-t) = x(t)$ $x(-t) = -x(t)$ | $X(f) = 2 \int_0^{\infty} x(t) \cos(2\pi ft) dt$ $X(f) = -2 \int_0^{\infty} x(t) \sin(2\pi ft) dt$ |
| Time shift | $x(t - \tau)$ | $e^{-j2\pi f\tau} X(f)$ |
| Time scale | $x(at)$ | $\frac{1}{ a } X\left(\frac{f}{a}\right)$ |
| Time reversal | $x(-t)$ | $X^*(f)$ |
| Duality | $X(t)$ | $x(-f)$ |
| Time convolution | $x(t) * y(t)$ | $X(f) Y(f)$ |
| Frequency convolution | $x(t) y(t)$ | $X(f) * Y(f)$ |
| Modulation | $x(t)e^{j2\pi f_0 t}$ | $X(f - f_0)$ |
| Time differentiation | $\frac{d^n}{dt^n} x(t)$ | $(j2\pi f)^n X(f)$ |
| Frequency differentiation | $t^n x(t)$ | $\left(\frac{j}{2\pi}\right)^n \frac{d^n}{df^n} X(f)$ |
| Integration | $\int_{-\infty}^{\infty} x(\tau) d\tau$ | $\frac{1}{j2\pi f} X(f) + \frac{1}{2} X(0) \delta(f)$ |
| Correlation | $R_{xy}(\tau) = \int_{-\infty}^{\infty} y(t)x(t - \tau) dt$ | $Y(-f) X(f)$ |
| Parseval's theorem | $\int_{-\infty}^{\infty} x(t) ^2 dt$ | $\int_{-\infty}^{\infty} X(f) ^2 df$ |

the amplitude spectral density gives a continuous display of the amplitude density spectrum, which in this case is in the form of impulses, rather than just a number.

Similarly the Fourier transform of a train of impulses of the form

$$p(t) = \sum_{n=-\infty}^{\infty} \delta(t - nT) \tag{23.27}$$

is given by

$$P(f) = \frac{1}{T} \sum_{k=-\infty}^{\infty} \delta(f - kF_s), \quad F_s = \frac{1}{T} \tag{23.28}$$

Energy and Power Spectral Density⁶

Suppose $x(t)$ is an aperiodic signal with a Fourier transform $X(f)$, then its energy is given by

$$E = R_{xx}(0) = \int_{-\infty}^{\infty} |x(t)|^2 dt = \int_{-\infty}^{\infty} |X(f)|^2 df \tag{23.29}$$

This is Parseval's theorem and it shows that the principle of conservation of energy in the time and frequency domains holds. The amplitude spectrum $X(f)$ can be expressed as

$$X(f) = |X(f)| \angle X(f)$$

and denoting

$$S_{xx}(f) = |X(f)|^2$$

then the total energy of the signal is given by

$$E = \int_{-\infty}^{\infty} S_{xx}(f) df \quad (23.30)$$

where $S_{xx}(f)$ represents the distribution of the signal energy as a function of frequency. $S_{xx}(f)$ is termed the energy spectral density for the finite energy signal $x(t)$.

Consider a periodic signal $x(t)$ with an autocorrelation function

$$R_{xx}(\tau) = \lim_{T \rightarrow \infty} \frac{1}{T} \int_{-T/2}^{T/2} x(t)x^*(t - \tau) dt$$

Then,

$$R_{xx}(0) = \lim_{T \rightarrow \infty} \frac{1}{T} \int_{-T/2}^{T/2} |x(t)|^2 dt \quad (23.31)$$

which equals the signal power. Following the same procedure for energy signals, we define $S_{xx}(f)$ as the Fourier transform of $R_{xx}(\tau)$ so that

$$P = R_{xx}(0) = \int_{-\infty}^{\infty} S_{xx}(f) df \quad (23.32)$$

and $S_{xx}(f)$ is termed the power spectral density of the periodic signal $x(t)$.

The need to analyze stationary random signals also arises in many practical situations. The properties of such signals can be inferred from their correlation functions. For example the autocorrelation function, $\phi_{xx}(\tau)$ of a stationary random signal decreases and goes to zero as τ increases since the events become uncorrelated for a large separation of time. Hence, $\phi_{xx}(\tau) = \phi_{xx}(-\tau)$ and its Fourier transform exists. Consequently we can write

$$\phi_{xx}(0) = \int_{-\infty}^{\infty} \Gamma_{xx}(f) df \quad (23.33)$$

where $\Gamma_{xx}(f)$ and $\phi_{xx}(0)$ represent, respectively, the power spectral density and the average power of a random process.

Sampled Continuous-Time Signals

Discrete-time (DT) signals arise either naturally or by sampling continuous-time (CT) signals; however, the latter form is more often encountered in practice. In this case, a digital signal is formed from a CT signal through the process of analog-to-digital conversion. The first part of this process is the sampling of the analog signal, that is, the conversion of $x(t)$ into $x(nT_s)$, where T_s is the sampling period and its reciprocal, $F_s = 1/T_s$, is the sampling frequency in samples per second. The sampling frequency must be appropriately selected to avoid spectral distortion (aliasing), thereby ensuring that $x(t)$ can be reconstructed from its samples. To gain a good understanding of this procedure the sampling process is examined in the frequency domain.

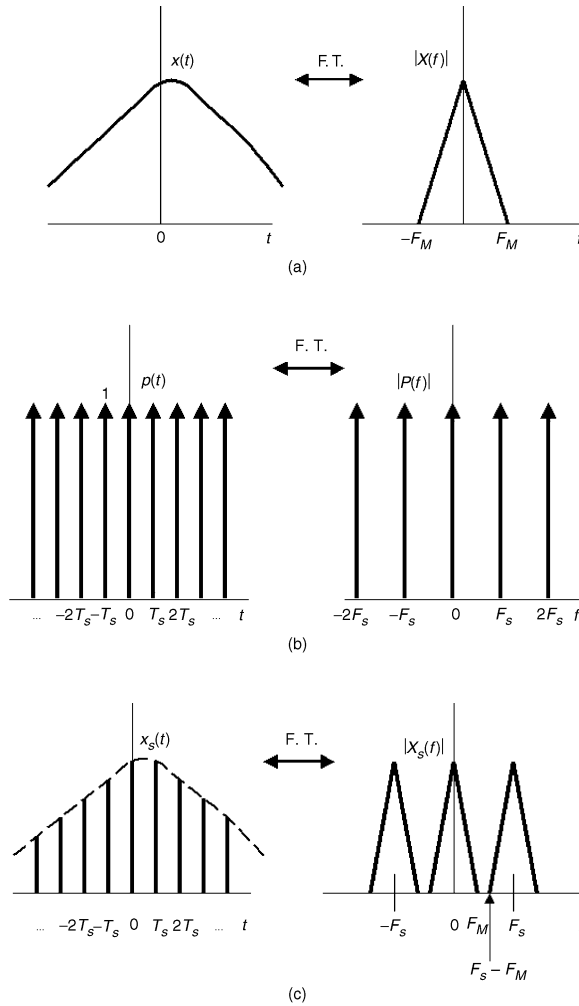

FIGURE 23.9 Ideal impulse sampling process: (a) bandlimited continuous-time signal and its Fourier transform, (b) train of impulses and its spectra, (c) sampled signal and its spectra.

Impulse Sampling⁶⁻⁹

Consider an idealized impulse-sampling process shown in Fig. 23.9, where $x(t)$ is to be sampled using the train of impulses $p(t)$, so that

$$x_s(t) = x(t)p(t) = x(t) \sum_{n=-\infty}^{\infty} \delta(t - nT_s) = \sum_{n=-\infty}^{\infty} x(nT_s) \delta(t - nT_s) \quad (23.34)$$

The main difference between $x_s(t)$ and $x(nT_s)$ is that the former is essentially a CT signal with zero values except at the integer values of T_s , while the latter is a perfectly selected sample of $x(t)$ as a result of impulse sampling.

The Fourier transform of Eq. (23.34) yields

$$X_s(f) = X(f) * P(f) = F_s \sum_{k=-\infty}^{\infty} X(f - F_s) \quad (23.33)$$

where $X(f)$ is the spectrum of $x(t)$.

It is observed that $X_s(f)$ consists of a scaled and periodically repeated version of $X(f)$ with period F_s . As shown in Fig. 23.9(c), it is obvious that when $F_s - F_M \geq F_M$, there is no overlapping of the spectra and the signal $x(t)$ can be recovered completely from $x_s(t)$. However, if $F_s - F_M < F_M$ the replicas of $X(f)$ will overlap, resulting in a distorted spectrum and as such, $x(t)$ can no longer be recovered from its sampled version. Consequently, in order to recover $x(t)$ from its samples, the sampling frequency should be such that

$$F_s - F_M \geq F_M$$

that is,

$$F_s \geq 2F_M$$

This is called the Nyquist sampling theorem. The minimum sampling frequency $F_s = 2F_M$ is called the Nyquist frequency. Sampling a signal at less than the Nyquist frequency results in a spectral distortion termed aliasing. Furthermore, sampling a signal at a frequency of at least Nyquist frequency implies that an ideal low-pass filter (LPF) with a gain of $1/F_s$ and cutoff frequency F_c can be used to recover its original spectrum, where $F_M \leq F_c \leq F_s - F_M$.

Suppose we want to reconstruct $x(t)$ from its samples. Assume that $X(f)$ is the spectrum of $x(nT_s)$, with no aliasing, as shown in Fig. 23.9(c). Thus,

$$X_a(f) = \begin{cases} \frac{1}{F_s} X(f), & |f| \leq \frac{F_s}{2} \\ 0, & |f| > \frac{F_s}{2} \end{cases} \quad (23.36)$$

Note that

$$X_a(f) = \sum_{n=-\infty}^{\infty} x(nT_s) e^{-j2\pi n f T_s} \quad (23.37)$$

so that its inverse Fourier transform is given by

$$\begin{aligned} x_a(t) &= \frac{1}{F_s} \sum_{n=-\infty}^{\infty} x(nT_s) \int_{-F_s/2}^{F_s/2} e^{j2\pi f(t-nT_s)} df \\ &= \sum_{n=-\infty}^{\infty} x(nT_s) \frac{\sin[\pi(t-nT_s)/T_s]}{\pi(t-nT_s)/T_s} \end{aligned} \quad (23.38)$$

This is the formula for the reconstruction of $x(t)$ from its samples. That is, $x(t)$ is generated by multiplying the appropriately shifted function $g(t) = \text{sinc}(tF_s)$ by the corresponding samples of $x(nT_s)$.

Practical Sampling⁸⁻¹⁰

The above discussion on sampling is based on the idealized models of periodic impulse sampling and bandlimited interpolation. In practice, CT signals are not precisely bandlimited just as impulse signals and ideal low-pass filters do not exist physically. Figure 23.10 represents the block diagram for the conversion of continuous signals into their discrete forms. The continuous-time signal is prefiltered, sampled, quantized, and finally encoded into finite-length words of, say, b bits. The prefilter, which is also called anti-aliasing filter (AAF), is a low-pass filter that is needed to limit the input signal bandwidth to $F_s/2$ prior to sampling to avoid aliasing. In practice this filter will possess non-ideal characteristics, hence

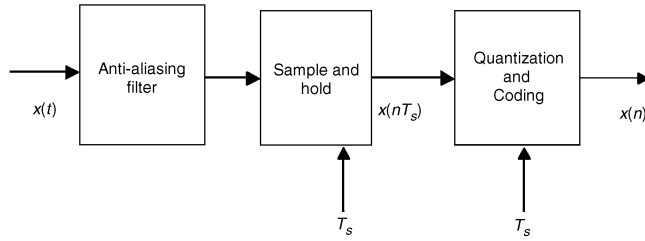

FIGURE 23.10 Practical sampling of continuous-time signals.

it should be designed to provide sufficient attenuation, usually to a level undetectable by the analog-to-digital converter (ADC) at frequencies above the Nyquist frequency.

The prefiltered signal is fed into the ADC where it will be converted to a DT signal. The ADC has an in-built sample-and-hold circuit and it operates at the sampling rate of F_s ; however, the sampling function has a finite width as opposed to the impulse sampling discussed above. The sampling operation can be modeled by the finite-width pulse sampler shown in Fig. 23.11(b), in which the sampling gate is open for τ out of T_s seconds and shorted to ground the remainder of the sampling interval. Here $p(t)$ is expressed as

$$p(t) = \sum_{n=-\infty}^{\infty} \Pi\left(\frac{t - nT_s}{\tau}\right)$$

which can be Fourier series expanded as

$$p(t) = \sum_{k=-\infty}^{\infty} c_k e^{j2\pi k f_s t}$$

where

$$c_k = \frac{\tau}{T_s} \text{sinc}\left(k \frac{\tau}{T_s}\right)$$

The Fourier transform of the sampled signal can be written as

$$X_s(f) = \sum_{k=-\infty}^{\infty} c_k X(f - kF_s)$$

Note that c_k is not constant in this expression (as opposed to the impulse sampling) since its value depends on the harmonic number (k) as well as the duty cycle τ/T_s . The discrete-time signal, $x(nT_s)$, is fed into the quantizer where each sample is transformed into one of the nearest finite sets of prescribed values, that is, $\hat{x}(n) = Q(x(nT_s))$, where $\hat{x}(n)$ is the quantized sample. The quantization process is shown in Fig. 23.11(d) for zero-order sample hold ADC, where L_i denotes the quantization level and Δ is the quantization step. The quantization error (or noise) incurred in this process is

$$L_i - \frac{\Delta}{2} < x(nT_s) < L_i + \frac{\Delta}{2}$$

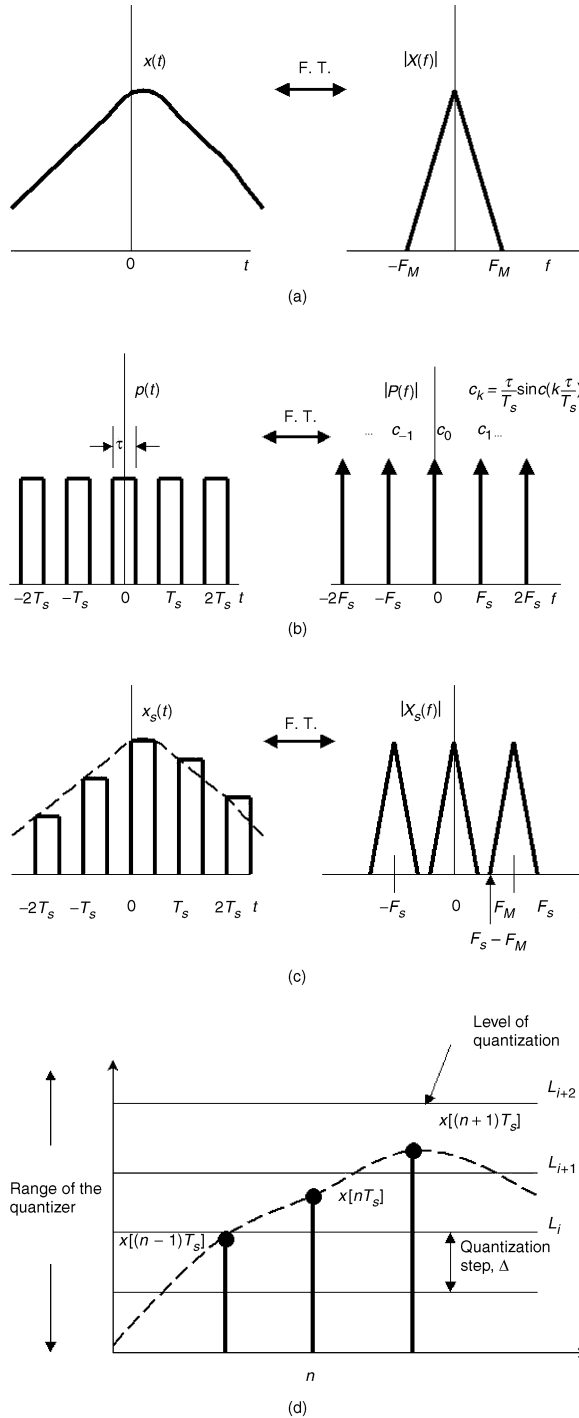

FIGURE 23.11 Finite-width pulse sampling signals and spectra: (a) bandlimited signal and spectrum, (b) finite-width train of pulses and its transform, (c) sampled signal and its spectra, (d) quantization process.

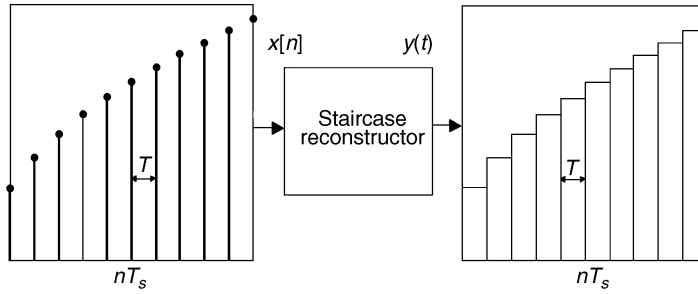

FIGURE 23.12 Digital-to-analog conversion process.

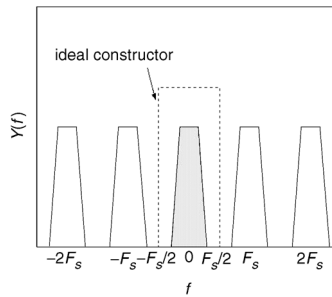

FIGURE 23.13 Frequency response of the ideal reconstruction filter.

From statistical considerations, the noise power is found to be $\Delta^2/12$ watts. A common measure of the performance of the ADC is the ratio of the signal power to noise power, and this is called the signal-to-quantization noise power, which expressed in decibels (dB) is

$$\text{SQNR}(\text{dB}) = 1.76 + 6.02b$$

Digital-to-Analog Conversion⁸⁻¹²

Reconstruction of the analog signal from its sampled form is closely akin to lowpass filtering of the sampled signal. Figure 23.12 shows how an analog signal can be reconstructed by filling the gaps between samples and holding the current value constant till the next sample is received. Consider an ideal reconstruction filter with an impulse response function $h(t)$, then its response is given by

$$y(t) = \sum_{n=-\infty}^{\infty} x(nT_s)h(t - nT_s)$$

Taking the Fourier transform of this equation gives

$$Y(f) = H(f)X(f)$$

where $X(f)$ is the periodic spectrum of $x(nT_s)$ as shown in Fig. 23.13 and $h(t) = \text{sinc}(F_s t)$. Note that $h(t)$ is noncausal; hence it cannot be used for real-time applications. Furthermore, since $h(t)$ is not time-limited, an infinite number of impulse responses must be used for interpolating between values in order to obtain exact results. Consequently, alternative reconstruction filters such as zero-order hold (staircase), first-order, or fractional-order holds are used in practice. However, the staircase reconstruction filter is, by and large, the simplest and most widely used in practice. The impulse response of this filter is given

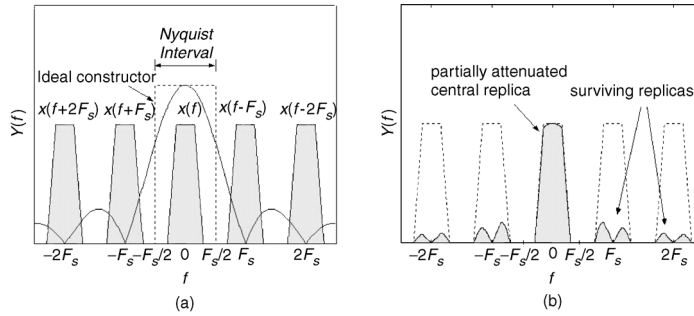

FIGURE 23.14 (a) Staircase reconstruction in frequency domain, (b) Result of staircase reconstruction in frequency domain.

as $h_o(t) = u(t) - u(t - T_s)$ since it must have a duration of T_s seconds to fill the entire gap between the samples. Thus, in effect this filter, as its name implies, generates a staircase approximation to the original analog signal. The frequency response of the filter is

$$H_o(f) = T \frac{\sin(\pi f T_s)}{\pi f T_s} e^{-j\pi f T_s}$$

Though the output of the staircase reconstruction filter is smoother than its sampled form, see Fig. 23.14(a), it contains spurious high-frequency components due to the sudden jumps in the staircase levels as different sampled values are considered. In addition, holding each of $x(nT_s)$ by T_s seconds introduces a time shift of $T_s/2$ to the output signal. However, this time delay has virtually no effect on the quality of the output signal. Figure 23.14(b) compares the signal spectra before and after the staircase reconstruction filter. It is noted that the output spectrum is slightly distorted due to non-ideal characteristics of $H_o(f)$ and that distorted and attenuated versions of $X(f)$ remain centered at nonzero multiples of F_s . These remaining spectral replicas may be removed by using an anti-imaging filter.^{8,11,12} In essence, the anti-imaging filter smoothens out the discontinuities produced by the staircase reconstruction filter as illustrated in Fig. 23.15.

Frequency Analysis of Discrete-Time Signals

The analysis of discrete-time (DT) signals in the frequency domain is very much similar to that of continuous-time (CT) signals. As in the CT analysis, the techniques for the analysis depend on the type of signal. Analysis of aperiodic DT signals will be considered first.

Discrete-Time Fourier Transform⁶⁻⁸

The decomposition of an aperiodic DT signal into its frequency components is carried out using discrete-time Fourier transformation (DTFT). Thus, the DTFT of $x(n)$ is given by

$$X(f) = \sum_{n=-\infty}^{\infty} x(n) e^{-j2\pi f n} \quad (23.39)$$

Unlike the Fourier transform of analog signal, $X(f)$ is periodic with period F_s ; hence, the frequency range for a DT signal is unique over the frequency interval $(-F_s/2, F_s/2)$ or, equivalently $(0, F_s)$. Note that Eq. (23.39) must be absolutely summable in order for $X(f)$ to exist, that is,

$$\sum_{n=-\infty}^{\infty} |x(n)| < \infty$$

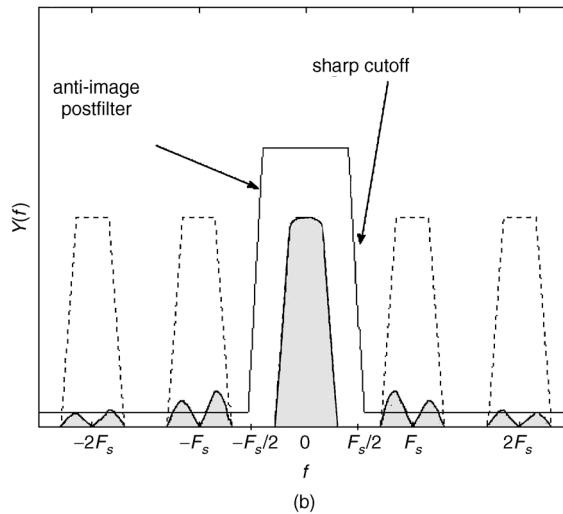
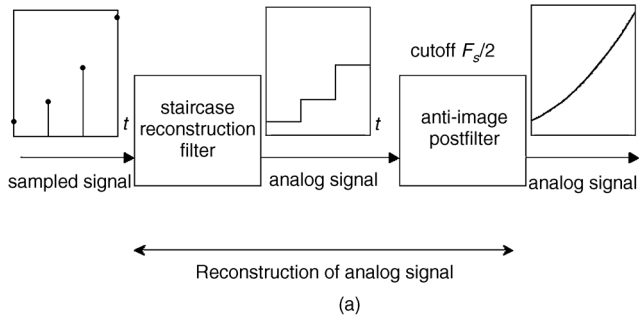

FIGURE 23.15 (a) Reconstruction of analog signal, (b) effect of anti-image postfiltering.

If the spectrum of a signal exists, then we can find the signal from its spectrum through the inverse DTFT. The inverse DTFT of $X(f)$ is given as

$$x(n) = \frac{1}{F_s} \int_{-F_s/2}^{F_s/2} X(f) e^{j2\pi fn} df$$

The properties of the DTFT of a DT signal are shown in Table 23.6.

For DT signals, the convolution of two sequences $x(n)$ and $y(n)$ is expressed as

$$x(n) * y(n) = \sum_{m=-\infty}^{\infty} x(m) y(n-m) \tag{23.40}$$

while the cross-correlation function of $x(n)$ and $y(n)$ is given by

$$R_{xy}(n) = x(n) \oplus y(n) = \sum_{m=-\infty}^{\infty} x(m) y^*(m-n)$$

When $x(n) = y(n)$, then the autocorrelation of $x(n)$ is

$$R_{xx}(n) = \sum_{m=-\infty}^{\infty} x(m) x^*(m-n)$$

TABLE 23.6 Properties of DTFT

| Property | Signal Description | Frequency Domain |
|---|--|---|
| Even symmetry (real signal) | $x_e(n) = \frac{1}{2}\{x(n) + x(-n)\}$ | $X_e(f) = \sum_{n=-\infty}^{\infty} x_e(n) \cos(2\pi n f)$ |
| Odd symmetry (real signal) | $x_o(n) = \frac{1}{2}\{x(n) - x(-n)\}$ | $X_o(f) = -\sum_{n=-\infty}^{\infty} x_o(n) \sin(2\pi n f)$ |
| Linearity | $ax(n) + by(n)$ | $aX(f) + bY(f)$ |
| Time shifting | $x(n - m)$ | $e^{-j2\pi f m} X(f)$ |
| Time reversal | $x(-n)$ | $X(-f)$ |
| Convolution | $x(n) * y(n)$ | $X(f)Y(f)$ |
| Correlation | $R_{xy}(n) = x(n) \oplus y(n)$ | $S_{xy}(f) = X(f)Y(-f)$ |
| Wiener–Khintchine theorem | $R_{xx}(n)$ | $S_{xx}(f)$ |
| Frequency shifting | $e^{j2\pi f_0 n} x(n)$ | $X(f - f_0)$ |
| Modulation | $x(n) \cos(2\pi n f_0)$ | $\frac{1}{2}\{X(f + f_0) + X(f - f_0)\}$ |
| Multiplication | $x(n)y(n)$ | $\frac{1}{F_s} \int_{F_s} X(\lambda)Y(f - \lambda) d\lambda$ |
| Differentiation in the frequency domain | $nx(n)$ | $\frac{j}{2\pi} \frac{dX(f)}{df}$ |
| Time differencing | $x(n) - x(n - 1)$ | $(1 - e^{-j2\pi f})X(f)$ |
| Summation | $\sum_{m=-\infty}^n x(m)$ | $\frac{X(f)}{(1 - e^{-j2\pi f})} + \frac{F_s X(0)}{2} \sum_{m=-\infty}^{\infty} \delta(f - mF_s)$ |
| Conjugation | $x^*(n)$ | $X^*(-f)$ |
| Parseval’s theorem | $\sum_{n=-\infty}^{\infty} x(n)y^*(n)$ | $\frac{1}{F_s} \int_{F_s} X(f)Y^*(f) df$ |

With the exception of the reflection operation (for the convolution), the procedures for computing the convolution and correlation are the same. Hence, it is more computationally efficient to use the same algorithm for evaluating both functions. To achieve this, one of the sequences is reflected (only for the correlation analysis), followed by convolution operation, that is,

$$R_{xy}(n) = x(n) * y^*(-n)$$

and

$$R_{xx}(n) = x(n) * x^*(-n)$$

The energy of an aperiodic signal is computed from

$$E = \sum_{n=-\infty}^{\infty} |x(n)|^2 = \sum_{n=-\infty}^{\infty} x(n)x^*(n)$$

Substituting the conjugated form of (23.40) into this equation gives

$$E = \frac{1}{F_s} \int_{F_s} |X(f)|^2 df = \frac{1}{F_s} \int_{F_s} S_{xx}(f) df \tag{23.41}$$

This expression relates the distribution of the energy of an aperiodic signal to frequency. The quantity $|X(f)|^2$ is called the energy spectral density of $x(n)$. The DTFT of some commonly encountered signals are shown in [Table 23.7](#).

TABLE 23.7 DTFT of Common DT Signals

| $x(n)$ | Frequency-Domain Representation, $X(f)$ |
|-----------------------------------|--|
| $\delta(n)$ | 1 |
| $A, -\infty < n < \infty$ | $AF_s \sum_{k=-\infty}^{\infty} \delta(f - mF_s), F_s = \frac{1}{T}$ |
| $u(n)$ | $\frac{1}{1 - e^{-j2\pi f}} + \frac{F_s}{2} \sum_{k=-\infty}^{\infty} \delta(f - kF_s)$ |
| $\Pi\left(\frac{n}{2q+1}\right)$ | $\frac{\sin[(2q+1)\pi f]}{\sin(\pi f)}$ |
| $\Lambda\left(\frac{n}{q}\right)$ | $\frac{\sin^2(\pi f q)}{q \sin^2(\pi f)}$ |
| $\text{sgn}(n)$ | $\frac{2}{1 - e^{-j2\pi f}}$ |
| $\alpha^n u(n)$ | $\frac{1}{1 - \alpha e^{-j2\pi f}}, \alpha < 1$ |
| $\alpha^{ n }$ | $\frac{1 - \alpha^2}{1 - 2\alpha \cos(2\pi f) + \alpha^2}, \alpha < 1$ |
| $n\alpha^n u(n)$ | $\frac{\alpha e^{-j2\pi f}}{(1 - \alpha e^{-j2\pi f})^2}, \alpha < 1$ |
| $e^{-\alpha n} u(n)$ | $\frac{1}{1 - e^{-(\alpha + j2\pi f)}}, \alpha > 0$ |
| $e^{-\alpha n }$ | $\frac{1 - e^{-2\alpha}}{1 - 2e^{-\alpha} \cos(2\pi f) + e^{-2\alpha}}, \alpha > 0$ |
| $e^{j2\pi f_0 n}$ | $F_s \sum_{k=-\infty}^{\infty} \delta(f - f_0 + kF_s)$ |
| $\cos(2\pi f_0 n + \theta)$ | $\frac{F_s}{2} \sum_{k=-\infty}^{\infty} \{e^{j\theta} \delta(f - f_0 + kF_s) + e^{-j\theta} \delta(f + f_0 + kF_s)\}$ |
| $\frac{\sin(2\pi f_c n)}{\pi n}$ | $\Pi\left(\frac{f}{2f_c}\right)$ |

Discrete Fourier Series⁶⁻⁸

Suppose $x(n)$ is a periodic DT signal with period N , then it is possible to obtain its discrete Fourier series (DFS) expansion in a manner analogous to the computation of the complex Fourier series for the CT signals. The orthogonal basis function for the DFS is $W_N^{-n} = e^{j2\pi n/N}$ so that the decomposition of $x(n)$ into a sum of N harmonically related complex exponentials is expressed as

$$x(n) = \sum_{k=0}^{N-1} c_k e^{j2\pi kn/N} = \sum_{k=0}^{N-1} c_k W_N^{-kn} \quad (23.42)$$

where c_k represents the discrete Fourier series coefficients. Multiplying both sides of (23.42) by W_N^{mn} , summing over one period, and using the fact that

$$\sum_{k=0}^{N-1} W_N^{n(k-m)} = \begin{cases} N, & k = m \\ 0, & k \neq m \end{cases}$$

TABLE 23.8 Properties of the Discrete Fourier Series

| Property | Signal Description | Discrete Fourier Series Coefficients |
|-------------------------------|-------------------------------|--------------------------------------|
| Linearity | $\sum_{m=0}^Q \beta_m x_m(n)$ | $\sum_{m=0}^Q \beta_m c_{m,k}$ |
| Time shift | $x(n - m)$ | $c_k W_N^{km}$ |
| Time-reversal | $x(-n)$ | c_{-k} |
| Modulation | $x(n) W_N^{-mn}$ | c_{k-m} |
| Real $x(n)$ | $x(n)$ | $c_k = c_k^*$ |
| $x_e(n)$ is an even DT signal | $x_e(n)$ | $\text{Re}\{c_k\}$ |
| $x_o(n)$ is an odd DT signal | $x_o(n)$ | $j\{\text{Im}\{c_k\}\}$ |

results in

$$c_k = \frac{1}{N} \sum_{n=0}^{N-1} x(n) W_N^{kn}, \quad k = 0, 1, 2, \dots, N-1 \quad (23.43)$$

The DFS coefficients $\{c_k\}$ provide the description of $x(n)$ in the frequency domain since c_k represents the amplitude and phase spectra associated with the k th harmonic component. Note that $\{c_k\}$ is a periodic sequence with fundamental period N , that is, $c_k = c_{k+N}$. Hence, any N consecutive samples of the signal or its DFS coefficients provide a complete description of the signal in the time or frequency domains. As shown in Table 23.8, the properties of the DFS follow closely those given for the DTFT. One of the main advantages of DFS over the DTFT is the replacement of the infinite summation in the DTFT by a finite sum in the DFS, thus allowing the computations of DFS and inverse DFS by digital computers.

Consider a periodic DT signal with period N , then its average power is

$$P = \frac{1}{N} \sum_{n=0}^{N-1} |x(n)|^2 \quad (23.44)$$

Using Eq. (23.42) in (23.44) gives

$$P = \frac{1}{N} \sum_{n=0}^{N-1} x(n)x^*(n) = \frac{1}{N} \sum_{n=0}^{N-1} x(n) \left(\sum_{k=0}^{N-1} c_k^* W_N^{kn} \right) = \sum_{k=0}^{N-1} |c_k|^2 \quad (23.45)$$

This is a Parseval's relation for the DT periodic signals, which indicates that the average power in $x(n)$ is the sum of the harmonics power. Consequently, the sequence $|c_k|^2$ is the power spectral density as this represents the distribution of power as a function of frequency.

The Discrete Fourier Transform^{6,8,13}

The discrete Fourier transform (DFT) is an important and extremely powerful technique for analyzing DT signals. Contrary to the DTFT, the DFT is applicable to finite-length sequences and it produces finite-length discrete spectra. Consequently, this transformation is amenable to digital computations and it is suitable for use in digital hardware implementations. As a result of its practicability, DFT has become a very useful tool for analyzing various waveforms or data that arise in many disciplines.

The DFT is a mapping of an N sample sequence, $x(n)$, into another N sequence $X(k)$ in the frequency domain, that is,

$$X(k) = \sum_{n=0}^{N-1} x(n) W_N^{kn}, \quad k = 0, 1, \dots, N-1 \quad (23.46)$$

TABLE 23.9 Properties of DFT

| Property | Signal Description | Discrete Fourier Transform |
|--------------------------|--|---|
| Linearity | $\sum_{m=0}^Q a_m x_m(n)$ | $\sum_{m=0}^Q a_m X_m(k)$ |
| Circular shift | $x[(n - m) \bmod N]$ | $W_N^{km} X(k)$ |
| Modulation | $W_N^{-qn} x(n)$ | $X[(k - q) \bmod N]$ |
| Time reversal | $x^*[-n \bmod N]$ | $x^*(k)$ |
| Complex conjugation | $x^*(n)$ | $X^*[-k \bmod N]$ |
| Circular convolution | $\sum_{m=0}^{N-1} x(m)y[(n - m) \bmod N]$ | $X(k)Y(k)$ |
| Multiplication | $x(n)y(n)$ | $\frac{1}{N} \sum_{m=0}^{N-1} X(m)Y[(k - m) \bmod N]$ |
| Parseval's theorem | $\sum_{k=0}^{N-1} x(n)y^*(n)$ | $\frac{1}{N} \sum_{k=0}^{N-1} X(k)Y^*(k)$ |
| Real part of signal | $\text{Re}\{x(n)\}$ | $\frac{1}{2}\{X(k) + X^*(N - k)\}$ |
| Imaginary part of signal | $j \text{Im}\{x(n)\}$ | $\frac{1}{2}\{X(k) - X^*(N - k)\}$ |
| Complex even | $x_{ce}(n) = \frac{1}{2}\{x(n) + x^*(N - n)\}$ | $X_R(k)$ |
| Complex odd | $x_{co}(n) = \frac{1}{2}\{x(n) - x^*(N - n)\}$ | $jX_I(k)$ |
| Any real signal | $x(n)$ | $X(k) = X^*(N - k)$ $X_R(k) = X_R(N - k)$ $X_I(k) = -X_I(N - k)$ $ X(k) = X(N - k) $ $\angle X(k) = -\angle X(N - k)$ |

$X(k)$ is called the k th harmonic and this exists provided all the samples of $x(n)$ are bounded. In order to recover $x(n)$ from $X(k)$ we need to perform inverse transformation. Thus, the inverse discrete Fourier transform (IDFT) of $X(k)$ is defined as

$$x(n) = \frac{1}{N} \sum_{k=0}^{N-1} X(k)W_N^{-kn}, \quad n = 0, 1, \dots, N - 1 \tag{23.47}$$

The DFT and DFS are conceptually different in the sense that the DFS is only applicable to periodic signals whereas DFT assumes that the signal is periodic, that is, there is an inherent windowing of nonperiodic signal if analyzed by the DFT technique. Also the scaling factor is applicable to the synthesis equation for the DFT operation, whereas it is used in the analysis equation in the DFS analysis.

The DFT properties bear strong resemblance to those of the DFS and DTFT as shown in [Table 23.9](#).

The following should be noted in the DFT computation: Circular shift operation can be considered as wrapping the part of the sequence that falls outside of 0 to $N - 1$ to the front of the sequence, that is, $x[(-n) \bmod N]$ is equivalent to $x(N - n)$.

As a result of the circular shift, linear convolution as given by Eq. (23.40) is different from circular convolution given in [Table 23.9](#). Thus,

$$x(n) \otimes_N y(n) = \sum_{m=0}^{N-1} x(m)y[(n - m) \bmod N] = \sum_{m=0}^{N-1} x[(n - m) \bmod N]y(m)$$

where $x[(n - m) \bmod N]$ is the reflected and circularly translated version of $x(n)$. However, by appropriate selecting the value of N , both the circular and linear convolution can be the same. Thus, if signals $x(n)$ and $y(n)$ are of length N_1 and N_2 , respectively, then circular and linear convolution are the same provided $N \geq N_1 + N_2 - 1$.

Circular correlation can be implemented by circular convolution since the cross correlation of the two sequences $x(n)$ and $y(n)$ can be expressed as

$$R_{xy}(n) = x(n) \otimes_N y(n) = x(n) \otimes_N y^* [(-n) \bmod N]$$

From Eqs. (23.46) and (23.47), it is noted that to compute the DFT coefficients would require N^2 complex multiplications and $N(N - 1)$ complex additions. This can be a computational load if N is very large. Fast Fourier transforms (FFTs) are different types of algorithms that have been developed to speed up the computation of the DFT coefficients. Readers can refer to many textbooks where the development of the various forms of the FFT algorithms has been discussed.^{7,8} It can be shown that the number of computations required for the FFT algorithms can be expressed as a constant times $N * \log_2 N$. Consequently, there is a reduction in computation when an FFT algorithm is used for the DFT computation.

Remarks on the DFT Processing of Signals

Zero Padding^{6,8}

The use of FFT for DFT coefficients computation imposes some constraints on the value of N , for example N has to be a power of 2 for radix-2 FFT algorithm. Also, circular convolution is an undesirable solution as it manifests from the IDFT of the product of the transform of two sequences. Zero-padding is a technique for remedying the above situations, that is, the zero-padding is used either to augment the sequence length so that either a radix-2 FFT algorithm can be used or to ensure that both the linear and circular convolution are the same. In addition, this procedure is also used to provide a better-looking display of the signal spectrum since the frequency spacing of the FFT samples decreases as N increases.

Error Sources^{8,10}

The resultant spectrum of a sampled signal comprises the analog spectrum repeated at the integer multiples of the sampling frequency. The overlapping of the analog signal spectrum with its shifted versions causes *aliasing*. In practice, excessive errors due to aliasing are minimized by either increasing the sampling rate or prefiltering the signal to remove the high-frequency spectral components. Another source of error in the DFT processing of signals is the *spectral leakage*. This is caused by using a window to truncate an infinitely long signal to obtain a finite-length data for DFT processing. It is known that windowing the samples of a signal in the time domain transforms to convolution of sampled signal spectrum and the window spectrum in the frequency domain. Suppose the window width does not correspond to an integer multiple of periods of all the frequency components of a discrete-time signal, then a single frequency component will spread (leak) into other frequency locations in the DFT of the truncated data. This phenomenon causes spectral distortion and makes it difficult to determine whether or not two closely adjacent frequencies are present in a signal. Spectral resolution becomes better if the window width is increased, or by choosing a window function with low sidelobes. The *picket-fence effect* arises because only a finite number of frequency points of a continuous-frequency spectrum are produced by the DFT. It is therefore possible to miss the peak of a particular frequency component in a signal because it is located between two adjacent frequency points in the spectrum. Since the frequency spacing $\Delta f = F_s/N$, this problem can be alleviated by increasing N the number of DFT points while maintaining the same sampling rate, implying having more samples in the DFT or a employing zero-padding technique.

DFT Parameter Selection⁶

The sampling period, T_s , frequency resolution (spacing), Δf , and the DFT length, N , are the three parameters that must be specified in performing DFT signal processing. Since $F_s = N\Delta f = 1/T_s$, these parameters are related according to $\Delta f = 1/NT_s$. If T_x denotes the length of the sampled data, then $T_x = MT_s$. Thus, there is

no spectral distortion if $N \geq M = T_x/T_s$. Equivalently, there will be no spectral distortion if

$$\Delta f = \frac{1}{T} = \frac{1}{NT_s} \leq \frac{1}{MT_s} = \frac{1}{T_x}$$

Parameters for the DFT processing of a sampled continuous signal must be carefully selected to avoid spectral distortion due to aliasing or data truncation. Assuming a window width of T_x seconds and that the signal has a maximum bandwidth of B hertz, then based on the sampling theorem we would have negligible aliasing, provided $F_s = 1/T_s \geq 2B$. Spectral leakage due to sharp data truncation is avoided provided the frequency resolution is selected to satisfy $1/\Delta f = T \geq T_x$. Consequently, spectral distortion due to aliasing and spectral leakage can be avoided if the length of the DFT is selected to satisfy $N = F_s/\Delta f \geq 2BT_x$.

References

1. Soliman, S.S., and Srinath, M.D., *Continuous and Discrete Signals and Systems*, Prentice-Hall, 1998.
2. O'Flynn, M., and Moriarty, E., *Linear Systems: Time Domain and Transform Analysis*, Wiley, 1987.
3. Lathi, B.P., *Modern Digital and Analog Communication Systems*, Oxford University Press, Third Edition, 1998.
4. Proakis, J.G., and Salehi, M., *Communication Systems Engineering*, Prentice-Hall, 1994.
5. Taylor, F.J., *Principles of Signals and Systems*, McGraw-Hill, 1994.
6. Carlson, G.E., *Signal and Linear System Analysis*, Wiley, Second Edition, 1998.
7. Proakis, J.G., and Manolakis, D.G., *Digital Signal Processing: Principles, Algorithms, and Applications*, Prentice-Hall, 1996.
8. Oppenheim, A.V., and Schaffer, R.W., with Buck, J.R., *Discrete-Time Signal Processing*, Prentice-Hall, Second Edition, 1999.
9. Houts, R.C., *Signal Analysis in Linear Systems*, Saunders College Publishing, 1991.
10. Ziemer, R.E., Tranter, W.H., and Fannin, D.R., *Signals and Systems: Continuous and Discrete*, MacMillan Publishing Company, Third Edition, 1993.
11. Orfanidis, S.J., *Introduction to Signal Processing*, Prentice-Hall, 1996.
12. Haykin, S., and Veen, B.V., *Signals and Systems*, Wiley, 1999.
13. Taylor, F., and Mellot, J., *Hands-On Digital Signal Processing*, McGraw-Hill, 1998.

23.2 z Transform and Digital Systems

Rolf Johansson

A digital system (or discrete-time system or sampled-data system) is a device such as a digital controller or a digital filter or, more generally, a system intended for digital computer implementation and usually with some periodic interaction with the environment and with a supporting methodology for analysis and design. Of particular importance for modeling and analysis are recurrent algorithms—for example, difference equations in input–output data—and the z transform is important for the solution of such problems.

The z transform is being used in the analysis of linear time-invariant systems and discrete time signals—for example, for digital control or filtering—and may be compared to the Laplace transform as used in the analysis of continuous-time signals and systems, a useful property being that the convolution of two time-domain signals is equivalent to multiplication of their corresponding z transforms. The z transform is important as a means to characterize a linear time-invariant system in terms of its pole–zero locations, its transfer function and Bode diagram, and its response to a large variety of signals. In addition, it provides important relationships between temporal and spectral properties of signals. The z transform generally appears in the analysis of difference equations as used in many branches of engineering and applied mathematics.

The z Transform

The z transform of the sequence $\{x_k\}_{-\infty}^{+\infty}$ is defined as the generating function

$$X(z) = \mathcal{Z}\{x\} = \sum_{k=-\infty}^{\infty} x_k z^{-k} \quad (23.48)$$

where the variable z has the essential interpretation of a forward shift operator so that

$$\mathcal{Z}\{x_{k+1}\} = z\mathcal{Z}\{x_k\} = zX(z) \quad (23.49)$$

The z transform is an infinite power series in the complex variable z^{-1} where $\{x_k\}$ constitutes a sequence of coefficients. As the z transform is an infinite power series, it exists only for those values of z for which this series converges and the *region of convergence* of $X(z)$ is the set of z for which $X(z)$ takes on a finite value. A sufficient condition for existence of the z transform is convergence of the power series

$$\sum_{k=-\infty}^{\infty} |x_k| \cdot |z^{-k}| < \infty \quad (23.50)$$

The region of convergence for a finite-duration signal is the entire z plane except $z = 0$ and $z = \infty$. For a one-sided infinite-duration sequence $\{x_k\}_{k=0}^{\infty}$, a number r can usually be found so that the power series converges for $|z| > r$. Then, the *inverse z transform* can be derived as

$$x_k = \frac{1}{2\pi i} \oint X(z) z^{k-1} dz \quad (23.51)$$

where the contour of integration encloses all singularities of $X(z)$. In practice, it is standard procedure to use tabulated results; some standard z transform pairs are to be found in [Table 23.10](#).

Digital Systems and Discretized Data

Periodic sampling of signals and subsequent computation or storing of the results requires the computer to schedule sampling and to handle the resulting sequences of numbers. A measured variable $x(t)$ may be available only as periodic observations of $x(t)$ as sampled with a time interval T (the sampling period). The sample sequence can be represented as

$$\{x_k\}_{-\infty}^{\infty}, \quad x_k = x(kT) \quad \text{for } k = \dots, -1, 0, 1, 2, \dots \quad (23.52)$$

and it is important to ascertain that the sample sequence adequately represents the original variable $x(t)$; see [Fig. 23.16](#). For ideal sampling it is required that the duration of each sampling be very short and the sampled function may be represented by a sequence of infinitely short impulses $\delta(t)$ (the Dirac impulse). Let the sampled function of time be expressed thus:

$$x_{\Delta}(t) = x(t) \cdot T \sum_{k=-\infty}^{\infty} \delta(t - kT) = x(t) \cdot \text{I} \text{I} \text{I}_T(t) \quad (23.53)$$

where

$$\text{I} \text{I} \text{I}_T(t) \triangleq T \sum_{k=-\infty}^{\infty} \delta(t - kT) \quad (23.54)$$

TABLE 23.10 Properties of the z Transform

| | |
|----------------|--|
| z transform | $\mathcal{Z}\{f_k\} = F(z)$ |
| Convolution | $\mathcal{Z}\{f_k * g_k\} = \mathcal{Z}\{f_k\} \cdot \mathcal{Z}\{g_k\}$ $\mathcal{Z}\{f_k \cdot g_k\} = \mathcal{Z}\{f_k\} * \mathcal{Z}\{g_k\}$ |
| Forward shift | $\mathcal{Z}\{f_{k+1}\} = z\mathcal{Z}\{f_k\} = zF(z)$ |
| Backward shift | $\mathcal{Z}\{f_{k-1}\} = \mathcal{Z}\{f_k\} = z^{-1}F(z)$ |
| Linearity | $\mathcal{Z}\{af_k + bg_k\} = a\mathcal{Z}\{f_k\} + b\mathcal{Z}\{g_k\}$ |
| Multiplication | $\mathcal{Z}\{af_k\} = F(a^{-1}z)$ |
| Final value | $\lim_{k \rightarrow \infty} f_k = \lim_{z \rightarrow 1} (1 - z^{-1})F(z)$ |
| Initial value | $f_0 = \lim_{z \rightarrow \infty} F(z)$ |
| | Time Domain z Transform |
| Impulse | $\delta_k = \begin{cases} 1, & k = 0 \\ 0, & k \neq 0 \end{cases} \Leftrightarrow \mathcal{Z}\{\delta_k\} = 1, \quad z \in C$ |
| Step function | $\sigma_k = \begin{cases} 0, & k < 0 \\ 1, & k \geq 0 \end{cases} \Leftrightarrow \mathcal{Z}\{\sigma_k\} = \frac{z}{z-1}, \quad z > 1$ |
| Ramp function | $x_k = k \cdot \sigma_k \Leftrightarrow X(z) = \frac{z}{(z-1)^2}, \quad z > 1$ |
| Exponential | $x_k = a^k \cdot \sigma_k \Leftrightarrow X(z) = \frac{z}{z-a}, \quad z > a $ |
| Sinusoid | $x_k = \sin \omega k \cdot \sigma_k \Leftrightarrow X(z) = \frac{z \sin \omega}{z^2 - 2z \cos \omega + 1}, \quad z > 1$ |



FIGURE 23.16 A continuous-time signal $x(t)$ and a sampling device that produces a sample sequence $\{x_k\}$.

and where the sampling period T is multiplied to ensure that the averages over a sampling period of the original variable x and the sampled signal x_Δ , respectively, are of the same magnitude. A direct application of the discretized variable $x_\Delta(t)$ in Eq. (23.53) verifies that the spectrum of x_Δ is related to the z transform $X(z)$ as

$$X_\Delta(i\omega) = \mathcal{F}\{x(t) \cdot \text{III}_T(t)\} = T \sum_{k=-\infty}^{\infty} x_k \exp(-i\omega kT) = TX(e^{i\omega T}) \quad (23.55)$$

Obviously, the original variable $x(t)$ and the sampled data are not identical, and thus it is necessary to consider the distortive effects of discretization. Consider the spectrum of the sampled signal $x_\Delta(t)$ obtained as the Fourier transform

$$X_\Delta(i\omega) = \mathcal{F}\{x_\Delta(t)\} = \mathcal{F}\{x(t)\} * \mathcal{F}\{\text{III}_T(t)\} \quad (23.56)$$

where

$$\mathcal{F}\{\text{III}_T(t)\} = \sum_{k=-\infty}^{\infty} \delta\left(\omega - \frac{2\pi}{T}k\right) = \frac{T}{2\pi} \text{III}_{2\pi/T}(\omega) \quad (23.57)$$

so that

$$X_{\Delta}(i\omega) = \mathcal{F}\{x(t)\} * \mathcal{F}\{\text{III}_T(t)\} = \sum_{k=-\infty}^{\infty} X\left[i\left(\omega - \frac{2\pi}{T}k\right)\right] \quad (23.58)$$

Thus, the Fourier transform X_{Δ} of the sampled variable has a periodic extension of the original spectrum $X(i\omega)$ along the frequency axis with a period equal to the sampling frequency $\omega_s = 2\pi/T$. There is an important result based on this observation known as the *Shannon sampling theorem*, which states that the continuous-time variable $x(t)$ may be reconstructed from the samples $\{x_k\}_{-\infty}^{+\infty}$ if and only if the sampling frequency is at least twice that of the highest frequency for which $X(i\omega)$ is nonzero. The original variable $x(t)$ may thus be recovered as

$$x(t) = \sum_{k=-\infty}^{\infty} x_k \frac{\sin\frac{\pi}{T}(t - kT)}{\frac{\pi}{T}(t - kT)} \quad (23.59)$$

The formula given in Eq. (23.59) is called *Shannon interpolation*, which is often quoted though it is valid only for infinitely long data sequences and would require a noncausal filter to reconstruct the continuous-time signal $x(t)$ in real-time operation. The frequency $\omega_i = \omega_s/2 = \pi/T$ is called the *Nyquist frequency* and indicates the upper limit of distortion-free sampling. A nonzero spectrum beyond this limit leads to interference between the sampling frequency and the sampled signal (*aliasing*); see Fig. 23.17.

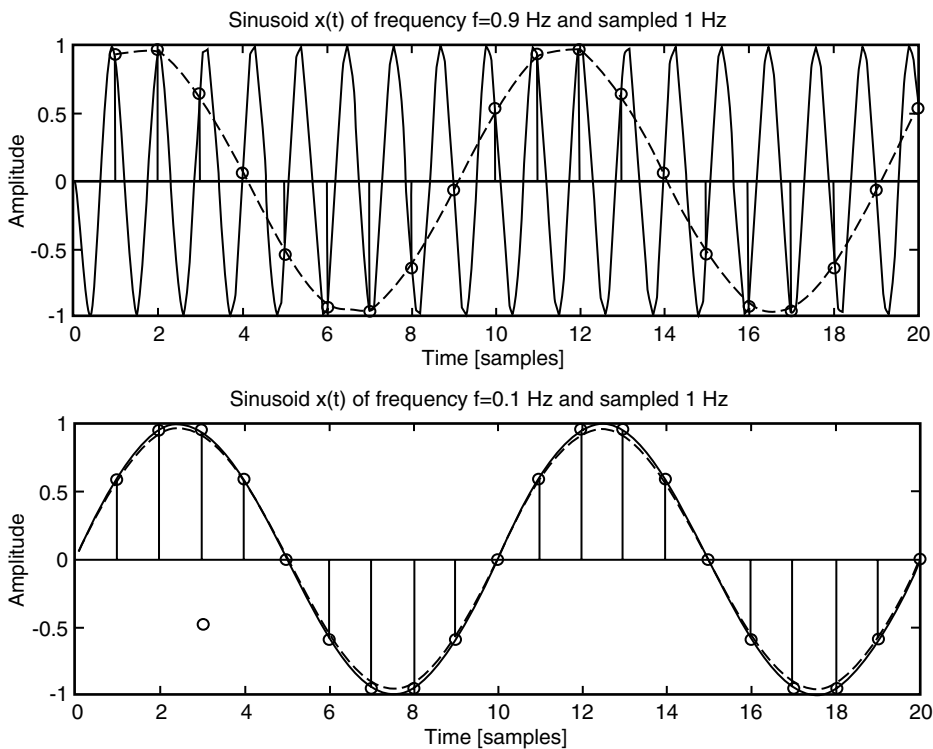

FIGURE 23.17 Illustration of aliasing appearing during sampling of a sinusoid $x(t) = \sin 2\pi \cdot 0.9t$ at the insufficient sampling frequency 1 Hz (sampling period $T = 1$) (*upper graph*). The sampled signal exhibits aliasing with its major component similar to a signal $x(t) = \sin 2\pi \cdot 0.1t$ sampled with the same rate (*lower graph*).

The Discrete Fourier Transform

Consider a finite length sequence $\{x_k\}_{k=0}^{N-1}$ that is zero outside the interval $0 \leq k \leq N-1$. Evaluation of the z transform $X(z)$ at N equally spaced points on the unit circle $z = \exp(i\omega_k T) = \exp[i(2\pi/NT)kT]$ for $k = 0, 1, \dots, N-1$ defines the *discrete Fourier transform* (DFT) of a signal x with a sampling period h and N measurements:

$$X_k = \text{DFT}\{x(kT)\} = \sum_{l=0}^{N-1} x_l \exp(-i\omega_k lT) = X(e^{i\omega_k T}) \quad (23.60)$$

Notice that the discrete Fourier transform $\{X_k\}_{k=0}^{N-1}$ is only defined at the discrete frequency points

$$\omega_k = \frac{2\pi}{NT}k, \quad \text{for } k = 0, 1, \dots, N-1 \quad (23.61)$$

In fact, the discrete Fourier transform adapts the Fourier transform and the z transform to the practical requirements of finite measurements. Similar properties hold for the discrete Laplace transform with $z = \exp(sT)$, where s is the Laplace transform variable.

The Transfer Function

Consider the following discrete-time linear system with input sequence $\{u_k\}$ (stimulus) and output sequence $\{y_k\}$ (response). The dependency of the output of a linear system is characterized by the convolution-type equation and its z transform,

$$y_k = \sum_{m=0}^{\infty} h_m u_{k-m} + v_k = \sum_{m=-\infty}^k h_{k-m} u_m + v_k, \quad k = \dots, -1, 0, 1, 2, \dots \quad (23.62)$$

$$Y(z) = H(z)U(z) + V(z)$$

where the sequence $\{v_k\}$ represents some external input of errors and disturbances and with $Y(z) = \mathcal{Z}\{y\}$, $U(z) = \mathcal{Z}\{u\}$, $V(z) = \mathcal{Z}\{v\}$ as output and inputs. The *weighting function* $h(kT) = \{h_k\}_{k=0}^{\infty}$, which is zero for negative k and for reasons of causality is sometimes called *pulse response* of the digital system (compare *impulse response* of continuous-time systems). The pulse response and its z transform, the *pulse transfer function*,

$$H(z) = \mathcal{Z}\{h(kT)\} = \sum_{k=0}^{\infty} h_k z^{-k} \quad (23.63)$$

determine the system's response to an input $U(z)$; see Fig. 23.18. The pulse transfer function $H(z)$ is obtained as the ratio

$$H(z) = \frac{X(z)}{U(z)} \quad (23.64)$$

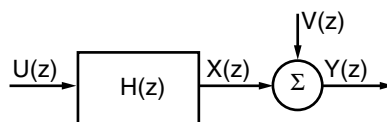

FIGURE 23.18 Block diagram with an assumed transfer function relationship $H(z)$ between input $U(z)$, disturbance $V(z)$, intermediate $X(z)$, and output $Y(z)$.

and provides the frequency domain input–output relation of the system. In particular, the Bode diagram is evaluated as $|H(z)|$ and $\arg H(z)$ for $z = \exp(i\omega_k T)$ and for $|\omega_k| < \omega_n = \pi/T$, that is, when $H(z)$ is evaluated for frequency points up to the Nyquist frequency ω_n along the unit circle.

State-Space Systems

Alternatives to the input–output representations by means of transfer functions are the state-space representations. Consider the following finite dimensional discrete state-space equation with a state vector $x_k \in \mathbb{R}^n$, input $u_k \in \mathbb{R}^p$, and observations $y_n \in \mathbb{R}^m$.

$$\begin{cases} x_{k+1} = \Phi x_k + \Gamma u_k \\ y_k = C x_k + D u_k \end{cases} \quad k = 0, 1, \dots \quad (23.65)$$

with the pulse transfer function

$$H(z) = C(zI - \Phi)^{-1}\Gamma + D \quad (23.66)$$

and the output variable

$$Y(z) = C \sum_{k=0}^{\infty} \Phi^k z^{-k} x_0 + H(z)U(z) \quad (23.67)$$

where possible effects of initial conditions x_0 appear as the first term. Notice that the initial conditions x_0 can be viewed as the net effects of the input in the time interval $(-\infty, 0)$.

Digital Systems Described by Difference Equations (ARMAX Models)

An important class of nonstationary stochastic processes is one in which some deterministic response to an external input and a stationary stochastic process are superimposed. This is relevant, for instance, when the external input cannot be effectively described by some probabilistic distribution. A discrete-time model can be formulated in the form of a difference equation with an external input $\{u_k\}$ that is usually considered to be known:

$$y_k = -a_1 y_{k-1} - \dots - a_n y_{k-n} + b_1 u_{k-1} + \dots + b_n u_{k-n} + w_k + c_1 w_{k-1} + \dots + c_n w_{k-n} \quad (23.68)$$

Application of the z transform permits formulation of Eq. (23.68) as

$$A(z^{-1})Y(z) = B(z^{-1})U(z) + C(z^{-1})W(z) \quad (23.69)$$

where

$$\begin{aligned} A(z^{-1}) &= 1 + a_1 z^{-1} + \dots + a_n z^{-n} \\ B(z^{-1}) &= 1 + b_1 z^{-1} + \dots + b_n z^{-n} \\ C(z^{-1}) &= 1 + c_1 z^{-1} + \dots + c_n z^{-n} \end{aligned} \quad (23.70)$$

Stochastic models including the A polynomial, according to Eqs. (23.69) and (23.70), are known as **autoregressive (AR) models** and models including the C polynomial are known as **moving-average (MA) models**, whereas the B polynomial determines the effects of the external input (X). Notice that the term *moving average* is here somewhat misleading, as there is no restriction that the coefficients should add to 1 or that the coefficients are nonnegative. An alternative description is *finite impulse response* or *all-zero filter*.

Thus, the full model of Eq. (23.69) is an **autoregressive moving average model** with external input (ARMAX) and its pulse transfer function $H(z) = B(z^{-1})/A(z^{-1})$ is stable if and only if the *poles*—that is, the complex numbers z_1, \dots, z_n solving the equation $A(z^{-1}) = 0$ —are strictly inside the unit circle, that is, $|z_i| < 1$. The *zeros* of the system—that is, the complex numbers z_1, \dots, z_n solving the equation $B(z^{-1}) = 0$ —may take on any value without any instability arising, although it is preferable to obtain zeros located strictly inside the unit circle, that is, $|z_i| < 1$ (*minimum-phase zeros*). By linearity $\{y_k\}$ can be separated into one purely deterministic process $\{x_k\}$ and one purely stochastic process $\{v_k\}$:

$$\begin{cases} A(z^{-1})X(z) = B(z^{-1})U(z) \\ A(z^{-1})V(z) = C(z^{-1})W(z) \end{cases} \quad \text{and} \quad \begin{cases} y_k = x_k + v_k \\ Y(z) = X(z) + V(z) \end{cases} \quad (23.71)$$

The type of decomposition (Eq. (23.71)) that separates the deterministic and stochastic processes is known as the *Wold decomposition*.

Prediction and Reconstruction

Consider the problem of predicting the output d steps ahead when the output $\{y_k\}$ is generated by the ARMA model,

$$A(z^{-1})Y(z) = C(z^{-1})W(z) \quad (23.72)$$

which is driven by a zero-mean white noise $\{w_k\}$ with covariance $\mathcal{E}\{w_i w_j\} = \sigma_w^2 \delta_{ij}$. In other words, assuming that observations $\{y_k\}$ are available up to the present time, how should the output d steps ahead be predicted optimally? Assume that the polynomials $A(z^{-1})$ and $C(z^{-1})$ are mutually prime with no zeros for $|z| \geq 1$. Let the C polynomial be expanded according to the *Diophantine equation*,

$$C(z^{-1}) = A(z^{-1})F(z^{-1}) + z^{-d}G(z^{-1}) \quad (23.73)$$

which is solved by the two polynomials

$$\begin{aligned} F(z^{-1}) &= 1 + f_1 z^{-1} + \dots + f_{n_F} z^{-n_F}, & n_F &= d - 1 \\ G(z^{-1}) &= g_0 + g_1 z^{-1} + \dots + g_{n_G} z^{-n_G}, & n_G &= \max(n_A - 1, n_C - d) \end{aligned} \quad (23.74)$$

Interpretation of z^{-1} as a *backward shift operator* and application of Eqs. (23.72) and (23.73) permit the formulation

$$y_{k+d} = F(z^{-1})w_{k+d} + \frac{G(z^{-1})}{C(z^{-1})}y_k \quad (23.75)$$

Let us, by $\hat{y}_{k+d|k}$, denote linear d -step predictors of y_{k+d} based upon the measured information available at time k . As the zero-mean term $F(z^{-1})w_{k+d}$ of Eq. (23.75) is unpredictable at time k , it is natural to suggest the following d -step predictor:

$$\hat{y}_{k+d|k} = \frac{G(z^{-1})}{C(z^{-1})} y_k \quad (23.76)$$

The prediction error satisfies

$$\begin{aligned} \mathbf{e}_{k+d} &= (\hat{y}_{k+d|k} - y_{k+d}) \\ &= \frac{G(z^{-1})}{C(z^{-1})} y_k - \frac{A(z^{-1})F(z^{-1}) + z^{-d}G(z^{-1})}{C(z^{-1})} y_{k+d} \\ &= -F(z^{-1})w_{k+d} \end{aligned} \quad (23.77)$$

Let $\mathcal{E}\{\cdot|\mathcal{F}_k\}$ denote the *conditional mathematical expectation* relative to the measured information available at time k . The conditional mathematical expectation and the covariance of the d -step prediction relative to available information at time k is

$$\begin{aligned} \mathcal{E}\{\hat{y}_{k+d|k} - y_{k+d} | \mathcal{F}_k\} &= \mathcal{E}\{-F(z^{-1})w_{k+d} | \mathcal{F}_k\} = 0 \\ \mathcal{E}\{(\hat{y}_{k+d|k} - y_{k+d})^2 | \mathcal{F}_k\} &= \mathcal{E}\{[F(z^{-1})w_{k+d}]^2 | \mathcal{F}_k\} \\ &= \mathcal{E}\{(w_{k+d} + f_1 w_{k+d-1} + \dots + f_{d-1} w_{k+1})^2 | \mathcal{F}_k\} \\ &= (1 + f_1^2 + \dots + f_{d-1}^2) \sigma_w^2 = 0 \end{aligned} \quad (23.78)$$

It follows that the predictor of Eq. (23.76) is unbiased and that the prediction error only depends on future, unpredictable noise components. It is straightforward to show that the predictor of Eq. (23.76) achieves the lower bound of Eq. (23.78) and that the predictor of Eq. (23.76) is optimal in the sense that the prediction error variance is minimized.

Example 23.1—An Optimal Predictor for a First-Order Model

Consider for the first-order ARMA model

$$y_{k+1} = -a_1 y_k + w_{k+1} + c_1 w_k \quad (23.79)$$

The variance of a one-step-ahead predictor $\hat{y}_{k+1|k}$ is

$$\begin{aligned} \mathcal{E}\{(\hat{y}_{k+1|k} - y_{k+1})^2 | \mathcal{F}_k\} &= \mathcal{E}\{(\hat{y}_{k+1|k} + a_1 y_k - c_1 w_k)^2 | \mathcal{F}_k\} + \mathcal{E}\{w_{k+1}^2 | \mathcal{F}_k\} \\ &= \mathcal{E}\{(\hat{y}_{k+1|k} + a_1 y_k - c_1 w_k)^2 | \mathcal{F}_k\} + \sigma_w^2 \geq \sigma_w^2 \end{aligned} \quad (23.80)$$

The optimal predictor satisfying the lower bound in Eq. (23.80) is obtained from Eq. (23.80) as

$$\hat{y}_{k+1|k}^o = -a_1 y_k + c_1 w_k \quad (23.81)$$

which, unfortunately, is not realizable as it stands because w_k is not available to measurement. Therefore, the noise sequence $\{w_k\}$ has to be substituted by some function of the observed variable $\{y_k\}$. A linear predictor chosen according to Eq. (23.76) is

$$\hat{y}_{k+1|k} = \frac{G(z^{-1})}{C(z^{-1})}y_k = \frac{c_1 - a_1}{1 + c_1 z^{-1}}y_k \quad (23.82)$$

The Kalman Filter

Consider the linear state-space model

$$\begin{aligned} x_{k+1} &= \Phi x_k + v_k, & x_k &\in \mathbb{R}^n \\ y_k &= Cx_k + w_k, & y_k &\in \mathbb{R}^m \end{aligned} \quad (23.83)$$

where $\{v_k\}$ and $\{w_k\}$ are assumed to be independent zero-mean white-noise processes with covariances Σ_v and Σ_w , respectively. It is assumed that $\{y_k\}$, but not $\{x_k\}$, is available to measurement and that it is desirable to predict $\{x_k\}$ from measurements of $\{y_k\}$.

Introduce the state predictor,

$$\begin{aligned} \hat{x}_{k+1|k} &= \Phi \hat{x}_{k|k-1} - K_k(\hat{y}_k - y_k), & \hat{x}_{k|k-1} &\in \mathbb{R}^n \\ \hat{y}_k &= C\hat{x}_{k|k-1}, & y_k &\in \mathbb{R}^m \end{aligned} \quad (23.84)$$

The predictor of Eq. (23.84) has the same dynamics matrix Φ as the state-space model of Eq. (101.83) and, in addition, there is a correction term $K_k(\hat{y}_k - y_k)$ with a factor K_k to be chosen. The prediction error is

$$\tilde{x}_{k+1|k} = \hat{x}_{k+1|k} - x_{k+1} \quad (23.85)$$

The prediction-error dynamics is

$$\tilde{x}_{k+1} = (\Phi - K_k C)\tilde{x}_k + v_k - K_k w_k \quad (23.86)$$

The mean prediction error is governed by the recursive equation

$$\mathcal{E}\{\tilde{x}_{k+1}\} = (\Phi - K_k C)\mathcal{E}\{\tilde{x}_k\} \quad (23.87)$$

and the mean square error of the prediction error is governed by

$$\begin{aligned} \mathcal{E}\{\tilde{x}_{k+1}\tilde{x}_{k+1}^T\} &= \mathcal{E}\{[(\Phi - K_k C)\tilde{x}_k + v_k - K_k w_k][(\Phi - K_k C)\tilde{x}_k + v_k - K_k w_k]^T\} \\ &= (\Phi - K_k C)\mathcal{E}\{\tilde{x}_k\tilde{x}_k^T\}(\Phi - K_k C)^T + \Sigma_v + K_k \Sigma_w K_k \end{aligned} \quad (23.88)$$

If we denote

$$P_k = \mathcal{E}\{\tilde{x}_k\tilde{x}_k^T\}, \quad Q_k = \Sigma_w + CP_k C^T \quad (23.89)$$

then Eq. (23.88) is simplified to

$$P_{k+1} = \Phi P_k \Phi^T - K_k C P_k C^T K_k^T + \Sigma_v + K_k Q_k K_k^T \quad (23.90)$$

By completing squares of terms containing K_k we find

$$P_{k+1} = \Phi P_k \Phi^T + \Sigma_v - \Phi P_k C^T Q_k^{-1} C P_k \Phi^T + (K_k - \Phi P_k C^T Q_k^{-1}) Q_k (K_k - \Phi P_k C^T Q_k^{-1})^T \quad (23.91)$$

where only the last term depends on K_k . Minimization of P_{k+1} can be done by choosing K_k such that the positive semidefinite K_k -dependent term in Eq. (23.91) disappears. Thus P_{k+1} achieves its lower bound for

$$K_k = \Phi P_k C^T (\Sigma_w + C P_k C^T)^{-1} \quad (23.92)$$

and the *Kalman filter* (or *Kalman–Bucy filter*) takes the form

$$\begin{aligned} \hat{x}_{k+1|k} &= \Phi \hat{x}_{k|k-1} - K_k (\hat{y}_k - y_k) \\ \hat{y}_k &= C \hat{x}_{k|k-1}, \quad K_k = \Phi P_k C^T (\Sigma_w + C P_k C^T)^{-1} \\ P_{k+1} &= \Phi P_k \Phi^T + \Sigma_v - \Phi P_k C^T (\Sigma_w + C P_k C^T)^{-1} C P_k \Phi^T \end{aligned} \quad (23.93)$$

which is the optimal predictor in the sense that the mean square error (Eq. (23.88)) is minimized in each step.

Example 23.2—Kalman Filter for a First-Order System

Consider the state-space model

$$x_{k+1} = 0.95x_k + v_k, \quad y_k = x_k + w_k \quad (23.94)$$

where $\{v_k\}$ and $\{w_k\}$ are zero-mean white-noise processes with covariances $\mathcal{E}\{v_k^2\} = 1$ and $\mathcal{E}\{w_k^2\} = 1$, respectively.

The Kalman filter takes on the form

$$\begin{aligned} \hat{x}_{k+1|k} &= 0.95 \hat{x}_{k|k-1} - K_k (\hat{x}_{k|k-1} - y_k) \\ K_k &= \frac{0.95 P_k}{1 + P_k} \\ P_{k+1} &= 0.95^2 P_k + 1 - \frac{0.95^2 P_k^2}{1 + P_k} \end{aligned} \quad (23.95)$$

The result of one such realization is shown in [Fig. 23.19](#).

Defining Terms

Autoregressive (AR) model: An autoregressive time series of order n is defined via $y_k = -\sum_{m=1}^n a_m y_{k-m} + w_k$. The sequence $\{w_k\}$ is usually assumed to consist of zero-mean identically distributed stochastic variables w_k .

Autoregressive moving average (ARMA) model: An autoregressive moving average time series of order n is defined via $y_k = -\sum_{m=1}^n a_m y_{k-m} + \sum_{m=0}^n c_m w_{k-m}$. The sequence $\{w_k\}$ is usually assumed to consist of zero-mean identically distributed stochastic variables w_k .

Discrete Laplace transform: The discrete Laplace transform is a counterpart to the Laplace transform with application to discrete signals and systems. The discrete Laplace transform is obtained from the z transform by means of the substitution $z = \exp(sT)$, where T is the sampling period.

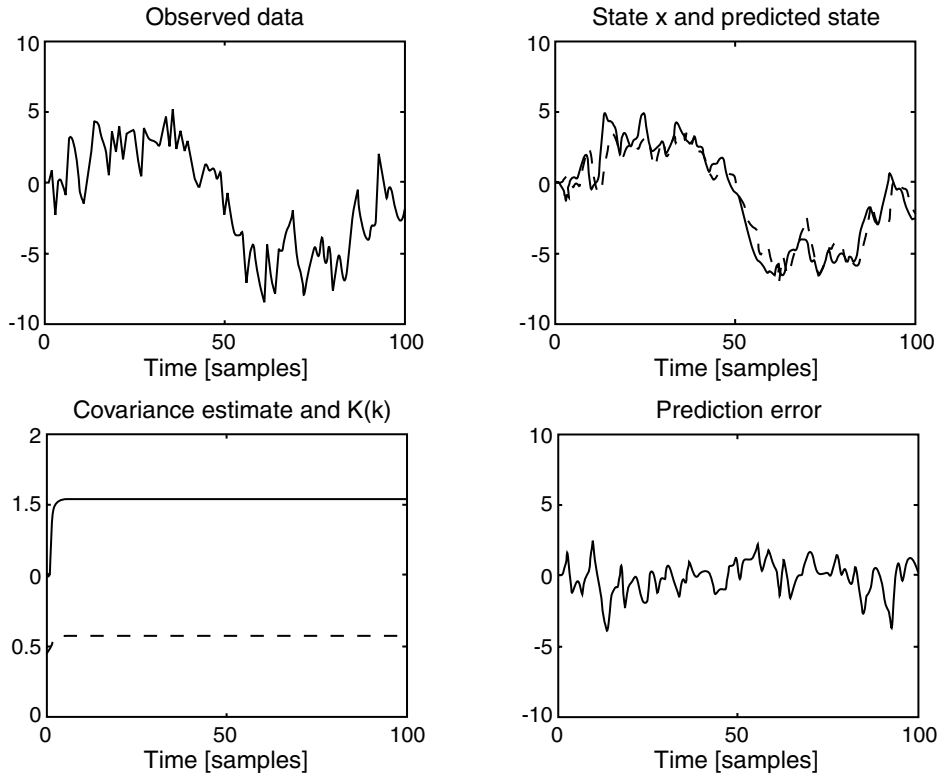

FIGURE 23.19 Kalman filter applied to one-step-ahead prediction of x_{k+1} in Eq. (23.94). The observed variable $\{y_k\}$, the state $\{x_k\}$, and the predicted state $\{\hat{x}_k\}$, the estimated variance $\{P_k\}$ and $\{K_k\}$, and the prediction error $\{\tilde{x}_k\}$ are shown in a 100-step realization of the stochastic process. (Source: Johansson, R. 1993. *System Modeling and Identification*. Prentice-Hall, Englewood Cliffs, NJ.)

Moving average (MA) process: A moving average time series of order n is defined via $y_k = \sum_{m=0}^n c_m w_{k-m}$. The sequence $\{w_k\}$ is usually assumed to consist of zero-mean identically distributed stochastic variables w_k .

Rational model: AR, MA, ARMA, and ARMAX are commonly referred to as rational models.

Time Series: A sequence of random variable $\{y_k\}$, where k belongs to the set of positive and negative integers.

z transform: A generating function applied to sequences of data and evaluated as a function of the complex variable z with interpretation of frequency.

References

- Box, G. E. P. and Jenkins, G. M. 1970. *Time Series Analysis: Forecasting and Control*. Holden-Day, San Francisco, CA.
- Hurewicz, W. 1947. Filters and servo systems with pulsed data. In *Theory of Servomechanisms*, H. M. James, N. B. Nichols, and R. S. Phillips, eds., McGraw-Hill, New York.
- Jenkins, G. M. and Watts, D. G. 1968. *Spectral Analysis and Its Applications*. Holden-Day, San Francisco, CA.
- Johansson, R. 1993. *System Modeling and Identification*. Prentice-Hall, Englewood Cliffs, NJ.
- Jury, E. I. 1956. Synthesis and critical study of sampled-data control systems. *AIEE Trans.* 75: 141–151.
- Kalman, R. E. and Bertram, J. E. 1958. General synthesis procedure for computer control of single and multi-loop linear systems. *Trans. AIEE.* 77: 602–609.

- Kolmogorov, A. N. 1939. Sur l'interpolation et extrapolation des suites stationnaires. *C. R. Acad. Sci.* 208: 2043–2045.
- Ragazzini, J. R. and Zadeh, L. A. 1952. The analysis of sampled-data systems. *AIEE Trans.* 71:225–234.
- Tsytkin, Y. Z. 1950. Theory of discontinuous control. *Avtomatika i Telemekhanika*. Vol. 5.
- Wiener, N. 1949. *Extrapolation, Interpolation and Smoothing of Stationary Time Series with Engineering Applications*. John Wiley & Sons, New York.

Further Information

Early theoretical efforts developed in connection with servomechanisms and radar applications [Hurewicz, 1947]. Tsytkin [1950] introduced the discrete Laplace transform and the formal z transform definition was introduced by Ragazzini and Zadeh [1952] with further developments by Jury [1956]. Much of prediction theory was originally developed by Kolmogorov [1939] and Wiener [1949] whereas state-space methods were forwarded by Kalman and Bertram [1958]. Pioneering textbooks on time-series analysis and spectrum analysis are provided by Box and Jenkins [1970] and Jenkins and Watts [1968].

Detailed accounts of time-series analysis and the z transform and their application to signal processing are to be found in

- Oppenheim, A. V. and Schaffer, R. W. 1989. *Discrete-Time Signal Processing*. Prentice-Hall, Englewood Cliffs, NJ.
- Proakis, J. G. and Manolakis, D. G. 1989. *Introduction to Digital Signal Processing*. Maxwell MacMillan Int. Ed., New York.

Theory of time-series analysis and its application to discrete-time control is to be found in

- Åström, K. J. and Wittenmark, B. 1990. *Computer-Controlled Systems*, 2nd ed., Prentice-Hall, Englewood Cliffs, NJ.

Theory of time-series analysis and methodology for determination and validation of discrete-time models and other aspects of system identification are to be found in

- Johansson, R. 1993. *System Modeling and Identification*. Prentice-Hall, Englewood Cliffs, NJ.

Good sources to monitor current research are

- *IEEE Transactions on Automatic Control*
- *IEEE Transactions on Signal Processing*

Examples of easy-to-read survey articles for signal processing applications are

- Cadzow, J. A. 1990. Signal processing via least-squares error modeling. *IEEE ASSP Magazine*. 7:12–31, October.
- Schroeder, M. R. 1984. Linear prediction, entropy, and signal analysis. *IEEE ASSP Magazine*. 1:3–11, July.

23.3 Continuous- and Discrete-Time State-Space Models

Kam Leang, Qingze Zou, and Santosh Devasia

Introduction

In this section we introduce the modeling of continuous- and discrete-time systems using the state-space approach. The state-space approach is a technique that uses a set of first order differential equations to represent the behavior of a system in the time-domain. The state-space approach has an advantage over frequency-domain approaches such as the transfer-function approach: it can be used to model linear,

nonlinear, time-varying, and multivariable systems, whereas the transfer-function approach is suited to linear time-invariant (LTI) systems [1, Chapter 3]. In addition, models expressed in first order state-space form in the time-domain can be readily solved by a digital computer or microprocessor, which makes this approach quite useful for the design and control of modern mechatronic systems. Furthermore, there is a wide variety of available computer software, such as MATLAB [2], that take advantage of the state-space form for analyzing and solving design problems. Therefore, the state-space approach can be used to investigate the behavior and facilitate in the design of both continuous- and discrete-time systems, the fundamentals of which will be the focus of this section.

In the following, we begin with an example: the modeling of a piezoceramic actuator and use the example throughout the section. The concept of a system state is introduced and we explain the state-space equation for linear systems and present its solution. The topic of linearization of nonlinear systems is briefly mentioned. The relationships between time- and frequency-domain models are discussed and a procedure for obtaining a state-space model using experimental frequency-domain (frequency-response) data is presented. This section closes with a discussion of discrete-time state-space modeling and concluding remarks. Useful MATLAB commands are also included as footnotes.

States and the State-Space

An Example Piezoceramic Actuator

We begin by modeling a piezoceramic actuator, which is an example mechatronic (electromechanical) system. When a voltage is applied to a piezoceramic material, its dimension changes. This change in dimension can be used to precisely position an object or tool (such as a sensor), therefore making piezoceramics suitable actuators for a wide variety of applications. For example, due to their ability to achieve positioning with sub-nanometer level precision, piezoceramic actuators have become ideal for emerging nanotechnologies. In particular, a piezo-tube actuator is used in scanning probe microscopes (SPMs, see Fig. 23.20) to precisely position a probe tip for high-precision nanofabrication, surface modification, and the acquisition of images of atoms [3]. The probe tip can be positioned in the three coordinate axes (x , y , and z), with each motion controlled by an independent voltage source ($V_x(t)$, $V_y(t)$, and $V_z(t)$). Scanning of the probe is performed parallel to the sample surface along the x - and y -axis; the z -axis movement allows motion of the probe perpendicular to the sample surface. An accurate mathematical model of the dynamics of a piezo-tube actuator is required for the analysis and design of SPM systems. A designer can exploit the known information of the system from its model to improve or optimize a design for building faster and more reliable SPMs. For example, an approach that has been

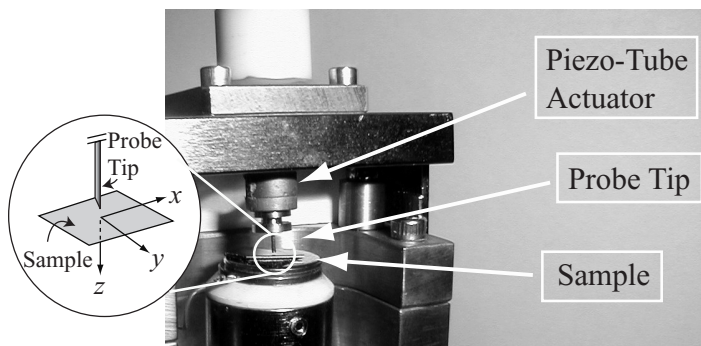

FIGURE 23.20 The main components of a scanning probe microscope (SPM) used for surface analysis, which includes the piezo-tube actuator, the probe tip, and the sample. The configuration of the probe tip and sample with respect to the coordinate axes (x , y , and z) are shown in the magnified view.

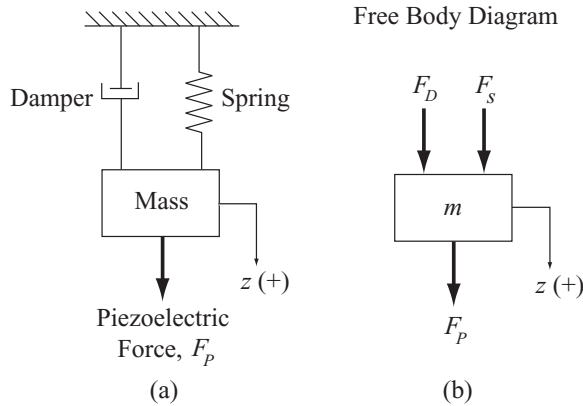

FIGURE 23.21 (a) A simple *lumped model* of the piezo-tube actuator modeled along the z -axis consisting of a mass, a spring, and a damper [4]. The positive z -direction is indicated by the arrow and the “+” sign. (b) The forces acting on the mass (free body diagram).

successfully implemented is the inversion-based control method, which finds the inputs required to achieve exact tracking by inverting the system model [3]. This technique works best when the dynamics of the system are well characterized and understood. In general, the analysis and design of control systems also requires a system model. Thus for analysis and design, it is crucial to obtain an accurate mathematical model that describes the behavior of a system. Modeling of the example piezo-tube system is considered in the following.

Simple Model of a Piezo-Tube Actuator

We will model the dynamics of the piezo-tube actuator along the z -axis where the input is the applied voltage $V_z(t)$ and the output of the system is the displacement of the probe tip $z(t)$. We begin the modeling by simplifying the system as an isolated mass, an ideal spring, and a damper as shown in Fig. 23.21(a). The entire mass of the piezo-tube is lumped into one mass element m , the internal elastic behavior of the piezo-tube is modeled as a spring, and the structural damping in the piezo-tube is modeled as a damper or a viscous friction element (such models are referred to as *lumped models* [4]). A mathematical relationship between the applied voltage $V_z(t)$ and the displacement of the probe tip $z(t)$ can be obtained using physical laws. Applying Newton’s second law (the sum of all external forces F_i acting on a body is equal the product of its mass m and acceleration $\ddot{z}(t)$) we can write the equation of motion as

$$\sum_i F_i(t) = m\ddot{z}(t) \tag{23.96}$$

As shown in Fig. 23.21(b) (the free body diagram), there are three external forces acting on the piezo-tube. First, the force exerted by the spring is assumed to be proportional to the displacement of the probe tip, i.e.,

$$F_s(t) = -kz(t) \tag{23.97}$$

where k is the spring constant with SI units [N/m]. Second, the damping force is considered to be proportional to the velocity of the probe tip $\dot{z}(t)$, i.e.,

$$F_D(t) = -c\dot{z}(t) \tag{23.98}$$

where c is the viscous friction or damping coefficient with SI units [N · s/m]. Third, induced strain ϵ in the piezoceramic material is proportional to the applied voltage $V_z(t)$ [5], and by Hooke's Law, the induced stress σ is proportional to the induced strain ϵ . Hence, the induced force $F_p(t)$ (stress σ times the cross-sectional area) is proportional to the applied voltage $V_z(t)$, i.e.,

$$F_p(t) = bV_z(t) \quad (23.99)$$

where b is a constant with SI units [N/V]. Rewriting Eq. (23.96) in terms of the three external forces, the equation of motion becomes

$$\sum_{i=1}^3 F_i(t) = F_S(t) + F_D(t) + F_p(t) = -kz(t) - c\dot{z}(t) + bV_z(t) = m\ddot{z}(t) \quad (23.100)$$

which is called the *mass-spring-damper* model. Note that the relationship between the input voltage $V_z(t)$ and the displacement $z(t)$ of the probe tip (i.e., the model of the dynamics) is a second order differential equation. The response of the probe tip (displacement of mass m) to an applied voltage $V_z(t)$ can be obtained in the frequency-domain by using the Laplace transform technique [6, Chapter 2, section 5]; however, the state-space approach can be used to obtain the solution directly in the time-domain. In the remaining sections, the state-space approach to modeling is presented and the *mass-spring-damper* model of the piezo-tube actuator will be used as an example.

States of a System

We begin by introducing the concept of a state, which is the basis for the state-space approach. In general, a state can be defined as the following:

The state $x(t_0)$ of a dynamic system at time t_0 is a set of variables that, together with the input $u(t)$, for $t \geq t_0$, determines the behavior of the system for all $t \geq t_0$ [7, Chapter 2, section 1.1].

Fundamental to this definition is the notion that the state summarizes the current configuration of a system. Therefore, the memory of a dynamical system is preserved in the state variables at the current time t_0 (called initial condition), and the future behavior of the system is determined by the initial condition $x(t_0)$ and the applied input $u(t)$, for $t \geq t_0$. The state of a system can be written as the set

$$x(t) = \begin{bmatrix} x_1(t) \\ x_2(t) \\ \vdots \\ x_n(t) \end{bmatrix} \quad (23.101)$$

where n is the number of states.¹ Any set of variables that satisfy the above definition can be a valid state, hence the state is not unique [8, Chapter 2, section 2].

Example

The state variables required to describe the mass-spring-damper system can be chosen as the position $z(t)$ and velocity $\dot{z}(t)$ of the mass. We can write the state vector as

$$x(t) = \begin{bmatrix} x_1(t) \\ x_2(t) \end{bmatrix} = \begin{bmatrix} z(t) \\ \dot{z}(t) \end{bmatrix} \quad (23.102)$$

¹For a discussion on the minimal set of states required to describe a system (minimal realization), see [7, Chapter 7].

where the number of states is two ($n = 2$). If the position $z(t)$ and velocity $\dot{z}(t)$ of the mass are known at time t_0 , along with the applied voltage $V_z(t)$ defined for $t \geq t_0$, then the future behavior of the system (i.e., the state $x(t)$) can be determined by solving the differential Eq. (23.100).

The Linear State-Space Equation and Its Solution

For a linear system, the evolution of the states of a system over time can be described by a set of linear first order differential equations of the form:

$$\begin{aligned}\dot{x}_1(t) &= \frac{dx_1(t)}{dt} = a_{11}(t)x_1(t) + \cdots + a_{1n}(t)x_n(t) + b_{11}(t)u_1(t) + \cdots + b_{1p}(t)u_p(t) \\ \dot{x}_2(t) &= \frac{dx_2(t)}{dt} = a_{21}(t)x_1(t) + \cdots + a_{2n}(t)x_n(t) + b_{21}(t)u_1(t) + \cdots + b_{2p}(t)u_p(t) \\ &\vdots \\ \dot{x}_n(t) &= \frac{dx_n(t)}{dt} = a_{n1}(t)x_1(t) + \cdots + a_{nn}(t)x_n(t) + b_{n1}(t)u_1(t) + \cdots + b_{np}(t)u_p(t)\end{aligned}\quad (23.103)$$

where n is the number of states (or the order of the system) and p is the number of inputs.² Defining the input vector as

$$u(t) = \begin{bmatrix} u_1(t) \\ u_2(t) \\ \vdots \\ u_p(t) \end{bmatrix}\quad (23.104)$$

and the state vector $x(t)$ as defined in Eq. (23.101), the set of first order differential equations given by Eq. (23.103) can be rewritten in compact matrix form as [8, Chapter 2, section 2]

$$\begin{aligned}\dot{x}(t) &= \begin{bmatrix} a_{11}(t) & a_{12}(t) & \cdots & a_{1n}(t) \\ a_{21}(t) & a_{22}(t) & \cdots & a_{2n}(t) \\ \vdots & \vdots & \ddots & \vdots \\ a_{n1}(t) & a_{n2}(t) & \cdots & a_{nn}(t) \end{bmatrix} x(t) + \begin{bmatrix} b_{11}(t) & b_{12}(t) & \cdots & b_{1p}(t) \\ b_{21}(t) & b_{22}(t) & \cdots & b_{2p}(t) \\ \vdots & \vdots & \ddots & \vdots \\ b_{n1}(t) & b_{n2}(t) & \cdots & b_{np}(t) \end{bmatrix} u(t) \\ &= A(t)x(t) + B(t)u(t)\end{aligned}\quad (23.105)$$

where $A(t)$ is an $n \times n$ matrix and $B(t)$ is an $n \times p$ matrix. For a system defined with q outputs $y(t)$, which are assumed to be a linear combination of the state $x(t)$ and input $u(t)$, we can write the output equation as

$$\begin{aligned}y(t) &= \begin{bmatrix} c_{11}(t) & c_{12}(t) & \cdots & c_{1n}(t) \\ c_{21}(t) & c_{22}(t) & \cdots & c_{2n}(t) \\ \vdots & \vdots & \ddots & \vdots \\ c_{q1}(t) & c_{q2}(t) & \cdots & c_{qn}(t) \end{bmatrix} x(t) + \begin{bmatrix} d_{11}(t) & d_{12}(t) & \cdots & d_{1p}(t) \\ d_{21}(t) & d_{22}(t) & \cdots & d_{2p}(t) \\ \vdots & \vdots & \ddots & \vdots \\ d_{q1}(t) & d_{q2}(t) & \cdots & d_{qp}(t) \end{bmatrix} u(t) \\ &= C(t)x(t) + D(t)u(t)\end{aligned}\quad (23.106)$$

²Given a higher order differential equation, a set of first order differential equations can be obtained by a procedure known as reduction to first order as presented in [9].

where $C(t)$ is a $q \times n$ matrix and $D(t)$ is a $q \times p$ matrix. In general, the matrices $A(t)$, $B(t)$, $C(t)$, and $D(t)$ are time varying; however, in this chapter we will only consider the time-invariant case where A , B , C , and D are constant matrices, then Eqs. (23.107) and (23.108) are called the linear time-invariant (LTI) state and output equations, respectively.³

$$\dot{x}(t) = Ax(t) + Bu(t) \quad (23.107)$$

$$y(t) = Cx(t) + Du(t) \quad (23.108)$$

The response of the system to an applied input can be quantified by the evolution of the system state $x(t)$ and the output $y(t)$. The state-space Eq. (23.107) is a set of first order differential equations in matrix form, which can be solved in time for a given initial condition $x(t_0)$ as [8, Chapter 3]

$$x(t) = e^{A(t-t_0)} x(t_0) + \int_{t_0}^t e^{A(t-\tau)} Bu(\tau) d\tau \quad (23.109)$$

Note that solution (23.109) is the sum of two terms: the first term is the effect of initial condition $x(t_0)$ and the second is the effect of the applied input $u(t)$ between $t_0 \leq \tau \leq t$.⁴ Using the output Eq. (23.108) and the state solution given by (23.109), the output $y(t)$ becomes

$$y(t) = Ce^{A(t-t_0)} x(t_0) + \int_{t_0}^t Ce^{A(t-\tau)} Bu(\tau) d\tau + Du(t) \quad (23.110)$$

The system response $y(t)$ to an applied input $u(t)$ is characterized by the system matrices (A , B , C , D). For example, the output $y(t)$ will be bounded for any bounded input if the system is stable and the system is stable if the real parts of all the eigenvalues of A are less than zero (strictly negative) [8, Chapter 4, section 4].⁵

Example

For the mass-spring-damper example system, the state-space equation can be found by differentiating the states $x(t)$ defined in Eq. (23.102) and using the equation of motion (23.100) to obtain

$$\begin{aligned} \dot{x}_1(t) &= \dot{z}(t) = x_2(t) \\ \dot{x}_2(t) &= \ddot{z}(t) = -\left(\frac{k}{m}\right)z(t) - \left(\frac{c}{m}\right)\dot{z}(t) + \left(\frac{b}{m}\right)V_z(t) = -\left(\frac{k}{m}\right)x_1(t) - \left(\frac{c}{m}\right)x_2(t) + \left(\frac{b}{m}\right)u(t) \end{aligned} \quad (23.111)$$

We choose the position of the mass $z(t)$ to be the output of the system, and write the state-space and output equation in the form given by Eqs. (23.107) and (23.108) as

$$\dot{x}(t) = \begin{bmatrix} 0 & 1 \\ -(k/m) & -(c/m) \end{bmatrix} x(t) + \begin{bmatrix} 0 \\ b/m \end{bmatrix} u(t) \quad (23.112)$$

$$y(t) = \begin{bmatrix} 1 & 0 \end{bmatrix} x(t) \quad (23.113)$$

³For a detailed discussion of the solution of linear time-varying equations, see [7, Chapter 4, section 5].

⁴The MATLAB command `lsim` simulates the time response of LTI models to arbitrary inputs.

⁵The MATLAB command `eig(A)` returns the eigenvalues of the system matrix A .

Linearization of Nonlinear Systems

A general form of the state-space equation (for nonlinear systems) is

$$\dot{x}(t) = g(x, u) \quad (23.114)$$

$$y(t) = h(x, u) \quad (23.115)$$

where g and h can be nonlinear functions.⁶ The behavior of nonlinear systems is beyond the scope of this section; however, a detailed discussion can be found in [10]. The behavior of a nonlinear system can be approximated by a linear model in a neighborhood of an equilibrium point. Such linearizations can simplify the analysis and design of nonlinear systems because the tools developed for linear systems can be applied under certain conditions [10]. Let x_0 and u_0 be the equilibrium point and equilibrium input, respectively, such that [10, Chapter 1]

$$g(x_0, u_0) = 0 \quad (23.116)$$

$$h(x_0, u_0) = y_0 \quad (23.117)$$

Consider small perturbations in the equilibrium point $x(t) = x_0 + \bar{x}(t)$, the input $u(t) = u_0(t) + \bar{u}(t)$, and the output $y(t) = y_0 + \bar{y}(t)$. If the perturbation $\bar{x}(t)$ is small for all t , we obtain the following by expanding (23.114) in Taylor series (neglecting higher order terms of $\bar{x}(t)$ and $\bar{u}(t)$):

$$\begin{aligned} \dot{x}_0 + \dot{\bar{x}}(t) &= g(x_0 + \bar{x}(t), u_0 + \bar{u}(t)) \\ \dot{\bar{x}}(t) &= g(x_0, u_0) + \left. \frac{\partial g}{\partial x} \right|_{\substack{x=x_0 \\ u=u_0}} \bar{x}(t) + \left. \frac{\partial g}{\partial u} \right|_{\substack{x=x_0 \\ u=u_0}} \bar{u}(t) \end{aligned} \quad (23.118)$$

Recognizing that $g(x_0, u_0) = 0$ we obtain

$$\dot{\bar{x}}(t) = \bar{A}\bar{x}(t) + \bar{B}\bar{u}(t) \quad (23.119)$$

where

$$\bar{A} = \left. \frac{\partial g}{\partial x} \right|_{\substack{x=x_0 \\ u=u_0}} \quad \text{and} \quad \bar{B} = \left. \frac{\partial g}{\partial u} \right|_{\substack{x=x_0 \\ u=u_0}} \quad (23.120)$$

The matrices \bar{A} and \bar{B} are the Jacobians evaluated at x_0 and u_0 . Equation (23.119) is a linear state equation and is valid for small perturbations about x_0 and u_0 . A similar result can be obtained for the change $\bar{y}(t)$ in the output from the equilibrium value y_0 as

$$\bar{y}(t) = \bar{C}\bar{x}(t) + \bar{D}\bar{u}(t) \quad (23.121)$$

where

$$\bar{C} = \left. \frac{\partial h}{\partial x} \right|_{\substack{x=x_0 \\ u=u_0}} \quad \text{and} \quad \bar{D} = \left. \frac{\partial h}{\partial u} \right|_{\substack{x=x_0 \\ u=u_0}} \quad (23.122)$$

⁶The MATLAB command `ode45` can be used to obtain the numeric solution to the general nonlinear state space equation.

Relationship between State Equations and Transfer-Functions

State-Space to Transfer-Function

The input-to-output relationship of a dynamic system in the frequency-domain is represented by a transfer-function, which can be obtained by taking the Laplace transform of (23.107) and (23.108) with zero initial conditions as follows [8, Chapter 3, section 5]:

$$sX(s) = AX(s) + BU(s), \quad (23.123)$$

$$Y(s) = CX(s) + DU(s), \quad (23.124)$$

where s is the Laplace variable. Solving (23.123) for $X(s)$ and substituting into (23.124), the ratio of the output $Y(s)$ to input $U(s)$ for a single-input single-output system (SISO) can be found as

$$\begin{aligned} G(s) &= \frac{Y(s)}{U(s)} = C(sI - A)^{-1}B + D \\ &= \frac{N(s)}{D(s)} \end{aligned} \quad (23.125)$$

where I is an $n \times n$ identity matrix. In Eq. (23.125), $N(s)$ and $D(s)$ are referred to as the numerator and denominator polynomial of $G(s)$, respectively.⁷

Analogous to the state-space equation, the boundedness of the output response $y(t)$ to a bounded input $u(t)$ is characterized by the roots of the denominator polynomial $D(s)$, i.e., the values of s for which $D(s) = 0$. In particular, the output $y(t)$ will be bounded for any bounded input, i.e., system is stable if the real parts of all the roots of $D(s)$ are less than zero (strictly negative).⁸ Alternatively, a convenient method to determine stability without having to find the roots of $D(s)$ explicitly is the Routh–Hurwitz stability criterion [6, Chapter 6].

Example

With the state-space description of the mass-spring-damper system defined in Eqs. (23.112) and (23.113), the transfer-function realization using Eq. (23.125) becomes

$$\begin{aligned} G(s) &= \frac{Y(s)}{U(s)} = \begin{bmatrix} 1 & 0 \end{bmatrix} \left[s \begin{bmatrix} 1 & 0 \\ 0 & 1 \end{bmatrix} - \begin{bmatrix} 0 & 1 \\ -(k/m) & -(c/m) \end{bmatrix} \right]^{-1} \begin{bmatrix} 0 \\ b/m \end{bmatrix} + [0] \\ &= \frac{b/m}{s^2 + (c/m)s + k/m} \end{aligned} \quad (23.126)$$

The input to the system is the applied voltage $V_z(t)$ and the output is the displacement of the mass $z(t)$.

Frequency-Response Using Transfer-Functions

Consider a linear single-input single-output (SISO) stable system with transfer-function description $G(s)$. When the system $G(s)$ is excited by a sinusoidal input of the form

$$u(t) = P \sin(\omega t) \quad (23.127)$$

with amplitude P and frequency ω , the output response (after the transients decay) will also be a sinusoid of the form

$$y(t) = MP \sin(\omega t + \phi) \quad (23.128)$$

⁷The MATLAB command `ss2tf` can be used to convert a state-space realization to a transfer-function.

⁸The MATLAB command `roots (den)` can be used to find the roots of `den`, where `den` is the coefficients of $D(s)$.

with the same frequency ω and a phase shift ϕ [6, Chapter 8]. The output amplitude is the input amplitude scaled by M , the magnitude gain. The magnitude gain M is found by taking the magnitude of $G(s)$ evaluated at $s = j\omega$, i.e.,

$$M = |G(s)|_{s=j\omega} \quad (23.129)$$

Usually, the magnitude gain M is expressed in units of decibels (dB), i.e., $M \text{ [dB]} = 20 \log M$. The phase shift ϕ is the angle of $G(s)$ evaluated at $s = j\omega$, i.e.,

$$\phi = \angle G(s)|_{s=j\omega} \quad (23.130)$$

with units of degrees. The plot of the magnitude gain M and the phase shift ϕ versus the frequency ω gives a graphical representation of the frequency-response (Bode plots) of a system.⁹ These plots can be obtained experimentally by measuring the magnitude gain and phase shift between the input and output response of a system over a range of frequencies. Additionally, a system's transfer-function can be obtained from an experimental frequency-response data by using curve-fitting software. In section "Experimental Modeling Using Frequency Response," we present this approach to determine a model for a system using experimental frequency-response data.

Transfer-Function to State-Space

In section "State-Space to Transfer-Function," a transfer-function model was obtained for a system in state-space form. In the following, an approach for realizing a state-space model from a transfer-function $G(s)$ is presented. For a realizable transfer function $G(s)$ of a SISO system of the form

$$G(s) = \frac{b_0 s^n + b_1 s^{n-1} + \cdots + b_n}{s^n + a_1 s^{n-1} + \cdots + a_n} \quad (23.131)$$

the controllable canonical state-space form written in terms of the coefficients of $G(s)$ is

$$\dot{x}(t) = \begin{bmatrix} -a_1 & -a_2 & \cdots & -a_{n-1} & -a_n \\ 1 & 0 & \cdots & 0 & 0 \\ 0 & 1 & \cdots & 0 & 0 \\ \vdots & \vdots & \ddots & \vdots & \vdots \\ 0 & 0 & \cdots & 1 & 0 \end{bmatrix} x(t) + \begin{bmatrix} 1 \\ 0 \\ 0 \\ \vdots \\ 0 \end{bmatrix} u(t) \quad (23.132)$$

$$y(t) = [(b_1 - a_1 b_0) \quad (b_2 - a_2 b_0) \quad \cdots \quad (b_n - a_n b_0)] x(t) + [b_0] u(t) \quad (23.133)$$

where the number of states n is equal to the highest power of the denominator of $G(s)$.¹⁰ The smallest possible dimension for realizing a system, referred to as the minimum realization, is an important factor to consider in analysis and design.¹¹ Models of minimum order require less computational power in simulation and implementation compared to higher order models. For information about other equivalent canonical state-space forms, refer to [7, Chapter 4, sections 3 and 4].

⁹The MATLAB command `bode` plots the magnitude gain and phase shift for a linear system.

¹⁰The MATLAB command `tf2ss` generates the controllable canonical form realization of a transfer function $G(s)$. Other useful commands include `ss2tf`, `zp2tf`, and `tf2zp`.

¹¹For a detailed discussion of minimal realizations for multi-input multi-output systems, see [7, Chapter 7].

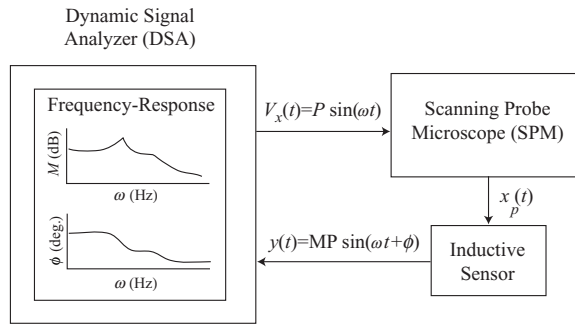

FIGURE 23.22 A schematic of the experimental setup used to determine the frequency-response of the piezo-tube actuator. An inductive sensor measured the displacement of the actuator along the x -axis, and the frequency-response data from the DSA were used to estimate the system model.

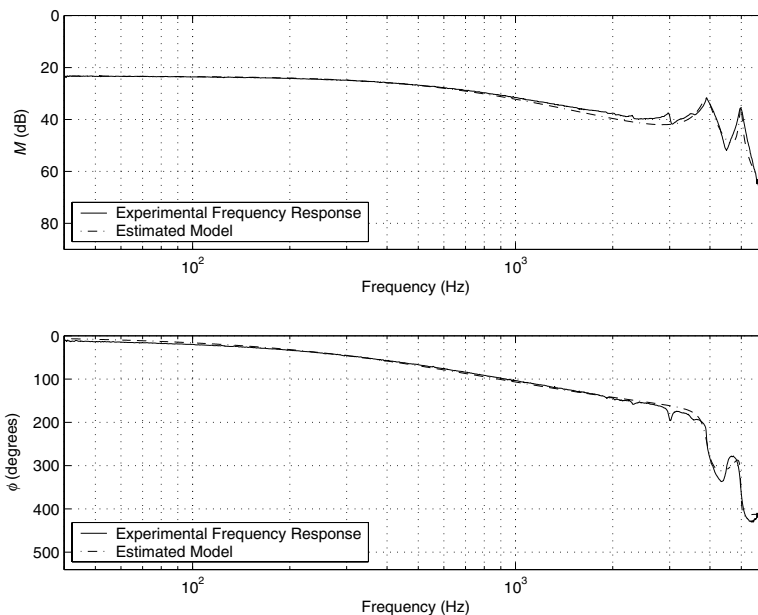

FIGURE 23.23 The experimental magnitude gain and phase versus frequency plots for the piezo-tube actuator measured along the x -axis with superimposed model frequency-response. Solid line represents experimental data; dashed line represents results from estimated model.

Experimental Modeling Using Frequency-Response

An approach to modeling using experimental frequency-response data is presented in this section. Using a dynamic signal analyzer (DSA), the frequency-response of the dynamics along the x -axis for the piezo-tube actuator was measured.¹² A sinusoidal input voltage $V_x(t)$ with frequency varying between 10 Hz and 6 kHz was generated by a DSA and applied to the scanning probe microscope (SPM) system as shown in Fig. 23.22. Using an inductive sensor, the displacement $x_p(t)$ of the piezo-tube along the x -axis was measured and fed back to the DSA to compute the frequency-response (M and ϕ versus frequency ω plots). Figure 23.23 shows the Bode plots obtained by the DSA between the applied voltage $V_x(t)$ and the output of the inductive sensor $y(t)$. An estimate of the system model from the frequency-response

¹²Stanford Research Systems, model SRS785.

data was then found with the MATLAB software.¹³ The transfer-function between the applied input voltage $V_x(t)$ and the output of the inductive sensor $y(t)$ was found to be

$$G_1(s) = \frac{Y(s)}{V_x(s)} = \frac{5.544 \times 10^5 s^4 - 7.528 \times 10^9 s^3 + 1.476 \times 10^{15} s^2 - 4.571 \times 10^{18} s + 9.415 \times 10^{23}}{s^6 + 1.255 \times 10^4 s^5 + 1.632 \times 10^9 s^4 + 1.855 \times 10^{13} s^3 + 6.5 \times 10^{17} s^2 + 6.25 \times 10^{21} s + 1.378 \times 10^{25}} \quad (23.134)$$

with units of V/V. Equation (23.135) was scaled by the inductive sensor gain (30 Å/V) and the transfer-function between the applied voltage $V_x(t)$ and the actual displacement of the piezo-tube $x_p(t)$ is given by

$$G_2(s) = \frac{X_p(s)}{V_x(s)} = \frac{1.663 \times 10^7 s^4 - 2.258 \times 10^{11} s^3 + 4.427 \times 10^{16} s^2 - 1.371 \times 10^{20} s + 2.825 \times 10^{25}}{s^6 + 1.255 \times 10^4 s^5 + 1.632 \times 10^9 s^4 + 1.855 \times 10^{13} s^3 + 6.5 \times 10^{17} s^2 + 6.25 \times 10^{21} s + 1.378 \times 10^{25}} \quad (23.135)$$

with units of Å/V.

Time Scaling of a Transfer-Function Model

We present below an approach for rescaling time for $G_2(s)$ from seconds [s] to milliseconds [ms]. We briefly recall the time scaling property of the Laplace transform presented in [1, Chapter 3, section 1.4]. Let $F(s)$ be the Laplace transform of $f(t)$, i.e.,

$$f(t) \xrightarrow{L} F(s) \quad (23.136)$$

where L denotes the Laplace transform operator. Now, consider a new time scale defined as $\hat{t} = at$, where a is a constant. The Laplace transform of $f(\hat{t}) = f(at)$ is given by

$$f(\hat{t}) = f(at) \xrightarrow{L} \frac{1}{|a|} F\left(\frac{s}{a}\right) = \hat{F}(s) \quad (23.137)$$

Using relation (23.137), we can reduce the coefficients of $G_2(s)$ by changing the time units of both the input signal $u(t)$ and output signal $y(t)$ as follows:

$$\hat{G}_2(s) = \frac{\hat{Y}(s)}{\hat{U}(s)} = \frac{Y(s/a)/|a|}{U(s/a)/|a|} = \frac{Y(s/a)}{U(s/a)} = G\left(\frac{s}{a}\right) \quad (23.138)$$

Therefore, to rescale time for $G_2(s)$ from seconds [s] to millisecond [ms], we choose $\hat{t} = at = 0.001t$ and the new rescaled transfer $\hat{G}_2(s)$ becomes

$$\begin{aligned} \hat{G}_2(s) &= G_2\left(\frac{s}{a}\right) \Big|_{a=0.001} \\ &= G_2(1000s) \\ \hat{G}_2(s) &= \frac{16.63s^4 - 225.8s^3 + 4.427 \times 10^4 s^2 - 1.371 \times 10^5 s + 2.825 \times 10^7}{s^6 + 12.55s^5 + 1.632 \times 10^3 s^4 + 1.855 \times 10^4 s^3 + 6.5 \times 10^5 s^2 + 6.25 \times 10^6 s + 1.378 \times 10^7} \end{aligned} \quad (23.139)$$

¹³The MATLAB command `invfreqs` gives real numerator and denominator coefficients of experimentally determined frequency response data.

Note that the time unit of the input and output signal of $\hat{G}_2(s)$ are now in milliseconds, not seconds! The coefficients of the numerator and denominator polynomials are smaller and this form ($\hat{G}_2(s)$) is less prone to computational errors due to round off than the form $G_2(s)$, Eq. (23.135).

The State-Space Model

The state-space realization for $\hat{G}_2(s)$ expressed in controllable canonical form (Eqs. (23.132) and (23.133)) is given by the following:

$$\dot{x}(t) = \begin{bmatrix} -12.55 & -1.632 \times 10^3 & -1.855 \times 10^4 & -6.50 \times 10^5 & -6.25 \times 10^6 & -1.378 \times 10^7 \\ 1 & 0 & 0 & 0 & 0 & 0 \\ 0 & 1 & 0 & 0 & 0 & 0 \\ 0 & 0 & 1 & 0 & 0 & 0 \\ 0 & 0 & 0 & 1 & 0 & 0 \\ 0 & 0 & 0 & 0 & 1 & 0 \end{bmatrix} x(t) + \begin{bmatrix} 1 \\ 0 \\ 0 \\ 0 \\ 0 \\ 0 \end{bmatrix} u(t) \quad (23.140)$$

$$y(t) = [0 \ 16.63 \ -225.8 \ 4.427 \times 10^4 \ -1.371 \times 10^5 \ 2.825 \times 10^7]x(t) \quad (23.141)$$

The time unit for Eqs. (23.140) and (23.141) are milliseconds [ms]. If the initial state at t_0 is known, along with the applied voltage $V_x(t)$ defined for $t \geq t_0$, the future behavior of the system, i.e., the state $x(t)$ and output $y(t)$, can be determined from Eqs. (23.140) and (23.141), respectively.

Discrete-Time State-Space Modeling

Introduction

The study of discrete-time systems is important to the analysis and the design of modern mechatronics systems where digital computers or small microprocessors are predominantly used to control systems. Digital computers and microprocessors output or acquire information at discrete time instants. For example, the input applied by a digital computer to actuate the piezo-tube changes at discrete time instants. Similarly, the displacement of the piezo-tube can only be measured at specified time instants using digital computers; therefore, in comparison to a continuous-time control system where the input signals change continuously over time, the input of a discrete-time system changes once in a while. Such discrete-time systems are studied next.

Consider a continuous-time system with continuous input $u(t)$ and output $y(t)$ as described by Eqs. (23.107) and (23.108). Let a digital computer or microprocessor be used to provide the input $u[k]$ and measure the output $y[k]$ as depicted in Fig. 23.24 (such systems with continuous and discrete signals are

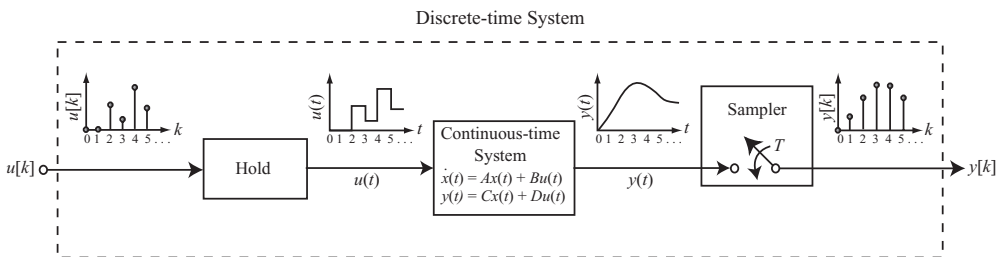

FIGURE 23.24 A block diagram of a discrete-time system showing signals in graphic form. Note that $u[k] = u(k \cdot T)$ and $y[k] = y(k \cdot T)$, for $k = 0, 1, 2, \dots$, and the sampling period T is assumed to be constant.

called sampled-data systems). The input $u[k]$ and output $y[k]$ of this system are discrete with $u[k] = u(k \cdot T)$ and $y[k] = y(k \cdot T)$ for $k = 0, 1, 2, \dots$, where T is the constant sampling period. The discrete input $u[k]$ is applied to the continuous system from a digital computer or microprocessor and is held constant during the time interval T (zero-order hold). A sampler acquires the output of the continuous system at each time instant T yielding the discrete output $y[k]$. The discrete system is between the input $u[k]$ and the output $y[k]$ [11, Chapter 1].¹⁴ The equivalent discrete-time state-space representation of the continuous-time state-space model given by Eqs. (23.107) and (23.108) is given by (the details of the formulation can be found in [11, Chapter 5, section 5])

$$x[k+1] = A_D x[k] + B_D u[k] \quad (23.142)$$

$$y[k] = C_D x[k] + D_D u[k] \quad (23.143)$$

where

$$A_D = e^{AT}, \quad B_D = \left(\int_0^T e^{A\lambda} d\lambda \right) B, \quad C_D = C, \quad \text{and} \quad D_D = D \quad (23.144)$$

and matrices C_D and D_D are not changed by the sampling.¹⁵ This discrete model (Eqs. (23.142) and (23.143)) is the representation of the sampled-data system shown in Fig. 23.24.

Solutions to the Discrete-Time State-Space Equations

The solution to the discrete model (Eqs. (23.142) and (23.143)) is given by

$$x[k] = A_D^k x[0] + \sum_{j=0}^{k-1} A_D^{k-j-1} B_D u[j] \quad (23.145)$$

$$y[k] = C A_D^k x[0] + C \sum_{j=0}^{k-1} A_D^{k-j-1} B_D u[j] + D u[k] \quad (23.146)$$

for each sampling step k . Details of the formulation can be found in [11, Chapter 5, section 3]. The state response $x[k]$ to an applied input $u[k]$ is characterized by the system matrices (A_D , B_D , C_D , D_D). In particular, the output $y[k]$ will be bounded for any bounded input $u[k]$ if the system is stable. A system in the form given by Eq. (23.142) is stable if the magnitude of all the eigenvalues of A_D are less than unity, i.e., lie within the unit circle center at the origin of the z -plane [11, Chapter 5, section 6].

The z -Transform and Relationship with the State-Space

The input-to-output relationship in the frequency-domain for a discrete-time system is represented by a discrete transfer-function called the z -transform, written in terms of the variable z [12, Chapter 4]. Analogous to the continuous-time case, the model of a dynamic system in discrete transfer-function form can be useful in the design and control of systems [12, Chapter 7]. If the system model is available in discrete transfer-function form, then a state-space realization can be found as follows. Given a discrete system described by the following z -transform $G(z)$:

$$G(z) = \frac{d_0 + d_1 z^{-1} + \dots + d_n z^{-n}}{1 + c_1 z^{-1} + \dots + c_n z^{-n}} \quad (23.147)$$

¹⁴We do not discuss quantizing and quantization error. See [11, Chapter 1, section 3] for details.

¹⁵Given a continuous-time state-space model (A , B , C , D), the MATLAB command `c2d`, gives the discrete time equivalent for a specified sampling period T .

the controllable canonical discrete state-space realization for $G(z)$ is

$$x[k+1] = \begin{bmatrix} -c_1 & -c_2 & \cdots & -c_{n-1} & -c_n \\ 1 & 0 & \cdots & 0 & 0 \\ 0 & 1 & \cdots & 0 & 0 \\ \vdots & \vdots & & \vdots & \vdots \\ 0 & 0 & \cdots & 1 & 0 \end{bmatrix} x[k] + \begin{bmatrix} 1 \\ 0 \\ 0 \\ \vdots \\ 0 \end{bmatrix} u[k] \quad (23.148)$$

$$y[k] = [(d_1 - c_1 d_0) \ (d_2 - c_2 d_0) \ \dots \ (d_n - c_n d_0)] x[k] + [d_0] u[k] \quad (23.149)$$

The number of states n is equivalent to the highest power of the denominator of $G(z)$. For information about other equivalent canonical state-space forms, refer to [11, Chapter 5, section 2].

Example

Consider the continuous-time state-space model of the piezo-tube system described by Eqs. (23.140) and (23.141). A digital computer with the sampling rate of 10 kHz ($T = 1.0 \times 10^{-4}$) is used to provide the control input $u[k]$ and measure its displacement along the x -axis (output $y[k]$). The discrete-time state-space model with $(A_D, B_D, C_D,$ and $D_D)$ given by Eq. (23.144) is

$$x[k+1] = \begin{bmatrix} 0.999 & -0.163 & -1.85 & -65.0 & -624.5 & -1377.1 \\ 9.99 \times 10^{-5} & 0.999 & -9.26 \times 10^{-5} & -3.25 \times 10^{-3} & -3.12 \times 10^{-2} & -6.69 \times 10^{-2} \\ 5.00 \times 10^{-9} & 1.00 \times 10^{-4} & 1 & -1.08 \times 10^{-7} & -1.04 \times 10^{-6} & -2.30 \times 10^{-6} \\ 1.67 \times 10^{-13} & 5.00 \times 10^{-9} & 1.00 \times 10^{-4} & 1 & -2.60 \times 10^{-11} & -5.74 \times 10^{-11} \\ 4.17 \times 10^{-18} & 1.67 \times 10^{-13} & 5.00 \times 10^{-9} & 1.00 \times 10^{-4} & 1 & -1.15 \times 10^{-15} \\ 8.33 \times 10^{-23} & 4.17 \times 10^{-18} & 1.67 \times 10^{-13} & 5.00 \times 10^{-9} & 1.00 \times 10^{-4} & 1 \end{bmatrix} x[k] + \begin{bmatrix} 9.99 \times 10^{-5} \\ 4.99 \times 10^{-9} \\ 1.67 \times 10^{-13} \\ 4.17 \times 10^{-18} \\ 8.33 \times 10^{-23} \\ 1.39 \times 10^{-27} \end{bmatrix} u[k] \quad (23.150)$$

$$y[k] = [0 \ 16.63 \ -225.8 \ 4.427 \times 10^4 \ -1.371 \times 10^5 \ 2.825 \times 10^7] x[k] \quad (23.151)$$

The realization given by Eqs. (23.150) and (23.151) was found using the MATLAB command 'c2d'.

Summary

We presented tools for modeling continuous- and discrete-time systems using the state-space approach in this section. The state-space approach to modeling is a powerful technique for the analysis and design of mechatronic and dynamic systems, and can take advantage of tools available in modern digital computers and microprocessors. The discussion of the system states and the state-space was motivated by an example piezo-tube actuator system. We considered the modeling of linear systems and a technique for linearizing nonlinear systems was briefly introduced. The frequency-response of a system and an approach to modeling using experimental frequency-response data was presented. Relationships between models

expressed in the frequency- and time-domain for both continuous- and discrete-time systems was discussed. For additional details about the concepts mentioned in this section and those not covered, it is recommended that the reader consider the attached references for further reading.

References

1. Franklin, G. F., et al., *Feedback Control of Dynamic Systems*, 3rd ed., Addison-Wesley, New York, 1994.
2. Hanselman, D., and Littlefield, B., *The Student Edition of Matlab, Version 5, User's Guide*, Prentice-Hall, Upper Saddle River, NJ, 1997.
3. Croft, D., et al., Creep, hysteresis, and vibration compensation for piezoactuators: atomic force microscopy application, *ASME J. Dyn. Syst., Meas., Control*, 123, 35, 2001.
4. Dorny, C. N., *Understanding Dynamic Systems—Approaches to Modeling, Analysis, and Design*, Prentice-Hall, Englewood Cliffs, NJ, 1993.
5. Locatelli, M., et al., Easy method to characterize a piezoelectric ceramic tube as a displacer, *Rev. Sci. Instrum.*, 59, 4, 1988.
6. Dorf, R. C., and Bishop, R. H., *Modern Control Systems*, 9th ed., Prentice-Hall, Upper Saddle River, NJ, 2001.
7. Chen, T. C., *Linear System Theory and Design*, Oxford University Press, New York, 1999.
8. Friedland, B., *Control System Design: An Introduction to State-Space Methods*, McGraw-Hill, New York, 1986.
9. Gillis, J. T., State space, in *The Control Handbook*, Levine, W. S., CRC Press, Salem, MA, 1996, Chap. 5.
10. Khalil, H. K., *Nonlinear Systems*, 2nd ed., Prentice-Hall, Upper Saddle River, NJ, 1996.
11. Ogata, K., *Discrete-Time Control Systems*, 2nd ed., Prentice-Hall, Englewood Cliffs, NJ, 1995.
12. Franklin, G. F., et al., *Digital Control of Dynamic Systems*, 3rd ed., Addison-Wesley, Menlo Park, 1998.

23.4 Transfer Functions and Laplace Transforms

C. Nelson Dorny

We perceive a system primarily through its behavior. Therefore, our mental image of a system usually includes representative response **signals**. The *step response*, the behavior when we suddenly turn on the system, is such a system-characterizing signal. We should view the step response as a description of the system. The *impulse response* is another description of the system. For a system represented by linear differential equations, the unit-step response is the integral of the unit-impulse response.

Let us represent time differentiation (d/dt) by the *time-derivative operator*, p . Then we can denote the time derivative of a signal y by py , its second derivative by p^2y , its integral with respect to time by $(1/p)y$, and so on. This *operator notation* simplifies the expressions for differential equations. We shall use the expression *system equations* to mean a set of differential equations that determines fully the behaviors of the dependent variables that appear in those equations. We can reduce a *linear* set of system equations to a single **input–output system equation** by eliminating all but one dependent variable from the set. The *transfer function* associated with that dependent variable is a mathematical expression that contains all the essential information embodied in the system differential equation.

The Laplace transformation converts signals (functions of time) to functions of a *complex-frequency variable*, $s = \sigma + j\omega$. There is a one-to-one correspondence between a signal and its Laplace transform. We can retrieve the time function by inverse transformation. Laplace transformation produces images that have some properties that are more convenient than those of the original signals. In particular, time differentiating a signal corresponds to multiplying its Laplace transform by the complex-frequency variable s . Hence, the transformation converts linear constant-coefficient differential equations to linear algebraic equations. Such simplifications of time-domain operations make Laplace transformation useful.

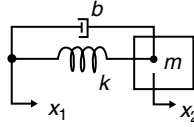

FIGURE 23.25 The lumped model of a mechanical system.

The Laplace transformation also converts the impulse response of a system variable to the transfer function for that variable. As a consequence, we can view the differential equation that represents a linear system as an expression of the response of that system to an impulsive input.

Transfer Functions

The node displacements x_1 and x_2 and the compressive forces f_1 and f_2 within the branches of the lumped model of Fig. 23.25 are related to each other by the spring equation, the damper equation, and the balance of forces at node 2. The spring equation is $f_2 = k(x_1 - x_2)$. The equation for the damper is $f_1 = b(px_1 - px_2)$. The balance of forces requires that $f_1 + f_2 = mp^2x_2$. These equations describe fully the behavior of the system if the spring and mass are unenergized. (If the mass were moving and/or the spring were compressed, we would have to express separately their initial energy states to describe fully the future relations among the variables.)

Eliminate f_1 and f_2 from the equations to obtain the operational equation:

$$(mp^2 + bp + k)x_2 = (bp + k)x_1 \tag{23.152}$$

This differential equation describes fully the **zero-state** relation between x_1 and x_2 . Rearrange Eq. (23.152) to form the ratio

$$\frac{x_2}{x_1} = \frac{bp + k}{mp^2 + bp + k} \tag{23.153}$$

We call Eq. (23.152) the *transfer function* from x_1 to x_2 . The transfer function focuses attention on the mathematical operations that characterize the behavioral relationships rather than on the particular natures of the variables. (Note that the transfer function from v_1 to v_2 , where $v_1 = px_1$ and $v_2 = px_2$, is the same as the transfer function given by Eq. (23.153).)

In general, suppose that y_1 and y_2 are two variables related (in operator notation) by the linear differential equation

$$y_2 = G(p)y_1 \tag{23.154}$$

We formally define the *transfer function* from y_1 to y_2 by

$$G(p) = \left. \frac{y_2}{y_1} \right|_{\text{ZS}} \tag{23.155}$$

where the notation ZS means **zero state**. If y_1 is an independent variable, then $G(p)$ is the *input-output transfer function* for the variable y_2 and accounts fully for its behavior owing to the **input signal** y_1 . We can determine from that transfer function the behavior of the system for any source waveform and any initial state.

The Laplace Transformation

The *one-sided Laplace transformation*, \mathcal{L} , is an integral operator that converts a signal $f(t)$ to a complex-valued function $F(s)$ in the following fashion:

$$\mathcal{L}[f(t)] \equiv F(s) \triangleq \int_{0^-}^{\infty} f(t)e^{-st} dt \quad (23.156)$$

We refer to the transformed function $F(s)$ as the *Laplace transform* of the signal $f(t)$. Picture the lower limit 0^- of the integral as a *specific* instant prior to but infinitesimally close to $t = 0$. It is customary to use a lowercase symbol (f) to represent a signal waveform and an uppercase symbol (F) to represent its Laplace transform. (Although we speak here of time signals, there is nothing in Eq. (23.156) that requires $f(t)$ to be a function of time. The transformation can be applied to functions of any quantity t .)

We shall use the Laplace transformation to transform the signals of **time-invariant** linear systems. The behavior of such a system for $t \geq 0$ depends only on the input signal for $t \geq 0$ and on the prior **state** of the output variable (at $t = 0^-$). Hence, it does not matter that the Laplace transformation ignores $f(t)$ for $t < 0^-$.

The process of finding the time function $f(t)$ that corresponds to a particular Laplace transform $F(s)$ is called *inverse Laplace transformation*, and is denoted by \mathcal{L}^{-1} . We also call $f(t)$ the *inverse Laplace transform* of $F(s)$. Since the one-sided Laplace transformation ignores $t < 0^-$, $F(s)$ contains no information about $f(t)$ for $t < 0^-$. Therefore, inverse Laplace transformation cannot reconstruct $f(t)$ for $t < 0^-$. We shall treat all signals as if they are defined only for $t \geq 0^-$. Then there is a one-to-one relation between $f(t)$ and $F(s)$.

To illustrate the Laplace transformation, we find the Laplace transform of the decaying exponential, $f(t) = e^{-\alpha t}$, $t \geq 0^-$. The transform is

$$\begin{aligned} F(s) &= \int_{0^-}^{\infty} e^{-\alpha t} e^{-st} dt = \left. \frac{e^{-(s+\alpha)t}}{-(s+\alpha)} \right|_{0^-}^{\infty} \\ &= \left. \frac{e^{-(\sigma+\alpha)t} e^{-j\omega t}}{-(s+\alpha)} \right|_{0^-}^{\infty} = \frac{1}{s+\alpha} \quad \text{for } \text{Re}[s] > -\alpha \end{aligned} \quad (23.157)$$

We must require $\sigma > -\alpha$, where σ is the real part of s , in order that the real-exponent factor converge to zero at the upper limit. (The magnitude of the complex-exponent factor remains 1 for all t .) Therefore, the Laplace transform of the decaying exponential is defined only for $\text{Re}[s] > -\alpha$. This restriction on the domain of F in the complex s plane is comparable to the restriction $t \geq 0^-$ on the domain of f .

The significant features of the complex-frequency function $1/(s + \alpha)$ are the existence of a single pole and the location of that pole, $s = -\alpha$ [rad/s]. (The pole defines the left boundary of that region of the complex s plane over which the transform $1/(s + \alpha)$ is defined.) The significant features of the corresponding time function are the fact of decay and the rate of decay, with the exponent $-\alpha$ [rad/s]. There are clear parallels between the features of $f(t)$ and $F(s)$. We should think of the whole complex-valued function F as representing the whole time waveform f .

As a second transformation example, let $f(t) = \delta(t)$, the unit impulse, essentially a unit-area pulse of very short duration. It acts at $t = 0$, barely within the lower limit of the Laplace integral. It has value zero at $t = 0^-$. (Because we use 0^- as the lower limit of the defining integral, it does not matter whether the impulse straddles $t = 0$ or begins to rise at $t = 0$.) The impulse is nonzero only for $t \approx 0$, where $e^{-st} \approx 1$. Therefore, the Laplace transform is

$$\Delta(s) = \int_{0^-}^{\infty} \delta(t)e^{-st} dt \approx \int_{0^-}^{\infty} \delta(t)(1) dt = 1 \quad (23.158)$$

Table 23.11 Laplace Transform Pairs

| $f(t) = \mathcal{L}^{-1}[\mathbf{F}(s)], t \geq 0^-$ | $\mathbf{F}(s) = \mathcal{L}[f(t)]$ |
|--|--|
| 1. Unit impulse $\delta(t)$ | 1 |
| 2. Unit step $u_s(t)$ | $\frac{1}{s}$ |
| 3. $t^n, n = 1, 2, \dots$ | $\frac{n!}{s^{n+1}}$ |
| 4. $e^{-\alpha t}$ | $\frac{1}{s + \alpha}$ |
| 5. $t^n e^{-\alpha t}, n = 1, 2, \dots$ | $\frac{n!}{(s + \alpha)^{n+1}}$ |
| 6. $\sin(\omega_0 t)$ | $\frac{\omega_0}{s^2 + \omega_0^2}$ |
| 7. $\cos(\omega_0 t)$ | $\frac{s}{s^2 + \omega_0^2}$ |
| 8. $e^{-\alpha t} \sin(\omega_d t)$ | $\frac{\omega_d}{(s + \alpha)^2 + \omega_d^2}$ |
| 9. $e^{-\alpha t} \cos(\omega_d t)$ | $\frac{s + \alpha}{(s + \alpha)^2 + \omega_d^2}$ |

Source: Dorny, C. N. 1993. *Understanding Dynamic Systems*, p. 412. Prentice-Hall, Englewood Cliffs, NJ. With permission.

It is not necessary to derive the Laplace transform for each signal that we use in the study of systems. [Table 23.11](#) gives the transforms for some signal waveforms that are common in dynamic systems.

Transform Properties

A number of useful properties of the Laplace transformation \mathcal{L} are summarized in [Table 23.12](#). According to the derivative property, the multiplier s acts precisely like the time-derivative operator, but in the domain of Laplace-transformed signals. When we Laplace transform the equation for an energy-storage element such as a mass or a spring, the derivative property automatically incorporates the prior energy

Table 23.12 Properties of the Laplace Transformation, \mathcal{L}

| | |
|-------------------------|---|
| 1. Magnification | $\mathcal{L}[af(t)] = a\mathbf{F}(s)$ |
| 2. Addition | $\mathcal{L}[f_1(t) + f_2(t)] = \mathbf{F}_1(s) + \mathbf{F}_2(s)$ |
| 3. Derivative | $\mathcal{L}[\dot{f}(t)] = s\mathbf{F}(s) - f(0^-)$ |
| 4. Derivatives | $\mathcal{L}[\ddot{f}(t)] = s^2\mathbf{F}(s) - sf(0^-) - \dot{f}(0^-)$ |
| 5. Integral | $\mathcal{L}\left[\int_0^t f(t) dt\right] = \frac{\mathbf{F}(s)}{s}$ |
| 6. Convolution | $\mathcal{L}\left[\int_0^t f_1(\lambda)f_2(t-\lambda) d\lambda\right] = \mathbf{F}_1(s)\mathbf{F}_2(s)$ |
| 7. Initial value | $f(0^+) = \lim_{t \rightarrow 0^+} f(t) = \lim_{s \rightarrow \infty} s\mathbf{F}(s)$ |
| 8. Final Value | $f(\infty) = \lim_{t \rightarrow \infty} f(t) = \lim_{s \rightarrow 0} s\mathbf{F}(s)$ if finite |
| 9. Definite integral | $\int_0^\infty f(t) dt = \lim_{s \rightarrow 0} s\mathbf{F}(s)$ if finite |
| 10. Exponential decay | $\mathcal{L}[e^{-\alpha t}f(t)] = \mathbf{F}(s + \alpha)$ |
| 11. Delay | $\mathcal{L}[f(t - t_0)u_s(t - t_0)] = e^{-t_0 s}\mathbf{F}(s)$ for $t_0 \geq 0$ |
| 12. Time multiplication | $\mathcal{L}[tf(t)] = -\frac{d\mathbf{F}(s)}{ds}$ |
| 13. Time division | $\mathcal{L}\left[\frac{f(t)}{t}\right] = \int_s^\infty \mathbf{F}(s) ds$ |
| 14. Time scaling | $\mathcal{L}[f(at)] = \frac{\mathbf{F}(s/a)}{a}$ |

Source: Dorny, C. N. 1993. *Understanding Dynamic Systems*, p. 413. Prentice-Hall, Englewood Cliffs, NJ. With permission.

state of the element—essentially the value of the variable at $t = 0^-$. When we Laplace transform the input–output system equation for a particular system variable, the derivative property automatically incorporates the whole prior system state. As a consequence, we can find the solution to the system equation without having to determine the initial conditions (at $t = 0^+$)—a considerable simplification of the solution process.

Since $F(s)$ contains all information about $f(t)$ for $t \geq 0^-$, it is possible to find some features of the signal $f(t)$ from the transform $F(s)$ without performing an inverse Laplace transformation. Properties 7–9 of Table 23.12 provide three of these features, namely the initial value ($t \rightarrow 0^+$), the final value ($t \rightarrow \infty$), and the area under the waveform. The remaining properties in the table show the effect on the transform of various changes in the signal waveform.

The usual approach to finding inverse transforms is to use a table of transform pairs. That table might be stored in a software package such as CC, MATLAB, MAPLE, and so on. Table 23.11 demonstrates that transforms of typical system signals are ratios of polynomials in s . A ratio of polynomials can be decomposed into a sum of *simple* polynomial fractions—a process referred to as *partial fraction expansion*. Hence, the inversion process can be accomplished by a computer program that incorporates a brief table of transforms.

Transformation and Solution of a System Equation

Suppose that an independent external source applies a specific velocity pattern $v_1(t)$ to node 1 of Fig. 23.25. To obtain the input–output system equation that relates the velocity v_2 of node 2 to the input signal v_1 , multiply Eq. (23.153) by p and substitute v_1 for px_1 and v_2 for px_2 . The result is

$$(mp^2 + bp + k)v_2 = (bp + k)v_1 \quad (23.159)$$

The two sides of Eq. (23.159) are identical functions of time. Therefore, the Laplace transforms of the two sides of Eq. (23.159) are equal. Since the Laplace transformation is linear (properties 1 and 2 of Table 23.12), and since the coefficients of the differential equation are constants, the Laplace transform can be applied separately to the individual terms of each side. The result is

$$m[s^2V_2(s) - sv_2(0^-) - \dot{v}_2(0^-)] + b[sV_2(s) - v_2(0^-)] + kV_2(s) = b[sV_1(s) - v_1(0^-)] + kV_1(s) \quad (23.160)$$

where the derivative properties of the Laplace transformation (properties 3 and 4 of Table 23.12) introduce the prior values $v_1(0^-)$, $v_2(0^-)$, and $\dot{v}_2(0^-)$ into the equation. According to Eq. (23.160), to fully determine the transform $V_2(s)$ of the behavior $v_2(t)$, we must specify these prior values and also $V_1(s)$. It can be shown that specifying the three prior values is equivalent to specifying the energy states of the spring and mass.

Let us assume that the independent source applies the constant velocity $v_1(t) = v_c$ beginning at $t = 0$. The corresponding transform, by item 2 of Table 23.11 and property 1 of Table 23.12, is $V_1(s) = v_c/s$. Substitute the transform $V_1(s)$ into Eq. (23.160) and solve for

$$V_2(s) = \frac{(bs + k)v_c + ms\dot{v}_2(0^-) + bs[v_2(0^-) - v_1(0^-)] + ms^2v_2(0^-)}{s(ms^2 + bs + k)} \quad (23.161)$$

We could find the output signal waveform $v_2(t)$ as a function of the model parameters m , k , b , the source-signal parameter v_c , and the prior state information $v_1(0^-)$, $v_2(0^-)$, and $\dot{v}_2(0^-)$, but the expression for the solution would be messy. Instead, we complete the solution process for specific numbers: $m = 2$ kg, $b = 4$ N · s/m, $k = 10$ N/m, $\dot{v}_2(0^-) = 0$ m/s², $v_1(0^-) = 0$ m/s, $v_2(0^-) = -1$ m/s, and $v_c = 1$ m/s. The partial-fraction expansion of the transform and the inverse transform, both obtained by a commercial computer program, are

$$V_2(s) = \frac{1}{s} - \frac{2s + 2}{(s + 1)^2 + 2^2} \quad (23.162)$$

$$v_2(t) = 1 - 2e^{-t} \cos(2t), \quad \text{for } t \geq 0 \quad (23.163)$$

We can take Laplace transforms of the system equations at any stage in their development. We can even write the equations directly in terms of transformed variables if we wish. The process of eliminating variables can be carried out as well in one notation as in another. For example, the operator $G(p)$ in Eq. (23.154) represents a ratio of polynomials in the time-derivative operator p . Therefore, Laplace transforming the differential equation, Eq. (23.154), introduces the prior values of various derivatives of y_1 and y_2 . If the prior values of all these derivatives are zero, then the Laplace-transformed equation is

$$Y_2(s) = G(s)Y_1(s) \quad (23.164)$$

where the operator p in Eq. (23.154) is replaced by the complex-frequency variable s in Eq. (23.164). It is appropriate, therefore, to define the transfer function directly in terms of Laplace-transformed signals:

$$G(s) = \left. \frac{Y_2(s)}{Y_1(s)} \right|_{PV=0} \quad (23.165)$$

where $Y_1(s)$ and $Y_2(s)$ are the Laplace transforms of the signals $y_1(t)$ and $y_2(t)$, and the notation $PV = 0$ means that the prior values (at $t = 0^-$) of $y_1(t)$ and $y_2(t)$ and the various derivatives mentioned above in connection with Eq. (23.164) are set to zero. The *frequency domain* definition, Eq. (23.165), is equivalent to the *time domain* definition, Eq. (23.155).

Suppose that the input signal $y_1(t)$ is the unit impulse $\delta(t)$. Then the response signal $y_2(t)$ is the unit-impulse response of the system. Since the Laplace transform of the unit impulse is $Y_1(s) = \Delta(s) = 1$ by entry 1 of Table 23.11, Eq. (23.164) shows that the Laplace transform $Y_2(s)$ of the unit-impulse response is identical to the zero-state transfer function (expressed in the transform domain).

The transfer function for a linear system has two interpretations. Both interpretations characterize the system. In the frequency domain, the transfer function $G(s)$ is the multiplier that produces the response—by multiplying the source-signal transform, as in Eq. (23.164). In the time domain, we use a representative response signal—the impulse response—to characterize the system. The transfer function $G(s)$ is the Laplace transform of that characteristic response.

Defining Terms

Input: An independent variable.

Input–output system equation: A differential equation that describes the behavior of a single dependent variable as a function of time. The dependent variable is viewed as the system output. The independent variable(s) are the inputs.

Output: A dependent variable.

Signal: An observable variable; a quantity that reveals the behavior of a system.

State: The state of an n th-order linear system corresponds to the values of a dependent variable and its first $n - 1$ time derivatives.

Time invariant: A system that can be represented by differential equations with constant coefficients.

Zero state: A condition in which no energy is stored or in which all variables have the value zero.

References

- Franklin, G. F., Powell, J. D., and Emami-Naeini, A. 1994. *Feedback Control of Dynamic Systems*, 3rd ed., Addison Wesley, Reading, MA.
- Kuo, B. C. 1991. *Automatic Control Systems*, 6th ed., Prentice-Hall, Englewood Cliffs, NJ.
- Nise, N. S. 1992. *Control Systems Engineering*, Benjamin Cumming, Redwood City, CA.

Further Information

A thorough mathematical treatment of Laplace transforms is presented in *Advanced Engineering Mathematics*, by C. Ray Wylie and Louis C. Barrett. *Understanding Dynamic Systems*, by C. Nelson Dorny, applies transfer functions and related concepts in a variety of contexts. The following journals publish papers that use transfer functions and Laplace transforms:

IEEE Transactions on Automatic Control. Published monthly by the Institute of Electrical and Electronics Engineers.

IEEE Transactions on Systems, Man, and Cybernetics. Published bimonthly.

Journal of Dynamic Systems, Measurement, and Control. Published quarterly by the American Society of Mechanical Engineers.

24

State Space Analysis and System Properties

- 24.1 Models: Fundamental Concepts
- 24.2 State Variables: Basic Concepts
Introduction • Basic State Space Models • Signals and State
Space Description
- 24.3 State Space Description for Continuous-Time
Systems
Linearization • Linear State Space models • State Similarity
Transformation • State Space and Transfer Functions
- 24.4 State Space Description for Discrete-Time
and Sampled Data Systems
Linearization of Discrete-Time Systems • Sampled Data
Systems • Linear State Space Models • State Similarity
Transformation • State Space and Transfer Functions
- 24.5 State Space Models for Interconnected
Systems
- 24.6 System Properties
Controllability, Reachability, and Stabilizability
• Observability, Reconstructibility, and Detectability
• Canonical Decomposition • PBH Test
- 24.7 State Observers
Basic Concepts • Observer Dynamics • Observers and
Measurement Noise
- 24.8 State Feedback
Basic Concepts • Feedback Dynamics • Optimal State
Feedback. The Optimal Regulator
- 24.9 Observed State Feedback
Separation Strategy • Transfer Function Interpretation for
the Single-Input Single-Output Case

Mario E. Salgado

*Universidad Técnica Federico
Santa María*

Juan I. Yuz

*Universidad Técnica Federico
Santa María*

24.1 Models: Fundamental Concepts

An essential connection between an engineer/scientist and a system relies on his/her ability to describe the system in a way which is useful to understand and to quantify its behavior.

Any description supporting that connection is a **model**. In system theory, models play a fundamental role, since they are needed to analyze, to synthesize, and to design systems of all imaginable sorts.

There is not a unique model for a given system. Firstly, the need for a model may obey different purposes. For instance, when dealing with an electric motor, we might be interested in the electro-mechanical energy conversion process, alternatively, we might be interested in modelling the motor either as a thermal system, or as a mechanical system to study vibrations, the strength of the materials, and so on.

A second source of that nonuniqueness is the fact that models are always inaccurate, since real systems are usually infinitely complex. One of the key decisions for an engineer when facing the task of **modelling** a system is to decide which are the essential features that the model should capture, and that decision is also closely related to the purpose of the model.

The theory supporting modelling is by itself a vast field, where first principles, signal theory, mathematics and numerical tools combine in different ways to generate rich methodologies. A model is rarely built in one go, the model building process is usually iterative, and it progresses according to the quality of the results obtained when using the model in a particular application. Iterations may also include changes in modelling methodology.

In this chapter we will deal with a special class of models to describe *dynamic systems*. Dynamic systems are those where the system variables are interdependent not only algebraically, but also in a way where we observe the intervention of accumulated effects and rate of change. Models for dynamic systems can be built in the continuous time domain, in the discrete time domain, or in a continuous-discrete time framework (for hybrid systems, involving sampled systems). We will cover the three situations.

In this quest we will put the emphasis on concepts, fundamental properties, physical interpretations, and examples. We will include neither proofs nor intricate theoretical developments. Sometimes we will sacrifice rigor for the sake of an easier understanding. To cover in depth the theory supporting our presentation we refer the interested reader to the specialized literature such as [6,8,10–14].

24.2 State Variables: Basic Concepts

Introduction

One of the most frequently used class of models is that defined by a set of equations on a set of system inner variables. These inner variables are known as **state variables**. The values they have at a specific time instant form a set known as the **system state**, although we will often use the expressions *state variables* and *system state* as synonyms.

The above definition is too vague since it would fit to any set of system variables. What is distinctive in the set of state variables is clarified in the following definition.

A set of state variables for the given system is a set of system inner variables such that any system variable can be computed as a function of the present state and the present and future system inputs.

In this definition we have preferred to stress the physical meaning of state variables. However, a more abstract definition is also possible. The definition also implies that if we know the state at time t we can then compute the energy stored in the system at that instant. The energy stored in a system depends on some system variables (speed, voltage, current, position, temperature, pressure, etc.) and all of them, by definition, can be computed from the system state.

The above definition suggests that one can think of the state in a more general way: the state variables can be chosen as a **function** (e.g., a linear combination) of inner system variables. This generalization builds some distance between the state and its physical interpretation. However, it has the advantage of making the framework more general. It also makes more evident an interesting feature: the **choice of state variables is not unique**.

Another important observation is that the time evolution of the state, the state trajectory itself, can be computed from the present value of the state and the present and future inputs. Thus, the models involved are first order differential (continuous time) or one-step recursive (discrete time) equations.

Basic State Space Models

If we denote by \mathbf{x} the vector corresponding to a particular choice of state variables, the general form of a state variable model is as follows:

For continuous-time systems

$$\frac{dx}{dt} = F(x(t), u(t), t) \tag{24.1}$$

$$y(t) = G(x(t), u(t), t) \tag{24.2}$$

where $u(t)$ is the system **input vector** and $y(t)$ is an **output vector**.

For discrete-time systems

$$x[t + 1] = F_d(x[t], u[t], t) \tag{24.3}$$

$$y[t] = G_d(x[t], u[t], t) \tag{24.4}$$

Similarly to the continuous-time case, $u[t]$ is the system **input vector** and $y[t]$ is an **output vector**.

Note that throughout this chapter we will use the symbol t to denote continuous and discrete time, but the difference will be made on using [and] to enclose the argument in the discrete-time case, when $t \in \mathbb{Z}$.

To obtain a first glimpse at the concepts underlying the state space approach, we consider the following example.

Example 24.1

In Fig. 24.1, an external force $f(t)$ is applied to a mass-spring system. The position $d(t)$ is measured with respect to the mass position when the spring is relaxed and no external force is applied. The mass movement is damped by a viscous friction force proportional to the mass velocity, $v(t)$.

From first principles we know that to be able to compute the mass position and the mass velocity we must know the initial mass velocity, and the initial spring stretching. Thus, the state vector must have two components, i.e., $x(t) = [x_1(t) \ x_2(t)]^T$, and a natural state choice is

$$x_1(t) = d(t) \tag{24.5}$$

$$x_2(t) = v(t) = \dot{x}_1(t) \tag{25.6}$$

With this choice, one can apply Newton laws to obtain

$$f(t) = M \frac{dv(t)}{dt} + Kd(t) + Dv(t) = M\dot{x}_2(t) + Kx_1(t) + Dx_2(t) \tag{24.7}$$

where D is the viscous friction proportional constant. We are now in position to write the state equations as

$$\dot{x}_1(t) = x_2(t) \tag{24.8}$$

$$\dot{x}_2(t) = -\frac{K}{M}x_1(t) - \frac{D}{M}x_2(t) + \frac{1}{M}f(t) \tag{24.9}$$

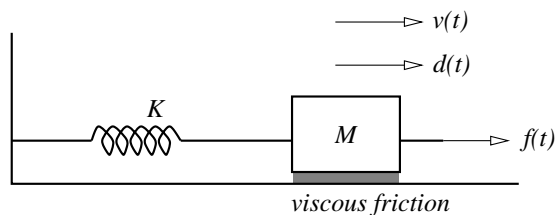

FIGURE 24.1 Mechanical system.

We also observe that the energy, $w(t)$, stored in the system is given by

$$w(t) = \frac{1}{2}K(d(t))^2 + \frac{1}{2}M(v(t))^2 = \mathbf{x}(t)^T \mathbf{L}\mathbf{x}(t) \quad (24.10)$$

where \mathbf{L} is a diagonal matrix: $\mathbf{L} = \text{diag} \left[\frac{K}{2}, \frac{M}{2} \right]$.

Finally, the nonuniqueness of the state vector can be appreciated if, instead of the choices made in (24.8), we choose a new state $\bar{\mathbf{x}}(t)$ related to $\mathbf{x}(t)$ by a nonsingular matrix $\mathbf{T} \in \mathbb{R}^{2 \times 2}$, i.e.,

$$\bar{\mathbf{x}}(t) = \mathbf{T}\mathbf{x}(t) \quad (24.11)$$

More on this will be said in subsection “State Similarity Transformation.”

Signals and State Space Description

The state space framework can also be used to describe a wide variety of signals using a model of the form

$$\frac{d\mathbf{x}(t)}{dt} = \mathbf{A}\mathbf{x}(t), \quad y(t) = \mathbf{C}\mathbf{x}(t) \quad \text{for continuous-time signals} \quad (24.12)$$

$$\mathbf{x}[t+1] = \mathbf{A}_q\mathbf{x}[t], \quad y[t] = \mathbf{C}_q\mathbf{x}[t] \quad \text{for discrete-time signals} \quad (24.13)$$

To illustrate the idea we consider a continuous-time signal given by

$$f(t) = 2 + 4\cos(5t) - \sin(5t) \quad (24.14)$$

This signal can be interpreted as the solution for the homogeneous differential equation

$$\frac{d^3 f(t)}{dt^3} + 25 \frac{df(t)}{dt} = 0, \quad \text{subject to } f(0) = 6, \dot{f}(0) = -5 \text{ and } \ddot{f}(0) = -100 \quad (24.15)$$

If we now choose, as state variables, $x_1(t) = f(t)$, $x_2(t) = \dot{f}(t)$, and $x_3(t) = \ddot{f}(t)$, then the state space model for this signal is

$$\frac{d\mathbf{x}(t)}{dt} = \begin{bmatrix} 0 & 1 & 0 \\ 0 & 0 & 1 \\ 0 & -25 & 0 \end{bmatrix} \mathbf{x}(t), \quad y(t) = [1 \quad 0 \quad 0] \mathbf{x}(t) \quad (24.16)$$

In this usage of state space models, the state variables have no particular physical meaning. However, this description is particularly useful in signal reconstruction theory and when dealing with disturbances in control system synthesis.

24.3 State Space Description for Continuous-Time Systems

In this section the state space description for continuous-time systems is presented. The analysis is focused on the class of **linear and time invariant** systems; to do that, we first show how to build a linear model from the nonlinear equations (24.1) and (24.2).

An additional restriction is that, at this stage, the systems under study have no pure time delays. This feature generates an infinite dimensional state vector. However, we will see in [section 24.4](#) that this class of systems can be successfully dealt with using sampled data models.

Linearization

Since we will concentrate on time invariant systems, (24.1) and (24.2) can be rewritten as

$$\frac{d\mathbf{x}}{dt} = \mathbf{F}(\mathbf{x}(t), \mathbf{u}(t)) \quad (24.17)$$

$$\mathbf{y}(t) = \mathbf{G}(\mathbf{x}(t), \mathbf{u}(t)) \quad (24.18)$$

We assume that the model (24.17) and (24.18) has at least one *equilibrium point* given by $\{\mathbf{x}_Q, \mathbf{u}_Q, \mathbf{y}_Q\}$. This is a triad conformed by three constant vectors satisfying

$$\mathbf{0} = \mathbf{F}(\mathbf{x}_Q, \mathbf{u}_Q) \quad (24.19)$$

$$\mathbf{y}_Q = \mathbf{G}(\mathbf{x}_Q, \mathbf{u}_Q) \quad (24.20)$$

Note that the equilibrium point is defined by the state derivatives equal to zero.

If we now consider a neighborhood around the equilibrium point, then we can approximate the model (24.17) and (24.18) by a truncated Taylor's series having the form

$$\dot{\mathbf{x}}(t) \approx \mathbf{F}(\mathbf{x}_Q, \mathbf{u}_Q) + \left. \frac{\partial \mathbf{F}}{\partial \mathbf{x}} \right|_{\substack{\mathbf{x}=\mathbf{x}_Q \\ \mathbf{u}=\mathbf{u}_Q}} (\mathbf{x}(t) - \mathbf{x}_Q) + \left. \frac{\partial \mathbf{F}}{\partial \mathbf{u}} \right|_{\substack{\mathbf{x}=\mathbf{x}_Q \\ \mathbf{u}=\mathbf{u}_Q}} (\mathbf{u}(t) - \mathbf{u}_Q) \quad (24.21)$$

$$\mathbf{y}(t) \approx \mathbf{G}(\mathbf{x}_Q, \mathbf{u}_Q) + \left. \frac{\partial \mathbf{G}}{\partial \mathbf{x}} \right|_{\substack{\mathbf{x}=\mathbf{x}_Q \\ \mathbf{u}=\mathbf{u}_Q}} (\mathbf{x}(t) - \mathbf{x}_Q) + \left. \frac{\partial \mathbf{G}}{\partial \mathbf{u}} \right|_{\substack{\mathbf{x}=\mathbf{x}_Q \\ \mathbf{u}=\mathbf{u}_Q}} (\mathbf{u}(t) - \mathbf{u}_Q) \quad (24.22)$$

Equations (24.21) and (24.22) can then be written as

$$\frac{d\Delta\mathbf{x}(t)}{dt} = \mathbf{A}\Delta\mathbf{x}(t) + \mathbf{B}\Delta\mathbf{u}(t) \quad (24.23)$$

$$\Delta\mathbf{y}(t) = \mathbf{C}\Delta\mathbf{x}(t) + \mathbf{D}\Delta\mathbf{u}(t) \quad (24.24)$$

where

$$\Delta\mathbf{x}(t) = \mathbf{x}(t) - \mathbf{x}_Q, \quad \Delta\mathbf{u}(t) = \mathbf{u}(t) - \mathbf{u}_Q, \quad \Delta\mathbf{y}(t) = \mathbf{y}(t) - \mathbf{y}_Q \quad (24.25)$$

and

$$\mathbf{A} = \left. \frac{\partial \mathbf{F}}{\partial \mathbf{x}} \right|_{\substack{\mathbf{x}=\mathbf{x}_Q \\ \mathbf{u}=\mathbf{u}_Q}}, \quad \mathbf{B} = \left. \frac{\partial \mathbf{F}}{\partial \mathbf{u}} \right|_{\substack{\mathbf{x}=\mathbf{x}_Q \\ \mathbf{u}=\mathbf{u}_Q}}, \quad \mathbf{C} = \left. \frac{\partial \mathbf{G}}{\partial \mathbf{x}} \right|_{\substack{\mathbf{x}=\mathbf{x}_Q \\ \mathbf{u}=\mathbf{u}_Q}}, \quad \mathbf{D} = \left. \frac{\partial \mathbf{G}}{\partial \mathbf{u}} \right|_{\substack{\mathbf{x}=\mathbf{x}_Q \\ \mathbf{u}=\mathbf{u}_Q}} \quad (24.26)$$

The linearization ideas presented above are illustrated in the following example.

Example 24.2

Consider the magnetic levitation system shown in [Fig. 24.2](#).

The metallic sphere is subject to two forces: its own weight, mg , and the attraction force generated by the electromagnet, $f(t)$. The electromagnet is commanded through a voltage source, $e(t) > 0, \forall t$.

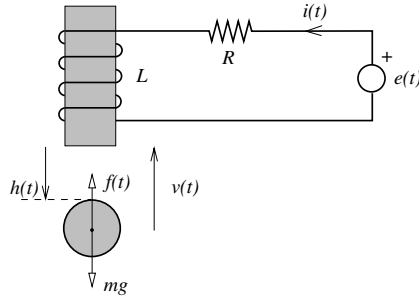

FIGURE 24.2 Magnetic levitation system.

The attraction force on the sphere, $f(t)$, depends on the distance $h(t)$ and the current, $i(t)$. This relation can be approximately described by

$$f(t) = \frac{K_1}{h(t) + K_2} i(t) \quad (24.27)$$

where K_1 and K_2 are positive constants.

Using first principles we can write

$$e(t) = Ri(t) + L \frac{di(t)}{dt} \quad (24.28)$$

$$v(t) = -\frac{dh(t)}{dt} \quad (24.29)$$

$$f(t) = \frac{K_1}{h(t) + K_2} i(t) = mg + m \frac{dv(t)}{dt} \quad (24.30)$$

We next choose as state variables: the current $i(t)$, the sphere position $h(t)$, and the sphere speed $v(t)$, i.e.,

$$x(t) = [x_1(t) \ x_2(t) \ x_3(t)]^T = [i(t) \ h(t) \ v(t)]^T \quad (24.31)$$

Then, from (24.28)–(24.30) we can set the system description as in (24.1) yielding

$$\frac{di(t)}{dt} = \frac{dx_1(t)}{dt} = -\frac{R}{L}x_1(t) + \frac{1}{L}e(t) \quad (24.32)$$

$$\frac{dh(t)}{dt} = \frac{dx_2(t)}{dt} = -x_3(t) \quad (24.33)$$

$$\frac{dv(t)}{dt} = \frac{dx_3(t)}{dt} = \frac{K_1}{m(x_2(t) + K_2)}x_1(t) - g \quad (24.34)$$

Before one can build the linearized model, an equilibrium point has to be computed. The driving input in this system is the source voltage $e(t)$. Say that the equilibrium point is obtained with $e(t) = E_Q$.

Hence, the state in equilibrium can be computed from (24.32) to (24.34), setting all the derivatives equal to zero, i.e.,

$$-\frac{R}{L}x_{1Q} + \frac{1}{L}E_Q = 0 \Rightarrow x_{1Q} = \frac{E_Q}{R} \quad (24.35)$$

$$-x_{3Q} = 0 \Rightarrow x_{3Q} = 0 \quad (24.36)$$

$$\frac{K_1}{m(x_{2Q} + K_2)}x_{1Q} - g = 0 \Rightarrow x_{2Q} = \frac{K_1}{mg}x_{1Q} - K_2 = \frac{K_1E_Q}{mgR} - K_2 \quad (24.37)$$

The setting now is adequate to build the linearized model in the incremental input $\Delta e(t)$ and the incremental state $\Delta \mathbf{x}(t) = [\Delta x_1(t) \quad \Delta x_2(t) \quad \Delta x_3(t)]^T$. The result is

$$\frac{d\Delta x_1(t)}{dt} = -\frac{R}{L}\Delta x_1(t) + \frac{1}{L}\Delta e(t) \quad (24.38)$$

$$\frac{d\Delta x_2(t)}{dt} = -\Delta x_3(t) \quad (24.39)$$

$$\frac{d\Delta x_3(t)}{dt} = \frac{Rg}{E_Q}\Delta x_1(t) - \frac{Rmg^2}{K_1E_Q}\Delta x_2(t) \quad (24.40)$$

If we define as the system output, the sphere position $h(t)$, we can then compare the above equations with (24.23) and (24.24) to obtain

$$\mathbf{A} = \begin{bmatrix} -\frac{R}{L} & 0 & 0 \\ 0 & 0 & -1 \\ \frac{Rg}{E_Q} & -\frac{Rmg^2}{K_1E_Q} & 0 \end{bmatrix}, \quad \mathbf{B} = \begin{bmatrix} \frac{1}{L} \\ 0 \\ 0 \end{bmatrix}, \quad \mathbf{C} = \begin{bmatrix} 0 \\ 1 \\ 0 \end{bmatrix}, \quad \mathbf{D} = 0 \quad (24.41)$$

In the sequel we will drop the prefix Δ , but the reader should bear in mind that the model above is linear in the **incremental** components of the state, the inputs and the outputs around a chosen equilibrium point.

Linear State Space Models

Our starting point is now the linear time invariant state space model

$$\frac{d\mathbf{x}(t)}{dt} = \mathbf{A}\mathbf{x}(t) + \mathbf{B}\mathbf{u}(t) \quad (24.42)$$

$$\mathbf{y}(t) = \mathbf{C}\mathbf{x}(t) + \mathbf{D}\mathbf{u}(t) \quad (24.43)$$

The solution to Eq. (24.42), subject to $\mathbf{x}(t_0) = \mathbf{x}_0$, is given by

$$\mathbf{x}(t) = e^{\mathbf{A}(t-t_0)}\mathbf{x}_0 + \int_{t_0}^t e^{\mathbf{A}(t-\tau)}\mathbf{B}\mathbf{u}(\tau) d\tau \quad \forall t \geq t_0 \quad (24.44)$$

where the **transition matrix** e^{At} satisfies

$$e^{At} = \mathbf{I} + \sum_{k=1}^{\infty} \frac{1}{k!} \mathbf{A}^k t^k \quad (24.45)$$

The interested reader can check that (24.44) satisfies (24.43). To do that he/she should use the Leibnitz's rule for the derivative of an integral.

With the above result, the solution for (24.43) is given by

$$\mathbf{y}(t) = \mathbf{C} e^{\mathbf{A}(t-t_0)} \mathbf{x}_0 + \mathbf{C} \int_{t_0}^t e^{\mathbf{A}(t-\tau)} \mathbf{B} \mathbf{u}(\tau) d\tau + \mathbf{D} \mathbf{u}(t) \quad (24.46)$$

System Dynamics

The state of the system has two components: the **unforced** component, $\mathbf{x}_u(t)$, and the **forced** component, $\mathbf{x}_f(t)$, where

$$\mathbf{x}_u(t) = e^{\mathbf{A}(t-t_0)} \mathbf{x}_0 \quad (24.47)$$

$$\mathbf{x}_f(t) = \int_{t_0}^t e^{\mathbf{A}(t-\tau)} \mathbf{B} \mathbf{u}(\tau) d\tau \quad (24.48)$$

To gain insight into the state space model and its solution, consider the case when $t_0 = 0$ and $u(t) = 0 \forall t \geq 0$, i.e., the state has only the **unforced part**. Then

$$\mathbf{x}(t) = e^{\mathbf{A}t} \mathbf{x}_0 \quad (24.49)$$

Further assume that $\mathbf{A} \in \mathbb{R}^n$ and that, for simplicity, it has distinct eigenvalues $\lambda_1, \lambda_2, \dots, \lambda_n$ with n (linearly independent) eigenvectors $\mathbf{v}_1, \mathbf{v}_2, \dots, \mathbf{v}_n$. Then there always exists a set of constants $\alpha_1, \alpha_2, \dots, \alpha_n$ such that

$$\mathbf{x}_0 = \sum_{\ell=1}^n \alpha_{\ell} \mathbf{v}_{\ell}, \quad \alpha_{\ell} \in \mathbb{C} \quad (24.50)$$

A well-known result from linear algebra tells us that the eigenvalues of \mathbf{A}^k are $\lambda_1^k, \lambda_2^k, \dots, \lambda_n^k$ with corresponding eigenvectors $\mathbf{v}_1, \mathbf{v}_2, \dots, \mathbf{v}_n$. The application of this result yields

$$\mathbf{x}(t) = e^{\mathbf{A}t} \mathbf{x}_0 = \mathbf{I} + \sum_{\ell=1}^n \alpha_{\ell} \sum_{k=1}^{\infty} \frac{1}{k!} \frac{\mathbf{A}^k \mathbf{v}_{\ell}}{\lambda_{\ell}^k \mathbf{v}_{\ell}} t^k = \sum_{\ell=1}^n \alpha_{\ell} e^{\lambda_{\ell} t} \mathbf{v}_{\ell} \quad (24.51)$$

This equation shows that the unforced component of the state is a linear combination of **natural modes**, $\{e^{\lambda_{\ell} t}\}$, each of which is associated with an eigenvalue of \mathbf{A} . Hence the matrix \mathbf{A} determines:

- the structure of the unforced response
- the stability (or otherwise) of the system
- the speed of response

When the matrix \mathbf{A} does not have a set of n independent eigenvectors, Jordan forms can be used (see, e.g., [9,10]).

Structure of the Unforced Response

In the absence of input, the state evolves as a combination of natural modes which belong to a defined class of functions: all those generated by exponentials with either real or complex exponents. Hence these modes include constants, real exponentials, pure sine waves, exponentially modulated sine waves, and some other special functions arising from repeated eigenvalues.

To illustrate these ideas and their physical interpretation consider the system in Example 24.1. For that system

$$\mathbf{A} = \begin{bmatrix} 0 & 1 \\ -\frac{K}{M} & -\frac{D}{M} \end{bmatrix} \quad (24.52)$$

Hence, the system eigenvalues are solutions to the equation

$$\det(\lambda\mathbf{I} - \mathbf{A}) = \lambda^2 + \frac{D}{M}\lambda + \frac{K}{M} = 0 \quad (24.53)$$

i.e.,

$$\lambda_{1,2} = -\frac{D}{2M} \pm \sqrt{\frac{D^2}{4M^2} - \frac{K}{M}} \quad (24.54)$$

Hence, when the damping is zero ($D = 0$), the system eigenvalues are a couple of conjugate imaginary numbers, and the two natural (complex) modes combine to yield a sustained oscillation with angular frequency $\omega_0 = \sqrt{K/M}$. This is in agreement with our physical intuition, since we expect a sustained oscillation to appear when the system has nonzero initial conditions even if the external force, $f(t)$, is zero.

When the system is slightly damped ($D^2 < 4KM$), the matrix eigenvalues are conjugate complex numbers, and the associated complex natural modes combine to yield an exponentially damped sine wave. This also agrees with intuition, since the energy initially stored in the mass and the spring will periodically go from the mass to the spring and vice versa but, at the end, it will completely dissipate, as heat, in the viscous friction.

Finally if the damping is high ($D^2 > 4KM$), the matrix eigenvalues are a couple of negative real numbers, and the natural modes are two decaying exponentials. The heavy damping will preclude oscillations and the initial energy will dissipate quickly.

The three different situations are illustrated in Fig. 24.3. For this simulation we have used three different values of the viscous friction constant D and

$$M = 2 \text{ kg}, \quad K = 0.1 \text{ N/m}, \quad d(0) = 0.3 \text{ m}, \quad v(0) = 0.05 \text{ m/s} \quad (24.55)$$

Note that, except when there is no friction ($D = 0$), the mass comes to rest asymptotically.

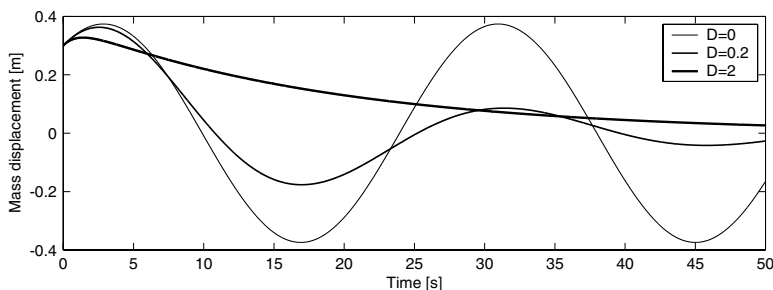

FIGURE 24.3 Unforced response of a mass-spring system.

Structure of the Forced Response

When the initial state is zero, the state will exhibit only the forced component. The forced component of the state will include natural modes and some additional **forced** or **particular** modes, which depend on the nature of the system input $\mathbf{u}(t)$. In general the forcing modes in the input will also appear in the state. However, some special cases arise when some of the forcing modes in $\mathbf{u}(t)$ coincide with some system natural modes.

System Stability

Stability in linear, time-invariant systems can also be analyzed using the state matrix \mathbf{A} .

All systems variables can be expressed as linear functions of the state and the system input. When the system input $\mathbf{u}(t)$ is a vector of bounded time functions, then the boundedness of the system variables depends on the state to be bounded.

We then have the following result:

Theorem 24.1 *Consider a system with the state description (24.42) and (24.43) where \mathbf{B} , \mathbf{C} , and \mathbf{D} have bounded elements. Then the system state (and hence the system output) is bounded for all bounded inputs if and only if the eigenvalues of \mathbf{A} have negative real parts.*

To illustrate this theorem we again consider the magnetic levitation system from Example 24.2. For that system the matrix \mathbf{A} (in the linearized model) is given by

$$\mathbf{A} = \begin{bmatrix} -\frac{R}{L} & 0 & 0 \\ 0 & 0 & -1 \\ \frac{Rg}{E_Q} & \frac{Rmg^2}{K_1 E_Q} & 0 \end{bmatrix} \quad (24.56)$$

and its eigenvalues are the roots of $\det(\lambda\mathbf{I} - \mathbf{A}) = 0$, where

$$\det(\lambda\mathbf{I} - \mathbf{A}) = \left(\lambda + \frac{R}{L}\right) \left(\lambda - \sqrt{\frac{Rmg^2}{K_1 E_Q}}\right) \left(\lambda + \sqrt{\frac{Rmg^2}{K_1 E_Q}}\right) \quad (24.57)$$

One can then see that the set of matrix eigenvalues includes one which is **real and greater than zero**. This implies that the system is **unstable**. This is in agreement with physical reasoning. Indeed, at least theoretically, we can position the sphere in equilibrium (this is described by x_{2Q} in (24.37)). However, this is an unstable equilibrium point, since as soon as we slightly perturb the sphere, it accelerates either towards the ground or towards the magnet.

Speed of Response and Resonances

Even if the system is stable there are still some questions regarding other fundamental properties.

To start with, in stable systems the real part of the eigenvalues determines the speed at which the associated mode converges to zero. The slowest modes, the *dominant* modes, determine the speed at which the system output settles at its steady state value, i.e., determine the system speed of response. For example, if the system dominant eigenvalues are $\lambda_{1,2} = -\sigma \pm j\omega_o$, $\sigma > 0$, the combined natural modes generate an exponentially damped sine wave $y(t) = Ae^{-\sigma t} \sin(\omega_o t + \alpha)$. We then observe that this signal decays faster for a larger σ .

A second issue, of special importance for flexible structures, is the presence of resonances, which have associated complex eigenvalues. In physical systems, the existence of complex eigenvalues is intimately connected to the presence of two forms of energy. The resonance describes the (poorly damped) oscillation between those two forms of energy. In electric circuits those energies are the electrostatic energy in capacitors and the electromagnetic energy in inductors. In mechanical systems we have the kinetic energy of moving masses and the potential energy in springs. Flexible structures may have many resonant modes. One of the main problems with resonances occurs when the input contains energy at a frequency

close to the resonant frequency. For example, if a system has eigenvalues $\lambda_{1,2} = -0.05 \pm j$, i.e., the resonant frequency is 1 rad/s and, additionally, one of the **input** components is a sine wave of frequency 0.9 rad/s, then the system output exhibits a very large (forced) oscillation with amplitude initially growing almost linearly and later, stabilizing to a constant value. In real situations this phenomenon may destroy the system (recall the Tacoma bridge case).

State Similarity Transformation

We have already said that the choice of state variables is nonunique. Say that we have a system with input $\mathbf{u}(t)$, output $\mathbf{y}(t)$, and two different choices of state vectors: $\mathbf{x}(t) \in \mathbb{R}^n$ with an associated 4-tuple $(\mathbf{A}, \mathbf{B}, \mathbf{C}, \mathbf{D})$, and $\bar{\mathbf{x}}(t) \in \mathbb{R}^n$ with an associated 4-tuple $(\bar{\mathbf{A}}, \bar{\mathbf{B}}, \bar{\mathbf{C}}, \bar{\mathbf{D}})$. Then there exists a nonsingular matrix $\mathbf{T} \in \mathbb{R}^{n \times n}$ such that

$$\bar{\mathbf{x}}(t) = \mathbf{T}\mathbf{x}(t) \Leftrightarrow \mathbf{x}(t) = \mathbf{T}^{-1}\bar{\mathbf{x}}(t) \quad (24.58)$$

This leads to the following equivalences:

$$\bar{\mathbf{A}} = \mathbf{T}\mathbf{A}\mathbf{T}^{-1}, \quad \bar{\mathbf{B}} = \mathbf{T}\mathbf{B}, \quad \bar{\mathbf{C}} = \mathbf{C}\mathbf{T}^{-1} \quad (24.59)$$

Different choices of state variables may or may not respond to different phenomenological approaches to the system analysis. Sometimes it is just a question of mathematical simplicity, as we shall see in [section 24.6](#). In other occasions, the decision is made considering relative facility to measure certain system variables. However, what is important is that, no matter which state description is chosen, certain fundamental system characteristics do not change. They are related to the fact that the system eigenvalues are invariant with respect to similarity transformations, since

$$\det(\lambda\mathbf{I} - \bar{\mathbf{A}}) = \det(\lambda\mathbf{T}\mathbf{T}^{-1} - \mathbf{T}\mathbf{A}\mathbf{T}^{-1}) = \det(\mathbf{T})\det(\lambda\mathbf{I} - \mathbf{A})\det(\mathbf{T}^{-1}) \quad (24.60)$$

$$= \det(\lambda\mathbf{I} - \mathbf{A}) \quad (24.61)$$

Hence, stability, nature of the unforced response, and speed of response are invariants with respect to similarity transformations.

Example 24.3

Consider the electric network shown in [Fig. 24.4](#)

We choose the state vector $\mathbf{x}(t) = [x_1(t) \quad x_2(t)]^T = [i_L(t) \quad v_C(t)]^T$. Also $u(t) = v_f(t)$. Using first principles we have that

$$\frac{d\mathbf{x}(t)}{dt} = \begin{bmatrix} 0 & \frac{1}{L} \\ \frac{1}{C} & -\frac{R_1 + R_2}{R_1 R_2 C} \end{bmatrix} \mathbf{x}(t) + \begin{bmatrix} 0 \\ \frac{1}{R_1 C} \end{bmatrix} u(t) \quad (24.62)$$

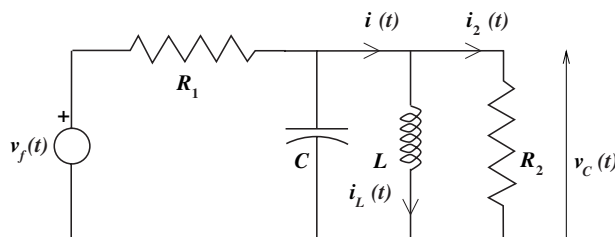

FIGURE 24.4 Electric network.

An alternative state vector is $\bar{\mathbf{x}}(t) = [\bar{x}_1(t) \quad \bar{x}_2(t)]^T = [i_1(t) \quad i_2(t)]^T$. It is straightforward to show that

$$\bar{\mathbf{x}}(t) = \underbrace{\frac{1}{R_2} \begin{bmatrix} R_2 & 1 \\ 0 & 1 \end{bmatrix}}_{\mathbf{T}} \mathbf{x}(t) \quad (24.63)$$

State Space and Transfer Functions

The state space description of linear time invariant systems is an alternative description to that provided by transfer functions. Strictly speaking, the state space description has a wider scope, as we shall see in this subsection.

For a linear time invariant system with input $\mathbf{u}(t) \in \mathbb{R}^m$ and output $\mathbf{y}(t) \in \mathbb{R}^p$, the transfer function, $\mathbf{H}(s) \in \mathbb{C}^{p \times m}$, is defined by the equation

$$\mathbf{Y}(s) = \mathbf{H}(s)\mathbf{U}(s), \quad \text{where} \quad [\mathbf{H}(s)]_{ij} = \frac{Y_i(s)}{U_j(s)} \quad (24.64)$$

i.e., the (i, j) element in matrix $\mathbf{H}(s)$ is the Laplace transformation of the response in the i^{th} output when a unit impulse is applied at the j^{th} input, with zero initial conditions and with the remaining inputs equal to zero for all $t \geq 0$.

On the other hand, if we Laplace-transform (24.42) and (24.43) with zero initial conditions, we obtain

$$\mathbf{X}(s) = (s\mathbf{I} - \mathbf{A})^{-1} \mathbf{B}\mathbf{U}(s) \quad (24.65)$$

$$\mathbf{Y}(s) = \mathbf{C}\mathbf{X}(s) + \mathbf{D}\mathbf{U}(s) = \underbrace{(\mathbf{C}(s\mathbf{I} - \mathbf{A})^{-1} \mathbf{B} + \mathbf{D})}_{\mathbf{H}(s)} \mathbf{U}(s) \quad (24.66)$$

For simplicity, and to be able to go deeper into the analysis, **in the remaining part of this section we will focus our attention on the class of scalar systems**, i.e., systems with a single input and a single output (SISO systems). This means that $m = p = 1$, \mathbf{B} becomes a column vector, \mathbf{C} is a row vector, and $D = H(\infty)$ (in real systems it usually holds that $D = H(\infty) = 0$). For SISO systems, $H(s)$ is a quotient of polynomials in s , i.e.,

$$H(s) = \frac{\mathbf{C} \text{Adj}(s\mathbf{I} - \mathbf{A})\mathbf{B} + \mathbf{D} \det(s\mathbf{I} - \mathbf{A})}{\det(s\mathbf{I} - \mathbf{A})} \quad (24.67)$$

where $\text{Adj}(\mathbf{o})$ denotes the adjoint matrix of (\mathbf{o}) .

A key issue is that the transfer function poles are eigenvalues of matrix \mathbf{A} . However, it is not true, in general, that the set of transfer function poles is identical to the set of matrix \mathbf{A} eigenvalues. This can be appreciated through the following example.

Example 24.4

Let

$$\mathbf{A} = \begin{bmatrix} -2 & 1 \\ 0 & -3 \end{bmatrix}, \quad \mathbf{B} = \begin{bmatrix} 1 \\ 0.5 \end{bmatrix}, \quad \mathbf{C} = [0 \quad 1], \quad D = 0 \quad (24.68)$$

Then

$$H(s) = \mathbf{C}(s\mathbf{I} - \mathbf{A})^{-1}\mathbf{B} = \frac{1}{(s+2)(s+3)} \begin{bmatrix} 0 & 1 \end{bmatrix} \begin{bmatrix} s+3 & 1 \\ 0 & s+2 \end{bmatrix} \begin{bmatrix} 1 \\ 0.5 \end{bmatrix} \quad (24.69)$$

$$= \frac{0.5(s+2)}{(s+2)(s+3)} = \frac{0.5}{(s+3)} \quad (24.70)$$

Therefore, the transfer function has only one pole, although matrix \mathbf{A} has two eigenvalues. We observe that there is a pole–zero cancellation in $H(s)$. This phenomenon is closely connected to the question of system properties, which is the central topic in [section 24.6](#).

To acquire a phenomenological feeling on this issue, consider again the magnetic levitation system in [Example 24.2](#). If we define the current $i(t)$ as the system output we can immediately see that the transfer function from the input $e(t)$ to this output has only one pole. This contrasts with the fact that the dimension of the state is equal to three. The explanation for this is that, in our simplified physical model, the current $i(t)$ is unaffected by the position and the speed of the metallic sphere (note that we have neglected the changes in the inductance due to changes in the sphere position).

The key result is that **the transfer function may not provide the same amount of information than the state space model** for the same system.

An interesting problem is to obtain a state space description from a given transfer function. The reader must be aware that the resulting state space model does not reveal pole-zero cancellations; for that reason, the obtained description is known as a **minimal realization**.

There are many methods to go from the transfer function to a state space model. We present below one of those methods.

Consider a transfer function given by

$$H_T(s) = \frac{B_o(s)}{A_o(s)} + H_T(\infty) = \frac{b_{n-1}s^{n-1} + b_{n-2}s^{n-2} + \cdots + b_1s + b_0}{s^n + a_{n-1}s^{n-1} + \cdots + a_1s + a_0} + H_T(\infty) \quad (24.71)$$

We first recall that $D = H_T(\infty)$. We can thus concentrate on the transfer function $H(s) = H_T(s) - H_T(\infty)$, which is a strictly proper transfer function.

Consider next a variable $v_\ell(t) \in \mathbb{R}$ whose Laplace transform, $V_\ell(s)$, satisfies

$$V_\ell(s) = \frac{s^{\ell-1}}{A_o(s)}U(s), \quad \ell \in \{1, 2, \dots, n\} \quad (24.72)$$

This implies that

$$v_\ell(t) = \frac{dv_{\ell-1}(t)}{dt}, \quad \ell \in \{2, \dots, n\} \quad (24.73)$$

$$Y(s) = \sum_{\ell=1}^n b_{\ell-1}V_\ell(s) \quad (24.74)$$

$$U(s) = \frac{A_o(s)}{A_o(s)}U(s) = \underbrace{\frac{s^n}{A_o(s)}U(s)}_{sV_n(s)} + \sum_{\ell=1}^n a_{\ell-1} \underbrace{\frac{s^{\ell-1}}{A_o(s)}U(s)}_{V_\ell(s)} \quad (24.75)$$

Now choose as state variables,

$$x_\ell(t) = v_\ell(t) \quad (24.76)$$

The above equations yield

$$\mathbf{A} = \begin{bmatrix} 0 & 1 & 0 & \cdots & 0 & 0 \\ 0 & 0 & 1 & \cdots & 0 & 0 \\ \vdots & \vdots & \vdots & & \vdots & \vdots \\ -a_0 & -a_1 & -a_2 & \cdots & -a_{n-2} & -a_{n-1} \end{bmatrix}, \quad \mathbf{B} = \begin{bmatrix} 0 \\ 0 \\ \vdots \\ 0 \\ 1 \end{bmatrix} \quad (24.77)$$

$$\mathbf{C} = [b_0 \quad b_1 \quad b_2 \quad \cdots \quad b_{n-1}], \quad \mathbf{D} = H_T(\infty) \quad (24.78)$$

Example 24.5

The transfer function of a system is given by

$$H(s) = \frac{4s - 10}{(s + 2)^2(s - 1)} = \frac{4s - 10}{s^3 + 3s^2 - 4} \quad (24.79)$$

Then a minimal realization for this system is

$$\mathbf{A} = \begin{bmatrix} 0 & 1 & 0 \\ 0 & 0 & 1 \\ 4 & 0 & -3 \end{bmatrix}, \quad \mathbf{B} = \begin{bmatrix} 0 \\ 0 \\ 1 \end{bmatrix} \quad (24.80)$$

$$\mathbf{C} = [-10 \quad 4 \quad 0], \quad \mathbf{D} = 0 \quad (24.81)$$

A key result is that a **system transfer function is invariant with respect to state similarity transformations.**

24.4 State Space Description for Discrete-Time and Sampled Data Systems

In this section we will present an overview of the state space description for discrete time systems, mainly based on the results presented for the continuous time case.

Discrete time models may arise from two different sources:

- From a *pure* discrete-time system, usually nonlinear, whose variables are defined only at specific time instants t_k . Systems like that can be found in economic systems, stochastic process theory, etc.
- From a discretization of a continuous-time system. In this case, we are only concerned with the value of some system variables at specific time instants. These models are useful when digital systems, such as microcontrollers, computers, PLCs, or others, interact with continuous-time *real systems* such as mechanical structures, valves, tanks, analog circuits or a whole industrial process¹. These are called **sampled data systems**.

In both cases our analysis will be focused on the class of **linear and time invariant** models.

¹Through *digital-to-analog* and *analog-to-digital* converters (DAC and ADC, respectively).

Linearization of Discrete Time Systems

The discrete time equivalents to (24.3) and (24.4) are given by the nonlinear equations

$$\mathbf{x}[t + 1] = \mathbf{F}_d(\mathbf{x}[t], \mathbf{u}[t]) \quad (24.82)$$

$$\mathbf{y}[t] = \mathbf{G}_d(\mathbf{x}[t], \mathbf{u}[t]) \quad (24.83)$$

The linearization of models for discrete time systems follows along the same lines to that for continuous ones. Consider firstly an equilibrium point given by $\{\mathbf{x}_Q, \mathbf{u}_Q, \mathbf{y}_Q\}$:

$$\mathbf{x}_Q = \mathbf{F}_d(\mathbf{x}_Q, \mathbf{u}_Q) \quad (24.84)$$

$$\mathbf{y}_Q = \mathbf{G}_d(\mathbf{x}_Q, \mathbf{u}_Q) \quad (24.85)$$

Note that an equilibrium point is defined by a set of **constant** values of the state and **constant** values of the input which satisfy (24.82) and (24.83). This yields a constant system output. The discrete model can then be linearized around this equilibrium point. Defining

$$\Delta \mathbf{x}[t] = \mathbf{x}[t] - \mathbf{x}_Q, \quad \Delta \mathbf{u}[t] = \mathbf{u}[t] - \mathbf{u}_Q, \quad \Delta \mathbf{y}[t] = \mathbf{y}[t] - \mathbf{y}_Q \quad (24.86)$$

we have the state space model

$$\Delta \mathbf{x}[t + 1] = \mathbf{A}_d \Delta \mathbf{x}[t] + \mathbf{B}_d \Delta \mathbf{u}[t] \quad (24.87)$$

$$\Delta \mathbf{y}[t] = \mathbf{C}_d \Delta \mathbf{x}[t] + \mathbf{D}_d \Delta \mathbf{u}[t] \quad (24.88)$$

where

$$\mathbf{A}_d = \left. \frac{\partial \mathbf{F}_d}{\partial \mathbf{x}} \right|_{\substack{\mathbf{x}=\mathbf{x}_Q \\ \mathbf{u}=\mathbf{u}_Q}}, \quad \mathbf{B}_d = \left. \frac{\partial \mathbf{F}_d}{\partial \mathbf{u}} \right|_{\substack{\mathbf{x}=\mathbf{x}_Q \\ \mathbf{u}=\mathbf{u}_Q}}, \quad \mathbf{C}_d = \left. \frac{\partial \mathbf{G}_d}{\partial \mathbf{x}} \right|_{\substack{\mathbf{x}=\mathbf{x}_Q \\ \mathbf{u}=\mathbf{u}_Q}}, \quad \mathbf{D}_d = \left. \frac{\partial \mathbf{G}_d}{\partial \mathbf{u}} \right|_{\substack{\mathbf{x}=\mathbf{x}_Q \\ \mathbf{u}=\mathbf{u}_Q}} \quad (24.89)$$

Sampled Data Systems

As we have already said, discrete time models are frequently obtained by sampling inputs and outputs in continuous-time systems. When a digital device is to be used to act upon a continuous-time system, the command signals need only to be defined at specific instants, and not at *all* time. However, to be able to act upon the continuous-time system, we need a continuous-time signal. This is usually built with a *zero order hold*, which generates a staircase signal. Also, when we want to digitally measure a system variable this is done at some specific time instants. This means that we must **sample** the output signals. Figure 24.5 illustrates these concepts. If we assume a periodic sampling, with period Δ , we are only interested in the signals at time $k\Delta$. In the sequel we will drop Δ from the arguments, using $\mathbf{u}(k\Delta) = \mathbf{u}[t]$ for the input, $\mathbf{y}(k\Delta) = \mathbf{y}[t]$ for the output, and $\mathbf{x}(k\Delta) = \mathbf{x}[t]$ for the system state.

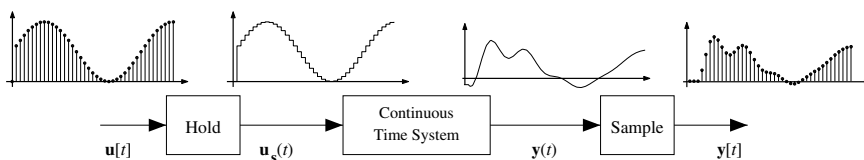

FIGURE 24.5 Schematic representation of a sampled data system.

If we consider the continuous, time-invariant, and linear state space model defined by equations (24.42) and (24.43), with initial state $\mathbf{x}(k_0\Delta) = \mathbf{x}_0$, we can use Eq. (24.44) to calculate the next value of the state:

$$\mathbf{x}(k_0\Delta + \Delta) = e^{A(k_0\Delta + \Delta - k_0\Delta)} \mathbf{x}(k_0\Delta) + \int_{k_0\Delta}^{k_0\Delta + \Delta} e^{A(k_0\Delta + \Delta - \tau)} \mathbf{B} \mathbf{u}(\tau) d\tau \quad (24.90)$$

Furthermore, if a zero order hold is used, i.e., $\mathbf{u}(\tau) = \mathbf{u}(k_0\Delta)$ for $k_0\Delta \leq \tau < k_0\Delta + \Delta$, we obtain

$$\mathbf{x}(k_0\Delta + \Delta) = e^{A\Delta} \mathbf{x}(k_0\Delta) + \int_0^\Delta e^{A\eta} d\eta \mathbf{B} \mathbf{u}(k_0\Delta) \quad (24.91)$$

And, if we know the state and the input at time $k_0\Delta$, the output is defined by Eq. (24.43):

$$\mathbf{y}(k_0\Delta) = \mathbf{C}\mathbf{x}(k_0\Delta) + \mathbf{D} \mathbf{u}(k_0\Delta) \quad (24.92)$$

We can now conclude that given a continuous-time model with state space matrices $\{\mathbf{A}, \mathbf{B}, \mathbf{C}, \mathbf{D}\}$, and we sample inputs and outputs every Δ seconds then, the equivalent sampled data systems will be described by the discrete-time state space model:

$$\mathbf{x}(k\Delta + \Delta) = \mathbf{A}_d \mathbf{x}(k\Delta) + \mathbf{B}_d \mathbf{u}(k\Delta) \quad (24.93)$$

$$\mathbf{y}(k\Delta) = \mathbf{C}_d \mathbf{x}(k\Delta) + \mathbf{D}_d \mathbf{u}(k\Delta) \quad (24.94)$$

where

$$\mathbf{A}_d = e^{A\Delta}, \quad \mathbf{B}_d = \int_0^\Delta e^{A\eta} d\eta \mathbf{B}, \quad \mathbf{C}_d = \mathbf{C}, \quad \mathbf{D}_d = \mathbf{D} \quad (24.95)$$

There are different methods to obtain \mathbf{A}_d defined in (24.95), but a simple way to calculate this matrix is to use Laplace transformation. This yields

$$\mathbf{A}_d = e^{A\Delta} = \mathcal{L}^{-1} \{ (s\mathbf{I} - \mathbf{A})^{-1} \} \Big|_{t=\Delta} \quad (24.96)$$

Example 24.6

Consider the mechanical system of Example 24.1 on the page 4, that was described by the state space model:

$$\begin{bmatrix} \dot{x}_1(t) \\ \dot{x}_2(t) \end{bmatrix} = \begin{bmatrix} 0 & 1 \\ -\frac{K}{M} & -\frac{D}{M} \end{bmatrix} \begin{bmatrix} x_1(t) \\ x_2(t) \end{bmatrix} + \begin{bmatrix} 0 \\ \frac{1}{M} \end{bmatrix} f(t) \quad (24.97)$$

where $f(t)$ is the external force, and where we can choose either the mass position, $x_1(t)$, or the mass velocity, $x_2(t)$, of the mass, as the system output.

For the purpose of a numerical illustration, we set $M = 1$ kg, $D = 1.2$ N s/m, and $K = 0.32$ N/m.

The matrix \mathbf{A}_d is obtained from (24.96), applying inverse Laplace transformation

$$\mathbf{A}_d = \mathcal{L}^{-1} \left\{ \left[\begin{array}{cc} s & -1 \\ 0.32 & s + 1.2 \end{array} \right]^{-1} \right\} \Big|_{t=\Delta} = \begin{bmatrix} 2e^{-0.4\Delta} - e^{-0.8\Delta} & 2.5(e^{-0.4\Delta} - e^{-0.8\Delta}) \\ 0.8(e^{-0.4\Delta} - e^{-0.8\Delta}) & -e^{-0.4\Delta} + 2e^{-0.8\Delta} \end{bmatrix} \quad (24.98)$$

and the \mathbf{B}_d matrix is obtained from (24.95):

$$\mathbf{B}_d = \int_0^\Delta \begin{bmatrix} 2e^{-0.4\eta} - e^{-0.8\eta} & 2.5(e^{-0.4\eta} - e^{-0.8\eta}) \\ 0.8(e^{-0.4\eta} - e^{-0.8\eta}) & -e^{-0.4\eta} + 2e^{-0.8\eta} \end{bmatrix} d\eta \begin{bmatrix} 0 \\ 1 \end{bmatrix} \quad (24.99)$$

$$\Rightarrow \mathbf{B}_d = \begin{bmatrix} -6.25e^{-0.4\Delta} + 3.125e^{-0.8\Delta} + 3.125 \\ 2.5(e^{-0.4\Delta} - e^{-0.8\Delta}) \end{bmatrix}$$

Note that both, \mathbf{A}_d and \mathbf{B}_d are functions of Δ . Thus, the sampling period, Δ , has a strong presence in the dynamic behavior of the sampled system, as we shall observe in the following subsections.

Linear State Space Models

We will analyze the linear time invariant state space model

$$\mathbf{x}[t+1] = \mathbf{A}_d \mathbf{x}[t] + \mathbf{B}_d \mathbf{u}[t] \quad (24.100)$$

$$\mathbf{y}[t] = \mathbf{C}_d \mathbf{x}[t] + \mathbf{D}_d \mathbf{u}[t] \quad (24.101)$$

This can be a linearized discrete time model like (24.87) and (24.88), or a sampled data system like (24.93) and (24.94) where Δ has been dropped from the time argument.

The solution to Eqs. (24.100) and (24.101), subject to $\mathbf{x}[t_0] = \mathbf{x}_o$, is given by

$$\mathbf{x}[t] = \mathbf{A}_d^{(t-t_0)} \mathbf{x}_o + \sum_{i=0}^{(t-t_0)-1} \mathbf{A}_d^{(t-t_0)-i-1} \mathbf{B}_d \mathbf{u}[i+t_0] \quad \forall t \geq t_0 \quad (24.102)$$

where $\mathbf{A}_d^{(t-t_0)}$ is the **transition matrix**.

The reader can check easily that (24.102) satisfies (24.100). With the above result, the solution for (24.101) is given by

$$\mathbf{y}[t] = \mathbf{C}_d \mathbf{A}_d^{(t-t_0)} \mathbf{x}_o + \mathbf{C}_d \sum_{i=0}^{(t-t_0)-1} (\mathbf{A}_d^{(t-t_0)-i-1} \mathbf{B}_d \mathbf{u}[i+t_0]) + \mathbf{D}_d \mathbf{u}[t] \quad (24.103)$$

System Dynamics

The state of the system has two components: the **unforced** component, $\mathbf{x}_u[t]$, and the **forced** component, $\mathbf{x}_f[t]$, where

$$\mathbf{x}_u[t] = \mathbf{A}_d^{(t-t_0)} \mathbf{x}_o \quad (24.104)$$

$$\mathbf{x}_f[t] = \sum_{\tau=0}^{(t-t_0)-1} \mathbf{A}_d^{(t-t_0)-i-1} \mathbf{B}_d \mathbf{u}[i+t_0] \quad (24.105)$$

To gain insight into the state space model and its solution consider the case when $t_0 = 0$ and $u[t] = 0$, $\forall t \geq 0$, i.e., the state has only the **unforced part**. Then

$$\mathbf{x}[t] = \mathbf{A}_d^t \mathbf{x}_o \quad (24.106)$$

Further assume that $\mathbf{A}_d \in \mathbb{R}^{n \times n}$ and that, for simplicity, it has n distinct eigenvalues η_ℓ , with n linearly independent eigenvectors \mathbf{v}_ℓ . Then there always exists a set of n constants α_ℓ such that

$$\mathbf{x}_o = \sum_{\ell=1}^n \alpha_\ell \mathbf{v}_\ell, \quad \alpha_\ell \in \mathbb{C} \quad (24.107)$$

A well known result from linear algebra tells us that the eigenvalues of \mathbf{A}_d^k are η_ℓ^k , for $k \in \mathbb{N}$, with corresponding eigenvectors \mathbf{v}_ℓ . The application of this result yields

$$\mathbf{x}[t] = \mathbf{A}_d^t \mathbf{x}_o = \mathbf{A}_d^t \sum_{\ell=1}^n \alpha_\ell \mathbf{v}_\ell = \sum_{\ell=1}^n \alpha_\ell \underbrace{\mathbf{A}_d^t \mathbf{v}_\ell}_{\eta_\ell^t \mathbf{v}_\ell} \quad (24.108)$$

$$\mathbf{x}[t] = \sum_{\ell=1}^n \alpha_\ell \eta_\ell^t \mathbf{v}_\ell \quad (24.109)$$

This equation shows that the unforced component of the state is a linear combination of **natural modes**, $\{\eta_\ell^t\}$, and each one is associated with an eigenvalue of \mathbf{A}_d , which are also known as **natural frequencies** of the model. Thus, we again have that the matrix \mathbf{A}_d determines:

- the structure of the unforced response
- the stability (or otherwise) of the system
- the speed of response

Structure of the Unforced Response

In the absence of input, the state evolves as a combination of natural modes which belong to a defined class of functions: the powers of the model eigenvalues, either real or complex. These modes are discrete functions related to constants, real exponentials, pure sine waves, exponentially modulated sine waves, and some other special functions arising from repeated eigenvalues.

To illustrate these ideas and their physical interpretation consider the sampled system in Example 24.6. If $\Delta = 1$, the state space matrices are

$$\mathbf{A}_d = \begin{bmatrix} 0.8913 & 0.5525 \\ -0.1768 & 0.2283 \end{bmatrix}, \quad \mathbf{B}_d = \begin{bmatrix} 0.3397 \\ 0.5525 \end{bmatrix} \quad (24.110)$$

Hence, the system eigenvalues are solutions to the equation

$$\det(\eta \mathbf{I} - \mathbf{A}_d) = \det \left(\begin{bmatrix} \eta - 0.8913 & -0.5525 \\ 0.1768 & \eta - 0.2283 \end{bmatrix} \right) \quad (24.111)$$

$$= (\eta - 0.6703)(\eta - 0.4493) = 0 \quad (24.112)$$

i.e., $\eta_1 = 0.6703$, $\eta_2 = 0.4493$, and the unforced response is

$$\mathbf{x}_u[t] = C_1(0.6702)^t + C_2(0.4493)^t \quad (24.113)$$

where C_1 and C_2 depend on the initial conditions only. We can observe that, when t tends to infinity, $\mathbf{x}_u[t]$ decays to zero, because $|\eta_{1,2}| < 1$. Also these eigenvalues are positive real numbers, so there is no oscillation

in the natural modes. This last observation is consistent with the parameter choice in Example 1.6, which made the mass-spring system to be overdamped.

Structure of the Forced Response

Consider the Eq. (24.102). Then, when the initial state is zero, the state will only exhibit the forced component. However, the forced component will still include natural modes plus some additional **forced** or **particular** modes, which depend on the nature of the system input $\mathbf{u}[t]$. In general, the forcing modes in the input will also appear in the state. However, special cases arise when a forcing mode in $\mathbf{u}[t]$ coincides with a system natural mode.

System Stability

Stability in linear time-invariant systems can also be analyzed using the state matrix \mathbf{A}_d . As we said, all systems variables can be expressed as linear functions of the state and the system input. When the system input $\mathbf{u}[t]$ is a vector of bounded time functions, then the boundedness of the system variables depends on the state to be bounded. We then have the following result:

Theorem 24.2 Consider a system with the state description (24.100) and (24.101) where \mathbf{B}_d , \mathbf{C}_d , and \mathbf{D}_d have bounded elements. Then the system state is bounded for all bounded inputs if and only if the eigenvalues of \mathbf{A}_d lies inside the unit disc, i.e., $|\eta_\ell| < 1, \forall \ell$.

Speed of Response and Resonances

We recall that the natural modes of discrete-time systems are the powers of the eigenvalues η_ℓ . Since those eigenvalues can always be described as complex quantities, we can then write the natural modes as

$$(\eta_\ell)^t = (|\eta_\ell|e^{j\theta_\ell})^t = |\eta_\ell|^t e^{j\theta_\ell t}, \quad \text{where } \theta_\ell = \angle \eta_\ell \quad (24.114)$$

Therefore, we have that

- $0 < |\eta_\ell| < \infty$ determines the *speed* at which the mode decays to zero for stable systems ($|\eta_\ell| < 1$), or grows to infinity for unstable systems ($|\eta_\ell| > 1$)
- $-\pi < \theta_\ell \leq \pi$ determines the *frequency* of the natural mode, measured in radians.

Although the natural modes of stable systems decay to zero, their nature determines the system transient response.

To illustrate these issues the **step response**, with zero initial conditions, is frequently used.

Example 24.7

Consider the first order, single-input single-output discrete-time system

$$\mathbf{x}[t+1] = \eta_\ell \mathbf{x}[t] + \mathbf{u}[t] \quad (24.115)$$

$$\mathbf{y}[t] = (1 - \eta_\ell) \mathbf{x}[t] \quad (24.116)$$

To obtain the step response, we can use the Eq. (24.103), where $\mathbf{x}_0 = 0, \mathbf{u}[t] = 1, \forall t \geq 0$.

$$\mathbf{y}[t] = \mathbf{C}_d \left(\sum_{i=0}^{t-1} \mathbf{A}_d^{t-i-1} \right) \mathbf{B}_d \quad (24.117)$$

$$= (1 - \eta_\ell) \left(\sum_{i=0}^{t-1} \eta_\ell^{t-i-1} \right) = (1 - \eta_\ell) \eta_\ell^{t-1} \frac{1 - \eta_\ell^{-t}}{1 - \eta_\ell^{-1}} \quad (24.118)$$

$$= 1 - \eta_\ell^t \quad (24.119)$$

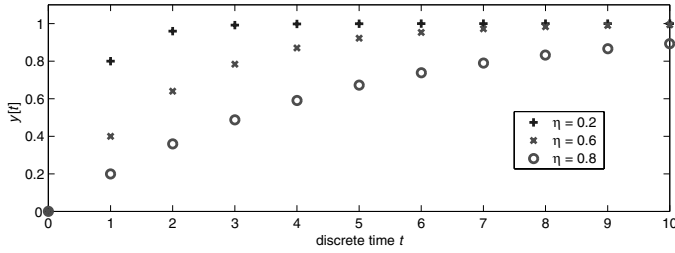

FIGURE 24.6 Step response of the system for different eigenvalues.

The output signal, $y[t] = y_h[t] + y_p[t]$, is shown in Fig. 24.6, for different values of the eigenvalue η_ℓ . The transient is given by $y_h[t] = -\eta_\ell^t$, and the steady state response by $y_p[t] = 1$.

We observed in Eq. (24.114) that the system eigenvalues define the damping of its transient response, but also determine its frequency of oscillation (when the eigenvalues have a nonzero imaginary part). The potential problem when resonant modes exist is the same problem we found in the context of continuous-time systems, i.e., the system input contains a sine wave or another kind of signal, with energy at a frequency close to one of the natural frequencies of the system. The system output still remains bounded, although it grows to undesirable amplitudes.

Example 24.8

Consider the discrete-time system described by the state space model

$$\mathbf{x}[t+1] = \begin{bmatrix} 1.2796 & -0.81873 \\ 1 & 0 \end{bmatrix} \mathbf{x}[t] + \begin{bmatrix} 1 \\ 0 \end{bmatrix} u[t] \quad (24.120)$$

$$y[t] = \begin{bmatrix} 0 & 0.5391 \end{bmatrix} \mathbf{x}[t] \quad (24.121)$$

The eigenvalues of the system are obtained from \mathbf{A}_d :

$$\eta_{1,2} = 0.6398 \pm j0.6398 = 0.9048 (e^{j\pi/4}) \quad (24.122)$$

And the associated natural modes, present in the transient response, are

$$\eta_{1,2}^t = 0.9048^t e^{j\frac{\pi}{4}t} = 0.9048^t \left[\cos\left(\frac{\pi}{4}t\right) \pm j\sin\left(\frac{\pi}{4}t\right) \right] \quad (24.123)$$

The natural modes are slightly damped, because $|\eta_{1,2}|$ is close to 1, and they show an oscillation of frequency $\pi/4$.

In the plots shown in Fig. 24.7 we appreciate a strongly resonant output. The upper plot corresponds to an input $u[t] = \sin(\frac{\pi}{4}t)$, i.e., the input frequency coincides with the frequency of the natural modes. In the lower plot the input is a square wave of frequency input signal $\pi/12$. In this case, the input **third** harmonic has a frequency equal to the frequency of the natural modes.

Effect of Different Sampling Periods

We observe in Eq. (24.95) that \mathbf{A}_d and \mathbf{B}_d depend on the choice of the sampling period Δ . This choice determines the position of the eigenvalues of the system too. If we look at the Eq. (24.96), assuming that \mathbf{A} has been diagonalized, we have that

$$\mathbf{A}_d = e^{\text{diag}\{\lambda_1, \dots, \lambda_n\}\Delta} = \text{diag}\{e^{\lambda_1\Delta}, \dots, e^{\lambda_n\Delta}\} \quad (24.124)$$

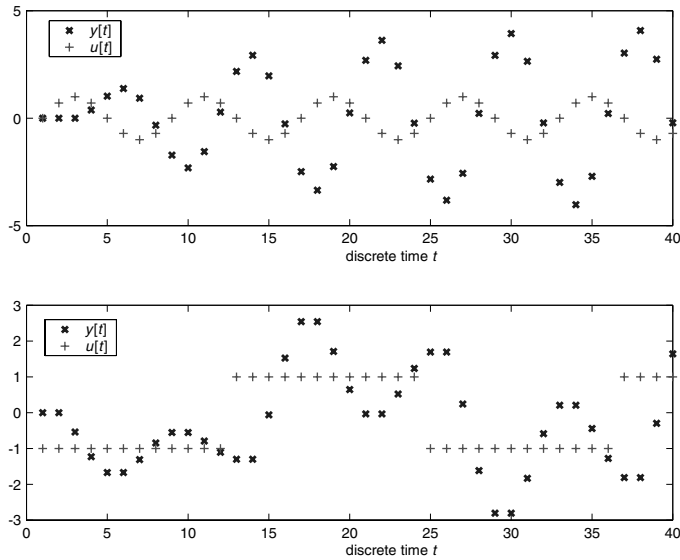

FIGURE 24.7 Resonant effect in the system output.

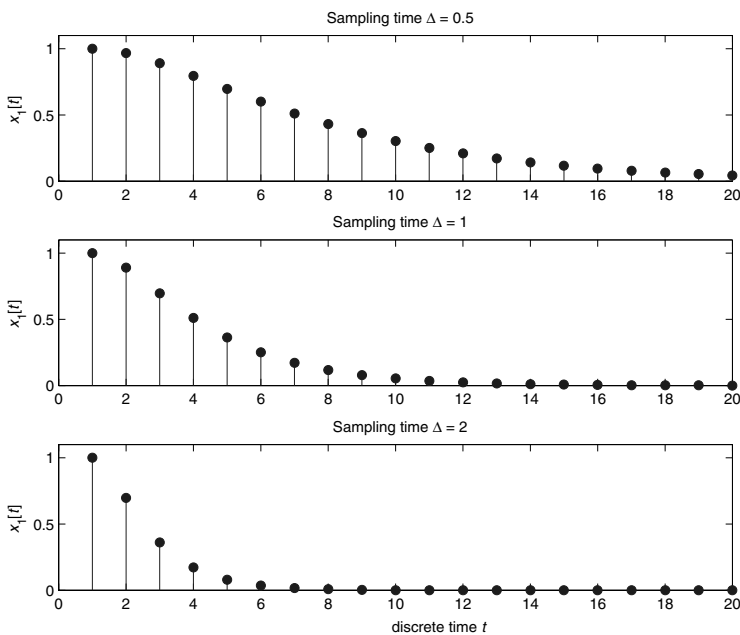

FIGURE 24.8 Effect of sampling in natural modes.

where $\{\lambda_1, \dots, \lambda_n\}$ are the eigenvalues of the underlying continuous-time systems. Then, these eigenvalues are mapped to the eigenvalues of the sampled-data system by equation:

$$\eta_\ell = e^{\lambda_\ell \Delta} \tag{24.125}$$

In Fig. 24.8 we observe the response of the sampled system of Example 24.6, choosing $x_1[t]$ as the system output, when the initial condition is $\mathbf{x}_o = [1 \ 0]^T$, for different values of Δ . Observe that the horizontal axis corresponds to t , so the *real* instants times are $t\Delta$.

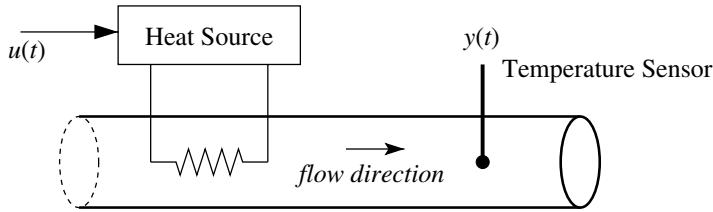

FIGURE 24.9 Heating system with time delay.

A fundamental issue regarding sampling of continuous-time signals is that the sampling period has to be chosen small enough to capture the essential nature of the signal to be sampled. To exemplify an ill-chosen Δ , assume that the signal $f(t) = A \sin(\omega_0 t)$ is sampled every Δ seconds, with $\Delta = 2\ell\pi/\omega_0$, $\ell \in \mathbb{N}$. Then the resulting discrete time signal is $f[t] = 0$, $\forall t \in \mathbb{Z}$.

Sampled Data Systems and Time Delays

We said in section 24.3 that one cannot use continuous-time state space models to describe systems with time delays, because they are infinite dimensional systems. It was also said there that we would be able to tackle this problem using sampled signals. This is done using the following example.

Example 24.9

Consider the heating system sketched in Fig. 24.9.

The measured temperature, $y(t)$, of the flow depends on the power injected by the heat source. This source is commanded by a control signal $u(t)$. Changes in $u(t)$ yield changes in the temperature $y(t)$, but with a significant time delay. The linearized system can thus be represented by the transfer function:

$$\frac{Y(s)}{U(s)} = H(s) = \frac{e^{-\tau s} K}{s + \lambda} \quad (24.126)$$

where $U(s)$ and $Y(s)$ are the Laplace transforms of $u(t)$ and $y(t)$, respectively.

We next assume that the input and output signals are sampled every $\Delta[s]$. The time delay τ , in seconds, is a function of the flow velocity and we can assume, for simplicity, that τ is a multiple of the sampling interval Δ , i.e., $\tau = m\Delta$, $m \in \mathbb{Z}^+$. These delays translate in a factor z^m in the denominator of the Z-transform transfer function. In other words, the delay gives rise to a set of m poles at the origin. Furthermore, the continuous-time system eigenvalue at $s = -\lambda$ becomes a discrete-time system eigenvalue at $z = e^{-\lambda\Delta}$ (see Eq. (24.125)). The resulting transfer function is

$$\frac{Y[z]}{U[z]} = H[z] = \frac{K}{\lambda} \frac{1 - e^{-\lambda\Delta}}{z^m (z - e^{-\lambda\Delta})} \quad (24.127)$$

And this transfer function can be expressed as the discrete state space model

$$x_1[t+1] = x_2[t] \quad (24.128)$$

$$x_2[t+1] = x_3[t] \quad (24.129)$$

\vdots \vdots

$$x_m[t+1] = x_{m+1}[t] \quad (24.130)$$

$$x_{m+1}[t+1] = e^{-\lambda\Delta} x_{m+1}[t] + \frac{K}{\lambda} (1 - e^{-\lambda\Delta}) u[t] \quad (24.131)$$

$$y[t] = x_1[t] \quad (24.132)$$

We can then think of the states variables $x_{m+1}[t], \dots, x_1[t]$ as the temperature at equally spaced points, between the heat source and the temperature sensor.

When the time delay τ is not a multiple of the sampling period Δ , an additional pole at the origin and an additional zero appear in the discrete transfer function. The details can be found elsewhere, e.g., in [7].

State Similarity Transformation

The idea of transforming the state via a similarity transformation equally applies to discrete-time systems. The system properties also remain unchanged.

State Space and Transfer Functions

For discrete-time systems the relation between state space and transfer function models is basically the same as in the continuous-time case (see section “State Space and Transfer Functions”). As we said then, the state space description of linear time invariant systems is an alternative description to that provided by transfer functions, although in some situations it provides more information on the system.

For a linear discrete-time invariant system with input $\mathbf{u}[t] \in \mathbb{R}^m$ and output $\mathbf{y}[t] \in \mathbb{R}^p$, the transfer function, $\mathbf{H}[z] \in \mathbb{C}^{p \times m}$, is defined by the equation

$$\mathbf{Y}[z] = \mathbf{H}[z]\mathbf{U}[z], \quad \text{where} \quad [\mathbf{H}[z]]_{ij} = \frac{Y_i[z]}{U_j[z]} \quad (24.133)$$

i.e., the (i, j) element in matrix $\mathbf{H}[z]$ is the Zeta transformation of the response in the i^{th} output when a unit Kronecker’s delta is applied at the j^{th} input, with zero initial conditions and with the remaining inputs equal to zero for all $t \geq 0$.

On the other hand, if we apply Zeta transform to the discrete time state space model (24.100) and (24.101), with zero initial conditions, we have

$$\mathbf{X}[z] = (z\mathbf{I} - \mathbf{A}_d)^{-1}\mathbf{B}_d\mathbf{U}[z] \quad (24.134)$$

$$\mathbf{Y}[z] = \mathbf{C}_d\mathbf{X}[z] + \mathbf{D}_d\mathbf{U}[z] \quad (24.135)$$

leading to

$$\mathbf{C}_d(z\mathbf{I} - \mathbf{A}_d)^{-1}\mathbf{B}_d + \mathbf{D}_d = \mathbf{H}[z] \quad (24.136)$$

In the following analysis, we will focus on the class of scalar systems, i.e., $m = p = 1$, \mathbf{B}_d , \mathbf{C}_d^T are column vectors, and $\mathbf{D}_d = H[\infty]$. We can then see that $H[z]$ is a quotient of polynomials in z , i.e.,

$$H[z] = \frac{\mathbf{C}_d \text{Adj}(z\mathbf{I} - \mathbf{A}_d)\mathbf{B}_d + \mathbf{D}_d \det(z\mathbf{I} - \mathbf{A}_d)}{\det(z\mathbf{I} - \mathbf{A}_d)} \quad (24.137)$$

where $\text{Adj}(\mathbf{o})$ denotes the adjoint matrix of (\mathbf{o}) .

We have again, paralleling the continuous-time case, that the transfer function poles are eigenvalues of \mathbf{A}_d . However, it is not true in general that the set of transfer function poles is identical to the set of eigenvalues of the matrix. It is important to realize that transfer function models can hide cancellations between poles and zeros, with the consequences described in subsections “Controllability, Reachability and Stabilizability” and “Observability, Reconstructability and Detectability.”

A key result for discrete-time system is the same for continuous-time systems: **the transfer function may not provide the same amount of information than the state space model** for the same system.

One way to obtain the state space model is to use the same method proposed in section “State Space and Transfer Functions,” applying Zeta transformation instead of Laplace transformation, and using the fact that

$$F[z] = Z\{f[t]\} \Leftrightarrow zF[z] = Z\{f[t + 1]\} \quad (24.138)$$

Example 24.10

The transfer function of a system is given by

$$H[z] = \frac{2z^2 - z + 1}{(z - 0.8)(z - 0.6)} = \frac{1.8z + 0.04}{z^2 - 1.4z + 0.48} + 2 \quad (24.139)$$

Then a minimal realization for this system is

$$\mathbf{A}_d = \begin{bmatrix} 0 & 1 \\ -0.48 & -1.4 \end{bmatrix}, \quad \mathbf{B}_d = \begin{bmatrix} 0 \\ 1 \end{bmatrix} \quad (24.140)$$

$$\mathbf{C}_d = [0.04 \quad 1.8], \quad \mathbf{D}_d = 2 \quad (24.141)$$

In discrete-time models it also happens that the **system transfer function is invariant with respect to state similarity transformations.**

24.5 State Space Models for Interconnected Systems

To build state space models for complex systems it is sometimes useful (and possible) to describe them as the interconnection of simpler systems. That interconnection is usually a combination of three basic interconnection structures: series, parallel, and feedback. In those three basic cases our aim is to obtain a state space model for the composite system.

In the following analysis we will use two systems, which are defined by

$$\text{System 1: } \frac{d\mathbf{x}_1(t)}{dt} = \mathbf{A}_1\mathbf{x}_1(t) + \mathbf{B}_1\mathbf{u}_1(t) \quad (24.142)$$

$$\mathbf{y}_1(t) = \mathbf{C}_1\mathbf{x}_1(t) + \mathbf{D}_1\mathbf{u}_1(t) \quad (24.143)$$

$$\text{System 2: } \frac{d\mathbf{x}_2(t)}{dt} = \mathbf{A}_2\mathbf{x}_2(t) + \mathbf{B}_2\mathbf{u}_2(t) \quad (24.144)$$

$$\mathbf{y}_2(t) = \mathbf{C}_2\mathbf{x}_2(t) + \mathbf{D}_2\mathbf{u}_2(t) \quad (24.145)$$

Series Connection

The system interconnection shown in Fig. 24.10 is known as a series or cascade connection. To build the desired state space model, we first observe that $\mathbf{y}_2(t) = \mathbf{u}_1(t)$. Also, the composite system input is $\mathbf{u}(t) = \mathbf{u}_2(t)$,

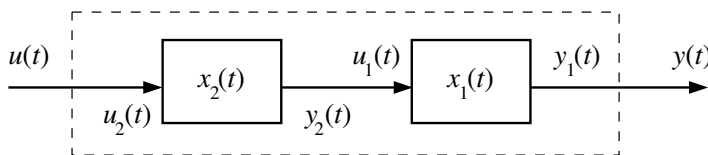

FIGURE 24.10 Series connection.

and the composite system output is $\mathbf{y}(t) = \mathbf{y}_1(t)$. We thus obtain

$$\begin{bmatrix} \dot{\mathbf{x}}_1(t) \\ \dot{\mathbf{x}}_2(t) \end{bmatrix} = \begin{bmatrix} \mathbf{A}_1 & \mathbf{B}_1\mathbf{C}_2 \\ 0 & \mathbf{A}_2 \end{bmatrix} \begin{bmatrix} \mathbf{x}_1(t) \\ \mathbf{x}_2(t) \end{bmatrix} + \begin{bmatrix} \mathbf{B}_1\mathbf{D}_2 \\ \mathbf{B}_2 \end{bmatrix} \mathbf{u}(t) \quad (24.146)$$

$$\mathbf{y}(t) = [\mathbf{C}_1 \ \mathbf{D}_1\mathbf{C}_2] \begin{bmatrix} \mathbf{x}_1(t) \\ \mathbf{x}_2(t) \end{bmatrix} + [\mathbf{D}_1\mathbf{D}_2] \mathbf{u}(t) \quad (24.147)$$

Parallel Connection

The system interconnection shown in Fig. 24.11 is known as a parallel connection. To obtain the desired state space model we observe that the input is $\mathbf{u}(t) = \mathbf{u}_1(t) = \mathbf{u}_2(t)$ and the output for the whole system is $\mathbf{y}(t) = \mathbf{y}_1(t) + \mathbf{y}_2(t)$. We obtain

$$\begin{bmatrix} \dot{\mathbf{x}}_1(t) \\ \dot{\mathbf{x}}_2(t) \end{bmatrix} = \begin{bmatrix} \mathbf{A}_1 & \mathbf{0} \\ \mathbf{0} & \mathbf{A}_2 \end{bmatrix} \begin{bmatrix} \mathbf{x}_1(t) \\ \mathbf{x}_2(t) \end{bmatrix} + \begin{bmatrix} \mathbf{B}_1 \\ \mathbf{B}_2 \end{bmatrix} \mathbf{u}(t) \quad (24.148)$$

$$\mathbf{y}(t) = [\mathbf{C}_1 \ \mathbf{C}_2] \begin{bmatrix} \mathbf{x}_1(t) \\ \mathbf{x}_2(t) \end{bmatrix} + [\mathbf{D}_1 + \mathbf{D}_2] \mathbf{u}(t) \quad (24.149)$$

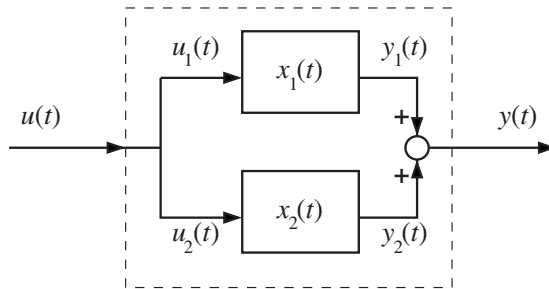

FIGURE 24.11 Parallel connection.

Feedback Connection

The system interconnection shown in Fig. 24.12 is known as feedback connection (with unit negative feedback), and it corresponds to the basic structure of a control loop, where S_1 is the *plant* and S_2 is the *controller*. To build the composite state space model we observe that the overall system input satisfies the equation $\mathbf{u}(t) = \mathbf{u}_2(t) + \mathbf{y}_1(t)$, and the overall system output is $\mathbf{y}(t) = \mathbf{y}_1(t)$. Furthermore, we assume

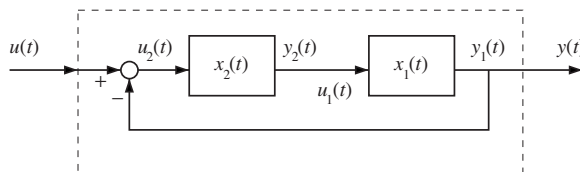

FIGURE 24.12 Feedback connection.

that the system S_1 (the plant) is strictly proper, i.e., $\mathbf{D}_1 = 0$. We then obtain

$$\begin{bmatrix} \dot{\mathbf{x}}_1(t) \\ \dot{\mathbf{x}}_2(t) \end{bmatrix} = \begin{bmatrix} \mathbf{A}_1 - \mathbf{B}_1\mathbf{D}_2\mathbf{C}_1 & \mathbf{B}_1\mathbf{C}_2 \\ -\mathbf{B}_2\mathbf{C}_1 & \mathbf{A}_2 \end{bmatrix} \begin{bmatrix} \mathbf{x}_1(t) \\ \mathbf{x}_2(t) \end{bmatrix} + \begin{bmatrix} \mathbf{B}_1\mathbf{D}_2 \\ \mathbf{B}_2 \end{bmatrix} \mathbf{u}(t) \quad (24.150)$$

$$\mathbf{y}(t) = [\mathbf{C}_1 \quad \mathbf{0}] \begin{bmatrix} \mathbf{x}_1(t) \\ \mathbf{x}_2(t) \end{bmatrix} \quad (24.151)$$

The same results apply, mutatis mutandis, to discrete-time interconnected systems. More details can be found elsewhere, e.g., in [15].

24.6 System Properties

Controllability, Reachability, and Stabilizability

A very important question that we must be interested in regarding control systems using state space models is whether or not we can steer the state via the control input to certain locations in the state space. We must remember that the states of a system frequently are internal variables like temperature, pressure, level of tanks, or others. These are sometimes critical variables that we want to keep between specific values.

Controllability

The issue of controllability is concerned with whether or not a given initial state \mathbf{x}_0 can be steered to the origin in finite time using the input $\mathbf{u}(t)$.

Example 24.11

If we examine the model defined in (24.152), we note that the input $u(t)$ has no effect over the state $x_2(t)$.

$$\begin{bmatrix} \dot{x}_1(t) \\ \dot{x}_2(t) \end{bmatrix} = \begin{bmatrix} 0 & 1 \\ 0 & 0 \end{bmatrix} \begin{bmatrix} x_1(t) \\ x_2(t) \end{bmatrix} + \begin{bmatrix} 1 \\ 0 \end{bmatrix} u(t) \quad (24.152)$$

Given an initial state $[x_1(0), x_2(0)]^T$, the input $u(t)$ can be chosen to steer $x_1(t)$ to zero, while $x_2(t)$ remains unchanged.

Formally, we have the following definition:

Definition 24.1 A state x_o is said to be **controllable** if there exists a finite interval $[0, T]$ and an input $\{u(t), t \in [0, T]\}$ such that $x(T) = 0$. If all states are controllable, then the system is said to be **completely controllable**.

Reachability

A related concept is that of **reachability**, used sometimes in discrete-time systems. It is formally defined as follows:

Definition 24.2 A state $\bar{\mathbf{x}} \neq \mathbf{0}$ is said to be **reachable**, from the origin, if given $\mathbf{x}(0) = \mathbf{0}$, there exists a finite time interval $[0, T]$ and an input $\{\mathbf{u}(t), t \in [0, T]\}$ such that $\mathbf{x}(T) = \bar{\mathbf{x}}$. If all states are reachable the system is said to be **completely reachable**.

For continuous, time-invariant, linear systems, there is no distinction between complete controllability and reachability. However, the following example illustrates that there is a subtle difference in the

discrete-time case. Consider the system and the output

$$\mathbf{x}[t+1] = \underbrace{\begin{bmatrix} 0.5 & 1 \\ -0.25 & -0.5 \end{bmatrix}}_{\mathbf{A}_d} \mathbf{x}[t] \Rightarrow \mathbf{x}[t] = \begin{bmatrix} 0.5 & 1 \\ -0.25 & -0.5 \end{bmatrix}^t \mathbf{x}[0] \quad (24.153)$$

We can see that this system is completely controllable since $\mathbf{x}[t] = 0, \forall t \geq 2$ and $\forall \mathbf{x}[0] \in \mathbb{R}^2$. This implies that every initial state is controllable. However, no nonzero state is reachable.

In view of the distinction between controllability and reachability in discrete time, we will use the term *controllability* in the sequel to cover the stronger of the two concepts.

Usually, in the context of linear time invariant systems, controllability and reachability are used interchangeably.

Controllability Test

We now present a systematic way to determine the complete controllability of a system.

Theorem 24.3 Consider the linear, time-invariant, state space model where $\mathbf{A} \in \mathbb{R}^{n \times n}$:

$$\dot{\mathbf{x}}(t) = \mathbf{A}\mathbf{x}(t) + \mathbf{B}\mathbf{u}(t) \quad (24.154)$$

$$\mathbf{y}(t) = \mathbf{C}\mathbf{x}(t) + \mathbf{D}\mathbf{u}(t) \quad (24.155)$$

i) The set of all controllable states is the **range space** of the controllability matrix $\mathbf{\Gamma}_c[\mathbf{A}, \mathbf{B}]$ where

$$\mathbf{\Gamma}_c[\mathbf{A}, \mathbf{B}] \triangleq [\mathbf{B} \quad \mathbf{A}\mathbf{B} \quad \mathbf{A}^2\mathbf{B} \quad \cdots \quad \mathbf{A}^{n-1}\mathbf{B}] \quad (24.156)$$

ii) The model is completely controllable if and only if $\mathbf{\Gamma}_c[\mathbf{A}, \mathbf{B}]$ has **full row rank**.

Example 24.12

Consider the state space model given in (24.152), with state space matrices

$$\mathbf{A} = \begin{bmatrix} 0 & 1 \\ 0 & 0 \end{bmatrix}, \quad \mathbf{B} = \begin{bmatrix} 1 \\ 0 \end{bmatrix} \quad (24.157)$$

The controllability matrix for this system, is given by

$$\mathbf{\Gamma}_c[\mathbf{A}, \mathbf{B}] = [\mathbf{B} \quad \mathbf{A}\mathbf{B}] = \begin{bmatrix} 1 & 0 \\ 0 & 0 \end{bmatrix} \quad (24.158)$$

Clearly, $\text{rank } \mathbf{\Gamma}_c[\mathbf{A}, \mathbf{B}] = 1$, thus the system is **not** completely controllable.

The result above applies to continuous-time models, and it holds equally well for reachability of discrete-time models.

Also we can see that the controllability of a system is a property that does not depend on the choice of state variables. To see that, consider the similarity transformation defined in subsection "State Similarity Transformation." Then, observing that $\bar{\mathbf{A}}^i = \mathbf{T}^{-1}\mathbf{A}^i\mathbf{T}$, we have

$$\mathbf{\Gamma}_c[\bar{\mathbf{A}}, \bar{\mathbf{B}}] = \mathbf{T}^{-1}\mathbf{\Gamma}_c[\mathbf{A}, \mathbf{B}] \quad (24.159)$$

which implies that $\mathbf{\Gamma}_c[\bar{\mathbf{A}}, \bar{\mathbf{B}}]$ and $\mathbf{\Gamma}_c[\mathbf{A}, \mathbf{B}]$ have the same rank.

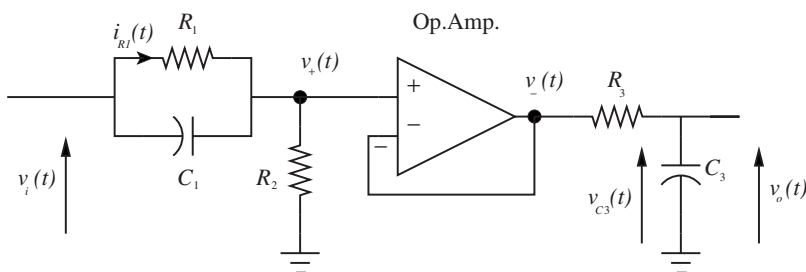

FIGURE 24.13 Electronic circuit.

The reader may wish to check that the state space models used to describe signals in subsection “Signals and State Space Description” are uncontrollable. Indeed, it is always true **that any state space model where $\mathbf{B} = \mathbf{0}$ is completely uncontrollable.**

Loss of Controllability

Lack of controllability is sometimes a structural feature. However, in some other cases, it depends on the numerical value of certain parameters. We illustrate this in the following example.

Example 24.13

Consider the electronic circuit shown in Fig. 24.13.

We first build a state space model for the circuit. We choose, as state variables, $x_1(t) = i_{R_1}(t)$ and $x_2(t) = v_{C_3}(t)$. Using first principles on the left half of the circuit we have that

$$i_{C_1} = C_1 \frac{d}{dt}(v_i - v_+), \quad i_{R_1} = \frac{v_i - v_+}{R_1}, \quad i_{R_2} = \frac{v_+}{R_2}, \quad i_{C_1} = i_{R_2} - i_{R_1} \quad (24.160)$$

This yields

$$\frac{di_{R_1}(t)}{dt} = -\frac{(R_1 + R_2)}{C_1 R_1 R_2} i_{R_1}(t) + \frac{1}{C_1 R_1 R_2} v_i(t) \quad (24.161)$$

$$v_+(t) = -R_1 i_{R_1}(t) + v_i(t) \quad (24.162)$$

And, similarly, from the right half of the circuit we obtain

$$\frac{dv_{C_3}(t)}{dt} = -\frac{1}{R_3 C_3} v_{C_3}(t) + \frac{1}{R_3 C_3} v_-(t) \quad (24.163)$$

$$v_o(t) = v_{C_3}(t) \quad (24.164)$$

The (ideal) operational amplifier ensures that $v_+(t) = v_-(t)$, so we can combine the state space models given in Eqs. (24.161)–(24.164) to obtain

$$\begin{bmatrix} \frac{di_{R_1}(t)}{dt} \\ \frac{dv_{C_3}(t)}{dt} \end{bmatrix} = \begin{bmatrix} \frac{(R_1 + R_2)}{C_1 R_1 R_2} & 0 \\ \frac{R_1}{R_3 C_3} & -\frac{1}{R_3 C_3} \end{bmatrix} \begin{bmatrix} i_{R_1}(t) \\ v_{C_3}(t) \end{bmatrix} + \begin{bmatrix} \frac{1}{C_1 R_1 R_2} \\ \frac{1}{C_3 R_3} \end{bmatrix} v_i(t) \quad (24.165)$$

$$v_o(t) = [0 \ 1] \begin{bmatrix} i_{R_1}(t) \\ v_{C_3}(t) \end{bmatrix} \quad (24.166)$$

The controllability matrix is then given by

$$\Gamma_c[\mathbf{A}, \mathbf{B}] = [\mathbf{B} \quad \mathbf{AB}] = \begin{bmatrix} \frac{1}{R_1 R_2 C_1} & \frac{-(R_1 + R_1)}{(R_1 R_2 C_1)^2} \\ \frac{1}{R_3 C_3} & \frac{-(R_2 C_1 + R_3 C_3)}{(R_3 C_3)^2 R_2 C_1} \end{bmatrix} \quad (24.167)$$

and

$$\det(\Gamma_c[\mathbf{A}, \mathbf{B}]) = \frac{R_2}{(R_1 R_2 R_3 C_1 C_2)^2} (-R_1 C_1 + R_3 C_3) \quad (24.168)$$

where we can observe that the system is completely controllable if, and only if, $R_1 C_1 \neq R_3 C_3$.

This issue has a very important interpretation if we analyze it from the transfer function point of view. Applying Laplace transform to Eqs. (24.161)–(24.164), the transfer function from $v_i(t)$ to $v_o(t)$ (recall that $V_+(s) = V_-(s)$) is given by

$$\frac{V_o(s)}{V_i(s)} = \frac{V_o(s) V_+(s)}{V_-(s) V_i(s)} = \frac{\frac{1}{R_3 C_3}}{\left(s + \frac{1}{R_3 C_3}\right)} \cdot \frac{\left(s + \frac{1}{R_1 C_1}\right)}{\left(s + \frac{R_1 + R_2}{R_1 R_2 C_1}\right)} \quad (24.169)$$

where we can observe that the loss of complete controllability, when $R_1 C_1 = R_3 C_3$ obtained from (24.168), means that there is a **zero-pole cancellation** in the transfer function, i.e., the zero from the left half of the circuit in Fig. 24.13 is cancelled by the pole from the other part of the circuit. This issue will be discussed in more detail in section “Canonical Decomposition.”

Controllability Gramian

The test of controllability gives us a *yes or no* answer about the controllability of a system model. However, to conclude that a system is completely controllable says nothing about the *degree* of controllability. For **stable** systems, we can quantify the effort to control the system state through the energy involved in the input signal $\mathbf{u}(t)$ applied from $t = -\infty$ to reach the state $\mathbf{x}(0) = \mathbf{x}_0$ at $t = 0$:

$$J(\mathbf{u}) = \int_{-\infty}^0 \|\mathbf{u}(t)\|^2 dt = \int_{-\infty}^0 \mathbf{u}(t)^T \mathbf{u}(t) dt \quad (24.170)$$

It can be shown that the minimal *control energy* is

$$J(\mathbf{u}_{\text{opt}}) = \mathbf{x}_0^T \mathbf{P}^{-1} \mathbf{x}_0 \quad (24.171)$$

where

$$\mathbf{P} = \int_0^{\infty} e^{\mathbf{A}t} \mathbf{B} \mathbf{B}^T e^{\mathbf{A}^T t} dt \quad (24.172)$$

The matrix \mathbf{P} is called the **controllability gramian**, and it measures the controllability of the state vector $\mathbf{x}(0)$. If this matrix is *small*, it means that we need a lot of energy in the control input $\mathbf{u}(t)$ to steer the state vector to \mathbf{x}_0 . Indeed, we can appreciate the necessary effort for each one of the state variables, making, for example $\mathbf{x}_0 = [0, \dots, 0, 1, 0, \dots, 0]^T$.

It is important to emphasize that the existence of the integral defined in (24.172) is guaranteed only if the eigenvalues of \mathbf{A} have negative real part, i.e., the system must be stable.

Also, the controllability gramian P defined in (24.172) satisfies the Lyapunov equation

$$\mathbf{A}\mathbf{P} + \mathbf{P}\mathbf{A}^T + \mathbf{B}\mathbf{B}^T = 0 \quad (24.173)$$

For discrete-time systems we have the following equations for the controllability gramian:

$$\mathbf{P}_d = \sum_{k=0}^{\infty} \mathbf{A}_d^k \mathbf{B}_d \mathbf{B}_d^T (\mathbf{A}_d^T)^k \quad (24.174)$$

which satisfies

$$\mathbf{A}_d \mathbf{P}_d \mathbf{A}_d^T - \mathbf{P}_d + \mathbf{B}_d \mathbf{B}_d^T = 0 \quad (24.175)$$

The sum defined in (24.174) is bounded if and only if the discrete-time system is stable, i.e., its eigenvalues lie inside the unit disc.

Example 24.14

We can analyze the model of the Example 24.13, where the electronic circuit was described by the state space models (24.165) and (24.166). If we want to appreciate the information that we can obtain from the controllability gramian, defined in (24.172), when the model is close to losing complete controllability, we can choose suitable values of the parameters that ensure $R_1 C_1 \approx R_3 C_3$.

If we choose

$$R_1 = R_2 = R_3 = 10^3 \, \Omega, \quad C_1 = 0.9 \times 10^3 \, \mu\text{F}, \quad C_3 = 10^3 \, \mu\text{F} \quad (24.176)$$

the model will be described by

$$\begin{bmatrix} \dot{i}_{R1}(t) \\ \dot{v}_{C3}(t) \end{bmatrix} = \begin{bmatrix} -\frac{20}{9} & 0 \\ -10^3 & -1 \end{bmatrix} \begin{bmatrix} i_{R1}(t) \\ v_{C3}(t) \end{bmatrix} + \begin{bmatrix} \frac{0.01}{9} \\ 1 \end{bmatrix} v_i(t) \quad (24.177)$$

$$v_o(t) = \begin{bmatrix} 0 & 1 \end{bmatrix} \begin{bmatrix} i_{R1}(t) \\ v_{C3}(t) \end{bmatrix} \quad (24.178)$$

If we look at the relative magnitude of the elements of \mathbf{B} , we can *a priori* say that the effect of the input $u(t)$ upon the state $i_{R1}(t)$ will be much weaker than its effect upon the state $v_{C3}(t)$. To verify this we can compute the controllability gramian defined in (24.172), solving

$$\mathbf{0} = \mathbf{A}\mathbf{P} + \mathbf{P}\mathbf{A}^T + \mathbf{B}\mathbf{B}^T \quad (24.179)$$

$$\mathbf{0} = \begin{bmatrix} -\frac{20}{9} & 0 \\ -10^3 & -1 \end{bmatrix} \begin{bmatrix} p_{11} & p_{12} \\ p_{21} & p_{22} \end{bmatrix} + \begin{bmatrix} p_{11} & p_{12} \\ p_{21} & p_{22} \end{bmatrix} \begin{bmatrix} -\frac{20}{9} & -10^3 \\ 0 & -1 \end{bmatrix} + \begin{bmatrix} \frac{0.01}{9} \\ 1 \end{bmatrix} \begin{bmatrix} \frac{0.01}{9} & 1 \end{bmatrix} \quad (24.180)$$

We have

$$\mathbf{P} = \begin{bmatrix} 0.28 \times 10^{-6} & 0.000258620 \\ 0.000258620 & 0.99999948 \end{bmatrix}, \quad \mathbf{P}^{-1} = \begin{bmatrix} 4736624.0 & -1224.9 \\ -1224.9 & 1.3 \end{bmatrix} \quad (24.181)$$

So we can obtain the minimal control energy to steer the state $\mathbf{x}(t)$, from 0 in $t = -\infty$ to \mathbf{x}_0 in $t = 0$, from Eq. (24.171).

$$\mathbf{x}_0 = [1, 0]^T \Rightarrow J(u_{\text{opt}}) = 4736624.0 \quad (24.182)$$

$$\mathbf{x}_0 = [0, 1]^T \Rightarrow J(u_{\text{opt}}) = 1.3 \quad (24.183)$$

We can thus verify that the control energy to attain $i_{R1}(0) = 1$ is six orders of magnitude greater than the necessary energy to attain $v_{C3}(0) = 1$.

Also, if we substitute the parameter values in Eq. (24.169), we have that the transfer function is given by

$$\frac{V_o(s)}{V_i(s)} = \frac{1}{s+1} \cdot \frac{s+1+\frac{1}{9}}{s+\frac{20}{95}} \quad (24.184)$$

from where we observe a **zero-pole quasi cancellation**.

The idea of gramian has been extended to include the unstable case; see [16].

Canonical Decomposition and Stabilizability

If we have a system which is not completely controllable, it can be **decomposed** into a controllable subsystem and a completely uncontrollable subsystem in the following way.

Lemma 24.1 *Consider a system having rank $\{\mathbf{\Gamma}_c[\mathbf{A}, \mathbf{B}]\} = k < n$. Then there exists a similarity transformation \mathbf{T} such that $\bar{\mathbf{x}} = \mathbf{T}^{-1}\mathbf{x}$,*

$$\bar{\mathbf{A}} = \mathbf{T}^{-1}\mathbf{A}\mathbf{T}, \quad \bar{\mathbf{B}} = \mathbf{T}^{-1}\mathbf{B} \quad (24.185)$$

and $\bar{\mathbf{A}}, \bar{\mathbf{B}}$ have the form

$$\bar{\mathbf{A}} = \begin{bmatrix} \bar{\mathbf{A}}_c & \bar{\mathbf{A}}_{12} \\ \mathbf{0} & \bar{\mathbf{A}}_{nc} \end{bmatrix}, \quad \bar{\mathbf{B}} = \begin{bmatrix} \bar{\mathbf{B}}_c \\ \mathbf{0} \end{bmatrix} \quad (24.186)$$

where $\bar{\mathbf{A}}_c$ has dimension k and $(\bar{\mathbf{A}}_c, \bar{\mathbf{B}}_c)$ is completely controllable.

The above result tells us what states we can and what states we cannot steer to zero. To appreciate this, we express the state and output equations in the form

$$\begin{bmatrix} \dot{\bar{\mathbf{x}}}_c \\ \dot{\bar{\mathbf{x}}}_{nc} \end{bmatrix} = \begin{bmatrix} \bar{\mathbf{A}}_c & \bar{\mathbf{A}}_{12} \\ \mathbf{0} & \bar{\mathbf{A}}_{nc} \end{bmatrix} \begin{bmatrix} \bar{\mathbf{x}}_c \\ \bar{\mathbf{x}}_{nc} \end{bmatrix} + \begin{bmatrix} \bar{\mathbf{B}}_c \\ \mathbf{0} \end{bmatrix} \mathbf{u} \quad (24.187)$$

$$\mathbf{y} = \begin{bmatrix} \bar{\mathbf{C}}_c & \bar{\mathbf{C}}_{nc} \end{bmatrix} \begin{bmatrix} \bar{\mathbf{x}}_c \\ \bar{\mathbf{x}}_{nc} \end{bmatrix} + \mathbf{D}\mathbf{u} \quad (24.188)$$

The **controllable subspace** of a state space model is composed of all states generated through every possible linear combination of the states in $\bar{\mathbf{x}}_c$. The stability of this subspace is determined by the location of the eigenvalues of $\bar{\mathbf{A}}_c$.

On the other hand, the **uncontrollable subspace** is composed of all states generated through every possible linear combination of the states in $\bar{\mathbf{x}}_{nc}$. The stability of this subspace is determined by the location of the eigenvalues of $\bar{\mathbf{A}}_{nc}$.

Hence, the input will have no effect over the uncontrollable subspace, so the best we can hope is that this uncontrollable subspace is stable, since then the state in this subspace will go to the origin. In this case the state space model is said to be **stabilizable**.

A key feature of the descriptions (24.187) and (24.188) arises from the fact that the transfer function is given by

$$\mathbf{H}(s) = \bar{\mathbf{C}}_c(s\mathbf{I} - \bar{\mathbf{A}}_c)^{-1}\bar{\mathbf{B}}_c + \mathbf{D} \quad (24.189)$$

Equation (24.189) says that the eigenvalues of the uncontrollable subspace do not belong to the set of poles of the system transfer function. This implies that there is a cancellation of all poles corresponding to the roots of $(s\mathbf{I} - \bar{\mathbf{A}}_{nc})$.

Controllability Canonical Form

Lemma 24.2 Consider a completely reachable state space model for a SISO system. Then, there exists a similarity transformation which converts the state space model into the following **controllability canonical form**:

$$\mathbf{A}' = \begin{bmatrix} 0 & 0 & \dots & 0 & -\alpha_0 \\ 1 & 0 & \dots & 0 & -\alpha_1 \\ 0 & 1 & \dots & 0 & -\alpha_2 \\ \vdots & \vdots & \ddots & \vdots & \vdots \\ 0 & 0 & \dots & 1 & -\alpha_{n-1} \end{bmatrix}, \quad \mathbf{B}' = \begin{bmatrix} 1 \\ 0 \\ 0 \\ \vdots \\ 0 \end{bmatrix} \quad (24.190)$$

where $\lambda^n + \alpha_{n-1}\lambda^{n-1} + \dots + \alpha_1\lambda + \alpha_0 = \det(\lambda\mathbf{I} - \mathbf{A})$ is the characteristic polynomial of \mathbf{A} .

Lemma 24.3 Consider a completely controllable state space model for a SISO system. Then, there exists a similarity transformation which converts the state space model into the following **controller canonical form**:

$$\mathbf{A}'' = \begin{bmatrix} -\alpha_{n-1} & -\alpha_{n-2} & \dots & -\alpha_1 & -\alpha_0 \\ 1 & 0 & \dots & 0 & 0 \\ 0 & 1 & \dots & 0 & 0 \\ \vdots & \vdots & \ddots & \vdots & \vdots \\ 0 & 0 & \dots & 1 & 0 \end{bmatrix}, \quad \mathbf{B}'' = \begin{bmatrix} 1 \\ 0 \\ 0 \\ \vdots \\ 0 \end{bmatrix} \quad (24.191)$$

where $\lambda^n + \alpha_{n-1}\lambda^{n-1} + \dots + \alpha_1\lambda + \alpha_0 = \det(\lambda\mathbf{I} - \mathbf{A})$ is the characteristic polynomial of \mathbf{A} .

Observability, Reconstructibility, and Detectability

If we consider the state space model of a system, one might conjecture that if one observes the output over some time interval then this might tell us some information about the state. The associated model property is called observability (or reconstructibility).

Observability

Observability is concerned with the issue of what can be said on the state if we measure the plant output.

Example 24.15

If we look at the system defined by state space model

$$\begin{bmatrix} \dot{x}_1(t) \\ \dot{x}_2(t) \end{bmatrix} = \begin{bmatrix} -1 & 0 \\ 1 & -1 \end{bmatrix} \begin{bmatrix} x_1(t) \\ x_2(t) \end{bmatrix}, \quad y(t) = [1 \quad 0] \begin{bmatrix} x_1(t) \\ x_2(t) \end{bmatrix} \quad (24.192)$$

we can see that the output $y(t)$ only is determined by $x_1(t)$, and the other state variable $x_2(t)$ has no influence on the output. So the system is not completely observable.

A formal definition is as follows:

Definition 24.3 The state $\mathbf{x}_0 \neq \mathbf{0}$ is said to be **unobservable** if given $\mathbf{x}(0) = \mathbf{x}_0$, and $\mathbf{u}(t) = \mathbf{0}$ for $t \geq 0$, then $\mathbf{y}(t) = \mathbf{0}$ for $t \geq 0$, i.e., we cannot see any effect of \mathbf{x}_0 on the system output.

The system is said to be **completely observable** if there exists no nonzero initial state that it is unobservable.

Reconstructibility

There is another concept, closely related to observability, called **reconstructibility**. Reconstructibility is concerned with what can be said about $\mathbf{x}(T)$, having observed the **past** values of the output, \mathbf{y} , for $0 \leq t \leq T$. For linear time invariant, continuous-time systems, the distinction between observability and reconstructibility is unnecessary. However, the following example illustrates that in discrete time, the two concepts are different. Consider

$$\mathbf{x}[t+1] = \mathbf{0}, \quad \mathbf{x}[0] = \mathbf{x}_0 \quad (24.193)$$

$$\mathbf{y}[t] = \mathbf{0} \quad (24.194)$$

This system is clearly reconstructible for all $T \geq 1$, since we know for certain that $\mathbf{x}[T] = \mathbf{0}$ for $T \geq 1$. However, it is completely unobservable since $\mathbf{y}[t] = \mathbf{0}$, $\forall k$ irrespective of \mathbf{x}_0 .

In view of the subtle difference between observability and reconstructibility, we will use the term *observability* in the sequel to cover the stronger of the two concepts.

Observability Test

A test for observability of a system is established in the following theorem.

Theorem 24.4 Consider the linear, continuous, time-invariant, state space model where $\mathbf{A} \in \mathbb{R}^{n \times n}$

$$\dot{\mathbf{x}}(t) = \mathbf{A}\mathbf{x}(t) + \mathbf{B}\mathbf{u}(t) \quad (24.195)$$

$$\mathbf{y}(t) = \mathbf{C}\mathbf{x}(t) + \mathbf{D}\mathbf{u}(t) \quad (24.196)$$

i) The set of all unobservable states is equal to the null space of the observability matrix $\mathbf{\Gamma}_o[\mathbf{A}, \mathbf{C}]$ where

$$\mathbf{\Gamma}_o[\mathbf{A}, \mathbf{C}] \triangleq \begin{bmatrix} \mathbf{C} \\ \mathbf{C}\mathbf{A} \\ \vdots \\ \mathbf{C}\mathbf{A}^{n-1} \end{bmatrix} \quad (24.197)$$

ii) The system is completely observable if and only if $\mathbf{\Gamma}_o[\mathbf{A}, \mathbf{C}]$ has **full column rank** n .

Example 24.16

Consider the following state space model:

$$\mathbf{A} = \begin{bmatrix} -3 & -2 \\ 1 & 0 \end{bmatrix}, \quad \mathbf{B} = \begin{bmatrix} 1 \\ 0 \end{bmatrix}, \quad \mathbf{C} = [1 \quad -1] \quad (24.198)$$

The observability matrix is given by

$$\mathbf{\Gamma}_o[\mathbf{A}, \mathbf{C}] = \begin{bmatrix} \mathbf{C} \\ \mathbf{CA} \end{bmatrix} = \begin{bmatrix} 1 & -1 \\ -4 & -2 \end{bmatrix} \quad (24.199)$$

Hence $\text{rank } \mathbf{\Gamma}_o[\mathbf{A}, \mathbf{C}] = 2$, which says that the system is completely observable.

Example 24.17

If we look at the model defined in (24.192), we have

$$\mathbf{A} = \begin{bmatrix} -1 & 0 \\ 1 & -1 \end{bmatrix}, \quad \mathbf{C} = [1 \quad 0] \quad (24.200)$$

The observability matrix is

$$\mathbf{\Gamma}_o[\mathbf{A}, \mathbf{C}] = \begin{bmatrix} 1 & 0 \\ -1 & 0 \end{bmatrix} \quad (24.201)$$

Hence $\text{rank } \mathbf{\Gamma}_o[\mathbf{A}, \mathbf{C}] = 1 < 2$ and the system is not completely observable.

The above result also applies to discrete-time models.

The observability is a system property that does not depend on the choice of state variables. It can be proved that the rank of the matrix defined in Eq. (24.197) does not change when a similarity transformation \mathbf{T} is used (see subsection “State Similarity Transformation”).

Loss of Observability

Lack of observability may arise from structural system features. However, it is also possible that lack of observability occurs when certain system parameters take some specific numerical values. This is the same phenomenon, for controllability, we analyzed in the subsection “Controllability, Reachability, and Stabilizability.” We expect that those parameters will affect the complete observability of the model in a similar way. Let us look at the following example.²

Example 24.18

Consider the electronic circuit in Fig. 24.14. We can see this is the same as that in Fig. 24.13 where the left and right halves were swapped, so we can use similar equations to obtain a state space model. The state variables have been chosen to be $x_1(t) = v_{C3}(t)$ and $x_2(t) = i_{R1}(t)$.

For the left half of the circuit, we have

$$\frac{dv_{C3}(t)}{dt} = -\frac{1}{R_3 C_3} v_{C3}(t) + \frac{1}{R_3 C_3} v_i(t) \quad (24.202)$$

$$v_+(t) = v_{C3}(t) \quad (24.203)$$

²Which is the *dual* of Example 24.13.

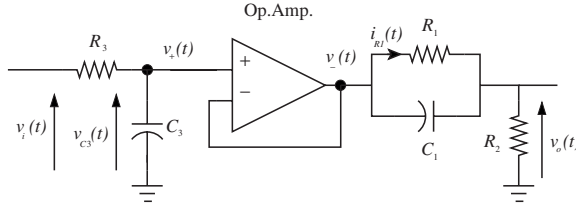

FIGURE 24.14 Electronic circuit.

And for the right half, we have

$$\frac{di_{R1}(t)}{dt} = -\left(\frac{R_1 + R_2}{C_1 R_1 R_2}\right)i_{R1}(t) + \frac{1}{C_1 R_1 R_2}v_-(t) \quad (24.204)$$

$$v_o(t) = -R_1 i_{R1}(t) + v_-(t) \quad (24.205)$$

The operational amplifier, in voltage follower connection, ensures that $v_+(t) = v_-(t)$, so we can combine the state space models given in Eqs. (24.202)–(24.205):

$$\begin{bmatrix} \frac{dv_{C3}(t)}{dt} \\ \frac{di_{R1}(t)}{dt} \end{bmatrix} = \begin{bmatrix} -\frac{1}{R_3 C_3} & 0 \\ \frac{1}{C_1 R_1 R_2} & -\frac{R_1 + R_2}{C_1 R_1 R_2} \end{bmatrix} \begin{bmatrix} v_{C3}(t) \\ i_{R1}(t) \end{bmatrix} + \begin{bmatrix} \frac{1}{R_3 C_3} \\ 0 \end{bmatrix} v_i(t) \quad (24.206)$$

$$v_o(t) = [1 \quad -R_1] \begin{bmatrix} v_{C3}(t) \\ i_{R1}(t) \end{bmatrix} \quad (24.207)$$

The observability matrix is given by

$$\Gamma_c[\mathbf{C}, \mathbf{A}] = \begin{bmatrix} \mathbf{C} \\ \mathbf{CA} \end{bmatrix} = \begin{bmatrix} 1 & -R_1 \\ -\frac{1}{R_3 C_3} - \frac{1}{R_2 C_1} & \frac{R_1 + R_2}{R_2 C_1} \end{bmatrix} \quad (24.208)$$

To determine the complete observability, or otherwise, we need to compute the matrix determinant

$$\det(\Gamma_c[\mathbf{C}, \mathbf{A}]) = \frac{1}{R_3 C_3 C_1}(-R_1 C_1 + R_3 C_3) \quad (24.209)$$

from where we conclude that the model system is completely observable if and only if, $R_1 C_1 \neq R_3 C_3$, which is the same condition we obtained in Example 24.13.

Applying Laplace transform to Eqs. (24.204)–(24.203) we obtain the transfer function from $V_i(s)$ to $V_o(s)$:

$$\frac{V_o(s)}{V_i(s)} = \frac{V_+(s)}{V_i(s)} \frac{V_o(s)}{V_-(s)} = \frac{s + \frac{1}{R_1 C_1}}{s + \frac{R_1 + R_2}{R_1 R_2 C_1}} \cdot \frac{\frac{1}{R_3 C_3}}{s + \frac{1}{R_3 C_3}} \quad (24.210)$$

The condition $R_1C_1 = R_3C_3$ produces the loss of complete observability, leading to a **pole-zero cancellation** in the model transfer function, i.e., the pole from the left half of the circuit in Fig. 24.14 is cancelled by the zero from the right half. There is subtle difference between the transfer functions in (24.210) and (24.169). The final result is the same, but the order the cancellation is different in each case. The **zero-pole cancellation** is connected to the loss of complete observability and the **pole-zero cancellation** is connected to the loss of complete controllability. These issues will be discussed in more detail in subsection “Canonical Decomposition.”

Observability Gramian

The observability test in Theorem 24.4 answers *yes* or *no* to the question about completely observability of a model. However, sometimes we are interested in the *degree* of observability for a particular model. So we can quantify the energy of the output signal $\mathbf{y}(t)$, when there is no input ($\mathbf{u}(t) = \mathbf{0}$) and the state is $\mathbf{x}(0) = \mathbf{x}_0$ at $t = 0$

$$E(\mathbf{x}_0) = \int_0^\infty \|\mathbf{y}(t)\|^2 dt = \int_0^\infty \mathbf{y}(t)^T \mathbf{y}(t) dt \quad (24.211)$$

It can be proved that the *output energy* is

$$E(\mathbf{x}_0) = \int_0^\infty \|\mathbf{y}(t)\|^2 dt = \mathbf{x}_0^T \mathbf{Q} \mathbf{x}_0 \quad (24.212)$$

where

$$\mathbf{Q} = \int_0^\infty e^{\mathbf{A}^T t} \mathbf{C}^T \mathbf{C} e^{\mathbf{A} t} dt \quad (24.213)$$

The matrix \mathbf{Q} is called **observability gramian**, and it measures the observability of the state vector $\mathbf{x}(0)$. If this matrix is *small*, it means that we have a weak contribution of the initial state \mathbf{x}_0 in the energy of the output $\mathbf{y}(t)$. Indeed, we can appreciate the effect of each one of the state variables taking, for example, $\mathbf{x}_0 = [0, \dots, 0, 1, 0, \dots, 0]^T$.

Note that the existence of the integral defined in (24.213) is guaranteed if and only if the system is stable, i.e., if and only if the eigenvalues of \mathbf{A} have negative real part.

Also, the observability gramian \mathbf{Q} defined in (24.213) satisfies the Lyapunov equation

$$\mathbf{A}^T \mathbf{Q} + \mathbf{Q} \mathbf{A} + \mathbf{C}^T \mathbf{C} = 0 \quad (24.214)$$

For stable discrete-time systems, the controllability gramian is defined by

$$\mathbf{Q}_d = \sum_{k=0}^{\infty} (\mathbf{A}_d^T)^k \mathbf{C}_d^T \mathbf{C}_d \mathbf{A}_d^k \quad (24.215)$$

which satisfies

$$\mathbf{A}_d^T \mathbf{Q}_d \mathbf{A}_d - \mathbf{Q}_d + \mathbf{C}_d^T \mathbf{C}_d = 0 \quad (24.216)$$

Example 24.19

We will use the model of Example 24.18, described by the state space models (24.206) and (24.207), to appreciate the utility of the observability gramian (24.213), especially when the model is close to losing complete observability, i.e., when $R_1C_1 \approx R_3C_3$.

Assuming the same component values as in Example 24.14 for $R_1, R_2, R_3, C_1,$ and C_3 we have

$$\begin{bmatrix} \dot{v}_{C3}(t) \\ \dot{i}_{R1}(t) \end{bmatrix} = \begin{bmatrix} -1 & 0 \\ 10^{-3} & -\frac{20}{9} \end{bmatrix} \begin{bmatrix} v_{C3}(t) \\ i_{R1}(t) \end{bmatrix} + \begin{bmatrix} 1 \\ 0 \end{bmatrix} v_i(t) \quad (24.217)$$

$$v_o(t) = [1 \quad -10^3] \begin{bmatrix} v_{C3}(t) \\ i_{R1}(t) \end{bmatrix} \quad (24.218)$$

If we look at the relative magnitude of the components of \mathbf{C} matrix, we can foretell *a priori* that the output $v_o(t)$ will be mainly determined by state $i_{R1}(t)$. To verify this we compute the observability gramian defined in (24.172), solving

$$\mathbf{0} = \mathbf{A}^T \mathbf{Q} + \mathbf{Q} \mathbf{A} + \mathbf{C}^T \mathbf{C} \quad (24.219)$$

$$\mathbf{0} = \begin{bmatrix} -1 & 10^{-3} \\ 0 & -\frac{20}{9} \end{bmatrix} \begin{bmatrix} q_{11} & q_{12} \\ q_{21} & q_{22} \end{bmatrix} + \begin{bmatrix} q_{11} & q_{12} \\ q_{21} & q_{22} \end{bmatrix} \begin{bmatrix} -1 & 0 \\ 10^{-3} & -\frac{20}{9} \end{bmatrix} + \begin{bmatrix} 1 \\ -10^3 \end{bmatrix} [1 \quad 10^{-3}] \quad (24.220)$$

We have

$$\mathbf{Q} = \begin{bmatrix} 0.57 & 69.83 \\ 69.83 & 225000 \end{bmatrix} \quad (24.221)$$

From there we can compute the contribution of each state to the total energy in the output. Doing this, we verify that the state variable $i_{R1}(t)$ has an effect over the output greater than the effect of $v_{C3}(t)$, as defined in Eq. (24.212):

$$\mathbf{x}_0 = [1, 0]^T \Rightarrow E(\mathbf{x}_0) = 0.57 \quad (24.222)$$

$$\mathbf{x}_0 = [0, 1]^T \Rightarrow E(\mathbf{x}_0) = 225000 \quad (24.223)$$

The transfer function is

$$\frac{V_o(s)}{V_i(s)} = \frac{s + 1 + \frac{1}{9}}{s + \frac{20}{9}} \cdot \frac{1}{s + 1} \quad (24.224)$$

We observe that there is a pole-zero **quasi-cancellation**.

Duality Principle

We observe a remarkable similarity between the results in Theorem 24.3 and in Theorem 24.4, and also for the definitions of the gramians (24.172) and (24.213). This is known as the **duality principle**, and it can be formalized as follows:

Theorem 24.5 (Duality) Consider a state space model described by the 4-tuple $(\mathbf{A}, \mathbf{B}, \mathbf{C}, \mathbf{D})$. Then the system is completely controllable if and only if the dual system $(\mathbf{A}^T, \mathbf{C}^T, \mathbf{B}^T, \mathbf{D}^T)$ is completely observable.

Canonical Decomposition and Detectability

The above theorem can often be used to go from a result on controllability to one on observability and vice versa. The *dual* of Lemma 24.1 is:

Lemma 24.4 *If $\text{rank } \{\Gamma_0[\mathbf{A}, \mathbf{C}]\} = k < n$, there exists a similarity transformation \mathbf{T} such that with $\bar{\mathbf{x}} = \mathbf{T}^{-1}\mathbf{x}$, $\bar{\mathbf{A}} = \mathbf{T}^{-1}\mathbf{A}\mathbf{T}$, $\bar{\mathbf{C}} = \mathbf{C}\mathbf{T}$, then $\bar{\mathbf{C}}$ and $\bar{\mathbf{A}}$ take the form*

$$\bar{\mathbf{A}} = \begin{bmatrix} \bar{\mathbf{A}}_o & 0 \\ \bar{\mathbf{A}}_{21} & \bar{\mathbf{A}}_{no} \end{bmatrix}, \quad \bar{\mathbf{C}} = [\bar{\mathbf{C}}_o \quad 0] \quad (24.225)$$

where $\bar{\mathbf{A}}_o$ has dimension k and the pair $(\bar{\mathbf{C}}_o, \bar{\mathbf{A}}_o)$ is completely observable.

This result has a relevance similar to that of the controllability property and the associated decomposition. To appreciate this, we apply the dual of Lemma 24.1 to express the (transformed) state and output equations in partitioned form as

$$\begin{bmatrix} \dot{\bar{\mathbf{x}}}_o(t) \\ \dot{\bar{\mathbf{x}}}_{no}(t) \end{bmatrix} = \begin{bmatrix} \bar{\mathbf{A}}_o & 0 \\ \bar{\mathbf{A}}_{21} & \bar{\mathbf{A}}_{no} \end{bmatrix} \begin{bmatrix} \bar{\mathbf{x}}_o(t) \\ \bar{\mathbf{x}}_{no}(t) \end{bmatrix} + \begin{bmatrix} \bar{\mathbf{B}}_o \\ \bar{\mathbf{B}}_{no} \end{bmatrix} \mathbf{u}(t) \quad (24.226)$$

$$\mathbf{y}(t) = \begin{bmatrix} \bar{\mathbf{C}}_o & 0 \end{bmatrix} \begin{bmatrix} \bar{\mathbf{x}}_o(t) \\ \bar{\mathbf{x}}_{no}(t) \end{bmatrix} + \mathbf{D}\mathbf{u}(t) \quad (24.227)$$

The above description reveals why one can be in trouble when trying to control a system using only the system output. The output has no information on the state $\bar{\mathbf{x}}_{no}$.

The **observable subspace** of a model is the space composed of all states generated through every possible linear combination of the states in $\bar{\mathbf{x}}_o$. The stability of this subspace is determined by the location of the eigenvalues of $\bar{\mathbf{A}}_o$.

The **unobservable subspace** of a model is the space composed of all states generated through every possible linear combination of the states in $\bar{\mathbf{x}}_{no}$. The stability of this subspace is determined by the location of the eigenvalues of $\bar{\mathbf{A}}_{no}$.

If the unobservable subspace is stable we say that the system is **detectable**.

A key feature of the descriptions (24.226) and (24.227) arises from the fact that the transfer function is given by

$$\mathbf{H}(s) = \bar{\mathbf{C}}_o(s\mathbf{I} - \bar{\mathbf{A}}_o)^{-1}\bar{\mathbf{B}}_o + \mathbf{D} \quad (24.228)$$

Equation (24.228) says that the eigenvalues of the unobservable subspace do not belong to the set of poles of the system transfer function. This implies that there is a cancellation of all poles corresponding to the roots of $(s\mathbf{I} - \bar{\mathbf{A}}_{no})$.

Observability Canonical Form

There are also duals of the canonical forms given in Lemmas 24.2 and 24.3. For example, the dual of Lemma 24.3 is:

Lemma 24.5 *Consider a completely observable SISO system. Then there exists a similarity transformation that converts the model to the **observer canonical form**:*

$$\dot{\mathbf{x}}(t) = \begin{bmatrix} -\alpha_{n-1} & 1 & & \\ \vdots & & \ddots & \\ \vdots & & & 1 \\ -\alpha_0 & 0 & & 0 \end{bmatrix} \mathbf{x}(t) + \begin{bmatrix} b_{n-1} \\ \vdots \\ \vdots \\ b_0 \end{bmatrix} \mathbf{u}(t) \quad (24.229)$$

$$\mathbf{y}(t) = [1 \quad 0 \quad \cdots \quad 0]\mathbf{x}(t) + \mathbf{D}\mathbf{u}(t) \quad (24.230)$$

Canonical Decomposition

Further insight into the structure of linear dynamical systems is obtained by considering those systems which are only partially observable or controllable. These systems can be separated into completely observable and completely controllable systems.

The two results of Lemmas 24.1 and 24.4 can be combined for those systems, which are neither completely observable nor completely controllable. We can see it as follows.

Theorem 24.6 (Canonical Decomposition Theorem) *Consider a system described in state space form. Then, there always exists a similarity transformation \mathbf{T} such that the transformed model for $\bar{\mathbf{x}} = \mathbf{T}^{-1}\mathbf{x}$ takes the form*

$$\bar{\mathbf{A}} = \begin{bmatrix} \bar{\mathbf{A}}_{co} & \mathbf{0} & \bar{\mathbf{A}}_{13} & \mathbf{0} \\ \bar{\mathbf{A}}_{21} & \bar{\mathbf{A}}_{22} & \bar{\mathbf{A}}_{23} & \bar{\mathbf{A}}_{24} \\ \mathbf{0} & \mathbf{0} & \bar{\mathbf{A}}_{33} & \mathbf{0} \\ \mathbf{0} & \mathbf{0} & \bar{\mathbf{A}}_{34} & \bar{\mathbf{A}}_{44} \end{bmatrix}, \quad \bar{\mathbf{B}} = \begin{bmatrix} \bar{\mathbf{B}}_1 \\ \bar{\mathbf{B}}_2 \\ \mathbf{0} \\ \mathbf{0} \end{bmatrix}, \quad \bar{\mathbf{C}} = [\bar{\mathbf{C}}_1 \ \mathbf{0} \ \bar{\mathbf{C}}_2 \ \mathbf{0}] \quad (24.231)$$

where

- i) The subsystem $[\bar{\mathbf{A}}_{co}, \bar{\mathbf{B}}_1, \bar{\mathbf{C}}_1]$ is both completely controllable and completely observable and has the same transfer function as the original system (see Lemma 24.6).
- ii) The subsystem

$$\begin{bmatrix} \bar{\mathbf{A}}_{co} & \mathbf{0} \\ \bar{\mathbf{A}}_{21} & \bar{\mathbf{A}}_{22} \end{bmatrix}, \quad \begin{bmatrix} \bar{\mathbf{B}}_1 \\ \bar{\mathbf{B}}_2 \end{bmatrix}, \quad [\bar{\mathbf{C}}_1 \ \mathbf{0}] \quad (24.232)$$

is completely controllable.

- iii) The subsystem

$$\begin{bmatrix} \bar{\mathbf{A}}_{co} & \bar{\mathbf{A}}_{13} \\ \mathbf{0} & \bar{\mathbf{A}}_{33} \end{bmatrix}, \quad \begin{bmatrix} \bar{\mathbf{B}}_1 \\ \mathbf{0} \end{bmatrix}, \quad [\bar{\mathbf{C}}_1 \ \bar{\mathbf{C}}_2] \quad (24.233)$$

is completely observable.

The canonical decomposition described in Theorem 24.6 leads to an important consequence for the transfer function of the model, which will take only the completely observable and completely controllable subspace.

Lemma 24.6 *Consider the transfer function matrix $\mathbf{H}(s)$ given by*

$$\mathbf{Y}(s) = \mathbf{H}(s)\mathbf{U}(s) \quad (24.234)$$

Then

$$\mathbf{H} = \mathbf{C}(s\mathbf{I} - \mathbf{A})^{-1}\mathbf{B} + \mathbf{D} = \bar{\mathbf{C}}_1(s\mathbf{I} - \bar{\mathbf{A}}_{co})^{-1}\bar{\mathbf{B}}_1 + \mathbf{D} \quad (24.235)$$

where $\bar{\mathbf{C}}_1$, $\bar{\mathbf{A}}_{co}$, and $\bar{\mathbf{B}}_1$ are as in Eq. (24.231). This state description is a minimal realization of the transfer function.

If \mathbf{M} is any square matrix and we denote by $\Lambda\{\mathbf{M}\}$ the set of eigenvalues of \mathbf{M} , then

$$\Lambda\{\bar{\mathbf{A}}\} = \Lambda\{\bar{\mathbf{A}}_{co}\} \cup \Lambda\{\bar{\mathbf{A}}_{22}\} \cup \Lambda\{\bar{\mathbf{A}}_{33}\} \cup \Lambda\{\bar{\mathbf{A}}_{44}\} \quad (24.236)$$

where

- $\Lambda\{\bar{\mathbf{A}}\}$ = eigenvalues of the system,
- $\Lambda\{\bar{\mathbf{A}}_{co}\}$ = eigenvalues of the controllable and observable subsystem,
- $\Lambda\{\bar{\mathbf{A}}_{22}\}$ = eigenvalues of the controllable but unobservable subsystem,
- $\Lambda\{\bar{\mathbf{A}}_{33}\}$ = eigenvalues of the uncontrollable but observable subsystem,
- $\Lambda\{\bar{\mathbf{A}}_{44}\}$ = eigenvalues of the uncontrollable and unobservable subsystem.

We observe that controllability for a given system depends on the structure of the input ports, i.e., where, in the system, the manipulable inputs are applied. Thus, the states of a given subsystem may be uncontrollable for a given input, but completely controllable for another. This distinction is of fundamental importance in control system design since not all plant inputs can be manipulated (consider, for example, disturbances) and, therefore, cannot be used to steer the plant to reach certain states.

Similarly, the observability property depends on which outputs are being considered. Certain states may be unobservable from a given output, but they may be completely observable from some other output. This also has a significant impact on output feedback control systems, since some states may not appear in the plant output being measured and fed back. However, they may appear in crucial internal variables and thus be important to the control problem.

PBH Test

An alternative test for controllability and observability is provided by the following lemma known as PBH test.

Lemma 24.7 Consider a state space model $(\mathbf{A}, \mathbf{B}, \mathbf{C})$. Then

- (i) The system is not completely observable if and only if there exists a nonzero vector $\mathbf{x} \in \mathbb{C}^n$ and a scalar $\lambda \in \mathbb{C}$ such that

$$\mathbf{A}\mathbf{x} = \lambda\mathbf{x}, \quad \mathbf{C}\mathbf{x} = 0 \quad (24.237)$$

- (ii) The system is not completely controllable if and only if there exists a nonzero vector $\mathbf{x} \in \mathbb{C}^n$ and a scalar $\lambda \in \mathbb{C}$ such that

$$\mathbf{x}^T \mathbf{A} = \lambda \mathbf{x}^T, \quad \mathbf{x}^T \mathbf{B} = 0 \quad (24.238)$$

24.7 State Observers

Basic Concepts

When the state variables have to be measured for monitoring, implementing control systems, or other purposes, there are hard technical and economical issues to face. Observers are a way to estimate the state variables based upon a system model, measurements of the plant output $\mathbf{y}(t)$, and measurements of the plant input $\mathbf{u}(t)$. This problem is a generalization of that of indirectly measuring a system variable using a system model and the measurement of some other easier-to-measure variable.

Observer Dynamics

Assume that the system has a state space model given by (24.42) and (24.43) with $\mathbf{D} = \mathbf{0}$ (a strictly proper system has been assumed). Then, the general structure of a classic observer for the system state is as shown in Fig. 24.15, where the matrix \mathbf{J} is the **observer gain**.

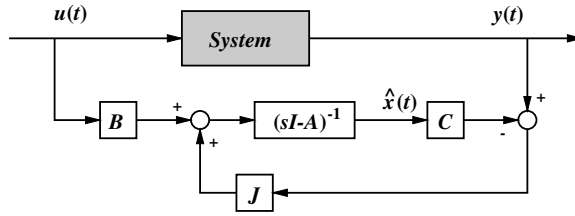

FIGURE 24.15 Classic state observer.

Therefore, the observer equation is

$$\frac{d\hat{\mathbf{x}}(t)}{dt} = \mathbf{A}\hat{\mathbf{x}}(t) + \mathbf{B}\mathbf{u}(t) + \mathbf{J}(\mathbf{y}(t) - \mathbf{C}\hat{\mathbf{x}}(t)) \quad (24.239)$$

An obvious question is: if we know an exact system model and the system input, why do we need to feed the system output? The answer is that **we need the output measurement since we do not know the system initial state**. This can be appreciated from the equation for the state estimation error, $\tilde{\mathbf{x}}(t) = \mathbf{x}(t) - \hat{\mathbf{x}}(t)$. That equation can be obtained subtracting (24.239) from (24.42). This leads to

$$\frac{d\tilde{\mathbf{x}}(t)}{dt} = (\mathbf{A} - \mathbf{J}\mathbf{C})\tilde{\mathbf{x}}(t) \quad (24.240)$$

From (24.240) we observe that the estimation error will converge to zero for a nonzero initial error if and only if all the eigenvalues of the matrix $\mathbf{A} - \mathbf{J}\mathbf{C}$ have negative real parts, i.e., if the **observer polynomial** $E(s) = \det(s\mathbf{I} - \mathbf{A} + \mathbf{J}\mathbf{C})$ is strictly Hurwitz.

Discussion

- Equation (24.240) is valid only if the model is a perfect representation of the system under study. Modelling errors will impact the observer. This will normally lead to nonzero state estimation errors.
- If the pair (\mathbf{A}, \mathbf{C}) is completely observable, then the eigenvalues of $\mathbf{A} - \mathbf{J}\mathbf{C}$ can be arbitrarily located (in the stability region). Thus, the speed of the estimation convergence is a designer's choice. Those eigenvalues are known as the **observer poles**.
- If the pair (\mathbf{A}, \mathbf{C}) is detectable, then the observer will yield zero steady state error asymptotically, although not all the eigenvalues of $\mathbf{A} - \mathbf{J}\mathbf{C}$ can be placed at will.
- If the system is not completely observable, and the unobservable subspace contains unstable modes, then the observer will never converge.

To illustrate the observer techniques we refer to Example 24.5.

Example 24.20

Assume that we want the observer poles for the state model in Example 24.5 to be located at $s = -4$, $s = -6$, and $s = -8$. We can then compute the observer gain, \mathbf{J} , using a software such as MATLAB. This yields

$$\mathbf{J} = [-4.5247 \quad -7.5617 \quad -4.1543]^T \quad (24.241)$$

To appreciate the observer dynamics, assume that the initial system state is $\mathbf{x}(0) = [-1 \quad 2 \quad 1]^T$ and that the system input is a square wave of amplitude 1, and frequency equal to 1 rad/s. The observer is initialized with $\hat{\mathbf{x}}(0) = 0$. Then the norm of the estimation error, $\|\hat{\mathbf{x}}(t)\|$, evolves as shown in Fig. 24.16. It is important

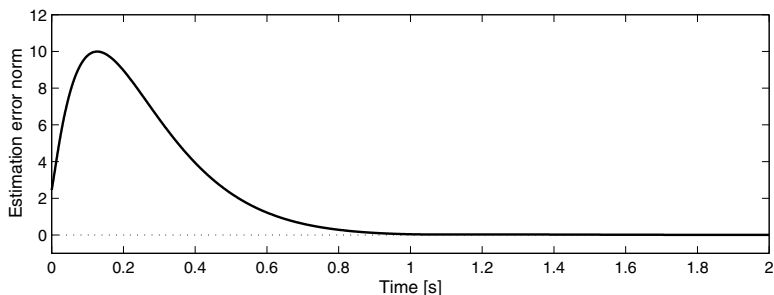

FIGURE 24.16 State estimation error.

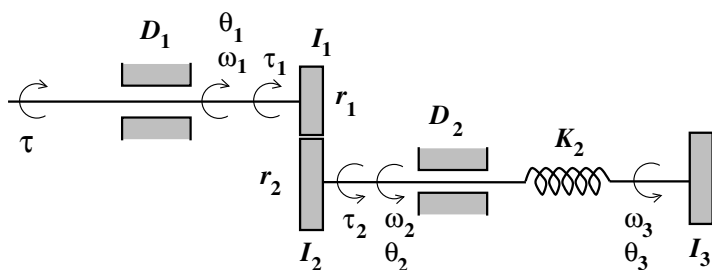

FIGURE 24.17 Rotational system.

to point out that, in this example, the plant is unstable. This means that the state and the state estimation grow unbounded. However, under the assumption of perfect modelling, the estimation error converges to zero.

To gain physical insight into the observer philosophy, we consider the following application.

Example 24.21

Figure 24.17 shows the schematics of a rotational system driven by a torque $\tau(t)$. The system power is transmitted through a gear system built with two wheels with radii r_1 and r_2 and inertias I_1 and I_2 , respectively. The rotation of both shafts is damped by viscous friction with coefficients D_1 and D_2 , and a significant torsional spring in shaft 2 has also been modelled. The system load is modelled as an inertia I_3 . We want to estimate the load speed ω_3 based on the measurement of the speed in shaft 1, ω_1 .

We first need to build a state space model. To do that we choose a minimum set of system variables, which quantify the energy stored in the system. The system has four components able to store energy: three inertias and a spring. Nevertheless, the energy stored in I_1 and I_2 can be computed either from ω_1 or from ω_2 , i.e., we need only one of these speeds, since they satisfy

$$\frac{\omega_1(t)}{\omega_2(t)} = \frac{r_2}{r_1} \quad \text{and} \quad \tau_1(t)\omega_1(t) = \tau_2(t)\omega_2(t) \quad (24.242)$$

Thus, a physically oriented choice of state variables is

$$x_1(t) = \omega_1(t) \quad (24.243)$$

$$x_2(t) = \theta_2(t) - \theta_3(t) \quad (24.244)$$

$$x_3(t) = \omega_3(t) \quad (24.245)$$

From first principles we have

$$\tau(t) = D_1 \omega_1(t) + I_1 \frac{d\omega_1(t)}{dt} + \tau_1(t) \quad (24.246)$$

$$\tau(t) = \frac{r_2}{r_1} \tau_1(t) = D_2 \omega_2(t) + I_2 \frac{d\omega_2(t)}{dt} + K_2(\theta_2(t) - \theta_3(t)) \quad (24.247)$$

$$0 = K_2(\theta_3(t) - \theta_2(t)) + I_3 \frac{d\omega_3(t)}{dt} \quad (24.248)$$

Since we have chosen $\omega_1(t)$ as the measurable system variable, we finally obtain

$$\frac{d\mathbf{x}(t)}{dt} = \underbrace{\begin{bmatrix} \frac{r_1^2 D_2 + r_2^2 D_1}{r_1^2 I_2 + r_2^2 I_1} & -\frac{r_1 r_2 K_2}{r_1^2 I_2 + r_2^2 I_1} & 0 \\ \frac{r_1}{r_2} & 0 & -1 \\ 0 & \frac{K_2}{I_3} & 0 \end{bmatrix}}_{\mathbf{A}} \mathbf{x}(t) + \underbrace{\begin{bmatrix} \frac{r_2}{r_1^2 I_2 + r_2^2 I_1} \\ 0 \\ 0 \end{bmatrix}}_{\mathbf{B}} \tau(t) \quad (24.249)$$

$$\omega_1(t) = \underbrace{[1 \ 0 \ 0]}_{\mathbf{C}} \mathbf{x}(t) \quad (24.250)$$

To evaluate the observability properties of this system, numerical values for the parameters are chosen as follows:

$$r_1 = 0.25 \text{ m}, \quad r_2 = r_3 = 0.50 \text{ m}, \quad D_1 = D_2 = 10 \text{ Nms/rad} \quad (24.251)$$

$$K_2 = 30 \text{ Nm/rad}, \quad I_1 = 2.39 \text{ Nms}^2/\text{rad}, \quad I_2 = I_3 = 38.29 \text{ Nms}^2/\text{rad} \quad (24.252)$$

With these values we have that

$$\mathbf{A} = \begin{bmatrix} -1.045 & -1.254 & 0 \\ 0.5 & 0 & -1 \\ 0 & 0.784 & 0 \end{bmatrix}, \quad \mathbf{B} = \begin{bmatrix} 0.084 \\ 0 \\ 0 \end{bmatrix} \quad (24.253)$$

We next use the test presented in the subsection ‘‘Observability, Reconstructibility, and Detectability.’’ This yields

$$\Gamma_o = \begin{bmatrix} \mathbf{C} \\ \mathbf{CA} \\ \mathbf{CA}^2 \end{bmatrix} = \begin{bmatrix} 1.0000 & 0 & 0 \\ -1.0450 & -1.2540 & 0 \\ 0.4650 & 1.3104 & 1.2540 \end{bmatrix} \quad (24.254)$$

From this expression we see that Γ_o is a full rank matrix. Thus, the system state is completely observable from $\omega_1(t)$.

Once we have a state estimate, $\hat{\mathbf{x}}(t)$, an estimate, $\omega_3(t)$ for ω_3 , is obtained from

$$\omega_3(t) = \underbrace{[0 \quad 0 \quad 1]}_{\mathbf{K}_3^T} \hat{\mathbf{x}}(t) \quad (24.255)$$

where $\omega_3(t)$ can be obtained from (24.239). This yields

$$\frac{d\hat{\omega}_3(t)}{dt} = \mathbf{K}_3^T \frac{d\hat{\mathbf{x}}(t)}{dt} = \mathbf{K}_3^T (\mathbf{A} - \mathbf{J}\mathbf{C}) \hat{\mathbf{x}}(t) + \underbrace{\mathbf{K}_3^T \mathbf{B}}_0 \tau(t) + \mathbf{K}_3^T \mathbf{J} \omega_1(t) \quad (24.256)$$

Observers and Measurement Noise

In the theory above we have assumed that both the system input, $\mathbf{u}(t)$, and the system output, $\mathbf{y}(t)$, are available with no errors. This assumption is usually correct with regard to $\mathbf{u}(t)$, since the same equipment generating $\mathbf{u}(t)$ is normally used to estimate the state. However, that assumption is not usually valid with respect to $\mathbf{y}(t)$, since the measurement of this variable is normally corrupted with noise. To analyze the effect of this error, let us denote by $\mathbf{y}_m(t)$ the noisy measurement, i.e., $\mathbf{y}_m(t) = \mathbf{y}(t) + \mathbf{v}(t)$, where $\mathbf{v}(t)$ is the additive measurement noise. Therefore, the state estimation error satisfies

$$\frac{d\tilde{\mathbf{x}}(t)}{dt} = (\mathbf{A} - \mathbf{J}\mathbf{C})\tilde{\mathbf{x}}(t) + \mathbf{J}\mathbf{v}(t) \quad (24.257)$$

We then have that

$$\tilde{\mathbf{X}}(s) = (s\mathbf{I} - \mathbf{A} + \mathbf{J}\mathbf{C})^{-1} \tilde{\mathbf{x}}(0) + (s\mathbf{I} - \mathbf{A} + \mathbf{J}\mathbf{C})^{-1} \mathbf{J}V(s) \quad (24.258)$$

Hence, the error is small if the transfer function $(s\mathbf{I} - \mathbf{A} + \mathbf{J}\mathbf{C})^{-1} \mathbf{J}$ filters out the noise. Consider the following example.

Example 24.22

A system has a state space model given by

$$\mathbf{A} = \begin{bmatrix} -2 & 1 \\ 1 & -3 \end{bmatrix}, \quad \mathbf{B} = \begin{bmatrix} 1 \\ 0.5 \end{bmatrix}, \quad \mathbf{C} = [1 \quad -1], \quad D = 0 \quad (24.259)$$

Assume that we want to estimate a system variable $z(t) = \gamma^T \mathbf{x}(t)$, where $\gamma^T = [1 \quad 1]$. Then, a suitable observer-based estimate is $\hat{z}(t)$, which is given by

$$\hat{z}(t) = \gamma^T \hat{\mathbf{x}}(t) \quad (24.260)$$

Then, the noise term in the estimation of $z(t)$ is $z_v(t)$, whose Laplace transform satisfies

$$Z_v(s) = H_v(s)V(s), \quad \text{where } H_v(s) = \gamma^T (s\mathbf{I} - \mathbf{A} + \mathbf{J}\mathbf{C})^{-1} \mathbf{J} \quad (24.261)$$

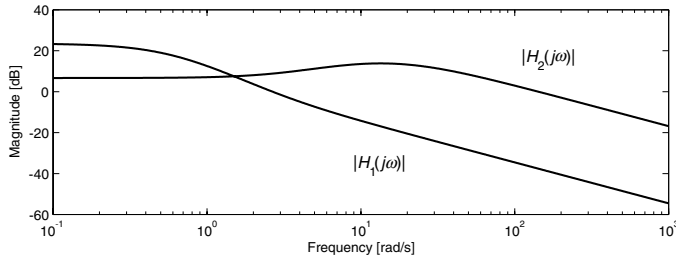

FIGURE 24.18 Observer filtering characteristics.

We next consider two different choices for the observer polynomial $E(s)$. They are

$$E_1(s) = (s + 0.5)(s + 0.75) \quad \text{and} \quad E_2(s) = (s + 10)(s + 20) \quad (24.262)$$

The reader can appreciate that the resulting observers will have very different speeds, the first observer being much slower than the second one.

With those choices we compute the observer gains, J_1 and J_2 , and the corresponding filter functions

$$H_1(s) = \gamma^T (s\mathbf{I} - \mathbf{A} + \mathbf{J}_1\mathbf{C})^{-1} \mathbf{J}_1 = \frac{1.875s + 5.625}{s^2 + 1.25s + 0.375} \quad (24.263)$$

$$H_2(s) = \gamma^T (s\mathbf{I} - \mathbf{A} + \mathbf{J}_2\mathbf{C})^{-1} \mathbf{J}_2 = \frac{144s + 432}{s^2 + 30s + 200} \quad (24.264)$$

To compare both cases we compute and plot the frequency response of each filter. The result is shown in Fig. 24.18.

From Fig. 24.18 we observe that for a high frequency noise, the slowest filter is more immune to noise than the fast filter.

The above case exemplifies the trade-off between observer speed and noise immunity. A systematic way to face this dilemma is to use an optimal filter theory, such as Kalman–Bucy filtering. The interested reader is referred to [2].

24.8 State Feedback

Basic Concepts

When all the system states can be measured, and the system is completely reachable (in the sense explained in subsection “Controllability, Reactability, and Stabilizability”), we can control the system using state feedback to achieve full command of the loop dynamics. This idea is captured in Fig. 24.19.

Figure 24.19 shows the most basic form of state feedback: the plant input has a component that is proportional to the state (the other component is an external signal $\bar{r}(t)$).

State feedback is a very simple, almost naive idea. A careful analysis shows that this idea has some shortcomings and potentially dangerous features, such as

- It requires as many sensors as state variables. This is not only very expensive but also, in some cases, its implementation may become impossible.
- Each state measurement is a source of error because of its limited accuracy.
- Each measurement introduces noise, which has deleterious effect on the control system performance.

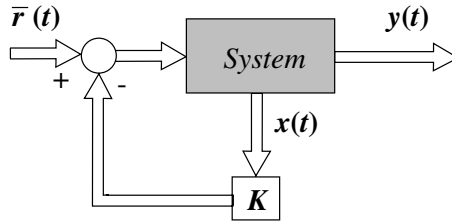

FIGURE 24.19 State feedback.

- The correct overall performance relies on the correct functioning of a complex set of equipments. This poses several questions regarding performance degradation and system integrity.

In spite of these weak points, state feedback is by itself a powerful concept, since it works as a basis for more sophisticated and robust control schemes. The key reason for this is that any linear controller can be explained as the combination of a state observer and state feedback.

Feedback Dynamics

Assume that the system to be controlled has a transfer function $H(s)$ and a state space representation given by (24.42) and (24.43), with $\mathbf{D} = \mathbf{0}$. If the plant input is generated according to

$$\mathbf{u}(t) = -\mathbf{K}\mathbf{x}(t) + \bar{\mathbf{r}}(t) \quad (24.265)$$

then the state space representation for the complete control loop is given by

$$\frac{d\mathbf{x}(t)}{dt} = \mathbf{A}\mathbf{x}(t) + \mathbf{B}(-\mathbf{K}\mathbf{x}(t) + \bar{\mathbf{r}}(t)) \quad (24.266)$$

$$\mathbf{y}(t) = \mathbf{C}\mathbf{x}(t) \quad (24.267)$$

It can be shown that the relationship between $\bar{\mathbf{R}}(s)$ and $\mathbf{Y}(s)$ is given by

$$\mathbf{Y}(s) = \underbrace{\mathbf{C}(s\mathbf{I} - \mathbf{A})^{-1}\mathbf{B}}_{\mathbf{H}(s)} (\mathbf{I} + \mathbf{K}(s\mathbf{I} - \mathbf{A})^{-1}\mathbf{B})^{-1}\bar{\mathbf{R}}(s) \quad (24.268)$$

This shows that the state feedback loop preserves the system zeros and shifts the poles to the roots of $\det(s\mathbf{I} - \mathbf{A} + \mathbf{BK})$.

Optimal State Feedback. The Optimal Regulator

Consider a linear time invariant system having a state space representation given by (24.42) and (24.43), with $\mathbf{D} = \mathbf{0}$, subject to the initial state $\mathbf{x}(0) = \mathbf{x}_0$.

Assume that the control objective is to steer the plant from the the initial state, \mathbf{x}_0 , to the smallest possible value as soon as possible in the interval $[0, t_f]$. We additionally require that the steering process does not demand too much control effort. Then, the optimal regulator problem is defined as the problem of finding an optimal control $\mathbf{u}(t)$ over the interval $[0, t_f]$ such that a quadratic cost function is minimized. This cost function is chosen as

$$J_u(\mathbf{x}_0) = \int_0^{t_f} [\mathbf{x}(t)^T \mathbf{Q}\mathbf{x}(t) + \mathbf{u}(t)^T \mathbf{R}\mathbf{u}(t)] dt + \mathbf{x}(t_f)^T \mathbf{Q}_f \mathbf{x}(t_f) \quad (24.269)$$

where $\mathbf{Q} \in \mathbb{R}^{n \times n}$, $\mathbf{Q}_f \in \mathbb{R}^{n \times n}$ are symmetric nonnegative definite matrices and $\mathbf{R} \in \mathbb{R}^{m \times m}$ is a symmetric positive definite matrix. The requirements on the weighting matrices are set so that the cost function makes sense. For instance, if \mathbf{Q} is allowed to be negative, then the *optimal* cost could even be negative while the state could grow unbounded in magnitude. Also, if we allow \mathbf{R} to have eigenvalues at the origin (i.e., \mathbf{R} is allowed to be a nonnegative definite matrix, instead of requiring it to be a strictly positive definite matrix) then the control $\mathbf{u}(t)$ could also grow unbounded (in the directions of the associated eigenvectors) without that situation being revealed by the cost function.

A time invariant linear control law is asymptotically obtained when $t_f \rightarrow \infty$. Under this condition, the optimal control law is given by

$$\mathbf{u}^o(t) = -\mathbf{K}^o \mathbf{x}(t) \quad (24.270)$$

with

$$\mathbf{K}^o = -\mathbf{R}^{-1} \mathbf{B}^T \mathbf{P}_\infty \quad (24.271)$$

and where \mathbf{P}_∞ is the only nonnegative solution of the algebraic Riccati equation

$$\mathbf{0} = \mathbf{Q} - \mathbf{P}_\infty \mathbf{B} \mathbf{R}^{-1} \mathbf{B}^T \mathbf{P}_\infty + \mathbf{P}_\infty \mathbf{A} + \mathbf{A}^T \mathbf{P}_\infty \quad (24.272)$$

For this solution to exist, it is necessary that certain technical conditions are satisfied (for a detailed discussion of these issues see, for instance, [5]).

Discussion

- The solution for the LQR problem minimizes the cost function (24.269) and, when $t_f \rightarrow \infty$, always stabilizes the plant.
- A key issue is how to choose the weighting matrices \mathbf{Q} and \mathbf{R} . A frequent choice for \mathbf{Q} is $\mathbf{Q} = \mathbf{C}^T \mathbf{C}$. With this choice, the magnitude of the plant output is directly introduced into the cost function.
- For a given \mathbf{Q} , the *size* of \mathbf{R} strongly influences the location of the closed loop poles. The larger \mathbf{R} is, the slower is the control loop.

Further reading on optimal quadratic regulators can be found in the literature. See, e.g., [1,3,4,8,9].

24.9 Observed State Feedback

Separation Strategy

Due to the drawbacks inherent in the measuring of the state, feedback of the estimated state can be used instead. The resulting control system integrates an observer and a feedback mechanism for the observed states.

The combination of a state observer and the feedback of the estimated state conform the structure shown in Fig. 24.20.

In Fig. 24.20, the (matrix) transfer functions $\mathbf{T}_1(s)$ and $\mathbf{T}_2(s)$ can be obtained from Fig. 24.15. This yields

$$\mathbf{T}_1(s) = (s\mathbf{I} - \mathbf{A}_o + \mathbf{J}\mathbf{C}_o)^{-1} \mathbf{B}_o \quad (24.173)$$

$$\mathbf{T}_2(s) = (s\mathbf{I} - \mathbf{A}_o + \mathbf{J}\mathbf{C}_o)^{-1} \mathbf{J} \quad (24.174)$$

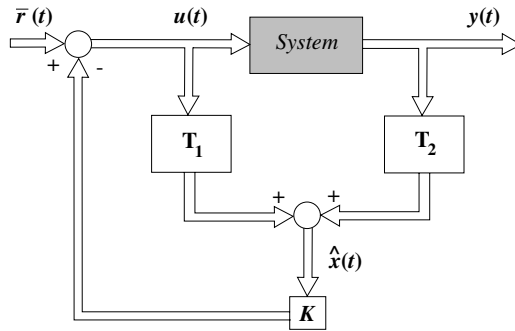

FIGURE 24.20 Estimated state feedback.

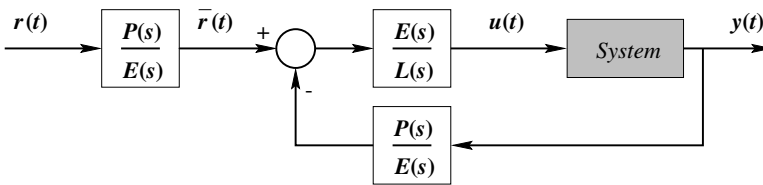

FIGURE 24.21 Equivalent control loop.

Transfer Function Interpretation for the Single-Input Single-Output Case

Consider a SISO plant having transfer function

$$G_o(s) = \mathbf{C}(s\mathbf{I} - \mathbf{A}_o)^{-1}\mathbf{B} = \frac{N_o(s)}{M_o(s)} \quad (24.275)$$

where $M_o(s)$ and $N_o(s)$ are polynomials in s .

First, a state feedback gain, \mathbf{K} , is chosen to obtain a closed loop polynomial $F(s)$, where $F(s) = \det(s\mathbf{I} - \mathbf{A}_o + \mathbf{B}_o\mathbf{K})$. Next, an observer gain, \mathbf{J} , is computed to obtain an observer polynomial $E(s) = \det(s\mathbf{I} - \mathbf{A}_o + \mathbf{J}\mathbf{C}_o)$.

If the observer and the observed state feedback are combined, the resulting control loop can be made equivalent (by a suitable choice of $\bar{r}(t)$) to the classical control loop shown in Fig. 24.21.

In Fig. 24.21 the polynomials $P(s)$ and $L(s)$ satisfy the Diophantine equation

$$M_o(s)L(s) + N_o(s)P(s) = E(s)F(s) \quad (24.276)$$

This result says that the set of closed loop poles is the union of the set of observer poles and the set of state feedback poles.

References

1. Anderson, B.D.O. and Moore, J., *Linear optimal Control*. Prentice-Hall, Englewood Cliffs, NJ, 1971.
2. Anderson, B.D.O. and Moore, J., *Optimal Filtering*. Prentice-Hall, Englewood Cliffs, NJ, 1979.
3. Athans, M. and Falb, P., *Optimal Control*. McGraw Hill, 1966.
4. Dennis Bernstein and Wassim Haddad. LQG control with an H_∞ performance bound: A Riccati equation approach. *IEEE Transactions on Automatic Control*, 34(3): L293–305, 1989.
5. Bittanti, S., Laub, A.J., and Willems, J.C., *The Riccati Equation*. Springer Verlag, Berlin, 1996.
6. Dorf, R.C. and Bishop, R., *Modern Control Systems*. Prentice-Hall, Englewood Cliffs, NJ, 1997.

7. Franklin, G.F. and Powell, J.D., *Digital Control of Dynamics Systems*. 2nd ed., Addison-Wesley, 1990.
8. Goodwin, G.C., Graebe, S., and Salgado, M.E., *Control System Design*. Prentice-Hall, NJ, 2001.
9. Kwakernaak, H. and Sivan, R., *Linear Optimal Control System*. Wiley-Interscience, New York, 1972.
10. Ogata, K., *State Space Analysis of Control Systems*. Prentice-Hall, Englewood Cliffs, NJ, 1967.
11. Rosenbrock, H.H., *State Space and Multivariable Theory*. John Wiley and Sons, New York, 1970.
12. Schultz, D.G. and Melsa, J.L., *State Function and Linear Control Systems*. McGraw Hill, New York, 1967.
13. Wiberg, D.W., *Theory and Problems of State Space and Linear Systems*. McGraw Hill, New York, 1971.
14. Zadeh, L.A. and Desoer, C.A., *Linear System Theory: The State Space Approach*. McGraw Hill, New York, 1963.
15. Zhou, K., *Essentials of Robust Control*. Prentice-Hall, Englewood Cliffs, NJ, 1998.
16. Zhou, K., Salomon, G., and Wu, E., Balanced realization and model reduction for unstable systems. *International Journal of Robust and Nonlinear Control*, 9:183–198, 1999.

25

Response of Dynamic Systems

- 25.1 System and Signal Analysis
 - Continuous Time Systems • Discrete Time Systems
 - Laplace and z-Transform • Transfer Function Models
- 25.2 Dynamic Response
 - Pulse and Step Response • Sinusoid and Frequency Response
- 25.3 Performance Indicators for Dynamic Systems
 - Step Response Parameters • Frequency Domain Parameters

Raymond de Callafon
University of California

25.1 System and Signal Analysis

In dynamic system design and analysis it is important to predict and understand the dynamic behavior of the system. Examining the dynamic behavior can be done by using a mathematical model that describes the relevant dynamic behavior of the system in which we are interested. Typically, a model is formulated to describe either continuous or discrete time behavior of a system. The corresponding equations that govern the model are used to predict and understand the dynamic behavior of the system.

A rigorous analysis can be done for relatively simple models of a dynamic system by actually computing solutions to the equations of the model. Usually, this analysis is limited to linear first and second order models. Although limited to small order models, the solutions tend to give insight in the typical responses of a dynamic system. For more complicated, higher order and possibly nonlinear models, numerical simulation tools provide an alternative for the dynamic system analysis.

In the following we review the analysis of linear models of discrete and continuous time dynamic systems. The equations that describe and relate continuous and discrete time behavior are presented. For the analysis of continuous time systems extensive use is made of the Laplace transform that converts linear differential equations into algebraic expressions. For similar purposes, a z-transform is used for discrete time systems.

Continuous Time Systems

Models that describe the linear continuous time dynamical behavior of a system are usually given in the form of differential equations that relate an input signal $u(t)$ to an output signal $y(t)$. The differential equation of a time invariant linear continuous time model has the general format

$$\sum_{j=0}^{n_a} a_j \frac{d^j}{dt^j} y(t) = \sum_{j=0}^{n_b} b_j \frac{d^j}{dt^j} u(t) \quad (25.1)$$

in which a linear combination is taken using the j th order time derivatives d^j/dt^j of a single output $y(t)$ and a single input $u(t)$. In (25.1), the scalar real valued numbers a_j for $j = 0, \dots, n_a$, $a_{n_a} \neq 0$ and b_j for $j = 0, \dots, n_b$, $b_{n_b} \neq 0$, respectively, are called the denominator and numerator coefficients. The input $u(t)$ is distinguished from the output $y(t)$ in (25.1) by requiring $n_a \geq n_b$. As a result, the n_a th derivative is the highest derivative of the output $y(t)$ and n_a is used to indicate the order of the differential equation.

An alternative representation of a model of a continuous time system can be obtained by rewriting the n_a th order differential equation in (25.1) into a set of (coupled) first order differential equations. This can be done by introducing a state variable $x(t)$ and rewriting the higher order differential equation into

$$\begin{aligned} \frac{d}{dt}x(t) &= Ax(t) + Bu(t) \\ y(t) &= Cx(t) + Du(t) \end{aligned} \quad (25.2)$$

where A, B, C , and D are real valued matrices. The set of first order differential equations given in (25.2) is referred to as a state space representation. The state variable $x(t)$ is a column vector and contains n_a variables, where n_a is the order of the differential equation.

The size of the matrices in (25.2) corresponds to the order of differential equation from which the state space realization is derived. For generalization purposes, consider multiple inputs and outputs rearranged in $m \times 1$ input column vector $u(t)$ and a $p \times 1$ output column vector $y(t)$. Given the $n_a \times 1$ size of the state vector, the state matrix A has size $n_a \times n_a$, the input matrix has size $n_a \times m$, the output matrix C has size $p \times n_a$, and the feedthrough matrix D has size $m \times p$. From these size considerations it can be observed that the state space realization in (25.2) easily generalizes the model description of multi-input multi-output systems.

To illustrate the concepts, consider the differential equation

$$m \frac{d^2}{dt^2}y(t) + c \frac{d}{dt}y(t) + ky(t) = u(t) \quad (25.3)$$

that describes the dynamical behavior of the one cart system given in Fig. 25.1. The differential equation (25.3) is found by writing Newton's second law for the cart mass m with position output $y(t)$, spring force $ky(t)$, damper force $c(d/dt)y(t)$, and force input $u(t)$. Comparing with (25.1) it can be seen that $n_a = 2 \geq n_b = 0$, making (25.3) a second order differential equation. The differential equation can be rewritten into a state space representation (25.2) by defining the state variable

$$x(t) := \begin{bmatrix} y(t) \\ \frac{d}{dt}y(t) \end{bmatrix}$$

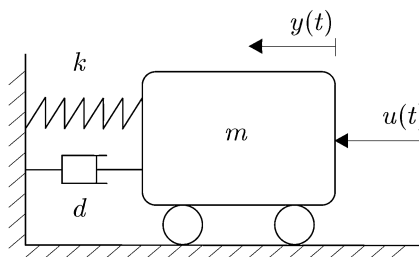

FIGURE 25.1 One cart system representing a single mass dynamical system with cart mass m , spring constant k , and damping constant c .

that consists the position and velocity of the mass. With this state variable (25.3) can be rewritten into

$$\begin{aligned}\frac{d}{dt}x(t) &= \begin{bmatrix} 0 & 1 \\ -\frac{k}{m} & -\frac{d}{m} \end{bmatrix} x(t) + \begin{bmatrix} 0 \\ \frac{1}{m} \end{bmatrix} u(t) \\ y(t) &= \begin{bmatrix} 1 & 0 \end{bmatrix} x(t) + 0u(t)\end{aligned}$$

which yields a state space model similar to (25.2). In this case, the size of the state matrix A is 2×2 , the input matrix B is 2×1 , the output matrix C is 1×2 , and the feedthrough matrix $D = 0$ is scalar.

Discrete Time Systems

Discrete time models approximate and describe the sampled data behavior of a continuous time dynamical system. In some applications, such as digital control, the dynamical control system is inherently discrete time. In these situations, analysis with discrete time equivalent models is necessary.

For analysis purposes, both input $u(t)$ and output $y(t)$ are assumed to be sampled on a regular discrete time interval

$$t = k\Delta T, \quad k = 0, 1, 2, \dots$$

where ΔT indicates the sampling time. To maintain uniform notation throughout the analysis, the sampling time ΔT is normalized to $\Delta T = 1$ and the time dependency t is assumed to be discrete with $t = k = 0, 1, 2, \dots$

Given sampled or discrete time input/output data, a linear discrete time model can be formulated in the form of a difference equation

$$\sum_{j=0}^{n_c} c_j y(k+j) = \sum_{j=0}^{n_d} d_j u(k+j) \quad (25.4)$$

in which a linear combination is taken of positive time shifted inputs $u(k)$ and outputs $y(k)$. To distinguish the differential equation from the difference equation (25.1), different scalar real valued numbers c_j for $j = 0, \dots, n_c$, $c_{n_c} \neq 0$ and d_j for $j = 0, \dots, n_d$, $d_{n_d} \neq 0$ are used. The input $u(k)$ is distinguished from the output $y(k)$ in (25.1) by requiring $n_c \geq n_d$ for causality purposes. As a result, the n_c is the largest time shift of the output $y(k)$ and n_c is used to indicate the order of the difference equation.

The simplicity with which the difference equation can be represented also allows an algebraic representation of (25.4). Introducing the time shift operator

$$qu(k) := u(k+1) \quad (25.5)$$

allows (25.4) to be rewritten into the algebraic expression

$$y(k) \sum_{j=0}^{n_c} c_j q^j = u(k) \sum_{j=0}^{n_d} d_j q^j$$

Following this analysis, the discrete time output $y(k)$ can be represented by the difference model

$$y(k) = G(q)u(k), \quad \text{with } G(q) = \frac{\sum_{j=0}^{n_d} d_j q^j}{\sum_{j=0}^{n_c} c_j q^j} \quad (25.6)$$

where the scalar real valued numbers c_j for $j = 0, \dots, n_c$, $c_{n_c} \neq 0$ and d_j for $j = 0, \dots, n_d$, $d_{n_d} \neq 0$, respectively, indicate the denominator and numerator coefficients.

Similar to the continuous time system representation, the higher order difference equation (25.4) can also be rewritten into a set of (coupled) first order difference equations for analysis purposes. This can be done by introducing a state variable $x(k)$ and rewriting the higher order difference equation into

$$\begin{aligned} qx(k) &= Fx(k) + Gu(k) \\ y(k) &= Hx(k) + Ju(k) \end{aligned} \tag{25.7}$$

where $qx(k) = x(k + 1)$, according to (25.5). The state variable $x(k)$ is a column vector and contains n_c variables, where n_c is the order of the difference equation. The state space matrices in (25.7) are labeled differently to distinguish them from the continuous time state space model.

Laplace and z-Transform

An important mathematical concept for the analysis of models described by linear differential equations such as (25.1) and (25.2) is the Laplace transform. As indicated before, the Laplace transform converts linear differential equations into algebraic expressions. With this conversion, proper algebraic manipulation can be used to recover solutions of the differential equation. In a similar manner, the z-transform is used for discrete time models described by difference equations. Although it was shown in (25.6) that a difference equation can be written as an algebraic expression, the z-transform allows complex analysis of the discrete time models.

The Laplace transform of a signal $u(t)$ is defined to be

$$L\{u(t)\} := u(s) = \int_{t=0}^{\infty} u(t)e^{-st} dt \tag{25.8}$$

where the integration over t eliminates the time dependency and the transform $u(s)$ is a function of the Laplace variable only. This is indicated in the transform $u(s)$ where the dependency of t has been dropped, and $u(s)$ is a function of the (complex valued) Laplace variable s only.

The integral (25.8) exists for most commonly used signals $u(t)$, provided certain conditions on s are imposed. To illustrate the transform, consider a (unity) step signal

$$u(t) := \begin{cases} 0, & t < 0 \\ 1, & t \geq 0 \end{cases}$$

where the shape of $u(t)$ resembles a stepwise change of an input signal. With the definition of the Laplace transform in (25.8) the transform of the step signal becomes

$$u(s) = \int_{t=0}^{\infty} u(t)e^{-st} dt = \int_{t=0}^{\infty} e^{-st} dt = -\frac{e^{-st}}{s} \Big|_0^{\infty} = \frac{1}{s} \tag{25.9}$$

where it is assumed that the real part of s is greater than zero so that $\lim_{t \rightarrow \infty} e^{-st} = 0$.

If a signal $u(k)$ is given at discrete time samples $k = 0, 1, 2, \dots$, the integral expression of (25.8) cannot be applied. Instead, a transform similar to the Laplace transform can be used and denoted by the z-transform. The z-transform of a discrete time signal $u(k)$ is defined as

$$L\{u(k)\} := u(z) = \sum_{k=0}^{\infty} u(k)z^{-k} \tag{25.10}$$

The series (25.10) converges if it is assumed that there exist values r_l and r_u with $r_l < |z| < r_u$ as bounds on the magnitude of the complex variable z .

The z -transform has the same role in discrete time systems that the Laplace transform has in continuous time systems. In case of sampling, the complex variable z of the z -transform is related to the complex variables s in the Laplace transform via

$$z = e^{s\Delta T} \quad (25.11)$$

where ΔT is the sampling time used for sampling. Both the Laplace and z -transform are linear operators and satisfy

$$L\{\alpha u(t) + \beta y(t)\} = \alpha L\{u(t)\} + \beta\{y(t)\} \quad (25.12)$$

Using the definition in (25.8) and the linearity property in (25.12), the transform of most commonly used functions has been precalculated and tabulated.

Of particular interest for the analysis of linear differential equations such as (25.1) and (25.2) is the Laplace transform of a derivative:

$$\begin{aligned} L\left\{\frac{d}{dt}u(t)\right\} &= \int_{t=0}^{\infty} \frac{d}{dt}u(t)e^{-st} dt \\ &= u(t)e^{-st}\Big|_0^{\infty} + s \int_{t=0}^{\infty} u(t)e^{-st} dt \\ &= su(s) - u(0) \end{aligned}$$

With $u(0) = 0$ it can be seen that the Laplace transform of the derivative of $u(t)$ is simply s times the Laplace transform of $u(s)$. This result can be extended to higher order derivatives and the result for the n th derivative is given by

$$L\left\{\frac{d^n}{dt^n}u(t)\right\} = s^n u(s) - \sum_{j=1}^n s^{n-j} \frac{d^{j-1}}{dt^{j-1}}u(t)\Big|_{t=0}$$

In case the signal $u(t)$ satisfies the initial zero conditions

$$\frac{d^{j-1}}{dt^{j-1}}u(t)\Big|_{t=0} = 0 \quad \text{for } j = 1, \dots, n$$

the formula reduces to

$$L\left\{\frac{d^n}{dt^n}u(t)\right\} = s^n u(s)$$

and the Laplace transform of an n th order derivative is simply s^n times the transform $u(s)$.

For discrete time systems the interest lies in the z -transform of a time-shifted signal. Similar to the Laplace transform, the z -transform of an n time-shifted signal can be computed and is given by

$$L\{q^n u(k)\} = z^n u(z) - \sum_{j=0}^{n-1} z^{n-j} u(j)$$

In case the discrete time signal $u(k)$ satisfies the initial zero conditions $u(j) = 0$ for $j = 0, \dots, n - 1$, the formula reduces to

$$L\{q^n u(k)\} = z^n u(z)$$

and the z -transform of an n time-shifted discrete time signal is simply z^n times the transform $u(z)$.

Transfer Function Models

The results of the Laplace and z -transform can be used to reduce linear differential equations (25.1) and difference equation (25.4) to the algebraic expressions. Starting with the differential equations for continuous time models and assuming zero initial conditions for both the input $u(t)$ and output signal $y(t)$, the Laplace transform of (25.1) yields

$$y(s) \sum_{j=0}^{n_a} a_j s^j = u(s) \sum_{j=0}^{n_b} b_j s^j$$

which can be written in transfer function format

$$y(s) = G(s)u(s), \quad \text{with } G(s) = \frac{\sum_{j=0}^{n_b} b_j s^j}{\sum_{j=0}^{n_a} a_j s^j} \quad (25.13)$$

In (25.13), the transfer function $G(s)$ is the ratio of the numerator polynomial $\sum_{j=0}^{n_b} b_j s^j$ and the denominator polynomial $\sum_{j=0}^{n_a} a_j s^j$. As indicated before, the scalar real valued numbers a_j for $j = 0, \dots, n_a$, $a_{n_a} \neq 0$ and b_j for $j = 0, \dots, n_b$, $b_{n_b} \neq 0$, respectively, are called the denominator and numerator coefficients.

Similarly for the discrete time model, assuming zero initial conditions for both the input $u(k)$ and output signal $y(k)$, the z -transform of (25.4) yields

$$y(z) \sum_{j=0}^{n_c} c_j z^j = u(z) \sum_{j=0}^{n_d} b_j z^j$$

which can be written in transfer function format

$$y(z) = G(z)u(z), \quad \text{with } G(z) = \frac{\sum_{j=0}^{n_c} c_j z^j}{\sum_{j=0}^{n_d} b_j z^j} \quad (25.14)$$

From the transfer function representations, poles and zeros of the dynamic system can be computed for dynamic system analysis. The poles of the system are defined as the roots of the denominator polynomial. The zeros of the system are defined as the roots of the numerator polynomial.

The Laplace and z -transform can also be used to reduce the state space representation to a set of algebraic expressions that consists of (coupled) first order polynomials. Assuming zero initial conditions for the state vector $x(t)$, application of the Laplace transform to (25.2) yields

$$\begin{aligned} sX(s) &= AX(s) + BU(s) \\ Y(s) &= CX(s) + DU(s) \end{aligned}$$

in which the state vector $x(s)$ can be eliminated. Solving for $x(s)$ gives $x(s) = (sI - A)^{-1} BU(s)$ and the above transform can be rewritten into a transfer function representation

$$y(s) = G(s)u(s), \quad \text{with } G(s) = D + C(sI - A)^{-1}B \quad (25.15)$$

Under mild technical conditions involving controllability and observability of the state space model, the transfer function representations in (25.13) and (25.15) are similar in case the state space model in (25.2) is derived from the differential equation (25.1) and vice versa.

25.2 Dynamic Response

The Laplace and z-transform offer the possibility to compute the dynamic response of a dynamic system by means of algebraic manipulations. The analysis of the dynamic response gives insight into the dynamic behavior of the system by addressing the response to typical test signals such as impulse, step, and sinusoid excitation of the system.

The response can be computed for relatively simple continuous or discrete dynamical systems given by low order differential or difference equations. Both the state space model and the transfer function descriptions provide helpful representations in the analysis of a dynamic system. The result are presented in the following.

Pulse and Step Response

A possible way to evaluate the response of a dynamic system is by means of pulse and step based test signals. For continuous time systems an input impulse signal is defined as a δ function

$$u_{\text{imp}}(t) := \delta(t) = \begin{cases} \infty, & t = 0 \\ 0, & t \neq 0 \end{cases}$$

with the property

$$\int_{t=-\infty}^{\infty} f(t)\delta(t) dt = f(0)$$

where $f(t)$ is an integrable function over $(-\infty, \infty)$. Although an impulse signal is not practical from an experiment point of view, the computation or simulation of the impulse response gives insight into the transient behavior of the dynamical system.

With the properties of the impulse function $\delta(t)$ mentioned above, the Laplace transform of the impulse function is given by

$$L\{\delta(t)\} = \delta(s) = \int_{t=0}^{\infty} \delta(t)e^{-st} dt = e^{-s0} = 1$$

Hence the output $y(s)$ due to an impulse input is given by $y_{\text{imp}}(s) = G(s)u_{\text{imp}}(s) = G(s)\delta(s) = G(s)$. As a result, an immediate inverse Laplace transform of the continuous time transfer function $G(s)$,

$$y_{\text{imp}}(t) = L^{-1}\{G(s)\}$$

gives the dynamic response $y_{\text{imp}}(t)$ of the system to an impulse input response.

The computation of the step response is done in a similar way. In (25.9), the Laplace transform of the step signal

$$u_{\text{step}}(t) := \begin{cases} 0, & t < 0 \\ 1, & t \geq 0 \end{cases}$$

is given as $u_{\text{step}}(s) = 1/s$. Consequently, with $y_{\text{step}}(s) = G(s)u_{\text{step}}(s) = G(s)/s$, the inverse Laplace transform of $G(s)/s$

$$y_{\text{step}}(t) = L^{-1} \left\{ \frac{G(s)}{s} \right\}$$

will yield the dynamic response $y_{\text{step}}(t)$ of the system to a step input response.

From a practical point of view, the computation of an inverse Laplace transform is limited to low order models of first or second order. However, the results give insight into the dominant behavior of most dynamic systems. This is illustrated in the following examples.

- Consider a first order continuous model given by the transfer function

$$G(s) = \frac{K}{\tau s + 1}$$

where K and τ indicate, respectively, the static gain and the time constant of the system. Such a transfer function may arise from a simple RC network with $\tau = RC$. In order to compute the step response of the system, the inverse Laplace transform of $G(s)/s$ needs to be computed. This inverse Laplace transform is given by

$$y_{\text{step}}(t) = L^{-1} \left\{ \frac{G(s)}{s} \right\} = \frac{K}{\tau} (1 - e^{-t/\tau})$$

and it can be seen that the step response is an exponential function. For stability the time constant τ needs to satisfy $\tau > 0$. It can also be observed that the smaller the time constant, the faster the response.

- Consider a second order continuous time model given by the transfer function

$$G(s) = \frac{\omega_n^2}{s^2 + 2\beta\omega_n s + \omega_n^2} \quad (25.16)$$

where ω_n and β , respectively, indicate the undamped resonance frequency and the damping coefficient of the system. This model can be derived from the dynamical behavior of the one cart system depicted in Fig. 25.1 and given in (25.3). For $\beta < 1$ (underdamped), the inverse Laplace transform of $G(s)$ is given by

$$y_{\text{imp}}(t) = \frac{\omega_m}{\sqrt{1 - \beta^2}} e^{-\beta\omega_n t} \sin(\omega_n \sqrt{1 - \beta^2} t)$$

From this expression it can be observed that the response is a decaying sinusoid with a resonance frequency of $\omega_n \sqrt{1 - \beta^2}$. For stability, both $\omega_n > 0$ and $\beta > 0$ and the larger ω_n , the faster the decay of the sinusoid and the higher is the frequency of the response $y_{\text{imp}}(t)$. Illustration of the impulse response of this second order system have been depicted in Figs. 25.2 and 25.3 where variations in the undamped resonance frequency ω_n and the damping coefficient β illustrate the dynamic behavior of the system.

For discrete systems, the analysis of the pulse response is based on the discrete time pulse function

$$u_{\text{imp}}(k) := \delta(k) = \begin{cases} 1, & k = 0 \\ 0, & k \neq 0 \end{cases}$$

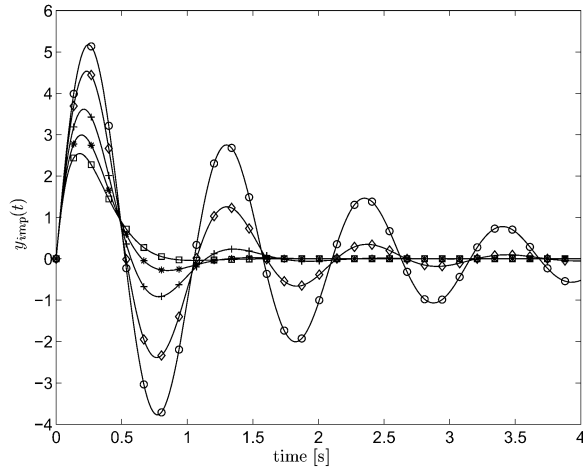

FIGURE 25.2 Variations in impulse response $y_{\text{imp}}(t)$ of second order system with $\omega_n = 6$ and $\beta = 0.1(\circ), 0.2(\diamond), 0.4(+), 0.6(*), 0.8(\square)$.

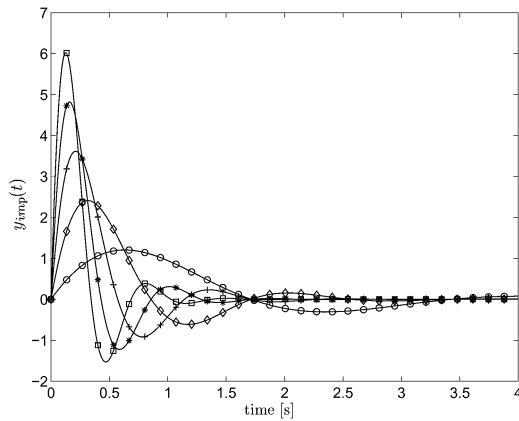

FIGURE 25.3 Variations in impulse response $y_{\text{imp}}(t)$ of second order system with $\beta = 0.4$ and $\omega_n = 2(\circ), 4(\diamond), 6(+), 8(*), 10(\square)$.

which has a value of 1 at $k = 0$ and zero anywhere else. The step signal is similar to the continuous time signal and is given by

$$u_{\text{step}}(k) := \begin{cases} 0, & k < 0 \\ 1, & k \geq 0 \end{cases}$$

In order to characterize the discrete time pulse and step response a similar procedure as for the continuous time model can be followed by using the z -transform. It is easy to show that the z -transform $u_{\text{imp}}(z) = 1$ and the z -transform of the step signal equals $u_{\text{step}}(z) = z/(z - 1)$. Hence, the response of the discrete time system to a pulse or step signal can be computed with

$$y_{\text{imp}}(k) = L^{-1}\{G(z)\}, \quad y_{\text{step}}(k) = L^{-1}\left\{\frac{G(z)z}{z-1}\right\}$$

In addition to the approach using a z -transform, the ratio of the polynomials in the difference model (25.6) can be written in a series expansion:

$$G(q) = \frac{\sum_{j=0}^{n_d} d_j q^j}{\sum_{j=0}^{n_c} c_j q^j} = \sum_{j=0}^{\infty} g_k q^{-k}$$

With the discrete time pulse function $u_{\text{imp}}(k)$ as an input, it can be observed that

$$y_{\text{imp}}(k) = \sum_{j=0}^{\infty} g_k q^{-k} \delta(k) = g_k$$

and it can be concluded that the pulse response $y_{\text{imp}}(k)$ equals the coefficients in the series expansion of the difference equation. Similarly, with the discrete time step function $u_{\text{step}}(k)$ as an input, it can be observed that

$$y_{\text{imp}}(k) = \sum_{j=0}^{\infty} g_k q^{-k} u_{\text{step}}(k) = \sum_{j=0}^k g_k$$

and it can be concluded that the step response $y_{\text{step}}(k)$ values are computed as a finite sum of the coefficients in the series expansion of the difference equation. The computation of a discrete time pulse response for a first order discrete time model is given in the following example.

- Consider a first order discrete model given by the difference model

$$G(q) = \frac{1}{q + d}$$

where d indicates the discrete time constant of the system. The series expansion of the difference model can be computed as follows:

$$G(q) = \frac{1}{q - d} = \sum_{j=0}^{\infty} d^j$$

and it can be seen that the discrete time pulse response

$$y_{\text{imp}}(k) = d^k$$

is an exponential function. For stability the discrete constant d needs to satisfy $|d| < 1$. Similar as in the continuous time model it can be observed that the smaller the time constant, the faster the response. Additionally, the first order discrete time model may exhibit an oscillation in case $-1 < d < 0$.

Sinusoid and Frequency Response

So far we have considered transient effects caused by step, pulse, and impulse inputs to investigate the dynamic properties of a dynamical system. However, periodic inputs occur frequently in practical situations and the analysis of a dynamic system to periodic inputs and especially sinusoidal inputs can yield more insight into the behavior of the system.

The response of a linear system to a sinusoidal input is referred to as the frequency response of the system. An input signal, $u(t) = U \sin \omega t$, that is, a sine wave with amplitude U and frequency ω , has a Laplace transform

$$u(s) = \frac{U\omega}{s^2 + \omega^2}.$$

Consequently, the response of the system is given by

$$y(s) = G(s) \frac{U\omega}{s^2 + \omega^2}$$

and a partial fraction expansion of $y(s)$ will result in terms that represent the (stable) transient behavior of $y(s)$ and the term associated to the sinusoidal input $u(s)$. Elimination of the transient effects and performing an inverse Laplace transform will yield a periodic time response $y(t)$ of the same frequency ω , given by

$$y(t) = AU \sin(\omega t + \phi)$$

where the amplitude magnification A and the phase shift ϕ are given by

$$A = G(s)|_{s=i\omega}, \quad \phi = \angle G(s)|_{s=i\omega} \quad (25.17)$$

By evaluating the transfer function $G(s)$ along the imaginary axis $s = i\omega$, $\omega \geq 0$, the magnitude $|G(i\omega)|$ gives information on the relative amplification of the sinusoidal input, whereas the phase $\angle G(i\omega)$ gives information on the relative phase shift between input and output.

This analysis can be easily extended to discrete time systems by employing the relation between the Laplace variable s and the z -transform variable in (25.11) to obtain the discrete time sinusoidal response

$$y(k) = AU \sin(\omega k + \phi)$$

where the amplitude magnification A and the phase shift ϕ are given by

$$A = G(z)|_{z=e^{i\Delta T\omega}}, \quad \phi = \angle G(z)|_{z=e^{i\Delta T\omega}} \quad (25.18)$$

Due to the sampling nature of the discrete time system, the transfer function $G(z)$ is now evaluated on the unit circle

$$e^{i\Delta T\omega}, \quad 0 \leq \omega < \frac{\pi}{\Delta T}$$

to attain information of the magnitude and phase shift of the sinusoidal response.

Plotting the frequency response of a dynamical system gives insight in the pole locations (resonance modes) and zero locations of the dynamical system. As an example, the frequency response of the second order system given in (25.16) has been depicted in Fig. 25.4. It can be seen from the figure that, as expected, the second order system is less damped for smaller damping coefficients β and this results in a larger amplitude response of the second order system at the resonance frequency $\omega_n = 6$ rad/s. It can also be observed that the phase change at the resonance frequency becomes more abrupt for smaller damping coefficients.

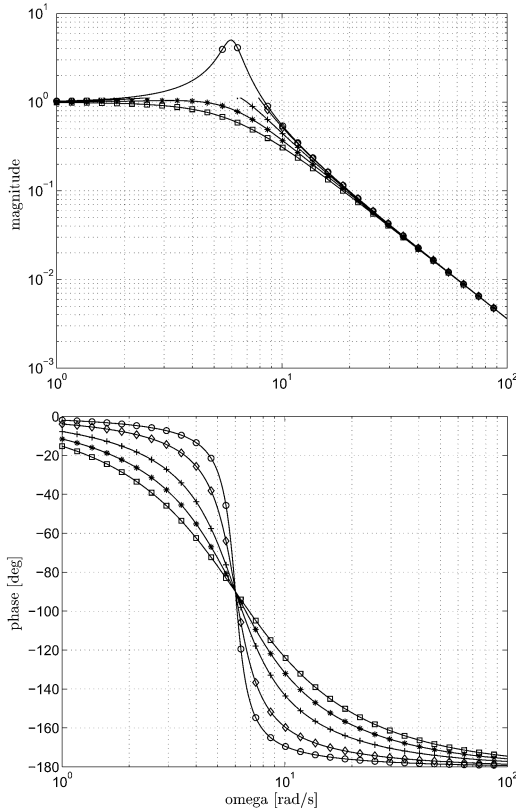

FIGURE 25.4 Variations in frequency response of second order system $G(s)$ with $\omega_n = 6$ and $\beta = 0.1(\circ)$, $0.2(\diamond)$, $0.4(+)$, $0.6(*)$, $0.8(\square)$.

25.3 Performance Indicators for Dynamic Systems

Step Response Parameters

Specifications for dynamic systems often involve requirements on the transient behavior of the system. Transient behavior requirements can be formulated on the basis of a step response and the most significant parameters have been summarized below and illustrated in Fig. 25.5.

- Steady state or DC value y_s of step response output.
- The steady state error y_{se} is the error between steady state value y_s and desired DC value of step response output.
- The maximum overshoot A_m is the maximum deviation of the step response output above its steady state value y_s .
- The peak time t_p is the time at which the maximum overshoot occurs.
- Settling time t_s is the time at which the step response input stays within some small percentage range of the steady state value y_s . Typically, a percentage of 2% or 5% is chosen to determine the settling time.
- The rise time t_r is usually defined as the time required for the step response output to rise from 10% to 90% of the steady state value y_s .
- The delay time t_d is defined as the time required to reach 50% of the steady state value y_s .

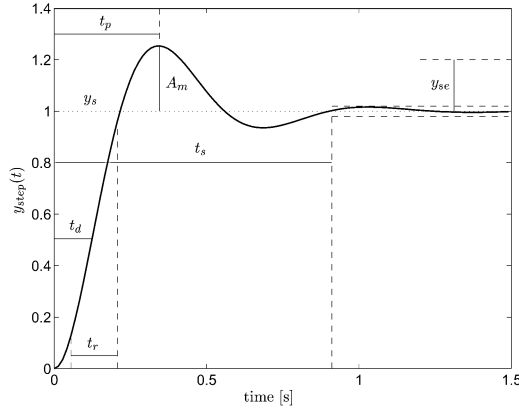

FIGURE 25.5 Parameters for step-response behavior: steady state value y_s , steady state error y_{se} , maximum overshoot A_m , peak time t_p , settling time t_s , rise time t_r , and delay time t_d .

Most of the above value can be obtained from an experimentally determined step response. In general, they cannot be obtained in an analytical form, except for low order models. For the second order model of the one mass system given in (25.3), some analytical results can be obtained. For a second order model of (25.3), the maximum overshoot A_m is determined by

$$A_m = 100e^{-\pi\beta/\sqrt{1-\xi^2}}, \quad \text{where } \xi = \frac{A}{\sqrt{\pi^2 + A^2}}, \quad A = \ln\left(\frac{100}{A_m}\right)$$

The peak time t_p can be computed by

$$t_p = \frac{\pi}{\omega_n \sqrt{1-\xi^2}}$$

whereas the delay time t_d can be approximated by

$$t_d \approx \frac{1 + 0.7\xi}{\omega_n}$$

As the maximum overshoot increases with a smaller damping coefficient β in the system, the maximum overshoot is often used to indicate the relative stability of the system.

Frequency Domain Parameters

With the frequency domain analysis of dynamic systems, specifications for the dynamic properties of a system can also be stated in the frequency domain. Frequency domain specifications in filter design often address ripple, bandwidth, roll-off, and phase lag parameters. Similar characteristics can also be specified for dynamic systems in case the model of the system is analyzed in the frequency domain. The most significant parameters have been summarized below and illustrated in Fig. 25.6.

- The bandwidth ω_b is a notion for the maximum frequency at which the output will track a sinusoidal input in a satisfactory manner. By convention, the bandwidth is defined as the frequency at which the output is attenuated -3 dB (0.707).
- The resonant frequency ω_r is the first frequency at which a significant resonance mode with low damping occurs. The resonance mode can, if uncontrolled, negatively influence the settling time of the dynamic system and plays an important role in characterization of performance.

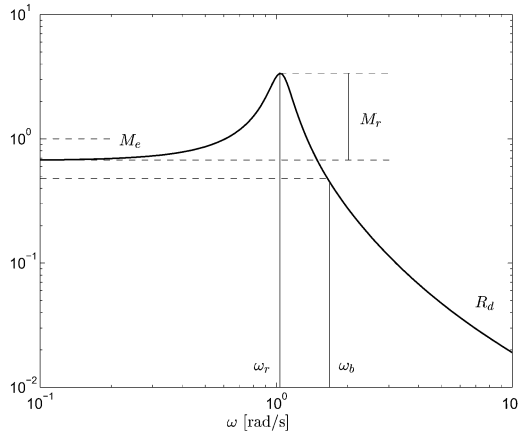

FIGURE 25.6 Parameters for frequency response behavior: bandwidth ω_b , resonance frequency ω_r , resonant peak M_r , steady state error M_e , and roll-off R_d .

- The resonant peak M_r is the height of a resonance mode. The resonant peak is a measure for the damping. As illustrated in Fig. 25.2 for a second order model, the resonance mode increases at lower damping coefficients.
- Steady state errors M_e can also be analyzed in the frequency response of a system. Using the final value theorem for continuous time systems

$$\lim_{t \rightarrow \infty} y(t) = y_s = \lim_{s \rightarrow 0} sy(s)$$

the presence of steady state errors can be inspected in the frequency domain by evaluation $|G(s)|$ at $s = i\omega = 0$ or for small values of the frequency vector ω . This can be seen as follows. As the Laplace transform $u_{\text{step}}(s)$ of a step input signal $u_{\text{step}}(t)$ is $u_{\text{step}}(s) = 1/s$,

$$\lim_{t \rightarrow \infty} y_{\text{step}}(t) = \lim_{s \rightarrow 0} sy_{\text{step}}(s) = \lim_{s \rightarrow 0} sG(s) \frac{1}{s} = \lim_{s \rightarrow 0} G(s)$$

By evaluating $|G(i\omega)|$ for small frequencies ω , the steady state behavior of $G(s)$ can be studied.

A similar result exist for discrete time systems, where the final value theorem reads as follows. If $u(z)$ converges for $|z| > 1$ and all poles of $(z - 1)u(z)$ are inside the unit circle, then

$$\lim_{k \rightarrow \infty} u(k) = \lim_{z \rightarrow 1} (z - 1)u(z)$$

Hence, for discrete time systems the steady state behavior of a transfer function $G(z)$ can be studied by evaluating $|G(e^{i\omega\Delta T})|$ for small frequencies ω .

- Roll-off R_d at high frequencies is defined as the negative slope of the frequency response at higher frequencies. The roll-off determines the performance of the dynamic system as high frequent disturbances can be amplified if a dynamic system does not have enough high frequent roll-off.

26

The Root Locus Method

- 26.1 Introduction
- 26.2 Desired Pole Locations
- 26.3 Root Locus Construction
 - Root Locus Rules • Root Locus Construction
 - Design Examples
- 26.4 Complementary Root Locus
- 26.5 Root Locus for Systems with Time Delays
 - Stability of Delay Systems • Dominant Roots of a Quasi-Polynomial • Root Locus Using Padé Approximations
- 26.6 Notes and References

Hitay Özbay
The Ohio State University

26.1 Introduction

The root locus technique is a graphical tool used in feedback control system analysis and design. It has been formally introduced to the engineering community by W. R. Evans [3,4], who received the Richard E. Bellman Control Heritage Award from the American Automatic Control Council in 1988 for this major contribution.

In order to discuss the root locus method, we must first review the basic definition of bounded input bounded output (BIBO) stability of the standard linear time invariant feedback system shown in Fig. 26.1, where the plant, and the controller, are represented by their transfer functions $P(s)$ and $C(s)$, respectively.¹ The plant, $P(s)$, includes the physical process to be controlled, as well as the actuator and the sensor dynamics.

The feedback system is said to be stable if none of the closed-loop transfer functions, from external inputs r and v to internal signals e and u , have any poles in the closed right half plane, $\bar{\mathbb{C}}_+ := \{s \in \mathbb{C} : \text{Re}(s) \geq 0\}$. A necessary condition for feedback system stability is that the closed right half plane zeros of $P(s)$ (respectively $C(s)$) are distinct from the poles of $C(s)$ (respectively $P(s)$). When this condition holds, we say that there is no unstable pole–zero cancellation in taking the product $P(s)C(s) =: G(s)$, and then checking feedback system stability becomes equivalent to checking whether all the roots of

$$1 + G(s) = 0 \tag{26.1}$$

are in the open left half plane, $\mathbb{C}_- := \{s \in \mathbb{C} : \text{Re}(s) < 0\}$. The roots of (26.1) are the closed-loop system poles. We would like to understand how the closed-loop system pole locations vary as functions of a real parameter of $G(s)$. More precisely, assume that $G(s)$ contains a parameter K , so that we use the notation

¹Here we consider the continuous time case; there is essentially no difference between the continuous time case and the discrete time case, as far as the root locus construction is concerned. In the discrete time case the desired closed-loop pole locations are defined relative to the unit circle, whereas in the continuous time case desired pole locations are defined relative to the imaginary axis.

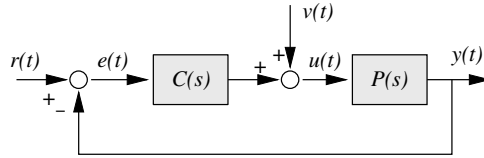

FIGURE 26.1 Standard unity feedback system.

$G(s) = G_K(s)$ to emphasize the dependence on K . The *root locus* is the plot of the roots of (26.1) on the complex plane, as the parameter K varies within a specified interval.

The most common example of the root locus problem deals with the uncertain (or adjustable) gain as the varying parameter: when $P(s)$ and $C(s)$ are fixed rational functions, except for a gain factor, $G(s)$ can be written as $G(s) = G_K(s) = KF(s)$, where K is the uncertain/adjustable gain, and

$$F(s) = \frac{N(s)}{D(s)} \quad \text{where} \quad \begin{aligned} N(s) &= \prod_{j=1}^m (s - z_j) \\ D(s) &= \prod_{i=1}^n (s - p_i), \end{aligned} \quad n \geq m \quad (26.2)$$

with z_1, \dots, z_m , and p_1, \dots, p_n being the open-loop system zeros and poles. In this case, the closed-loop system poles are the roots of the characteristic equation

$$\chi(s) := D(s) + KN(s) = 0 \quad (26.3)$$

The *usual root locus* is obtained by plotting the roots $r_1(K), \dots, r_n(K)$ of the characteristic polynomial $\chi(s)$ on the complex plane, as K varies from 0 to $+\infty$. The same plot for the negative values of K gives the *complementary root locus*. With the help of the root locus plot the designer identifies the admissible values of the parameter K leading to a set of closed-loop system poles that are in the desired region of the complex plane. There are several factors to be considered in defining the “desired region” of the complex plane in which all the roots $r_1(K), \dots, r_n(K)$ should lie. Those are discussed briefly in the next section. Section 26.3 contains the root locus construction procedure, and design examples are presented in section 26.4.

The root locus can also be drawn with respect to a system parameter other than the gain. For example, the characteristic equation for the system $G(s) = G_\lambda(s)$, defined by

$$G_\lambda(s) = P(s)C(s), \quad P(s) = \frac{(1 - \lambda s)}{s(1 + \lambda s)}, \quad C(s) = K_c \left(1 + \frac{1}{T_I s} \right)$$

can also be transformed into the form given in (26.3). Here K_c and T_I are given fixed PI (Proportional plus Integral) controller parameters, and $\lambda > 0$ is an uncertain plant parameter. Note that the phase of the plant is

$$\angle P(j\omega) = -\frac{\pi}{2} - 2 \tan^{-1}(\lambda\omega)$$

so the parameter λ can be seen as the uncertain phase lag factor (for example, a small uncertain time delay in the plant can be modeled in this manner, see [9]). It is easy to see that the characteristic equation is

$$s^2(\lambda s + 1) + K_c(1 - \lambda s) \left(s + \frac{1}{T_I} \right) = 0$$

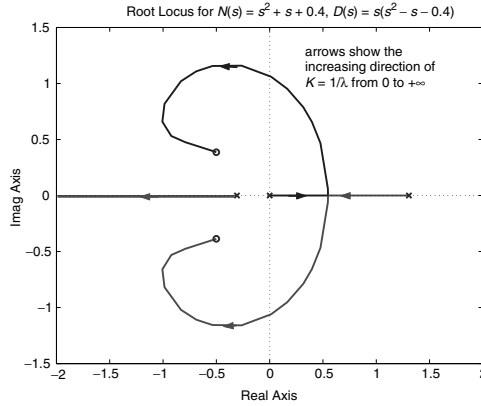

FIGURE 26.2 The root locus with respect to $K = 1/\lambda$.

and by rearranging the terms multiplying λ this equation can be transformed to

$$1 + \frac{1}{\lambda} \frac{(s^2 + K_c s + K_c/T_I)}{s(s^2 - K_c s - K_c/T_I)} = 0$$

By defining $K = \lambda^{-1}$, $N(s) = (s^2 + K_c s + K_c/T_I)$, and $D(s) = s(s^2 - K_c s - K_c/T_I)$, we see that the characteristic equation can be put in the form of (26.3). The root locus plot can now be obtained from the data $N(s)$ and $D(s)$ defined above; that shows how closed-loop system poles move as λ^{-1} varies from 0 to $+\infty$, for a given fixed set of controller parameters K_c and T_I . For the numerical example $K_c = 1$ and $T_I = 2.5$, the root locus is illustrated in Fig. 26.2.

The root locus construction procedure will be given in section 26.3. Most of the computations involved in each step of this procedure can be performed by hand calculations. Hence, an approximate graph representing the root locus can be drawn easily. There are also several software packages to generate the root locus automatically from the problem data z_1, \dots, z_m , and p_1, \dots, p_n .

If a numerical computation program is available for calculating the roots of a polynomial, we can also obtain the root locus with respect to a parameter which enters into the characteristic equation nonlinearly. To illustrate this point let us consider the following example: $G(s) = G_{\omega_0}(s)$ where

$$G_{\omega_0}(s) = P(s)C(s), \quad P(s) = \frac{(s - 0.1)}{(s^2 + 1.2\omega_0 s + \omega_0^2)(s + 0.1)}, \quad C(s) = \frac{(s - 0.2)}{(s + 2)}$$

Here $\omega_0 \geq 0$ is the uncertain plant parameter. Note that the characteristic equation

$$1 + \frac{\omega_0(1.2s + \omega_0)(s + 0.1)(s + 2)}{s^2(s + 0.1)(s + 2) + (s - 0.2)(s - 0.1)} = 0 \tag{26.4}$$

cannot be expressed in the form of $D(s) + KN(s) = 0$ with a single parameter K . Nevertheless, for each ω_0 we can numerically calculate the roots of (26.4) and plot them on the complex plane as ω_0 varies within a range of interest. Figure 26.3 illustrates all the four branches, $r_1(K), \dots, r_4(K)$, of the root locus for this system as ω_0 increases from zero to infinity. The figure is obtained by computing the roots of (26.4) for a set of values of ω_0 by using MATLAB.

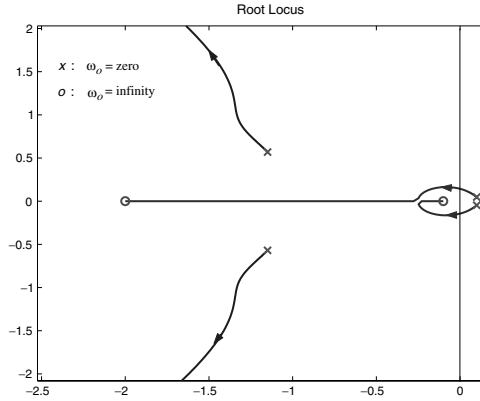

FIGURE 26.3 The root locus with respect to ω_o .

26.2 Desired Pole Locations

The performance of a feedback system depends heavily on the location of the closed-loop system poles $r_i(K) = 1, \dots, n$. First of all, for stability we want $r_i(K) \in \mathbb{C}_-$ for all $i = 1, \dots, n$. Clearly, having a pole “close” to the imaginary axis poses a danger, i.e., “small” perturbations in the plant might lead to an unstable feedback system. So the desired pole locations must be such that stability is preserved under such perturbations (or in the presence of uncertainties) in the plant. For second-order systems, we can define certain stability robustness measures in terms of the pole locations, which can be tied to the characteristics of the step response. For higher order systems, similar guidelines can be used by considering the dominant poles only.

In the standard feedback control system shown in Fig. 26.1, assume that the closed-loop transfer function from $r(t)$ to $y(t)$ is in the form

$$T(s) = \frac{\omega_o^2}{s^2 + 2\zeta\omega_o s + \omega_o^2}, \quad 0 < \zeta < 1, \quad \omega_o \in \mathbb{R}$$

and $r(t)$ is the unit step function. Then, the output is

$$y(t) = 1 - \frac{e^{-\zeta\omega_o t}}{\sqrt{1 - \zeta^2}} \sin(\omega_d t + \theta), \quad t \geq 0$$

where $\omega_d := \omega_o \sqrt{1 - \zeta^2}$ and $\theta := \cos^{-1}(\zeta)$. For some typical values of ζ , the step response $y(t)$ is as shown in Fig. 26.4. The maximum *percent overshoot* is defined to be the quantity

$$\text{PO} := \frac{y_p - y_{ss}}{y_{ss}} \times 100\%$$

where y_p is the peak value. By simple calculations it can be seen that the peak value of $y(t)$ occurs at the time instant $t_p = \pi/\omega_d$, and

$$\text{PO} = e^{-\pi\zeta/\sqrt{1-\zeta^2}} \times 100\%$$

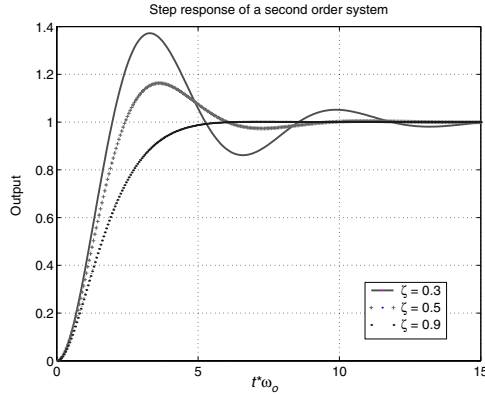

FIGURE 26.4 Step response of a second-order system.

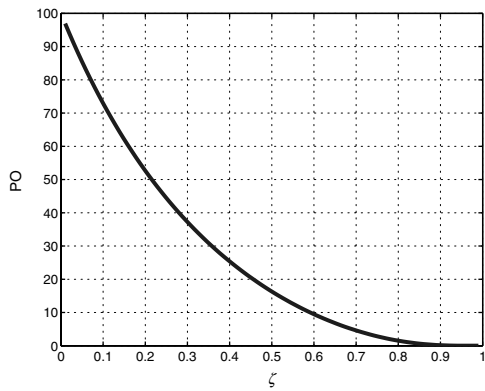

FIGURE 26.5 PO versus ζ .

Figure 26.5 shows PO versus ζ . The *settling time* is defined to be the smallest time instant t_s , after which the response $y(t)$ remains within 2% of its final value, i.e.,

$$t_s := \min\{t': |y(t) - y_{ss}| \leq 0.02y_{ss} \forall t \geq t'\}$$

Sometimes 1% or 5% is used in the definition of settling time instead of 2%; conceptually, there is no difference. For the second-order system response, we have

$$t_s \approx \frac{4}{\zeta\omega_0}$$

So, in order to have a fast settling response, the product $\zeta\omega_0$ should be large.

The closed-loop system poles are

$$r_{1,2} = -\zeta\omega_0 \pm j\omega_0\sqrt{1 - \zeta^2}$$

Therefore, once the maximum allowable settling time and PO are specified, we can define the region of desired pole locations by determining the minimum allowable ζ and $\zeta\omega_0$. For example, let the desired PO and t_s be bounded by

$$PO \leq 10\% \quad \text{and} \quad t_s \leq 8 \text{ s}$$

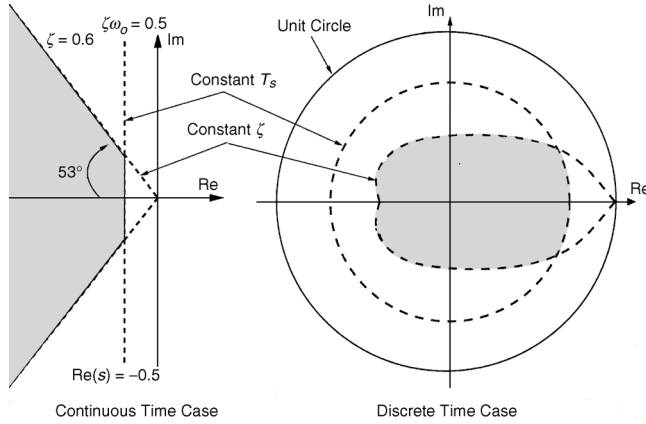

FIGURE 26.6 Region of the desired closed-loop poles.

The PO requirement implies that $\zeta \geq 0.6$, equivalently $\theta \leq 53^\circ$ (recall that $\cos(\theta) = \zeta$). The settling time requirement is satisfied if and only if $\text{Re}(r_{1,2}) \leq -0.5$. Then, the region of desired closed-loop poles is the shaded area shown in Fig. 26.6. The same figure also illustrates the region of desired closed-loop poles for similar design requirements in the discrete time case.

If the order of the closed-loop transfer function $T(s)$ is higher than two, then, depending on the location of its poles and zeros, it may be possible to approximate the closed-loop step response by the response of a second-order system. For example, consider the third-order system

$$T(s) = \frac{\omega_o^2}{(s^2 + 2\zeta\omega_o s + \omega_o^2)(1 + s/r)} \quad \text{where } r \gg \zeta\omega_o$$

The transient response contains a term e^{-rt} . Compared with the envelope $e^{-\zeta\omega_o t}$ of the sinusoidal term, e^{-rt} decays very fast, and the overall response is similar to the response of a second-order system. Hence, the effect of the third pole $r_3 = -r$ is negligible.

Consider another example,

$$T(s) = \frac{\omega_o^2 [1 + s/(r + \epsilon)]}{(s^2 + 2\zeta\omega_o s + \omega_o^2)(1 + s/r)} \quad \text{where } 0 < \epsilon \ll r$$

In this case, although r does not need to be much larger than $\zeta\omega_o$, the zero at $-(r + \epsilon)$ cancels the effect of the pole at $-r$. To see this, consider the partial fraction expansion of $Y(s) = T(s)R(s)$ with $R(s) = 1/s$:

$$Y(s) = \frac{A_0}{s} + \frac{A_1}{s - r_1} + \frac{A_2}{s - r_2} + \frac{A_3}{s + r}$$

where $A_0 = 1$ and

$$A_3 = \lim_{s \rightarrow -r} (s + r)Y(s) = \frac{\omega_o^2}{2\zeta\omega_o r - (\omega_o^2 + r^2)} \left(\frac{\epsilon}{r + \epsilon} \right)$$

Since $|A_3| \rightarrow 0$ as $\epsilon \rightarrow 0$, the term $A_3 e^{-rt}$ is negligible in $y(t)$.

In summary, if there is an approximate pole-zero cancellation in the left half plane, then this pole-zero pair can be taken out of the transfer function $T(s)$ to determine PO and t_s . Also, the poles closest to the

imaginary axis dominate the transient response of $y(t)$. To generalize this observation, let r_1, \dots, r_n be the poles of $T(s)$, such that $\text{Re}(r_k) \ll \text{Re}(r_2) = \text{Re}(r_1) < 0$, for all $k \geq 3$. Then, the pair of complex conjugate poles $r_{1,2}$ are called the *dominant poles*. We have seen that the desired transient response properties, e.g., PO and t_s , can be translated into requirements on the location of the dominant poles.

26.3 Root Locus Construction

As mentioned above, the root locus primarily deals with finding the roots of a characteristic polynomial that is an affine function of a single parameter, K ,

$$\chi(s) = D(s) + KN(s) \quad (26.5)$$

where $D(s)$ and $N(s)$ are fixed monic polynomials (i.e., coefficient of the highest power is normalized to 1). If N and/or D are not monic, the highest coefficient(s) can be absorbed into K .

Root Locus Rules

Recall that the usual root locus shows the locations of the closed-loop system poles as K varies from 0 to $+\infty$. The roots of $D(s)$, p_1, \dots, p_n , are the poles, and the roots of $N(s)$, z_1, \dots, z_m , are the zeros, of the open-loop system, $G(s) = KF(s)$. Since $P(s)$ and $C(s)$ are proper, $G(s)$ is proper, and hence $n \geq m$. So the degree of the polynomial $\chi(s)$ is n and it has exactly n roots.

Let the closed-loop system poles, i.e., roots of $\chi(s)$, be denoted by $r_1(K), \dots, r_n(K)$. Note that these are functions of K ; whenever the dependence on K is clear, they are simply written as r_1, \dots, r_n . The points in \mathbb{C} that satisfy (26.5) for some $K > 0$ are on the root locus. Clearly, a point $r \in \mathbb{C}$ is on the root locus if and only if

$$K = -\frac{1}{F(r)} \quad (26.6)$$

The condition (26.6) can be separated into two parts:

$$|K| = \frac{1}{|F(r)|} \quad (26.7)$$

$$\angle K = 0^\circ = -(2\ell + 1) \times 180^\circ - \angle F(r), \quad \ell = 0, \pm 1, \pm 2, \dots \quad (26.8)$$

The phase rule (26.8) determines the points in \mathbb{C} that are on the root locus. The magnitude rule (26.7) determines the gain $K > 0$ for which the root locus is at a given point r . By using the definition of $F(s)$, (26.8) can be rewritten as

$$(2\ell + 1) \times 180^\circ = \sum_{i=1}^n \angle(r - p_i) - \sum_{j=1}^m \angle(r - z_j) \quad (26.9)$$

Similarly, (26.7) is equivalent to

$$K = \frac{\prod_{i=1}^n |r - p_i|}{\prod_{j=1}^m |r - z_j|} \quad (26.10)$$

Root Locus Construction

There are several software packages available for generating the root locus automatically for a given $F = N/D$. In particular, the related MATLAB commands are `rlocus` and `rlocfind`. In many cases, approximate root locus can be drawn by hand using the rules given below. These rules are determined from the basic definitions (26.5), (26.7), and (26.8).

1. The root locus has n branches: $r_1(K), \dots, r_n(K)$.
2. Each branch starts ($K \equiv 0$) at a pole p_i and ends (as $K \rightarrow \infty$) at a zero z_j , or converges to an asymptote, $Me^{j\alpha_\ell}$, where $M \rightarrow \infty$ and

$$\alpha_\ell = \frac{2\ell + 1}{n - m} \times 180^\circ, \quad \ell = 0, \dots, (n - m - 1)$$

3. There are $(n - m)$ asymptotes with angles α_ℓ . The center of the asymptotes (i.e., their intersection point on the real axis) is

$$\sigma_a = \frac{\sum_{i=1}^n p_i - \sum_{j=1}^m z_j}{n - m}$$

4. A point $x \in \mathbb{R}$ is on the root locus if and only if the total number of poles p_i 's and zeros z_j 's to the right of x (i.e., total number of p_i 's with $\text{Re}(p_i) > x$ plus total number of z_j 's with $\text{Re}(z_j) > x$) is odd. Since $F(s)$ is a rational function with real coefficients, poles and zeros appear in complex conjugates, so when counting the number of poles and zeros to the right of a point $x \in \mathbb{R}$ we just need to consider the poles and zeros on the real axis.
5. The values of K for which the root locus crosses the imaginary axis can be determined from the Routh–Hurwitz stability test. Alternatively, we can set $s = j\omega$ in (26.5) and solve for real ω and K satisfying

$$D(j\omega) + KN(j\omega) = 0$$

Note that there are two equations here, one for the real part and one for the imaginary part.

6. The break points (intersection of two branches on the real axis) are feasible solutions (satisfying rule 4) of

$$\frac{d}{ds}F(s) = 0 \tag{26.11}$$

7. Angles of departure ($K \equiv 0$) from a complex pole, or arrival ($K \rightarrow +\infty$) to a complex zero, can be determined from the phase rule. See example below.

Let us now follow the above rules step by step to construct the root locus for

$$F(s) = \frac{(s + 3)}{(s - 1)(s + 5)(s + 4 + j2)(s + 4 - j2)}$$

First, enumerate the poles and zeros as $p_1 = -4 + j2$, $p_2 = -4 - j2$, $p_3 = -5$, $p_4 = 1$, $z_1 = -3$. So, $n = 4$ and $m = 1$.

1. The root locus has four branches.
2. Three branches converge to the asymptotes whose angles are 60° , 180° , and -60° , and one branch converges to $z_1 = -3$.

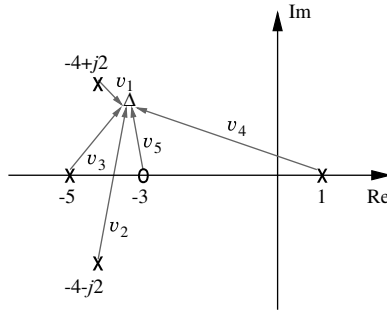

FIGURE 26.7 Angle of departure from $-4 + j2$.

3. The center of the asymptotes is $\sigma = (-12 + 3)/3 = -3$.
4. The intervals $(-\infty, -5]$ and $[-3, 1]$ are on the root locus.
5. The imaginary axis crossings are the feasible roots of

$$(\omega^4 - j12\omega^3 - 47\omega^2 + j40\omega - 100) + K(j\omega + 3) = 0 \quad (26.12)$$

for real ω and K . Real and imaginary parts of (26.12) are

$$\begin{aligned} \omega^4 - 47\omega^2 - 100 + 3K &= 0 \\ j\omega(-12\omega^2 + 40 + K) &= 0 \end{aligned}$$

They lead to two feasible pairs of solutions ($K = 100/3, \omega = 0$) and ($K = 215.83, \omega = \pm 4.62$).

6. Break points are the feasible solutions of

$$3s^4 + 36s^3 + 155s^2 + 282s + 220 = 0$$

Since the roots of this equation are $-4.55 \pm j1.11$ and $-1.45 \pm j1.11$, there is no solution on the real axis, hence no break points.

7. To determine the angle of departure from the complex pole $p_1 = -4 + j2$, let Δ represent a point on the root locus near the complex pole p_1 , and define $v_i, i = 1, \dots, 5$, to be the vectors drawn from p_i , for $i = 1, \dots, 4$, and from z_1 for $i = 5$, as shown in Fig. 26.7. Let $\theta_1, \dots, \theta_5$ be the angles of v_1, \dots, v_5 . The phase rule implies

$$(\theta_1 + \theta_2 + \theta_3 + \theta_4) - \theta_5 = \pm 180^\circ \quad (26.13)$$

As Δ approaches p_1 , θ_1 becomes the angle of departure and the other θ_i 's can be approximated by the angles of the vectors drawn from the other poles, and from the zero, to the pole p_1 . Thus θ_1 can be solved from (26.13), where $\theta_2 \approx 90^\circ$, $\theta_3 \approx \tan^{-1}(2)$, $\theta_4 \approx 180^\circ - \tan^{-1}(\frac{2}{5})$, and $\theta_5 \approx 90^\circ + \tan^{-1}(\frac{1}{2})$. That yields $\theta_1 \approx -15^\circ$.

The exact root locus for this example is shown in Fig. 26.8. From the results of item 5 above, and the shape of the root locus, it is concluded that the feedback system is stable if

$$33.33 < K < 215.83$$

i.e., by simply adjusting the gain of the controller, the system can be made stable. In some situations we need to use a dynamic controller to satisfy all the design requirements.

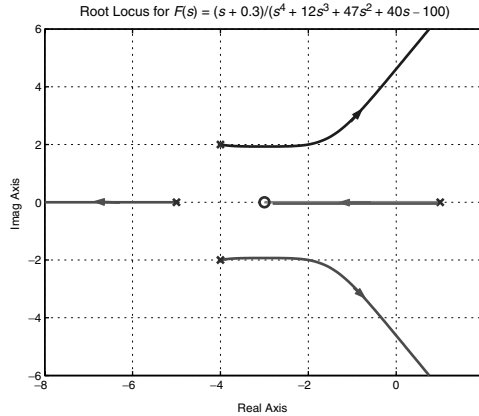

FIGURE 26.8 Root locus for $F(s) = \frac{(s + 3)}{(s - 1)(s + 5)(s + 4 + j2)(s + 4 - j2)}$.

Design Examples

Example 1

Consider the standard feedback system with a plant

$$P(s) = \frac{1}{0.72} \frac{1}{(s + 1)(s + 2)}$$

and design a controller such that

- the feedback system is stable,
- $PO \leq 10\%$, $t_s \leq 4$ s, and steady state error is zero when $r(t)$ is unit step,
- steady state error is as small as possible when $r(t)$ is unit ramp.

It is clear that the second design goal cannot be achieved by a simple proportional controller. To satisfy this condition, the controller must have a pole at $s = 0$, i.e., it must have integral action. If we try an integral control of the form $C(s) = K_c/s$, with $K_c > 0$, then the root locus has three branches, the interval $[-1, 0]$ is on the root locus; three asymptotes have angles $\{60^\circ, 180^\circ, -60^\circ\}$ with a center at $\sigma_a = -1$; and there is only one break point at $-1 + \frac{1}{\sqrt{3}}$, see Fig. 26.9. From the location of the break point, center, and angles of the asymptotes, it can be deduced that two branches (one starting at $p_1 = -1$, and the other one starting at $p_3 = 0$) always remain to the right of p_1 . On the other hand, the settling time condition implies that the real parts of the dominant closed-loop system poles must be less than or equal to -1 . So, a simple integral control does not do the job. Now try a PI controller of the form

$$C(s) = K_c \left(\frac{s - z_c}{s} \right), \quad K_c > 0$$

In this case, we can select $z_c = -1$ to cancel the pole at $p_1 = -1$ and the system effectively becomes a second-order system. The root locus for $F(s) = 1/s(s + 2)$ has two branches and two asymptotes, with center $\sigma_a = -1$ and angles $\{90^\circ, -90^\circ\}$; the break point is also at -1 . The branches leave -2 and 0 , and go toward each other, meet at -1 , and tend to infinity along the line $\text{Re}(s) = -1$. Indeed, the closed-loop system poles are

$$r_{1,2} = -1 \pm \sqrt{1 - K}, \quad \text{where } K = K_c/0.72$$

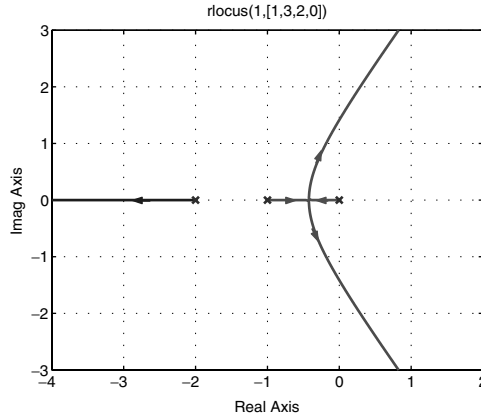

FIGURE 26.9 Root locus for Example 1.

The steady state error, when $r(t)$ is unit ramp, is $2/K$. So K needs to be as large as possible to meet the third design condition. Clearly, $\text{Re}(r_{1,2}) = -1$ for all $K \geq 1$, which satisfies the settling time requirement. The percent overshoot is less than 10% if ζ of the roots $r_{1,2}$ is greater than 0.6. A simple algebra shows that $\zeta = 1/\sqrt{K}$, hence the design conditions are met if $K = 1/0.36$, i.e. $K_c = 2$. Thus a PI controller that solves the design problem is

$$C(s) = 2\left(\frac{s+1}{s}\right)$$

The controller cancels a stable pole (at $s = -1$) of the plant. If there is a slight uncertainty in this pole location, perfect cancellation will not occur and the system will be third-order with the third pole at $r_3 \cong -1$. Since the zero at $z_0 = -1$ will approximately cancel the effect of this pole, the response of this system will be close to the response of a second-order system. However, we must be careful if the pole-zero cancellations are near the imaginary axis because in this case small perturbations in the pole location might lead to large variations in the feedback system response, as illustrated with the next example.

Example 2

A flexible structure with lightly damped poles has transfer function in the form

$$P(s) = \frac{\omega_1^2}{s^2(s^2 + 2\zeta\omega_1s + \omega_1^2)}$$

By using the root locus, we can see that the controller

$$C(s) = K_c \frac{(s^2 + 2\zeta\omega_1s + \omega_1^2)(s + 0.4)}{(s + r)^2(s + 4)}$$

stabilizes the feedback system for sufficiently large r and an appropriate choice of K_c . For example, let $\omega_1 = 2$, $\zeta = 0.1$, and $r = 10$. Then the root locus of $F(s) = P(s)C(s)/K$, where $K = K_c\omega_1^2$, is as shown in Fig. 26.10. For $K = 600$, the closed-loop system poles are

$$\{-10.78 \pm j2.57, -0.94 \pm j1.61, -0.2 \pm j1.99, -0.56\}$$

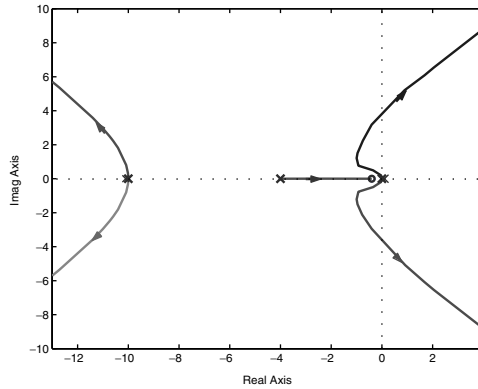

FIGURE 26.10 Root locus for Example 2(a).

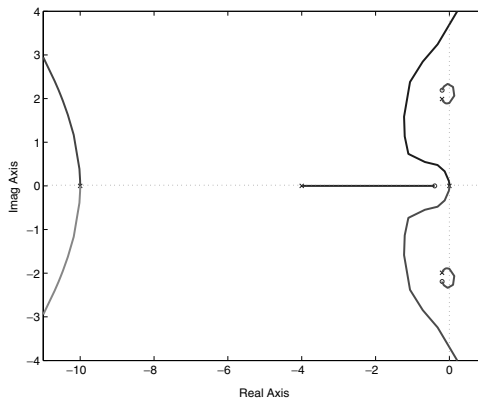

FIGURE 26.11 Root locus for Example 2(b).

Since the poles $-0.2 \pm j1.99$ are canceled by a pair of zeros at the same point in the closed-loop system transfer function $T = G(1 + G)^{-1}$, the dominant poles are at -0.56 and $-0.94 \pm j1.61$ (they have relatively large negative real parts and the damping ratio is about 0.5).

Now, suppose that this controller is fixed and the complex poles of the plant are slightly modified by taking $\zeta = 0.09$ and $\omega_1 = 2.2$. The root locus corresponding to this system is as shown in Fig. 26.11. Since lightly damped complex poles are not perfectly canceled, there are two more branches near the imaginary axis. Moreover, for the same value of $K = 600$, the closed-loop system poles are

$$\{-10.78 \pm j2.57, -1.21 \pm j1.86, 0.05 \pm j1.93, -0.51\}$$

In this case, the feedback system is unstable.

Example 3

One of the most important examples of mechatronic systems is the DC motor. An approximate transfer function of a DC motor [8, pp. 141–143] is in the form

$$P_m(s) = \frac{K_m}{s(s + 1/\tau_m)}, \quad \tau_m > 0$$

Also note that if τ_m is large, then $P_m(s) \approx P_b(s)$, where $P_b(s) = K_b/s^2$ is the transfer function of a rigid beam. In this example, the general class of plants $P_m(s)$ will be considered. Assuming that $p_m = -1/\tau_m$ and K_m are given, a first-order controller

$$C(s) = K_c \left(\frac{s - z_c}{s - p_c} \right) \quad (26.14)$$

will be designed. The aim is to place the closed-loop system poles far from the Im-axis. Since the order of $F(s) = P_m(s)C(s)/K_mK_c$ is three, the root locus has three branches. Suppose the desired closed-loop poles are given as p_1, p_2 , and p_3 . Then, the pole placement problem amounts to finding $\{K_c, z_c, p_c\}$ such that the characteristic equation is

$$\begin{aligned} \chi(s) &= (s - p_1)(s - p_2)(s - p_3) \\ &= s^3 - (p_1 + p_2 + p_3)s^2 + (p_1p_2 + p_1p_3 + p_2p_3)s - p_1p_2p_3 \end{aligned}$$

But the actual characteristic equation, in terms of the unknown controller parameters, is

$$\begin{aligned} \chi(s) &= s(s - p_m)(s - p_c) + k(s - z_c) \\ &= s^3 - (p_m + p_c)s^2 + (p_m p_c + K)s - Kz_c \end{aligned}$$

where $K := K_m K_c$. Equating the coefficients of the desired $\chi(s)$ to the coefficients of the actual $\chi(s)$, three equations in three unknowns are obtained:

$$\begin{aligned} p_m + p_c &= p_1 + p_2 + p_3 \\ p_m p_c + K &= p_1 p_2 + p_1 p_3 + p_2 p_3 \\ K z_c &= p_1 p_2 p_3 \end{aligned}$$

From the first equation p_c is determined, then K is obtained from the second equation, and finally z_c is computed from the third equation.

For different numerical values of p_m, p_1, p_2 , and p_3 the shape of the root locus is different. Below are some examples, with the corresponding root loci shown in Figs. 26.12–26.14.

(a) $p_m = -0.05, p_1 = p_2 = p_3 = -2 \Rightarrow$

$$K = 11.70, \quad p_c = -5.95, \quad z_c = -0.68$$

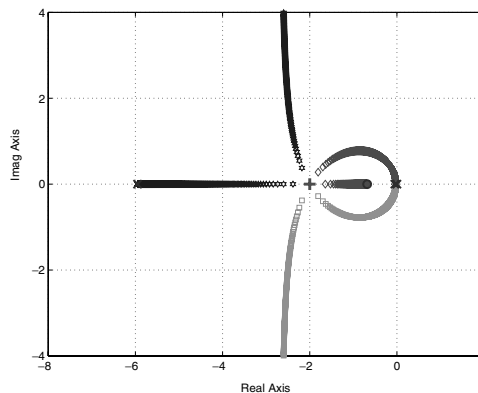

FIGURE 26.12 Root locus for Example 3(a).

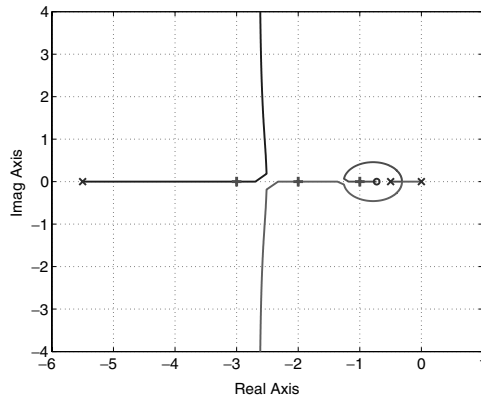

FIGURE 26.13 Root locus for Example 3(b).

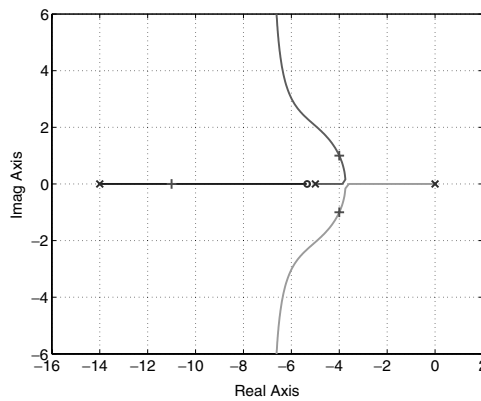

FIGURE 26.14 Root locus for Example 3(c).

(b) $p_m = -0.5, p_1 = -1, p_2 = -2, p_3 = -3 \Rightarrow$

$$K = 8.25, \quad p_c = -5.50, \quad z_c = -0.73$$

(c) $p_m = -5, p_1 = -11, p_2 = -4 + j1, p_3 = -4 - j1 \Rightarrow$

$$K = 35, \quad p_c = -14, \quad z_c = -5.343$$

Example 4

Consider the open-loop transfer function

$$P(s)C(s) = K_c \frac{(s^2 - 3s + 3)(s - z_c)}{s(s^2 + 3s + 3)(s - p_c)}$$

where K_c is the controller gain to be adjusted, and z_c and p_c are the controller zero and pole, respectively. Observe that the root locus has four branches except for the non-generic case $z_c = p_c$. Let the desired dominant closed-loop poles be $r_{1,2} = -0.4$. The steady state error for unit ramp reference input is

$$e_{ss} = \frac{p_c}{K_c z_c}$$

Accordingly, we want to make the ratio $K_c z_c / p_c$ as large as possible.

The characteristic equation is

$$\chi(s) = s(s^2 + 3s + 3)(s - p_c) + K_c(s^2 - 3s + 3)(s - z_c)$$

and it is desired to be in the form

$$\chi(s) = (s + 0.4)^2(s - r_3)(s - r_4)$$

for some $r_{3,4}$ with $\text{Re}(r_{3,4}) < 0$, which implies that

$$\chi(s)|_{s=-0.4} = 0, \quad \frac{d}{ds}\chi(s)|_{s=-0.4} = 0 \quad (26.15)$$

Conditions (26.15) give two equations:

$$\begin{aligned} 0.784(0.4 + p_c) - 4.36K_c(0.4 + z_c) &= 0 \\ 4.36K_c - 0.784 - 1.08(0.4 + p_c) + 3.8K_c(0.4 + z_c) &= 0 \end{aligned}$$

from which z_c and p_c can be solved in terms of K_c . Then, by simple substitutions, the ratio to be maximized, $K_c z_c / p_c$, can be reduced to

$$\frac{K_c z_c}{p_c} = \frac{3.4776K_c - 0.784}{24.2469K_c - 3.4776}$$

The maximizing value of K_c is 0.1297; it leads to $p_c = -0.9508$ and $z_c = -1.1637$. For this controller, the feedback system poles are

$$\{-1.64 + j0.37, -1.64 - j0.37, -0.40, -0.40\}$$

The root locus is shown in Fig. 26.15.

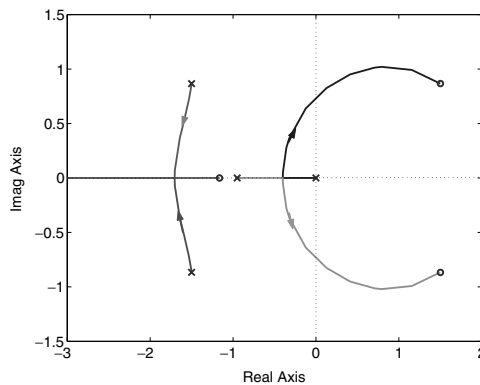

FIGURE 26.15 Root locus for Example 4.

26.4 Complementary Root Locus

In the previous section, the root locus parameter K was assumed to be positive and the phase and magnitude rules were established based on this assumption. There are some situations in which controller gain can be negative as well. Therefore, the complete picture is obtained by drawing the usual root locus (for $K > 0$) and the complementary root locus (for $K < 0$). The complementary root locus rules are

$$\ell \times 360^\circ = \sum_{i=1}^n \angle(r - p_i) - \sum_{j=1}^m \angle(r - z_j), \quad \ell = 0, \pm 1, \pm 2, \dots \quad (26.16)$$

$$|K| = \frac{\prod_{i=1}^n |r - p_i|}{\prod_{j=1}^m |r - z_j|} \quad (26.17)$$

Since the phase rule (26.16) is the 180° shifted version of (26.9), the complementary root locus is obtained by simple modifications in the root locus construction rules. In particular, the number of asymptotes and their center are the same, but their angles α_ℓ 's are given by

$$\alpha_\ell = \frac{2\ell}{(n - m)} \times 180^\circ, \quad \ell = 0, \dots, (n - m - 1)$$

Also, an interval on the real axis is on the complementary root locus if and only if it is not on the usual root locus.

Example 3 (revisited)

In the Example 3 given above, if the problem data is modified to $p_m = -5$, $p_1 = -20$, and $p_{2,3} = -2 \pm j$, then the controller parameters become

$$K = -10, \quad p_c = -19, \quad z_c = 10$$

Note that the gain is negative. The roots of the characteristic equation as K varies between 0 and $-\infty$ form the complementary root locus; see Fig. 26.16.

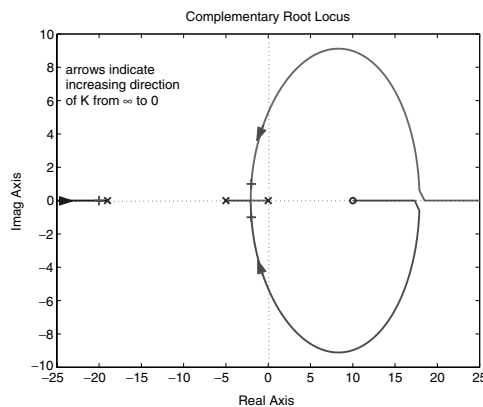

FIGURE 26.16 Complementary root locus for Example 3.

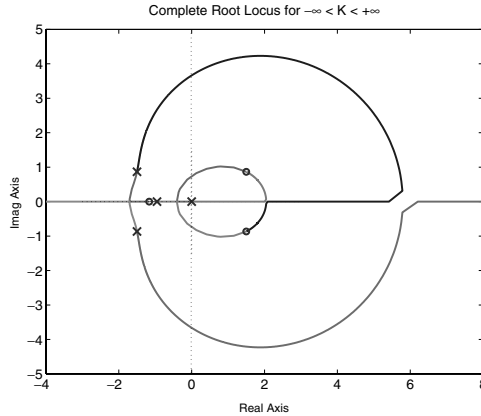

FIGURE 26.17 Complementary and usual root loci for Example 4.

Example 4 (revisited)

In this example, if K increases from $-\infty$ to $+\infty$, the closed-loop system poles move along the complementary root locus, and then the usual root locus, as illustrated in Fig. 26.17.

26.5 Root Locus for Systems with Time Delays

The standard feedback control system considered in this section is shown in Fig. 26.18, where the controller C and plant P are in the form

$$C(s) = \frac{N_c(s)}{D_c(s)}$$

and

$$P(s) = e^{-hs} P_0(s) \quad \text{where } P_0(s) = \frac{N_p(s)}{D_p(s)}$$

with (N_c, D_c) and (N_p, D_p) being coprime pairs of polynomials with real coefficients.² The term e^{-hs} is the transfer function of a pure delay element (in Fig. 26.18 the plant input is delayed by h seconds). In general, time delays enter into the plant model when there is

- a sensor (or actuator) processing delay, and/or
- a software delay in the controller, and/or
- a transport delay in the process.

In this case the open-loop transfer function is

$$G(s) = G_h(s) = e^{-hs} G_0(s)$$

where $G_0(s) = P_0(s)C(s)$ corresponds to the no delay case, $h = 0$.

Note that magnitude and phase of $G(j\omega)$ are determined from the identities

$$|G(j\omega)| = |G_0(j\omega)| \tag{26.18}$$

$$\angle G(j\omega) = -h\omega + \angle G_0(j\omega) \tag{26.19}$$

²A pair of polynomials is said to be coprime pair if they do not have common roots.

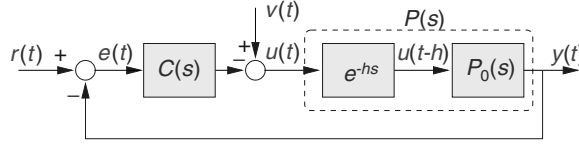

FIGURE 26.18 Feedback system a with time delay.

Stability of Delay Systems

Stability of the feedback system shown in Fig. 26.18 is equivalent to having all the roots of

$$\chi(s) = D(s) + e^{-hs}N(s) \quad (26.20)$$

in the open left half plane, \mathbb{C}_- , where $D(s) = D_c(s)D_p(s)$ and $N(s) = N_c(s)N_p(s)$. We assume that there is no unstable pole-zero cancellation in taking the product $P_0(s)C(s)$, and that $\deg(D) > \deg(N)$ (here N and D need not be monic polynomials). Strictly speaking, $\chi(s)$ is not a polynomial because it is a transcendental function of s . The functions of the form (26.20) belong to a special class of functions called *quasi-polynomials*. The closed-loop system poles are the roots of (26.20).

Following are known facts (see [1,10]):

- (i) If r_k is a root of (20), then so is \bar{r}_k (i.e., roots appear in complex conjugate pairs as usual).
- (ii) There are infinitely many poles $r_k \in \mathbb{C}$, $k = 1, 2, \dots$, satisfying $\chi(r_k) = 0$.
- (iii) And r_k 's can be enumerated in such a way that $\text{Re}(r_{k+1}) \leq \text{Re}(r_k)$; moreover, $\text{Re}(r_k) \rightarrow -\infty$ as $k \rightarrow \infty$.

Example

If $G_h(s) = e^{-hs}/s$, then the closed-loop system poles r_k , for $k = 1, 2, \dots$, are the roots of

$$1 + \frac{e^{-h\sigma_k} e^{-j h \omega_k}}{\sigma_k + j \omega_k} e^{\pm j 2k\pi} = 0 \quad (26.21)$$

where $r_k = \sigma_k + j\omega_k$ for some $\sigma_k, \omega_k \in \mathbb{R}$. Note that $e^{\pm j 2k\pi} = 1$ for all $k = 1, 2, \dots$. Equation (26.1) is equivalent to the following set of equations:

$$e^{-h\sigma_k} = |\sigma_k + j\omega_k| \quad (26.22)$$

$$\pm(2k-1)\pi = h\omega_k + \angle(\sigma_k + j\omega_k), \quad k = 1, 2, \dots \quad (26.23)$$

It is quite interesting that for $h = 0$ there is only one root $r = -1$, but even for infinitesimally small $h > 0$ there are infinitely many roots. From the magnitude condition (26.22), it can be shown that

$$\sigma_k \geq 0 \Rightarrow |\omega_k| \leq 1 \quad (26.24)$$

Also, for $\sigma_k \geq 0$, the phase $\angle(\sigma_k + j\omega_k)$ is between $-\pi/2$ and $+\pi/2$, therefore (26.23) leads to

$$\sigma_k \geq 0 \Rightarrow h|\omega_k| \geq \frac{\pi}{2} \quad (26.25)$$

By combining (26.24) and (26.25), it can be proven that the feedback system has no roots in the closed right half plane when $h < \pi/2$. Furthermore, the system is unstable if $h \geq \pi/2$. In particular, for $h = \pi/2$ there are two roots on the imaginary axis, at $\pm j1$. It is also easy to show that, for any $h > 0$ as $k \rightarrow \infty$, the roots converge to

$$r_k \rightarrow \frac{1}{h} \left[-\ln\left(\frac{2k\pi}{h}\right) \pm j2k\pi \right]$$

As $h \rightarrow 0$, the magnitude of the roots converge to ∞ .

As illustrated by the above example, property (iii) implies that for any given real number σ there are only finitely many r_k 's in the region of the complex plane

$$\mathbb{C}_\sigma := \{s \in \mathbb{C} : \text{Re}(s) \geq \sigma\}$$

In particular, with $\sigma = 0$, this means that the quasi-polynomial $\chi(s)$ can have only finitely many roots in the right half plane. Since the effect of the closed-loop system poles that have very large negative real parts is negligible (as far as closed-loop systems' input–output behavior is concerned), only finitely many “dominant” roots r_k for $k = 1, \dots, m$, should be computed for all practical purposes.

Dominant Roots of a Quasi-Polynomial

Now we discuss the following problem: given $N(s)$, $D(s)$, and $h \geq 0$, find the dominant roots of the quasi-polynomial

$$\chi(s) = D(s) + e^{-hs}N(s)$$

For each fixed $h > 0$, it can be shown that there exists σ_{\max} such that $\chi(s)$ has no roots in the region $\mathbb{C}_{\sigma_{\max}}$, see [11] for a simple algorithm to estimate σ_{\max} , based on Nyquist criterion. Given $h > 0$ and a region of the complex plane defined by $\sigma_{\min} \leq \text{Re}(s) \leq \sigma_{\max}$, the problem is to find the roots of $\chi(s)$ in this region.

Clearly, a point $r = \sigma + j\omega$ in \mathbb{C} is a root of $\chi(s)$ if and only if

$$D(\sigma + j\omega) = -e^{-h\sigma} e^{-j\omega h} N(\sigma + j\omega)$$

Taking the magnitude square of both sides of the above equation, $\chi(r) = 0$ implies

$$A_\sigma(x) := D(\sigma + x)D(\sigma - x) - e^{-2h\sigma} N(\sigma + x)N(\sigma - x) = 0$$

where $x = j\omega$. The term $D(\sigma + x)$ stands for the function $D(s)$ evaluated at $\sigma + x$. The other terms of $A_\sigma(x)$ are calculated similarly. For each fixed σ , the function $A_\sigma(x)$ is a polynomial in the variable x . By symmetry, if x is a zero of $A_\sigma(\cdot)$, then $(-x)$ is also a zero.

If $A_\sigma(x)$ has a root x_ℓ whose real part is zero, set $r_\ell = \sigma + x_\ell$. Next, evaluate the magnitude of $\chi(r_\ell)$; if it is zero, then r_ℓ is a root of $\chi(s)$. Conversely, if $A_\sigma(x)$ has no root on the imaginary axis, then $\chi(s)$ cannot have a root whose real part is the fixed value of σ from which $A_\sigma(\cdot)$ is constructed.

Algorithm

Given $N(s)$, $D(s)$, h , σ_{\min} , and σ_{\max} :

Step 1. Pick σ values $\sigma_1, \dots, \sigma_M$ between σ_{\min} and σ_{\max} such that $\sigma_{\min} = \sigma_1$, $\sigma_i < \sigma_{i+1}$, and $\sigma_M = \sigma_{\max}$. For each σ_i perform the following.

Step 2. Construct the polynomial $A_i(x)$ according to

$$A_i(x) := D(\sigma_i + x)D(\sigma_i - x) - e^{-2h\sigma_i}N(\sigma_i + x)N(\sigma_i - x)$$

Step 3. For each imaginary axis roots x_ℓ of A_i , perform the following test:

Check if $|\chi(\sigma_i + x_\ell)| = 0$; if yes, then $r = \sigma_i + x_\ell$ is a root of $\chi(s)$; if not, discard x_ℓ .

Step 4. If $i = M$, stop; else increase i by 1 and go to Step 2.

Example

We will find the dominant roots of

$$1 + \frac{e^{-hs}}{s} = 0 \tag{26.26}$$

for a set of critical values of h . Recall that (26.26) has a pair of roots $\pm j1$ when $h = \pi/2 = 1.57$. Moreover, dominant roots of (26.26) are in the right half plane if $h > 1.57$, and they are in the left half plane if $h < 1.57$. So, it is expected that for $h \in (1.2, 2.0)$ the dominant roots are near the imaginary axis. Take $\sigma_{\min} = -0.5$ and $\sigma_{\max} = 0.5$, with $M = 400$ linearly spaced σ_i 's between them. In this case

$$A_i(x) = \sigma_i^2 - e^{-2h\sigma_i} - x^2$$

Whenever $e^{-2h\sigma_i} \geq \sigma_i^2$, $A_i(x)$ has two roots:

$$x_\ell = \pm j\sqrt{e^{-2h\sigma_i} - \sigma_i^2}, \quad \ell = 1, 2$$

For each fixed σ_i satisfying this condition, let $r_\ell = \sigma_i + x_\ell$ (note that x_ℓ is a function of σ_i , so r_ℓ is a function of σ_i) and evaluate

$$f(\sigma_i) := \left| 1 + \frac{e^{-hr_\ell}}{r_\ell} \right|$$

If $f(\sigma_i) = 0$, then r_ℓ is a root of (26.26). For 10 different values of $h \in (1.2, 2.0)$, the function $f(\sigma)$ is plotted in Fig. 26.19. This figure shows the feasible values of σ_i for which r_ℓ (defined from σ_i) is a root of (26.26).

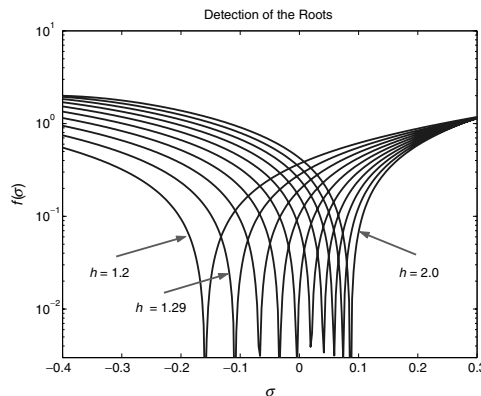

FIGURE 26.19 Detection of the dominant roots.

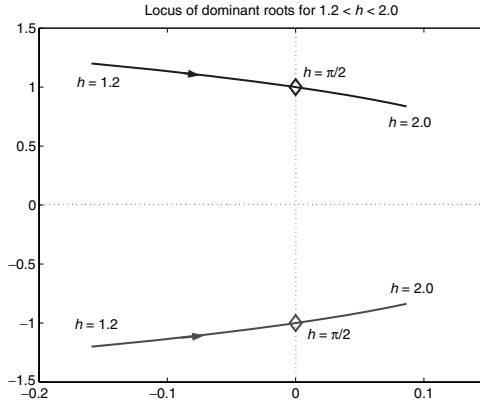

FIGURE 26.20 Dominant roots as h varies from 1.2 to 2.0.

The dominant roots of (26.26), as h varies from 1.2 to 2.0, are shown in Fig. 26.20. For $h < 1.57$, all the roots are in \mathbb{C}_- . For $h > 1.57$, the dominant roots are in \mathbb{C}_+ , and for $h = 1.57$, they are at $\pm j1$.

Root Locus Using Padé Approximations

In this section we assume that $h > 0$ is fixed and we try to obtain the root locus, with respect to uncertain/adjustable gain K , corresponding to the dominant poles. The problem can be solved by numerically calculating the dominant roots of the quasi-polynomial

$$\chi(s) = D(s) + KN(s)e^{-hs} \quad (26.27)$$

for varying K , by using the methods presented in the previous section. In this section an alternative method is given that uses Padé approximation of the time delay term e^{-hs} . More precisely, the idea is to find polynomials $N_h(s)$ and $D_h(s)$ satisfying

$$e^{-hs} \approx \frac{N_h(s)}{D_h(s)} \quad (26.28)$$

so that the dominant roots

$$D(s)D_h(s) + KN(s)N_h(s) = 0 \quad (26.29)$$

closely match the dominant roots of $\chi(s)$, (26.27). How should we do the approximation (26.28) for this match?

By using the stability robustness measures determined from the Nyquist stability criterion, we can show that for our purpose we may consider the following cost function in order to define a meaningful measure for the approximation error:

$$\Delta_h =: \sup_{\omega} \left| \frac{K_{\max} N(j\omega)}{D(j\omega)} \right| \left| e^{-jh\omega} - \frac{N_h(j\omega)}{D_h(j\omega)} \right|$$

where K_{\max} is the maximum value of interest for the uncertain/adjustable parameter K .

The ℓ th order Padé approximation is defined as follows:

$$N_h(s) = \sum_{k=0}^{\ell} (-1)^k c_k h^k s^k$$

$$D_h(s) = \sum_{k=0}^{\ell} c_k h^k s^k$$

where coefficients c_k 's are computed from

$$c_k = \frac{(2\ell - k)! \ell!}{2\ell! k! (\ell - k)!}, \quad k = 0, 1, \dots, \ell$$

First- and second-order approximations are in the form

$$\frac{N_h(s)}{D_h(s)} = \begin{cases} \frac{1 - hs/2}{1 + hs/2}, & \ell = 1 \\ \frac{1 - hs/2 + (hs)^2/12}{1 + hs/2 + (hs)^2/12}, & \ell = 2 \end{cases}$$

Given the problem data $\{h, K_{\max}, N(s), D(s)\}$, how do we find the smallest degree, ℓ , of the Padé approximation, so that $\Delta_h \leq \delta$ (or $\Delta_h/K_{\max} \leq \delta'$) for a specified error δ , or a specified relative error δ' ? The answer lies in the following result [7]: for a given degree of approximation ℓ we have

$$\left| e^{-j\omega} - \frac{N_h(j\omega)}{D_h(j\omega)} \right| \leq \begin{cases} 2 \left(\frac{eh\omega}{4\ell} \right)^{2\ell+1}, & \omega \leq \frac{4\ell}{eh} \\ 2, & \omega \geq \frac{4\ell}{eh} \end{cases}$$

In light of this result, we can solve the approximation order selection problem by using the following procedure:

1. Determine the frequency ω_x such that

$$\left| \frac{K_{\max} N(j\omega)}{D(j\omega)} \right| \leq \frac{\delta}{2}, \quad \text{for all } \omega \geq \omega_x$$

and initialize $\ell = 1$.

2. For each $\ell \geq 1$ define

$$\omega_{\ell} = \max \left\{ \omega_x, \frac{4\ell}{eh} \right\}$$

and plot the function

$$\Phi_{\ell}(\omega) := \begin{cases} 2 \left| \frac{K_{\max} N(j\omega)}{D(j\omega)} \right| \left(\frac{eh\omega}{4\ell} \right)^{2\ell+1}, & \text{for } \omega \leq \frac{4\ell}{eh} \\ 2 \left| \frac{K_{\max} N(j\omega)}{D(j\omega)} \right|, & \text{for } \omega_{\ell} \geq \omega \geq \frac{4\ell}{eh} \end{cases}$$

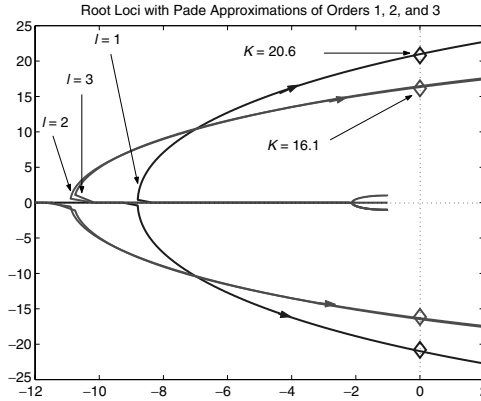

FIGURE 26.21 Dominant root for $\ell = 1$.

3. Check If

$$\max_{\omega \in [0, \omega_x]} \Phi_\ell(\omega) \leq \delta \quad (26.30)$$

If yes, stop, this value of ℓ satisfies the desired error bound: $\Delta_h \leq \delta$. Otherwise, increase ℓ by 1, and go to Step 2. Note that the left-hand side of the inequality (26.30) is an upper bound of Δ_h .

Since we assumed $\deg(D) > \deg(N)$, the algorithm will pass Step 3 eventually for some finite $\ell \geq 1$. At each iteration, we have to draw the error function $\Phi_\ell(\omega)$ and check whether its peak value is less than δ . Typically, as δ decreases, ω_x increases, and that forces ℓ to increase. On the other hand, for very large values of ℓ , the relative magnitude c_0/c_ℓ of the coefficients becomes very large, in which case numerical difficulties arise in analysis and simulations. Also, as time delay h increases, ℓ should be increased to keep the level of the approximation error δ fixed. This is a fundamental difficulty associated with time delay systems.

Example

Let $N(s) = s + 1$, $D(s) = s^2 + 2s + 2$ and $h = 0.1$, and $K_{\max} = 20$. Then, for $\delta' = 0.05$, applying the above procedure we calculate $\ell = 2$ as the smallest approximation degree satisfying $\Delta_h/K_{\max} < \delta'$. Therefore, a second-order approximation of the time delay should be sufficient for predicting the dominant poles for $K \in [0, 20]$. Figure 26.21 shows the approximate root loci obtained from Padé approximations of degrees $\ell = 1, 2, 3$. There is a significant difference between the root loci for $\ell = 1$ and $\ell = 2$. In the region $\text{Re}(s) \geq -12$, the predicted dominant roots are approximately the same for $\ell = 2, 3$, for $K \in [0, 20]$. So, we can safely say that using higher order approximations will not make any significant difference as far as predicting the behavior of the dominant poles for the given range of K .

26.6 Notes and References

This chapter in the handbook is an edited version of related parts of the author's book [9]. More detailed discussions of the root locus method can be found in all the classical control books, such as [2, 5, 6, 8]. As mentioned earlier, extension of this method to discrete time systems is rather trivial: the method to find the roots of a polynomial as a function of a varying real parameter is independent of the variable s (in the continuous time case) or z (in the discrete time case). The only difference between these two cases is the definition of the desired region of the complex plane: for the continuous time systems, this is defined relative to the imaginary axis, whereas for the discrete time systems the region is defined with respect to the unit circle, as illustrated in Fig. 26.6.

References

1. Bellman, R. E., and Cooke, K. L., *Differential Difference Equations*, Academic Press, New York, 1963.
2. Dorf, R. C., and Bishop, R. H., *Modern Control Systems*, 9th ed., Prentice-Hall, Upper Saddle River, NJ, 2001.
3. Evans, W. R., "Graphical analysis of control systems," *Transac. Amer. Inst. Electrical Engineers*, vol. 67 (1948), pp. 547–551.
4. Evans, W. R., "Control system synthesis by root locus method," *Transac. Amer. Inst. Electrical Engineers*, vol. 69 (1950), pp. 66–69.
5. Franklin, G. F., Powell, J. D., and Emami-Naeini, A., *Feedback Control of Dynamic Systems*, 3rd ed., Addison Wesley, Reading, MA, 1994.
6. Kuo, B. C., *Automatic Control Systems*, 7th ed., Prentice-Hall, Upper Saddle River, NJ, 1995.
7. Lam, J., "Convergence of a class of Padé approximations for delay systems," *Int. J. Control*, vol. 52 (1990), pp. 989–1008.
8. Ogata, K., *Modern Control Engineering*, 3rd ed., Prentice-Hall, Upper Saddle River, NJ, 1997.
9. Özbay, H., *Introduction to Feedback Control Theory*, CRC Press LLC, Boca Raton, FL, 2000.
10. Stepan, G., *Retarded Dynamical Systems: Stability and Characteristic Functions*, Longman Scientific & Technical, New York, 1989.
11. Ulus, C., "Numerical computation of inner-outer factors for a class of retarded delay systems," *Int. J. Systems Sci.*, vol. 28 (1997), pp. 897–904.

27

Frequency Response Methods

- 27.1 Introduction
- 27.2 Bode Plots
- 27.3 Polar Plots
- 27.4 Log-Magnitude Versus Phase plots
- 27.5 Experimental Determination of Transfer Functions
- 27.6 The Nyquist Stability Criterion
- 27.7 Relative Stability

Jyh-Jong Sheen
National Taiwan Ocean University

27.1 Introduction

The analysis and design of industrial control systems are often accomplished utilizing frequency response methods. By the term frequency response, we mean the steady-state response of a linear constant coefficient system to a sinusoidal input test signal. We will see that the response of the system to a sinusoidal input signal is also a sinusoidal output signal at the same frequency as the input. However, the magnitude and phase of the output signal differ from those of the input signal, and the amount of difference is a function of the input frequency. Thus, we will be investigating the relationship between the transfer function and the frequency response of linear stable systems.

Consider a stable linear constant coefficient system shown in Fig. 27.1. Using Euler's formula, $e^{j\omega t} = \cos \omega t + j \sin \omega t$, let us assume that the input sinusoidal signal is given by

$$u(t) = U_0 e^{j\omega t} = U_0 \cos \omega t + j U_0 \sin \omega t \quad (27.1)$$

Taking the Laplace transform of $u(t)$ gives

$$U(s) = \frac{U_0}{s - j\omega} = U_0 \frac{s + j\omega}{s^2 + \omega^2} = \frac{U_0 s}{s^2 + \omega^2} + j \frac{U_0 \omega}{s^2 + \omega^2} \quad (27.2)$$

The first term in Eq. (27.2) is the Laplace transform of $U_0 \cos \omega t$, while the second term, without the imaginary number j , is the Laplace transform of $U_0 \sin \omega t$.

Suppose that the transfer function $G(s)$ can be written as

$$G(s) = \frac{n(s)}{d(s)} = \frac{n(s)}{(s + p_1)(s + p_2) \cdots (s + p_n)} \quad (27.3)$$

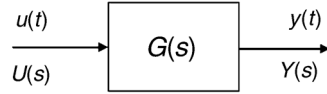

FIGURE 27.1 A stable linear constant coefficient system.

where $p_i, i = 1, 2, \dots, n$, are assumed to be distinct poles. The Laplace transform of the output $Y(s)$ is then

$$Y(s) = G(s)U(s) = G(s)\frac{U_0}{s - j\omega} \quad (27.4)$$

Taking the partial fraction expansion of $Y(s)$ gives

$$Y(s) = \frac{k_1}{s + p_1} + \dots + \frac{k_n}{s + p_n} + \frac{\alpha}{s - j\omega} \quad (27.5)$$

The coefficient α can be determined by

$$\alpha = [(s - j\omega)Y(s)]|_{s=j\omega} = [U_0G(s)]|_{s=j\omega} = U_0G(j\omega)$$

Therefore, the inverse Laplace transform of $Y(s)$ yields

$$y(t) = k_1e^{-p_1t} + \dots + k_n e^{-p_nt} + U_0G(j\omega)e^{j\omega t}, \quad t \geq 0 \quad (27.6)$$

For a stable system, all $-p_i$ have negative nonzero real parts and, therefore, all the terms $k_i e^{-p_i t}$, $i = 1, 2, \dots, n$, approach zero as t approaches infinity. Thus, at steady state, the output $y(t)$ becomes

$$y_{ss}(t) = \lim_{t \rightarrow \infty} y(t) = U_0G(j\omega)e^{j\omega t} = U_0|G(j\omega)|e^{j(\omega t + \phi)} \quad (27.7)$$

The sinusoidal transfer function, $G(j\omega)$, is written in exponential form

$$G(j\omega) = |G(j\omega)|e^{j\phi}$$

where

$$|G(j\omega)| = \sqrt{\{\text{Re}[G(j\omega)]\}^2 + \{\text{Im}[G(j\omega)]\}^2} \quad (27.8a)$$

and

$$\phi = \angle G(j\omega) = \tan^{-1} \frac{\text{Im}[G(j\omega)]}{\text{Re}[G(j\omega)]} \quad (27.8b)$$

Equation (27.7) shows that for a stable system subject to a sinusoidal input, the steady-state response is a sinusoidal output of the same frequency as the input. The amplitude of the output is that of the input times $|G(j\omega)|$, and the phase angle differs from that of the input by the amount $\phi = \angle G(j\omega)$.

Example 1

A first-order low-pass filter is shown in Fig. 27.2. The transfer function of this filter is

$$G(s) = \frac{V_o(s)}{V_i(s)} = \frac{1}{RCs + 1}$$

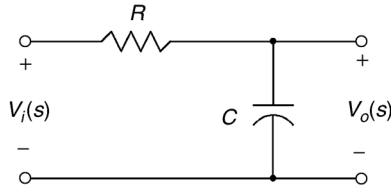

FIGURE 27.2 A first-order low-pass filter.

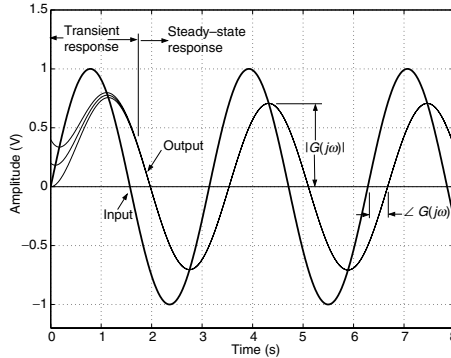

FIGURE 27.3 Frequency response of $G(s) = 1/(0.5s + 1)$ to $u(t) = \sin 2t$.

The sinusoidal transfer function is given by

$$G(j\omega) = \frac{1}{j\omega(RC) + 1} = \frac{1}{j(\omega/\omega_1) + 1}$$

where $\omega_1 = 1/RC$. The magnitude and phase angle of the frequency response are

$$|G(j\omega)| = \frac{1}{\sqrt{1 + (\omega/\omega_1)^2}} \quad \text{and} \quad \phi(\omega) = -\tan^{-1} \frac{\omega}{\omega_1}$$

Figure 27.3 shows the response of the system with $RC = 0.5$ to the input $u = \sin 2t$. It can be seen that the steady-state response is irrelevant to the initial conditions, and the steady-state amplitude of the output is $1/\sqrt{2}$ and the phase angle is -45° .

27.2 Bode Plots

There are three commonly used displays of frequency response of a system. They are:

1. the Bode diagram or logarithmic plot,
2. the polar plot, and
3. the log-magnitude versus phase plot or Nichols chart.

We will present Bode diagrams of sinusoidal transfer functions in this section, followed by the sections on polar plots and log-magnitude versus phase plots.

The main advantages in using the logarithmic plot are the capability of plotting low and high frequency characteristics of the transfer function in one diagram, and the relative ease of adding the separate terms

of a high-order transfer function graphically. The basic types of factors that may occur in a transfer function are as follows:

1. constant gain K ,
2. poles (or zeros) at the origin $(j\omega)^{\pm n}$,
3. poles (or zeros) on the real axis $(j\omega\tau + 1)^{\pm 1}$, and
4. complex conjugate poles (or zeros) $[(j\omega/\omega_n)^2 + 2\zeta(j\omega/\omega_n) + 1]^{\pm 1}$.

The curves of logarithmic magnitude and phase angle for these four factors can easily be drawn and then added together graphically to obtain the curves for the complete transfer function. The process of drawing the logarithmic plot can be further simplified by using asymptotic approximations to these curves and obtaining the actual curves at specific important frequencies.

Constant Gain K

The logarithmic gain for the constant gain K is

$$20 \log|K| = \text{constant in decibel}, \quad \angle K = \begin{cases} 0^\circ, & \text{if } K > 0 \\ -180^\circ, & \text{if } K < 0 \end{cases}$$

The gain and phase curves are simply horizontal lines on the Bode diagram.

Poles (or Zeros) at the Origin $(j\omega)^{\pm n}$

Since

$$20 \log|j\omega|^{\pm n} = \pm 20n \log \omega, \quad \angle(j\omega)^{\pm n} = \pm n \times 90^\circ$$

the slopes of the magnitude curves are $\pm 20n$ dB/decade for the factor $(j\omega)^{\pm n}$ and the phase angles are constants equal to $\pm n \times 90^\circ$.

Poles (or Zeros) on the Real Axis $(j\omega\tau + 1)^{\pm 1}$

For a pole factor $(j\omega\tau + 1)^{-1}$,

$$\left| \frac{1}{j\omega\tau + 1} \right| = \frac{1}{\sqrt{\omega^2 \tau^2 + 1}}$$

The magnitude of the pole factor is 1 when $\omega \ll 1/\tau$, and $1/(\omega\tau)$ when $\omega \gg 1/\tau$. Thus, there are two asymptotic curves for the pole factor,

$$20 \log \left| \frac{1}{j\omega\tau + 1} \right| \approx \begin{cases} 0 \text{ dB}, & \text{when } \omega \ll \frac{1}{\tau} \\ -20 \log \omega\tau = -20 \left(\log \omega - \log \frac{1}{\tau} \right), & \text{when } \omega \gg \frac{1}{\tau} \end{cases}$$

The slope of the asymptotic curve when $\omega \gg 1/\tau$ is -20 dB/decade for the pole factor. The two asymptotes intersect at $\omega = 1/\tau$, the break frequency or the corner frequency. The actual logarithmic gain at $\omega = 1/\tau$ is -3 dB. The phase angle is $\phi(\omega) = -\tan^{-1} \omega\tau$.

The Bode diagram of a zero factor $(j\omega\tau + 1)$ is obtained in the same manner. However, the slope of the magnitude asymptotic curve when $\omega \gg 1/\tau$ is $+20$ dB/decade, and the phase angle is $\phi(\omega) = +\tan^{-1} \omega\tau$. The Bode diagrams of first-order factors are shown in Fig. 27.4. Linear approximations to the phase angle curves are also presented.

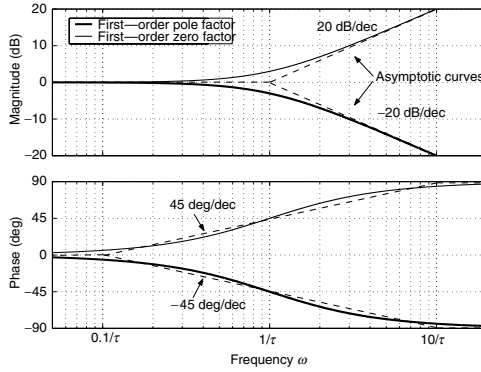

FIGURE 27.4 Bode diagrams for the first-order factors $(j\omega\tau + 1)^{\pm 1}$.

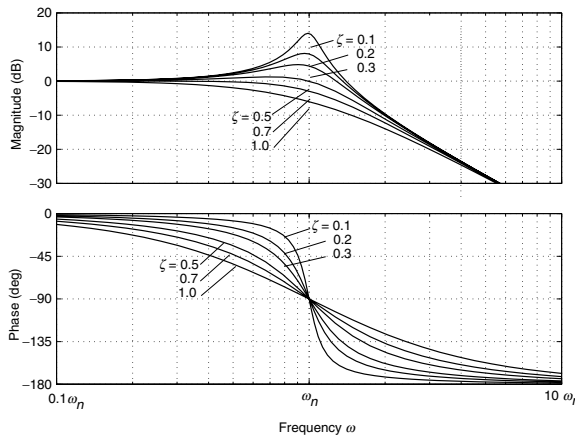

FIGURE 27.5 Bode diagram for the quadratic pole factor $[(j\omega/\omega_n)^2 + 2\zeta(j\omega/\omega_n) + 1]^{-1}$.

Complex Conjugate Poles (or Zeros) $[(j\omega/\omega_n)^2 + 2\zeta(j\omega/\omega_n) + 1]^{\pm 1}$

The magnitude and phase angle of the complex conjugate poles $[(j\omega/\omega_n)^2 + 2\zeta(j\omega/\omega_n) + 1]^{-1}$ are

$$\left| \left(j \frac{\omega}{\omega_n} \right)^2 + 2\zeta \left(j \frac{\omega}{\omega_n} \right) + 1 \right|^{-1} = \left[\left(1 - \frac{\omega^2}{\omega_n^2} \right)^2 + \left(2\zeta \frac{\omega}{\omega_n} \right)^2 \right]^{-1/2}$$

$$\angle \left[\left(j \frac{\omega}{\omega_n} \right)^2 + 2\zeta \left(j \frac{\omega}{\omega_n} \right) + 1 \right]^{-1} = -\tan^{-1} \frac{2\zeta\omega/\omega_n}{1 - \omega^2/\omega_n^2}$$

The magnitude of the complex conjugate pole factor is 1 when $\omega \ll \omega_n$, and $(\omega/\omega_n)^{-2}$ when $\omega \gg \omega_n$. Therefore, the two asymptotic curves for the complex conjugate pole factor are

$$20 \log \left| \left(j \frac{\omega}{\omega_n} \right)^2 + 2\zeta \left(j \frac{\omega}{\omega_n} \right) + 1 \right|^{-1} \approx \begin{cases} 0 \text{ dB,} & \text{when } \omega \ll \omega_n \\ -40(\log \omega - \log \omega_n), & \text{when } \omega \gg \omega_n \end{cases}$$

The slope of the asymptotic curve when $\omega \gg \omega_n$ is -40 dB/decade for the complex conjugate pole factor. The magnitude asymptotes intersect at $\omega = \omega_n$, the natural frequency. The actual gain at $\omega = \omega_n$ is $G(j\omega_n) = 1/2\zeta$. The Bode diagram of a complex conjugate pole factor is shown in Fig. 27.5. It is seen from Fig. 27.5 that the

difference between the actual magnitude curve and the asymptotic approximation is a function of damping ratio. The resonant frequency ω_r is defined as the frequency where the peak value of the frequency response M_r occurs. When the damping ratio approaches zero, ω_r approaches ω_n . The resonant frequency can be determined by taking the derivative of the magnitude with respect to the frequency, and setting it equal to zero. The resonant frequency and the peak value of the magnitude are represented by

$$\omega_r = \omega_n \sqrt{1 - 2\zeta^2}, \quad \zeta < 0.707 \quad (27.9a)$$

and

$$M_r = \frac{1}{2\zeta\sqrt{1 - \zeta^2}}, \quad \zeta < 0.707 \quad (27.9b)$$

Example 2

Let us consider the transfer function

$$G(s) = \frac{10(s/5 + 1)}{s(s + 1)[(s/10)^2 + (s/10) + 1]}$$

We first list the basic factors of $G(s)$ in Table 27.1 in the order of increasing corner or natural frequencies.

The complete asymptotic magnitude curve for $G(j\omega)$ is produced by adding together the asymptotic logarithmic magnitudes of each factor, as shown by the solid line in Fig. 27.6. Since the dc gain of each factor is 1, these factors have no effect on the asymptotic magnitude until the frequency approaches their corner or natural frequencies. Thus, the asymptotic magnitude can be quickly obtained by plotting each asymptote in order as frequency increases. The asymptotic curve intersects 20 dB at $\omega = 1$ with the slope -20 dB/decade due to the pole at the origin and the constant gain $K = 10$. At $\omega = 1$ the slope further decreases to -40 dB/decade due to the pole at $\omega = 1$. Then at $\omega = 5$ the slope increases to -20 dB/decade

TABLE 27.1 The Basic Factors of $G(j\omega)$

| Type of Factors | Constant Gain | Pole | Pole | Zero | Complex Poles |
|------------------|---------------|------|------|------|---------------|
| Corner frequency | $K = 10$ | 0 | 1 | 5 | 10 |
| Order | 0 | -1 | -1 | +1 | -2 |

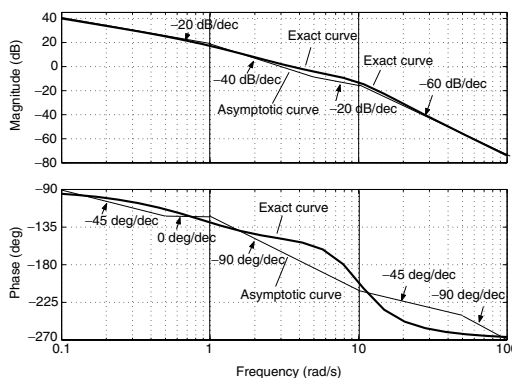

FIGURE 27.6 The Bode plot of the transfer function in Example 2.

due to the zero at $\omega = 5$. Finally at $\omega = 10$ the slope becomes -60 dB/decade due to the complex conjugate poles at $\omega_n = 10$.

The exact magnitude is obtained by calculating the actual magnitude at important frequencies such as the corner or natural frequencies of each factor. The phase curve can be obtained by adding the phase due to each factor. Although the linear approximation of the phase characteristic for a single pole or zero is suitable for initial analysis, the error between the exact phase curve and the linear approximation of complex conjugate poles can be large, as seen in Fig. 27.6. Hence, if the accurate phase angle curve is required, a computer program such as Matlab or Ctrl-C can be utilized to generate the actual phase curve.

27.3 Polar Plots

The polar plot of a sinusoidal transfer function $G(j\omega)$ is a plot of both the magnitude and the phase of the frequency response in polar coordinates as the frequency ω varies from zero to infinity. Since the sinusoidal transfer function $G(j\omega)$ can be expressed as

$$G(j\omega) = \text{Re}[G(j\omega)] + j \text{Im}[G(j\omega)] = |G(j\omega)|e^{j\phi}$$

the polar plot of $G(j\omega)$ is a plot of $\text{Re}[G(j\omega)]$ on the horizontal axis versus $\text{Im}[G(j\omega)]$ on the vertical axis in the complex $G(s)$ -plane as ω varies from zero to infinity. Hence, for each value of ω , a polar plot of $G(j\omega)$ is defined by a vector of length $|G(j\omega)|$ and a phase angle $\phi = \angle G(j\omega)$, as in Eq. (27.8).

We can investigate the general shapes of polar plots according to the system types and relative degrees of transfer functions. Relative degree of a transfer function is defined as the difference between the degree of the denominator polynomial and that of the numerator. Consider a transfer function of the form

$$\begin{aligned} G(j\omega) &= \frac{K(1 + j\omega\tau_a)(1 + j\omega\tau_b)\cdots}{(j\omega)^N(1 + j\omega\tau_1)(1 + j\omega\tau_2)\cdots} \\ &= \frac{b_0(j\omega)^m + b_1(j\omega)^{m-1} + \cdots}{a_0(j\omega)^n + b_1(j\omega)^{n-1} + \cdots} \end{aligned}$$

where $K > 0$ and the relative degree $n - m \geq 0$. The magnitudes and phase angles of $G(j\omega)$ as ω approaches zero and infinity are presented in Table 27.2. The general shapes of the polar plots of various system types in the low-frequency portion are shown in Fig. 27.7. The high-frequency portions of the polar plots of various relative degrees are shown in Fig. 27.8. It can be seen that the $G(j\omega)$ loci are parallel to either the horizontal or the vertical axes with infinite magnitude as $\omega \rightarrow 0^+$ for system types greater than zero. If the relative degree is greater than zero, the $G(j\omega)$ loci converge to the origin clockwise and are tangent to one or the other axes. Note that the polar plot curves can be very complicated due to the numerator and denominator dynamics over the intermediate frequency range. Therefore, the polar plot of $G(j\omega)$ in the frequency range of interest must be accurately determined.

TABLE 27.2 $G(j\omega)$ vs. System Type and Relative Degree as $\omega \rightarrow 0^+$ and ∞

| System Type | $\omega \rightarrow 0^+$ | Relative Degree | $\omega \rightarrow \infty$ |
|-------------|----------------------------|-----------------|-----------------------------|
| N | | $n - m$ | |
| 0 | $K \angle 0^\circ$ | 0 | $b_0/a_0 \angle 0^\circ$ |
| 1 | $\infty \angle -90^\circ$ | 1 | $0 \angle -90^\circ$ |
| 2 | $\infty \angle -180^\circ$ | 2 | $0 \angle -180^\circ$ |
| 3 | $\infty \angle -270^\circ$ | 3 | $0 \angle -270^\circ$ |

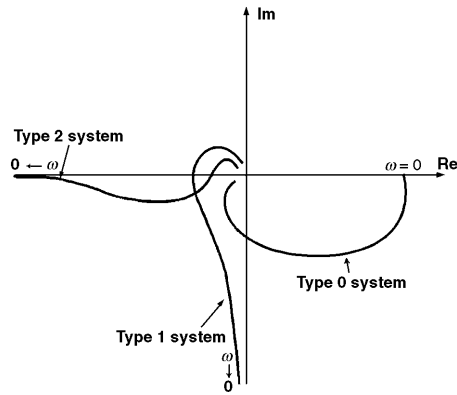

FIGURE 27.7 Polar plots of system with various system types as $\omega \rightarrow 0$.

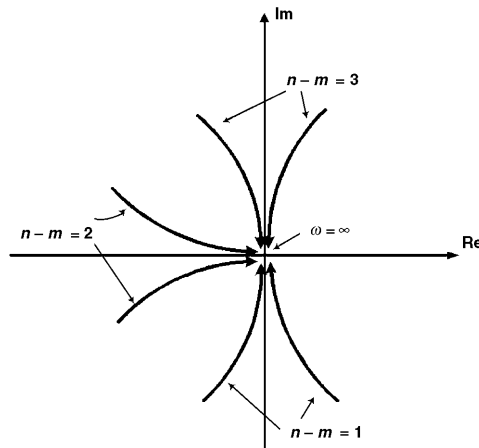

FIGURE 27.8 Polar plots of system with various relative degrees as $\omega \rightarrow \infty$.

We will see that for a closed-loop system, the polar plot of the loop transfer function is useful in determining the stability of the system. The polar plots of some simple systems are shown in Fig. 27.9.

27.4 Log-Magnitude Versus Phase Plots

Another approach to presenting the frequency response of a system by a single graph is to plot its logarithmic magnitude versus the phase angle over a frequency range of interest. The resulting curve is a function of the frequency ω . Such log-magnitude versus phase plots are called Nichols charts.

Advantages of the Nichols chart are that the relative stability of the closed-loop system can be determined quickly and that the process of closed-loop compensation can be carried out easily. The Nichols charts of the systems in Fig. 27.9 are depicted in Fig. 27.10 for comparison. Figure 27.11 displays three different frequency-response curves of the second-order system

$$G(s) = \frac{\omega_n^2}{s^2 + 2\zeta\omega_n s + \omega_n^2}$$

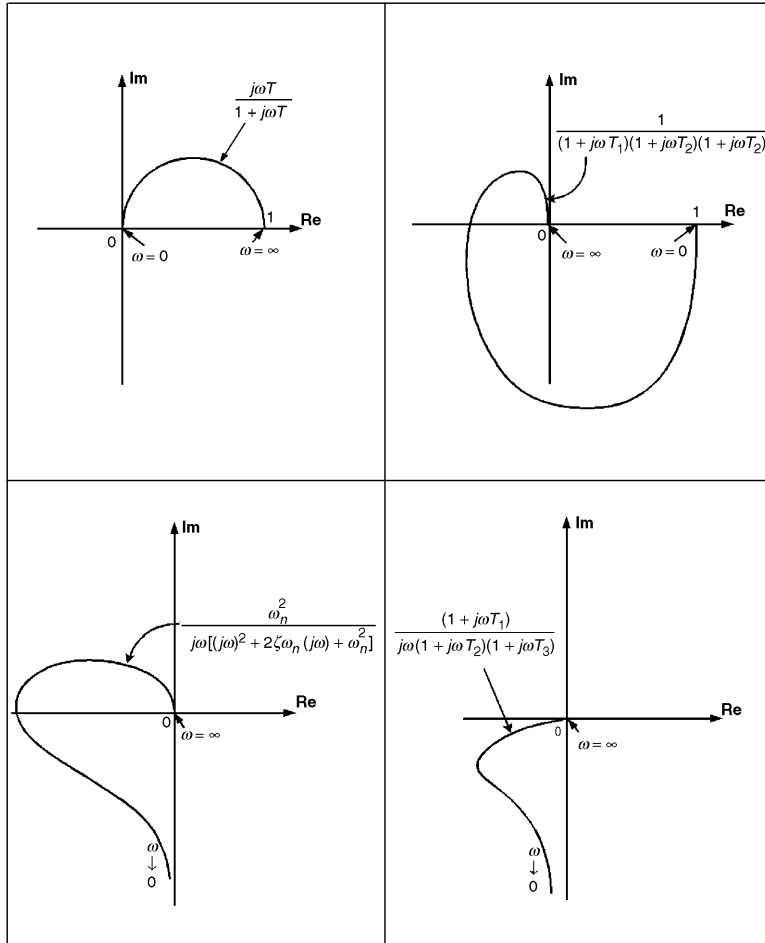

FIGURE 27.9 Polar plots of simple transfer functions.

27.5 Experimental Determination of Transfer Functions

We can obtain a transfer function model from frequency-response measurements of a stable system. First, the Bode diagram of the frequency response is plotted from the measurements. Then the open-loop transfer function can be deduced from the magnitude and phase plots based on the relationships of the basic pole and zero factors.

A wave analyzer is a device to measure the amplitudes and phases of the steady-state response as the frequency of the input sinusoidal wave is altered. A transfer function analyzer can be used to measure the open-loop and closed-loop transfer functions.

We will use a computer program combined with an analog-to-digital and digital-to-analog (AD and DA) card to generate the sinusoidal input signal and to measure the frequency response of a system. Consider the second-order Sallen-Key low-pass filter in Fig. 27.12. The transfer function of the filter is given by

$$G(s) = \frac{V_o(s)}{V_i(s)} = \frac{K}{s^2/\omega_n^2 + 2\zeta(s/\omega_n) + 1} \quad (27.10)$$

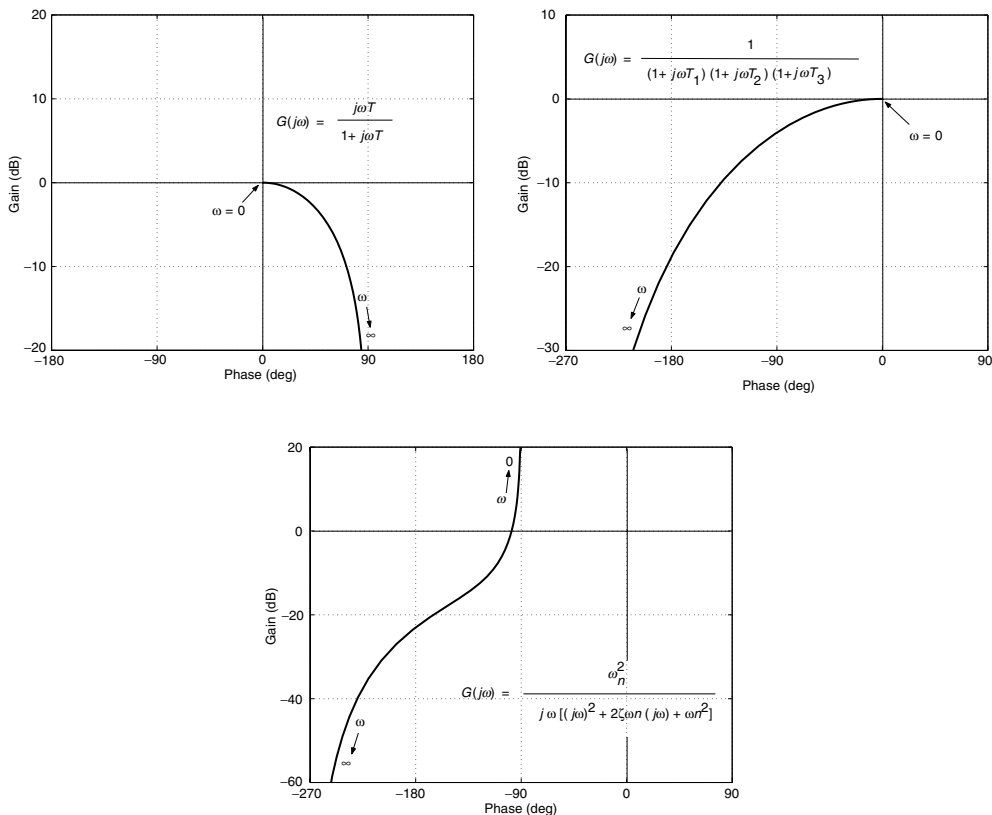

FIGURE 27.10 Nichols charts of simple transfer functions.

where

$$K = \frac{R_1 + R_2}{R_2}, \quad \omega_n = \frac{1}{\sqrt{R_A R_B C_A C_B}}$$

and

$$\zeta = \frac{1}{2} \left[\sqrt{\frac{C_B R_A + R_B}{C_A \sqrt{R_A R_B}}} + (1 - K) \sqrt{\frac{R_A C_A}{R_B C_B}} \right]$$

The Real-Time Windows Target in Matlab is used with an Advantech PCL-818L AD and DA card. The sampling time is 0.001 s. The measured magnitudes and phase angles are shown in Fig. 27.13. From the Bode plot, we can find that the dc gain is equal to 1.995 and the natural frequency $\omega_n = 17.90$ rad/s. From Eq. (27.9b) and $M_r = 1.993$, we have $\zeta = 0.26$.

An alternative to estimating the transfer function is to use an excitation signal that is sufficiently rich in the frequency contents of interest and to measure the corresponding output. System identification technique is then applied to find the order and parameters of the transfer function. Suitable excitation signals are the impulse signal, sweep sine signal, random sequence, and so forth. Figure 27.14 presents the sweep sine input and the corresponding output. The Matlab System Identification Toolbox is then

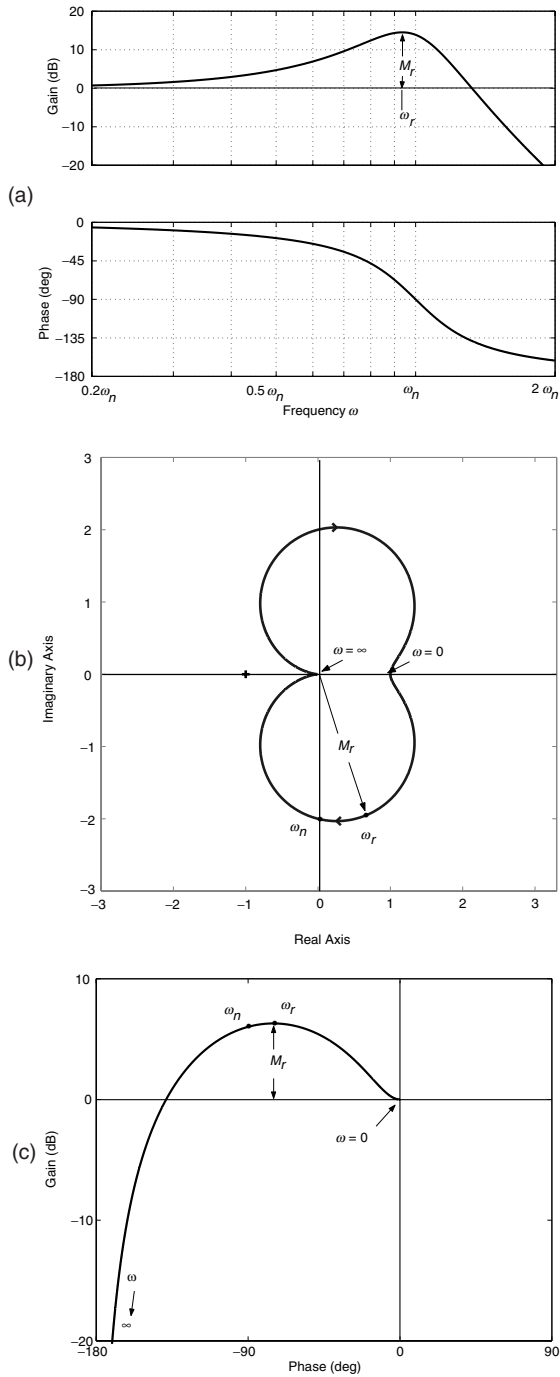

FIGURE 27.11 Three frequency response representations of $G(s) = \omega_n^2 / (s^2 + 2\zeta\omega_n s + \omega_n^2)$: (a) Bode diagram, (b) polar plot, and (c) Nichols chart.

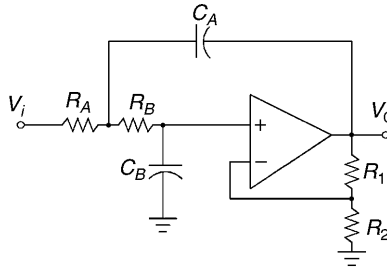

FIGURE 27.12 Sallen-Key low-pass filter.

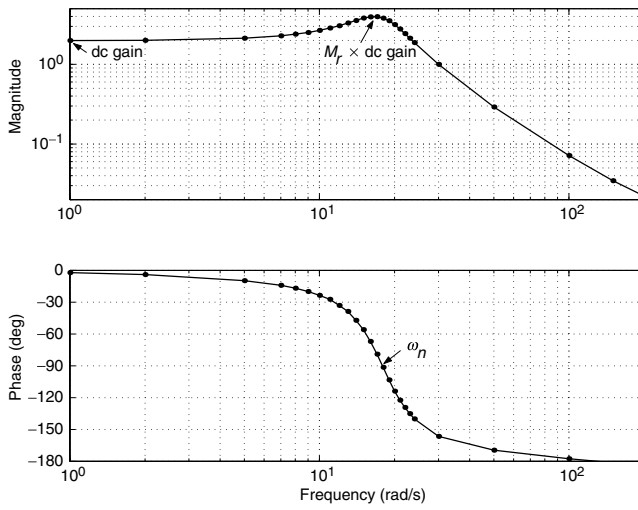

FIGURE 27.13 Frequency response of the Sallen-Key filter from experimental data.

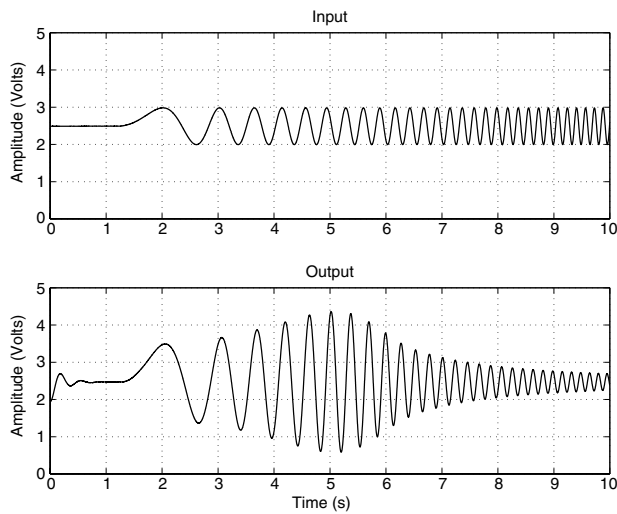

FIGURE 27.14 Sweep sine response of the Sallen-Key filter.

TABLE 27.3 Estimated Transfer Functions for the Second-Order Low-Pass Filter

| |
|---|
| 1. Ideal op-amp circuit: $G(s) = \frac{1.997}{(s/18.09)^2 + 2 \times 0.271(s/18.09) + 1}$ |
| where the measured values of resistors and capacitors are substituted in Eq. (27.10) with $R_1 = 98.4 \text{ k}\Omega$, $R_2 = 98.7 \text{ k}\Omega$, $R_A = 51.3 \text{ k}\Omega$, $R_B = 98.5 \text{ k}\Omega$, $C_A = 1.083 \text{ }\mu\text{F}$, and $C_B = 0.564 \text{ }\mu\text{F}$. |
| 2. From the Bode plot: $G(s) = \frac{1.995}{(s/17.90)^2 + 2 \times 0.259(s/17.90) + 1}$ |
| 3. System identification: $G(s) = \frac{1.997}{(s/17.78)^2 + 2 \times 0.255(s/17.78) + 1}$ |

utilized to estimate the transfer function. The resulting transfer functions from the ideal op-amp circuit in Eq.(27.10), the Bode plot, and system identification are shown in Table 27.3 for comparison. It is seen that the differences among the three transfer functions are very small. However, the task of determining transfer functions from Bode plots can be very difficult as various pole or zero factors of close corner frequencies can complicate the magnitude and phase plots for high-order systems. Thus, it is recommended that system identification technique be used for determination of high-order transfer functions.

27.6 The Nyquist Stability Criterion

The Nyquist stability criterion provides a graphical procedure for determining the closed-loop stability from the open-loop frequency-response curves. The criterion is based on a result from complex variables theory known as the argument principle, due to Cauchy.

Suppose $F(s)$ is a rational function of s with real coefficients that are analytic everywhere in the s -plane except at its poles. Let Γ_s be a closed, clockwise contour in the s -plane that does not pass through any zeros or poles of $F(s)$. The contour map Γ_F is defined by substituting the values of s on the contour Γ_s for s in $F(s)$. The resulting map is also a closed continuous contour in the $F(s)$ -plane. The principle of the argument can be stated as follows:

A contour map Γ_F of a complex function $F(s)$ defined on Γ_s in the s -plane will only encircle the origin of the $F(s)$ -plane if the contour contains a pole or zero of the function. The net number that Γ_F encircles the origin in the clockwise direction is

$$N = Z - P \tag{27.11}$$

where Z and P are, respectively, the numbers of zeros and poles of $F(s)$ enclosed by a closed clockwise contour Γ_s in the s -plane.

Example 3

To illustrate the argument principle, consider a rational function

$$F(s) = \frac{(s + 3)(s + 4)}{(s + 1)(s + 2)}$$

which has zeros at $s = -3, -4$ and poles at $s = -1, -2$. The various contour maps of $F(s)$ are shown in Fig. 27.15, where Γ_r denotes the contour map of a clockwise circular contour of radius r in the s -plane. We have the following observations from Fig. 27.15:

1. The contour map $\Gamma_{0.5}$ does not encircle the origin of the $F(s)$ -plane as the contour in the s -plane does not encircle any pole or zero.
2. $\Gamma_{1.99}$ encircles the origin once in the counterclockwise direction as the contour encircles the pole at $s = -1$ in the clockwise direction in the s -plane, and from Eq. (27.11), $N = Z - P = 0 - 1 = -1$. Note that $\Gamma_{1.99}$ is a closed contour with two loops and only the one encircling the origin is shown in Fig. 27.15.

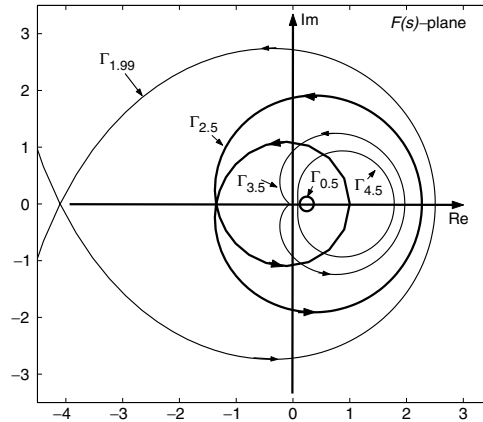

FIGURE 27.15 The contour maps of $F(s)$ in Example 3.

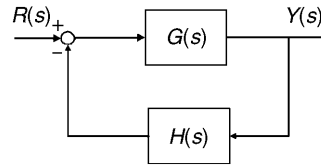

FIGURE 27.16 Closed-loop system.

3. $\Gamma_{2.5}$ encircles the origin twice in the counterclockwise direction as the contour contains two poles at $s = -1, -2$ and $N = Z - P = 0 - 2 = -2$.
4. When the radius of the contour is increased to contain the poles at $s = -1, -2$ and the zero at $s = -3$, then $N = Z - P = 1 - 2 = -1$ and a contour map like $\Gamma_{3.5}$ encircles the origin once in the counterclockwise direction.
5. When the radius of the contour is further increased to encircle the two poles and two zeros, then $N = 2 - 2 = 0$ and the contour map like $\Gamma_{4.5}$ does not encircle the origin.

We now apply Cauchy's principle of argument to develop the Nyquist stability criterion. Suppose that the characteristic equation of the closed-loop system in Fig. 27.16 is

$$F(s) = 1 + G(s)H(s) = 0$$

Let $L(s) = G(s)H(s)$, the loop transfer function. Using the argument principle, let us assume that none of the poles or zeros of $F(s)$ lie on the imaginary axis in the s -plane. We now define the Nyquist path, Γ_s , that is composed of the imaginary axis and a semicircle of infinite radius. This contour completely encloses the entire complex right-half plane as depicted in Fig. 20.17(a). The corresponding contour map Γ_F is shown in Fig. 27.17(b). It follows from the argument principle that N corresponds to the net number of clockwise encirclements of the origin of the $1 + L(s)$ -plane by Γ_F . P is the number of poles of $F(s)$ in the right-half s -plane and thus is the number of poles of the loop transfer function $L(s)$ in the right-half s -plane. Z is the number of zeros of the characteristic equation $F(s)$ of the closed-loop system in the right-half s -plane. Therefore, Z must be zero for the closed-loop system to be stable.

In practice, a modification is made to simplify the application of the Nyquist criterion. Instead of plotting Γ_F in the $1 + L(s)$ -plane, we plot just $L(s)$ evaluated along the contour Γ_s . The resulting contour map Γ_L is in the $L(s)$ -plane and has the same shape as Γ_F but is shifted 1 unit to the left, as shown in Fig. 27.17(c). It thus follows that N is the net number of encirclements of the -1 point in the $L(s)$ -plane.

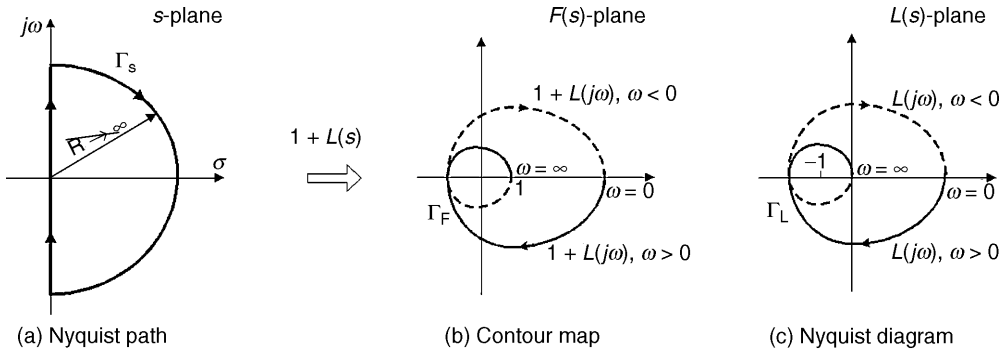

FIGURE 27.17 Nyquist diagram.

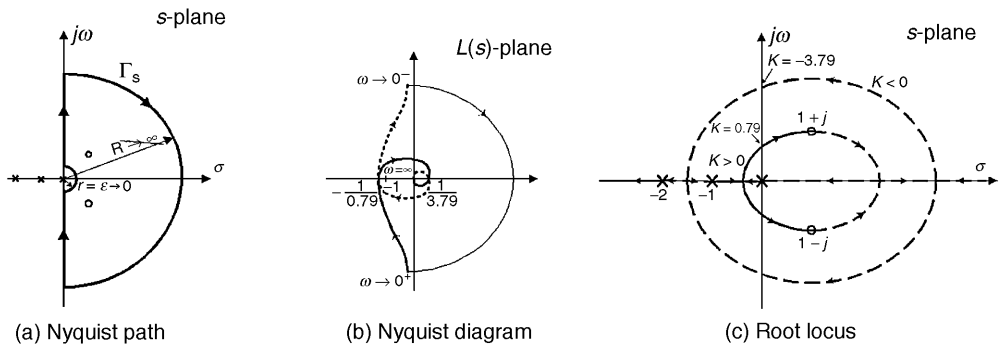

FIGURE 27.18 Nyquist diagram and root locus of Example 4.

The Nyquist stability criterion can now be stated as follows:

A necessary and sufficient condition for the closed-loop stability of a system defined by the loop transfer function $L(s)$ is that

$$Z = N + P \quad (27.12)$$

be equal to zero, where N is the net number of encirclements of the -1 point in the $L(s)$ -plane, and P is the number of unstable poles of the loop transfer function $L(s)$.

Example 4

Consider the system with the loop transfer function

$$KL(s) = KG(s)H(s) = K \frac{s^2 - 2s + 2}{s(s+1)(s+2)} \quad (27.13)$$

Let us determine the range of the gain K such that the closed-loop system is stable. Since there is a pole at $s = 0$, we need to modify the Nyquist path to detour around the origin. The contour is shown in Fig. 27.18(a), where the detour is chosen to be a semicircle of radius approaching zero in the limit. We use the following procedure to sketch the Nyquist plot in Fig. 27.18(b):

1. Determine $L(j\omega)$ as $\omega \rightarrow 0^+$: $L(s)$ is of system type 1 and thus

$$L(j\omega) \approx \frac{1}{j\omega} = \infty \angle -90^\circ$$

according to Table 27.2.

2. Determine $L(j\omega)$ as $\omega \rightarrow \infty$: $L(s)$ has a relative degree of 1 and

$$L(j\omega) \approx \frac{1}{j\omega} = 0 \angle -90^\circ$$

according to Table 27.2.

- From the Bode plot, draw the polar plot of $L(j\omega)$ as ω varies from 0^+ to ∞ . Although the magnitude curve of the factor $(s^2 - 2s + 2)$ is the same as the factor $(s^2 + 2s + 2)$, the phase of the factor $(s^2 - 2s + 2)$ changes from 0° to -180° . Thus, a sketch of the Bode diagram shows that the magnitude curve varies from infinity to zero and the phase changes from -90° to -450° . Since there are two points at which the phases are -180° and -360° , there will be two intersections of the $L(j\omega)$ locus with the real axis in the $L(s)$ -plane.
- Draw the polar plot of $L(j\omega)$ as ω varies from 0^- to $-\infty$ by reflecting the curve of $L(j\omega)$ in procedure 3 with respect to the real axis in the $L(s)$ -plane.
- Determine the contour map of the small detour around the origin of the s -plane to complete the plot. On the detour,

$$s = \lim_{\varepsilon \rightarrow 0} \varepsilon e^{j\theta}, \quad -90^\circ \leq \theta \leq 90^\circ$$

The contour map of the detour can then be determined by

$$\lim_{\varepsilon \rightarrow 0} L(\varepsilon e^{j\theta}) = \lim_{\varepsilon \rightarrow 0} \frac{(\varepsilon e^{j\theta})^2 - 2\varepsilon e^{j\theta} + 2}{\varepsilon e^{j\theta}(\varepsilon e^{j\theta} + 1)(\varepsilon e^{j\theta} + 2)} = \lim_{\varepsilon \rightarrow 0} \frac{1}{\varepsilon e^{j\theta}} = \lim_{\varepsilon \rightarrow 0} \frac{1}{\varepsilon} \angle -\theta$$

The resulting map is a large semicircle of radius approaching infinity. This semicircle starts at the point $L(j0^-)$ and swings 180° in the counterclockwise direction to connect the point $L(j0^+)$ in the $L(s)$ -plane.

- Calculate the intersections of the $L(j\omega)$ locus with the real-axis, for these points are related to the relative stability of the system. Suppose that the $L(j\omega)$ locus intersects the real axis for some critical frequency ω_{cr} . Then

$$L(j\omega_{cr}) = \begin{cases} 180^\circ + k360^\circ, & \text{for } K > 0 \\ 0^\circ + k360^\circ, & \text{for } K < 0 \end{cases}$$

where $k = 0, \pm 1, \pm 2, \pm 3, \dots$. This phase condition at the critical frequency is directly related to the angle condition of the root locus when the root locus crosses the imaginary axis. Therefore, we can utilize the Routh–Hurwitz criterion to determine the points where the $L(j\omega)$ locus crosses the real axis. The characteristic equation of the system (27.13) can be written as

$$s^3 + (K + 3)s^2 + (2 - 2K)s + 2K = 0$$

Thus, the Routh array is

$$\begin{array}{r|ll} s^3 & 1 & 2 - 2K \\ s^2 & K + 3 & 2K \\ s^1 & c & \\ s^0 & 2K & \end{array}$$

where

$$c = \frac{(K + 3)(2 - 2K) - 2K}{K + 3}$$

Let $c = 0$, and solving for K , we get the critical gains

$$K_{cr} = \frac{-3 \pm \sqrt{21}}{2} = 0.79, -3.79$$

Substituting the values of K_{cr} in the auxiliary equation

$$(K_{cr} + 3)s^2 + 2K_{cr} = 0$$

we obtain the critical frequencies

$$\omega_{cr} = \sqrt{\frac{2K_{cr}}{K_{cr} + 3}} = \begin{cases} 0.65, & \text{when } K_{cr} = 0.79 \\ 3.10, & \text{when } K_{cr} = -3.79 \end{cases}$$

At the critical frequency, we have the characteristic equation

$$1 + K_{cr}L(j\omega_{cr}) = 0$$

Hence the points of the $L(j\omega)$ locus that cross the real-axis are

$$L(j\omega_{cr}) = -\frac{1}{K_{cr}} = -\frac{1}{0.79}, \frac{1}{3.79}$$

The complete Nyquist plot is shown not to scale in Fig. 27.18(b). The range of the gain K for which the system is stable can be determined using Nyquist criterion. For different values of K , the Nyquist diagram needs to be redrawn in order to count the number of encirclement of the -1 point. We can avoid this by counting the number of encirclement of $-1/K$ point instead. From the Nyquist criterion, $Z = N + P$, where $P = 0$. It can be seen from Fig. 27.18(b) that there are four cases of the encirclements of the $-1/K$ point.

1. $K > 0$ and $-1/K < -1/0.79 \Rightarrow 0 < K < 0.79$, and $N = 0$. We have $Z = 0$ and the system is stable.
2. $K > 0$ and $-1/K > -1/0.79 \Rightarrow K > 0.79$, and $N = 2$. We have $Z = 2$ and the system has two unstable poles.
3. $K < 0$ and $-1/K < 1/3.79 \Rightarrow K < -3.79$, and $N = 3$. We have $Z = 3$ and the system has three unstable poles.
4. $K < 0$ and $-1/K > 1/3.79 \Rightarrow -3.79 < K < 0$ and $N = 1$. We have $Z = 1$ and the system has one unstable pole.

The root locus of system (27.13) is also shown in Fig. 27.18(c) for comparison.

27.7 Relative Stability

In designing a control system, it is required that the system be stable. In addition to stability, there are important concerns such as acceptable transient response and capability to deal with model uncertainty. Since the model used in the design and analysis of a control system is never exact, it may suggest a stable system; but the physical system turns out to be unstable. Therefore, it is required that the system not only be stable but also have some stability margin or adequate relative stability.

Suppose that the sinusoidal loop transfer function $L(j\omega)$ locus intersects the -1 point for some critical frequency ω_{cr} . Then

$$L(j\omega_{cr}) = G(j\omega_{cr})H(j\omega_{cr}) = -1$$

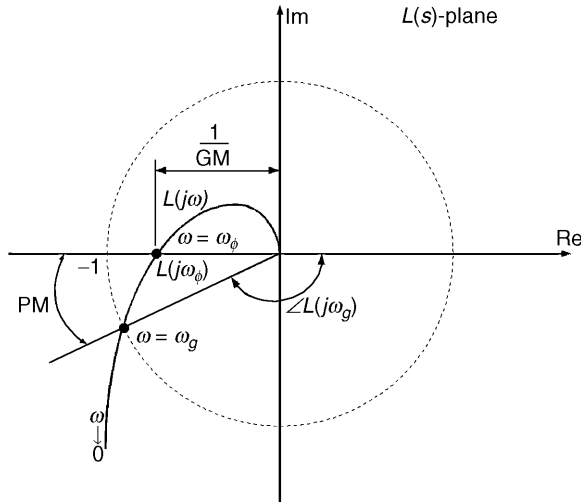

FIGURE 27.19 Gain and phase margins.

or

$$1 + L(j\omega_{cr}) = 1 + G(j\omega_{cr})H(j\omega_{cr}) = 0$$

This indicates that the closed-loop system has a pair of complex poles at $s = \pm j\omega_{cr}$. Hence, the system is marginally stable and oscillates with the frequency ω_{cr} , provided that all other closed-loop system poles are in the left half s -plane. In general, the closer the $L(j\omega)$ locus comes to the $-1 + j0$ point in the Nyquist plot, the more oscillatory is the system response. For this reason, the closeness of the $L(j\omega)$ locus to the -1 point can be used as a measure of the stability margin. Two traditional measures of the stability margin are gain margin and phase margin.

Gain margin and phase margin are usually defined for stable closed-loop systems that are characterized by a minimum phase, loop transfer function $L(s)$. The gain margin is the factor by which the open-loop gain of a stable closed-loop system can be increased before the system goes unstable. The phase margin is the amount of additional phase lag at the gain crossover frequency required to make the stable closed-loop system marginally stable. Thus we have the following definitions:

Gain margin (GM): The gain margin is the reciprocal of the magnitude $|L(j\omega)|$ at the phase crossover frequency ω_ϕ , where the phase of $L(j\omega_\phi)$ reaches -180° . The gain margin is given by

$$GM = \frac{1}{|L(j\omega_\phi)|} \quad \text{or} \quad GM(\text{dB}) = -20 \log |L(j\omega_\phi)|$$

Phase margin (PM): The phase margin is defined as the angle between the phase of the loop transfer at the gain crossover frequency ω_g where $|L(j\omega_g)| = 1$ and the angle -180° , or $PM = \angle L(j\omega_g) + 180^\circ$.

The gain and phase margins are shown in Fig. 27.19. Gain and phase margins are stability margins for single-input single-output systems. They cannot apply for multi-input multi-output systems. In addition, they can be a poor indication of stability margin in the face of combined gain and phase variations, as shown in Fig. 27.20. This is due to the fact that gain and phase margins are measures of stability margin in terms of only pure gain and phase variations, but not a combination of both. As a consequence, a system may have good gain and phase margins, but it is close to instability, as indicated in Fig. 27.20. To make up for the insufficiencies of gain and phase margins, a third stability margin, return difference, is used in modern control theory. We will only consider single-input single-output systems.

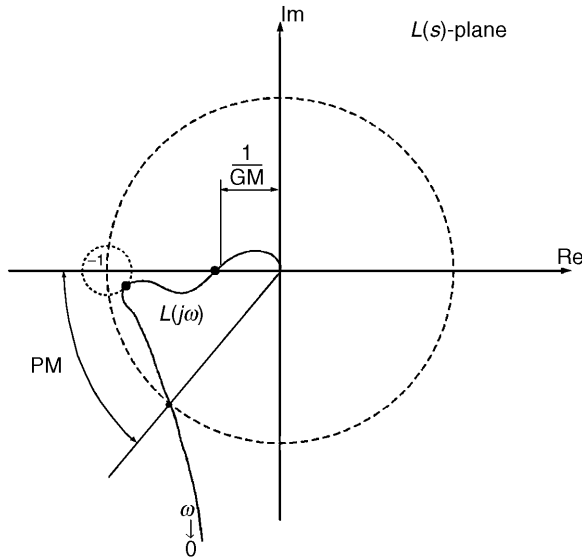

FIGURE 27.20 Insufficiency of gain and phase margins.

Minimum return difference: The minimum return difference is the minimum value of $|1 + L(j\omega)|$, for $0 < \omega < \infty$. It can be seen from Fig. 27.20 that the minimum return difference is the minimum distance from the Nyquist plot to the -1 point. Therefore, the gain and phase margins are special cases of the minimum return difference. The gain margin is directly related to the case when the minimum return difference occurs at the phase crossover frequency, and the phase margin is corresponding to the case that the minimum return difference occurs at the gain crossover frequency.

Although the minimum return difference is a better measure of stability margin than the gain and phase margins, it is seldom used in the classical control theory. This is because the classical control analysis and design is usually carried out using the Bode diagram or the Nichols chart instead of the Nyquist plot. The gain and phase margins are more easily determined from the Bode diagram or the Nichols chart than the Nyquist plot. Despite the fact that the minimum return difference can be easily evaluated from the Nyquist plot, it is difficult to determine the minimum return difference from the Bode plot or the Nichols chart.

We now correlate the phase margin and the damping ratio ζ of an underdamped second-order system. Consider the standard second-order system

$$T(s) = \frac{\omega_n^2}{s^2 + 2\zeta\omega_n s + \omega_n^2} \quad (27.14)$$

We assume that the transfer function $T(s)$ comes from a unity feedback configuration and can be rewritten as

$$T(s) = \frac{G(s)}{1 + G(s)}$$

where the open-loop transfer function $G(s)$ is given by

$$G(s) = \frac{\omega_n^2}{s(s + 2\zeta\omega_n)} \quad (27.15)$$

The phase margin occurs at the gain crossover frequency ω_c when $|G(j\omega_c)| = 1$, or

$$\frac{\omega_n^2}{\omega_c(\omega_c^2 + 4\zeta^2\omega_n^2)^{1/2}} = 1$$

This equation can be rewritten as

$$(\omega_c^2)^2 + 4\zeta^2\omega_n^2(\omega_c^2) - \omega_n^4 = 0$$

Solving for positive ω_c , we obtain

$$\frac{\omega_c^2}{\omega_n^2} = (4\zeta^4 + 1)^{1/2} - 2\zeta^2$$

Substituting $s = j\omega_c$ into Eq. (27.15), the phase margin for the system is

$$\begin{aligned} \text{PM} &= 180^\circ + \angle G(j\omega_c) \\ &= 180^\circ - 90^\circ - \tan^{-1}\left(\frac{\omega_c}{2\zeta\omega_n}\right) \\ &= 90^\circ - \tan^{-1}\left(\frac{1}{2\zeta}[(4\zeta^4 + 1)^{1/2} - 2\zeta^2]^{1/2}\right) \\ &= \tan^{-1}\left(2\zeta\left[\frac{1}{(4\zeta^4 + 1)^{1/2} - 2\zeta^2}\right]^{1/2}\right) \end{aligned} \quad (27.16)$$

Equation (27.16) relates the damping ratio of the standard second-order system (27.14) to the phase margin of its corresponding open-loop system (27.15) in a unity feedback configuration. This equation provides a correlation between the frequency response and the time response. A plot of ζ versus PM is shown in Fig. 27.21. The curve of ζ versus PM can be approximated by a dashed line in Fig. 27.21. The linear approximation can be expressed as

$$\zeta = 0.01 \text{ PM} \quad (27.17)$$

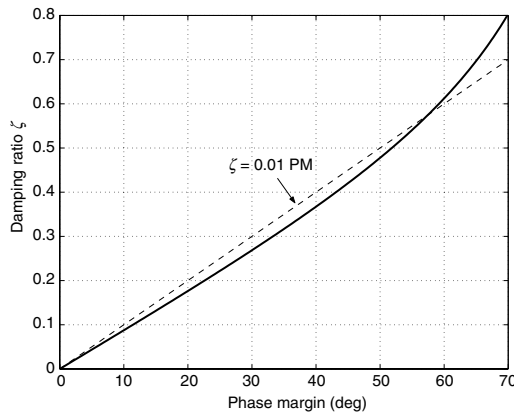

FIGURE 27.21 Damping ratio vs. phase margin for a second-order system.

This approximation is reasonably accurate for $\zeta \leq 0.7$ and is useful in relating the frequency response to the transient performance of a second-order system. Equation (27.17) may also be used for higher-order systems if the system can be assumed to have a pair of dominant underdamped complex poles.

References

1. Dorf, R.C., and Bishop, R.H., *Modern Control Systems*, 9th ed., Prentice-Hall, 2001.
2. Ogata, K., *Modern Control Engineering*, 2nd ed., Prentice-Hall, 1990.
3. Kuo, B.C., *Control Systems*, 7th ed., Prentice-Hall, 1995.
4. Franklin, G.F., Powell, J.D., and Emami-Naeini, A., *Feedback Control of Dynamic Systems*, 3rd ed., Addison-Wesley, 1994.
5. Phillips, C.L., and Harbor, R.D., *Feedback Control Systems*, 4th ed., Prentice-Hall, 2000.
6. Wolovich, W.A., *Automatic Control Systems: Basic Analysis and Design*, Harcourt Brace College Publishing, 1994.

28

Kalman Filters as Dynamic System State Observers

| | |
|------|--|
| 28.1 | The Discrete-Time Linear Kalman Filter Linearization of Dynamic and Measurement System Models • Linear Kalman Filter Error Covariance Propagation • Linear Kalman Filter Update |
| 28.2 | Other Kalman Filter Formulations The Continuous–Discrete Linear Kalman Filter • The Continuous–Discrete Extended Kalman Filter |
| 28.3 | Formulation Summary and Review |
| 28.4 | Implementation Considerations |

Timothy P. Crain II
NASA Johnson Space Center

28.1 The Discrete-Time Linear Kalman Filter

Distilled to its most fundamental elements, the Kalman filter [1] is a predictor-corrector estimation algorithm that uses a dynamic system model to predict state values and a measurement model to correct this prediction. However, the Kalman filter is capable of a great deal more than just state observation in such a manner. By making certain stochastic assumptions, the Kalman filter carries along an internal metric of the statistical confidence of the estimate of individual state elements in the form of a covariance matrix. The essential properties of the Kalman filter are derived from the requirements that the state estimate be

- a linear combination of the previous state estimate and current measurement information
- unbiased with respect to the true state
- and optimal in terms of having minimum variance with respect to the true state.

Starting with these basic requirements an elegant and efficient formulation for the implementation of the Kalman filter may be derived.

The Kalman filter processes a time series of measurements to update the estimate of the system state and utilizes a dynamic model to propagate the state estimate between measurements. The observed measurement is assumed to be a function of the system state and can be represented via

$$\mathbf{Y}(t) = h(\mathbf{X}(t), \boldsymbol{\beta}, t) + \mathbf{v}(t) \quad (28.1)$$

where $\mathbf{Y}(t)$ is an m dimensional observable, h is the nonlinear measurement model, $\mathbf{X}(t)$ is the n dimensional system state, $\boldsymbol{\beta}$ is a vector of modeling parameters, and $\mathbf{v}(t)$ is a random process accounting for measurement noise.

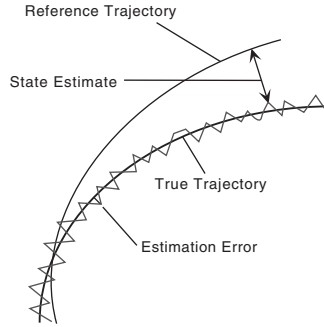

FIGURE 28.1 LKF tracking of a two-dimensional trajectory.

The true dynamic system is described by a general first-order, ordinary differential equation

$$\dot{\mathbf{X}}(t) = f(\mathbf{X}(t), \boldsymbol{\alpha}, t) + \mathbf{w}(t) \quad (28.2)$$

where f is the nonlinear dynamics function that incorporates all significant deterministic effects of the environment, $\boldsymbol{\alpha}$ is a vector of parameters used in the model, and $\mathbf{w}(t)$ is a random process that accounts for the noise present from mismodeling in f or from the quantum uncertainty of the universe, depending on the accuracy of the deterministic model in use.

With these general models available, a linear Kalman filter (LKF) may be derived in a discrete-time formulation. The dynamics and measurement functions are linearized about a known reference state, $\tilde{\mathbf{X}}(t)$, which is related to the true environment state, $\mathbf{X}(t)$, via

$$\tilde{\mathbf{X}}(t) + \mathbf{x}(t) = \mathbf{X}(t) \quad (28.3)$$

The LKF state estimate is related to the true difference by

$$\hat{\mathbf{x}}_k^{(\pm)} = \mathbf{x}_k + \delta\mathbf{x}_k^{(\pm)} \quad (28.4)$$

where the “ $\hat{\mathbf{x}}$ ” denotes the state estimate (or filter state), $\delta\mathbf{x}_k^{(\pm)}$ is the estimation error, and “ \pm ” indicates whether the estimate and error are evaluated instantaneously before (–) or after (+) measurement update at discrete time t_k .

It is important to emphasize that the LKF filter state is the estimate of the difference between the environment and the reference state. The LKF mode of operation will therefore carry along a reference state and the filter state between measurement updates. Only the filter state is at the time of measurement update. Figure 28.1 illustrates the generalized relationship between the true, reference, and filter states in an LKF estimating a two-dimensional trajectory.

Linearization of Dynamic and Measurement System Models

The dynamics and measurement functions may be linearized about the known reference state, $\tilde{\mathbf{X}}(t)$, according to

$$f(\mathbf{X}, \boldsymbol{\alpha}, t) \approx f(\tilde{\mathbf{X}}(t), \boldsymbol{\alpha}, t) + \mathbf{F}(\tilde{\mathbf{X}}(t), \boldsymbol{\alpha}, t)\mathbf{x}(t) + \mathbf{w}(t) \quad (28.5)$$

$$h(\mathbf{X}, \boldsymbol{\alpha}, t) \approx h(\tilde{\mathbf{X}}(t), \boldsymbol{\beta}, t) + \mathbf{H}(\tilde{\mathbf{X}}(t), \boldsymbol{\beta}, t)\mathbf{x}(t) + \mathbf{v}(t) \quad (28.6)$$

where \mathbf{F} is the dynamics partial derivative matrix and \mathbf{H} is the measurement partial derivative matrix defined by

$$\mathbf{F}(\tilde{\mathbf{X}}(t), \boldsymbol{\alpha}, t) = \left. \frac{\partial f}{\partial \mathbf{X}} \right|_{\mathbf{x}=\tilde{\mathbf{x}}} \quad (28.7)$$

$$\mathbf{H}(\tilde{\mathbf{X}}(t), \boldsymbol{\beta}, t) = \left. \frac{\partial h}{\partial \mathbf{X}} \right|_{\mathbf{x}=\tilde{\mathbf{x}}} \quad (28.8)$$

and $\mathbf{x}(t)$ is the true state to be estimated representing the difference between the environment and reference states

$$\mathbf{x}(t) = \mathbf{X}(t) - \tilde{\mathbf{X}}(t) \quad (28.9)$$

After linearizing the dynamic and measurement models, the effect of neglecting the higher order terms is assumed to be included in the random processes $\mathbf{w}(t)$ and $\mathbf{v}(t)$. The linearization is an acceptable approximation if $\mathbf{x}(t)$ is sufficiently small.

The reference and filter states are propagated according to the discrete-time linear relationship

$$\tilde{\mathbf{X}}_{k+1} = \boldsymbol{\Phi}(t_{k+1}, t_k) \tilde{\mathbf{X}}_k \quad (28.10)$$

$$\hat{\mathbf{x}}_{k+1}^{(-)} = \boldsymbol{\Phi}(t_{k+1}, t_k) \hat{\mathbf{x}}_k^{(-)} \quad (28.11)$$

where $\boldsymbol{\Phi}(t_{k+1}, t_k)$ is the state transition matrix from time t_k to time t_{k+1} and has the following properties:

$$\begin{aligned} \boldsymbol{\Phi}(t_k, t_k) &= \mathbf{I} \\ \dot{\boldsymbol{\Phi}}(t_{k+1}, t_k) &= \mathbf{F}(\tilde{\mathbf{X}}(t), \boldsymbol{\alpha}, t) \boldsymbol{\Phi}(t_{k+1}, t_k) \\ \boldsymbol{\Phi}(t_{k+2}, t_k) &= \boldsymbol{\Phi}(t_{k+2}, t_{k+1}) \boldsymbol{\Phi}(t_{k+1}, t_k) \end{aligned} \quad (28.12)$$

Note that the system dynamics are now incorporated into the propagation of the reference and filter states by the integration of the dynamics partial derivative in Eq. (28.13).

Mathematically, the true difference state is propagated in a similar fashion with the addition of a process noise random value

$$\mathbf{x}_{k+1} = \boldsymbol{\Phi}(t_{k+1}, t_k) \mathbf{x}_k + \mathbf{w}_k \quad (28.13)$$

In general, it is not required that the reference dynamic model be exactly the same as the truth dynamics or that the modeling parameter $\boldsymbol{\alpha}$ be equivalent to the true modeling vector. This notation is left in place to simplify the derivation of the Kalman filter formulation. A number of innovative approaches have been developed for adapting reference model parameters to improve fidelity with the unknown real-world system model [2–6] and can be used to enhance filter operation.

The LKF also requires a linearized measurement, $\mathbf{y}_k = \mathbf{Y}_k - \tilde{\mathbf{Y}}_k$, modeled by

$$\mathbf{y}_k = \mathbf{H}_k \mathbf{x}_k + \mathbf{v}_k \quad (28.14)$$

For the development of the Kalman filters presented here, the random contributions \mathbf{v}_k and \mathbf{w}_k are assumed to be discrete realizations of the continuous zero mean Gaussian process in Eqs. (28.1) and (28.2) and are defined by

$$E[\mathbf{v}_k \mathbf{v}_i^T] = \mathbf{R}_k \delta_{ki} \quad (28.15)$$

$$E[\mathbf{w}_k \mathbf{w}_i^T] = \mathbf{Q}_k \delta_{ki} \quad (28.16)$$

Generally, it is assumed that the process noise and measurement noise sequences are uncorrelated so that

$$E[\mathbf{w}_k \mathbf{v}_i^T] = 0 \quad \forall k, \forall i \quad (28.17)$$

However, the Kalman filter can be configured to operate in systems where this assumption does not apply [7].

Linear Kalman Filter Error Covariance Propagation

The propagation of the filter and reference states in the LKF were outlined in the previous section in Eqs. (28.11) and (28.13). However, all Kalman filter formulations must also propagate a confidence metric of the state estimate in the form of a state error covariance matrix. The state error covariance, \mathbf{P} , is defined as the expectation of the outer product of the estimation error vector

$$\mathbf{P}_k^{(\pm)} = E[\delta \mathbf{x}_k^{\pm} \delta \mathbf{x}_k^{\pm T}] \quad (28.18)$$

The state error covariance matrix is $n \times n$ and symmetric, and must remain positive definite to retain filter stability. The mechanism for propagating the covariance can be derived by taking the covariance just before measurement update at time t_{k+1}

$$\mathbf{P}_{k+1}^{(-)} = E[\delta \mathbf{x}_{k+1}^{(-)} \delta \mathbf{x}_{k+1}^{(-)T}] \quad (28.19)$$

and substituting the estimation error and propagation definitions in Eqs. (28.4), (28.11), and (28.13) to yield

$$\mathbf{P}_{k+1}^{(-)} = E\left[\Phi(t_{k+1}, t_k) \left(\hat{\mathbf{x}}_k^{(+)} - \mathbf{x}_k\right) \left(\hat{\mathbf{x}}_k^{(+)} - \mathbf{x}_k\right)^T \Phi(t_{k+1}, t_k)^T + \mathbf{w}_k \mathbf{w}_k^T\right] \quad (28.20)$$

Utilizing the definitions of process noise covariance in Eq. (28.16) and state error covariance in Eq. (28.18) the propagation equation reduces to

$$\mathbf{P}_{k+1}^{(-)} = \Phi(t_{k+1}, t_k) \mathbf{P}_k^{(+)} \Phi(t_{k+1}, t_k)^T + \mathbf{Q}_k \quad (28.21)$$

The propagation equation can be interpreted as the sum of the mapping of the previous post-update error covariance through the system dynamics and the system process noise induced uncertainty. Thus, process noise acts to increase the state error covariance between measurement updates.

Linear Kalman Filter Update

The linear Kalman filter (LKF) seeks an unbiased, minimum variance solution for the difference state, \mathbf{x}_k , by combining previous state information with available measurements. The state estimate after measurement update is therefore assumed to be a linear combination of the pre-update state and the linearized measurement information

$$\hat{\mathbf{x}}_k^{(+)} = \mathbf{K}_k^* \hat{\mathbf{x}}_k^{(-)} + \mathbf{K}_k \mathbf{z}_k \quad (28.22)$$

Substituting Eqs. (28.4) and (28.14) into Eq. (28.22) and solving for the estimation error yields

$$\delta \mathbf{x}_k^{(+)} = (\mathbf{K}_k^* + \mathbf{K}_k \mathbf{H}_k - \mathbf{I}) \mathbf{x}_k + \mathbf{K}_k^* \delta \mathbf{x}_k^{(-)} + \mathbf{K}_k \mathbf{v}_k \quad (28.23)$$

By definition $E[\mathbf{v}_k] = \mathbf{0}$ and $E[\delta\mathbf{x}_k^{(-)}] = \mathbf{0}$ by assumption of unbiased estimation. Therefore, the updated state estimation error is unbiased

$$E[\delta\mathbf{x}_k^{(+)}] = \mathbf{0} \quad (28.24)$$

only if

$$\mathbf{K}_k^* + \mathbf{K}_k \mathbf{H}_k - \mathbf{I} = \mathbf{0} \quad (28.25)$$

Substitution of Eq. (28.25) into Eq. (28.22) results in an expression for the updated state estimate

$$\hat{\mathbf{x}}_k^{(+)} = \hat{\mathbf{x}}_k^{(-)} + \mathbf{K}_k \left(\mathbf{z}_k - \mathbf{H}_k \hat{\mathbf{x}}_k^{(-)} \right) \quad (28.26)$$

with estimation error

$$\delta\mathbf{x}_k^{(+)} = (\mathbf{I} - \mathbf{K}_k \mathbf{H}_k) \delta\mathbf{x}_k^{(-)} + \mathbf{K}_k \mathbf{v}_k \quad (28.27)$$

The post-measurement error covariance in Eq. (28.18) may be expanded to

$$\mathbf{P}_k^{(+)} = (\mathbf{I} - \mathbf{K}_k \mathbf{H}_k) \mathbf{P}_k^{(-)} (\mathbf{I} - \mathbf{K}_k \mathbf{H}_k)^T + \mathbf{K}_k \mathbf{R}_k \mathbf{K}_k^T \quad (28.28)$$

by substitution of Eq. (28.27) and applying the conditions of uncorrelated process and measurement noise, zero mean measurement noise, and the definition of the pre-measurement state estimation error covariance. At this point, only the requirement that the Kalman filter be an unbiased estimator has been satisfied, so now we will select the Kalman gain \mathbf{K}_k that delivers the minimum summed variance on the post-measurement state estimation error. In other words, we seek the gain that will minimize

$$J_k = \text{trace} \left[\mathbf{P}_k^{(+)} \right] \quad (28.29)$$

The necessary condition for minimality of J_k is that its partial derivative with respect to the Kalman gain is zero. By employing the following relationship

$$\frac{\partial}{\partial \mathbf{A}} [\text{trace}(\mathbf{A} \mathbf{B} \mathbf{A}^T)] = 2 \mathbf{A} \mathbf{B} \quad (28.30)$$

where \mathbf{B} is a symmetric matrix, on the components of Eq. (28.28) with respect to \mathbf{K}_k results in

$$(\mathbf{I} - \mathbf{K}_k \mathbf{H}_k) \mathbf{P}_k^{(-)} \mathbf{H}_k^T + \mathbf{K}_k \mathbf{R}_k = \mathbf{0} \quad (28.31)$$

The optimal gain (the Kalman gain) is therefore

$$\mathbf{K}_k = \mathbf{P}_k^{(-)} \mathbf{H}_k^T \left[\mathbf{H}_k \mathbf{P}_k^{(-)} \mathbf{H}_k^T + \mathbf{R}_k \right]^{-1} \quad (28.32)$$

which is sometimes written as

$$\mathbf{K}_k = \mathbf{P}_k^{(-)} \mathbf{H}_k^T \mathbf{W}_k^{-1} \quad (28.33)$$

where the term \mathbf{W}_k is referred to as the innovations covariance

$$\mathbf{H}_k \mathbf{P}_k^{(-)} \mathbf{H}_k^T + \mathbf{R}_k \quad (28.34)$$

28.2 Other Kalman Filter Formulations

In addition to the LKF, there are several other formulations of the Kalman filter that may be employed to more closely follow the characteristics of specific state observation scenarios. The LKF may be varied according to the temporal nature of the dynamic and measurement systems to be continuous in dynamics and measurements or continuous in dynamics and discrete in measurements [12]. Also, there are applications when the dynamic system is energetic or the measurement quality is poor that may cause the reference state in the LKF to quickly leave the region of linearity about the environment state. In such systems, the reference state can be updated through addition of the filter state into an implementation known as the extended Kalman filter (EKF). The EKF is highly suited to real-time applications but is nonlinear in the sense that the reference state is essentially reinitialized at the time of each measurement update. Both the continuous–discrete LKF and EKF will be developed in the following sections.

The Continuous–Discrete Linear Kalman Filter

There may quite naturally arise an application where the reference state, filter state, and state error covariance are more suitably propagated in a continuous fashion than through the linear application of the state transition matrix. Also, it is common for the measurement system to deliver discrete-time observations even when the dynamics are best modeled continuously. In such a situation the update mechanization is unchanged from the previous LKF derivation while the propagation between updates is carried out through continuous integration. Without loss of generality, it may be stated that the reference dynamics of a continuous Kalman filter may be represented by

$$\dot{\tilde{\mathbf{X}}}(t) = f(\tilde{\mathbf{X}}(t), \boldsymbol{\alpha}, t) \quad (28.35)$$

Furthermore, by taking time derivatives of the filter state and covariance propagation (Eqs. (28.11) and (28.21)) and substituting in Eq. (28.13) for the derivative of the state transition matrix, the continuous-time filter state and covariance relations are found to be

$$\dot{\hat{\mathbf{x}}}(t) = f(\tilde{\mathbf{X}}(t), \boldsymbol{\alpha}, t) + \mathbf{F}(\tilde{\mathbf{X}}(t), \boldsymbol{\alpha}, t)[\hat{\mathbf{x}}(t) - \tilde{\mathbf{X}}(t)] \quad (28.36)$$

$$\dot{\mathbf{P}}(t) = \mathbf{F}(t)\mathbf{P}(t) + \mathbf{P}(t)\mathbf{F}^T(t) + \bar{\mathbf{Q}}(t) \quad (28.37)$$

where $\bar{\mathbf{Q}}(t)$ is the spectral density of the dynamic process noise at time t and the explicit functional dependency of \mathbf{F} was dropped for notational convenience. In this mechanization of the LKF, the state transition matrix need not be calculated as the dynamics are included directly via the partial derivative matrix and the reference state, filter state, and error covariance are propagated continuously.

The process and measurement noise representations in this formulation are continuous and discrete for the respective models, and are again assumed to be zero mean processes governed by the continuous dynamic process noise covariance

$$E[\mathbf{w}(t)\mathbf{w}^T(\tau)] = \mathbf{Q}(t)\delta(t - \tau) \quad (28.38)$$

and the discrete measurement noise covariance

$$E[\mathbf{v}_k\mathbf{v}_j^T] = \mathbf{R}_k\delta_{kj} \quad (28.39)$$

It is also assumed here that the process and measurement noises are uncorrelated so that

$$E[\mathbf{w}(t)\mathbf{v}_k^T] = 0 \quad (28.40)$$

although the formulation can be modified to accommodate process and measurement noise correlations if necessary [7].

The Continuous–Discrete Extended Kalman Filter

In applications where the reference state may quickly deviate beyond the linear region of the environment state, the reference may be directly updated at the time of measurement update by adding the LKF filter state to the reference in an EKF. The EKF is similar to the LKF, in that measurements are processed to provide an estimate of the difference between the true state and reference state of the spacecraft. Also, the EKF evaluates dynamics and measurement partials with respect to the reference state in a manner similar to the LKF. However, the reference state about which these partials are evaluated is modified through the addition of measurement information

$$\tilde{\mathbf{X}}(t_k)^{(+)} = \tilde{\mathbf{X}}(t_k)^{(-)} + \hat{\mathbf{x}}(t_k) \quad (28.41)$$

The reference state dynamics model used in the EKF formulation is given by Eq. (28.35), but the measurement model is the discrete form given by Eq. (28.1). The filter state representing the estimated difference between the true state and the reference state is only calculated at the time of measurement update via dropping the previous estimate information term from Eq. (28.26):

$$\hat{\mathbf{x}}_k = \mathbf{K}_k \mathbf{Z}_k \quad (28.42)$$

where the innovation is now the actual measurement residual

$$\mathbf{Z}_k = \mathbf{Y}_k - \mathbf{h}(\tilde{\mathbf{X}}_k^{(-)}, \boldsymbol{\beta}, t_k) \quad (28.43)$$

Therefore, in the EKF there is not a separate filter state that needs to be propagated to the time of the next measurement, as the filter state has been incorporated into the updated reference state.

As before, the error covariance at each measurement is updated by

$$\mathbf{P}_k^{(+)} = (\mathbf{I} - \mathbf{K}_k \mathbf{H}_k) \mathbf{P}_k^{(-)} (\mathbf{I} - \mathbf{K}_k \mathbf{H}_k)^T + \mathbf{K}_k \mathbf{R}_k \mathbf{K}_k^T, \quad (28.44)$$

and the EKF Kalman gain and innovations covariance are analogous to their LKF counterparts

$$\mathbf{K}_k = \mathbf{P}_k^{(-)} \mathbf{H}_k \mathbf{W}_k^{-1} \quad (28.45)$$

$$\mathbf{W}_k = \mathbf{H}_k \mathbf{P}_k^{(-)} \mathbf{H}_k + \mathbf{R}_k. \quad (28.46)$$

The difference between EKF operation and LKF operation is illustrated by revisiting the two-dimensional trajectory illustration in Fig. 28.2. The reference trajectory can now be seen to respond to measurement information availability and tracks the true environment trajectory.

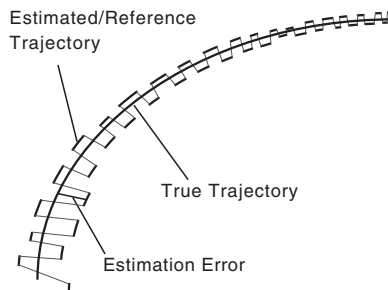

FIGURE 28.2 EKF tracking of a two-dimensional trajectory.

28.3 Formulation Summary and Review

The LKF discrete–discrete formulation was given by the following propagation equations:

$$\begin{aligned}\tilde{\mathbf{X}}_{k+1} &= \Phi(t_{k+1}, t_k) \tilde{\mathbf{X}}_k \\ \hat{\mathbf{x}}_{k+1}^{(-)} &= \Phi(t_{k+1}, t_k) \hat{\mathbf{x}}_k^{(-)} \\ \mathbf{P}_{k+1}^{(-)} &= \Phi(t_{k+1}, t_k) \mathbf{P}_k^{(-)} \Phi(t_{k+1}, t_k)^T + \mathbf{Q}_k\end{aligned}$$

and update equations

$$\begin{aligned}\hat{\mathbf{x}}_k^{(+)} &= \hat{\mathbf{x}}_k^{(-)} + \mathbf{K}_k \left[\mathbf{z}_k - \mathbf{H}_k \hat{\mathbf{x}}_k^{(-)} \right] \\ \mathbf{P}_k^{(+)} &= (\mathbf{I} - \mathbf{K}_k \mathbf{H}_k) \mathbf{P}_k^{(-)} (\mathbf{I} - \mathbf{K}_k \mathbf{H}_k)^T + \mathbf{K}_k \mathbf{R}_k \mathbf{K}_k^T \\ \mathbf{K}_k &= \mathbf{P}_k^{(-)} \mathbf{H}_k^T \left[\mathbf{H}_k \mathbf{P}_k^{(-)} \mathbf{H}_k^T + \mathbf{R}_k \right]^{-1}\end{aligned}$$

In the discrete time LKF mechanization, the reference state is unaffected by the incorporation of measurement information into the filter state.

In a slight variation of this approach, the dynamics of the LKF may be made continuous, and the filter state, reference state, and covariance propagated without the use of a state transition matrix.

$$\begin{aligned}\dot{\tilde{\mathbf{X}}}(t) &= f(\tilde{\mathbf{X}}(t), \boldsymbol{\alpha}, t) \\ \dot{\hat{\mathbf{x}}}^{(-)}(t) &= \mathbf{F}(\tilde{\mathbf{X}}(t), \boldsymbol{\alpha}, t) \hat{\mathbf{x}}^{(-)}(t) \\ \dot{\mathbf{P}}(t) &= \mathbf{F}(t) \mathbf{P}(t) + \mathbf{P}(t) \mathbf{F}^T(t) + \bar{\mathbf{Q}}(t)\end{aligned}$$

When the application requires that the reference state be modified to remain in the linear vicinity of the environment state, the EKF continuous–discrete formulation may be appropriate. In the continuous–discrete EKF formulation, the propagation is carried out according to

$$\begin{aligned}\dot{\tilde{\mathbf{X}}}(t) &= f(\tilde{\mathbf{X}}(t), \boldsymbol{\alpha}, t) \\ \dot{\mathbf{P}}(t) &= \mathbf{F}(t) \mathbf{P}(t) + \mathbf{P}(t) \mathbf{F}^T(t) + \bar{\mathbf{Q}}(t)\end{aligned}$$

and the measurement update according to

$$\begin{aligned}\tilde{\mathbf{X}}(t_k)^{(+)} &= \tilde{\mathbf{X}}(t_k)^{(-)} + \hat{\mathbf{x}}(t_k) \\ \hat{\mathbf{x}}_k &= \mathbf{K}_k \left[\mathbf{Y}_k - \mathbf{h} \left(\tilde{\mathbf{X}}_k^{(-)}, \boldsymbol{\beta}, t_k \right) \right] \\ \mathbf{P}_k^{(+)} &= (\mathbf{I} - \mathbf{K}_k \mathbf{H}_k) \mathbf{P}_k^{(-)} (\mathbf{I} - \mathbf{K}_k \mathbf{H}_k)^T + \mathbf{K}_k \mathbf{R}_k \mathbf{K}_k^T \\ \mathbf{K}_k &= \mathbf{P}_k^{(-)} \mathbf{H}_k^T \left[\mathbf{H}_k \mathbf{P}_k^{(-)} \mathbf{H}_k^T + \mathbf{R}_k \right]^{-1}\end{aligned}$$

The reference state will change with the incorporation of measurement information into the EKF and the partials evaluated along this changing reference.

28.4 Implementation Considerations

It is commonly held among designers of Kalman filters that the implementation of the formulas listed above represent only a portion of the effort required to develop an accurate and robust Kalman filter application. Once the dynamics, measurements, and partial derivatives have been coded, the task remains to tune the noise magnitudes represented in the process noise covariance \mathbf{Q} and the measurement noise covariance \mathbf{R} . While the measurement noise can be based in realistic hardware performance specifications, the process noise is often used as a tuning parameter to ensure that the filter operates correctly. This process of tuning the filter crosses over into the area of design and is nearly an art form of such myriad approaches that it is beyond the scope of this work to outline. However, a Kalman filter checklist is provided for the newcomer to the field to reduce the time of the implementation and tuning learning curve:

- Because the linear Kalman filter does not change the reference state in the presence of measurement information, the reference state and partial derivatives for an LKF application may be computed prior to operation. This makes the LKF more amenable to computationally restricted applications or hypothesis testing where differing process noise and measurement noise parameters are being evaluated in parallel [8].
- Process noise serves to keep the filter from becoming overconfident in its estimate (i.e., a covariance with near zero diagonal values) and converging prematurely. Examining the propagation equations for the Kalman filters presented previously, it can easily be seen how the addition of process noise increases the magnitude of the state error covariance between measurements.
- The innovations covariance should ideally converge to describe the variance in the filter measurement residuals. Adaptive techniques have been implemented where the filter noise parameters are tuned according to a metric linking residual statistics with the innovations covariance [5]. In an ideal filter, the innovations covariance should approach the measurement noise covariance as the process noise magnitude approaches zero.
- When multiple measurements are available at the same time, they may be processed as a series of scalar observations as long as they are uncorrelated (i.e., \mathbf{R} is a diagonal matrix). The effect of processing scalar measurements is that the innovations covariance becomes a scalar, and a numerical division rather than a matrix inversion is required to calculate the Kalman gain.
- Measurement editing may be employed to prevent spurious data from causing filter divergence in a number of ways. One of the most common is to reject measurements when the ratio of the measurement residual squared to the scalar innovations covariance

$$\frac{r_k^2}{W_k} \quad (28.47)$$

is above a user-defined threshold. The threshold value may either be a constant or may be time varying after long propagation periods to allow for a smooth transition to a steady state innovations covariance.

- The covariance should always be positive definite. If filter divergence is a chronic problem in a particular application, the numerical integrity of the covariance may provide insight into the nature of the divergence. There are also several numerical implementations of the covariance update equation that take advantage of its symmetry and positive definiteness to enhance its stability while reducing computational load [9].
- Process noise may be enhanced by including time correlated states such as first-order Gauss–Markov processes to the filter to account for specific dynamic effects. The biases associated with these processes can be included in the filter state for estimation.

As a final note it should be stressed that the Kalman filter is not the state observer algorithm best suited for all applications. Its strengths lie in light computational requirements and real-time availability

of a state estimate in the presence of accurate measurement information. However, batch estimation techniques such as least-squares estimation may be more appropriate in applications where the dynamic process is modeled to a high degree of fidelity, measurements are not uniformly accurate, and real-time operation is not an issue. A number of quality texts [10–12] have been written on the subject of stochastic estimation in general and specifically Kalman filtering that the the reader is encouraged to pursue for more detailed information.

References

1. Kalman, R. E., “A new approach to linear filtering and prediction problems,” *Transactions of the ASME, Ser. D, Journal of Basic Equations*, March 1960, pp. 35–45.
2. Burkhart, P. and Bishop, R., “Adaptive orbit determination for interplanetary spacecraft,” *Journal of Guidance, Control, and Dynamics*, Vol. 19, No. 3, 1997, pp. 693–701.
3. Chaer, W., Bishop, R., and Ghosh, J., “Hierarchical adaptive Kalman filtering for interplanetary orbit determination,” *IEEE Transactions on Aerospace and Electronic Systems*, Vol. 34, No. 3, 1998, pp. 1–14.
4. Crain, T. and Bishop, R., “The mixture-of-experts gating network: integration into the ARTSN extended Kalman filter,” Technical Memorandum CSR-TM-99-01, Center for Space Research, March 1999.
5. Ely, T., Bishop, R., and Crain, T., “Adaptive interplanetary navigation using genetic algorithms,” *The Journal of Astronautical Sciences*, 2000, Accepted for Publication.
6. Crain, T. and Bishop, R., “Unmodeled impulse detection and identification during Mars pathfinder cruise,” Technical Memorandum CSR-TM-00-01, Center for Space Research, March 2000.
7. Chaer, W. and Bishop, R., “Adaptive Kalman filtering with genetic algorithms,” *Advances in the Astronautical Sciences*, edited by R. Proulx, J. Liu, P. Siedelmann, and S. Alfano, Vol. 89, Univelt, San Diego, CA, 1995, pp. 141–156, Pt. 1.
8. Gholson, N. and Moose, R., “Maneuvering target tracking using adaptive state estimation,” *IEEE Transactions on Aerospace and Electronic Systems*, Vol. 13, No. 3, May 1997, pp. 310–317.
9. Bierman, G., *Factorization Methods for Discrete Sequential Estimation*, Academic Press, 1977.
10. Brown, R. G. and Huang, P. Y. C., *Introduction to Random Signals and Applied Kalman Filtering*, John Wiley and Sons, 1992.
11. Lewis, F., *Applied Optimal Control and Estimation*, Prentice-Hall, Englewood Cliffs, NJ, 1992.
12. Gelb, A., *Applied Optimal Estimation*, The M.I.T. Press, Cambridge, MA, 1974.

29

Digital Signal Processing for Mechatronic Applications

Bonnie S. Heck

Georgia Institute of Technology

Thomas R. Kurfess

Georgia Institute of Technology

- 29.1 Introduction
- 29.2 Signal Processing Fundamentals
 - Continuous-Time Signals • Discrete-Time Signals
- 29.3 Continuous-Time to Discrete-Time Mappings
 - Discretization • s -Plane to z -Plane Mappings
 - Frequency Domain Mappings
- 29.4 Digital Filter Design
 - IIR Filter Design • FIR Filter Design • Computer-Aided
 - Design of Digital Filters • Filtering Examples
- 29.5 Digital Control Design
 - Digital Control Example

29.1 Introduction

Most engineers work in the world of mechatronics as there are relatively few systems that are purely mechanical or electronic. There are a variety of means by which electrical systems augment mechanical systems and vice versa. For example, most microprocessors found in a computer today have some sort of heat sink and perhaps a fan attached to them to keep them within their operational temperature zone. Electrical systems are widely employed to monitor and control a wide variety of mechanical systems. With the advent of inexpensive digital processing chips, digital filtering and digital control for mechanical systems is becoming commonplace. Examples of this can be seen in every automobile and most household appliances. For example, sensor signals used in monitoring and controlling of mechanical systems require some form of signal processing. This signal processing can range from simply “cleaning-up” the signal using a low pass filter to more advanced analyses such as torque and power monitoring in a DC servo motor. This chapter presents a brief overview of digital signal processing methods suitable for mechanical systems. Since this chapter is limited in space, it does not give any derivation or details of analysis. For a more detailed discussion, see references [1,2].

29.2 Signal Processing Fundamentals

A few fundamental concepts on signal processing must be introduced before a discussion of filtering or control can be undertaken.

Continuous-Time Signals

Laplace transforms are used for system analysis of continuous-time systems, solving for system response, and control design. The single-sided Laplace transform of a continuous-time signal, $x(t)$, is given by

$$X(s) = \int_0^{\infty} x(t)e^{-st} dt$$

A transfer function of a linear system, $H(s)$, can be found as the ratio of the Laplace transforms of the output over that of the input (with zero initial conditions).

The Fourier transform is used to determine the frequency content of a signal. The Fourier transform of $x(t)$ is given by

$$X(\omega) = \int_{-\infty}^{\infty} x(t)e^{-j\omega t} dt \quad (29.1)$$

where ω is in units of radians per second. Notice that when $x(t) = 0$ for $t \leq 0$, the Laplace transform is equivalent to the Fourier transform by setting $s = j\omega$. (It should be noted that there are some additional convergence considerations for the Fourier transform.) The frequency response of a system is defined as the ratio of the Fourier transforms of the output over that of the input. Equivalently, it can be found from the transfer function as $H(\omega) \equiv H(j\omega) = H(s)|_{s=j\omega}$. For simplicity of notation, the j is usually not shown in the argument list, giving rise to the notation $H(\omega)$ to represent the frequency response. The bandwidth of a system is defined as the frequency at which $H(\omega) = 0.707H(0)$.

Discrete-Time Signals

The z -transform is useful for solving a difference equation and for performing system analysis. The z -transform of a discrete-time signal, $x[n]$, is defined as

$$X(z) = \sum_{n=-\infty}^{\infty} x[n]z^{-n}$$

The discrete-time Fourier transform (DTFT) is used to determine the frequency content of a signal. The DTFT and the inverse DTFT of a signal are defined by

$$X(\Omega) = \sum_{n=-\infty}^{\infty} x[n]e^{-j\Omega n} \quad (29.2)$$

and

$$x[n] = \frac{1}{2\pi} \int_{-\pi}^{\pi} X(\Omega)e^{j\Omega n} d\Omega \quad (29.3)$$

Note that the DTFT can be derived from the z -transform by setting $z = e^{j\Omega}$. (Again, there are some assumptions on convergence in this derivation.) Since the DTFT is periodic with period 2π , it is typically displayed over the range $[-\pi, \pi]$ or $[0, 2\pi]$, where the frequencies of general interest are from $\Omega = 0$ (low frequency) to $\Omega = \pi$ (high frequency). The frequency response of a discrete-time system can be found as the ratio of the DTFT of the output signal over that of the input signal. Alternatively, it can be found from the transfer function as $H(\Omega) \equiv H(e^{j\Omega}) = H(z)|_{z=e^{j\Omega}}$. The notation $H(\Omega)$ is preferred over $H(e^{j\Omega})$ for its simplicity. As in the continuous-time case, the bandwidth is defined as the frequency at which $H(\Omega) = 0.707H(0)$.

While the DTFT is continuous with respect to the frequency variable Ω , the discrete Fourier transform (DFT) contains points that are discrete with respect to a parameter k . Consider a finite duration sequence $x[n]$, where $x[n] = 0$ for $n < 0$ and for $n \geq N$. The DFT of $x[n]$ and the inverse DFT are defined as

$$X_k = \sum_{n=0}^{N-1} x[n] e^{-j2\pi nk/N}, \quad k = 0, 1, \dots, N-1 \tag{29.4}$$

and

$$x_n = \frac{1}{N} \sum_{k=0}^{N-1} X_k e^{j2\pi nk/N}, \quad n = 0, 1, \dots, N-1$$

Note that the DFT is a discretized version of the DTFT where $X_k = X(\Omega)|_{\Omega=2\pi k/N}$ over the range $\Omega = 0$ to $\Omega = 2\pi$. Calculating a closed-form solution for the DTFT can be done only for simple signals such as a square pulse or a triangular pulse. Therefore, the DFT is generally used as a numerical method to calculate the DTFT at discrete points in frequency in the range $0 \leq \Omega \leq 2\pi$. In particular, to obtain a plot of the DTFT, plot X_k versus k where k is scaled by $2\pi/N$. For an arbitrary signal, such as obtained from measurements of a physical device, computing the DFT instead of the DTFT is the preferred method to find the frequency content of the signal. To get more resolution in plotting a DTFT from the points calculated by a DFT, zeros can be added to the end of the sequence so that the value of N is increased.

Suppose a time domain signal is not finite in duration, so that there is no value of N such that $x[n] = 0$ for $n \geq N$. In order to perform the DFT, the signal must be truncated. There are two cases to be considered: the case where $x[n]$ is decaying to zero and the case where $x[n]$ has periodic components. The case when $x[n]$ decays to zero is handled by choosing N to be large enough so that the signal is negligible beyond that value. The resulting DFT is an approximation (not a discretized version) of the DTFT. If the signal is periodic, the DTFT cannot be computed numerically since the resulting DTFT would have impulses in it. However, the frequencies present in the signal could still be determined if the value of N used for the truncation is chosen so that the truncated signal goes through an integer number of cycles. If this not done, the resulting DFT will have leakage in the frequency plot when compared to the DTFT of the true signal. For example, consider a signal $x[n] = \cos(0.4\pi n)$. This is periodic with period $n = 5$ and has DTFT given by $X(\Omega) = \pi[\delta(\Omega + 0.4\pi) + \delta(\Omega - 0.4\pi)]$ for $-\pi \leq \Omega \leq \pi$. All the frequency content is located at $\Omega = 0.4\pi$ and $\Omega = -0.4\pi$. Since the DTFT is periodic with 2π , there is also an impulse at $\Omega = 2\pi - 0.4\pi$. The DFT is computed for two truncations of the signal, one at $N = 20$ (four complete cycles) and the other at $N = 22$. The DFT for $N = 20$ is plotted in Fig. 29.1(a) where the independent variables k are scaled by $2\pi/N$ for the plot. This plot shows zero frequency content except at $\Omega = 0.4\pi$ (≈ 1.2566) and $\Omega = 2\pi - 0.4\pi$ (≈ 5.0265), giving the correct location of the impulses in the DTFT. Similarly, the DFT for $N = 22$ is plotted in Fig. 29.1(b), notice the resulting leakage in the frequency characteristics.

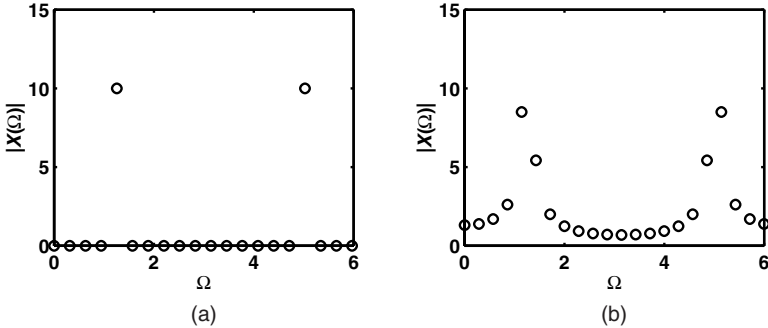

FIGURE 29.1 DFT of periodic signal (a) truncated after 4 complete cycles and (b) truncated after 4.4 cycles.

If a signal has periodic content, but is not periodic, such as $x[n] = \cos(0.5\pi n) + \cos(0.2n)$, then leakage cannot be avoided by a selection of N . An alternate means of reducing leakage is to first taper the signal to zero at the initial and end points of the sequence prior to computing the DFT. This process, known as *windowing* the data, is accomplished by multiplying $x[n]$ by a window function $w[n]$ and then performing the DFT on the product $x[n]w[n]$. Three common windows are the rectangular window, which is a sharp truncation, the Hanning window, and the Hamming window [1].

Rectangular Window:

$$w[n] = 1, \quad 0 \leq n \leq N - 1$$

Hanning Window:

$$w[n] = \frac{1}{2} \left(1 - \cos\left(\frac{2\pi n}{N-1}\right) \right), \quad 0 \leq n \leq N - 1$$

Hamming Window:

$$w[n] = 0.54 - 0.46 \cos\left(\frac{2\pi n}{N-1}\right), \quad 0 \leq n \leq N - 1$$

If the value of N in a DFT is a power of 2, there is a fast method to compute the DFT called the fast Fourier transform (FFT). If the value of N is not a power of 2, zeros can be padded to the end of the signal in order to use the FFT. This does not affect the accuracy of the result, but it does improve the resolution of the resulting plot when the DFT (or FFT) is used to compute the DTFT. In many cases, the expression used in Eq. (29.4) suffices to compute the DFT since the added computational power of today's processors lessens the need for the numerical efficiency of the FFT. The details of the algorithm for the FFT are beyond the scope of this handbook. See [1] or [2] for details.

29.3 Continuous-Time to Discrete-Time Mappings

While most physical systems operate in continuous-time, computers operate in discrete-time. Therefore, in order to use computers to process measurements taken from continuous-time systems, there must be ways of mapping between the continuous-time world to the discrete-time world.

Discretization

Before an analog signal can be analyzed using digital techniques, it must be discretized (that is, converted into a discrete-time signal). The ideal method for discretization is *sampling*, where the values of the signal are determined at discrete points in time. Generally, the signal is sampled at a fixed rate known as the *sampling period*. The sampling rate (in hertz) is the inverse of the sampling period. Figure 29.2 depicts a 1 Hz signal that has been sampled at two rates. The dark points are sampled at 15 ms intervals, while the lighter points are sampled at 250 ms intervals. From Fig. 29.2, the waveform approximation clearly degrades as the sampling frequency is reduced and approaches the signal frequency. In fact, it can be shown that a signal must be sampled at a frequency that is higher than twice its maximum frequency content. This is known as the Nyquist Sampling Theorem. For example, if the signal in Fig. 29.2 is sampled at 0.5 Hz, it is possible for every sample to have a value of 0 as at 0, 500, 1000 ms, etc... the value of the signal is 0. The erroneous interpretation of the signal due to a sample frequency that is too low is known as aliasing. There are two means by which the Nyquist Sampling Theorem can be satisfied. The first is by employing a sample frequency that is more than twice the highest frequency content of the signal being sampled. This value frequency is known as the Nyquist frequency. As one never is sure of the actual frequency content of a real signal, a low pass filter may be used to ensure that a signal does not possess frequencies above a certain cut-off level. Such a filter is commonly

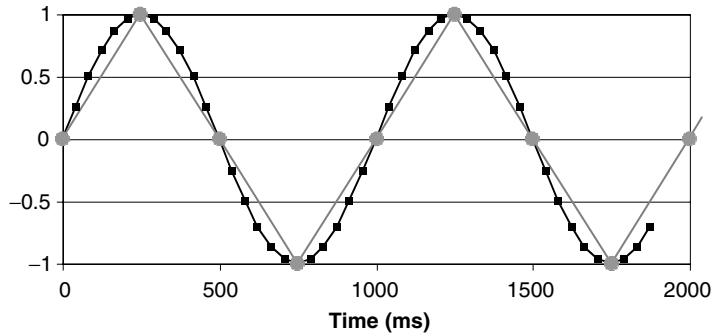

FIGURE 29.2 A 1-Hz signal.

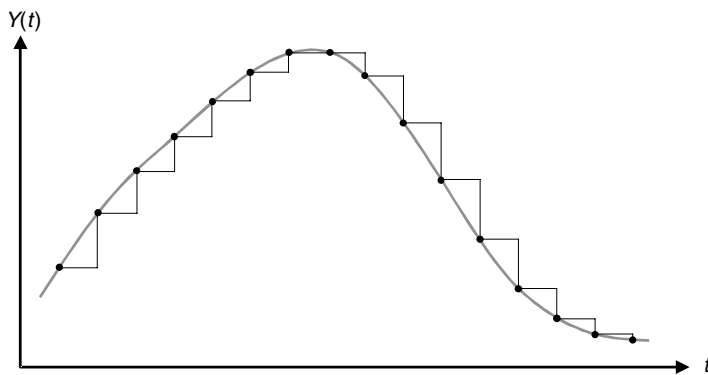

FIGURE 29.3 A signal sampled and reconstructed using a zero order hold (ZOH).

called an anti-aliasing filter. This is the second and most practical method that is used to satisfy the Nyquist Sampling Theorem. Thus, a combination of a well-designed anti-aliasing filter as well as a sampling frequency that is well above the cut-off frequency of the filter will ensure that the Nyquist Sampling Theorem is satisfied.

There are two important points that should be noted when using an anti-aliasing filter. First, it is important that the anti-aliasing filter be used before the signal is sampled as sampling is what causes aliasing. Basically, this requires that the anti-aliasing filter is implemented using an analog filter prior to the signal being digitized. Once a signal has been aliased during sampling, it cannot be corrected using digital filtering. The second point is that, in practice, the cutoff frequency of the anti-aliasing filter should be a factor of 5–10 below the value of the Nyquist frequency. It should be noted that an anti-aliasing filter adds phase lag to the measurement, which might deteriorate stability and performance in a feedback loop unless the bandwidth of the anti-aliasing filter is much higher than that of the closed loop system. Commercially available devices that perform sampling are analog-to-digital converters (ADCs), and the anti-aliasing filter is used before this device.

The converse of sampling is reconstruction where a discrete-time signal is converted into a continuous-time signal. The Nyquist sampling rate ensures that if a continuous-time signal is sampled at a rate that is at least twice the highest frequency component in the signal, then the continuous-time signal can be reconstructed exactly from the samples. However, this theorem assumes that an ideal reconstruction process is available, which is not practical. The most common practical means to reconstruct a signal is a zero-order hold (ZOH). The ZOH assumes that the value of the signal is constant between samples. This approximation is quite reasonable if the sampled signal does not change substantially between individual samples. Figure 29.3 is an example of a signal and its ZOH representation. The gray, smooth line represents the original analog signal. The black points along the signal indicate sample values of the signal. Each black

point is connected to the next via a horizontal then vertical straight line. The horizontal line is representative of the ZOH assumption that the value of the signal remains constant between samples. The vertical line is the reality that the signal does not remain constant over the sample period. As the time between sample points is increased, the accuracy of the ZOH decreases. Conversely, as the sample period is decreased, the accuracy of the ZOH is improved. Commercially available devices that perform reconstruction are digital-to-analog converters (DACs), which generally use the ZOH method.

s-Plane to z-Plane Mappings

One method to relate the s -plane to the z -plane is to derive a continuous-time mathematical representation of the sampled signal for $x(t)$ and compute its Laplace transform. The resulting Laplace transform of the sampled signal can be related to the z -transform of $x[n]$ by setting $z = e^{sT}$ where T is the sampling period. The relationship $z = e^{sT}$ is commonly termed the *exact mapping* between the z -plane and the s -plane. (For details of this derivation, see [1]). For example, a digital representation, $H_d(z)$, of a continuous-time system, $H(s)$, can be obtained using this mapping $H_d(z) = H(s)|_{z=e^{sT}}$. However, this mapping results in a nonrational function for $H_d(z)$.

Approximate mappings between the s -plane and the z -plane are commonly used that do result in a rational function for $H_d(z)$. Three such mappings are the bilinear transformation, forward transformation, and backward transformation.

Bilinear transformation:

$$s = \frac{2(z-1)}{T(z+1)}$$

Forward transformation:

$$s = \frac{1}{T}(z-1)$$

Backward transformation:

$$s = \frac{1}{Tz}(z-1)$$

The bilinear transformation (also known as Tustin's rule or the trapezoidal rule) is the most accurate of these mappings. It maps the entire left-hand side of the s -plane into the unit circle of the z -plane, so that it preserves stability. Consider a first-order example of $H(s) = 1/(s+2)$. The discrete-time representation of this transfer function is

$$H_d(z) = H(s)|_{s=\frac{2(z-1)}{T(z+1)}} = \frac{T(z+1)}{2z-2+2T}$$

Note that the resulting transfer function is rational in z .

An alternate method of mapping transfer functions between the continuous-time and the discrete-time domains is the response-matching mapping.

Response-matching: Suppose $x(t)$ is the input to a system $H(s)$ with the resulting output $y(t)$. Let $x[n]$ and $y[n]$ be the sampled versions of $x(t)$ and $y(t)$. Then, $H_d(z)$ is found from the ratio of z -transforms of $x[n]$ and $y[n]$. The most common response matching is step-response matching where $x(t)$ is a step function, $x(t) = 1$ for $t \geq 0$ and $x(t) = 0$ for $t < 0$. An expression for $H_d(z)$ is found from the following operation:

$$H_d(z) = (1-z^{-1})Z\left[\frac{H(s)}{s}\right]$$

where $Z[H(s)/s]$ represents the z-transform of the sampled version of the step response of the continuous-time system. The form for a generic first-order system is given below:

$$H(s) = \frac{a}{s+a} \Leftrightarrow H_a(z) = \frac{(1 - e^{-aT})z^{-1}}{1 - e^{-aT}z^{-1}}$$

The response matching method (especially with step inputs) is commonly used to map a continuous-time plant to discrete-time when designing a digital controller in the discrete-domain. Since most digital controllers are implemented using a ZOH on the output of the digital controller, the plant sees a stepped signal, one that looks like a sum of delayed step signals. Therefore, the step-response matching method is the most accurate way to map a plant that has a ZOH on its input.

Frequency Domain Mappings

The continuous-time Fourier transform can be related to the DTFT through the expression:

$$X(\omega) = TX(\Omega)|_{\Omega=\omega T} \quad \text{for } -\pi \leq \Omega \leq \pi$$

where $X(\omega)$ is defined in Eq. (29.1) and represents the continuous-time Fourier transform of $x(t)$, while $X(\Omega)$ is defined in Eq. (29.2) and represents the DTFT of the sampled signal $x[n]$. This mapping is very useful for computing the Fourier transform of measured data. In particular, suppose a continuous-time signal is measured by sampling it through an ADC and storing it as a discrete-time sequence. If the signal $x(t)$ is finite in duration, the DTFT of $x[n]$ can be computed at discrete points in frequency by using the DFT, X_k , as given in Eq. (29.4). Using the relationships $\omega = \Omega/T$, $\Omega = 2\pi k/N$, and $X_k = X(\Omega)|_{\Omega=2\pi k/N}$, where N is the length of the sequence for $x[n]$ and T is the sampling period, gives the relationship:

$$X(\omega)|_{\omega=2\pi k/NT} = TX_k \quad \text{for } 0 \leq \omega \leq \omega_s/2, \quad 0 \leq k \leq (N-1)/2$$

where $\omega_s = 2\pi/T$ is the sampling frequency in radian per second. Accuracy can be improved by decreasing the sampling period T , and the resolution in the plot can be increased by increasing NT .

If the signal $x(t)$ is not finite in duration, it must be truncated in order to use this numerical method to calculate the continuous-time Fourier transform. As discussed in the section “Discrete-Time Signals,” if the sampled signal $x[n]$ decays to zero, choose the number of sampled points N to be large enough so that $x(t)$ is negligible beyond that value. If the sampled signal $x[n]$ is periodic, choose the sampling period T and the number of points N such that the sampled signal $x[n]$ goes through an integer number of cycles. For example, consider the signal $x(t) = \cos(\pi t)$. If the sampling period is chosen as $T = 0.4$ s, the discretized signal would be $x[n] = x(nT) = \cos(0.4\pi n)$, which is the same signal analyzed in the section “Discrete-Time Signals.” Choosing $N = 5, 10, 15$, etc. would yield correct results in the DFT while any other value would result in leakage. If the signal $x(t)$ has periodic content, but does not appear to be periodic, then use a windowing function as discussed in the section “Discrete-Time Signals” to reduce leakage when computing the DFT.

Note that the DFT can also be used to determine the Fourier coefficients of periodic signals. Consider a Fourier series in the form

$$x(t) = \sum_{k=-\infty}^{\infty} c_k e^{j\omega_k t}$$

Sample the signal $x(t)$ by first making sure that the sampled signal goes through an integer number of cycles. The coefficients c_k for $k = 0, \dots, (N-1)/2$ can be found as $c_k = X_k/N$ where X_k is found from the DFT. The rest of the coefficients are obtained from $c_{-k} = c_k^*$.

Since the frequency response of a system is the ratio of the Fourier transforms of the output over the input, a mapping between a continuous-time system, $H(\omega)$, and a corresponding discrete-time system, $H_d(\Omega)$, can be derived from the previous mapping as

$$H(\omega) = H_d(\Omega)|_{\Omega=\omega T} \quad \text{for } -\pi \leq \Omega \leq \pi$$

This mapping is useful for the design of both digital filters and digital controllers.

29.4 Digital Filter Design

The frequency response function of a discrete-time system describes how the system processes input signals of different frequencies. Consider an input signal $x[n] = A \cos(\Omega_0 n)$ to a system with frequency response $H(\Omega)$ where $0 \leq \Omega_0 \leq 2\pi$. The corresponding output is given by

$$y[n] = |H(\Omega_0)| \cos(\Omega_0 n + \angle H(\Omega_0))$$

For aperiodic signals, the filtering property of Fourier transforms gives the relationship:

$$Y(\Omega) = H(\Omega)X(\Omega)$$

Thus, if $|H(\Omega)|$ is small over a certain range of frequencies, then input signals with frequency content in that range are attenuated as they pass through the system.

It is often convenient to filter continuous-time signals through a digital filter as shown in Fig. 29.4. The analog-to-digital converter (ADC) samples the continuous-time signal creating a sequence of discrete-time signals for processing by the computer or digital signal processing board. The filtered signal can be stored digitally for further study or it can be sent through a digital-to-analog converter (DAC). The digital filter can be implemented in software by a recursive equation obtained from the difference equation. Consider a digital filter with transfer function:

$$H(z) = \frac{b_1 z^N + b_2 z^{N-1} + \dots + b_{N+1}}{a_1 z^N + a_2 z^{N-1} + \dots + a_{N+1}} = \frac{b_1 + b_2 z^{-1} + \dots + b_{N+1} z^{-N}}{a_1 + a_2 z^{-1} + \dots + a_{N+1} z^{-N}}$$

The recursion used to calculate the current value of the output $y[n]$ is given by the difference equation:

$$y[n] = \frac{1}{a_1} (b_1 x[n] + b_2 x[n-1] + \dots + b_{N+1} x[n-N] - a_2 y[n-1] - \dots - a_{N+1} y[n-N]) \quad (29.5)$$

Notice that the past values of y and x must be stored for use in the recursion.

Now consider the impulse response of a digital filter, where $y[n]$ is calculated for an input $x[n]$ equal to an impulse (i.e., $\delta[n] = 1$ when $n = 0$ and $\delta[n] = 0$ otherwise). The recursion shown above results in a response for $y[n]$ that has infinite duration (i.e., there is no value of M so that $y[n] = 0$ for all $n > M$). This type of filter is called an *infinite impulse response (IIR) filter*.

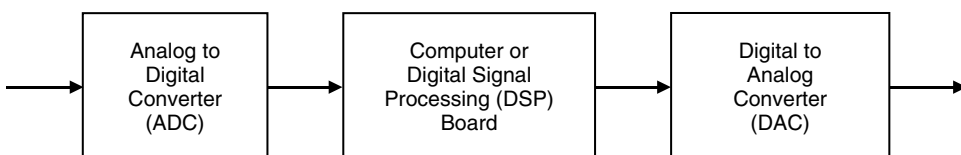

FIGURE 29.4 Configuration for standard digital signal processing hardware.

Now consider the case where the coefficients of the filter $a_m = 0$ for $m > 1$. The resulting expression for $y[n]$ from Eq. (29.5) would no longer be recursive since it would depend only on present and past values of x , and not on past values of y . As a result, the impulse response would have duration N . This type of filter is called a *finite impulse response (FIR) filter*. FIR filters are sometimes preferred over IIR filters since they have linear phase in the frequency response. Linear phase means that the angle of the frequency response is given by $-\theta\Omega$, where θ is a constant. This corresponds to a delay in the time domain. Design methods for both types of filters are described in the next two sections.

IIR Filter Design

The two methods for designing IIR filters are termed *analog emulation* (or indirect design) and *direct design*. Analog emulation involves designing an analog filter first and then using one of the mapping techniques described in the section “*s*-Plane to *z*-Plane Mappings” to convert it to a digital filter. This method has advantages in that there is a wealth of design techniques for analog filters that can be used in digital filter design. Direct design methods generally involve numerical techniques, and they are often preferred over analog emulation when the sampling period is not very small. Direct design is beyond the scope of this handbook; consult reference [2] for more information on the topic.

Analog filter design begins by selecting a bandwidth, a prototype of filter, and an order of the filter. Additional specifications may be set on the amount of ripple that is allowed in the passband or stopband. Two common analog prototypes are the Butterworth filters and the Chebyshev filters.

Butterworth filter: The Butterworth filter is characterized by having no zeros and having poles that are situated on a semicircle in the left-half of the *s*-plane. The distance of the poles to the origin is the bandwidth frequency and is denoted as ω_b . The angle of the poles can be determined by equally spacing out twice the number of poles around a full circle with radius ω_b and then keeping only the poles in the left-half plane, as shown in Fig. 29.5. An *N*th order Butterworth filter is given by

$$H(s) = \frac{\omega_b^N}{\prod_k (s - \omega_b p_k)}$$

where

$$p_k = \begin{cases} e^{jk\pi/N}, & k = \frac{N+1}{2} \text{ to } \frac{3N-1}{2} \text{ for } N \text{ odd} \\ e^{j(k+0.5)\pi/N}, & k = \frac{N}{2} \text{ to } \frac{3N-2}{2} \text{ for } N \text{ even} \end{cases}$$

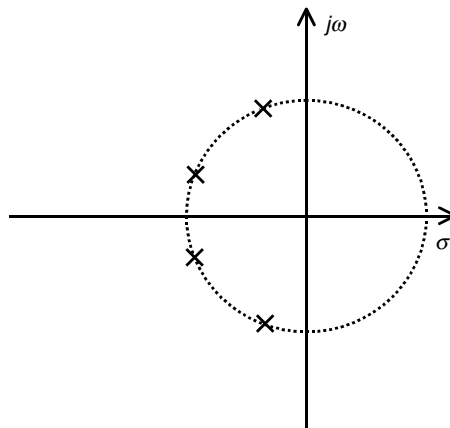

FIGURE 29.5 Pole distribution of a fourth-order Butterworth filter.

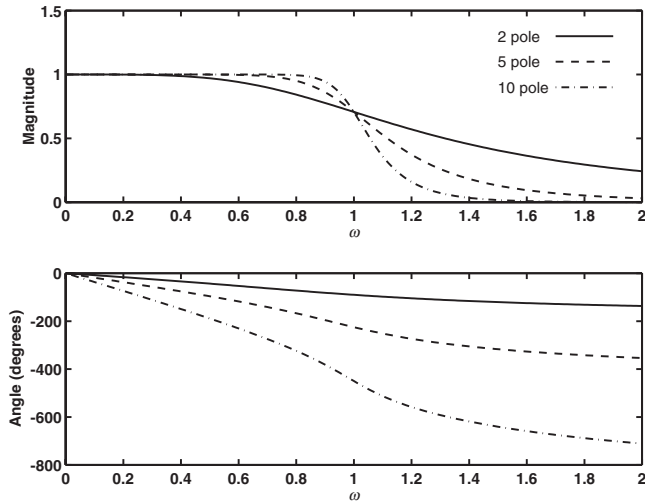

FIGURE 29.6 Comparison of analog Butterworth filters.

This filter is lowpass in that the magnitude of the frequency response is reasonably flat and close to a value of 1 for $\omega < \omega_b$ and drops off sharply beyond the bandwidth frequency. The larger the order of the filter, the sharper the drop off. Three filters are compared in Fig. 29.6. Notice that the sharp transitions offered by the larger order filters do come with a price: the phase is also decreased dramatically. The phasing becomes important in real-time measurement systems such as that required by feedback controllers.

Chebyshev filter: Unlike the monotonic behavior of the Butterworth filter, the Chebyshev filter allows some ripple in the magnitude plot for either the passband or the stopband. The Type 1 Chebyshev filter allows for ripple in the passband while the Type 2 Chebyshev filter allows for ripple in the stopband. Allowing for a ripple results in the Chebyshev filters having sharper transitions near the bandwidth than are achievable by a Butterworth filter of the same order. In Chebyshev design, the cutoff frequency ω_c is usually specified as opposed to the bandwidth. The cutoff frequency is the frequency at which the magnitude of the filter decays to a preset ratio of the DC value. When this ratio is 0.707, the cutoff frequency is the bandwidth. Often, in Chebyshev design, this ratio is chosen to correspond to the amount of ripple allowed in the passband. A Type 1 Chebyshev lowpass filter is defined by the relationships:

$$|H(\omega)| = \frac{1}{\sqrt{1 + \varepsilon^2 C_N^2(\omega/\omega_c)}}$$

and

$$C_N(x) = 2xC_{N-1}(x) - C_{N-2}(x)$$

The $C_N(x)$ expression is called the N th order Chebyshev polynomial, and it is calculated recursively starting with $C_0(x) = 1$ and $C_1(x) = x$. The value of $\varepsilon > 0$ determines the amount of ripple allowed in the passband; in particular, the ripple exists between the values of 1 and $1/\sqrt{1 + \varepsilon^2}$. Consider, for example, the Type 1 Chebyshev filters shown in Fig. 29.7; these filters were designed to have 1 dB of ripple in the passband ($\varepsilon = 0.51$). Note that $\varepsilon = 1$ for 3 dB of ripple.

As mentioned above, these prototype filters are lowpass. To design another type of filter, first the lowpass filter is designed, $H(s)$, with a cutoff frequency ω_c (typically chosen to be 1). Then a frequency transformation is used to convert the filter to the desired type. The standard frequency transformations are given below.

Lowpass to lowpass: To obtain a lowpass filter with cutoff frequency ω_1 , replace s in the original $H(s)$ by $s\omega_c/\omega_1$.

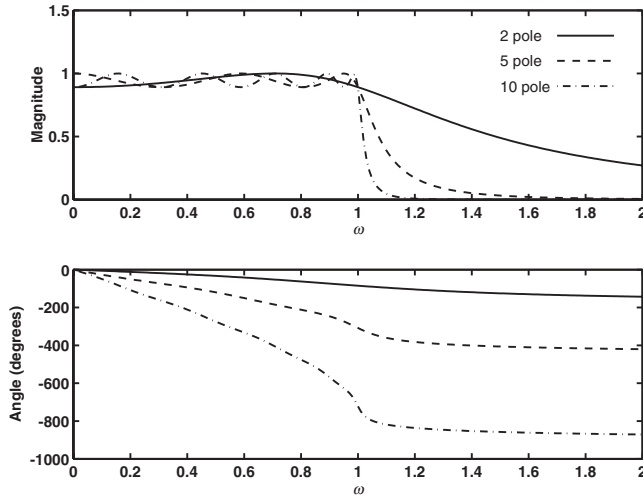

FIGURE 29.7 Comparison of analog Type I Chebyshev filters.

Lowpass to highpass: To obtain a highpass filter with a passband running from ω_1 to ∞ , replace s in the original $H(s)$ by $\omega_1 \omega_c / s$.

Lowpass to bandpass: To obtain a bandpass filter with a passband running from ω_1 to ω_2 , replace s in the original $H(s)$ by

$$\frac{s^2 + \omega_2 \omega_1}{s(\omega_2 - \omega_1)}.$$

Lowpass to bandstop: To obtain a bandstop filter with stopband running from ω_1 to ω_2 , replace s in the original $H(s)$ by

$$\frac{s(\omega_2 - \omega_1)}{s^2 + \omega_2 \omega_1}.$$

FIR Filter Design

One way to obtain an FIR filter is to truncate the impulse response of an ideal IIR filter. For example, an ideal IIR lowpass filter has the frequency response:

$$H(\Omega) = \begin{cases} A, & -\Omega_c \leq \Omega \leq \Omega_c \\ 0, & \text{otherwise} \end{cases}$$

where A is a constant and Ω_c is the cutoff frequency. The impulse response of this filter is found from taking the inverse DTFT using Eq. (29.3):

$$h[n] = \frac{A\Omega_c}{\pi} e^{jn\Omega_c/2} \text{sinc}\left(\frac{\Omega_c n}{\pi}\right)$$

Notice that this has infinite duration for both $n < 0$ and $n > 0$. Creating an FIR filter would entail truncating the impulse response for $n < -N$ and for $n > N$. However, the original IIR filter and the resulting truncated FIR filter are both noncausal; that is, the impulse response is nonzero for $n < 0$.

Noncausal filters need future values of the input in order to calculate the present value of the output; hence, they cannot be implemented in real-time. For this reason, typical IIR design uses nonideal filters (often based on analog prototypes) that approximate the ideal frequency response. When filtering a signal off-line that has been stored, causality is no longer required since all of the values of the signal are available (including “future” values).

In order to perform real-time implementation of an FIR filter that was generated by truncating an ideal IIR filter, the filter must be delayed so that all of the significant information of the impulse response occurs for $n \geq 0$. This delay in the time domain is equivalent to a linear phase lag in the frequency domain.

Thus, an FIR filter can be designed by first selecting an ideal IIR filter (lowpass, highpass, etc.), then taking the inverse DTFT to find the impulse response, and then truncating the impulse response, and finally, delaying it in time. An equivalent and more preferred method is to rearrange the steps described above. First, add a phase lag in the frequency response of the ideal IIR filter. This is done by multiplying the frequency response by $e^{j(N-1)/2}$. Then, take the inverse DTFT and truncate it for $n < 0$ and $n > N - 1$. The result is a causal FIR filter with order N .

The following are generic FIR filters of order N that have been generated using the method described above. Let $m = (N - 1)/2$.

Lowpass FIR filter with cutoff frequency Ω_c :

$$h[n] = \begin{cases} \frac{\Omega_c}{\pi}, & n = 0 \\ \frac{\Omega_c}{\pi} \text{sinc} \left[\frac{\Omega_c(n-m)}{\pi} \right], & \text{for } 0 < n \leq N-1 \\ 0, & \text{otherwise} \end{cases}$$

where $\text{sinc}(x) = \sin(\pi x)/\pi x$.

Highpass FIR filter with passband from Ω_1 :

$$h[n] = \begin{cases} 1 - \frac{\Omega_1}{\pi}, & \text{for } n = 0 \\ -\frac{\Omega_1}{\pi} \text{sinc} \left[\frac{\Omega_1(n-m)}{\pi} \right], & \text{for } 0 < n \leq N-1 \\ 0, & \text{otherwise} \end{cases}$$

Bandpass FIR filter with passband from Ω_1 to Ω_2 :

$$h[n] = \begin{cases} \frac{\Omega_2 - \Omega_1}{\pi}, & \text{for } n = 0 \\ \frac{\Omega_2}{\pi} \text{sinc}[\Omega_2(n-m)/\pi] - \frac{\Omega_1}{\pi} \text{sinc}[\Omega_1(n-m)/\pi], & \text{for } 0 < n \leq N-1 \\ 0, & \text{otherwise} \end{cases}$$

To implement these filters, the coefficients in Eq. (29.5) are set to $b_m = h[m-1]$, $a_1 = 1$, and $a_m = 0$ for $m > 1$.

The FIR filters designed using this method have frequency responses that have rather sharp transitions between the passband and the stopband (the larger the order, the sharper the transition), but they tend to give rise to a ripple in the passband and stopband. This ripple results from the sharp truncation of the IIR filter’s impulse response. A more gradual truncation using a window can be performed that smooths the ripple in the frequency response. The windows discussed in the section “s-Plane to z-Plane Mappings”

that are employed in data collection are also used in FIR filter design, where the modified filter is given as $h[n]w[n]$. FIR design using different windows is discussed in further detail in [1,2].

Computer-Aided Design of Digital Filters

Matlab™ is a common software package for signal processing analysis and design. The signal processing toolbox contains several commands for designing and simulating digital filters. For example, the commands `butter` and `cheby1` automatically design a prototype analog filter for an IIR and then use the bilinear transformation to map the filter to the discrete-time domain. Lowpass, highpass, bandstop, and bandpass filters can be designed using these commands as long as the digital cutoff frequencies, normalized by π , are specified. To design a digital lowpass filter based on the analog Butterworth filter with cutoff frequency w_1 , use the command $[b, a] = \text{butter}(N, w_1 * T/\pi)$ where N is the number of poles, T is the sampling period, and $w_1 * T$ is digital cutoff frequency. This command puts the coefficients of the filter, defined in Eq. (29.5), in vectors b and a in ascending order. To design a digital highpass filter with analog cutoff frequency w_1 , use the commands $[b, a] = \text{butter}(N, w_1 * T/\pi, \text{'high'})$. To design a digital bandpass filter with analog passband from w_1 to w_2 , define $w = [w_1, w_2]$ and use the command $[b, a] = \text{butter}(N, w * T/\pi)$. To design a digital bandstop filter with stopband from w_1 to w_2 , define $w = [w_1, w_2]$ and use the command $[b, a] = \text{butter}(N, w * T/\pi, \text{'stop'})$. The design for an N th order Type I Chebyshev filter is accomplished using the same methods as for `butter` except that “`butter`” is replaced by “`cheby1`.”

The signal processing toolbox also provides commands for designing FIR filters. To obtain a lowpass FIR filter with length N and analog cutoff frequency w_1 , use the command $h = \text{fir1}(N - 1, w_1 * T/\pi)$. The resulting vector h contains the impulse response of the FIR where $h(1)$ is the value of $h[0]$. The values in the vector h also equal the coefficients of b in Eq. (29.5) in ascending order. (Recall, that $a_1 = 1$ and $a_m = 0$ for $m > 1$.) A length N highpass FIR filter with analog cutoff frequency w_1 is designed by using the command $h = \text{fir1}(N - 1, w_1 * T/\pi, \text{'high'})$. A bandpass FIR filter with passband from w_1 to w_2 is obtained by typing $h = \text{fir1}(N - 1, w * T/\pi)$ where $w = [w_1, w_2]$. A bandstop FIR filter with stopband from w_1 to w_2 is obtained by typing $h = \text{fir1}(N - 1, w * T/\pi, \text{'stop'})$ where $w = [w_1, w_2]$. The `fir1` command uses the Hamming window by default. Other windows are obtained by adding an option of “`hanning`” or “`boxcar`” (which is the rectangular window) to the arguments; for example, $h = \text{fir1}(N - 1, w_1 * T/\pi, \text{'high'}, \text{boxcar}(N))$ creates a highpass FIR filter with analog cutoff frequency w_1 using a rectangular window.

The filter command in Matlab is used to compute an output of a digital filter given its input sequence. An example of its use is $y = \text{filter}(b, a, x)$ where b and a are the coefficients of the filter and x is the input sequence.

Filtering Examples

Quite often, 60 Hz noise is encountered in measurements of electromechanical systems due to standard line voltage. (Note, in Europe noise at a 50-Hz frequency is typically encountered.) For demonstration purposes, a 60-Hz signal is superimposed on a lower frequency signal shown in Fig. 29.8. To alleviate the detrimental effects of the 60-Hz noise, a bandstop filter may be employed. Typically, most systems

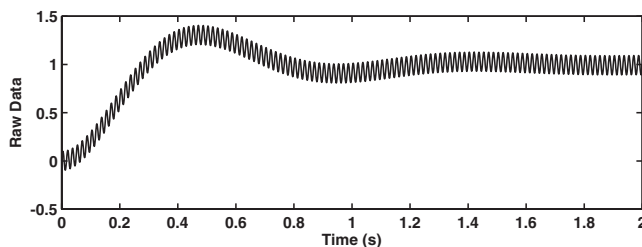

FIGURE 29.8 Measurement corrupted with 60-Hz noise.

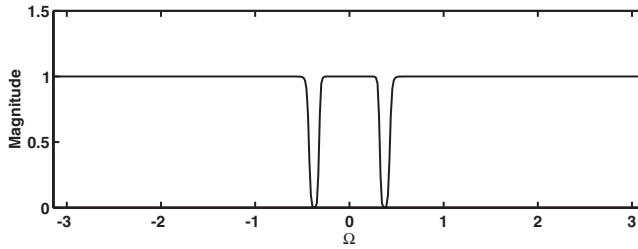

FIGURE 29.9 Bandstop filter.

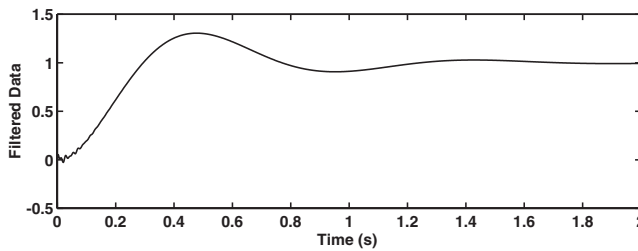

FIGURE 29.10 Filtered measurement.

have a bandstop filter designed around 60 Hz to avoid the type of response seen in Fig. 29.8. The following Matlab commands can be employed to design an eighth-order digital Butterworth bandstop filter whose break frequencies are 50 and 70 Hz. Thus, the filter should reject the 60-Hz noise.

```
T = 0.001; %Sample period
n = 4; % half the order of filter
low_freq = 50 * (2*pi); %Stop signals between 50 and 70 Hz
high_freq = 70 * (2*pi);

w1 = low_freq*(T/pi); % normalized digital break frequencies
w2 = high_freq*(T/pi);
w = [w1 w2];

[b,a] = butter(n,w,'stop'); % filter coefficients

W = -pi:pi/200:pi; % define a digital frequency vector
H = freqz(b,a,W); % computes the frequency response for plotting
```

Figure 29.9 shows the magnitude of the frequency response for the resulting IIR filter. Note that the frequency variable is plotted for the range $[-\pi, \pi]$ where DC frequency corresponds to $\Omega = 0$ and the highest frequency allowable is $\Omega = \pi$. In this example, the digital break frequencies correspond to $\Omega_1 = 50(2\pi)T = 0.314$ and $\Omega_2 = 70(2\pi)T = 0.44$. Figure 29.10 shows the result of applying this filter to the noisy signal. For all practical purposes, the 60-Hz noise is completely attenuated. As can be seen in Fig. 29.10, there are some initial system transients during the first 100 ms of the step response. This is a combination of the fourth-order Butterworth filter and the initial system transients to the 60-Hz signal. It should be noted that the sample frequency of 1000 kHz is fast enough to accurately capture the 60-Hz signal. If a sample frequency of less than 120 Hz is used, the 60-Hz signal will be aliased, and no amount of digital filtering would be able to eliminate the effects of the 60-Hz disturbance.

Another application of digital filtering in mechatronics is used when estimating displacement from an acceleration measurement. A simplistic approach to calculating the displacement is to integrate the acceleration twice. In the s -domain, this double integration is equivalent to multiplying by $1/s^2$. Using the

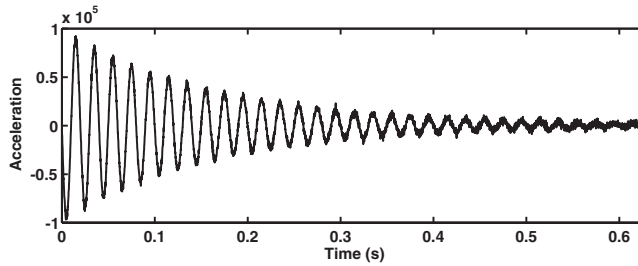

FIGURE 29.11 Acceleration measurement.

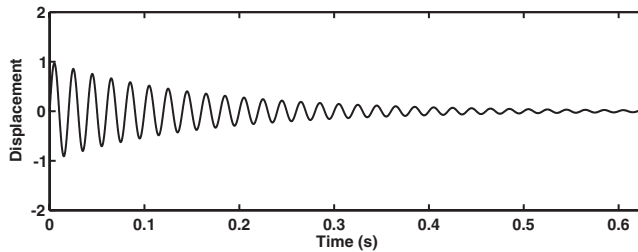

FIGURE 29.12 Actual displacement.

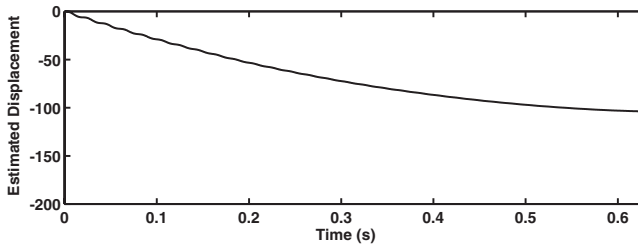

FIGURE 29.13 Estimated displacement without use of a prefilter.

bilinear transformation to convert $1/s^2$ to the z -domain yields the following transfer function,

$$H(z) = H(s) \Big|_{s=\frac{2(z-1)}{T(z+1)}} = \frac{1}{s^2} \Big|_{s=\frac{2(z-1)}{T(z+1)}} = \left(\frac{T^2}{4}\right) \left(\frac{z^2 + 2z + 1}{z^2 - 2z + 1}\right) = \left(\frac{T^2}{4}\right) \left(\frac{1 + 2z^{-1} + z^{-2}}{1 - 2z^{-1} + z^{-2}}\right)$$

The corresponding difference equation used to calculate the displacement $y[\bullet]$ from the acceleration $y_{\text{ad}}[\bullet]$ is $4(y[n] - 2y[n - 1] + y[n - 2]) = T^2(y_{\text{ad}}[n] + 2y_{\text{ad}}[n - 1] + y_{\text{ad}}[n - 2])$. However, accelerometers generally do not have good response at low frequencies; in fact, they often insert a bias in the data yielding a drift in the calculated displacement. They also are very sensitive to random vibrations. An alternate approach is to process the acceleration data through a bandpass filter before using the difference equation to integrate it numerically. The bandpass range must contain the natural frequencies in the system.

Consider, for example, the acceleration data shown in Fig. 29.11, which has some random noise. This signal is sampled at a rate of 6400 Hz, where the natural frequency of the system is 50 Hz. Figure 29.12 shows the actual displacement, while Fig. 29.13 shows the estimated displacement calculated by numerically integrating the acceleration data, using the difference equation given above. This estimation is very poor. Alternatively, an analog eighth-order Chebyshev Type I bandpass filter with passband 25–500 Hz

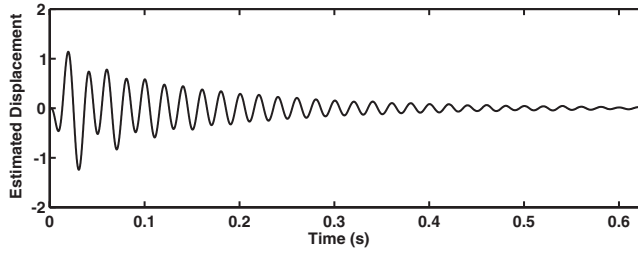

FIGURE 29.14 Estimated displacement with IIR prefilter.

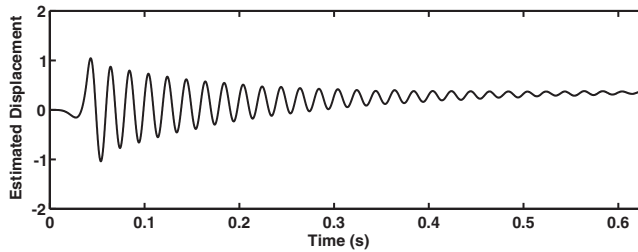

FIGURE 29.15 Estimated displacement with FIR prefilter.

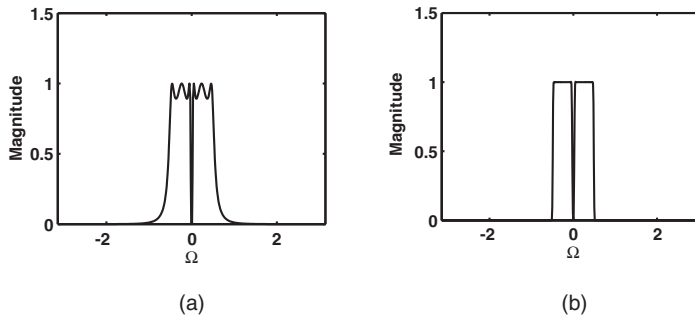

FIGURE 29.16 Digital bandpass filters: (a) Chebyshev IIR and (b) FIR filter.

is designed and then discretized using the bilinear transformation. The acceleration data is processed through this filter first, and then the filtered data are numerically integrated with the result shown in Fig. 29.14. Notice that the estimate is much better than that obtained without the bandpass filter. A 500th order FIR bandpass is also designed for this example with passband 25–500 Hz. After passing the data through the FIR filter, it is then numerically integrated resulting in the estimated displacement shown in Fig. 29.15. Due to the linear phase characteristic of the FIR filter, it has less transient distortion than the IIR filter, but it adds a larger lag. The larger the order, the more accurate the result, since less significant information is lost in truncating the impulse response of the ideal IIR bandpass filter, but the lag is larger. The magnitudes of the IIR filter and the FIR bandpass filters are shown in Fig. 29.16.

Two observations on this example should be mentioned:

1. The unfiltered calculation was extremely sensitive to bias in the data (as expected from the double integration). Therefore, the bias was removed from the acceleration before processing. Both filters effectively removed bias, so the results were virtually unchanged if the bias was present.
2. The FIR filter shows some drift. Presumably, the cause of the drift is that the filter seems to have some difficulty with the small stopband region near the origin. Increasing the stopband region

does reduce the drift. This can be done by decreasing the sample frequency or by increasing the passband frequency. Both of these remedies decrease the drift but increase other errors in the signal. Increasing the length of the filter decreases the drift error without introducing other errors.

Some of the Matlab commands used to design the filters and generate the results are:

```
[num,den] = c2dm(1,[1 0 0],T,'tustin'); %digitize 1/s^2
y1 = filter(num,den,ydd); % double integration of ydd

Wbreak = [2*pi*25*T, 2*pi*500*T]; % digital break frequencies
[b,a] = cheby1(4,1,Wbreak); % design IIR filter with 1dB ripple

W = -pi:pi/200:pi; % define digital frequency range for plot
H = freqz(b,a,W); % get frequency response
plot(W,abs(H)); % plot magnitude of frequency response

yddfilt = filter(b,a,ydd); % calculate output of IIR filter
y2 = filter(num,den,yddfilt); % double integration of yddfilt

hfir = fir1(500,Wbreak); % design FIR filter of order 500
yddfilt = filter(hfir,1,ydd); % calculate output of FIR filter
y3 = filter(num,den,yddfilt); % double integration of yddfilt
```

29.5 Digital Control Design

As in the digital filter design case, there are two general methods for designing a digital controller: an *indirect method* that is based on discretizing an analog design, and a *direct method* that is based on discretizing a plant (usually using the step-response matching method) and then designing the controller directly in the discrete domain. Most engineers learn classical continuous-time controls, and it is common for them to have more training in continuous-time control design than in discrete-time or digital control design. Fortunately, continuous-time control tools can often be used when designing digital control systems. To make use of controllers designed in the continuous-time domain, an s -plane to z -plane mapping is used. Any of the mappings discussed in this chapter can be used for a variety of controllers. It is always best to determine the mapping that is most efficient for a particular control or filter. Even though the bilinear approximation is more complex than the forward or backward approximations, it is used for most mechatronic systems. This is due to the fact that most modern controllers have enough computational power to manage the increased complexity at the required bandwidth of the mechatronic system.

As an example of the indirect design method, consider a PD (proportional derivative) controller that may be used to enhance the performance of a system. The derivative and proportional gains for the controller are K_d and K_p , respectively. The PD controller, $K(s)$, is given by

$$K(s) = K_d s + K_p. \quad (29.6)$$

Equation (29.6) can be implemented digitally using any of the s -plane to z -plane mappings discussed earlier in this chapter. As an example, the bilinear transformation is used generating the digital controller, $K(z)$.

$$K(z) = K(s) \Big|_{s=\frac{2(z-1)}{T(z+1)}} = \frac{(2K_d + TK_p)z + (TK_p - 2K_d)}{Tz + T} \quad (29.7)$$

Besides the control gains, the only factor that is needed for Eq. (29.7) is T , the sample time. As previously stated, the sample time should be at least a factor of 5–10 times the fastest system time constant.

However, sampling times are often chosen to be several hundred times faster than the fastest system time constant. An alternative strategy for a feedback system is to choose the sample rate to be at least 20 times the desired closed loop bandwidth. Having sampling times that are substantially faster than the actual system mitigates any differences between the controller as it is designed in the continuous domain and the implementation in the discrete domain. It should be noted that as the sampling frequency becomes higher, the control gains become smaller. For example, in Eq. (29.7), as the sampling time becomes smaller, T becomes smaller requiring better numerical resolution for the controller gains. If T becomes smaller than the controller's numerical gain resolution, it may be erroneously implemented at a value of 0 (zero) yielding an incorrect control law.

Digital Control Example

Consider a high speed position motor with motor dynamics governed by the first-order equation

$$G(s) = \frac{\omega(s)}{V_{in}(s)} = \frac{K_m}{T_m s + 1}$$

where K_m is the motor gain constant, T_m is the motor time constant, $\omega(s)$ is the Laplace transform of the motor velocity, and $V_{in}(s)$ is the Laplace transform of the motor input voltage. To determine the values of T_m and K_m , the velocity step response of the motor is used. Figure 29.17 is the response of the motor to a 1-V step input. The motor gain, K_m , is the steady-state value of the final motor speed and is 5. This result can also be determined using the Final Value Theorem as

$$\begin{aligned} \lim_{t \rightarrow \infty} \omega(t) &= \lim_{s \rightarrow 0} s \omega(s) = \lim_{s \rightarrow 0} s G(s) V_{in}(s) \\ &= \lim_{s \rightarrow 0} s G(s) \frac{1}{s} = \lim_{s \rightarrow 0} s \frac{K_m}{T_m s + 1} \frac{1}{s} = K_m \end{aligned}$$

The motor time constant, T_m , can be computed by determining the motor velocity for the step response at time $t = T_m$ as follows:

$$\omega(t = T_m) = K_m(1 - e^{-t/T_m}) = K_m(1 - e^{-1}) = 0.632K_m$$

So the time required for the motor to reach 63.2% of its steady-state step response is its time constant. From Fig. 29.18, the time constant of this motor is 0.05 s. Thus, the transfer function for the motor is given by

$$G(s) = \frac{\omega(s)}{V_{in}(s)} = \frac{K_m}{T_m s + 1} = \frac{5}{0.05s + 1} \quad (29.8)$$

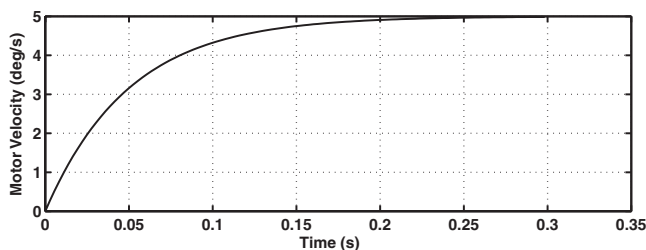

FIGURE 29.17 Motor velocity step response.

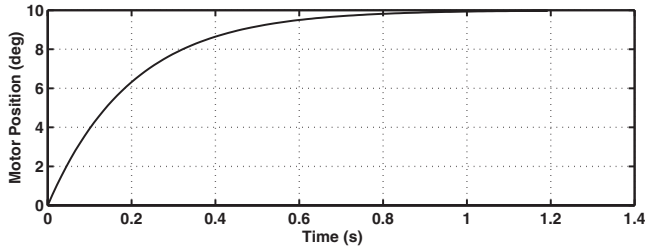

FIGURE 29.18 Closed-loop position response.

For this example, the motor is used in position control mode. Since the motor position is the integral of its velocity, Eq. (29.8) can be augmented with an integrator to generate the transfer function of the motor relating the input voltage to the output position, $\theta(s)$:

$$G_p(s) = \frac{\theta(s)}{V_{in}(s)} = \frac{K_m}{s(T_m s + 1)} \quad (29.9)$$

A PD controller is chosen for use in this example in order to enhance the system performance. To achieve a fast response with no overshoot, the derivative gain, K_d , and the proportional gain, K_p , are chosen to be 0.05 and 1, respectively, yielding the following control law:

$$K(s) = K_d s + K_p = 0.05 s + 1 \quad (29.10)$$

Nominally, this design cancels the high frequency pole of the motor dynamics given in Eq. (29.9).

A sample period of 1 ms is chosen for this example as it is significantly faster than the system's time constants, and it is not an unreasonable value given modern digital controllers. As previously discussed, using a 1-kHz (1 ms) sample frequency mitigates any differences between the controller as it is designed in the continuous domain and its implementation is in the discrete domain. Using the bilinear transformation given in the section "s-Plane to z-Plane Mappings" results in a digital controller of the form:

$$K_D(z) = \frac{101z - 99}{z + 1}$$

In fact, the closed-loop response of the system using the digital controller cannot be easily distinguished from that of the system using the analog controller given by Eq. (29.10). The closed-loop position response of the motor for a 10° command input is shown in Fig. 29.18.

As mentioned in section the "Filtering Examples," 60 Hz noise is often present in measurements of electro-mechanical systems, so a bandstop filter is often used to attenuate the noise. In the closed-loop operation, the digital bandpass filter is cascaded with the digital PD controller.

References

1. Kamen, E.W., and Heck, B.S., *Signals and Systems Using the Web and Matlab*, 2nd ed., Prentice-Hall, Englewood Cliffs, NJ, 2000.
2. Britton Rorabaugh, C., *Digital Filter Designer's Handbook: with C++ Algorithms*, 2nd ed., McGraw-Hill, New York, 1997.

30

Control System Design Via \mathcal{H}^2 Optimization

| | |
|------|---|
| 30.1 | Introduction |
| 30.2 | General Control System Design Framework Central Idea: Design Via Optimization • The Signals • General \mathcal{H}^2 Optimization Problem • Generalized Plant • Closed Loop Transfer Function Matrices • Overview of \mathcal{H}^2 Optimization Problems to Be Considered |
| 30.3 | \mathcal{H}^2 Output Feedback Problem Hamiltonian Matrices |
| 30.4 | \mathcal{H}^2 State Feedback Problem Generalized Plant Structure for State Feedback • State Feedback Assumptions |
| 30.5 | \mathcal{H}^2 Output Injection Problem Generalized Plant Structure for Output Injection • Output Injection Assumptions |
| 30.6 | Summary |

Armando A. Rodriguez
Arizona State University

30.1 Introduction

This chapter addresses control system design via \mathcal{H}^2 (quadratic) optimization. A unifying framework based on the concept of a generalized plant and weighted optimization permits designers to address state feedback, state estimation, dynamic output feedback, and more general structures in a similar fashion. The framework permits one to easily incorporate design parameters and/or weighting functions that may be used to influence the outcome of the optimization, satisfy desired design specifications, and systematize the design process. Optimal solutions are obtained via well-known Riccati equations; e.g., Control Algebraic Riccati Equation (CARE) and Filter Algebraic Riccati Equation (FARE). While dynamic weighting functions increase the dimension of the Riccati equations being solved, solutions are readily obtained using today's computer-aided design software (e.g., MATLAB, robust control toolbox, μ -synthesis toolbox, etc.).

In short, \mathcal{H}^2 optimization generalizes all of the well-known quadratic control and filter design methodologies:

- Linear Quadratic Regulator (LQR) design methodology [7,11],
- Kalman–Bucy Filter (KBF) design methodology [5,6],
- Linear Quadratic Gaussian (LQG) design methodology [4,10,11].

\mathcal{H}^2 optimization may be used to systematically design constant gain state feedback control laws, state estimators, dynamic output controllers, and much more.

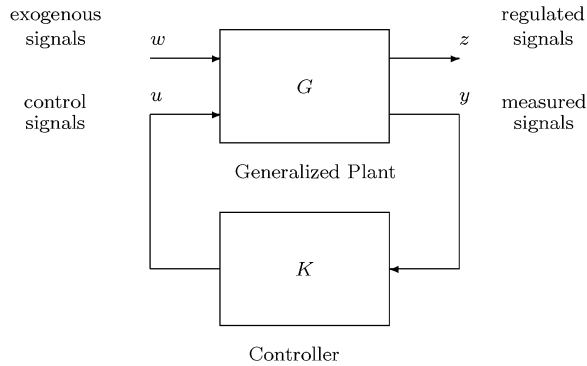

FIGURE 30.1 Generalized feedback system.

30.2 General Control System Design Framework

In this section, we present a general framework for control system (and estimator) design. Toward this end, we consider the generalized feedback system in Fig. 30.1. In this figure, G represents a *generalized plant*. G contains a model for the actual plant P (physical system) to be controlled. It may also contain additional (frequency dependent) weighting functions that are used to address closed loop design objectives. K represents a controller or compensator to be designed.

Central Idea: Design Via Optimization

The central idea here is that many important problems that arise in controls, estimation, filtering, and other areas of engineering may be cast in terms of a generalized plant G and a controller K to be designed by minimizing some norm (e.g., \mathcal{H}^2) on the closed loop transfer function matrix T_{wz} from the signals w to the signals z .

The Signals

To appreciate the flexibility of our generalized feedback system structure, it suffices to consider the nature of the signals z , u , w , and y in the figure. These signals may be described as follows:

- *Regulated Signals.* The signals $z \in \mathcal{R}^{n_z}$ represent *regulated signals* or signals that we would like to keep “small” in some sense, which depends on the application and desired performance objectives. Such signals might include tracking errors, actuator or control inputs, signal estimation errors, etc.
- *Control Signals.* The signals $u \in \mathcal{R}^{n_u}$ represent *control signals* or *manipulated variables* that are generated by the controller K . Control signals might include fuel flow to an engine, voltage applied to a dc motor, etc. They might also include state estimates provided by K . The idea is for K to manipulate and coordinate control signals u in a manner which keeps the regulated signals z “small.” In practice, we typically have more signals that require “regulation” than controls (i.e., $n_z \geq n_u$). It should be noted, however, that generally if we want to independently control m quantities, then we need at least m independent controls. This basic tenet must be adhered to in practice. The more independent controls u that are available, the easier (in principle) it is to influence the signals z to be regulated.
- *Exogenous Signals.* The signals $w \in \mathcal{R}^{n_w}$ represent *exogenous (or external) signals* that act upon the system. Exogenous signals may include reference commands issued to the control system, disturbances acting on the system, sensor noise, etc.

- *Measurement Signals.* The signals $y \in \mathcal{R}^{n_y}$ represent measurements or signals that are directly available to the controller K . Measurements may include a portion of or all of the plant state variables, measurable plant “outputs,” measurable control signals, measurable exogenous signals, etc. In practice, we typically have more exogenous signals than measurements (i.e., $n_w \geq n_y$). Generally, the more independent measurements we have the better—since, in theory, more useful information can be extracted.

Comment 30.1 (Toward a Separation Principle)

It is natural to associate the controls u with the regulated signals z . One might argue that the pair implicitly defines a regulation or control problem. This is analogous to the situation addressed in classical LQR problems. In such problems, one trades off control action (size) versus speed of regulation.

Similarly, it is natural to associate the exogenous signals w with the measurements y . One might argue that the pair implicitly defines an information extraction or estimation problem. This is analogous to the situation addressed in classical KBF problems. In such problems, one trades off sensor cost (or immunity to noise) versus speed of estimate construction.

Such associations suggest that just as in classical LQG problems, our surprisingly general structure may give rise to a natural separation principle. Indeed, this will be the case for the so-called \mathcal{H}^2 output feedback problem that we consider. ■

General \mathcal{H}^2 Optimization Problem

The so-called general \mathcal{H}^2 optimization problem may be stated as follows:

- Find a proper real-rational (finite dimensional) controller K that internally stabilizes G such that the \mathcal{H}^2 norm of the closed loop system transfer function matrix $T_{wz}(K)$ is minimized:

$$\min_K \|T_{wz}(K)\|_{\mathcal{H}^2} \quad (30.1)$$

where

$$\|F\|_{\mathcal{H}^2} \stackrel{\text{def}}{=} \sqrt{\frac{1}{2\pi} \int_{-\infty}^{\infty} \text{trace}\{F^H(j\omega)F(j\omega)\} d\omega} \quad (30.2)$$

$$= \sqrt{\int_0^{\infty} \text{trace}\{f^H(t)f(t)\} dt} \quad (30.3)$$

$$= \|f\|_{\mathcal{L}^2(\mathcal{R}_+)} \quad (30.4)$$

and f is the impulse response matrix associated with the transfer function matrix F .

Comment 30.2 (Use of Two Norm: Wide Band Exogenous Signals)

Noting that the two norm measures the energy of the response to an impulse and noting that the transform of unit Dirac delta function δ is unity, it follows that the two norm is appropriate when the exogenous signals w are wide band in nature. This can always be justified by introducing appropriate (low pass) filters within G . It should be noted that these ideas have stochastic interpretations as well. Instead of unit delta functions, one instead deals with white noise with unit intensity. ■

Comment 30.3 (Control and Estimation Problems)

Although we are seeking an \mathcal{H}^2 optimal controller, it must be noted that the generalized plant framework will enable the design of state estimators as well as dynamic and constant gain control laws. ■

Given the above problem statement, it is appropriate to recall the following elementary result:

Lemma 30.1 (Two Norm of a Stable System)

Consider a causal stable LTI strictly proper system $F = [A, B, C]$. It follows that

$$\|F\|_{\mathcal{H}^2} = \|f\|_{\mathcal{L}^2(\mathcal{X}^+)} = \sqrt{CL_c C^H} = \sqrt{B^H L_o B} \quad (30.5)$$

where L_c is the system controllability gramian and L_o is the system observability gramian. The controllability gramian

$$L_c \stackrel{\text{def}}{=} \int_0^\infty e^{At} B B^H e^{A^H t} dt \quad (30.6)$$

is the unique symmetric (at least) positive semi-definite solution of the algebraic Lyapunov equation

$$A L_c + L_c A^H + B B^H = 0 \quad (30.7)$$

L_c is positive definite if and only if (A, B) is controllable. The observability gramian

$$L_o \stackrel{\text{def}}{=} \int_0^\infty e^{A^H t} C^H C e^{At} dt \quad (30.8)$$

is the unique symmetric (at least) positive semi-definite solution of the algebraic Lyapunov equation

$$A^H L_o + L_o A + C^H C = 0 \quad (30.9)$$

L_o is positive definite if and only if (A, C) is observable. ■

Comment 30.4 (\mathcal{H}^2 Norm May Mislead— \mathcal{L}^∞ Norm Is Important)

It is important to note that the $\mathcal{H}^2/\mathcal{L}^2$ norm (or energy) of a function may be very small, while the function itself may be very large in amplitude. Consider a tall thin pulse, for example. This observation is critical because there are many important cases in which we are very concerned with the height of a function—more so than its energy. A good example of this comes from classical Nyquist stability theory [2,8]. Nyquist taught us that the peak magnitude of the sensitivity function $S = 1/(1 + L)$ associated with a standard negative feedback loop is very important in terms of the feedback loop's stability robustness. A large sensitivity means that the Nyquist plot comes close to the critical -1 point—implying that a small perturbation (or unanticipated modeling error) may cause the closed loop system to go unstable. To assist us with this fundamental issue we may use frequency dependent weighting functions, but what we really need is a norm that directly addresses such concerns. This motivates the so-called \mathcal{H}^∞ and \mathcal{L}^∞ norms as well as $\mathcal{H}^\infty/\mathcal{L}^\infty$ control theory [4,11]. ■

Comment 30.5 (Computation of \mathcal{H}^2 Norm in MATLAB)

The \mathcal{H}^2 norm of a system $F = [A, B, C, D]$ may be computed using the following MATLAB command sequence:

```
lc = lyap (a, b*b')
twonorm = sqrt (trace(c*lc*c'))
```

or

```
lo = lyap (a', c*c')
twonorm = sqrt (trace(b'*lo*b)).
```

■

Generalized Plant

The generalized plant G is assumed to possess the following two-port state space structure:

$$G = \left[\begin{array}{c|c} G_{11} & G_{12} \\ \hline G_{21} & G_{22} \end{array} \right] = \left[\begin{array}{c|cc} A & B_1 & B_2 \\ \hline C_1 & 0_{n_z \times n_w} & D_{12} \\ C_2 & D_{21} & 0_{n_y \times n_u} \end{array} \right] = \left[\begin{array}{c|c} A & B \\ \hline C & D \end{array} \right] \quad (30.10)$$

where $G_{ij}(s) = C_i(sI - A)^{-1}B_j$, $A \in \mathcal{R}^{n \times n}$, $B_1 \in \mathcal{R}^{n \times n_w}$, $B_2 \in \mathcal{R}^{n \times n_u}$, $C_1 \in \mathcal{R}^{n_z \times n}$, $C_2 \in \mathcal{R}^{n_y \times n}$, $D_{12} \in \mathcal{R}^{n_z \times n_u}$, $D_{21} \in \mathcal{R}^{n_y \times n_w}$.

Comment 30.6 (Weighting Functions: Satisfying Closed Loop Design Specifications)

As stated earlier, the generalized plant G may contain frequency dependent weighting functions as well as a model for the physical system P (plant) being controlled. Typically $P = G_{22} = [A, B_2, C_2]$. Weighting functions within G may be viewed as design parameters (mathematical knobs) that may be manipulated by a designer to influence the \mathcal{H}^2 problem in a manner which results in a controller that is not just optimal—a notion that is often irrelevant in practical applications—but which satisfies desired closed loop design specifications. Weighting functions may be used to weight (penalize) tracking errors, actuator and other signal levels, state estimation errors, etc. By making the weight on a signal large in a specific frequency range, we are indirectly telling the optimization problem to find a controller that makes the signal small in that frequency range. By making the weight on a signal small in a specific frequency range, we are indirectly conveying our willingness to tolerate a signal which is large in that frequency range. This idea can be illustrated via example. ■

Comment 30.7 ($D_{11} = 0$ Necessary, $D_{22} = 0$ Not Necessary)

$D_{11} = 0$ Necessary. Note that we have assumed that $D_{11} = 0$; i.e., there is no direct path from the exogenous signals w to the regulated signals z . This assumption is essential for the \mathcal{H}^2 norm of the closed loop transfer function T_{wz} to be finite. If $D_{11} \neq 0$, then $\|T_{wz}\|_{\mathcal{H}^2}$ will be infinite and the \mathcal{H}^2 problem will be ill-posed; i.e., make no sense. If we have a nonzero D_{11} , adding strictly proper filters on either w or z (e.g., $[1000/(s + 1000)]I$) will result in $D_{11} = 0$. In this sense, the assumption is not restrictive.

$D_{22} = 0$ Not Necessary. It has also been assumed that $D_{22} = 0$; i.e., the transfer function matrix D_{22} from controls u to measurements y is strictly proper. This assumption is very realistic since G_{22} (our plant P) is typically strictly proper in practice. If not, high frequency dynamics (e.g., actuator dynamics, flexible modes, parasitics, etc.) may be included to make it strictly proper. One might even include a simple high bandwidth low pass filter (e.g., $1000/(s + 1000)$) to make G_{22} strictly proper. If this is not desirable because of the increased dimension, there is an alternative that does not increase the dimension of G .

- One can always remove D_{22} from G_{22} to obtain a new generalized plant \hat{G} with $\hat{D}_{22} = 0$. The term D_{22} is then absorbed into an augmented controller \hat{K} by noting that u is related to y as follows:

$$u = K[y + D_{22}u] = [I - KD_{22}]^{-1}Ky \quad (30.11)$$

Noting this, it follows that the augmented controller, denoted \hat{K} , is given by

$$\hat{K} = [I - KD_{22}]^{-1}K \quad (30.12)$$

The \mathcal{H}^2 problem can then be carried out for \hat{G} and \hat{K} (without regard to D_{22}). When the optimal controller \hat{K} for \hat{G} is obtained, one can compute the optimal controller K for G using the relationship

$$K = \hat{K}[I + D_{22}\hat{K}]^{-1} \quad (30.13)$$

With this stated, the assumption $D_{22} = 0$ is made without any loss of generality. ■

Closed Loop Transfer Function Matrices

Given the structure for the generalized plant G , we have the following closed loop relationships:

$$u = Ky \tag{30.14}$$

$$= K(G_{21}w + G_{22}u) \tag{30.15}$$

$$= [I - KG_{22}]^{-1}KG_{21}w \tag{30.16}$$

$$= K[I - G_{22}K]^{-1}G_{21}w \tag{30.17}$$

$$y = [I - G_{22}K]^{-1}G_{21}w \tag{30.18}$$

$$z = G_{11}w + G_{12}u \tag{30.19}$$

$$= G_{11}w + G_{12}Ky \tag{30.20}$$

$$= [G_{11} + G_{12}K[I - G_{22}K]^{-1}G_{21}]w \tag{30.21}$$

From this, we have the following closed loop transfer function matrices:

$$T_{wu} = K[I - G_{22}K]^{-1}G_{21} \tag{30.22}$$

$$T_{wy} = [I - G_{22}K]^{-1}G_{21} \tag{30.23}$$

$$T_{wz} = G_{11} + G_{12}K[I - G_{22}K]^{-1}G_{21} \tag{30.24}$$

We say that each of these is a *linear fractional transformation (LFT)* involving K .

Comment 30.8 (Well Posedness of Closed Loop System)

In the above manipulation, it has been assumed that the inverse $[I - G_{22}K]^{-1}$ is well defined. This well posedness condition is guaranteed by our assumption that $D_{22} = 0$. This assumption implies that $G_{22}(j\infty) = D_{22} = 0$ and hence that the inverse is well defined. ■

The following example shows how to formulate a so-called Weighted \mathcal{H}^3 Mixed Sensitivity Problem to address feedback control system design issues.

Example 30.1 (Weighted \mathcal{H}^2 Mixed Sensitivity Problem: Design Philosophy)

This example considers the design of a controller K for a plant $P = [A_p, B_p, C_p, D_p]$ as shown in Fig. 30.2. To obtain K , we will formulate an \mathcal{H}^2 optimization that considers (directly or indirectly) various issues that are of importance in the design of a good feedback loop.

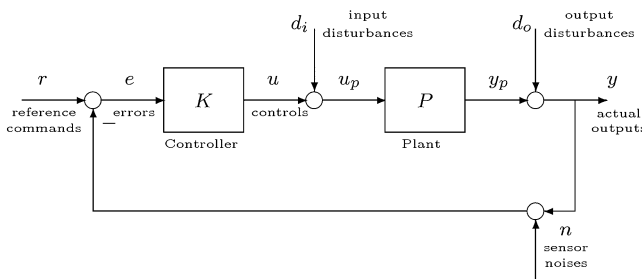

FIGURE 30.2 Standard negative feedback loop.

Feedback System Performance Issues. Generally, in designing a feedback controller K as shown in Fig. 30.2, a designer must consider each of the following closed loop performance issues:

- *Closed Loop Stability.* The closed loop system should be stable. This involves all closed loop transfer function matrices since we generally want all of them to be stable. A strictly proper closed loop transfer function matrix whose \mathcal{H}^2 norm is infinite, for example, implies that the transfer function matrix is unstable (or marginally stable). Stable strictly proper transfer function matrices necessarily have a finite \mathcal{H}^3 norm.
- *Command Following.* The closed loop system should exhibit good low frequency reference command following; i.e., the output y (not to be confused with generalized plant measurements) should track low frequency reference commands r that are issued to the feedback system. This typically requires that the sensitivity transfer function matrix

$$S \stackrel{\text{def}}{=} [I + PK]^{-1} \quad (30.25)$$

be small at low frequencies.

- *Disturbance Attenuation.* The closed loop system should exhibit good low frequency disturbance attenuation. For disturbances d_o , modeled at the plant output, this requires that the sensitivity transfer function matrix be small at low frequencies. For disturbances d_i , modeled at the plant input, this requires that

$$T_{d,y} \stackrel{\text{def}}{=} SP \quad (30.26)$$

be small at low frequencies.

- *Sensor Noise Attenuation.* The closed loop system should exhibit good high frequency noise n attenuation. This typically requires that the complementary sensitivity transfer function matrix

$$T \stackrel{\text{def}}{=} I - S \quad (30.27)$$

be small at high frequencies.

- *Stability Robustness.* The closed loop system should exhibit robustness with respect to high frequency unmodeled dynamics (e.g., flexible modes, parasitic dynamics, time delays, etc.); This typically requires that the “peak” of some closed loop transfer function matrix be small at high frequencies.

- *Multiplicative Modeling Error.* For a plant modeled as

$$P_{\text{act}} = [I + \Delta]P \quad (30.28)$$

where P_{act} represents the actual plant, P represents a nominal model, and Δ represents a stable multiplicative perturbation at the plant output, the relevant closed loop transfer function matrix (that seen by Δ) is T .

- *Additive Modeling Error.* For a plant modeled as

$$P_{\text{act}} = P + \Delta \quad (30.29)$$

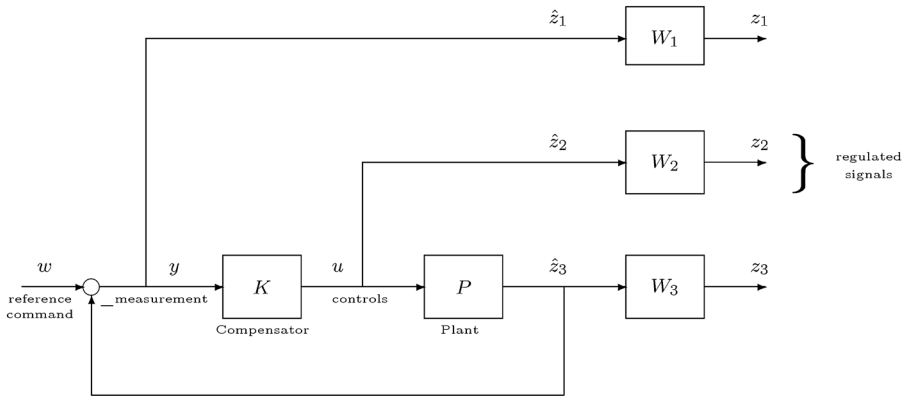

FIGURE 30.3 Negative feedback system for weighted mixed sensitivity problem.

where P_{act} represents the actual plant, P represents a nominal model, and Δ represents a stable additive perturbation, the relevant closed loop transfer function matrix (that seen by Δ) is KS .

- *Reasonable Control Action.* The closed loop system should exhibit reasonably sized control action for typical reference commands and sensor noise. This typically requires that the “size” of KS be controlled. Too much lead (i.e., derivative action) in K may help in terms of stabilization, achieving a high bandwidth and phase margin, but it may result in controls that are unnecessarily large in the presence of typical reference commands r and sensor noise n .

The above list suggests that there are many important issues that impact the control system design process. Part of a designer’s job, however, is to prioritize and select issues that are most important. Toward this end, we turn our attention away from Fig. 30.2 and consider instead the “fictitious” (mathematical) system depicted in Fig. 30.3.

Weighting Functions and Closed Loop Transfer Function Matrix

Figure 30.3 includes specific weighting functions that will help us formulate an \mathcal{H}^2 optimization that (directly or indirectly) addresses some of the issues mentioned above. The figure shows a weighting W_1 on the signal y (the tracking error), a weighting W_2 on the controls u , and a weighting W_3 on the plant outputs \hat{z}_3 . From the figure, it follows that regulated signals

$$z = \begin{bmatrix} z_1 \\ z_2 \\ z_3 \end{bmatrix}$$

are related to the exogenous signals w as follows:

$$z_1 = W_1 \hat{z}_1 = W_1 S w \quad (30.30)$$

$$z_2 = W_2 \hat{z}_2 = W_2 K S w \quad (30.31)$$

$$z_3 = W_3 \hat{z}_3 = W_3 T w \quad (30.32)$$

From this, it follows that the closed loop transfer function matrix from w to z is given by

$$T_{wz} = \begin{bmatrix} W_1 S \\ W_2 K S \\ W_3 T \end{bmatrix} \quad (30.33)$$

Since T_{wz} involves various “sensitivity” transfer function matrices, we say that we have a weighted mixed sensitivity problem.

Selection of Weighting Functions

Typically, the weighting functions W_1 , W_2 , W_3 are selected to be stable transfer function matrices that are (at least initially) diagonally structured.

- *Sensitivity Weighting.* One might select the sensitivity weighting W_1 on the sensitivity S as follows:

$$W_1 = \left[\frac{k_1}{s + \epsilon} \right] I_{n_y \times n_y} \quad (30.34)$$

where $k_1, \epsilon > 0$. The parameter k_1 is typically selected to be large. The parameter ϵ is typically selected to be small. Such selections are made so that S is heavily penalized at low frequencies—precisely where we want K to make S small.

- *Control Weighting.* One might select the control weighting W_2 on KS as follows:

$$W_2 = k_2 I_{n_u \times n_u} \quad (30.35)$$

where $k_2 > 0$ provides a nonsingular penalty on the controls u (i.e., on KS).

- *Output Weighting.* One might select the output weighting W_3 on T as follows:

$$W_3 = \left[\frac{k_3(s + z_3)}{s + p_3} \right] I_{n_y \times n_y} \quad (30.36)$$

with $k_3 > 0$ and $z_3 < p_3$. Such a weighting would penalize T more heavily at higher frequencies.

In general, care must be taken in selecting the structure of weighting functions. Inappropriate selections may result in an ill-posed problem and a very arduous design process. For example, W_1 must be strictly proper for \mathcal{H}^2 problems—otherwise the \mathcal{H}^2 norm of $W_1 S$ makes no sense (since S approaches the identity at high frequencies). While there exists no precise systematic method for the selection of weighting functions, the above structures seem to work well (as starting points) in many applications.

Input–Output Representation for Generalized Plant G

To obtain an input–output (transfer function matrix) description for our generalized plant, we must express the regulated signals z_1, z_2, z_3 and the measurements y in terms of the exogenous signals w and the controls u . Doing so yields

$$z_1 = W_1 \hat{z}_1 = W_1(w - Pu) = W_1 w - W_1 P u \quad (30.37)$$

$$z_2 = W_2 \hat{z}_2 = W_2 u \quad (30.38)$$

$$z_3 = W_3 \hat{z}_3 = W_3 P u \quad (30.39)$$

$$y = w - \hat{z}_3 = w - P u \quad (30.40)$$

From this, we obtain the following input–output (transfer function matrix) description for our generalized plant G :

$$\begin{bmatrix} z \\ y \end{bmatrix} = \begin{bmatrix} G_{11} & G_{12} \\ G_{21} & G_{22} \end{bmatrix} \begin{bmatrix} w \\ u \end{bmatrix} \quad (30.41)$$

or

$$\begin{bmatrix} z_1 \\ z_2 \\ z_3 \\ y \end{bmatrix} = \left[\begin{array}{cc|c} W_1 & -W_1P & \\ \hline 0 & W_2 & \\ 0 & W_3P & \\ \hline I & -P & \end{array} \right] \begin{bmatrix} w \\ u \end{bmatrix} \quad (30.42)$$

State Space Representation for Generalized Plant G

Next we obtain a two-port state space representation for G . To do so, we assume the following state space representations:

$$P = [A_p, B_p, C_p, D_p] \quad \text{with state } x_p \quad (30.43)$$

$$W_1 = [A_1, B_1, C_1, D_1] \quad \text{with state } x_1 \quad (30.44)$$

$$W_2 = [A_2, B_2, C_2, D_2] \quad \text{with state } x_2 \quad (30.45)$$

$$W_3 = [A_3, B_3, C_3, D_3] \quad \text{with state } x_3 \quad (30.46)$$

To obtain the desired state space representation for G , we need to express the signals $(\{\dot{x}_i\}_{i=1}^3, \dot{x}_p, \{z_i\}_{i=1}^3, y)$ in terms of the signals $(\{x_i\}_{i=1}^3, x_p, w, u)$. This is just a matter of simple bookkeeping. Doing so yields the following:

$$\dot{x}_1 = A_1x_1 + B_1y = A_1x_1 + B_1(w - C_px_p - D_pu) = A_1x_1 - B_1C_px_p - B_1D_pu \quad (30.47)$$

$$\dot{x}_2 = A_2x_2 + B_2u \quad (30.48)$$

$$\dot{x}_3 = A_3x_3 + B_3\hat{z}_3 = A_3x_3 + B_3(C_px_p + D_pu) = A_3x_3 + B_3C_px_p + B_3D_pu \quad (30.49)$$

$$\dot{x}_p = A_px_p + B_pu \quad (30.50)$$

$$z_1 = C_1x_1 + D_1y = C_1x_1 + D_1(w - C_px_p - D_pu) = C_1x_1 - D_1C_px_p + D_1w - D_1D_pu \quad (30.51)$$

$$z_2 = C_2x_2 + D_2u \quad (30.52)$$

$$z_3 = C_3x_3 + D_3\hat{z}_3 = C_3x_3 + D_3(C_px_p + D_pu) = C_3x_3 + D_3C_px_p + D_3D_pu \quad (30.53)$$

$$y = w - C_px_p - D_pu = -C_px_p + w - D_pu \quad (30.54)$$

The above equations may be written in standard two-port form:

$$\begin{bmatrix} \dot{x} \\ z \\ y \end{bmatrix} = \left[\begin{array}{ccc|c} A & B_{11} & B_{12} & \\ \hline C_{11} & D_{11} & D_{12} & \\ \hline C_{21} & D_{21} & D_{22} & \end{array} \right] \begin{bmatrix} x \\ w \\ u \end{bmatrix} \quad (30.55)$$

as follows:

$$\begin{bmatrix} \dot{x}_1 \\ \dot{x}_2 \\ \dot{x}_3 \\ \dot{x}_p \\ \frac{z_1}{\gamma} \\ z_2 \\ z_3 \\ y \end{bmatrix} = \left[\begin{array}{cc|c|c} A_1 & & -B_1 C_p & -B_1 D_p \\ & A_2 & & B_2 \\ & & A_3 & B_3 D_p \\ & & & B_p \\ \hline C_1 & & -D_1 C_p & D_1 \\ & C_2 & & D_2 \\ & & C_3 & D_3 D_p \\ \hline & & -C_p & I \\ & & & -D_p \end{array} \right] \begin{bmatrix} x_1 \\ x_2 \\ x_3 \\ x_p \\ \frac{w}{\gamma} \\ u \end{bmatrix} \quad (30.56)$$

Checking Assumptions

In selecting the weights, W_1, W_2, W_3 , one must make sure that none of the “standard” \mathcal{H}^2 problem assumptions are violated. Thus far, we require that $D_{11} = 0$ and $D_{22} = 0$. To ensure that $D_{11} = 0$, we need

$$D_1 = 0 \quad (30.57)$$

To ensure that $D_{22} = 0$, we need

$$D_p = 0. \quad (30.58)$$

This results in

$$\begin{bmatrix} \dot{x}_1 \\ \dot{x}_2 \\ \dot{x}_3 \\ \dot{x}_p \\ \frac{z_1}{\gamma} \\ z_2 \\ z_3 \\ y \end{bmatrix} = \left[\begin{array}{cc|c|c} A_1 & & -B_1 C_p & B_2 \\ & A_2 & & \\ & & A_3 & B_3 C_p \\ & & & B_p \\ \hline C_1 & & & \\ & C_2 & & D_2 \\ & & C_3 & \Delta_3 C_p \\ \hline & & -C_p & I \end{array} \right] \begin{bmatrix} x_1 \\ x_2 \\ x_3 \\ x_p \\ \frac{w}{\gamma} \\ u \end{bmatrix} \quad (30.59)$$

In subsequent sections, additional assumptions will be imposed on the two-port state space representation for the generalized plant G . The additional assumptions imposed will depend upon the specific \mathcal{H}^2 problem being considered.

Weighted \mathcal{H}^2 Optimal Mixed Sensitivity Problem

Given the above, the weighted \mathcal{H}^2 optimal mixed sensitivity problem is then to find a real-rational (finite-dimensional) proper internally stabilizing controller K that minimizes $\|T_{wz}\|_{\mathcal{H}^2}$; i.e.,

$$\min_K \|T_{wz}\|_{\mathcal{H}^2} = \min_K \left\| \begin{bmatrix} W_1 S \\ W_2 K S \\ W_3 T \end{bmatrix} \right\|_{\mathcal{H}^2} \quad (30.60)$$

We will show how this optimal control problem—and problems like it—can be readily solved using computer-aided design software (e.g., MATLAB, robust control toolbox, μ -tools). ■

Comment 30.9 (Construction of Generalized Plant G)

Generalized plants G are very easy to construct within SIMULINK. Input port blocks may be used to specify exogenous signals w and controls u . Output port blocks may be used to specify regulated signals z and measurements y . The “linmod” command may be applied to the constructed block diagram (SIMULINK file) to obtain a two-port state space $(A, B = [B_1 \ B_2], C = [C_1; \ C_2], D = [D_{11} \ D_{12}; \ D_{21} \ D_{22}])$ representation for G . The syntax for the command is as follows:

```
[ a, b, c, d ] = linmod ( 'filename' )
```

This method enables one to create generalized plant models quickly. ■

Overview of \mathcal{H}^2 Optimization Problems to Be Considered

Three fundamental problems are considered in this chapter:

1. **\mathcal{H}^2 Output Feedback Problem.** The solution to this problem is an optimal model-based dynamic compensator possessing the structure

$$K_{\text{opt}} = \left[\begin{array}{c|c} A - B_2 G_c - H_f C_2 & H_f \\ \hline -G_c & O_{n_u \times n_n} \end{array} \right] \tag{30.61}$$

where G_c is a control gain (state feedback) matrix and H_f is a filter gain (observer) matrix. G_c is found by using the solution of a Control Algebraic Riccati Equation (CARE)—similar to that found in Linear Quadratic Regulator (LQR) problems. H_f is found by using the solution of a Filter Algebraic Riccati Equation (FARE)—similar to that found in Kalman–Bucy Filtering (KBF) problems. The structure of K_{opt} , G_c , and H_f can be thought of as the solution to a classical Linear Quadratic Gaussian (LQG) control problem which gives rise to the well known separation principle: closed loop poles are the eigenvalues of $A - B_2 G_c$, and the eigenvalues of $A - H_f C_2$.

2. **\mathcal{H}^2 State Feedback Problem.** The solution to this problem is an optimal constant gain (state feedback) compensator possessing the structure

$$K_{\text{opt}} = -G_c \tag{30.62}$$

where G_c is a control gain (state feedback) matrix found by using the solution to a CARE—similar to that found in LQR problems. The poles of the resulting closed loop system are the eigenvalues of $A - B_2 G_c$. In short, this problem should be viewed as a mechanism for computing control gain matrices G_c that may be used in a state feedback application or in a model-based compensator application.

3. **\mathcal{H}^2 Output Injection Problem.** The solution to this problem is an optimal constant gain (static) compensator possessing the structure

$$K_{\text{opt}} = -H_f \tag{30.63}$$

where H_f is a filter gain (observer) matrix found by using the solution to a FARE—similar to that found in KBF problems. The poles of the resulting closed loop system are the eigenvalues of $A - H_f C_2$. In short, this problem should be viewed as a mechanism for computing filter gain matrices H_f that may be used in a state estimation application or in a model-based compensator application.

30.3 \mathcal{H}^2 Output Feedback Problem

In this section, we consider the \mathcal{H}^2 output feedback problem. This problem results in model-based (dynamic) compensators involving a control gain (state feedback) matrix G_c and a filter gain (observer) matrix H_f . As such, the problem generalizes the ideas presented in classical LQG theory.

The following “standard” \mathcal{H}^2 output feedback problem assumption is now made.

Assumption 30.1 (\mathcal{H}^2 Output Feedback Problem)

Throughout this section, it will be assumed that

1. *Plant G_{22} Assumption.* (A, B_2, C_2) stabilizable and detectable.
 - This assumption is necessary and sufficient for the existence of a proper internally stabilizing controller K . With this assumption, the following model based (observer based) controller stabilizes the feedback loop in Fig. 30.1:

$$K = \left[\begin{array}{c|c} A - B_2G_c - H_f(C_2 - D_{22}G_c) & H_f \\ \hline -G_c & O_{n_u \times n} \end{array} \right] \tag{30.64}$$

provided that $(A - B_2G_c)$ and $(A - H_fC_2)$ are stable, as suggested by the classical separation principle from the theory of linear systems.

This assumption mandates that *all of the “bad” open loop poles (right half plane and imaginary) must be controllable through the controls u and observable through the measurements y .*

Suppose that G satisfies the assumption. Consider the augmentation of an integrator I/s (weighting function). Such an augmentation can result in the assumption being violated. Absorbing an integrator I/s (weighting function) on the exogenous signals w into G , for example, would violate the stabilizability assumption since it would introduce an open loop pole on the imaginary axis that is not controllable through the controls u . Absorbing an integrator on the regulated signals z into G would violate the detectability assumption since it would introduce an open loop pole on the imaginary axis that is not observable through the measurements y . Using $I/(s + \epsilon)$ ($\epsilon > 0$) instead of I/s —in either case—would result in a G that does not violate the assumption.

2. *Nonsingular Control Weighting Assumption.* $R = D_{12}^T D_{12} > 0$.
 - This assumption implies that $D_{12} \in \mathcal{R}^{n_z \times n_u}$ has full column rank (i.e., $\text{rank } D_{12} = n_u$) and hence that every control (direction) u influences the regulated signals z through D_{12} (i.e., D_{12} has no right null space). The matrix D_{12} must therefore be “tall” and “thin;” i.e.,

$$(\text{number of regulated signals}) \ n_z \geq n_u \ (\text{number of control signals}) \tag{30.65}$$

The matrix $R = D_{21}^T D_{12} \in \mathcal{R}^{n_u \times n_u}$ may be interpreted as a weighting on the controls u —just like the control weighting matrix “ R ” in LQR problems. As in the LQR problem, we might say that the control weighting R on u is nonsingular. The larger R , the smaller we want our controls to be—sacrificing speed of regulation. A large R results in a low “regulation” bandwidth. The smaller R , the larger we will permit our controls u to be—in order to speed up regulation. A small R results in a high “regulation” bandwidth.

3. *Regulator Assumption.* $\begin{bmatrix} j\omega I - A & -B_2 \\ C_1 & D_{12} \end{bmatrix}$ has full column rank $(n + n_u)$ for all ω .
 - This assumption implies that transfer function matrix from control signals u to regulated signals z has no (right) zero on the imaginary axis. Together with (1) and (2), it will guarantee that the Hamiltonian \mathcal{H}_{con} involving (A, B_2, C_1, D_{12}, R) —that is, associated with the controls u and regulated signals z —will belong to $\text{dom}(\text{Ric})$. This, in turn, guarantees that the solution of the associated CARE results in a control gain matrix $G_c \in \mathcal{R}^{n_u \times n}$ such that $A - B_2G_c$ is stable.

The assumption implies that G has no imaginary modes that are unobservable through the regulated signals z ; that is, all open loop poles on the imaginary axis must be observable through the regulated signals z . (A, C_1) , therefore, cannot possess unobservable imaginary modes. This is a necessary condition. It is not sufficient. An integrator hanging on the measurements y , for example, would violate this.

Since D_{12} has full column rank, the assumption is equivalent to the pair

$$(A - B_2 R^{-1} D_{12}^T C_1, (I - D_{12} R^{-1} D_{12}^T) C_1) \quad (30.66)$$

having no unobservable imaginary modes.

- If D_{12} is square, then it is invertible and the assumption is equivalent to $A - B_2 R^{-1} D_{12}^T C_1$ having no imaginary modes.
- If $D_{12}^T C_1 = 0$ (no cross penalty between controls and states), then the assumption is equivalent to (A, C_1) having no unobservable imaginary modes.

4. Nonsingular Measurement Weighting Assumption. $\Theta = D_{21} D_{12}^T > 0$.

- This assumption implies that $D_{21} \in \mathcal{R}^{n_y \times n_w}$ has full row rank (i.e., $\text{rank } D_{21} = n_y$) and hence that the measurements y are linearly independent through D_{21} (i.e., D_{21} has no left null space). The matrix D_{21} must therefore be “short” and “fat;” i.e.,

$$(\text{number of measurements}) n_y \leq n \text{ (number of exogenous signals)} \quad (30.67)$$

The matrix $\Theta = D_{21} D_{12}^T \in \mathcal{R}^{n_y \times n_y}$ may be interpreted as the intensity of sensor noise impacting the measurements y —just like the sensor noise intensity matrix “ Θ ” found in KBF problems. As in the KBF problem, we say that the intensity matrix Θ associated with the measurements y is nonsingular. The larger Θ , the more we want to low pass filter the measurements y —sacrificing speed of estimation. A large Θ results in a low bandwidth for the associated estimator (observer). The smaller Θ , the less we want to low pass filter the measurements y —trading off our immunity to noise for speed of estimation. A small Θ results in a high bandwidth for the associated estimator (observer).

5. Filter Assumption. $\begin{bmatrix} j\omega I - A & -B_1 \\ C_2 & D_{21} \end{bmatrix}$ has full row rank $(n + n_y)$ for all ω .

- This assumption implies that transfer function matrix from exogenous signals w to measurements y has no (left) zero on the imaginary axis. Together with (1) and (3), it will guarantee that the Hamiltonian \mathcal{H}_{fil} involving $(A, B_1, C_2, D_{21}, \Theta)$ —that is, involving exogenous signals z and measurements y —will belong to $\text{dom}(\text{Ric})$. This, in turn, guarantees that the solution of the associated FARE results in a filter gain matrix $H_f \in \mathcal{R}^{n \times n_y}$ such that $A - H_f C_2$ is stable.

The assumption implies that G has no imaginary modes that are uncontrollable through the exogenous signals w ; that is, all open loop poles on the imaginary axis must be controllable through the exogenous signals w . (A, B_1) , therefore, cannot possess uncontrollable imaginary modes. This is a necessary condition. It is not sufficient. An integrator hanging on the controls u , for example, would violate this.

Since D_{21} has full row rank, the assumption is equivalent to the pair

$$(A - B_1 D_{21}^T \Theta^{-1} C_2, B_1 (I - D_{21}^T \Theta^{-1} D_{21})) \quad (30.68)$$

having no uncontrollable imaginary modes.

- If D_{21} is square, then it is invertible and the assumption is equivalent to $A - B_1 D_{21}^T \Theta^{-1} C_2$ having no imaginary modes.
- If $B_1 D_{21}^T = 0$ (uncorrelated process and sensor noise), then the assumption is equivalent to (A, B_1) having no uncontrollable imaginary modes. ■

Comment 30.10 (Duality Relationships)

In the above discussion, we note the following dual relationships:

$$A \longleftrightarrow A^T \quad (30.69)$$

$$B_2 \longleftrightarrow C_2^T \quad (30.70)$$

$$C_1 \longleftrightarrow B_1^T \quad (30.71)$$

$$D_{12} \longleftrightarrow D_{21}^T \quad (30.72)$$

$$R = D_{12}^T D_{12} \longleftrightarrow \Theta = D_{21} D_{21}^T \quad (30.73)$$

These imply that

- controls u are dual to measurements y
- Regulated signals z are dual to exogenous signals w . ■

Hamiltonian Matrices

Associated with our \mathcal{H}^2 optimal control problem are the following two Hamiltonian matrices:

$$H_{\text{con}} = \begin{bmatrix} A & 0 \\ -C_1^T C_1 & -A^T \end{bmatrix} - \begin{bmatrix} B_2 \\ -C_1^T D_{12}^T \end{bmatrix} R^{-1} \begin{bmatrix} D_{12}^T C_1 & B_2^T \end{bmatrix} \quad (30.74)$$

$$= \begin{bmatrix} A - B_2 R^{-1} D_{12}^T C_1 & -B_2 R^{-1} B_2^T \\ -C_1^T (I - D_{12}^T R^{-1} D_{12}^T) C_1 & -(A - B_2 R^{-1} D_{12}^T C_1)^T \end{bmatrix} \quad (30.75)$$

$$H_{\text{fil}} = \begin{bmatrix} A^T & 0 \\ -B_1 B_1^T & -A \end{bmatrix} - \begin{bmatrix} C_2^T \\ -B_1 D_{21}^T \end{bmatrix} \Theta^{-1} \begin{bmatrix} D_{21} B_1^T & C_2 \end{bmatrix} \quad (30.76)$$

$$= \begin{bmatrix} (A - B_1 D_{21}^T \Theta^{-1} C_2)^T & -C_2^T \Theta^{-1} C_2 \\ -B_1 (I - D_{21}^T \Theta^{-1} D_{21}) B_1^T & -(A - B_1 D_{21}^T \Theta^{-1} C_2) \end{bmatrix} \quad (30.77)$$

The first Hamiltonian is associated with an optimal state feedback control or regulator problem. The second is associated with an optimal filtering or estimation problem.

The solution to the \mathcal{H}^2 output feedback problem is now given [11, pp. 261–262].

Theorem 30.1 (Solution to \mathcal{H}^2 Output Feedback Problem Subject to Standard Assumptions)

Suppose that G satisfies the assumptions given in Assumption 30.1—the so-called standard \mathcal{H}^2 output feedback problem assumptions. Given this, we have the following.

The unique minimizing \mathcal{H}^2 optimal controller is n dimensional (like generalized plant G) and is given by

$$K_{\text{opt}} = \left[\begin{array}{c|c} A - B_2 G_c - H_f C_2 & H_f \\ \hline -G_c & O_{n_u \times n_y} \end{array} \right] \quad (30.78)$$

where the control gain matrix $G_c \in \mathcal{R}^{n_u \times n}$ is given by

$$G_c = R^{-1} [B_2^T X + D_{12}^T C_1] \quad (30.79)$$

$X = \text{Ric}(\mathcal{H}_{con}) \geq 0$ is the unique (at least) positive semi-definite solution of the CARE:

$$(A - B_2 R^{-1} D_{12}^T C_1)^T X + X(A - B_2 R^{-1} D_{12}^T C_1) + C_1^T (1 - D_{12}^T R^{-1} D_{12}^T) C_1 - X B_2 R^{-1} B_2^T X = 0 \quad (30.80)$$

and the filter gain matrix $H_f \in \mathcal{R}^{n \times n_y}$ is given by

$$H_f = [Y C_2^T + B_1 D_{21}^T] \Theta^{-1} \quad (30.81)$$

$Y = \text{Ric}(\mathcal{H}_{fil}) \geq 0$ is the unique (at least) positive semi-definite solution of the FARE:

$$(A - B_1 D_{12}^T \Theta^{-1} C_2) Y + Y(A - B_1 D_{21}^T \Theta^{-1} C_2)^T + B_1 (I - D_{21}^T \Theta^{-1} D_{21}) B_1^T - Y C_2^T \Theta^{-1} C_2 Y = 0 \quad (30.82)$$

Moreover, the minimum norm is given by

$$\|T_{wz}(K_{opt})\|_{\mathcal{L}^2} = \sqrt{\|M_c B_1\|_{\mathcal{L}^2}^2 + \|R^{1/2} G_c M_f\|_{\mathcal{L}^2}^2} \quad (30.83)$$

$$= \sqrt{\text{trace}(B_1^T X B_1) + \text{trace}(R G_c Y G_c^T)} \quad (30.84)$$

where

$$M_c = [A - B_2 G_c, I_{n \times n}, C_1 - D_{12} G_c] \quad (30.85)$$

$$M_f = [A - H_f C_2, I_{n \times n}, B_1 - H_f D_{21}] \quad (30.86)$$

Finally, the closed loop poles are the eigenvalues of $A - B_2 G_c$ and $A - H_f C_2$. ■

Comment 30.11 (Computing Optimal \mathcal{H}^2 Controller in MATLAB)

The following MATLAB command sequence may be used to compute the optimal \mathcal{H}^2 controller K_{opt} and the resulting closed loop transfer function matrix T_{wz} :

```
tss_g = mksys(a, [b1 b2], [c1; c2], [0*ones(nz, nw) d12; d21 0*ones(ny, nu), 'tss')
[ss_k ss_twz] = h2lqg(tss_g, 'schur')
[a_k, b_k, d_k] = branch(ss_k, 'a,b,c,d')
```

The “mksys” command packs the two-port state space data for the generalized plant G into a column vector data structure (called a tree) possessing the “tss” (two-port state space) variable designation. All dimension information is encoded into the column vector. The “h2lqg” command computes the optimal \mathcal{H}^2 controller K_{opt} and the associated closed loop system from the exogenous signals w to the regulated signals z . An eigenvalue-eigenvector method is the default method used to solve the two relevant algebraic Riccati equations. A Schur method—based on Schur’s unitary transformation of a matrix to upper triangular form—may be used by including the “schur” option. The results are stored in the tree vectors ss_k and ss_twz , respectively. The ‘branch’ command is then used to retrieve the state space representation for K_{opt} from the tree vector ss_k . ■

Comment 30.12 (Relationship to LQG, Stability Robustness Margins)

Theorem 30.1 shows that the optimal \mathcal{H}^2 output feedback controller is identical in structure to that found in classical LQG problems. While certain LQR, KBF, and LQG/LTR problem formulations do result in feedback loops possessing stability robustness margins, LQG controllers need not possess margins [3].

The same is true for \mathcal{H}^2 output feedback designs. We will show how the \mathcal{H}^2 framework presented can be manipulated to solve LQG/LTR problems which yield model-based controllers with desirable stability robustness margins—comparable to those found in feedback designs resulting from suitably formulated LQR and KBF problems (e.g., infinite upward gain margin, at least 6 dB downward gain margin, at least $\pm 60^\circ$ phase margin). ■

The following example shows how weighted \mathcal{H}^2 mixed sensitivity optimization may be used to design a controller for an unstable system with a time delay.

Example 30.2 (Weighted \mathcal{H}^2 Mixed Sensitivity Design for Unstable System with Time Delay)

In this example, we consider an unstable system with a time delay $\Delta = 0.05$ s (50 ms). The system is modeled (approximately) as follows:

$$P \approx \frac{1}{s-1} \begin{bmatrix} 2/\Delta - s \\ 2/\Delta + s \end{bmatrix} = \frac{1}{s-1} \begin{bmatrix} 40 - s \\ 40 + s \end{bmatrix} \quad (30.87)$$

Design Specifications. The objective is to design a controller K that satisfies the following closed loop specifications: (1) closed loop stability, (2) sensitivity below -60 dB for all frequencies below 0.1 rad/s, (3) sensitivity gain crossover between 2 and 3 rad/s, (4) peak sensitivity below 5 dB, (5) peak complementary sensitivity below 10 dB.

Weighted \mathcal{H}^2 Mixed Sensitivity Problem. To achieve the above specifications, we formulated a weighted \mathcal{H}^2 mixed sensitivity problem—with a weighting W_1 on the sensitivity S and a weighting W_2 on KS ; i.e.,

$$\min_K \|T_{wz}\|_{\mathcal{H}^2} = \min_K \left\| \begin{bmatrix} W_1 S \\ W_2 KS \end{bmatrix} \right\|_{\mathcal{H}^2} \quad (30.88)$$

The weighting functions used were as follows:

$$W_1 = \frac{k_1}{s+p_1} = \frac{10}{s+0.01} \quad (30.89)$$

$$W_2 = \frac{k_2(s+z_2)}{s+p_2} = \frac{0.1(s+40)}{s+2} \quad (30.90)$$

W_1 penalizes the sensitivity S heavily at low frequencies (e.g., below 0.001 rad/s). Above 0.1 rad/s, W_1 is small and W_2 penalizes KS (with magnitude greater than unity) until about 4 rad/s. Since the solution of our \mathcal{H}^2 optimization depends in a very complex manner on the parameters that define W_1 and W_2 , it should be no surprise that it took a while to determine suitable parameters.

Construction of Generalized Plant. The generalized plant G was assembled using SIMULINK and the “linmod” command. The resulting two-port state space representation is as follows:

$$G = \begin{bmatrix} 0 & -W_1 P \\ 0 & W_2 \\ 1 & -P \end{bmatrix} = \begin{bmatrix} A & B_1 & B_2 \\ C_1 & D_{11} & D_{12} \\ C_2 & D_{21} & D_{22} \end{bmatrix} = \begin{bmatrix} -0.01 & 0 & -40 & 1 & 1 & 0 \\ 0 & -2 & 0 & 0 & 0 & 1 \\ 0 & 0 & 0 & 1 & 0 & 0 \\ 0 & 0 & 40 & -39 & 0 & 1 \\ \hline 10 & 0 & 0 & 0 & 0 & 0 \\ 0 & 3 & 0 & 0 & 0 & 0.1 \\ \hline 0 & 0 & -40 & 1 & 1 & 0 \end{bmatrix} \quad (30.91)$$

Computation of \mathcal{H}^2 Optimal Controller. The “mksys” command was used to pack the above two-port state space into a tree vector data structure. The “h2lqg” command was then used to obtain the optimal controller. Note that the generalized plant is 4th order (two for plant P , one for sensitivity weighting W_1 , one for control weighting W_2). The optimal controller:

$$K_{\text{opt}} = \frac{191.0813(s + 40)(s + 2)(s + 0.526)}{(s + 1.915)(s + 0.01)(s^2 + 84.15s + 2133)} \quad (30.92)$$

is also 4th order—the order of the generalized plant G . The pole at $s = -0.01$ is an approximate integrator—a consequence of the heavy weighting that W_1 places on the sensitivity at low frequencies.

Closed Loop Analysis. The resulting closed loop poles (two plant $P = G_{22}$, four from controller K_{opt}) are as follows:

$$s = -1, -2.0786 \pm j0.8302, -40, -40, -39.9216 \quad (30.93)$$

The resulting sensitivity, KS , and complementary sensitivity frequency responses are shown in Figs.30.4–30.6, respectively. The figures show that all of the design specifications are met (or nearly met). The peak sensitivity is about 4.855 dB. The peak complementary sensitivity is about 8.71 dB. The KS response shows the impact of the compensators’ lead between 0.1 and 10 rad/s.

Computation of Minimum \mathcal{H}^2 Norm. The minimum two-norm was computed using the following MATLAB command sequence:

```
lc = lyap(acl, bcl*bcl)
minnorm = sqrt( trace( ccl*c*c' ) )
```

The minimum two-norm was found to be 9.0648. ■

The following simple example illustrates how the \mathcal{H}^2 output feedback problem solution can be used to solve classical LQG problems.

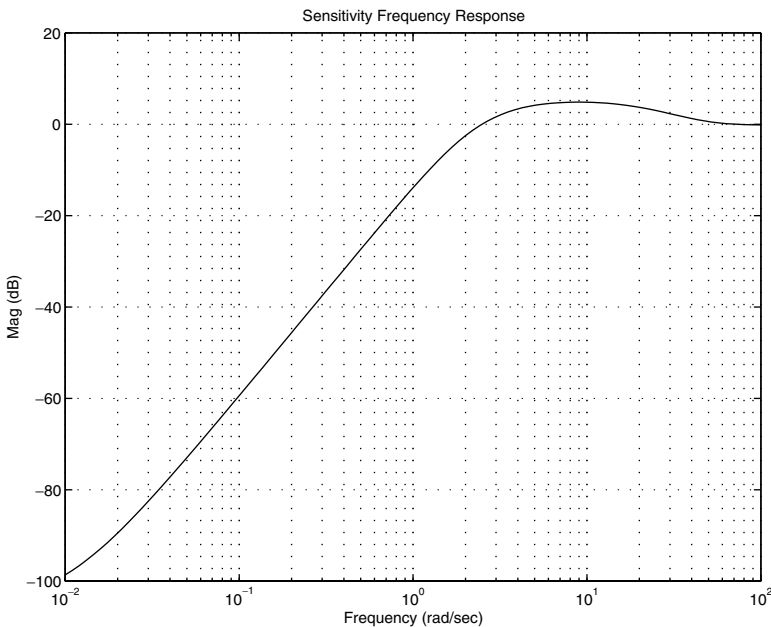

FIGURE 30.4 \mathcal{H}^2 Design sensitivity frequency response.

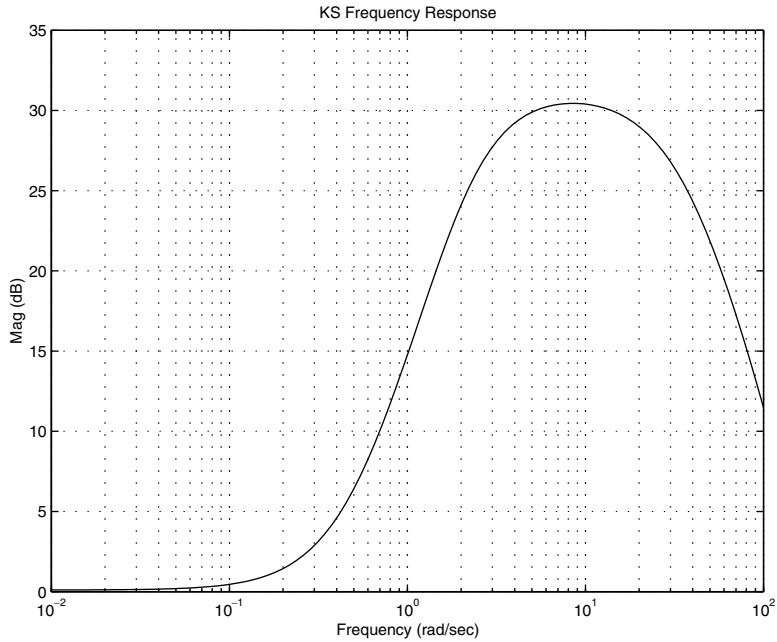

FIGURE 30.5 \mathcal{H}^2 Design KS frequency response.

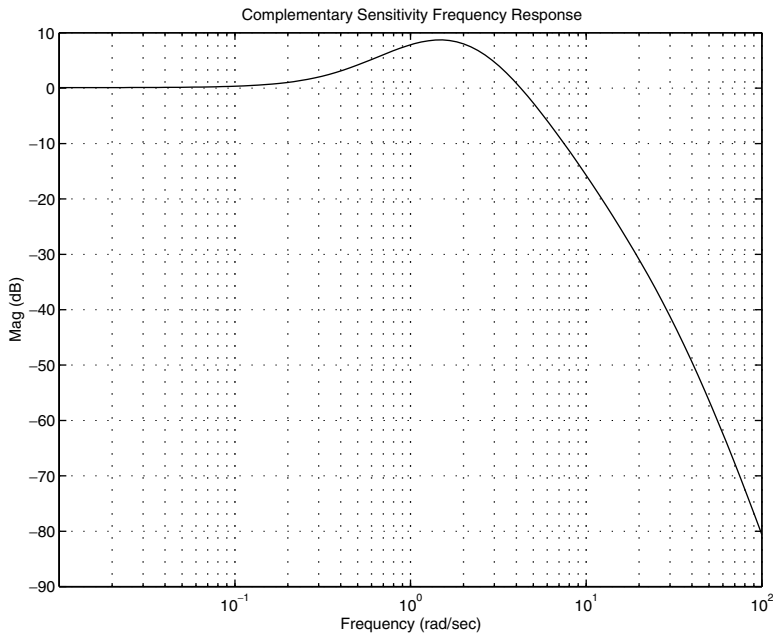

FIGURE 30.6 \mathcal{H}^2 Design complementary sensitivity frequency response.

Example 30.3 (LQG/LTR Design for First Order Unstable Missile Model)

We consider an unstable missile described by a simple first order model with state x (pitch attitude), control input u (fin elevator deflection), process noise $w_1 = \xi$ (angular wind gust), and sensor noise $w_2 = \theta$.

It is assumed that the missile's center of gravity (c.g.) is aft of its center of pressure (c.p.)—where lift is concentrated. This assumption results in a missile pitch instability. It is also assumed that the missile's

moment of inertia about its c.g. is very small. This assumption leads to a simple first order model. The missile's angular velocity \dot{x} is assumed to be proportional to its attitude x and the process noise $w_1 = \xi$. Regulated signals $z = [z_1 \ z_2]^T$ include the vehicle's pitch attitude $z_1 = x$ and a weighted control input $z_2 = \sqrt{\rho}u$. Here, $\rho > 0$ is a design parameter to be selected below. The vehicle's pitch attitude is measured. The pitch attitude measurement y includes additive sensor noise $w_2 = \theta$.

Missile Model. The (generalized) missile model is given as follows:

$$\dot{x} = x + \xi + u \quad (30.94)$$

$$z = \begin{bmatrix} x \\ \sqrt{\rho}u \end{bmatrix} \quad (30.95)$$

$$y = x + \sqrt{\mu}\theta \quad (30.96)$$

where $\mu > 0$ is design parameter to be selected below.

Design Specifications. The goal is to design a real-rational proper model-based \mathcal{H}^2 optimal compensator (i.e., minimizes $\|T_{wz}\|_{\mathcal{H}^2}$) which results in a stable closed loop system with a dominant closed loop pole at $s = -5$ (settling time $t_s \approx 1$ s).

Construction of Generalized Plant. The above model may be rewritten as follows:

$$\dot{x} = x + \begin{bmatrix} 1 & 0 \end{bmatrix} \begin{bmatrix} \xi \\ \theta \end{bmatrix} + u \quad (30.97)$$

$$z = \begin{bmatrix} 1 \\ 0 \end{bmatrix} x + 0_{2 \times 2} \begin{bmatrix} \xi \\ \theta \end{bmatrix} + \begin{bmatrix} 0 \\ \sqrt{\rho} \end{bmatrix} u \quad (30.98)$$

$$y = x + \begin{bmatrix} 0 & \sqrt{\mu} \end{bmatrix} \begin{bmatrix} \xi \\ \theta \end{bmatrix} + 0_{1 \times 1} u \quad (30.99)$$

From this, it follows that

$$A = 1, \quad B_1 = \begin{bmatrix} 1 & 0 \end{bmatrix}, \quad B_2 = 1 \quad (30.100)$$

$$C_1 = \begin{bmatrix} 1 \\ 0 \end{bmatrix}, \quad D_{11} = 0_{2 \times 2}, \quad D_{12} = \begin{bmatrix} 0 \\ \sqrt{\rho} \end{bmatrix} \quad (30.101)$$

$$C_2 = 1, \quad D_{21} = \begin{bmatrix} 0 & \sqrt{\mu} \end{bmatrix}, \quad D_{22} = 0_{1 \times 1} \quad (30.102)$$

\mathcal{H}^2 Problem Assumptions. We now check each of the \mathcal{H}^2 output feedback problem assumptions, as stated in Assumption 30.2. From the above data, it follows that $D_{11} = 0_{2 \times 2}$, $D_{22} = 0_{1 \times 1}$, and (A, B_2, C_2) is stabilizable and detectable, and

$$R = D_{12}^T D_{12} = \rho > 0 \quad (30.103)$$

$$\Theta = D_{21}^T D_{21} = \mu > 0 \quad (30.104)$$

Since

$$D_{12}^T C_1 = 0 \quad (30.105)$$

$$B_1 D_{21}^T = 0 \quad (30.106)$$

the imaginary axis rank conditions involving (A, B_2, C_1, D_{12}) and (A, B_1, C_2, D_{21}) in Assumption 30.2 become equivalent to (A, C_1) having no imaginary unobservable modes and (A, B_1) having no imaginary uncontrollable modes. These are clearly satisfied since $A = 1$ has no imaginary modes. Given this, it follows that all of the \mathcal{H}^2 output feedback problem assumptions in Assumption 30.2 are satisfied.

Plant. Finally, we note that the so-called plant (or missile) transfer function $P = G_{22}$ is given by

$$P = G_{22} = C_2(sI - A)^{-1}B_2 \quad (30.107)$$

$$= \frac{1}{s-1} \quad (30.108)$$

G_{22} is unstable with a right half plane pole at $s = 1$. G_{22} is also minimum phase (i.e., no zeros in $\text{Res} > 0$).

Filter Gain Matrix H_f . Since $B_1 D_{21}^T = 0$, the associated FARE is given by

$$AY + YA^T + B_1 B_1^T - Y C_2^T \Theta^{-1} C_2 Y = Y + Y + 1 - \frac{1}{\mu} Y^2 = 0 \quad (30.109)$$

or

$$Y^2 - 2\mu Y - \mu = 0 \quad (30.110)$$

Application of the quadratic formula and selecting the positive (stabilizing) root yields:

$$Y = \mu + \sqrt{\mu^2 + \mu} \quad (30.111)$$

This yields the following filter gain matrix:

$$H_f = Y C_2^T \Theta^{-1} = 1 + \sqrt{1 + \frac{1}{\mu}} \quad (30.112)$$

We now select μ to achieve the given dominant pole specification:

$$A - H_f C_2 = 1 - 1 - \sqrt{1 + \frac{1}{\mu}} = -5 \quad (30.113)$$

This yields

$$\mu = \frac{1}{24} \quad (30.114)$$

The associated KBF open loop transfer function is given by

$$G_{\text{KF}} = -C_2(sI - A)^{-1}H_f \quad (30.115)$$

$$= \frac{-6}{s-1} \quad (30.116)$$

We will see below that this will be the approximate open loop transfer function PK_{opt} for the final design. In this sense, G_{KF} represents our target open loop transfer function.

Control Gain Matrix G_c . Since $D_{12}^T C_1 = 0$, the associated CARE is given by

$$A^T X + XA + C_1^T C_1 - X B_2 R^{-1} B_2 X = X + X + 1 - \frac{1}{\rho} X^2 = 0 \quad (30.117)$$

or

$$X^2 - 2\rho X - \rho = 0 \quad (30.118)$$

Application of the quadratic formula and selecting the positive (stabilizing) root yields:

$$X = \rho + \sqrt{\rho^2 + \rho} \quad (30.119)$$

This yields the following control gain matrix:

$$G_c = R^{-1} B_2^T X = 1 + \sqrt{1 + \frac{1}{\rho}} \quad (30.120)$$

This results in a closed loop (regulator) pole at

$$A - B_2 G_c = 1 - 1 - \sqrt{1 + \frac{1}{\rho}} = -\sqrt{1 + \frac{1}{\rho}} \quad (30.121)$$

Note that for large ρ (referred to as expensive control in LQR problems) we have a closed loop pole at $s = -1$, at the left half plane reflection of the plant pole at $s = 1$. We will select the design parameter ρ to be small (referred to as cheap control in LQR problems) so that this closed loop (regulator) pole $s \approx -1/\sqrt{\rho}$ is fast and the closed loop filter pole at $s = -5$ at is the dominant closed loop pole.

\mathcal{H}^2 Optimal Output Feedback Model-Based Compensator. The resulting \mathcal{H}^2 optimal output feedback model-based compensator is given by

$$K_{\text{opt}} = \left[\begin{array}{c|c} A - B_2 G_c - H_f C_2 & H_f \\ \hline -G_c & \mathbf{0}_{n_u \times n_y} \end{array} \right] \quad (30.122)$$

where

$$A - B_2 G_c - H_f C_2 = 1 - 1 - \sqrt{1 + \frac{1}{\rho}} - 1 - \sqrt{1 + \frac{1}{\mu}} \quad (30.123)$$

$$= 1 - 1 - \sqrt{1 + \frac{1}{\rho}} - 1 - \sqrt{1 + 24} \quad (30.124)$$

$$= -6 - \sqrt{1 + \frac{1}{\rho}} \quad (30.125)$$

$$H_f = 1 + \sqrt{1 + \frac{1}{\mu}} \quad (30.126)$$

$$= 1 + \sqrt{1 + 24} \quad (30.127)$$

$$= 6 \quad (30.128)$$

$$G_c = 1 + \sqrt{1 + \frac{1}{\rho}} \quad (30.129)$$

Given this, the compensator transfer function is given by

$$K_{\text{opt}} = -G_c(sI - A + B_2G_c + H_fC_2)^{-1}H_f \quad (30.130)$$

$$= \frac{-6(1 + \sqrt{1 + 1/\rho})}{s + 6 + \sqrt{1 + 1/\rho}} \quad (30.131)$$

For small ρ (cheap control), this yields

$$K_{\text{opt}} \approx \frac{-6(1/\sqrt{\rho})}{s + 1/\sqrt{\rho}} \quad (30.132)$$

Open Loop Transfer Function. The associated open loop transfer function is given by

$$PK_{\text{opt}} = -C_2(sI - A)^{-1}B_2 \quad G_c(sI - A + B_2G_c + H_fC_2)^{-1}H_f \quad (30.133)$$

$$= \frac{1}{s - 1} \left[\frac{-6(1 + \sqrt{1 + 1/\rho})}{s + 6 + \sqrt{1 + 1/\rho}} \right] \quad (30.134)$$

For small ρ (cheap control), this becomes

$$PK_{\text{opt}} \approx \frac{1}{s - 1} \left[\frac{-6(1/\sqrt{\rho})}{s + 1/\sqrt{\rho}} \right] \quad (30.135)$$

Loop Transfer Recovery (LTR). From this, we see that as control weighting parameter ρ approaches zero (cheap control), the open loop transfer function approaches the KBF open loop transfer function G_{KF} ; i.e.,

$$\lim_{\rho \rightarrow 0^+} G_{22}K_{\text{opt}} = \frac{-6}{s - 1} \quad (30.136)$$

$$= G_{\text{KF}} \quad (30.137)$$

This shows that as ρ approaches zero (cheap control), the actual open loop transfer function PK_{opt} approaches the target open loop transfer function G_{KF} . The above procedure of recovering a target open loop transfer function (with desirable closed loop properties) using an LQG controller is called *LQG with loop transfer recovery or LQG/LTR*.

Selection of Far Away Closed Loop Regulator Pole. For small ρ , the closed loop system is stable with closed loop poles at $s = -5$ and $s \approx -1/\sqrt{\rho}$. A good selection for ρ might be $\rho = 1/2500$. This results in a fast closed loop pole at $s \approx -50$ and makes the closed loop filter pole at $s = -5$ the dominant closed loop pole, as required.

Stability Robustness Margins. It is well known that \mathcal{H}^2 and LQG designs need not possess good stability robustness margins. In fact, they can be arbitrarily bad [3]. LQG/LTR designs for minimum phase plants (such as ours: $P = 1/(s - 1)$) have guaranteed stability robustness margins. LQG/LTR designs provide margins that approach those associated with LQR and KBF designs; i.e., infinite upward gain margin, at least 6 dB downward gain margin, and at least $\pm 60^\circ$ phase margin. Our final LQG/LTR design

$$PK_{\text{opt}} = \frac{-6}{s - 1} \left[\frac{50}{s + 50} \right] \quad (30.138)$$

offers an infinite upward gain margin and a downward gain margin of 1/6 (−15.56 dB). The resulting unity gain crossover frequency is $\omega_g = \sqrt{35} = 5.92$ rad/s and the associated phase margin is about 99.59°. Not bad.

The following example extends the LQG/LTR ideas presented in [Example 30.3](#) to the general MIMO setting—enabling the design of feedback loops (with nominal robustness margins) via \mathcal{H}^2 optimization. ■

Example 30.4 (MIMO LQG and LQG/LTR Control Design Via \mathcal{H}^2 Optimization)

We consider a MIMO plant P defined by the state space representation

$$\dot{x} = Ax + Bu \quad (30.139)$$

$$y = Cx \quad (30.140)$$

It is assumed that the plant $P = [A, B, C]$ is stabilizable and detectable.

The goal is to demonstrate how the \mathcal{H}^2 optimal output feedback solution that has been presented may be used to solve MIMO LQG control problems. We specifically would like to present a method which lends itself to the concept of LTR—whereby we use a model-based LQG controller to recover a target loop transfer function matrix with desirable closed loop properties. Our motivation is not optimal stochastic LQG control problems; it is the design of control laws with desirable closed loop properties.

Construction of Generalized Plant G. With our final objective being a model-based compensator defined by a control gain matrix G_c and a filter gain matrix H_f , we consider the following generalized plant:

$$\dot{x} = Ax + L\xi + Bu \quad (30.141)$$

$$z = \begin{bmatrix} Mx \\ \sqrt{\rho}I_{n_u \times n_u} \end{bmatrix} \quad (30.142)$$

$$y = Cx + \sqrt{\mu}\theta \quad (30.143)$$

where u is the control, x is the (generalized) plant state, $w_1 = \xi$ represents process noise in the state equation, $w_2 = \theta$ represents sensor noise in the measurement equation, $A \in \mathcal{R}^{n \times n}$, $L \in \mathcal{R}^{n \times n_u}$, $B \in \mathcal{R}^{n \times n_u}$, $M \in \mathcal{R}^{n_y \times n}$, $C \in \mathcal{R}^{n_y \times n}$, $n_y = n_u$, $\rho > 0$, $\mu > 0$.

Design Parameter Assumptions. It is assumed that either:

- (A, L) has no imaginary uncontrollable modes and (A, M) is detectable, or
- (A, L) is stabilizable and (A, M) has no imaginary unobservable modes.

Here, L , M , μ , and ρ should be viewed as “design parameters” that are selected in order to obtain control and filter gain matrices G_c and H_f such that the resulting model-based compensator exhibits desirable closed loop properties.

Two-Port State Space Representation for Generalized Plant G. The above model may be rewritten in two-port state space form as follows

$$\begin{bmatrix} \dot{x} \\ z \\ y \end{bmatrix} = \begin{array}{c|cc} \begin{array}{c|c} A & \begin{bmatrix} L & 0_{n \times n_y} \end{bmatrix} \\ \hline \begin{bmatrix} M \\ 0_{n_u \times n} \end{bmatrix} & \begin{array}{cc} 0_{n_y \times n_u} & 0_{n_y \times n_y} \\ 0_{n_u \times n_u} & 0_{n_u \times n_y} \end{array} \end{array} & \begin{array}{c} B \\ \hline \begin{bmatrix} 0_{n_y \times n_u} \\ \sqrt{\rho}I_{n_u \times n_u} \end{bmatrix} \end{array} & \begin{array}{c} x \\ \xi \\ \theta \\ u \end{array} \end{array} \quad (30.144)$$

Check on \mathcal{H}^2 Output Feedback Assumptions. We now make sure that all of the \mathcal{H}^2 output feedback problem assumptions in Assumption 30.2 are satisfied.

- *Plant $P = G_{22}$ Assumptions.* Since the plant $P = G_{22} = [A, B, C]$ is stabilizable and detectable, it follows that $(A, B_2 = B, C_2 = C)$ is stabilizable and detectable.
- *Regulator Assumptions.* Since

$$D_{12} = \begin{bmatrix} 0_{n_y \times n_u} \\ \sqrt{\rho} I_{n_u \times n_u} \end{bmatrix}$$

has full column rank, it follows that the control weighting matrix $R = D_{12}^T D_{12} = \rho I_{n_u \times n_u} > 0$ is nonsingular.

Since $D_{12}^T C_1 = 0$, it follows that the imaginary axis (column) rank condition involving (A, B_2, C_1, D_{12}) in Assumption 30.2 is equivalent to $(A - B_2 R^{-1} D_{12}^T C_1, (I - D_{12} R^{-1} D_{12}^T) C_1) = (A, C_1)$ having no unobservable imaginary modes. Since (A, M) is either detectable or has no imaginary unobservable modes, it follows that

$$A, C_1 = \begin{bmatrix} M \\ 0_{n_u \times n} \end{bmatrix}$$

has no unobservable imaginary modes. The associated Hamiltonian H_{con} will, therefore, yield a Riccati solution and control gain matrix G_c such that $A - BG_c$ is stable.

- *Filter Assumptions.* Since $D_{21} = [0_{n_y \times n_u} \quad \sqrt{\mu} I_{n_y \times n_y}]$ has full row rank, it follows that the measurement weighting matrix $\Theta = D_{21} D_{21}^T = \mu I_{n_y \times n_y} > 0$ is nonsingular.

Since $B_1 D_{21}^T = 0$, it follows that the imaginary axis (row) rank condition involving (A, B_1, C_2, D_{21}) in Assumption 30.2 is equivalent to $(A - B_1 D_{21}^T \Theta^{-1} C_2, B_1 (I - D_{21} \Theta^{-1} D_{21}^T)) = (A, B_1)$ having no uncontrollable imaginary modes. Since (A, L) is either stabilizable or has no uncontrollable imaginary modes, it follows that $(A, B_1 = [L \quad 0_{n \times n_y}])$ has no uncontrollable imaginary modes. The associated Hamiltonian H_{fil} will therefore yield a Riccati solution and filter gain matrix H_f such that $A - H_f C$ is stable.

Given the above, it follows that all of the \mathcal{H}^2 output feedback problem assumptions in Assumption 30.2 are satisfied.

Control Gain Matrix. It follows that the control gain matrix G_c is given by

$$G_c = R^{-1} B^T X \quad (30.145)$$

where $X \geq 0$ is the unique (at least) positive semi-definite solution of the CARE:

$$A^T X + XA + C^T C - XBR^{-1}BX = 0 \quad (30.146)$$

Moreover, $A - BG$ is stable.

Filter Gain Matrix. It follows that the filter gain matrix H_f is given by

$$H_f = YC^T \Theta^{-1} \quad (30.147)$$

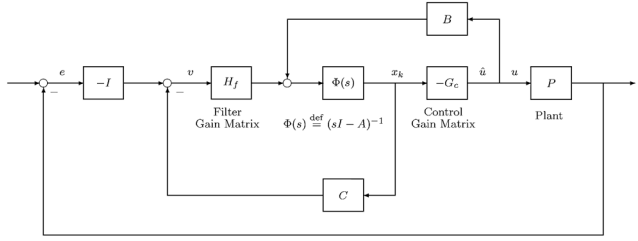

FIGURE 30.7 Negative feedback loop with LQG model-based compensator and plant.

where $Y > 0$ is the unique (at least) positive semi-definite solution of the FARE:

$$AY + YA^T + LL^T - YC^T\Theta^{-1}CY = 0 \quad (30.148)$$

Moreover, $A - HC$ is stable.

\mathcal{H}^2 Optimal (LQG) Compensator. The \mathcal{H}^2 optimal compensator that minimizes the \mathcal{H}^2 norm of the transfer function matrix from the exogenous signals $w = \begin{bmatrix} \xi \\ \theta \end{bmatrix}$ to the regulated signals $z = \begin{bmatrix} C_x \\ \sqrt{\rho}I_{n_u \times n_u} \end{bmatrix}$ is then given by

$$K_{\text{opt}} = \left[\begin{array}{c|c} A - BG_c - H_f C & H_f \\ \hline G_c & 0_{n_u \times n} \end{array} \right] \quad (30.149)$$

Note that the minus sign on G_c (lower left hand entry of K_{opt}) has been removed in anticipation of the negative feedback system implementation shown in Fig. 30.7. By the separation principle, the closed loop poles are the eigenvalues of $A - BG_c$ and $A - H_f C$.

Stability Robustness Margins. It should be emphasized that the resulting controller K_{opt} , although stabilizing, may possess arbitrarily bad stability robustness margins [3]. This is despite the fact that the associated regulator loop

$$G_{LQ} = G_c(sI - A)^{-1}B \quad (30.150)$$

and filter loop

$$G_{KF} = C(sI - A)^{-1}H_f \quad (30.151)$$

when viewed as MIMO open loop transfer function matrices within their own negative feedback loops, possess the following well-known stability robustness margins: infinite upward gain margin, at least 6 dB downward gain margin, and at least $\pm 60^\circ$ phase margin. This gives rise to the following natural question:

Is there a way that we can select the control gain matrix G_c and the filter gain matrix H_f so that the resulting model-based compensator K_{opt} results in a feedback loop which possesses the above nice margins?

Fortunately, the answer to this is a definitive yes! Two methods which result in comparable stability margins at the plant input or at the plant output (but not both simultaneously) are now presented.

Loop Transfer Recovery (LTR) Methods. The approach we take to achieve a feedback design with good stability margins is as follows. The process involves two steps.

1. *Target Loop Design.* The first step is to design a target open loop transfer function matrix that possesses desired closed loop properties. The target loop may be associated with the plant output. If so, we denote it L_o . In such a case, L_o represents our desired PK_{opt} . If associated with the plant input, we denote it L_i . In such a case, L_i represents our desired $K_{\text{opt}}P$. (In general, $PK_{\text{opt}}P \neq K_{\text{opt}}P$.)

2. *Target Loop Recovery Via Model-Based Compensator.* The second step is to use a model-based compensator $K_{\text{opt}} = [A - BG_c - H_f C, H, G]$ to recover the target loop (either L_o or L_i).

If we want to recover L_o (i.e., good properties at that plant output), then we want $PK_{\text{opt}} \approx L_o$. This is called loop transfer recovery at the plant output (LTRO).

If we want to recover L_i (i.e., good properties at that plant input), then we want $K_{\text{opt}}P \approx L_i$. This is called loop transfer recovery at the plant input (LTRI).

Note: In general, the properties associated with breaking the loop at the plant output (properties of PK_{opt}) are different (perhaps very different) from those associated with breaking the loop at the plant input (properties of $K_{\text{opt}}P$). It is usually very difficult for PK_{opt} and $K_{\text{opt}}P$ to both possess great properties (e.g., margins, etc.). Typically, a designer must trade off nice properties at the plant output for nice properties at the plant input, or vice versa.

\mathcal{H}^2 -based methods for LTRO and LTRI are now presented.

- Loop Transfer Recovery at Plant Output (LTRO).
 1. *Design of Target Loop L_o .* The first step is to design a target loop $L_o = C(sI - A)^{-1}H_f$ with desirable closed loop properties (e.g., stability, sensitivity, complementary sensitivity, stability robustness margins, etc). This may be done using any method! (Any method you feel comfortable enough with.)

One procedure that results in good properties at the plant output is based on *KBF* methods. The idea is to select the design (shaping) matrix L so that the singular values $G_{\text{FOL}} = C(sI - A)^{-1}L$ look nice; e.g., large minimum singular value at low frequencies, small maximum singular value at high frequencies, singular values cross 0 dB with slopes of -20 dB/dec, etc.

We then solve the FARE with $A, L, C, \Theta = \mu I_{n_y \times n_y}$ —using $\mu > 0$ to adjust the bandwidth of our target loop $L_o = G_{\text{KF}} = C(sI - A)^{-1}H_f$. A smaller (larger) μ results in a larger (smaller) bandwidth.

Guidelines for Shaping of Target Loop $L_o = G_{\text{KF}}$.

- The so-called Kalman Frequency Domain Equality (KFDE) guides our loop shaping:

$$[I + G_{\text{KF}}(j\omega)][I + G_{\text{KF}}(j\omega)]^H = I + \left[\frac{1}{\sqrt{\mu}} G_{\text{FOL}}(j\omega) \right] \left[\frac{1}{\sqrt{\mu}} G_{\text{FOL}}(j\omega) \right]^H \quad (30.152)$$

From this, it follows that

$$\sigma_i[I + G_{\text{KF}}(j\omega)] = \sqrt{1 + \frac{1}{\mu} \sigma_i^2[G_{\text{FOL}}(j\omega)]} \quad (30.153)$$

This suggests that by shaping G_{FOL} , we can shape the target loop $L_o = G_{\text{KF}}$. Specifically, if G_{FOL} is large at low frequencies, then we expect

$$G_{\text{KF}}(j\omega) \approx \frac{1}{\sqrt{\mu}} G_{\text{FOL}}(j\omega) \quad (30.154)$$

at low frequencies. This shows that the matrix L should be used for shaping the target loop $L_o = G_{\text{KF}}$ while $\mu > 0$ is used to adjust the target loop bandwidth—decreasing/increasing μ to raise/lower the target loop bandwidth. The resulting loop $L_o = G_{\text{KF}}$ is guaranteed to possess nice closed loop properties as described below.

- The above singular value relation implies that

$$\sigma_{\min}[I + G_{\text{KF}}(j\omega)] \geq 1 \quad (30.155)$$

for all ω . This, in turn, implies that the associated sensitivity singular values satisfy

$$\sigma_{\max}[S_{\text{KF}}(j\omega)] = \frac{1}{\sigma_{\min}[S_{\text{KF}}(j\omega)]^{-1}} \leq 1 \quad (0\text{dB}) \quad (30.156)$$

for all ω , where

$$S_{\text{KF}}(j\omega) = [I + G_{\text{KF}}(j\omega)]^{-1} \quad (30.157)$$

- From the above sensitivity singular value relationship, we obtain the follow celebrated KBF loop margins:

- infinite upward gain margin,
- at least $\frac{1}{2}$ (6 dB) downward gain margin,
- at least $\pm 60^\circ$ phase margin.

The above gain margins apply to simultaneous and independent gain perturbations when the loop is broken at the output. The same holds for the above phase margins. The above margins are NOT guaranteed for simultaneous gain and phase perturbations. It should be noted that these margins can be easily motivated using elementary SISO Nyquist stability arguments [2,8].

- From the above sensitivity singular value relations, we obtain the following complementary sensitivity singular value relationship:

$$\sigma_{\max}[T_{\text{KF}}(j\omega)] = \sigma_{\max}[I - S_{\text{KF}}(j\omega)] \leq 1 + \sigma_{\max}[S_{\text{KF}}(j\omega)] \leq 2 \quad (6\text{dB}) \quad (30.158)$$

for all ω , where

$$T_{\text{KF}} = I - S_{\text{KF}} = G_{\text{KF}}[1 + G_{\text{KF}}]^{-1} \quad (30.159)$$

2. *Recovery of Target Loop L_o Using Model-Based Compensator.* The second step is to use a model-based compensator $K_{\text{opt}} = [A - BG_c - H_f C, H_f, G_c]$ where G_c is found by solving the CARE with $A, B, M = C, R = \rho I_{n_u \times n_u}$ with ρ a small positive scalar. Since ρ is small, we call this a cheap control problem.

- If the plant $P = [A, B, C]$ is minimum phase, then it can be shown that

$$\lim_{\rho \rightarrow 0^+} X = 0 \quad (30.160)$$

$$\lim_{\rho \rightarrow 0^+} \sqrt{\rho} G_c = WC \quad (30.161)$$

for some orthonormal W (i.e., $W^T W = W W^T = I$)

$$\lim_{\rho \rightarrow 0^+} PK_{\text{opt}} = L_o \quad (30.162)$$

In such a case, $PK_{\text{opt}} \approx L_o$ for small ρ and hence PK_{opt} will possess stability margins that are close to those of L_o (at the plant output)—whatever method was used to design L_o . It must be noted that the minimum phase condition on the plant P is a sufficient condition. It is not necessary. Moreover, G_c need not be computed using a CARE. In fact, any G_c which (1) satisfies a limiting condition $\lim_{\rho \rightarrow 0^+} \sqrt{\rho} G_c = WC$ for some invertible matrix W and which (2) ensures that $A - BG_c$ is stable (for small ρ), will result in LTR at the plant output. This result

is a consequence of the structure of model-based compensators and has nothing to do with optimal control and filtering problems.

- Assuming that a limiting condition $\lim_{\rho \rightarrow 0^+} \sqrt{\rho} G_c = WC$ holds for some invertible matrix W , loop transfer recovery of the target loop $L_o = C(sI - A)^{-1}H_f$ may be proven as follows: For small ρ we have

$$G_c \approx \frac{WC}{\sqrt{\rho}} \quad (30.163)$$

which gives yields the following:

$$PK_{\text{opt}} = PG_c(sI - A + BG_c + H_f C)^{-1}H_f \quad (30.164)$$

$$\approx P \frac{WC}{\sqrt{\rho}} \left(sI - A + B \frac{WC}{\sqrt{\rho}} \right)^{-1} H_f \quad (30.165)$$

$$\approx P \frac{WC}{\sqrt{\rho}} (sI - A)^{-1} \left[I + B \frac{WC}{\sqrt{\rho}} (sI - A)^{-1} \right]^{-1} H_f \quad (30.166)$$

$$\approx P \frac{WC(sI - A)^{-1}}{\sqrt{\rho}} \left[I + B \frac{WC(sI - A)^{-1}}{\sqrt{\rho}} \right]^{-1} H_f \quad (30.167)$$

$$\approx P \left[I + \frac{WC(sI - A)^{-1}}{\sqrt{\rho}} B \right]^{-1} \frac{WC(sI - A)^{-1}}{\sqrt{\rho}} H_f \quad (30.168)$$

$$\approx P \left[\frac{WP}{\sqrt{\rho}} \right]^{-1} W \frac{C(sI - A)^{-1}H_f}{\sqrt{\rho}} \quad (30.169)$$

$$\approx C(sI - A)^{-1}H_f = L_o \quad (30.170)$$

The central idea (underneath the algebra) is that as ρ goes to zero, the C feedback path within the compensator $K_{\text{opt}} = [A - BG_c - H_f C, G_c, H_f]$ is broken (see Fig.30.7) and the nice properties that hold at the so-called innovations v (e.g., open loop transfer function matrix at v is $L_o = C(sI - A)^{-1}H_f$) in Fig. 30.7 get transferred to the error signal e (compensator input, or plant output) within the feedback loop.

- Loop Transfer Recovery at Plant Input (LTRI).
 1. *Design of Target Loop L_i .* The first step is to design a target loop $L_i = G_c(sI - A)^{-1}B$ with desirable closed loop properties (e.g., stability, sensitivity, complementary sensitivity, stability robustness margins, etc). This may be done using any method! (Any method you feel comfortable enough with.)

One procedure that results in good properties at the plant input is based on LQR methods. The idea is to select the design (shaping) matrix M so that the singular values of $G_{\text{OL}} = M(sI - A)^{-1}B$ look nice; e.g., large minimum singular value at low frequencies, small maximum singular value at high frequencies, singular values cross 0 dB with slopes of -20 dB/dec, etc.

We then solve the CARE with $A, B, M, R = \rho I_{n_u \times n_u}$, using $\rho > 0$ to adjust the bandwidth of our target loop $L_i = G_{\text{LQR}}G_c(sI - A)^{-1}B$. A smaller (larger) ρ results in a larger (smaller) bandwidth.

Guidelines for Shaping of Target Loop $L_i = G_{\text{LQ}}$.

- The so-called LQ frequency domain equality (LQFDE) guides our loop shaping:

$$[I + G_{\text{LQ}}(j\omega)]^H [I + G_{\text{LQ}}(j\omega)] = I + \left[\frac{1}{\sqrt{\rho}} G_{\text{OL}}(j\omega) \right]^H \left[\frac{1}{\sqrt{\rho}} G_{\text{OL}}(j\omega) \right] \quad (30.171)$$

From this, it follows that

$$\sigma_i [I + G_{LQ}(j\omega)] = \sqrt{I + \frac{1}{\rho} \sigma_i^2 [G_{OL}(j\omega)]} \quad (30.172)$$

This suggests that by shaping G_{OL} , we can shape the target loop $L_i = G_{LQ}$. Specifically, if G_{OL} is large at low frequencies, then we expect

$$G_{LQ}(j\omega) \approx \frac{1}{\sqrt{\rho}} G_{OL}(j\omega) \quad (30.173)$$

at low frequencies. This shows that the matrix M should be used for shaping the target loop $L_i = G_{LQ}$ while $\rho > 0$ is used to adjust the target loop bandwidth—decreasing/increasing ρ to raise/lower the target loop bandwidth. The resulting loop $L_i = G_{LQ}$ is guaranteed to possess nice closed loop properties as described below.

- The above singular value relation implies that

$$\sigma_{\min}[I + G_{LQ}(j\omega)] \geq 1 \quad (30.174)$$

for all ω . This, in turn, implies that the associated sensitivity singular values satisfy

$$\sigma_{\max}[S_{LQ}(j\omega)] = \frac{1}{\sigma_{\min}[S_{LQ}(j\omega)^{-1}]} \leq 1 \quad (0\text{dB}) \quad (30.175)$$

for all ω , where

$$S_{LQ} = [I + G_{LQ}]^{-1} \quad (30.176)$$

- From the above sensitivity singular value relationship, we obtain the follow celebrated LQR loop margins:

- infinite upward gain margin,
- at least $\frac{1}{2}$ (6 dB) downward gain margin,
- at least $\pm 60^\circ$ phase margin.

The above gain margins apply to simultaneous and independent gain perturbations when the loop is broken at the input. The same holds for the above phase margins. The above margins are NOT guaranteed for simultaneous gain and phase perturbations. It should be noted that these margins can be easily motivated using elementary SISO Nyquist stability arguments [2,8].

- From the above sensitivity singular value relations, we obtain the following complementary sensitivity singular value relationship:

$$\sigma_{\max}[T_{LQ}(j\omega)] = \sigma_{\max}[I - S_{LQ}(j\omega)] \leq 1 + \sigma_{\max}[S_{LQ}(j\omega)] \leq 2 \quad (6\text{dB}) \quad (30.177)$$

for all ω , where

$$T_{LQ} = I - S_{LQ} = G_{LQ}[1 + G_{LQ}]^{-1} \quad (30.178)$$

2. Recovery of Target Loop L_i Using Model-Based Compensator. The second step is to use $K_{\text{opt}} = [A - BG_c, -H_f C, H_p G_c]$ where H_f is found by solving the FARE with $A, L = B, C, \Theta = \mu I_{n_y \times n_y}$ with μ a small positive scalar. Since μ is small, we call this an expensive sensor problem.

- If the plant $P = [A, B, C]$ is minimum phase, then it can be shown that

$$\lim_{\mu \rightarrow 0^+} Y = 0 \quad (30.179)$$

$$\lim_{\mu \rightarrow 0^+} \sqrt{\mu} H_f = BV \quad (30.180)$$

for some orthonormal V (i.e., $V^T V = V V^T = I$)

$$\lim_{\mu \rightarrow 0^+} K_{\text{opt}} P = L_i \quad (30.181)$$

In such a case, $K_{\text{opt}} P \approx L_i$ for small μ and hence $K_{\text{opt}} P$ will possess stability margins that are close to those of L_i (at the plant input)—whatever method was used to design L_i .

It must be noted that the minimum phase condition on the plant P is a sufficient condition. It is not necessary. Moreover, H_f need not be computed using a FARE. In fact, any H_f which (1) satisfies a limiting condition $\lim_{\mu \rightarrow 0^+} \sqrt{\mu} H_f = BV$ for some invertible matrix V and which (2) ensures that $A - H_f C$ is stable (for small μ), will result in LTR at the plant input; i.e., $\lim_{\mu \rightarrow 0^+} K_{\text{opt}} P = L_i$. This result is a consequence of the structure of model-based compensators and has nothing to do with optimal control and filtering problems.

- Assuming that a limiting condition $\lim_{\mu \rightarrow 0^+} \sqrt{\mu} H_f = BV$ holds for some invertible matrix V , loop transfer recovery of the target loop $L_i = G_c(sI - A)^{-1} B$ may be proven as follows. For small μ we have

$$H_f \approx \frac{BV}{\sqrt{\mu}} \quad (30.182)$$

which gives the following:

$$K_{\text{opt}} P = G_c(sI - A + BG_c + H_f C)^{-1} H_f P \quad (30.183)$$

$$\approx G_c \left(sI - A + BG_c + \frac{BV}{\sqrt{\mu}} C \right)^{-1} \frac{BV}{\sqrt{\mu}} P \quad (30.184)$$

$$\approx G_c \left(sI - A + \frac{BV}{\sqrt{\mu}} C \right)^{-1} \frac{BV}{\sqrt{\mu}} P \quad (30.185)$$

$$\approx G_c(sI - A)^{-1} + \left[I + \frac{BV}{\sqrt{\mu}} C(sI - A)^{-1} \right]^{-1} \frac{BV}{\sqrt{\mu}} P \quad (30.186)$$

$$\approx G_c(sI - A)^{-1} \frac{BV}{\sqrt{\mu}} \left[I + C(sI - A)^{-1} \frac{BV}{\sqrt{\mu}} \right]^{-1} P \quad (30.187)$$

$$\approx G_c(sI - A)^{-1} \frac{BV}{\sqrt{\mu}} \left[C(sI - A)^{-1} \frac{BV}{\sqrt{\mu}} \right]^{-1} P \quad (30.188)$$

$$\approx G_c(sI - A)^{-1} B \frac{V}{\sqrt{\mu}} \left[P \frac{V}{\sqrt{\mu}} \right]^{-1} P \quad (30.189)$$

$$\approx G_c(sI - A)^{-1} B = L_i \quad (30.190)$$

The central idea (underneath the algebra) is that as μ goes to zero, the B feedback path within the compensator $K_{\text{opt}} = [A - BG_c - H_f C, G_c, H_f]$ is broken (see Fig. 30.7) and the nice properties

that hold at \hat{u} (e.g., open loop transfer function matrix at \hat{u} is $L_i = G_c(sI - A)^{-1}B$) in Fig. 30.7 get transferred to the plant input u (compensator output) within the feedback loop. ■

Comment 30.13 (Stability Margins and Peak Sensitivity)

The peak on the sensitivity plot is very important in the design of a feedback system. A large peak, for example, may be due to a closed loop pole near the imaginary axis. This certainly is undesirable. We thus want the peak to be “small.” It can be shown that the peak necessarily establishes gain and phase margin bounds.

Suppose that the peak sensitivity is bounded above by $\alpha \geq 1$; i.e., $\sigma_{\max} S(j\omega) < \alpha$ for all ω . It can be shown that the feedback loop then enjoys the following nominal multivariable stability robustness (gain and phase) margin bounds:

$$\uparrow GM > \frac{\alpha}{\alpha - 1} \quad (30.191)$$

$$\downarrow GM < \frac{\alpha}{\alpha + 1} \quad (30.192)$$

$$|PM| > 2 \sin^{-1} \left(\frac{1}{2\alpha} \right) \quad (30.193)$$

These bounds may be easily motivated using SISO Nyquist [2,8] ideas as follows.

If

$$|S(j\omega)| < \alpha \quad (30.194)$$

for all ω , then it follows that

$$\frac{1}{\alpha} < |1 + L(j\omega)| \quad (30.195)$$

for all ω . This, however, implies that the Nyquist plot associated with L cannot penetrate a circle centered at -1 with radius $1/\alpha$, left most end point at $-[(\alpha+1)/\alpha]$, and right most end point at $-[(\alpha-1)/\alpha]$. The upward gain margin bound follows from the right most point of the circle. The downward gain margin bound follows from the left most point of the circle. The phase margin bound can be obtained with a little geometry. ■

The following example considers the application of \mathcal{H}^2 theory to a robotic manipulator.

Example 30.5 (\mathcal{H}^2 -LQG/LTR Design for PUMA 560 Robotic Manipulator)

In this example, we show how \mathcal{H}^2 optimization may be used to design an LQG/LTR controller for a PUMA 560 robotic manipulator. The manipulator is shown in Fig. 30.8.

A two degree-of-freedom (dof) linear model $P = [A_p, B_p, C_p]$ was used to initiate the design process. Linearizing the PUMA's nonlinear model [9] about the equilibrium point $\theta_1 = 90^\circ$, $\theta_2 = 0^\circ$ (both links vertical), results in the following linear model:

$$\dot{x}_p = A_p x_p + B_p \mu_p \quad (30.196)$$

$$y_p = C_p x_p \quad (30.197)$$

$$u_p = [\tau_1 \quad \tau_2]^T \quad (30.198)$$

$$x_p = [\theta_1 \quad \theta_2 \quad \dot{\theta}_1 \quad \dot{\theta}_2]^T \quad (30.199)$$

$$y_p = [\theta_1 \quad \theta_2]^T \quad (30.200)$$

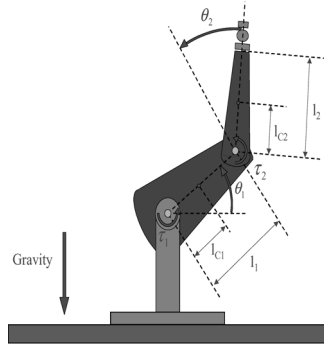

FIGURE 30.8 Two degree-of-freedom PUMA 560 robotic manipulator.

where

$$A_p = \begin{bmatrix} 0.0000 & 0.0000 & 1.0000 & 0.0000 \\ 0.0000 & 0.0000 & 0.0000 & 1.0000 \\ 31.7613 & -33.0086 & 0.0000 & 0.0000 \\ -56.9381 & 187.7089 & 0.0000 & 0.0000 \end{bmatrix} \quad (30.201)$$

$$B_p = \begin{bmatrix} 0.0000 & 0.0000 \\ 0.0000 & 0.0000 \\ 1037.7259 & -3919.6674 \\ -3919.6674 & 2030.8306 \end{bmatrix} \quad (30.202)$$

$$C_p = [I_{2 \times 2} \quad 0_{2 \times 2}] \quad (30.203)$$

The system poles are $s = \pm 14.1050$, $s = \pm 4.5299$. Eigenvector analysis shows that the fast instability at $s = 14.1050$ is primarily associated with the upper (shorter) link, while the slower instability at $s = 4.5299$ is primarily associated with the lower (longer) link. The system does not possess any natural integrators (i.e., no zero eigenvalues) and, as expected, the singular values $\sigma_i[P(j\omega)]$ are flat at low frequencies (see Fig. 30.9).

Closed Loop Objectives

A controller to be implemented within a negative feedback loop is sought. The closed loop system should exhibit the following properties: (1) closed loop stability, (2) zero steady state error to step reference commands, (3) good low frequency reference command following (step commands followed with little overshoot within 3 s), (4) good low frequency disturbance attenuation, (5) good high frequency noise attenuation, (6) good stability robustness margins at the plant output.

Each step of the control system design process is now described. A central idea is the formation of a so-called design plant P_d from the original plant P . The design plant P_d is what is submitted to our \mathcal{H}^2 -LQG/LTR design machinery.

Step 1: Augment Plant P with Integrators to Get Design Plant $P_d = [A, B, C]$

In order to guarantee zero steady-state error to step reference commands, we begin by augmenting the plant $P = [A_p, B_p, C_p]$ with integrators—one in each control channel—to form the design plant $P_d = [A, B, C]$; i.e., $P_d = P(I_{2 \times 2}/s)$. This is done as follows:

$$A = \begin{bmatrix} 0_{2 \times 2} & 0_{2 \times 4} \\ B_p & A_p \end{bmatrix} \quad (30.204)$$

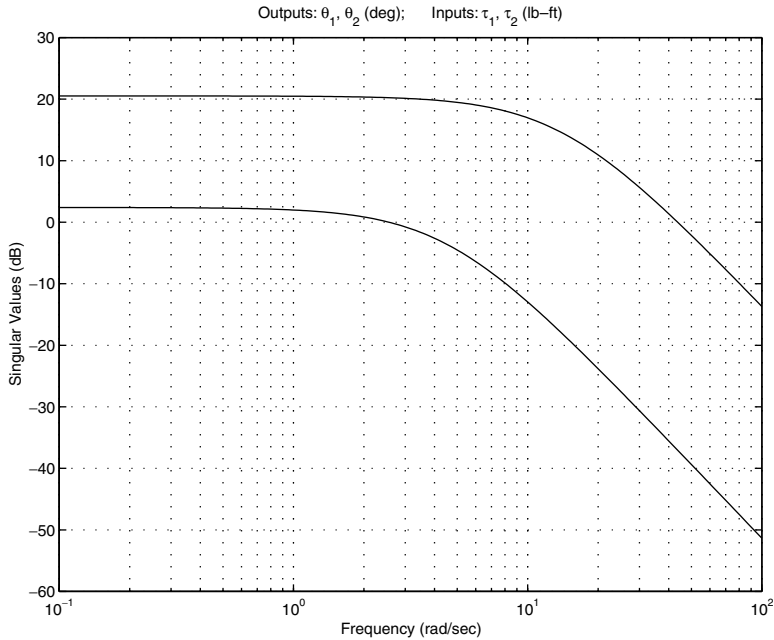

FIGURE 30.9 PUMA 560 robotic manipulator singular values.

$$B = \begin{bmatrix} \mathbf{1}_{2 \times 2} \\ \mathbf{0}_{4 \times 2} \end{bmatrix} \quad (30.205)$$

$$C = [\mathbf{0}_{2 \times 2} \quad C_p] \quad (30.206)$$

The state of this system is $x = \begin{bmatrix} x_i \\ x_p \end{bmatrix}$ where x_i is the integrator state and x_p is the plant state. The singular values for the augmented system P_d exhibit a slope of -20 dB/dec at low frequencies as expected (see Fig. 30.10). The minimum singular value crosses zero dB just above 1 rad/s. The maximum singular value crosses zero dB at about 8 rad/s.

Step 2: Design Target Open Loop Transfer Function Matrix $L_o = G_{KF} = C(sI - A)^{-1}H_f$

Next we design a target open loop transfer function matrix $L_o = G_{KF} = C(sI - A)^{-1}H_f$ that has desirable closed loop properties (e.g., sensitivity singular values, pole locations, stability margins, etc.) at the output. To do this, we use Kalman Filtering ideas. Like LQR loops designed without a cross-state-control-coupling penalty, Kalman Filter loops designed in similar fashion exhibit desirable stability robustness margins (e.g., infinite upward gain margin, at least 6 dB downward gain margin, at least $\pm 60^\circ$ phase margin). This target loop design is carried out as follows:

- Consider the augmented system shown in Fig. 30.11.

It will be used to design a target loop transfer function matrix $L_o = G_{KF}$ with desirable closed loop properties at the output. To do so, we begin by forming an augmented system $G_{FOL} = C(sI - A)^{-1}L$ with

$$L = \begin{bmatrix} L_L \\ L_H \end{bmatrix} \quad (30.207)$$

$$L_L = [C_p(-A_p)^{-1}B_p]^{-1} \quad (30.208)$$

$$L_H = (-A_p)^{-1}B_pL_L \quad (30.209)$$

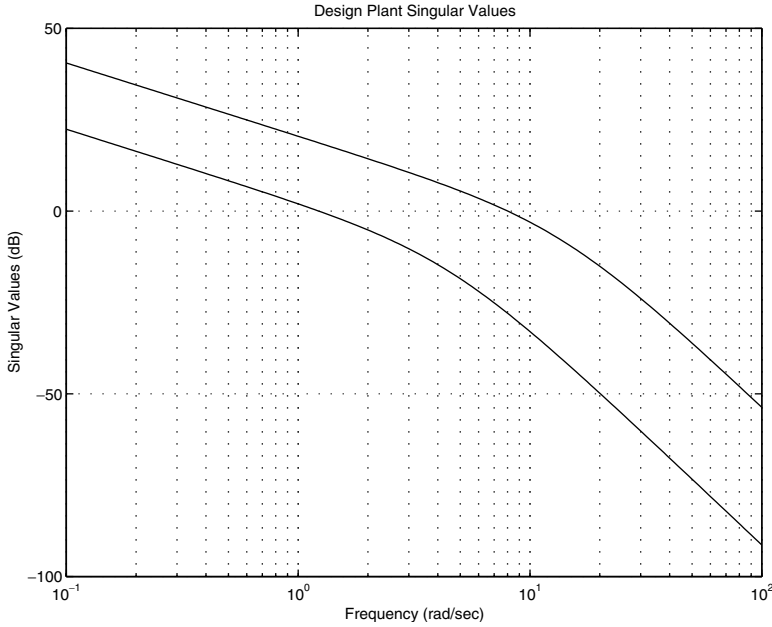

FIGURE 30.10 PUMA 560 robotic manipulator design plant singular values.

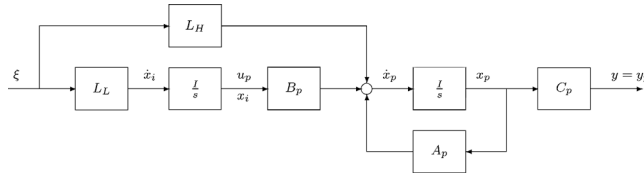

FIGURE 30.11 Augmented system used for designing target loop.

The matrix L_L matches the singular values of $G_{\text{FOL}} = C(sI - A)^{-1}L$ at low frequencies. The matrix L_H matches the singular values at high frequencies. Together, L_L and L_H match the singular values of $G_{\text{FOL}} = C(sI - A)^{-1}L$ at all frequencies (see Fig. 30.12). Why is this?

This selection for L_L and L_H results in

$$G_{\text{FOL}} = C_p(sI - A_p)^{-1}L_H + C_p(sI - A_p)^{-1}B_p\left(\frac{I}{s}\right)L_L \quad (30.210)$$

$$= C_p(sI - A_p)^{-1}\left[L_H + B_p\left(\frac{I}{s}\right)L_L\right] \quad (30.211)$$

$$= C_p(sI - A_p)^{-1}\left[(-A_p)^{-1}B_pL_L + B_p\left(\frac{I}{s}\right)L_L\right] \quad (30.212)$$

$$= C_p(sI - A_p)^{-1}[sI - A_p](-A_p)^{-1}B_pL_L\left(\frac{I}{s}\right) \quad (30.213)$$

$$= C_p(-A_p)^{-1}B_pL_L\left(\frac{I}{s}\right) \quad (30.214)$$

$$= \frac{I}{s} \quad (30.215)$$

The resulting gain crossover frequency in Fig. 30.12 is 1 rad/s, as expected.

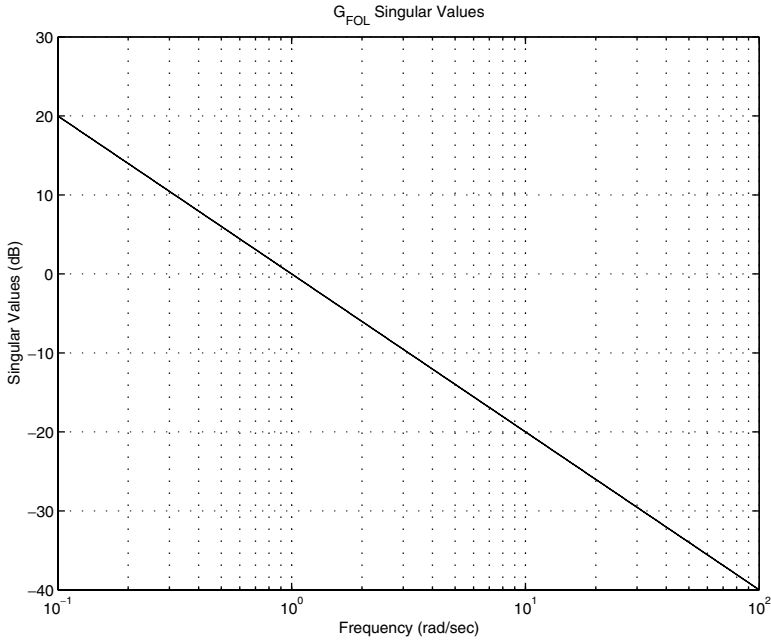

FIGURE 30.12 PUMA 560 robotic manipulator G_{FOL} singular values.

Why match the singular values of G_{FOL} in this manner? From the so-called Kalman Frequency Domain Equality (KFDE), it follows that

$$\sigma_i[I + G_{\text{KF}}(j\omega)] = \sqrt{1 + \frac{1}{\mu} \sigma_i^2[G_{\text{FOL}}(j\omega)]} \quad (30.216)$$

This suggests that by shaping G_{FOL} , we can shape the target $L_o = G_{\text{KF}}$. Specifically, if G_{FOL} is large at low frequencies, then we expect (from KFDE)

$$L_o(j\omega) = G_{\text{KF}}(j\omega) \approx \frac{1}{\sqrt{\mu}} G_{\text{FOL}}(j\omega) \quad (30.217)$$

at low frequencies. This shows that the matrix L should be used for shaping the target loop $L_o = G_{\text{KF}}$ while $\mu > 0$ is used to adjust the target loop bandwidth—decreasing/increasing μ to raise/lower the target loop bandwidth.

Note that through our selection of L , we have made all of the plant’s unstable modes uncontrollable through L . Hence, (A, L) is NOT stabilizable! While this might appear to be troublesome, it is not. What matters is that the associated Hamiltonian belongs to $\text{dom}(\text{Ric})$ so that a stabilizing H_f exists. A necessary and sufficient condition for this, however, is that (A, C) be detectable and (A, L) has no unobservable modes on the imaginary axis. Since each of these conditions are indeed satisfied, we can use the “are” command to find a stabilizing solution to the FARE.

- Next we solved the FARE with $\Theta = \mu I_{2 \times 2} (\mu = 0.1)$:

$$AY + YA^T + LL^T - YC^T \Theta^{-1} CY = 0 \quad (30.218)$$

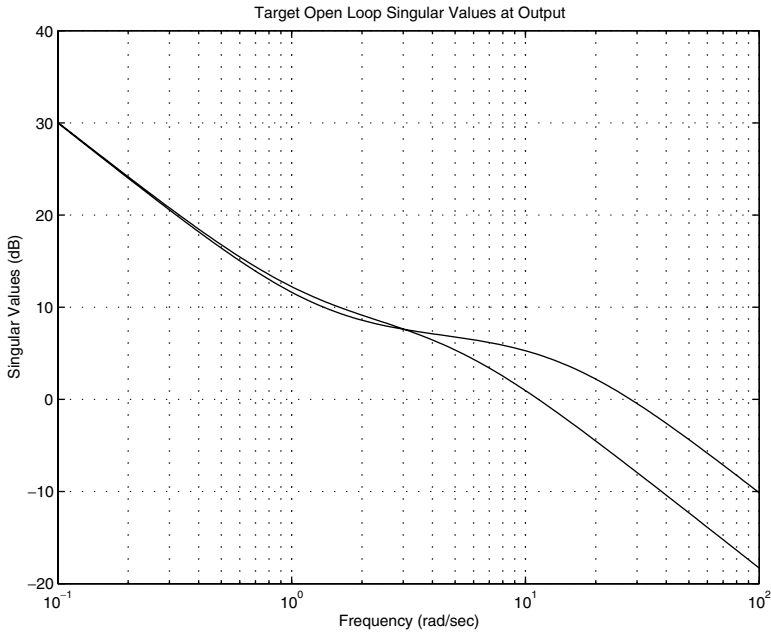

FIGURE 30.13 PUMA 560 robotic manipulator target loop G_{KF} singular values.

for $Y \geq 0$. The “are” command was used to do this, as it returns a stabilizing solution (provided that one exists). We then formed the filter gain matrix

$$H_f = YC^T \Theta^{-1} \quad (30.219)$$

$$= \begin{bmatrix} 2.3635 & 0.0384 \\ 0.4085 & 0.3091 \\ 13.1371 & -4.2300 \\ -4.2300 & 30.4572 \\ 90.2377 & -83.4384 \\ -100.9668 & 467.7679 \end{bmatrix} \quad (30.220)$$

Doing so results in the following target closed loop poles ($\lambda_i(A - H_f C)$):

$$s = -3.1623, -3.1623, -4.5299, -4.5299, -14.1050, -14.1050 \quad (30.221)$$

The singular values for the resulting target open loop transfer function matrix $L_o = G_{KF} = C(sI - A)^{-1}H_f$ are shown in Fig. 30.13.

The target open loop singular values—as expected from the KFDE—are matched at low frequencies with a slope of -20 dB/dec. They remain matched til about 1 rad/s, then they separate. This is expected since $G_{FOL} = I/s$ is not an achievable loop. (Not if closed loop stability matters!) The resulting filter gain matrix provides the necessary bandwidth to stabilize the unstable robotic manipulator, with open loop instabilities at $s = 14.1050, 4.5299$. One singular value crosses 0 dB just above 10 rad/s, the other just below 30 rad/s. μ was used to adjust the bandwidth.

The corresponding target sensitivity $S_{KF} = [I + G_{KF}]^{-1}$ singular values and complementary sensitivity $T_{KF} = G_{KF}[I + G_{KF}]^{-1}$ singular values are shown in Figs. 30.14 and 30.15, respectively. The associated

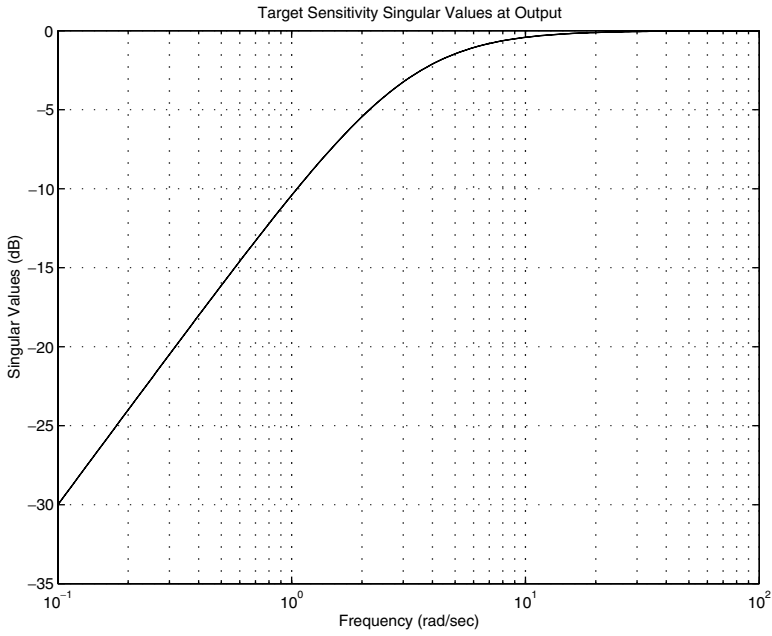

FIGURE 30.14 PUMA 560 robotic manipulator target sensitivity $S_{KF} = [I + G_{KF}]^{-1}$ singular values.

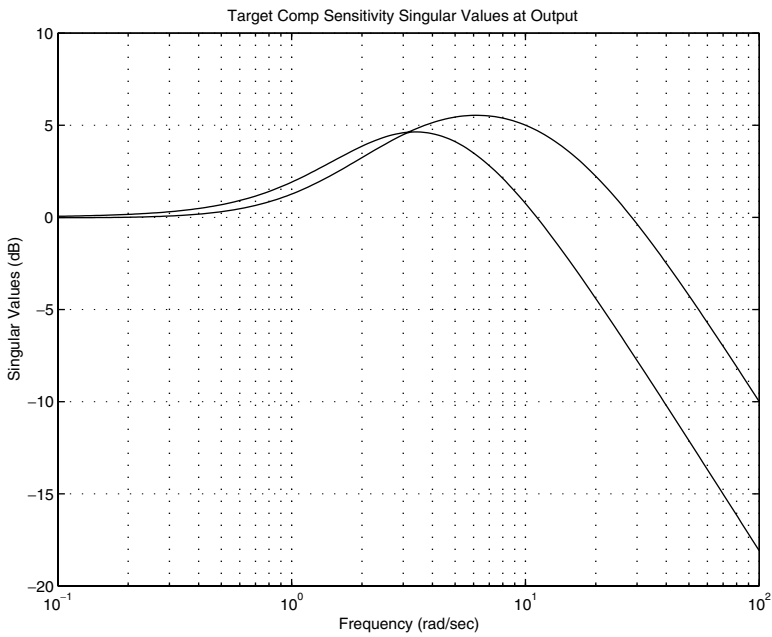

FIGURE 30.15 PUMA 560 robotic manipulator target complementary sensitivity $T_{KF} = G_{KF}[I + G_{KF}]^{-1}$ singular values.

sensitivity and complementary sensitivity singular values are desirable in that they suggest that the target loop will possess:

- good low frequency command following properties,
- good low frequency disturbance attenuation properties,
- good high frequency sensor noise attenuation properties, and
- good MIMO stability margins (nearly infinite upward gain margin, at least 6 dB downward gain margin, and at least $\pm 60^\circ$ phase margin) at the output.

The complementary sensitivity singular values suggest that a reference command prefilter W would reduce overshoot due to step reference commands. The design of such a filter will be considered below.

Step 3: Solve Cheap Control Problem to Recover Target Loop at Plant Output

Next we solve an appropriately formulated “cheap LQR control problem” that would produce a control gain matrix G_c such that the \mathcal{H}^2 optimal model-based compensator $K_d = [A - BG_c - H_f C, H_f, G_c]$ with $P_d = [A, B, C]$ approximates (“recovers”) the target loop transfer function matrix $L_o = G_{KF}$; i.e.,

$$P_d K_d \approx L_o = G_{KF} \quad (30.222)$$

This was done by solving the following CARE (using the “lqr” command) with $R = \rho I_{2 \times 2}$ ($\rho = 10^{-13}$):

$$XA + A^T X + C^T C - XBR^{-1}B^T X = 0 \quad (30.223)$$

for $X \geq 0$ and forming the control gain matrix

$$G_c = R^{-1}B^T X \quad (30.224)$$

$$= \begin{bmatrix} 987.9832 & -543.0034 & 3162945.2928 & 56.9921 & 13941.9005 & 2069.8324 \\ -543.0034 & 3657.5891 & 11.7867 & 3162634.3919 & 2069.7987 & 3765.7978 \end{bmatrix} \quad (30.225)$$

Doing so yields the following closed loop regulator poles ($\lambda_i(A - BG_c)$):

$$s = -440.8808, -220.4404 \pm j381.7871, -1881.9053, -940.9527 \pm j1629.7168 \quad (30.226)$$

All have damping factors greater than or equal to $\zeta = 0.5$. As a practical note to facilitate real-time implementation of the resulting controller, one might use model reduction techniques [10] to remove some of the very high frequency poles in the compensator. Doing so would permit using a larger integration step size in any real-time embedded system or microprocessor implementation.

Step 4: Construct Final Controller K

Next we form the final controller as follows:

$$K = \frac{K_d}{s} \quad (30.227)$$

$$= \frac{[A - BG_c - H_f C, H_f, G_c]}{s} \quad (30.228)$$

$$= [A_k, B_k, C_k] \quad (30.229)$$

A state space representation for this controller is given by

$$A_K = \begin{bmatrix} \mathbf{0}_{2 \times 2} & G_c \\ \mathbf{0}_{6 \times 2} & A - BG_c - H_f C \end{bmatrix}, \quad B_K = \begin{bmatrix} \mathbf{0}_{2 \times 2} \\ H_f \end{bmatrix} \quad (30.230)$$

$$C_K = \begin{bmatrix} I_{2 \times 2} & \mathbf{0}_{2 \times 6} \end{bmatrix} \quad (30.231)$$

With this selection, we have

$$PK = P \frac{K_d}{s} \quad (30.232)$$

$$= P \frac{I_{2 \times 2}}{s} K_d \quad (30.233)$$

$$= P_d K_d \quad (30.234)$$

$$\approx L_o = G_{KF} \quad (30.235)$$

Through this selection of K , we have recovered the target loop transfer function matrix $L_o = G_{KF}$. That is, K has approximately inverted P (from the right) in order to achieve $PK \approx L_o = G_{KF}$. An examination of the singular values for the actual loop PK shows that the actual singular values agree with the target singular values up to and beyond 100 rad/s.

Loop Transfer Recovery. Why were we able to recover the target loop? The recovery was permitted by the model-based structure of the compensator K , the Riccati equations used to obtain the gain matrices G_c and H_f , and the fact that the plant $P = [A_p, B_p, C_p]$ (and hence the design plant $P_d = [A, B, C] = P(I/s)$) is minimum phase. The minimum phase condition, specifically, is a sufficient condition which guarantees that there exists an orthonormal matrix $U(U^T U = U U^T = I)$ such that

$$\lim_{\rho \rightarrow 0^+} \sqrt{\rho} G_c = UC \quad (30.236)$$

This limiting behavior relating the control gain matrix and the design plant's C matrix, however, can be used to prove that loop transfer recovery takes place; i.e.,

$$\lim_{\rho \rightarrow 0^+} P_d K_d = \lim_{\rho \rightarrow 0^+} PK = L_o = G_{KF} \quad (30.237)$$

Step 5: Design Command Pre-filter W

The MATLAB command

$$t_0(a - b * g - h * c, h, g) \quad (30.238)$$

can be used to find the compensator's transmission zeros. These are also zeros of the closed loop transfer function matrix from r to y . The final compensator (as well as the target loop G_{KF}) has zeros near $s \approx -1.2$. Given this, a reference command prefilter

$$W = \frac{1.2}{s + 1.2} I_{2 \times 2} \quad (30.239)$$

was added outside the loop to filter reference commands. By so doing, we ensure that step reference commands for θ_1 and θ_2 are followed in the steady state (due to integrators in controller) without excessive overshoot during the transient.

Sensitivity Frequency Response

The resulting sensitivity singular values are plotted in Fig. 30.16. The plot suggests that low frequency reference commands r will be followed and low frequency output disturbances d_o will be attenuated. More precisely, reference commands r with frequency content below 0.3 rad/s should be followed to within about 20 dB; that is, with a steady-state error of about 10%. Similarly, output disturbances d_o with frequency content below 0.3 rad/s should be attenuated by approximately 20 dB.

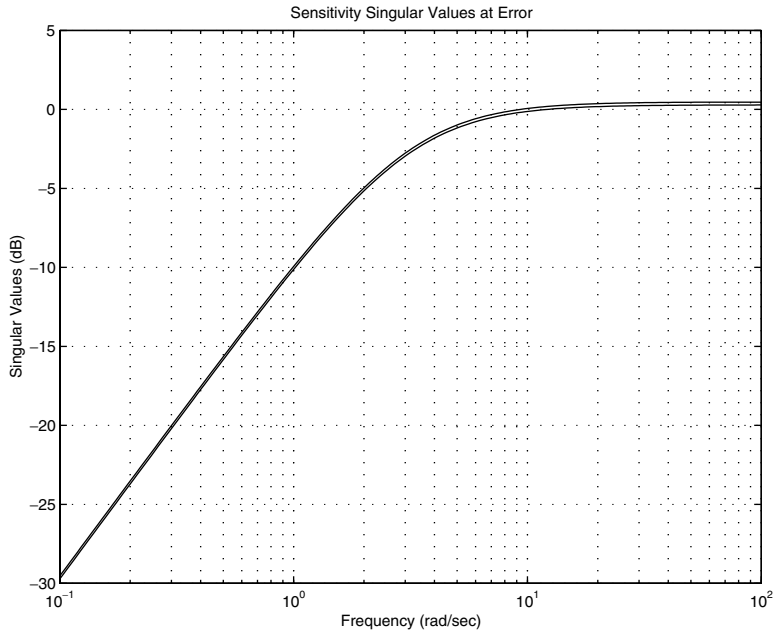

FIGURE 30.16 PUMA 560 sensitivity frequency response at error.

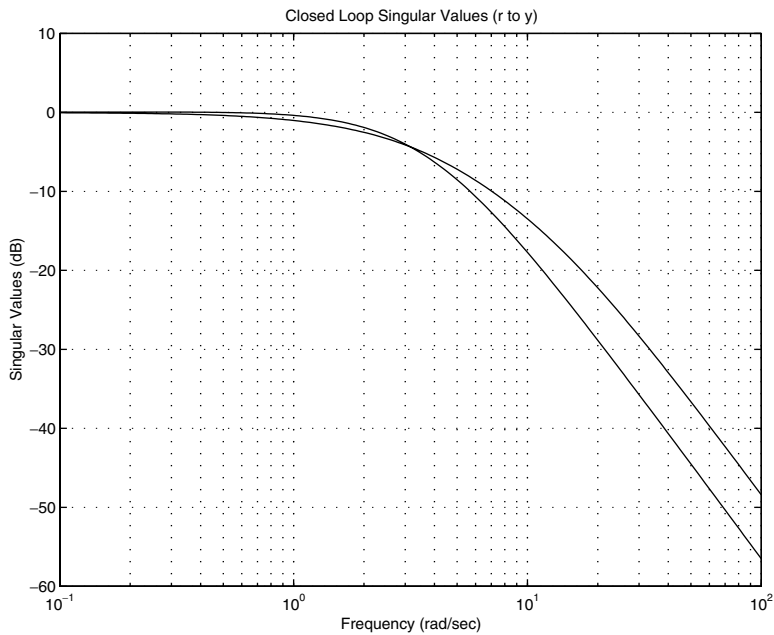

FIGURE 30.17 PUMA 560 reference to output frequency response.

Reference to Output Frequency Response

The transfer function matrix from reference commands r to link angles y is

$$T_{ry} = [I + PK]^{-1}PKW \tag{30.240}$$

Its singular values are plotted in Fig. 30.17. The plot suggests that low frequency reference commands will be followed in the steady state and that little overshoot will result during the transient.

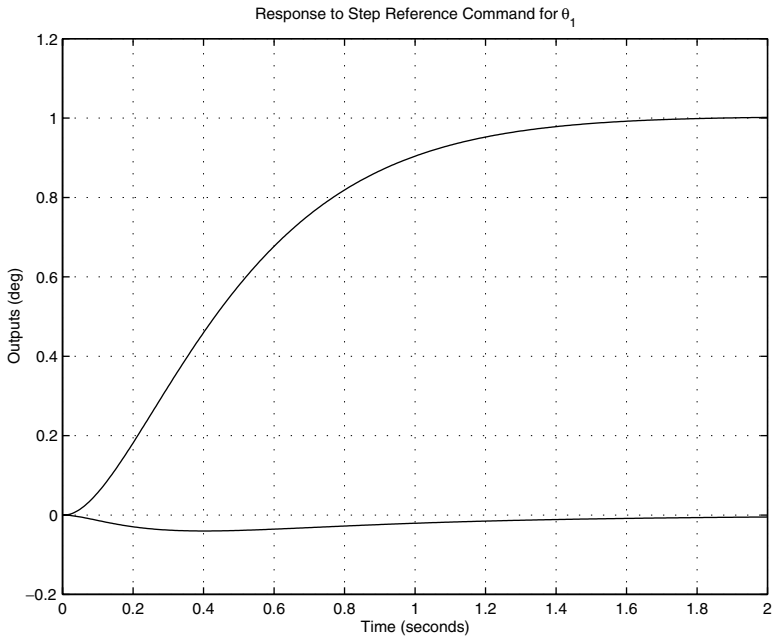

FIGURE 30.18 PUMA 560 outputs: response to θ_1 reference command.

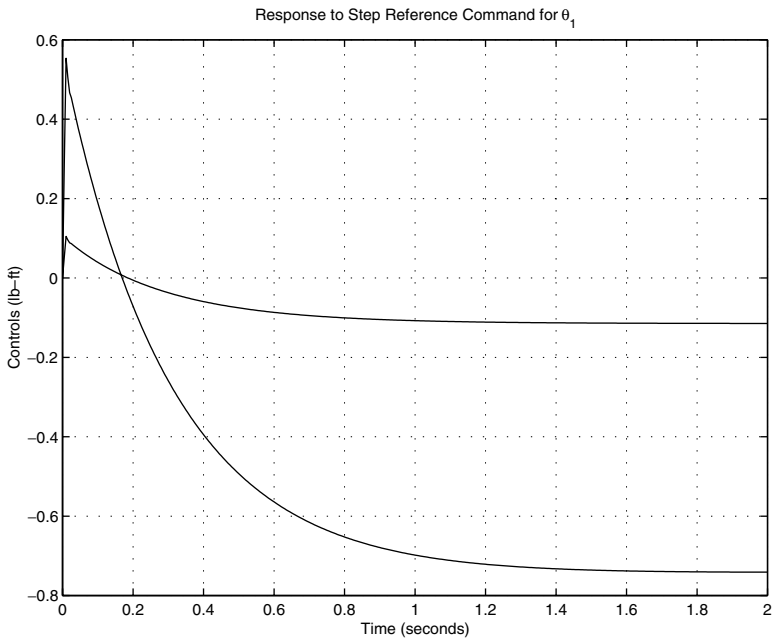

FIGURE 30.19 PUMA 560 controls: response to θ_1 reference command.

Response to Θ_1 Step Reference Command

The response to a unit step θ_1 command is plotted in Fig. 30.18. As expected, θ_1 follows the step command well, with no overshoot and settling in about 1.6 s. The associated θ_2 response is small, indicating little cross coupling in the final closed loop system. The corresponding controls are plotted in Fig. 30.19. They are acceptable in size.

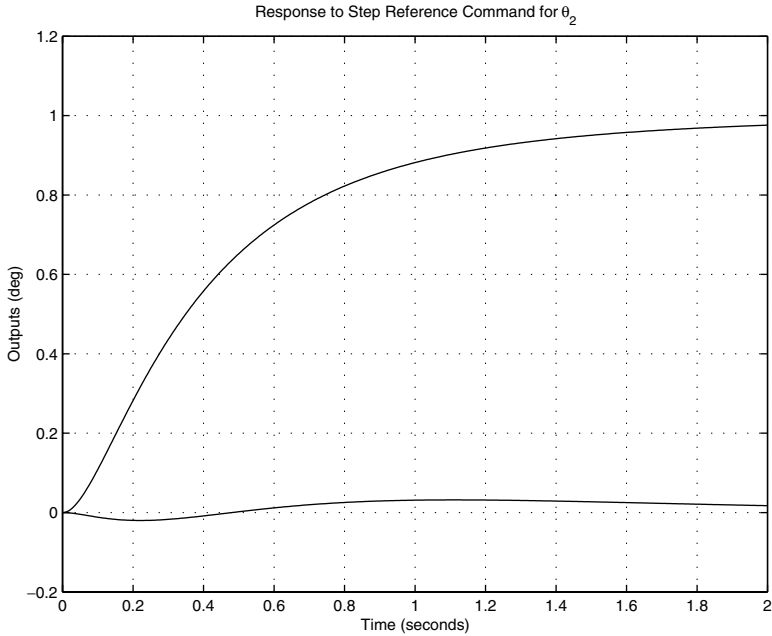

FIGURE 30.20 PUMA 560 outputs: response to θ_2 reference command.

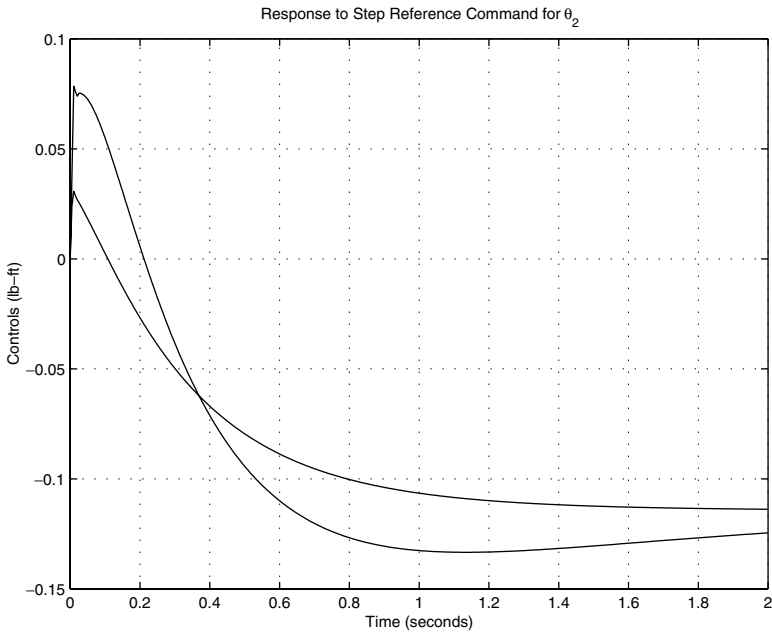

FIGURE 30.21 PUMA 560 controls: response to θ_2 reference command.

Response to Θ_2 Step Reference Command

The response to a unit step θ_2 command is plotted in Fig. 30.20. As expected, θ_2 follows the step command well, with no overshoot and settling in about 3 s. The associated θ_1 response is small, indicating little cross coupling in the final closed loop system. The corresponding controls are plotted in Fig. 30.21. They are acceptable in size. ■

30.4 \mathcal{H}^2 State Feedback Problem

This section shows that the methods presented for output feedback may be readily adopted to permit the design of \mathcal{H}^2 optimal constant gain state feedback control laws (control gain matrices G_c) as well.

Generalized Plant Structure for State Feedback

For this case, the generalized plant G (including plant P and weighting functions) takes the following form:

$$G = \left[\begin{array}{c|c} G_{11} & G_{12} \\ \hline G_{21} & G_{22} \end{array} \right] = \left[\begin{array}{c|cc} A & B_1 & B_2 \\ \hline C_1 & 0_{n_z \times n_w} & D_{12} \\ I_{n \times n} & 0_{n_y \times n_w} & 0_{n_y \times n_u} \end{array} \right] = \left[\begin{array}{c|c} A & B \\ \hline C & D \end{array} \right] \quad (30.241)$$

This implies that the measured signals y are the states x of the generalized plant G . As such, all of the modes of A are observable through $C_2 = I_{n \times n}$.

State Feedback Assumptions

The standard state feedback assumptions are a subset of those required for the output feedback problem formulation. The state feedback assumptions are as follows.

Assumption 30.2 (\mathcal{H}^2 State Feedback Problem)

Throughout this section, it will be assumed that

1. *Plant G_{22} Assumption.* (A, B_2) stabilizable.
2. *Nonsingular Control Weighting Assumption.* $R = D_{12}^T D_{12} > 0$ (D_{12} full column rank).
3. *Regulator Assumption.* $\begin{bmatrix} j\omega I - A & -B_2 \\ C_1 & D_{12} \end{bmatrix}$ has full column rank for all ω . ■

It should be noted that if $D_{12}^T C_1 = 0$, then (3) is equivalent to (A, C_1) having no unobservable imaginary modes. If (A, C_1) is detectable, then this is satisfied.

\mathcal{H}^2 Optimal State Feedback Control Law

The \mathcal{H}^2 optimal controller is given by

$$K_{\text{opt}} = -G_c \quad (30.242)$$

where the control gain matrix $G_c \in \mathcal{R}^{n_u \times n}$ is given by

$$G_c = R^{-1} [B_2^T X + D_{12}^T C_1] \quad (30.243)$$

where $X \geq 0$ is the unique (at least) positive semi-definite solution of the CARE:

$$(A - B_2 R^{-1} D_{12}^T C_1)^T X + X(A - B_2 R^{-1} D_{12}^T C_1) + C_1^T (I - D_{12}^T R^{-1} D_{12}^T) C_1 - X B_2 R^{-1} B_2^T X = 0 \quad (30.244)$$

The closed loop poles that result from the above constant gain state feedback control law are the eigenvalues of $A - B_2 G_c$. The minimum closed loop norm is given by

$$\min_K \|T_{wz}\|_{\mathcal{H}^2} = \sqrt{\text{trace}(B_1^T X B_1)} \quad (30.245)$$

State Feedback Loop Shaping

If one selects

$$B_2 = B \quad (30.246)$$

$$C_1 = \begin{bmatrix} M \\ 0_{n_u \times n} \end{bmatrix} \quad (30.247)$$

$$D_{12} = \begin{bmatrix} 0_{n_y \times n_u} \\ \sqrt{\rho} I_{n_u \times n_u} \end{bmatrix} \quad (30.248)$$

$$R = \rho I_{n_u \times n_u} \quad (30.249)$$

then $D_{12}^T C_1 = 0$ and we have

$$G_c = \frac{1}{\rho} B_2^T X \quad (30.250)$$

where $X \geq 0$ is the unique (at least) positive semi-definite solution of the CARE:

$$A^T X + XA + M^T M - XB \frac{1}{\rho} B^T X = 0 \quad (30.251)$$

The following LQFDE may be derived from the CARE:

$$[I + G_{LQ}(j\omega)]^H [I + G_{LQ}(j\omega)] = I + \left[\frac{1}{\sqrt{\rho}} G_{OL}(j\omega) \right]^H \left[\frac{1}{\sqrt{\rho}} G_{OL}(j\omega) \right] \quad (30.252)$$

where

$$G_{OL} = M(sI - A)^{-1} B \quad (30.253)$$

$$G_{LQ} = G_c(sI - A)^{-1} B \quad (30.254)$$

Given this, the loop shaping ideas discussed earlier are applicable. A designer may use the matrix M and the scalar $\rho > 0$ to shape G_{OL} in an effort to get a desirable loop G_{LQ} . The matrix M , specifically, may be used to match singular values at low frequencies, high frequencies, all frequencies, etc. Assuming that (A, B) is stabilizable and (A, M) has no imaginary modes that are unobservable, a stabilizing solution is guaranteed to exist. Moreover, the resulting G_{LQ} loop will possess nominal sensitivity and stability robustness properties—a consequence of the LQFDE. The resulting control gain matrix G_c may be used within a state feedback loop, a modified state feedback loop, or within a model-based compensator.

30.5 \mathcal{H}^2 Output Injection Problem

This section shows how the methods presented for output feedback may be readily adopted to permit the design of \mathcal{H}^2 optimal state estimators (filter gain matrices H_f) as well.

Generalized Plant Structure for Output Injection

For this case (dual to the state feedback case), the generalized plant G (including plant P and weighting functions) takes the following form:

$$G = \left[\begin{array}{c|c} G_{11} & G_{12} \\ \hline G_{21} & G_{22} \end{array} \right] = \left[\begin{array}{c|cc} A & B_1 & I_{n \times n} \\ \hline C_1 & 0_{n_z \times n_w} & 0_{n_z \times n_u} \\ C_2 & D_2 & 0_{n_y \times n_u} \end{array} \right] = \left[\begin{array}{c|c} A & B \\ \hline C & D \end{array} \right] \quad (30.255)$$

This implies that the control signals u directly impact all of the generalized plant states x . As such, all of the modes of A are controllable through $B_2 = I_{n \times n}$.

Output Injection Assumptions

The standard output injection assumptions are a subset of those required for the output feedback problem formulation. The output injection assumptions are as follows.

Assumption 30.3 (\mathcal{H}^2 Output Injection Problem)

Throughout this section, it will be assumed that

1. *Plant G_{22} Assumption.* (A, C_2) detectable.
2. *Nonsingular Measurement Weighting Assumption.* $\Theta = D_{21}D_{21}^T > 0$ (D_{21} full row rank).
3. *Filter Assumption.* $\begin{bmatrix} j\omega I - A & -B \\ C_1 & D_{21} \end{bmatrix}$ has full row rank for all ω . ■

It should be noted that if $B_1D_{21}^T = 0$, then (3) is equivalent to (A, B_1) having no uncontrollable imaginary modes. If (A, B_1) is stabilizable, then this is satisfied.

\mathcal{H}^2 Optimal Output Injection Law

The \mathcal{H}^2 optimal controller is then given by

$$K_{\text{opt}} = -H_f \quad (30.256)$$

where the filter gain matrix $H_f \in \mathcal{R}^{n \times n_y}$ is given by

$$H_f = [YC_2^T + B_1D_{21}^T]\Theta^{-1} \quad (30.257)$$

where $Y \geq 0$ is the unique (at least) positive semi-definite solution of the FARE:

$$(A - B_1D_{21}^T\Theta^{-1}C_2)Y + Y(A - B_1D_{21}^T\Theta^{-1}C_2)^T + B_1(I - D_{21}^T\Theta^{-1}D_{21})B_1^T - YC_2^T\Theta^{-1}C_2Y = 0 \quad (30.258)$$

The closed loop poles that result from the above output injection law are the eigenvalues of $A - H_fC_2$. The minimum closed loop norm is given by

$$\min_K \|T_{wz}\|_{\mathcal{H}^2} = \sqrt{\text{trace}\left(C_1YC_1^T\right)} \quad (30.259)$$

where Y is the solution to the FARE.

Estimator (Filter) Loop Shaping

If one selects

$$B_1 = [L \quad 0_{n \times n_y}] \quad (30.260)$$

$$D_{21} = [0_{n_y \times n_u} \quad \sqrt{\mu} I_{n_y \times n_y}] \quad (30.261)$$

$$C_2 = C \quad (30.262)$$

$$\Theta = \mu I_{n_y \times n_y} \quad (30.263)$$

then $B_1 D_{21}^T = 0$ and we have

$$H_f = Y C_2^T \frac{1}{\mu} \quad (30.264)$$

where $Y \geq 0$ is the unique (at least) positive semi-definite solution of the FARE:

$$Y A^T + A Y + L L^T - Y C^T \Theta^{-1} C Y = 0 \quad (30.265)$$

Given this, the following KFDE may be derived from the FARE:

$$[I + G_{\text{KF}}(j\omega)][I + G_{\text{KF}}(j\omega)]^H = I + \left[\frac{1}{\sqrt{\mu}} G_{\text{FOL}}(j\omega) \right] \left[\frac{1}{\sqrt{\mu}} G_{\text{FOL}}(j\omega) \right]^H \quad (30.266)$$

where

$$G_{\text{FOL}} = C(sI - A)^{-1} L \quad (30.267)$$

$$G_{\text{KF}} = C(sI - A)^{-1} H_f \quad (30.268)$$

Given this, the loop shaping ideas discussed earlier are applicable. A designer may use the matrix L and the scalar $\mu > 0$ to shape G_{FOL} in an effort to get a desirable loop G_{KF} . The matrix L , specifically, may be used to match singular values at low frequencies, high frequencies, all frequencies, etc. Assuming that (A, C) is detectable and (A, L) has no imaginary modes that are uncontrollable, then a stabilizing solution is guaranteed to exist. Moreover, the resulting G_{KF} loop will possess nominal sensitivity and stability robustness properties—a consequence of the KFDE. The resulting filter (output injection) gain matrix H_f may be used within an estimator (feedback) loop, a modified estimator (feedback) loop, or within a model-based compensator.

30.6 Summary

This chapter has presented a general framework for control system design via \mathcal{H}^2 optimization. While the focus has been on continuous time LTI systems, the methods are very flexible and have wide application. They may be used to design constant gain state feedback control laws, constant gain state estimators, dynamic output feedback controllers, and much more. Weighting functions are easily accommodated within the generalized plant framework presented. Such functions may be used to achieve closed loop design objectives. All of the ideas presented may be extended with subtle (all be it very important)

modifications, to accommodate control system design via \mathcal{H}^∞ optimization. Additional details may be found in [8,11].

The methods presented in this chapter may be extended to discrete time linear shift invariant (LSI) systems. Extensions to sampled data systems are also possible [1].

References

1. Chen, T. and Francis, B., *Optimal Sampled-Data Control Systems*, Springer, London, 1995.
2. Dorf, R.C. and Bishop, R.H., *Modern Control Systems*, Addison Wesley, 8th edition, CA, 1998.
3. Doyle, J.C., "Guaranteed margins for LQG regulators," *IEEE Transactions on Automatic Control*, Vol. AC-23, No. 4, August 1978, pp. 756–757.
4. Doyle, J.C., Glover, K., Khargonekar, P.P., and Francis, B.A., "State-space solutions to standard \mathcal{H}^2 and \mathcal{H}^∞ control problems," *IEEE Transactions on Automatic Control*, Vol. AC-34, No. 8, 1989, pp. 831–847. Also see *Proceedings of the 1988 American Control Conference*, Atlanta, Georgia, June, 1988.
5. Kalman, R.E., "A new approach to linear filtering and prediction problems," *ASME Journal of Basic Engineering*, Vol. 85, 1960, pp. 34–45.
6. Kalman, R.E. and Bucy, R.S., "New results in linear filtering and prediction problems," *ASME Journal of Basic Engineering*, 1960, pp. 95–108.
7. Kwakernaak, H. and Sivan, R., *Linear Optimal Control Systems*, Wiley-Interscience, New York, 1972.
8. Rodriguez, A.A., *A Practical Neo-Classical Approach to Feedback Control System Analysis and Design*, Control3D, 2000.
9. Spong, M.W. and Vidyasagar, M., *Robot Dynamics and Control*, John Wiley and Sons, New York, 1989.
10. Zhou, K., Doyle, J.C., and Glover, K., *Robust and Optimal Control*, Prentice-Hall, NJ, 1996.
11. Zhou, K. and Doyle, J.C., *Essentials of Robust Control*, Prentice-Hall, NJ, 1998.

31

Adaptive and Nonlinear Control Design

- 31.1 Introduction
- 31.2 Lyapunov Theory for Time-Invariant Systems
- 31.3 Lyapunov Theory for Time-Varying Systems
- 31.4 Adaptive Control Theory
Regulation and Tracking Problems • Certainty Equivalence
Principle • Direct and Indirect Adaptive Control • Model
Reference Adaptive Control (MRAC) • Self-Tuning
Controller (STC)
- 31.5 Nonlinear Adaptive Control Systems
- 31.6 Spacecraft Adaptive Attitude Regulation Example
- 31.7 Output Feedback Adaptive Control
- 31.8 Adaptive Observers and Output Feedback Control
- 31.9 Concluding Remarks

Maruthi R. Akella

The University of Texas at Austin

31.1 Introduction

The most important challenge for modern control theory is that it should deliver acceptable performance while dealing with poor models, high nonlinearities, and low-cost sensors under a large number of operating conditions. The difficulties encountered are not peculiar to any single class of systems and they appear in virtually every industrial application. Invariably, these systems contain such a large amount of model and parameter uncertainty that “fixed” controllers can no longer meet the stability and performance requirements. Any reasonable solution for such problems must be a suitable amalgamation between nonlinear control theory, adaptive elements, and information processing. Such are the factors behind the birth and evolution of the field of adaptive control theory, strongly motivated by several practical applications such as chemical process control and design of autopilots for high-performance aircraft, which operate with proven stability over a wide variety of speeds and altitudes.

A commonly accepted definition for an adaptive system is that it is any physical system that is designed from an adaptive standpoint!¹ All existing stability and convergence results, in the field of adaptive control theory, hinge on the crucial assumption that the unknown parameters must occur linearly within the plant containing known nonlinearities. Conceptually, the overall process makes the parameter estimates themselves as state variables, thus enlarging the dimension of the state space for the original system. By nature, adaptive control solutions for both linear and nonlinear dynamical systems lead to nonlinear time-varying formulations wherein the estimates of the unknown parameters are updated using input–output data. A parameter adaptation mechanism (typically nonlinear) is used to update the parameters within the control law. Given the nonlinearity due to adaptive feedback, there is the need to ensure that the closed-loop stability is preserved. It is thus an unmistakable fact that the fields of adaptive control and nonlinear system stability are intrinsically related to one another and any new insights gained in one

field would be of potential benefit to the other. Many formalisms in nonlinear stability theory can be employed such as the Lyapunov direct method and passivity-based methods. We will first present some important mathematical and analytical tools for studying the stability of nonlinear dynamical systems.

31.2 Lyapunov Theory for Time-Invariant Systems

The Lyapunov direct method is a commonly adopted and arguably one of the most popular methods for proving closed-loop stability in the adaptive control area. It is not restricted to local system behavior and determines the stability properties of the nonlinear system by considering the time evolution of the system solutions with respect to an “energy-like” scalar function, often known as the Lyapunov function.

Consider any dynamical system represented by the following nonlinear autonomous differential equation

$$\dot{\mathbf{x}} = \mathbf{f}(\mathbf{x}), \quad \mathbf{f}(0) = 0 \quad (31.1)$$

Obviously $\mathbf{x}(t) = 0$ is a solution. A sufficient condition for the existence and uniqueness of solutions for Eq. (31.1) is that $\mathbf{f}(\mathbf{x})$ be locally Lipschitz, that is,

$$\|\mathbf{f}(\mathbf{x}) - \mathbf{f}(\mathbf{y})\| \leq L\|\mathbf{x} - \mathbf{y}\| \quad (31.2)$$

for all \mathbf{x} and \mathbf{y} in a finite neighborhood of the origin. We are interested in the stability of the solutions of Eq. (31.1) in the presence of perturbations. Before discussing the main Lyapunov stability theorems, we present some important definitions.

Definition: Lyapunov stability

The solution $\mathbf{x}(t) = 0$ of Eq. (31.1) is called *stable* in the sense of Lyapunov if for all $\epsilon > 0$, there exists a $\delta(\epsilon) > 0$ such that for all initial conditions satisfying $\|\mathbf{x}(0)\| < \delta$, we have $\|\mathbf{x}(t)\| < \epsilon$ for $t \in [0, \infty)$. The solution is *unstable* if it is not stable. The solution is *asymptotically stable* if it is stable and there exists a $\delta > 0$ such that every initial condition that satisfies $\|\mathbf{x}(0)\| < \delta$ has the property

$$\lim_{t \rightarrow \infty} \|\mathbf{x}(t)\| = 0$$

The solution is *globally asymptotically stable* if it is asymptotically stable for all initial conditions. These definitions refer to stability of particular solutions of Eq. (31.1) with respect to initial conditions and not to the stability of differential equations.

Definition: Positive definite and semidefinite functions

Any continuously differentiable function $V: \mathcal{R}^n \rightarrow \mathcal{R}$ is called *positive definite* if (i) $V(0) = 0$ and (ii) $V(\mathbf{x}) > 0$ for all $\mathbf{x} \neq 0$. A function is *positive semidefinite* if condition (ii) is replaced by $V(\mathbf{x}) \geq 0$ for all $\mathbf{x} \neq 0$.

Theorem: Lyapunov’s stability theorem for time-invariant systems

If there exists a positive definite function $V: \mathcal{R}^n \rightarrow \mathcal{R}$ such that the time derivative of V along the solution of $\dot{\mathbf{x}} = \mathbf{f}(\mathbf{x})$ given by

$$\frac{d}{dt}V = \left[\frac{\partial V}{\partial \mathbf{x}} \right]^T \dot{\mathbf{x}} = \left[\frac{\partial V}{\partial \mathbf{x}} \right]^T \mathbf{f}(\mathbf{x})$$

is negative semidefinite, then the solution $\mathbf{x}(t) = 0$ of Eq. (31.1) is stable. In this case, the solution converges to the set $\{\mathbf{x} \in \mathcal{R}^n: \dot{V}(\mathbf{x}) = 0\}$. If \dot{V} is negative definite, then the solution is asymptotically stable. Furthermore, if \dot{V} is negative definite and $V(\mathbf{x}) \rightarrow \infty$ as $\|\mathbf{x}\| \rightarrow \infty$, then the solution is globally asymptotically stable. The function $V(\mathbf{x})$ is called a Lyapunov function for the system described by Eq. (31.1).

Remark: Lyapunov's theorem, though simple to state, has powerful applications in the stability analysis of nonlinear systems. However, since the theorem provides only a sufficient condition in terms of the Lyapunov function, we are often encountered with the difficult problem of finding a suitable Lyapunov function. In the special case when Eq. (31.1) is a stable linear system,

$$\dot{\mathbf{x}} = A_m \mathbf{x}$$

a quadratic Lyapunov function $V = \mathbf{x}^T P \mathbf{x}$ exists where P is a symmetric positive definite matrix satisfying the so-called Lyapunov equation

$$A_m^T P + P A_m = -Q \quad (31.3)$$

for any symmetric positive definite Q matrix. On the other hand, there is no general recipe for construction of Lyapunov functions for nonlinear systems. As a rule of thumb, in the case of mechanical systems, "energy-like" quantities are good candidates for a first attempt.

31.3 Lyapunov Theory for Time-Varying Systems

We are now ready to consider the stability of solutions for a time-varying (nonautonomous) differential equation

$$\dot{\mathbf{x}} = \mathbf{g}(\mathbf{x}, t), \quad \mathbf{g}(0, t) = 0 \quad \forall t \leq 0 \quad (31.4)$$

The function \mathbf{g} is assumed to be piecewise continuous with respect to t and locally Lipschitz in \mathbf{x} about a neighborhood of the solution $\mathbf{x}(t) = 0$. This would guarantee that the origin is an equilibrium for Eq. (31.4). In order to investigate the stability of equilibrium for this nonautonomous system, it is important to recognize that any solution of Eq.(31.4) depends not only on time t but also on the initial time t_0 . Thus, we need to revisit our previous definitions of stability.

Definition: Uniform Lyapunov stability

The solution $\mathbf{x}(t) = 0$ for Eq.(31.4) is *uniformly stable* if for every $\epsilon > 0$, there exists a $\delta(\epsilon) > 0$ that is independent of the initial time t_0 such that

$$\|\mathbf{x}(t_0)\| < \delta \quad \text{implies} \quad \|\mathbf{x}(t)\| < \epsilon \quad \forall t \geq t_0 \geq 0$$

The solution is *uniformly asymptotically stable* if it is uniformly stable and there is a positive constant ρ independent of t_0 such that $\|\mathbf{x}(t)\| \rightarrow 0$ as $t \rightarrow \infty$ for all $\|\mathbf{x}(t_0)\| < \rho$. The solution is *globally uniformly asymptotically stable* if it is uniformly asymptotically stable for all initial conditions.

The main stability theorem for nonautonomous systems requires the definition of certain *class K functions*.

Definition: Class K functions

A continuous function $\alpha: [0, a) \rightarrow [0, \infty)$ is said to belong to *class K* if it is strictly increasing and $\alpha(0) = 0$. It is said to belong to class K_∞ , or radially unbounded, if $a = \infty$ in such a way that $\alpha(r) \rightarrow \infty$ as $r \rightarrow \infty$.

Theorem: Lyapunov's stability theorem for time-varying systems

Consider a set $D = \{\mathbf{x} \in \mathcal{R}^n: \|\mathbf{x}\| \leq R\}$ about the equilibrium $\mathbf{x}(t) = 0$ for Eq. (31.4). If there exists a scalar function $V: \mathcal{R}^n \times \mathcal{R}^+ \rightarrow \mathcal{R}$ with continuous partial derivatives such that

- (i) $\alpha_1(\|\mathbf{x}\|) \leq V(\mathbf{x}, t) \leq \alpha_2(\|\mathbf{x}\|)$ *positive definite and decrescent*
- (ii) $\dot{V} = \frac{\partial V}{\partial t} + \left[\frac{\partial V}{\partial \mathbf{x}} \right]^T \mathbf{g}(\mathbf{x}, t) \leq \alpha_3(\|\mathbf{x}\|)$

for all $t \geq 0$, where α_1 , α_2 , and α_3 are class K functions, then the equilibrium point $\mathbf{x} = 0$ is uniformly asymptotically stable.

Remark: Note that in order to show stability for nonautonomous systems, it is necessary to bound the function $V(\mathbf{x}, t)$ by the class K functions that do not depend upon time t . A detailed treatment of all the definitions and proof for this theorem can be found in Slotine and Li² and Khalil.³

Remark: In the recent years, several interesting converse Lyapunov results have been obtained. In particular, for every uniformly stable (or uniformly asymptotic stable) system, there exists a positive definite Lyapunov function with a negative semidefinite time derivative (see Sastry and Bodson⁴). These results are particularly useful from a closed-loop performance point of view because they allow us to explicitly estimate the convergence rates in some cases of nonlinear adaptive control systems.

The application of Lyapunov's stability theorem for nonautonomous systems arising out of adaptive control often leads us to negative semidefinite time derivatives of the Lyapunov function. Therefore, asymptotic stability analysis is a much harder problem and the following result, known as Barbalat's Lemma, is extremely useful in such situations.

Lemma: Barbalat.

Consider a uniformly continuous function $\phi: \mathcal{R} \rightarrow \mathcal{R}$ defined at all real values of $t \geq 0$. If

$$\lim_{t \rightarrow \infty} \int_0^t \phi(s) ds$$

exists and is finite, then $\phi(t) \rightarrow 0$ as $t \rightarrow \infty$.

Remark: A consequence of this result is that if $\phi \in \mathcal{L}_2$ and $\dot{\phi} \in \mathcal{L}_\infty$, then $\phi(t) \rightarrow 0$ as $t \rightarrow \infty$ (see Slotine and Li² and Tao⁵ for discussion and proof).

31.4 Adaptive Control Theory

In contrast to a fixed or ordinary controller, an adaptive controller is one with adjustable parameters and an adjustment mechanism. The following are some basic concepts that are necessary for any discussion of adaptive control theory.

Regulation and Tracking Problems

The desired objective for any control problem is to maintain the plant output either at its desired value or within specified/acceptable bounds of the desired value. If these desired values are constant with respect to time, we have a regulation problem, otherwise it is a tracking problem.

Certainty Equivalence Principle

This principle has been the bedrock of most adaptive control design methods and has received considerable attention during the past two decades.^{4,6,7} Adaptive controllers based on this approach are obtained by independently designing a control law that meets the control objective assuming complete knowledge of all the unknown plant parameters (deterministic case), along with a parameter update law, which is usually a differential equation that generates online parameter estimates that are used to replace the unknown parameters within the control law. Such a controller would have perfect output tracking capability in the case when the plant parameters are exactly known. In the presence of parameter uncertainty, the adaptation mechanism will adjust the controller parameters so that the tracking objective is asymptotically achieved. The main issue, thus, in adaptive controller design is to synthesize the adaptation mechanism (parameter update law) that will guarantee that the control system remains stable and the output tracking error converges to zero as the parameter values are updated.

Direct and Indirect Adaptive Control

There exist two philosophically distinct approaches within adaptive control for plants containing unknown or uncertain parameters. The first of those is the so-called *direct approach* where the controller parameters are directly adjusted by the adaptation mechanism in such a way to optimize some pre-specified performance index based on the output. The second approach is the *indirect approach* wherein plant parameters are directly estimated and updated by the adaptation law and these estimated values are then used to compute the controller parameters. Direct adaptive control eliminates the need for this additional computation. Consequently, indirect adaptive control is plant parameter adaptive, whereas direct adaptive control is output performance adaptive. The plant parameter identification process is explicit within the direct approach while implicit in the indirect approach. Hence, they have also been referred to as explicit and implicit approaches. In both of these cases, the controller structure remains the same and is determined from the certainty equivalence principle.

Model Reference Adaptive Control (MRAC)

The MRAC framework consists of four parts: (i) the plant containing the unknown parameters, (ii) a suitable reference model for specifying the desired output characteristics, (iii) a feedback control law that contains adjustable parameters, and (iv) an adaptation mechanism that updates the adjustable parameters within the control law. A schematic sketch for this framework is shown in Fig. (31.1).

The plant is assumed to have a known structure with unknown parameters. For the case of linear systems, this means that the number of poles and zeros are assumed to be known, but the exact locations of poles and zeros are unknown. In the case of nonlinear systems, the structure of the governing equations of motion is assumed to be known, but some of the parameters appearing linearly within those equations can be unknown. The reference model specifies the desired output behavior expected from the plant as a result of the external reference input. It provides the ideal plant response which the adaptation mechanism should seek to track while updating the parameter estimates. The choice of the reference plant lies at the heart of any MRAC design and any acceptable selection must essentially satisfy two crucial requirements. The first of these requirements is that the reference model must accurately reflect the closed-loop performance specifications such as rise time, settling time, overshoot, and other transient performance characteristics. The other requirement is that given the assumed structure of the plant dynamics, the reference model's output behavior should be asymptotically achievable by the adaptive control system implying certain extra conditions on the relative degree of the reference model and persistent excitation conditions on the reference input. The controller structure is dictated by the certainty equivalence

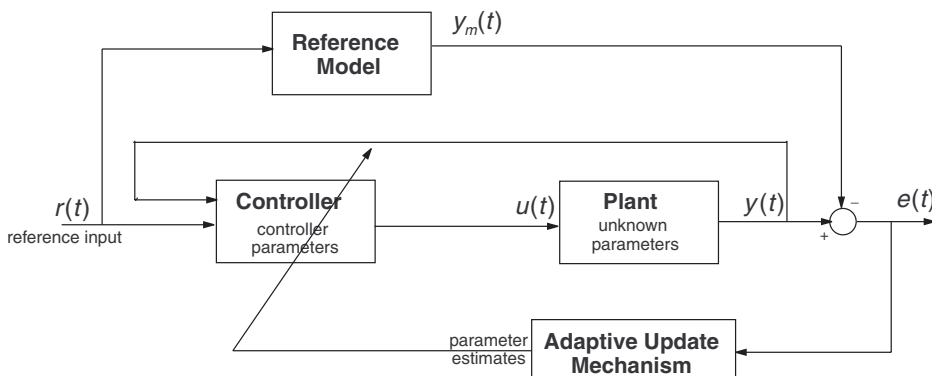

FIGURE 31.1 The model reference adaptive control framework.

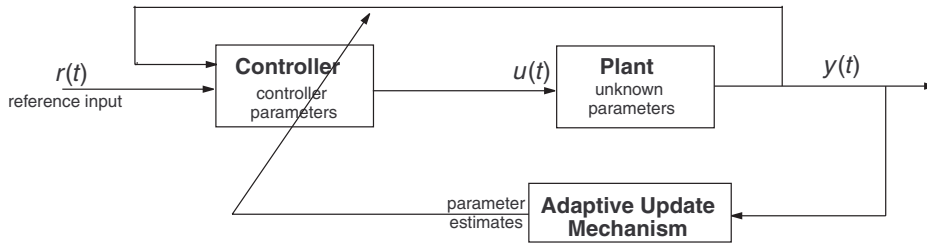

FIGURE 31.2 The self-tuning control architecture.

principle and both direct and indirect parameter update procedures can be adopted within the MRAC framework. Much of the work in this area deals with continuous time systems.

Self-Tuning Controller (STC)

In contrast to MRAC, there is no reference model in the STC design. A schematic sketch is shown in Fig. 31.2. In this formulation, the controller parameters of the plant parameters are estimated in real time, depending on whether it is a direct or indirect approach. These estimates are then used as if they are equal to the true parameters (certainty equivalence design). Parameter estimation involves finding the *best-fit* set of parameters based on the plant input–output data. This is different from the MRAC parameter adaptation scheme, where the parameter estimates are updated in such a way to achieve asymptotic tracking between the tracking error between the plant and the reference model. In several STC estimation schemes, it is also possible to quantify a measure of the quality of the parameter estimates, which can be used in the design of the controller. Many different combinations of the estimation methods can be adopted and can be applied to both continuous time and discrete time plants. Due to the “separation” between parameter estimation and control in STC, there is greater flexibility in design. However, stability and convergence are difficult to prove and stronger conditions on input signals are required (persistent excitation) to guarantee parameter convergence. Historically speaking, STC designs arose in the study of the stochastic regulation problem and much of the literature is devoted to discrete time plants using an indirect approach. In spite of the seeming difference between MRAC and STC, a direct correspondence exists between problems from both the areas.⁸

31.5 Nonlinear Adaptive Control Systems

For the most general case of nonlinear systems, there exists very limited theory in the field of adaptive control. Even though there is great interest in this area due to potential applications in a wide variety of complex mechanical systems, theoretical difficulties exist because of the lack of general analysis tools. However, some important special cases are well understood by now, and we summarize the conditions that these classes of systems satisfy:

1. The unknown parameters within the nonlinear plant are linearly parameterized.
2. The complete state vector is measured.
3. When the unknown parameters are assumed known, the control input can cancel all the nonlinearities in a feedback-linearization sense and any remaining internal dynamics should be stable. The adaptive design is then accomplished by certainty equivalence.

We now show a typical nonlinear MRAC methodology to deal with a situation in which the nonlinear plant model has unknown parameters. Consider the nonlinear system

$$\dot{x} = \theta f(x) + u \tag{31.5}$$

where θ is a constant and unknown matrix parameter, and \mathbf{f} is a known and differentiable nonlinear vector function. In analogy with the MRAC methodology, we assume that it is desired to have the state \mathbf{x} asymptotically track the state \mathbf{x}_m of a reference system that satisfies

$$\dot{\mathbf{x}}_m = A_m \mathbf{x}_m + \mathbf{r} \quad (31.6)$$

where $\mathbf{r}(t)$ is any piecewise continuous and bounded reference input and A_m is a Hurwitz matrix. Introduce an error vector $\mathbf{e} = \mathbf{x} - \mathbf{x}_m$ so that the error dynamics can be established by taking the difference between Eqs. (31.5) and (31.6) as follows:

$$\dot{\mathbf{e}} = \theta \mathbf{f}(\mathbf{x}) - A_m \mathbf{x}_m - \mathbf{r} + \mathbf{u} \quad (31.7)$$

If the parameter θ is assumed to be known, selecting the control input $\mathbf{u} = A_m \mathbf{x} + \mathbf{r} - \theta \mathbf{f}(\mathbf{x})$ would render the following structure for the error dynamics:

$$\dot{\mathbf{e}} = A_m \mathbf{e}$$

which would achieve the control objective. However, such a choice of control law is not impossible because θ is unknown. Hence we retain the same structure for the control law except for replacing θ by its time-varying estimate $\hat{\theta}$ so that the certainty-equivalence-based adaptive control law is given by

$$\mathbf{u} = A_m \mathbf{x} + \mathbf{r} - \hat{\theta} \mathbf{f}(\mathbf{x}) \quad (31.8)$$

Application of the control law in Eq. (31.7) leads us to the following closed-loop error dynamics:

$$\dot{\mathbf{e}} = A_m \mathbf{e} - \tilde{\theta} \mathbf{f}(\mathbf{x}) \quad (31.9)$$

where we have introduced the variable $\tilde{\theta}(t)$ to represent the parameter estimation error $\hat{\theta}(t) - \theta$. There are two things remaining to be done: (i) to show the stability and asymptotic convergence of $\mathbf{e}(t)$ to zero as $t \rightarrow \infty$, (ii) to provide an appropriate parameter adaptation mechanism for $\hat{\theta}(t)$. We accomplish both these tasks by adopting the Lyapunov method. Given that A_m is Hurwitz, for any choice of symmetric and positive definite matrix Q , there exists a symmetric, positive definite matrix P that satisfies the Lyapunov equation given in Eq. (31.3). Choosing a Lyapunov function in terms of such a P matrix,

$$V = \mathbf{e}^T P \mathbf{e} + \text{tr}[\tilde{\theta}^T \Gamma^{-1} \tilde{\theta}] \quad (31.10)$$

where Γ is a symmetric positive definite learning rate matrix. Taking the time derivative of V along the solutions of Eq. (31.9) we find that

$$\dot{V} = \mathbf{e}^T (P A_m + A_m^T P) \mathbf{e} - 2 \mathbf{e}^T P \tilde{\theta} \mathbf{f}(\mathbf{x}) + 2 \text{tr}[\tilde{\theta}^T \Gamma^{-1} \dot{\tilde{\theta}}] \quad (31.11)$$

Using several matrix trace identities,⁹ it is possible to show that

$$\mathbf{e}^T P \tilde{\theta} \mathbf{f}(\mathbf{x}) = \text{tr}[P \tilde{\theta} \mathbf{f}(\mathbf{x}) \mathbf{e}^T] = \text{tr}[\tilde{\theta} \mathbf{f}(\mathbf{x}) \mathbf{e}^T P] = \text{tr}[\tilde{\theta}^T P \mathbf{e} \mathbf{f}^T(\mathbf{x})]$$

so that we can combine the last two terms on the right-hand side of Eq. (31.11) as follows:

$$\dot{V} = \mathbf{e}^T \underbrace{(P A_m + A_m^T P)}_{-Q} \mathbf{e} + 2 \text{tr}[\tilde{\theta}^T \{\Gamma^{-1} \dot{\tilde{\theta}} - P \mathbf{e} \mathbf{f}^T(\mathbf{x})\}] \quad (31.12)$$

Since θ is constant, $\dot{\theta} = 0$ and $\dot{\hat{\theta}} = \dot{\theta}$. Thus, if the adaptive law for updating $\hat{\theta}$ is chosen as

$$\dot{\hat{\theta}} = \Gamma P e f^T(x) \quad (31.13)$$

then the derivative of the Lyapunov function in Eq. (31.12) becomes

$$\dot{V} = -e^T Q e \quad (31.14)$$

which is negative semidefinite, but not negative definite. This implies that $V(t) \leq V(0)$ for all $t \geq 0$, and thus, e and $\hat{\theta}$ must be bounded. This further implies that $x = e + x_m$ also is bounded. Also, $V \geq 0$ and $\dot{V} \leq 0$, which means $\lim_{t \rightarrow \infty} V(t) \doteq V_\infty$ exists and is finite. Now,

$$\int_0^\infty \dot{V}(\tau) d\tau = -\int_0^\infty e^T(\tau) Q e(\tau) d\tau = V_\infty - V(0)$$

implying that $e \in \mathcal{L}_2 \cap \mathcal{L}_\infty$. From Eq. (31.9), it is obvious that $\dot{e} \in \mathcal{L}_\infty$. Thus, we can invoke Barbalat's lemma to claim that $e(t) \rightarrow 0$ as $t \rightarrow \infty$. Notice, however, that the parameter error $\tilde{\theta} = \hat{\theta} - \theta$ will not necessarily converge to zero. True parameter convergence can occur only when the reference input $r(t)$ satisfies certain uniform observability and persistent excitation conditions⁴.

Remark: Note in the above MRAC design that while stability and tracking error convergence are guaranteed for any value of A_m , Q , and Γ , the performance of the controller will depend critically on the learning rate Γ . "Smaller" learning rates mean that the adaptation will be slow leading to large tracking errors and large transients. Conversely, the upper limit on the learning rate is limited by the presence of unmodeled dynamics, because too large a value for the learning rate will lead to highly oscillatory parameter estimates that can adversely excite the high frequency unmodeled plant dynamics.

Remark: The controller design methodology is based upon three crucial steps: (i) finding the appropriate controller structure in the spirit of feedback linearization, (ii) derivation of the tracking error dynamics that depend upon the parameter error terms, and (iii) finding a suitable Lyapunov function that can be used to derive the parameter update law such that the tracking error will go to zero. Determining the controller structure for the known parameter case is probably the most crucial step within any adaptive design because it turns out that adaptive feedback linearization cannot be always applied to systems that are linearizable by feedback in the known parameter case. This happens because higher derivatives of the parameter estimates appear in the control law for systems of higher order, making difficult the application of the certainty equivalence principle. Other relatively new approaches deviate from the conventional certainty equivalence principles by adopting integrator backstepping, nonlinear damping, and tuning functions.¹⁰ In these methods, the adaptive law estimates the unknown plant parameters directly, thereby permitting full utilization of any prior knowledge and therefore eliminating the possibility for overparameterization introduced by traditional direct MRAC methods. The design methodology and stability proof are obtained through a recursive process,^{10,11} an overview for which can be obtained from Kokotovic¹² and subsequent results by his research group.

Remark: Given the fact that there always exist model errors and other unknown disturbance effects in addition to the unknown parameters, adaptive control solutions would have to address the robustness question. Since the parameter error is always unknown, the Lyapunov function time derivative is always negative semidefinite. This implies that the closed-loop equations are not exponentially stable, nor even uniformly asymptotically stable. Any external or unmodeled disturbance would immediately make \dot{V} indefinite, and most methods that modify the stability proof for robustness are fixed to ensure \dot{V} to be negative outside a compact neighborhood of the equilibrium state. By introducing an additional term in the adaptive law Eq. (31.13), (referred to as σ -modification), Ioannou⁷ accomplishes robust stability. This method, though very popular, suffered from the drawback that when the disturbance is absent, the tracking error would not converge to zero. To overcome this problem, other schemes such as the ϵ -modification⁶ have been suggested to ensure robustness within the adaptive designs.

31.6 Spacecraft Adaptive Attitude Regulation Example

Consider the problem of a rigid spacecraft with an initial nonzero attitude and body angular velocity vector that has to be brought to rest at a zero attitude vector. This rigid body adaptive attitude regulation problem based on the feedback linearization approach has been derived by Schaub, Akella, and Junkins.¹³ The governing equations are described by Euler's rotational equations of motion and the desired linear closed-loop dynamics (LCLD) can be of either PD or PID form.^{13, 14} Only a crude estimate of the moment of inertia matrix is assumed to be known. An adaptive control law is presented, which includes an integral feedback term in the desired closed-loop dynamics and achieves asymptotic stability even in the presence of unmodeled external disturbances.

The resulting simulation is illustrated in Fig. 31.3. The attitude vector is specified in terms of the modified Rodrigues parameter (MRP) whose components σ_i are shown in Fig. 31.3(a). Without any adaptation, the open-loop control is still asymptotically stable. However, the transient attitude errors don't match those of the desired LCLD well at all. With adaptation turned on, the performance matches that of the ideal LCLD very closely.

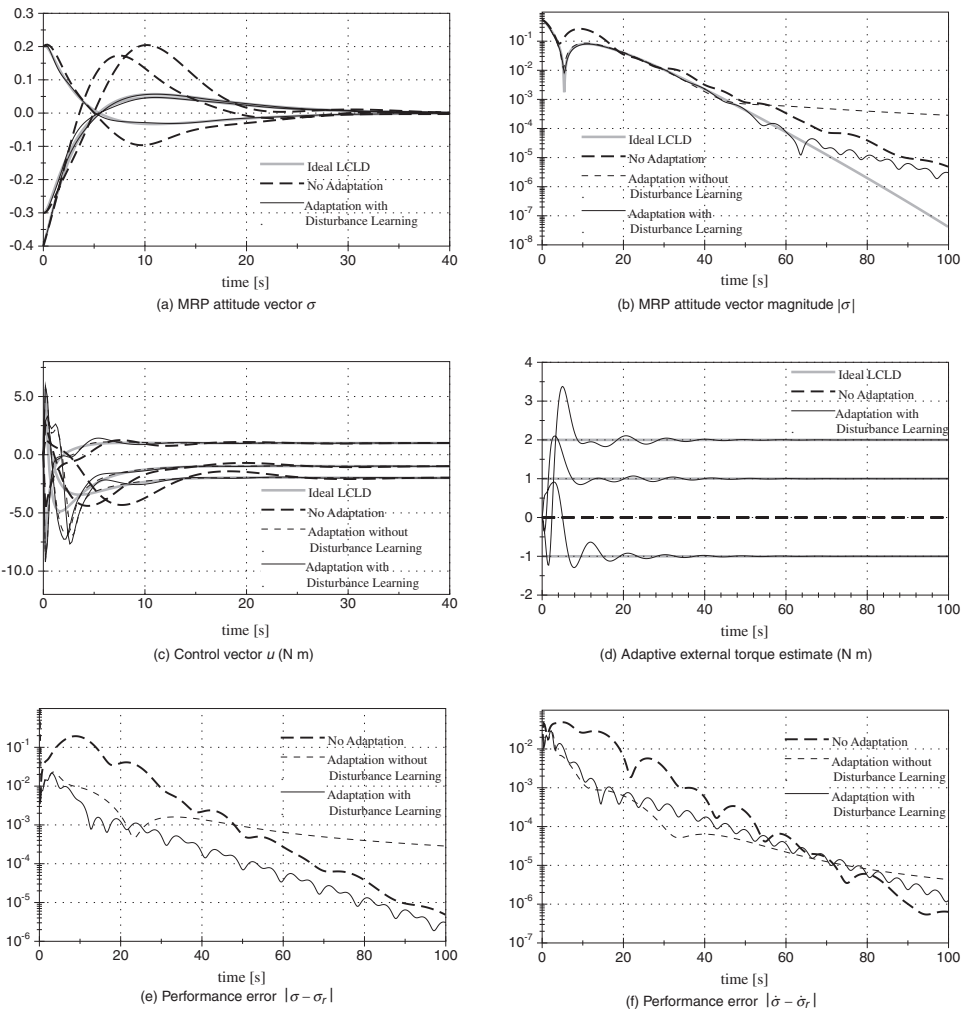

FIGURE 31.3 Rigid body stabilization while enforcing LCLD in the presence of large inertia and external disturbance ignorance.

Figure 31.3(b) shows the magnitude of the MRP attitude error vector σ on a logarithmic scale. Again the large transient errors of the open-loop, adaptation-free control law are visible during the first 20 s of the maneuver along with the good final convergence characteristics. The ideal LCLD performance is indicated again through the dotted line. Two versions of the adaptive control law are compared here, which differ only by whether or not the external disturbance is adaptively estimated too. On this figure both adaptive laws appear to enforce the desired LCLD very well for the first 40 s of the maneuver. After this the adaptive law without disturbance learning starts to decay at a slower rate, slower even than the open-loop (nonadaptive) solution. Including the external disturbance, adaptation clearly improves the final convergence rate. Note, however, that neither adaptive case starts to deviate from the ideal LCLD case until the MRP attitude error magnitude has decayed to roughly 10^{-3} . This corresponds to having a principal rotation error of roughly 0.23° . With external disturbance adaptation, the tracking error at which the LCLD deviations appear is about two orders of magnitude smaller.

The performance of the adaptive control law can be greatly varied by choosing different learning rates. However, since *large* initial inertia matrix and external disturbance model errors are present, the adaptive learning rates were reduced to avoid radical transient torques. The control torque vector components u_i for various cases are shown in Fig. 31.3(c). The open-loop torques don't approach the ideal LCLD torque during the transient part of the maneuver. The torques required by either adaptive case are very similar. The difference is that the case with external disturbance learning is causing some extra oscillation of the control about the LCLD case. However, note that with the chosen adaptive learning rates neither control law exhibits any radical transient torques about the ideal LCLD torque profile. Figure 31.3(d) illustrates that the adaptive external disturbance estimate F_e indeed asymptotically approaches the true external disturbance F_e^* . By reducing the external disturbance adaptive learning rate γ_{F_e} the transient adaptive estimate errors are kept within a reasonable range.

Figure 31.3(f) shows the absolute performance error in attitude rates. Both cases with adaptation added show large reductions in attitude rate errors compared to the nonadaptive case.

The purpose of the adaptive control discussed in this example is to enforce the desired LCLD. The previous figures illustrate that the resulting overall system remains asymptotically stable. Figure 31.3(e) illustrates the absolute performance error between the actual motion $\sigma(t)$ and the desired linear reference motion $\sigma_d(t)$. This figure demonstrates again the large performance error that results from using the open-loop control law with the incorrect system model. Adding adaptation improves the transient performance tracking by up to two orders of magnitude. Without including the external disturbance learning, the final performance error decay rate flattens out. This error will decay to zero. However, with the given learning gains, it does so at a slower rate than if no adaptation is taking place. Adding the external disturbance learning greatly improves the final performance error decay since the system is obtaining an accurate model of the actual constant disturbance. If the initial model estimates were more accurate, more aggressive adaptive learning rates could be used, resulting in even better LCLD performance tracking. This simulation illustrates though that even in the presence of large system uncertainty it is possible to track the desired LCLD very well.

31.7 Output Feedback Adaptive Control

In contrast to the state-space approaches, the input–output approach treats the plant as a black box that transforms the applied inputs into the corresponding output space. Stability theory for nonlinear systems from an input–output viewpoint is important in the context of adaptive output feedback control design. Solution to the problem of adaptive observer design involving state estimation of systems with unknown parameters is often the stepping stone towards resolving the output feedback control problem. There has been fairly recent breakthroughs in this area where the nonlinear adaptive observer design procedure has been extended to a slightly more general case of systems where the coefficients of the unknown parameters can depend on the entire state, and not just on the measured part.¹⁵

To a large extent, some powerful results have been made possible by exploiting certain “passivity-like” conditions coupled with the usual persistent excitation conditions. Crucial to this discussion is the

concept of passivity, which is really an abstract representation of the idea of energy dissipation in both linear and nonlinear systems. Passive systems are most common in mechanical and electrical engineering applications. A mechanical system consisting of masses, springs, and viscous dashpots is a common example for a passive system. We now give the following definitions.

Definition: Truncation of a signal

Let Y be the space of real-valued functions defined on $[0, \infty)$. Let \mathbf{x} be an element of Y . Then the *truncation* of \mathbf{x} at some $T > 0$ is defined by

$$\mathbf{x}_T(t) = \begin{cases} \mathbf{x}(t) & \text{for } 0 \leq t \leq T \\ 0 & \text{for } t > T \end{cases}$$

Definition: Extended space

If X is a normed linear subspace of Y , then the *extended space* X_e is defined by the set

$$\{\mathbf{x} \in Y : \mathbf{x}_T \in X \text{ for some fixed } T \geq 0\}$$

The extended \mathcal{L}_2 space is denoted by \mathcal{L}_{2e} .

Definition: Scalar product between two signals

The scalar product between two real-valued time signals $\mathbf{x}, \mathbf{y} \in \mathcal{L}_{2e}$ is defined as

$$\langle \mathbf{x} | \mathbf{y} \rangle = \int_0^\infty \mathbf{x}^T(\tau)\mathbf{y}(\tau) d\tau = \int_0^T \mathbf{x}^T(\tau)\mathbf{y}(\tau) d\tau$$

Definition: Passive systems

A system with input $\mathbf{u}(t)$ and output $\mathbf{y}(t)$ is *passive* if

$$\langle \mathbf{y} | \mathbf{u} \rangle \geq 0$$

The system is *input strictly passive* if $\exists \epsilon > 0$ such that

$$\langle \mathbf{y} | \mathbf{u} \rangle \geq \epsilon \|\mathbf{u}\|^2$$

The system is said to be *output strictly passive* if $\exists \epsilon > 0$ such that

$$\langle \mathbf{y} | \mathbf{u} \rangle \geq \epsilon \|\mathbf{y}\|^2$$

31.8 Adaptive Observers and Output Feedback Control

We now state the nonlinear adaptive observer problem formulated by Besançon¹⁵:

$$\begin{aligned} \dot{\mathbf{x}} &= \mathbf{f}(\mathbf{x}, \mathbf{u}, t) + \mathbf{g}(\mathbf{x}, \mathbf{u}, t)\theta \\ \mathbf{y} &= \mathbf{h}(\mathbf{x}) \end{aligned} \tag{31.15}$$

where functions \mathbf{f} and \mathbf{g} are C^∞ with respect to all their arguments and θ is a constant and unknown parameter. Variables \mathbf{x} , \mathbf{u} , and \mathbf{y} respectively denote the state, input, and output vectors. The input signals may be assumed to belong to some set of measurable and bounded functions. By the phrase adaptive observer, we imply the problem of reconstructing a state estimate $\hat{\mathbf{x}}(t)$ using the input \mathbf{u} and output \mathbf{y} in the presence of the unknown parameter θ such that $\lim_{t \rightarrow \infty} \|\hat{\mathbf{x}}(t) - \mathbf{x}(t)\| = 0$. The conditions for the

existence of such an observer are now available,¹⁵ which can be stated as follows. If a corresponding observer exists in the case when θ is known, and if this deterministic case observer is such that when a parameter error $\tilde{\theta} \doteq \hat{\theta} - \theta$ is made and the state estimation error system is passive between the “input” $\tilde{\theta}$ and the output error $h(\hat{x}) - y$, then an asymptotic state observer can be designed even when θ is unknown. In addition to this passivity requirement, parameter error convergence, as usual, would further need persistence of excitation with respect to u .

This powerful result finds immediate applications within the problem of spacecraft attitude tracking in the absence of angular velocity measurements.¹⁶ It is now well known that the governing equations of the rigid-body attitude control problem in terms of the MRP vector satisfy certain passivity conditions^{17, 18} between the angular velocity vector and the MRP vector. A very important consequence of passivity in this context is the fact that feedback control laws for attitude control can be implemented in a Lyapunov-based construction without requiring angular velocity measurements. In such a case, the only signal needed for feedback purposes would be the attitude vector. The resulting control laws provide *almost* global asymptotic stability in the sense of Tsiotras.¹⁸

31.9 Concluding Remarks

Historically speaking, the development and application of modern adaptive control theory for generic nonlinear systems adopted the philosophical approach of extending existing linear system methodologies. In some limited cases such as regulator theory, this approach of paralleling linear system methods has been highly successful. However, obtaining the same degree of success has been elusive in other research areas such as trajectory tracking, controller synthesis, and state reconstruction.

It is not difficult to fathom the reason for this bottleneck. Nonlinear systems occur in a vast variety of ways, and not all of them can be handled by simple extensions to existing linear adaptive control methodologies. One promising approach for the purpose of future research would be to specialize the study to mechanical systems, thereby restricting the class of nonlinear systems considered, and thus enabling the introduction of “structure” and additional constraints. Whereas in the case of output feedback control for general nonlinear systems, separate designs of stable observers and controllers do not necessarily guarantee stability for their combination (no separation principle), some structured approaches utilizing state transformations have already been shown to help recover the separation properties in some cases.¹⁵ As a result, these so-called structured approaches also enabled the formulation of global and semi-global tracking controllers based on output (partial state) feedback. It is quite possible that a focused pursuit of the same approach has the potential for providing a key to solving several other problems arising out of electromechanical systems that are otherwise intractable.

References

1. Narendra, K. S., “Parameter adaptive control—The End ... or The Beginning?,” *Proceedings of the 33rd Conference on Decision and Control*. Lake Buena Vista, Florida, December 1994.
2. Slotine, J. E. and Li, W., *Applied Nonlinear Control*. Prentice-Hall, Englewood Cliffs, NJ, 1991.
3. Khalil, H. K., *Nonlinear Systems*. Macmillan, New York, NY, 1992.
4. Sastry, S. and Bodson, M., *Adaptive Control: Stability, Convergence and Robustness*. Prentice-Hall, 1989.
5. Tao, G., “A simple alternative proof to the Barbalat Lemma,” *IEEE Transactions on Automatic Control*, Vol. 42, No. 5, May 1997, p. 698.
6. Narendra, K. S. and Annaswamy, A. M., *Stable Adaptive Systems*. Prentice-Hall, 1989.
7. Ioannou, P. A. and Sun, J., *Stable and Robust Adaptive Control*. Prentice-Hall, Upper Saddle River, NJ, 1995, pp. 85–134.
8. Astrom, K. J. and Wittenmark, B., *Adaptive Control*. Addison-Wesley, Reading, MA, 1995.
9. Gantmacher. *The Theory of Matrices*, Vol I. Chelsea Publishing Company, NY, 1977, pp. 353–354.
10. Krstić, M., Kanellakopoulos, I., and Kokotović, P. V., “Transient performance improvement with a new class of adaptive controllers,” *Systems & Control Letters*, Vol. 21, 1993, pp. 451–461.

11. Krtić, M., Kanellakopoulos, I., and Kokotović, P. V., "Nonlinear design of adaptive controllers for linear systems," *IEEE Transactions on Automatic Control*, Vol. 39, 1994, pp. 738–752.
12. Kokotovic, P. V., "The joy of feedback: nonlinear and adaptive control," *IEEE Control Systems Magazine*, Vol. 12, No. 3, 1992, pp. 7–17.
13. Schaub, H., Akella, M. R., and Junkins, J. L., "Adaptive control of nonlinear attitude motions realizing linear closed loop dynamics," *Journal of Guidance, Control and Dynamics*, Vol. 24, No. 1, Jan.–Feb. 2001.
14. Akella, M. R., Schaub, H., and Junkins, J. L., "Adaptive realization of linear closed loop tracking dynamics in the presence of large system model errors," *Journal of Astronautical Sciences*, Vol. 48, No. 4, 2000.
15. Besançon, G., "Global output feedback tracking control for a class of Lagrangian systems," *Automatica*, Vol. 36, 2000, pp. 1915–1921.
16. Akella, M. R., "Rigid body attitude tracking without angular velocity feedback," *Systems & Control Letters*, Vol. 42, No. 4, 2001.
17. Lizarralde, F. and Wen, J. T., "Attitude control without angular velocity measurement: a passivity approach," *IEEE Transactions on Automatic Control*, Vol. 41, No. 3, 1996, pp. 468–472.
18. Tsiotras, P., "Further passivity results for the attitude control problem," *IEEE Transactions on Automatic Control*, Vol. 43, No. 11, 1998, pp. 1597–1600.

32

Neural Networks and Fuzzy Systems

- 32.1 Neural Networks and Fuzzy Systems
- 32.2 Neuron Cell
- 32.3 Feedforward Neural Networks
- 32.4 Learning Algorithms for Neural Networks
 - Hebbian Learning Rule • Correlation Learning Rule • Instar Learning Rule • Winner Takes All (WTA) • Outstar Learning Rule • Widrow–Hoff LMS Learning Rule • Linear Regression • Delta Learning Rule • Error Backpropagation Learning
- 32.5 Special Feedforward Networks
 - Functional Link Network • Feedforward Version of the Counterpropagation Network • WTA Architecture • Cascade Correlation Architecture • Radial Basis Function Networks
- 32.6 Recurrent Neural Networks
 - Hopfield Network • Autoassociative Memory • Bidirectional Associative Memories (BAM)
- 32.7 Fuzzy Systems
 - Fuzzification • Rule Evaluation • Defuzzification • Design Example
- 32.8 Genetic Algorithms
 - Coding and Initialization • Selection and Reproduction • Reproduction • Mutation

Bogdan M. Wilamowski
University of Wyoming

32.1 Neural Networks and Fuzzy Systems

New and better electronic devices have inspired researchers to build intelligent machines operating in a fashion similar to the human nervous system. Fascination with this goal started when McCulloch and Pitts (1943) developed their model of an elementary computing neuron and when Hebb (1949) introduced his *learning rules*. A decade later Rosenblatt (1958) introduced the **perceptron** concept. In the early 1960s Widrow and Holf (1960, 1962) developed intelligent systems such as ADALINE and MADALINE. Nillson (1965) in his book *Learning Machines* summarized many developments of that time. The publication of the Mynsky and Paper (1969) book, with some discouraging results, stopped for some time the fascination with artificial neural networks, and achievements in the mathematical foundation of the **back-propagation** algorithm by Werbos (1974) went unnoticed. The current rapid growth in the area of neural networks started with the Hopfield (1982, 1984) recurrent network, Kohonen (1982) unsupervised training algorithms, and a description of the backpropagation algorithm by Rumelhart et al. (1986).

32.2 Neuron Cell

A biological neuron is a complicated structure, which receives trains of pulses on hundreds of *excitatory* and *inhibitory* inputs. Those incoming pulses are summed with different weights (averaged) during the time period of *latent summation*. If the summed value is higher than a threshold, then the neuron itself is generating a pulse, which is sent to neighboring neurons. Because incoming pulses are summed with time, the neuron generates a pulse train with a higher frequency for higher positive excitation. In other words, if the value of the summed weighted inputs is higher, the neuron generates pulses more frequently. At the same time, each neuron is characterized by the nonexcitability for a certain time after the firing pulse. This so-called *refractory period* can be more accurately described as a phenomenon where after excitation the threshold value increases to a very high value and then decreases gradually with a certain time constant. The refractory period sets soft upper limits on the frequency of the output pulse train. In the biological neuron, information is sent in the form of frequency modulated pulse trains.

This description of neuron action leads to a very complex neuron model, which is not practical. McCulloch and Pitts (1943) show that even with a very simple neuron model, it is possible to build logic and memory circuits. Furthermore, these simple neurons with thresholds are usually more powerful than typical logic gates used in computers. The McCulloch–Pitts neuron model assumes that incoming and outgoing signals may have only binary values 0 and 1. If incoming signals summed through positive or negative weights have a value larger than threshold, then the neuron output is set to 1. Otherwise, it is set to 0.

$$T = \begin{cases} 1, & \text{if } net \geq T \\ 0, & \text{if } net < T \end{cases} \quad (32.1)$$

where T is the threshold and net value is the weighted sum of all incoming signals:

$$net = \sum_{i=1}^n w_i x_i \quad (32.2)$$

Examples of McCulloch–Pitts neurons realizing OR, AND, NOT, and MEMORY operations are shown in Fig. 32.1. Note that the structure of OR and AND gates can be identical. With the same structure, other logic functions can be realized, as Fig. 32.2 shows.

The perceptron model has a similar structure. Its input signals, the weights, and the thresholds could have any positive or negative values. Usually, instead of using variable threshold, one additional constant input with a negative or positive weight can be added to each neuron, as Fig. 32.3 shows. In this case, the

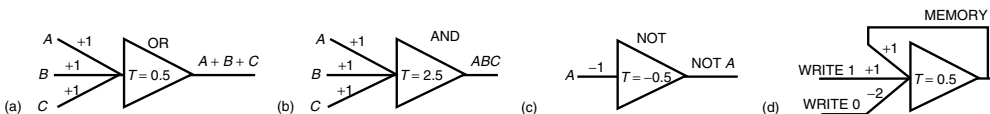

FIGURE 32.1 OR, AND, NOT, and MEMORY operations using networks with McCulloch–Pitts neuron model.

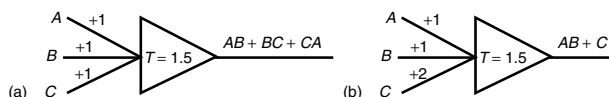

FIGURE 32.2 Other logic function realized with McCulloch–Pitts neuron model.

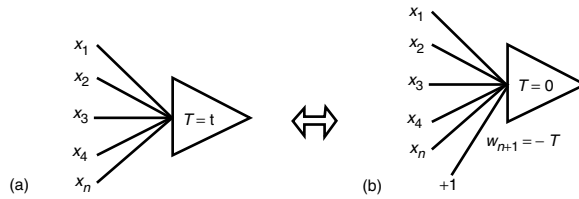

FIGURE 32.3 Threshold implementation with an additional weight and constant input with +1 value: (a) neuron with threshold T , (b) modified neuron with threshold $T=0$ and additional weight equal to $-T$.

threshold is always set to be zero and the net value is calculated as

$$net = \sum_{i=1}^n w_i x_i + w_{n+1} \quad (32.3)$$

where w_{n+1} has the same value as the required threshold and the opposite sign. Single-layer perceptrons were successfully used to solve many pattern classification problems. The hard threshold activation functions are given by

$$o = f(net) = \frac{\text{sgn}(net) + 1}{2} = \begin{cases} 1, & \text{if } net \geq 0 \\ 0, & \text{if } net < 0 \end{cases} \quad (32.4)$$

for **unipolar** neurons and

$$o = f(net) = \text{sgn}(net) = \begin{cases} 1, & \text{if } net \geq 0 \\ -1, & \text{if } net < 0 \end{cases} \quad (32.5)$$

for **bipolar** neurons. For these types of neurons, most of the known training algorithms are able to adjust weights only in single-layer networks.

Multilayer neural networks usually use continuous activation functions, either unipolar

$$o = f(net) = \frac{1}{1 + \exp(-\lambda net)} \quad (32.6)$$

or bipolar

$$o = f(net) = \tanh(0.5 \lambda net) = \frac{2}{1 + \exp(-\lambda net)} - 1 \quad (32.7)$$

These continuous activation functions allow for the gradient-based training of multilayer networks. Typical activation functions are shown in Fig. 32.4. In the case when neurons with additional threshold input are used (Fig. 32.3(b)), the λ parameter can be eliminated from Eqs. (32.6) and (32.7) and the steepness of the neuron response can be controlled by the weight scaling only. Therefore, there is no real need to use neurons with variable gains.

Note, that even neuron models with continuous activation functions are far from an actual biological neuron, which operates with frequency modulated pulse trains.

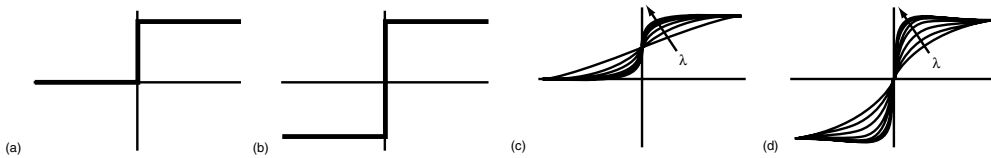

FIGURE 32.4 Typical activation functions: (a) hard threshold unipolar, (b) hard threshold bipolar, (c) continuous unipolar, (d) continuous bipolar.

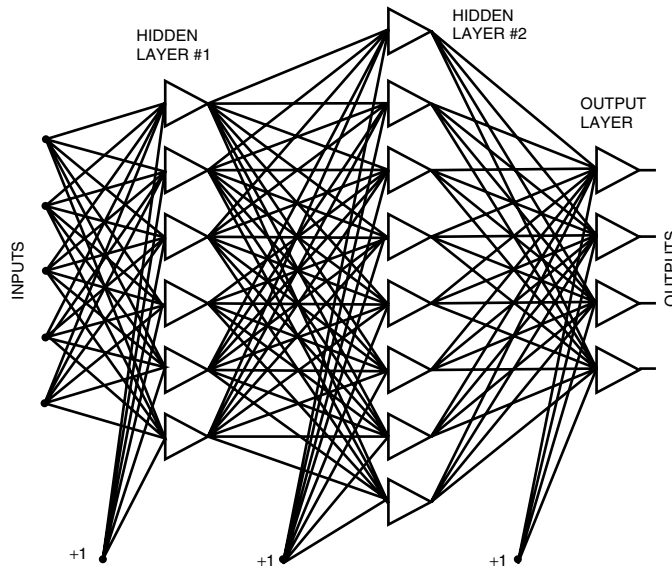

FIGURE 32.5 An example of the three-layer feedforward neural network, which is sometimes known also as the backpropagation network.

32.3 Feedforward Neural Networks

Feedforward neural networks allow only one-directional signal flow. Furthermore, most feedforward neural networks are organized in layers. An example of the three-layer feedforward neural network is shown in Fig. 32.5. This network consists of input nodes, two *hidden layers*, and an output layer.

A single neuron is capable of separating input patterns into two categories, and this separation is linear. For example, for the patterns shown in Fig. 32.6, the separation line is crossing x_1 and x_2 axes at points x_{10} and x_{20} . This separation can be achieved with a neuron having the following weights: $w_1 = 1/x_{10}$, $w_2 = 1/x_{20}$, and $w_3 = -1$. In general for n dimensions, the weights are

$$w_i = \frac{1}{x_{i0}} \quad \text{for } w_{n+1} = -1 \quad (32.8)$$

One neuron can divide only linearly separated patterns. To select just one region in n -dimensional input space, more than $n + 1$ neurons should be used. If more input clusters are to be selected, then the number of neurons in the input (hidden) layer should be properly multiplied. If the number of neurons in the input (hidden) layer is not limited, then all classification problems can be solved using the three-layer network. An example of such a neural network, classifying three clusters in the two-dimensional space, is shown in Fig. 32.7. Neurons in the first hidden layer create the separation lines between input clusters.

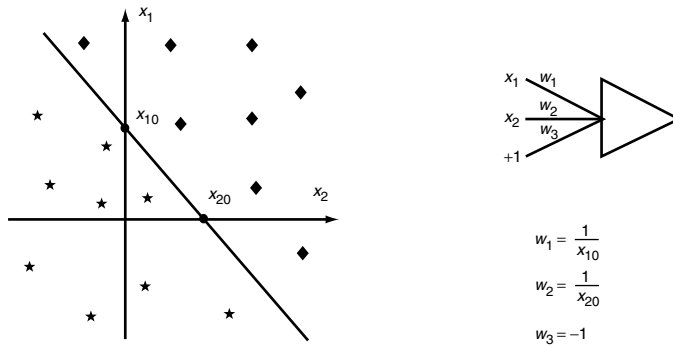

FIGURE 32.6 Illustration of the property of linear separation of patterns in the two-dimensional space by a single neuron.

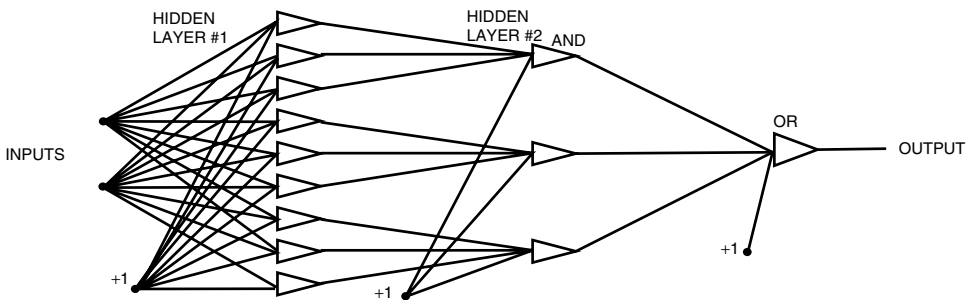

FIGURE 32.7 An example of the three-layer neural network with two inputs for classification of three different clusters into one category. This network can be generalized and can be used for solution of all classification problems.

Neurons in the second hidden layer perform the AND operation, as shown in Fig. 32.1(b). Output neurons perform the OR operation, as shown in Fig. 32.1(a), for each category. The linear separation property of neurons makes some problems especially difficult for neural networks, such as exclusive OR, parity computation for several bits, or to separate patterns laying on two neighboring spirals.

The feedforward neural network is also used for nonlinear transformation (mapping) of a multidimensional input variable into another multidimensional variable in the output. In theory, any input–output mapping should be possible if the neural network has enough neurons in hidden layers. (size of output layer is set by the number of outputs required). In practice, this is not an easy task. Presently, there is no satisfactory method to define how many neurons should be used in hidden layers. Usually, this is found by the trial-and-error method. In general, it is known that if more neurons are used, more complicated shapes can be mapped. On the other hand, networks with large numbers of neurons lose their ability for generalization, and it is more likely that such networks will also try to map noise supplied to the input.

32.4 Learning Algorithms for Neural Networks

Similarly to the biological neurons, the weights in artificial neurons are adjusted during a training procedure. Various learning algorithms were developed, and only a few are suitable for multilayer neuron networks. Some use only local signals in the neurons, others require information from outputs; some require a supervisor who knows what outputs should be for the given patterns, and other unsupervised algorithms need no such information. Common learning rules are described in the following sections.

Hebbian Learning Rule

The Hebb (1949) learning rule is based on the assumption that if two neighbor neurons must be activated and deactivated at the same time, then the weight connecting these neurons should increase. For neurons operating in the opposite phase, the weight between them should decrease. If there is no signal correlation, the weight should remain unchanged. This assumption can be described by the formula

$$\Delta w_{ij} = cx_i o_j \quad (32.9)$$

where

- w_{ij} = weight from i th to j th neuron,
- c = learning constant,
- x_i = signal on the i th input,
- o_j = output signal.

The training process starts usually with values of all weights set to zero. This learning rule can be used for both soft and hard threshold neurons. Since desired responses of neurons are not used in the learning procedure, this is the **unsupervised learning** rule. The absolute values of the weights are usually proportional to the learning time, which is undesired.

Correlation Learning Rule

The correlation learning rule is based on a similar principle as the Hebbian learning rule. It assumes that weights between simultaneously responding neurons should be largely positive, and weights between neurons with opposite reaction should be largely negative. Contrary to the Hebbian rule, the correlation rule is the **supervised learning**. Instead of actual response, o_j , the desired response, d_j , is used for the weight change calculation

$$\Delta w_{ij} = cx_i d_j \quad (32.10)$$

This training algorithm usually starts with initialization of weights to zero values.

Instar Learning Rule

If input vectors and weights are normalized, or they have only binary bipolar values (-1 or $+1$), then the *net* value will have the largest positive value when the weights and the input signals are the same. Therefore, weights should be changed only if they are different from the signals

$$\Delta w_i = c(x_i - w_i) \quad (32.11)$$

Note, that the information required for the weight is taken only from the input signals. This is a very local and unsupervised learning algorithm.

Winner Takes All (WTA)

The WTA is a modification of the instar algorithm where weights are modified only for the neuron with the highest *net* value. Weights of remaining neurons are left unchanged. Sometimes this algorithm is modified in such a way that a few neurons with the highest net values are modified at the same time. Although this is an unsupervised algorithm because we do not know what are desired outputs, there is a need for a “judge” or “supervisor” to find a winner with a largest net value. The WTA algorithm, developed by Kohonen (1982), is often used for automatic clustering and for extracting statistical properties of input data.

Outstar Learning Rule

In the outstar learning rule, it is required that weights connected to a certain node should be equal to the desired outputs for the neurons connected through those weights

$$\Delta w_{ij} = c(d_j - w_{ij}) \quad (32.12)$$

where d_j is the desired neuron output and c is the small learning constant, which further decreases during the learning procedure. This is the supervised training procedure because desired outputs must be known. Both instar and outstar learning rules were developed by Grossberg (1969).

Widrow–Hoff LMS Learning Rule

Widrow and Hoff (1960, 1962) developed a supervised training algorithm, which allows training a neuron for the desired response. This rule was derived so the square of the difference between the net and output value is minimized.

$$Error_j = \sum_{p=1}^P (net_{jp} - d_{jp})^2 \quad (32.13)$$

where

$Error_j$ = error for j th neuron,

P = number of applied patterns,

d_{jp} = desired output for j th neuron when p th pattern is applied,

net = given by Eq. (32.2).

This rule is also known as the least mean square (LMS) rule. By calculating a derivative of Eq. (32.13) with respect to w_{ij} , a formula for the weight change can be found:

$$\Delta w_{ij} = cx_i \sum_{p=1}^P (d_{jp} - net_{jp}) \quad (32.14)$$

Note that weight change Δw_{ij} is a sum of the changes from each of the individual applied patterns. Therefore, it is possible to correct the weight after each individual pattern was applied. This process is known as *incremental updating*; *cumulative updating* is when weights are changed after all patterns have been applied. Incremental updating usually leads to a solution faster, but it is sensitive to the order in which patterns are applied. If the learning constant c is chosen to be small, then both methods give the same result. The LMS rule works well for all types of activation functions. This rule tries to enforce the net value to be equal to desired value. Sometimes this is not what the observer is looking for. It is usually not important what the net value is, but it is important if the net value is positive or negative. For example, a very large net value with a proper sign will result in correct output and in large error as defined by Eq. (32.13) and this may be the preferred solution.

Linear Regression

The LMS learning rule requires hundreds or thousands of iterations, using formula (32.14), before it converges to the proper solution. Using the linear regression rule, the same result can be obtained in only one step.

Considering one neuron and using vector notation for a set of the input patterns \mathbf{X} applied through weight vector \mathbf{w} , the vector of net values \mathbf{net} is calculated using

$$\mathbf{X}\mathbf{w} = \mathbf{net} \quad (32.15)$$

where

- \mathbf{X} = rectangular array $(n + 1) \times p$,
- n = number of inputs,
- p = number of patterns.

Note that the size of the input patterns is always augmented by one, and this additional weight is responsible for the threshold (see Fig. 32.3(b)). This method, similar to the LMS rule, assumes a linear activation function, and so the *net* values \mathbf{net} should be equal to desired output values \mathbf{d}

$$\mathbf{X}\mathbf{w} = \mathbf{d} \tag{32.16}$$

Usually $p > n + 1$, and the preceding equation can be solved only in the least mean square error sense. Using the vector arithmetic, the solution is given by

$$\mathbf{w} = (\mathbf{X}^T\mathbf{X})^{-1}\mathbf{X}^T\mathbf{d} \tag{32.17}$$

When traditional method is used, the set of p equations with $n + 1$ unknowns, Eq. (32.16), has to be converted to the set of $n + 1$ equations with $n + 1$ unknowns

$$\mathbf{Y}\mathbf{w} = \mathbf{z} \tag{32.18}$$

where elements of the \mathbf{Y} matrix and the \mathbf{z} vector are given by

$$y_{ij} = \sum_{p=1}^P x_{ip}x_{jp}, \quad z_i = \sum_{p=1}^P x_{ip}d_p \tag{32.19}$$

Weights are given by Eq. (32.17) or they can be obtained by a solution of Eq. (32.18).

Delta Learning Rule

The LMS method assumes linear activation function $\mathbf{net} = \mathbf{o}$, and the obtained solution is sometimes far from optimum, as is shown in Fig. 32.8 for a simple two-dimensional case, with four patterns belonging to two categories. In the solution obtained using the LMS algorithm, one pattern is misclassified.

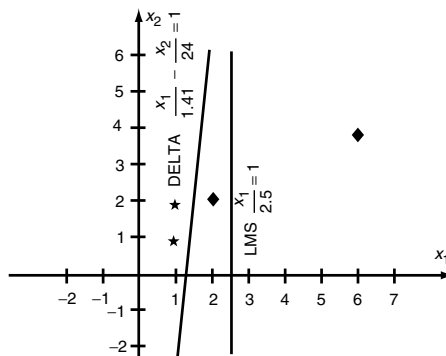

FIGURE 32.8 An example with a comparison of results obtained using LMS and delta training algorithms. Note that LMS is not able to find the proper solution.

is defined as

$$Error_j = \sum_{p=1}^P (o_{jp} - d_{jp})^2 \quad (32.20)$$

then the derivative of the error with respect to the weight w_{ij} is

$$\frac{d Error_j}{dw_{ij}} = 2 \sum_{p=1}^P (o_{jp} - d_{jp}) \frac{df(net_{jp})}{d net_{jp}} x_i \quad (32.21)$$

since $o = f(net)$ and the net is given by Eq. (32.2). Note that this derivative is proportional to the derivative of the activation function $f'(net)$. Thus, this type of approach is possible only for continuous activation functions and this method cannot be used with hard activation functions (32.4) and (32.5). In this respect the LMS method is more general. The derivatives' most common continuous activation functions are

$$f' = o(1 - o) \quad (32.22)$$

for the unipolar, Eq. (32.6), and

$$f' = 0.5(1 - o^2) \quad (32.23)$$

for the bipolar, Eq. (32.7).

Using the cumulative approach, the neuron weight w_{ij} should be changed with a direction of gradient

$$\Delta w_{ij} = cx_i \sum_{p=1}^P (d_{jp} - o_{jp}) f'_{jp} \quad (32.24)$$

In case of the incremental training for each applied pattern

$$\Delta w_{ij} = cx_i f'_j (d_j - o_j) \quad (32.25)$$

the weight change should be proportional to input signal x_i , to the difference between desired and actual outputs $d_{jp} - o_{jp}$, and to the derivative of the activation function f'_{jp} . Similar to the LMS rule, weights can be updated in both the incremental and the cumulative methods. In comparison to the LMS rule, the delta rule always leads to a solution close to the optimum. As it is illustrated in Fig. 32.8, when the delta rule is used, all four patterns are classified correctly.

Error Backpropagation Learning

The delta learning rule can be generalized for multilayer networks. Using an approach similar to the delta rule, the gradient of the global error can be computed with respect to each weight in the network. Interestingly,

$$\Delta w_{ij} = cx_i f'_j E_j \quad (32.26)$$

where

- c = learning constant,
- x_i = signal on the i th neuron input,
- f'_j = derivative of activation function.

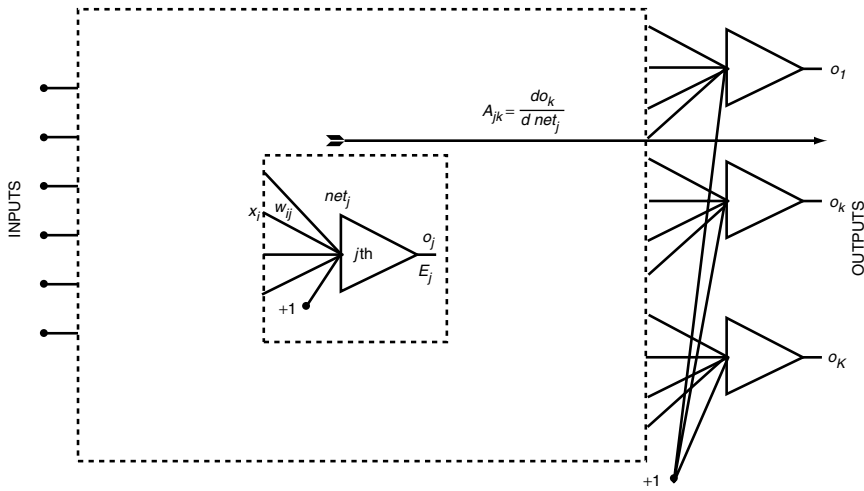

FIGURE 32.9 Illustration of the concept of gain computation in neural networks.

The cumulative error E_j on neuron output is given by

$$E_j = \frac{1}{f_j'} \sum_{k=1}^K (o_k - d_k) A_{jk} \quad (32.27)$$

where K is the number of network outputs and A_{jk} is the small signal gain from the input of the j th neuron to the k th network output, as Fig. 32.9 shows. The calculation of the backpropagating error starts at the output layer and cumulative errors are calculated layer by layer to the input layer. This approach is not practical from the point of view of hardware realization. Instead, it is simpler to find signal gains from the input of the j th neuron to each of the network outputs (Fig. 32.9). In this case, weights are corrected using

$$\Delta w_{ij} = c x_i \sum_{k=1}^K (o_k - d_k) A_{jk} \quad (32.28)$$

Note that this formula is general, regardless of whether the neurons are arranged in layers or not. One way to find gains A_{jk} is to introduce an incremental change on the input of the j th neuron and observe the change in the k th network output. This procedure requires only forward signal propagation, and it is easy to implement in a hardware realization. Another possible way is to calculate gains through each layer and then find the total gains as products of layer gains. This procedure is equally or less computationally intensive than a calculation of cumulative errors in the error backpropagation algorithm.

The backpropagation algorithm has a tendency for oscillation. To smooth the process, the weights increment Δw_{ij} can be modified according to Rumelhart, Hinton, and Williams (1986):

$$w_{ij}(n+1) = w_{ij}(n) + \Delta w_{ij}(n) + \alpha \Delta w_{ij}(n-1) \quad (32.29)$$

or according to Sejnowski and Rosenberg (1987),

$$w_{ij}(n+1) = w_{ij}(n) + (1 - \alpha) \Delta w_{ij}(n) + \alpha \Delta w_{ij}(n-1) \quad (32.30)$$

where α is the momentum term.

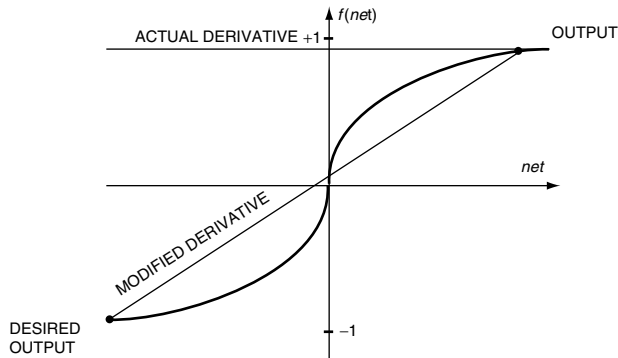

FIGURE 32.10 Illustration of the modified derivative calculation for faster convergence of the error backpropagation algorithm.

The backpropagation algorithm can be significantly sped up, when, after finding components of the gradient, weights are modified along the gradient direction until a minimum is reached. This process can be carried on without the necessity of a computationally intensive gradient calculation at each step. The new gradient components are calculated once a minimum is obtained in the direction of the previous gradient. This process is only possible for cumulative weight adjustment. One method of finding a minimum along the gradient direction is the *tree step process* of finding error for three points along gradient direction and then, using a parabola approximation, jump directly to the minimum. The fast learning algorithm using the described approach was proposed by Fahlman (1988) and is known as the *quickprop*.

The backpropagation algorithm has many disadvantages, which lead to very slow convergence. One of the most painful is that in the backpropagation algorithm, the learning process almost perishes for neurons responding with the maximally wrong answer. For example, if the value on the neuron output is close to +1 and desired output should be close to -1, then the neuron gain $f'(net) \approx 0$ and the error signal cannot backpropagate, and so the learning procedure is not effective. To overcome this difficulty, a modified method for derivative calculation was introduced by Wilamowski and Torvik (1993). The derivative is calculated as the slope of a line connecting the point of the output value with the point of the desired value, as shown in Fig. 32.10.

$$f_{\text{modif}} = \frac{o_{\text{desired}} - o_{\text{actual}}}{net_{\text{desired}} - net_{\text{actual}}} \quad (32.31)$$

Note that for small errors, Eq. (32.31) converges to the derivative of activation function at the point of the output value. With an increase of system dimensionality, the chances for local minima decrease. It is believed that the described phenomenon, rather than a trapping in local minima, is responsible for convergence problems in the error backpropagation algorithm.

32.5 Special Feedforward Networks

The multilayer backpropagation network, as shown in Fig. 32.5, is a commonly used feedforward network. This network consists of neurons with the sigmoid type continuous activation function presented in Figs. 32.4(c) and 32.4(d). In most cases, only the one hidden layer is required, and the number of neurons in the hidden layer are chosen to be proportional to the problem complexity. The number of neurons in the hidden layer is usually found by a trial-and-error process. The training process starts with all weights randomized to small values, and the error backpropagation algorithm is used to find a solution. When the learning process does not converge, the training is repeated with a new set of randomly chosen weights.

Nguyen and Widrow (1990) proposed an experimental approach for the two-layer network weight initialization. In the second layer, weights are randomly chosen in the range from -0.5 to $+0.5$. In the first layer, initial weights are calculated from

$$w_{ij} = \frac{\beta z_{ij}}{\|z_j\|}, \quad w_{(n+1)j} = \text{random}(-\beta, +\beta) \quad (32.32)$$

where z_{ij} is the random number from -0.5 to $+0.5$ and the scaling factor β is given by

$$\beta = 0.7P^{1/N} \quad (32.33)$$

where n is the number of inputs and N is the number of hidden neurons in the first layer. This type of weight initialization usually leads to faster solutions.

For adequate solutions with backpropagation networks, typically many tries are required with different network structures and different initial random weights. It is important that the trained network gains a generalization property. This means that the trained network also should be able to handle correctly patterns that were not used for training. Therefore, in the training procedure, often some data are removed from the training patterns and then these patterns are used for verification. The results with backpropagation networks often depend on luck. This encouraged researchers to develop feedforward networks, which can be more reliable. Some of those networks are described in the following sections.

Functional Link Network

One-layer neural networks are relatively easy to train, but these networks can solve only linearly separated problems. One possible solution for nonlinear problems was presented by Nilsson (1965) and was then elaborated by Pao (1989) using the functional link network shown in Fig. 32.11. Using nonlinear terms with initially determined functions, the actual number of inputs supplied to the one-layer neural network is increased. In the simplest case, nonlinear elements are higher order terms of input patterns. Note that the functional link network can be treated as a one-layer network, where additional input data are generated off-line using nonlinear transformations. The learning procedure for one-layer is easy and fast. Figure 32.12 shows an XOR problem solved using functional link networks. Note that when the functional link approach is used, this difficult problem becomes a trivial one. The problem with the functional link network is that proper selection of nonlinear elements is not an easy task. In many practical cases, however, it is not difficult to predict what kind of transformation of input data may linearize the problem, and so the functional link approach can be used.

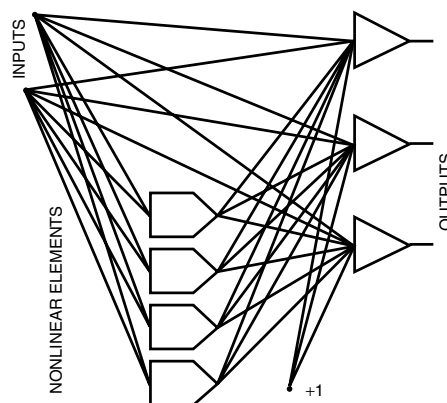

FIGURE 32.11 The functional link network.

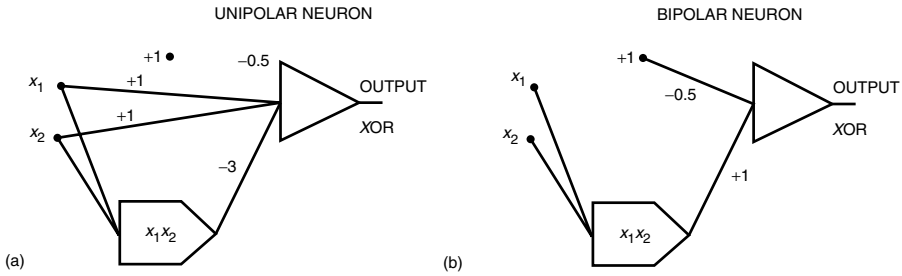

FIGURE 32.12 Functional link networks for solution of the XOR problem: (a) using unipolar signals, (b) using bipolar signals.

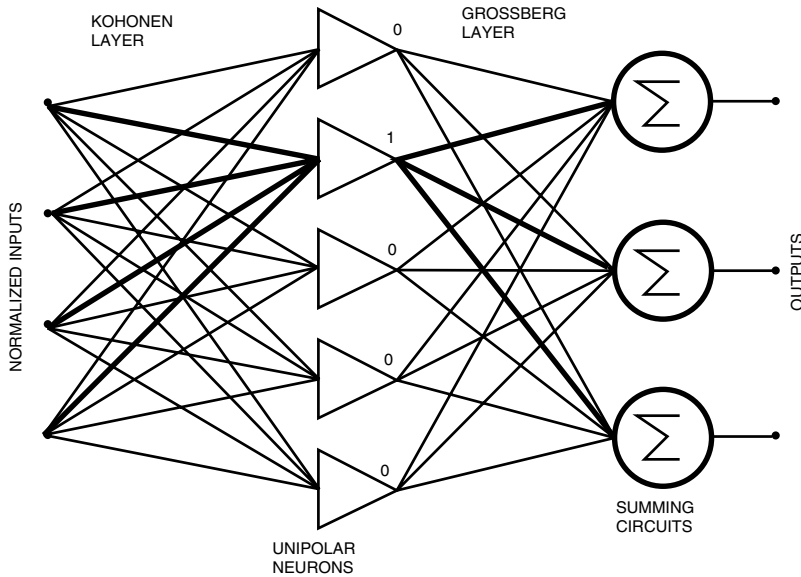

FIGURE 32.13 The counterpropagation network.

Feedforward Version of the Counterpropagation Network

The *counterpropagation network* was originally proposed by Hecht-Nilsen (1987). In this section a modified feedforward version as described by Zurada (1992) is discussed. This network, which is shown in Fig. 32.13, requires numbers of hidden neurons equal to the number of input patterns, or more exactly, to the number of input clusters. The first layer is known as the Kohonen layer with unipolar neurons. In this layer only one neuron, the winner, can be active. The second is the Grossberg outstar layer. The Kohonen layer can be trained in the unsupervised mode, but that need not be the case. When binary input patterns are considered, the input weights must be exactly equal to the input patterns. In this case,

$$net = \mathbf{x}^t \mathbf{w} = [n - 2HD(\mathbf{x}, \mathbf{w})] \quad (32.34)$$

where

- n = number of inputs,
- \mathbf{w} = weights,
- \mathbf{x} = input vector,

$HD(\mathbf{w}, \mathbf{x})$ = Hamming distance between input pattern and weights.

For a neuron in the input layer to be reacting just for the stored pattern, the threshold value for this neuron should be

$$w_{(n+1)} = -(n - 1) \quad (32.35)$$

If it is required that the neuron must also react for similar patterns, then the threshold should be set to $w_{n+1} = -[n - (1 + HD)]$, where HD is the Hamming distance defining the range of similarity. Since for a given input pattern only one neuron in the first layer may have the value of 1 and remaining neurons have 0 values, the weights in the output layer are equal to the required output pattern.

The network, with unipolar activation functions in the first layer, works as a lookup table. When the linear activation function (or no activation function at all) is used in the second layer, then the network also can be considered as an analog memory. For the address applied to the input as a binary vector, the stored set of analog values, as weights in the second layer, can be accurately recovered. The feedforward counterpropagation network may also use analog inputs, but in this case all input data should be normalized,

$$\mathbf{w}_i = \hat{\mathbf{x}}_i = \frac{\mathbf{x}_i}{\|\mathbf{x}_i\|} \quad (32.36)$$

The counterpropagation network is very easy to design. The number of neurons in the hidden layer is equal to the number of patterns (clusters). The weights in the input layer are equal to the input patterns, and the weights in the output layer are equal to the output patterns. This simple network can be used for rapid prototyping. The counterpropagation network usually has more hidden neurons than required. However, such an excessive number of hidden neurons are also used in more sophisticated feedforward networks such as the *probabilistic neural network* (PNN) Specht (1990) or the *general regression neural networks* (GRNN) Specht (1992).

WTA Architecture

The winner take all (WTA) network was proposed by Kohonen (1988). This is basically a one-layer network used in the unsupervised training algorithm to extract a statistical property of the input data, Fig. 32.14(a). At the first step, all input data are normalized so that the length of each input vector is the same and, usually, equal to unity, Eq. (32.36). The activation functions of neurons are unipolar and continuous. The learning process starts with a weight initialization to small random values. During the learning process the weights are changed only for the neuron with the highest value on the output—the winner:

$$\Delta \mathbf{w}_w = c(\mathbf{x} - \mathbf{w}_w) \quad (32.37)$$

where

\mathbf{w}_w = weights of the winning neuron,

\mathbf{x} = input vector,

c = learning constant.

Usually, this single-layer network is arranged into a two-dimensional layer shape, as shown in Fig. 32.14(b). The hexagonal shape is usually chosen to secure strong interaction between neurons. Also, the algorithm is modified in such a way that not only the winning neuron but also neighboring neurons are allowed for the weight change. At the same time, the learning constant c in Eq. (32.37) decreases with the distance from the winning neuron. After such an unsupervised training procedure, the Kohonen layer is able to organize data into clusters. Output of the Kohonen layer is then connected to the one- or two-layer feedforward network with the error backpropagation algorithm. This initial data organization in the WTA layer usually leads to rapid training of the following layer or layers.

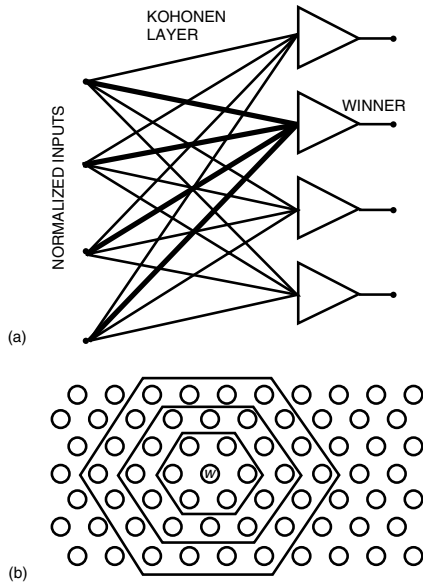

FIGURE 32.14 A winner take all architecture for cluster extracting in the unsupervised training mode: (a) network connections, (b) single-layer network arranged into a hexagonal shape.

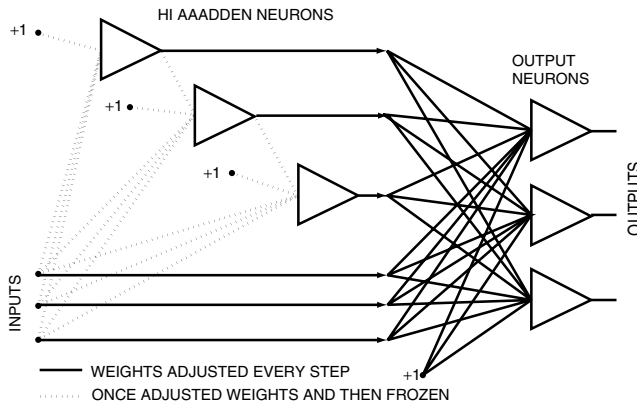

FIGURE 32.15 The cascade correlation architecture.

Cascade Correlation Architecture

The cascade correlation architecture was proposed by Fahlman and Lebiere (1990). The process of network building starts with a one-layer neural network and hidden neurons are added as needed. The network architecture is shown in Fig. 32.15. In each training step, a new hidden neuron is added and its weights are adjusted to maximize the magnitude of the correlation between the new hidden neuron output and the residual error signal on the network output to be eliminated. The correlation parameter S must be maximized:

$$S = \sum_{o=1}^O \left| \sum_{p=1}^P (V_p - \bar{V})(E_{po} - \bar{E}_o) \right| \quad (32.38)$$

where

- O = number of network outputs,
- P = number of training patterns,
- V_p = output on the new hidden neuron,
- E_{po} = error on the network output.

\bar{V} and \bar{E}_o are average values of V_p and E_{po} , respectively. By finding the gradient, $\delta S/\delta w_p$, the weight adjustment for the new neuron can be found as

$$\Delta w_i = \sum_{o=1}^O \sum_{p=1}^P \sigma_o (E_{po} - \bar{E}_o) f'_p x_{ip} \quad (32.39)$$

where

- σ_o = sign of the correlation between the new neuron output value and network output,
- f'_p = derivative of activation function for pattern p ,
- x_{ip} = input signal.

The output neurons are trained using the delta or quickprop algorithms. Each hidden neuron is trained just once and then its weights are frozen. The network learning and building process is completed when satisfactory results are obtained.

Radial Basis Function Networks

The structure of the radial basis network is shown in Fig. 32.16. This type of network usually has only one hidden layer with special neurons. Each of these neurons responds only to the inputs signals close to the stored pattern. The output signal h_i of the i th hidden neuron is computed using formula

$$h_i = \exp\left(-\frac{\|\mathbf{x} - \mathbf{s}_i\|^2}{2\sigma^2}\right) \quad (32.40)$$

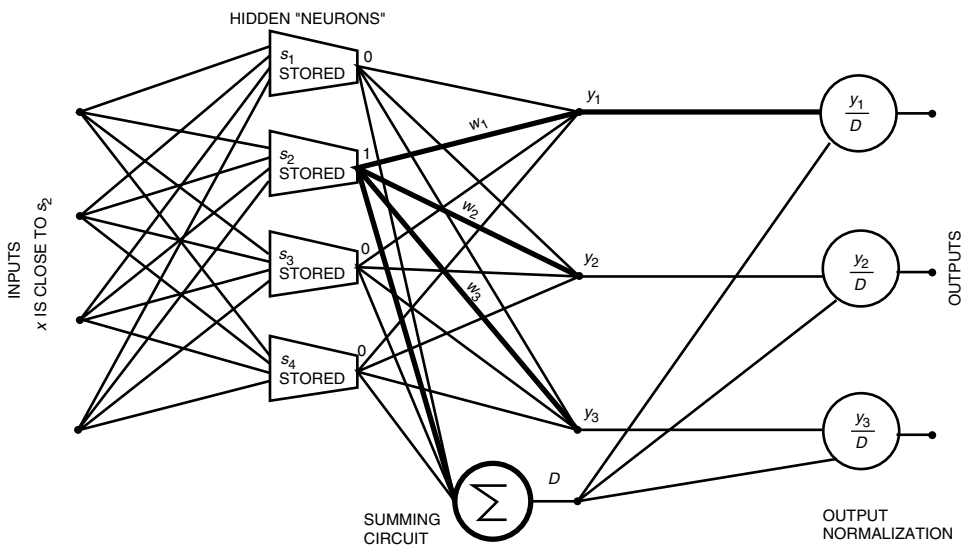

FIGURE 32.16 A typical structure of the radial basis function network.

where

- \mathbf{x} = input vector,
- \mathbf{s}_i = stored pattern representing the center of the i cluster,
- σ_i = radius of the cluster.

Note that the behavior of this “neuron” significantly differs from the biological neuron. In this “neuron,” excitation is not a function of the weighted sum of the input signals. Instead, the distance between the input and stored pattern is computed. If this distance is zero, the neuron responds with a maximum output magnitude equal to one. This neuron is capable of recognizing certain patterns and generating output signals that are functions of a similarity. Features of this neuron are much more powerful than a neuron used in the backpropagation networks. As a consequence, a network made of such neurons is also more powerful.

If the input signal is the same as a pattern stored in a neuron, then this neuron responds with 1 and remaining neurons have 0 on the output, as is illustrated in Fig. 32.16. Thus, output signals are exactly equal to the weights coming out from the active neuron. This way, if the number of neurons in the hidden layer is large, then any input–output mapping can be obtained. Unfortunately, it may also happen that for some patterns several neurons in the first layer will respond with a nonzero signal. For a proper approximation, the sum of all signals from the hidden layer should be equal to one. To meet this requirement, output signals are often normalized, as shown in Fig. 32.16.

The radial-based networks can be designed or trained. Training is usually carried out in two steps. In the first step, the hidden layer is usually trained in the unsupervised mode by choosing the best patterns for cluster representation. An approach similar to that used in the WTA architecture can be used. Also in this step, radii σ_i must be found for a proper overlapping of clusters.

The second step of training is the error backpropagation algorithm carried on only for the output layer. Since this is a supervised algorithm for one layer only, the training is very rapid, 100–1000 times faster than in the backpropagation multilayer network. This makes the radial basis-function network very attractive. Also, this network can be easily modeled using computers; however, its hardware implementation would be difficult.

32.6 Recurrent Neural Networks

In contrast to feedforward neural networks, with **recurrent networks** neuron outputs can be connected with their inputs. Thus, signals in the network can continuously circulate. Until recently, only a limited number of recurrent neural networks were described.

Hopfield Network

The single-layer recurrent network was analyzed by Hopfield (1982). This network, shown in Fig. 32.17, has unipolar hard threshold neurons with outputs equal to 0 or 1. Weights are given by a symmetrical square matrix \mathbf{W} with zero elements ($w_{ij} = 0$ for $i = j$) on the main diagonal. The stability of the system is usually analyzed by means of the *energy function*

$$E = -\frac{1}{2} \sum_{i=1}^N \sum_{j=1}^N W_{ij} v_i v_j \quad (32.41)$$

It has been proved that during signal circulation the energy E of the network decreases and the system converges to the stable points. This is especially true when the values of system outputs are updated in the asynchronous mode. This means that at a given cycle, only one random output can be changed to the required values. Hopfield also proved that those stable points, which the system converges, can be

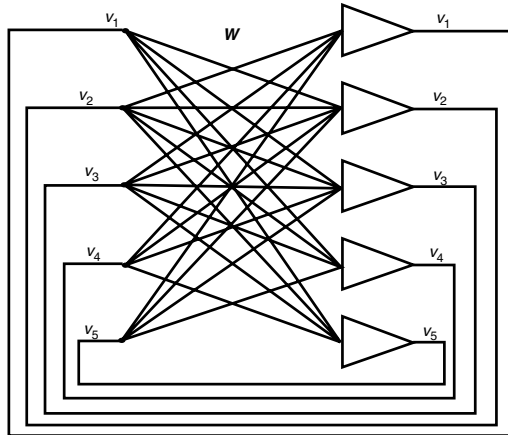

FIGURE 32.17 A Hopfield network or autoassociative memory.

programmed by adjusting the weights using a modified Hebbian rule,

$$\Delta w_{ij} = \Delta w_{ji} = (2v_i - 1)(2v_j - 1)c \quad (32.42)$$

Such memory has limited storage capacity. Based on experiments, Hopfield estimated that the maximum number of stored patterns is $0.15N$, where N is the number of neurons.

Later the concept of energy function was extended by Hopfield (1984) to one-layer recurrent networks having neurons with continuous activation functions. These types of networks were used to solve many optimization and linear programming problems.

Autoassociative Memory

Hopfield (1984) extended the concept of his network to autoassociative memories. In the same network structure as shown in Fig. 32.17, the bipolar hard-threshold neurons were used with outputs equal to -1 or $+1$. In this network, pattern \mathbf{s}_m are stored into the weight matrix \mathbf{W} using the autocorrelation algorithm

$$\mathbf{W} = \sum_{m=1}^M \mathbf{s}_m \mathbf{s}_m^T - \mathbf{M}\mathbf{I} \quad (32.43)$$

where M is the number of stored patterns and \mathbf{I} is the unity matrix. Note that \mathbf{W} is the square symmetrical matrix with elements on the main diagonal equal to zero (w_{ji} for $i = j$). Using a modified formula (32.42), new patterns can be added or subtracted from memory. When such memory is exposed to a binary bipolar pattern by enforcing the initial network states, after signal circulation the network will converge to the closest (most similar) stored pattern or to its complement. This stable point will be at the closest minimum of the energy

$$E(\mathbf{v}) = -\frac{1}{2} \mathbf{v}^T \mathbf{W} \mathbf{v} \quad (32.44)$$

Like the Hopfield network, the autoassociative memory has limited storage capacity, which is estimated to be about $M_{\max} = 0.15N$. When the number of stored patterns is large and close to the memory capacity, the network has a tendency to converge to spurious states, which were not stored. These spurious states are additional minima of the energy function.

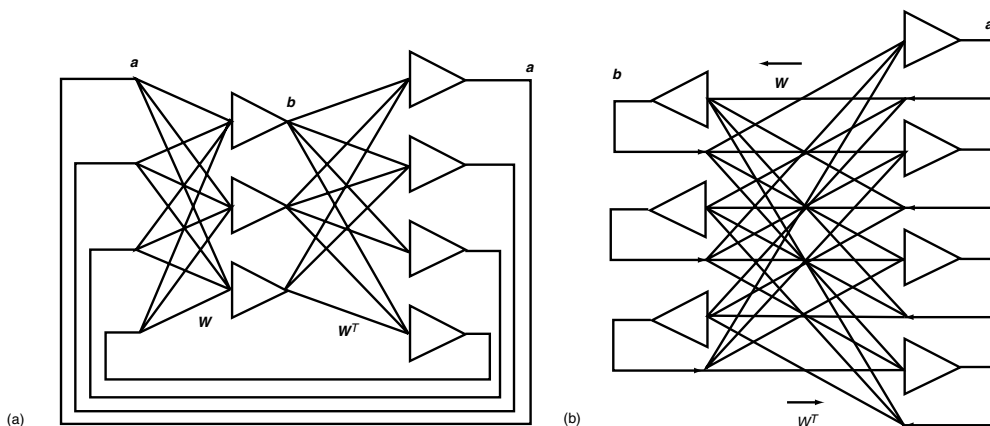

FIGURE 32.18 An example of the bidirectional autoassociative memory: (a) drawn as a two-layer network with circulating signals, (b) drawn as two-layer network with bidirectional signal flow.

Bidirectional Associative Memories (BAMs)

The concept of the autoassociative memory was extended to bidirectional associative memories (BAM) by Kosko (1987, 1988). This memory, shown in Fig. 32.18, is able to associate pairs of the patterns \mathbf{a} and \mathbf{b} . This is the two-layer network with the output of the second layer connected directly to the input of the first layer. The weight matrix of the second layer is \mathbf{W}^T and \mathbf{W} for the first layer. The rectangular weight matrix \mathbf{W} is obtained as a sum of the cross-correlational matrices

$$\mathbf{W} = \sum_{m=1}^M \mathbf{a}_m \mathbf{b}_m \quad (32.45)$$

where M is the number of stored pairs, and \mathbf{a}_m and \mathbf{b}_m are the stored vector pairs. If the nodes \mathbf{a} or \mathbf{b} are initialized with a vector similar to the stored one, then after signal circulations, both stored patterns \mathbf{a}_m and \mathbf{b}_m should be recovered. The BAM has limited memory capacity and memory corruption problems similar to the autoassociative memory. The BAM concept can be extended for association of three or more vectors.

32.7 Fuzzy Systems

The main applications of neural networks are related to the nonlinear mapping of n -dimensional input variables into m -dimensional output variables. Such a function is often required in control systems, where, for specific measured variables, certain control variables must be generated. Another approach for nonlinear mapping of one set of variables into another set of variables is the *fuzzy controller*. The principle of operation of the fuzzy controller significantly differs from neural networks. The block diagram of a fuzzy controller is shown in Fig. 32.19. In the first step, analog inputs are converted into a set of fuzzy variables. In this step, for each analog input, 3–9 fuzzy variables typically are generated. Each fuzzy variable has an analog value between zero and one. In the next step, a fuzzy logic is applied to the input fuzzy variables and a resulting set of output variables is generated. In the last step, known as *defuzzification*, from a set of output fuzzy variables, one or more output analog variables are generated, which are used as control variables.

FIGURE 32.19 The block diagram of the fuzzy controller.

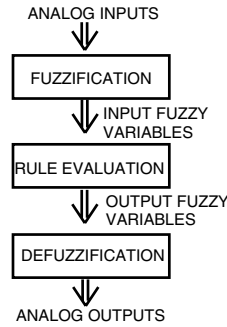

FIGURE 32.20 Fuzzification process: (a) typical membership functions for the fuzzification and the defuzzification processes, (b) example of converting a temperature into fuzzy variables.

Fuzzification

The purpose of fuzzification is to convert an analog variable input into a set of fuzzy variables. For higher accuracy, more fuzzy variables will be chosen. To illustrate the fuzzification process, consider that the input variable is the temperature and is coded into five fuzzy variables: cold, cool, normal, warm, and hot. Each fuzzy variable should obtain a value between zero and one, which describes a *degree of association* of the analog input (temperature) within the given fuzzy variable. Sometimes, instead of the term *degree of association*, the term *degree of membership* is used. The process of fuzzification is illustrated in Fig. 32.20. Using Fig. 32.20 we can find the degree of association of each fuzzy variable with the given temperature. For example, for a temperature of 57°F, the following set of fuzzy variables is obtained: [0, 0.5, 0.2, 0, 0], and for $T = 80^\circ\text{F}$, it is [0, 0, 0.25, 0.7, 0]. Usually only one or two fuzzy variables have a value other than zero. In the example, trapezoidal functions are used for calculation of the degree of association. Various different functions such as triangular or Gaussian can also be used, as long as the computed value is in the range from zero to one. Each membership function is described by only three or four parameters, which have to be stored in memory.

For proper design of the fuzzification stage, certain practical rules should be used:

- Each point of the input analog variable should belong to at least one and no more than two membership functions.
- For overlapping functions, the sum of two membership functions must not be larger than one. This also means that overlaps must not cross the points of maximum values (ones).
- For higher accuracy, more membership functions should be used. However, very dense functions lead to frequent system reaction and sometimes to system instability.

Rule Evaluation

In contrary to boolean logic where variables can have only binary states, in fuzzy logic all variables may have any values between zero and one. The fuzzy logic consists of the same basic: \wedge —AND, \vee —OR, and NOT operators:

$$\begin{aligned}
 A \wedge B \wedge C &\Rightarrow \min\{A, B, C\}\text{—smallest value of } A \text{ or } B \text{ or } C \\
 A \vee B \vee C &\Rightarrow \max\{A, B, C\}\text{—largest value of } A \text{ or } B \text{ or } C \\
 \bar{A} &\Rightarrow 1 - A\text{—one minus value of } A
 \end{aligned}$$

| | y_1 | y_2 | y_3 |
|-------|-------|-------|-------|
| x_1 | z_1 | z_1 | z_2 |
| x_2 | z_1 | z_3 | z_3 |
| x_3 | z_2 | z_4 | z_4 |
| x_4 | z_1 | z_2 | z_3 |
| x_5 | z_1 | z_2 | z_4 |

| | y_1 | y_2 | y_3 |
|-------|----------|----------|----------|
| x_1 | t_{11} | t_{12} | t_{13} |
| x_2 | t_{21} | t_{22} | t_{23} |
| x_3 | t_{31} | t_{32} | t_{33} |
| x_4 | t_{41} | t_{42} | t_{43} |
| x_5 | t_{51} | t_{52} | t_{53} |

FIGURE 32.21 Fuzzy tables: (a) table with fuzzy rules, (b) table with the intermediate variables t_{ij} .

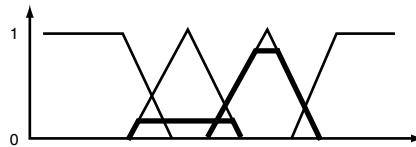

FIGURE 32.22 Illustration of the defuzzification process.

For example, $0.1 \wedge 0.7 \wedge 0.3 = 0.1$, $0.1 \vee 0.7 \vee 0.3 = 0.7$, and $\overline{0.3} = 0.7$. These rules are also known as Zadeh AND, OR, and NOT operators (Zadeh, 1965). Note that these rules are true also for classical binary logic.

Fuzzy rules are specified in the *fuzzy table* as it is shown for a given system. Consider a simple system with two analog input variables x and y , and one output variable z . The goal is to design a fuzzy system generating z as $f(x, y)$. After fuzzification, the analog variable x is represented by five fuzzy variables: x_1, x_2, x_3, x_4, x_5 and an analog variable y is represented by three fuzzy variables: y_1, y_2, y_3 . Assume that an analog output variable is represented by four fuzzy variables: z_1, z_2, z_3, z_4 . The key issue of the design process is to set proper output fuzzy variables z_k for all combinations of input fuzzy variables, as shown in the table in Fig. 32.21. The designer has to specify many rules such as if inputs are represented by fuzzy variables x_i and y_j , then the output should be represented by fuzzy variable z_k . Once the fuzzy table is specified, the fuzzy logic computation proceeds in two steps. First, each field of the fuzzy table is filled with intermediate fuzzy variables t_{ij} , obtained from AND operator $t_{ij} = \min\{x_i, y_j\}$, as shown in Fig. 32.21(b). This step is independent of the required rules for a given system. In the second step, the OR (max) operator is used to compute each output fuzzy variable z_k . In the given example in Fig. 32.21, $z_1 = \max\{t_{11}, t_{12}, t_{21}, t_{41}, t_{51}\}$, $z_2 = \max\{t_{13}, t_{31}, t_{42}, t_{52}\}$, $z_3 = \max\{t_{22}, t_{23}, t_{43}\}$, $z_4 = \max\{t_{32}, t_{34}, t_{53}\}$. Note that the formulas depend on the specifications given in the fuzzy table shown in Fig. 32.21(a).

Defuzzification

As a result of fuzzy rule evaluation, each analog output variable is represented by several fuzzy variables. The purpose of defuzzification is to obtain analog outputs. This can be done by using a membership function similar to that shown in Fig. 32.20. In the first step, fuzzy variables obtained from rule evaluations are used to modify the membership function employing the formula

$$\mu_k^*(z) = \min\{\mu_k(z), z_k\} \tag{32.46}$$

For example, if the output fuzzy variables are 0, 0.2, 0.7, 0.0, then the modified membership functions have shapes shown by the thick line in Fig. 32.22. The analog value of the z variable is found as a *center*

of gravity of modified membership functions $\mu_k^*(z)$,

$$z_{\text{analog}} = \frac{\sum_{k=1}^n \int_{-\infty}^{+\infty} \mu_k^*(z) z dz}{\sum_{k=1}^n \int_{-\infty}^{+\infty} \mu_k^*(z) dz} \quad (32.47)$$

In the case where shapes of the output membership functions $\mu_k(z)$ are the same, the equation can be simplified to

$$z_{\text{analog}} = \frac{\sum_{k=1}^n z_k z c_k}{\sum_{k=1}^n z_k} \quad (32.48)$$

where

- n = number of membership function of z_{analog} output variable,
- z_k = fuzzy output variables obtained from rule evaluation,
- $z c_k$ = analog values corresponding to the center of k th membership function.

Equation (32.47) is usually too complicated to be used in a simple microcontroller based system; therefore, in practical cases, Eq. (32.48) is used more frequently.

Design Example

Consider the design of a simple fuzzy controller for a sprinkler system. The sprinkling time is a function of humidity and temperature. Four membership functions are used for the temperature, three for humidity, and three for the sprinkling time, as shown in Fig. 32.23. Using intuition, the fuzzy table can be developed, as shown in Fig. 32.24(a).

Assume a temperature of 60°F and 70% humidity. Using the membership functions for temperature and humidity, the following fuzzy variables can be obtained for the temperature: [0, 0.2, 0.5, 0], and for the humidity: [0, 0.4, 0.6]. Using the min operator, the fuzzy table can be now filled with temporary fuzzy variables, as shown in Fig. 32.24(b). Note that only four fields have nonzero values. Using fuzzy rules, as shown in Fig. 32.24(a), the max operator can be applied in order to obtain fuzzy output variables: short $\rightarrow o_1 = \max\{0, 0, 0.2, 0.5, 0\} = 0.5$, medium $\rightarrow o_2 = \max\{0, 0, 0.2, 0.4, 0\} = 0.4$, long $\rightarrow o_3 = \max\{0, 0\} = 0$.

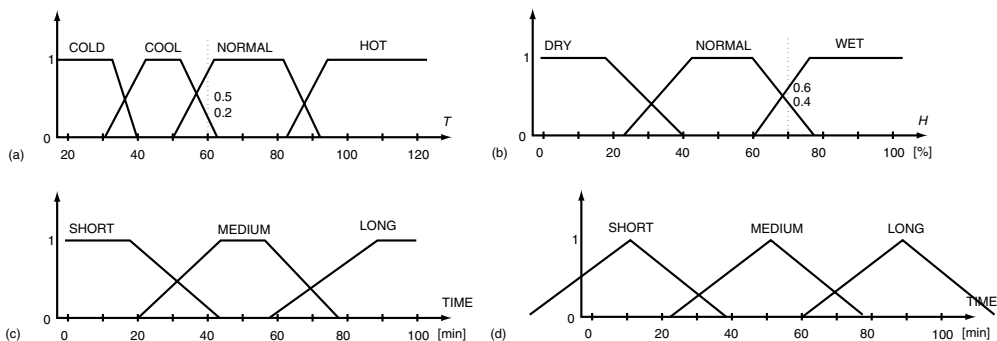

FIGURE 32.23 Membership functions for the presented example: (a) and (b) are membership functions for input variables, (c) and (d) are two possible membership functions for the output variable.

(a)

| | DRY | NORMAL | WET |
|------|-----|--------|-----|
| COLD | M | S | S |
| COOL | M | M | S |
| WARM | L | M | S |
| HOT | L | M | S |

(b)

| | | DRY | NORMAL | WET |
|------|-----|-----|--------|-----|
| | | 0 | 0.4 | 0.6 |
| COLD | 0 | 0 | 0 | 0 |
| COOL | 0.2 | 0 | 0.2 | 0.2 |
| WARM | 0.5 | 0 | 0.4 | 0.5 |
| HOT | 0 | 0 | 0 | 0 |

FIGURE 32.24 Fuzzy tables: (a) fuzzy rules for the design example, (b) fuzzy temporary variables for the design example.

Using Eq. (32.47) and Fig. 32.23(c), a sprinkle time of 28 min is determined. When the simplified approach is used with Eq. (32.46) and Fig. 32.23(d), then sprinkle time is 27 min.

32.8 Genetic Algorithms

The success of the artificial neural networks encouraged researchers to search for other patterns in nature to follow. The power of genetics through evolution was able to create such sophisticated machines as the human being. Genetic algorithms follow the evolution process in nature to find better solutions to some complicated problems. The foundations of genetic algorithms are given by Holland (1975) and Goldberg (1989). After initialization, the steps *selection*, *reproduction with a crossover*, and *mutation* are repeated for each generation. During this procedure, certain strings of symbols, known as chromosomes, evaluate toward a better solution. The genetic algorithm method begins with coding and an initialization. All significant steps of the genetic algorithm will be explained using a simple example of finding a maximum of the function $(\sin^2(x) - 0.5 * x)^2$ with the range of x from 0 to 1.6. Note that in this range, the function has a global maximum at $x = 1.309$, and a local maximum at $x = 0.262$.

Coding and Initialization

At first, the variable x has to be represented as a string of symbols. With longer strings, the process usually converges faster, so the fewer symbols for one string field that are used, the better. Although this string may be the sequence of any symbols, the binary symbols 0 and 1 are usually used. In our example, 6-bit binary numbers are used for coding, having a decimal value of $40x$. The process starts with a random generation of the initial population given in Table 32.1.

Selection and Reproduction

Selection of the best members of the population is an important step in the genetic algorithm. Many different approaches can be used to rank individuals. In this example the ranking function is given. Highest rank has member number 6, and lowest rank has member number 3. Members with higher rank should have higher chances to reproduce. The probability of reproduction for each member can be obtained as a fraction of the sum of all objective function values. This fraction is shown in the last column

TABLE 32.1 Initial Population

| String Number | String | Decimal Value | Variable Value | Function Value | Fraction of Total |
|---------------|--------|---------------|----------------|----------------|-------------------|
| 1 | 101101 | 45 | 1.125 | 0.0633 | 0.2465 |
| 2 | 101000 | 40 | 1.000 | 0.0433 | 0.1686 |
| 3 | 010100 | 20 | 0.500 | 0.0004 | 0.0016 |
| 4 | 100101 | 37 | 0.925 | 0.0307 | 0.1197 |
| 5 | 001010 | 10 | 0.250 | 0.0041 | 0.0158 |
| 6 | 110001 | 49 | 1.225 | 0.0743 | 0.2895 |
| 7 | 100111 | 39 | 0.975 | 0.0390 | 0.1521 |
| 8 | 000100 | 4 | 0.100 | 0.0016 | 0.0062 |
| Total | | | | 0.2568 | 1.0000 |

of [Table 32.1](#). Note that to use this approach, our objective function should always be positive. If it is not, the proper normalization should be introduced at first.

Reproduction

The numbers in the last column of [Table 32.1](#) show the probabilities of reproduction. Therefore, most likely members numbers 3 and 8 will not be reproduced, and members 1 and 6 may have two or more copies. Using a random reproduction process, the following population, arranged in pairs, could be generated:

$$\begin{array}{cccc} 101101 \rightarrow 45 & 110001 \rightarrow 49 & 100101 \rightarrow 37 & 110001 \rightarrow 49 \\ 100111 \rightarrow 39 & 101101 \rightarrow 45 & 110001 \rightarrow 49 & 101000 \rightarrow 40 \end{array}$$

If the size of the population from one generation to another is the same, two parents should generate two children. By combining two strings, two other strings should be generated. The simplest way to do this is to split in half each of the parent strings and exchange substrings between parents. For example, from parent strings 010100 and 100111, the following child strings will be generated: 010111 and 100100. This process is known as the *crossover*. The resultant children are

$$\begin{array}{cccc} 101111 \rightarrow 47 & 110101 \rightarrow 53 & 100001 \rightarrow 33 & 110000 \rightarrow 48 \\ 100101 \rightarrow 37 & 101001 \rightarrow 41 & 110101 \rightarrow 53 & 101001 \rightarrow 41 \end{array}$$

In general, the string need not be split in half. It is usually enough if only selected bits are exchanged between parents. It is only important that bit positions are not changed.

Mutation

In the evolutionary process, reproduction is enhanced with mutation. In addition to the properties inherited from parents, offspring acquire some new random properties. This process is known as mutation. In most cases mutation generates low-ranked children, which are eliminated in the reproduction process. Sometimes, however, the mutation may introduce a better individual with a new property. This prevents the process of reproduction from degeneration. In genetic algorithms, mutation usually plays a secondary role. For very high levels of mutation, the process is similar to random pattern generation, and such a searching algorithm is very inefficient. The mutation rate is usually assumed to be at a level well below 1%. In this example, mutation is equivalent to the random bit change of a given pattern. In this simple case, with short strings and a small population, and with a typical mutation rate of 0.1%, the patterns remain practically unchanged by the mutation process. The second generation for this example is shown in [Table 32.2](#).

TABLE 32.2 Population of Second Generation

| String Number | String | Decimal Value | Variable Value | Function Value | Fraction of Total |
|---------------|--------|---------------|----------------|----------------|-------------------|
| 1 | 010111 | 47 | 1.175 | 0.0696 | 0.1587 |
| 2 | 100100 | 37 | 0.925 | 0.0307 | 0.0701 |
| 3 | 110101 | 53 | 1.325 | 0.0774 | 0.1766 |
| 4 | 010001 | 41 | 1.025 | 0.0475 | 0.1084 |
| 5 | 100001 | 33 | 0.825 | 0.0161 | 0.0368 |
| 6 | 110101 | 53 | 1.325 | 0.0774 | 0.1766 |
| 7 | 110000 | 48 | 1.200 | 0.0722 | 0.1646 |
| 8 | 101001 | 41 | 1.025 | 0.0475 | 0.1084 |
| Total | | | | 0.4387 | 1.0000 |

Note that two identical highest ranking members of the second generation are very close to the solution $x = 1.309$. The randomly chosen parents for the third generation are:

010111 \rightarrow 47 110101 \rightarrow 53 110000 \rightarrow 48 101001 \rightarrow 41
 110101 \rightarrow 53 110000 \rightarrow 48 101001 \rightarrow 41 110101 \rightarrow 53

which produces the following children:

010101 \rightarrow 21 110000 \rightarrow 48 110001 \rightarrow 49 101101 \rightarrow 45
 110111 \rightarrow 55 110101 \rightarrow 53 101000 \rightarrow 40 110001 \rightarrow 49

The best result in the third population is the same as in the second one. By careful inspection of all strings from the second or third generation, it may be concluded that using crossover, where strings are always split in half, the best solution 110100 \rightarrow 52 will never be reached, regardless of how many generations are created. This is because none of the population in the second generation has a substring ending with 100. For such crossover, a better result can be only obtained due to the mutation process, which may require many generations. Better results in the future generation also can be obtained when strings are split in random places. Another possible solution is that only randomly chosen bits are exchanged between parents.

The genetic algorithm is very rapid, and it leads to a good solution within a few generations. This solution is usually close to global maximum, but not the best.

Defining Terms

Backpropagation: Training technique for multilayer neural networks.

Bipolar neuron: Neuron with output signal between -1 and $+1$.

Feedforward network: Network without feedback.

Perceptron: Network with hard threshold neurons.

Recurrent network: Network with feedback.

Supervised learning: Learning procedure when desired outputs are known.

Unipolar neuron: Neuron with output signal between 0 and $+1$.

Unsupervised learning: Learning procedure when desired outputs are unknown.

References

- Fahlman, S.E. 1988. Faster-learning variations on backpropagation: An empirical study. *Proceedings of the Connectionist Models Summer School*, D. Touretzky, G. Hinton, and T. Sejnowski, Eds., Morgan Kaufmann, San Mateo, CA.
- Fahlman, S.E. and Lebiere, C. 1990. The cascade correlation learning architecture. *Adv. Ner. Inf. Proc. Syst.*, 2, D.S. Touretzky, ed., pp. 524–532. Morgan Kaufmann, Los Altos, CA.

- Goldberg, D.E. 1989. *Genetic Algorithm in Search, Optimization and Machine Learning*. Addison–Wesley, Reading, MA.
- Grossberg, S. 1969. Embedding fields: a theory of learning with physiological implications. *Journal of Mathematical Psychology* 6:209–239.
- Hebb, D.O. 1949. *The Organization of Behavior, a Neuropsychological Theory*. John Wiley, New York.
- Hecht-Nielsen, R. 1987. Counterpropagation networks. *Appl. Opt.* 26(23):4979–4984.
- Hecht-Nielsen, R. 1988. Applications of counterpropagation networks. *Neural Networks* 1:131–139.
- Holland, J.H. 1975. *Adaptation in Natural and Artificial Systems*. Univ. of Michigan Press, Ann Arbor, MI.
- Hopfield, J.J. 1982. Neural networks and physical systems with emergent collective computation abilities. *Proceedings of the National Academy of Science* 79:2554–2558.
- Hopfield, J.J. 1984. Neurons with graded response have collective computational properties like those of two-state neurons. *Proceedings of the National Academy of Science* 81:3088–3092.
- Kohonen, T. 1988. The neural phonetic typerater. *IEEE Computer* 27(3):11–22.
- Kohonen, T. 1990. The self-organized map. *Proc. IEEE* 78(9):1464–1480.
- Kosko, B. 1987. Adaptive bidirectional associative memories. *App. Opt.* 26:4947–4959.
- Kosko, B. 1988. Bidirectional associative memories. *IEEE Trans. Sys. Man, Cyb.* 18:49–60.
- McCulloch, W.S. and Pitts., W.H., 1943. A logical calculus of the ideas imminent in nervous activity. *Bull. Math. Biophys.* 5:115–133.
- Minsky, M. and Papert, S. 1969. *Perceptrons*. MIT Press, Cambridge, MA.
- Nilsson, N.J. 1965. *Learning Machines: Foundations of Trainable Pattern Classifiers*. McGraw–Hill, New York.
- Nguyen, D. and Widrow, B. 1990. Improving the learning speed of 2-layer neural networks, by choosing initial values of the adaptive weights. *Proceedings of the International Joint Conference on Neural Networks* (San Diego), CA, June.
- Pao, Y.H. 1989. *Adaptive Pattern Recognition and Neural Networks*. Addison–Wesley, Reading, MA.
- Rosenblatt, F. 1958. The perceptron: a probabilistic model for information storage and organization in the brain. *Psych. Rev.* 65:386–408.
- Rumelhart, D.E., Hinton, G.E., and Williams, R.J. 1986. Learning internal representation by error propagation. *Parallel Distributed Processing*. Vol. 1, pp. 318–362. MIT Press, Cambridge, MA.
- Sejnowski, T.J. and Rosenberg, C.R. 1987. Parallel networks that learn to pronounce English text. *Complex Systems* 1:145–168.
- Specht, D.F. 1990. Probalistic neural networks. *Neural Networks* 3:109–118.
- Specht, D.F. 1992. General regression neural network. *IEEE Trans. Neural Networks* 2:568–576.
- Wasserman, P.D. 1989. *Neural Computing Theory and Practice*. Van Nostrand Reinhold, New York.
- Werbos, P., 1974. Beyond regression: new tools for prediction and analysis in behavioral sciences. Ph.D. diss., Harvard University.
- Widrow, B. and Hoff, M.E. 1960. Adaptive switching circuits. 1960 IRE Western Electric Show and Convention Record, Part 4 (Aug. 23):96–104.
- Widrow, B. 1962. Generalization and information storage in networks of adaline Neurons. In *Self-organizing Systems*, M.C. Jovitz, G.T. Jacobi, and G. Goldstein, eds., pp. 435–461. Sparten Books, Washington, D.C.
- Wilamowski, M. and Torvik, L., 1993. Modification of gradient computation in the back-propagation algorithm. *ANNIE'93 - Artificial Neural Networks in Engineering*. November 14–17, 1993, St. Louis, Missou.; also in C.H Dagli, ed. 1993. *Intelligent Engineering Systems Through Artificial Neural Networks* Vol. 3, pp. 175–180. ASME Press, New York.
- Zadeh, L.A. 1965. Fuzzy sets. *Information and Control* 8:338–353.
- Zurada, J. 1992. *Introduction to Artificial Neural Systems*. West Publ.

33

Advanced Control of an Electrohydraulic Axis

Florin Ionescu

University of Applied Sciences

Crina Vlad

Politeknica University of Bucharest

Dragos Arotaritei

Aalborg University Esbjerg

- 33.1 Introduction
- 33.2 Generalities Concerning ROBI_3, a Cartesian Robot with Three Electrohydraulic Axes
- 33.3 Mathematical Model and Simulation of Electrohydraulic Axes
The Extended Mathematical Model • Nonlinear Mathematical Model of the Servovalve • Nonlinear Mathematical Model of Linear Hydraulic Motor
- 33.4 Conventional Controllers Used to Control the Electrohydraulic Axis
PID, PI, PD with Filtering • Observer • Simulation Results of Electrohydraulic Axis with Conventional Controllers
- 33.5 Control of Electrohydraulic Axis with Fuzzy Controllers
- 33.6 Neural Techniques Used to Control the Electrohydraulic Axis
Neural Control Techniques
- 33.7 Neuro-Fuzzy Techniques Used to Control the Electrohydraulic Axis
Control Structure
- 33.8 Software Considerations
- 33.9 Conclusions

33.1 Introduction

Due to the development of technology in the last few years, robots are seen as advanced mechatronic systems which require knowledge from mechanics, actuators, and control in order to perform very complex tasks. Different kinds of servo-systems, especially electrohydraulic, could be met at the executive level of the robots. Taking into account the most advanced control approaches, this paper deals with the implementation of advanced controllers besides conventional ones which are used in an electrohydraulic system. The considered electrohydraulic system is one of the axes of a robot. These robots possess three or more electrohydraulic axes, which are identical with the axis studied in this chapter.

An electrohydraulic axis whose mathematical model (MM) is described in this chapter presents a multitude of nonlinearities. Conventional controllers are becoming increasingly inappropriate to control the systems with an imprecise model where many nonlinearities are manifested. Therefore, advanced techniques such as neural networks and fuzzy algorithms are deeply involved in the control of such systems. Neural networks, initially proposed by McCulloch and Pitts, Rosenblatt, Widrow, had several

limitations that restricted the domain of applications. An important change took place in the 1980s when Hopfield's theory regarding recurrent neural networks, the model of self-organization developed by Kohonen, and cellular neural networks (Chua) relaunched this research field. The development of some efficient algorithms dedicated specifically to the architecture of neural networks, and the application of these networks in control, represents an interesting area of research in the contemporary world of science.

Fuzzy systems, in conjunction with neural networks, hold an important place in advanced techniques of control. These systems have origins in fuzzy set theory initiated by L. Zadeh. One essential feature of fuzzy systems is the approximate reasoning in which the variables are described in a qualitative manner. Due to the capability of fuzzy systems to deal with imprecise information, they are strongly recommended in order to express knowledge in the form of linguistic rules. In this way, the human operator's knowledge, which is linguistic or numerical, is used to generate the set of fuzzy if-then rules as a basis for a fuzzy controller. A main drawback of fuzzy systems is the difficulty to design them on the basis of a systematic methodology. To overcome this drawback, the learning procedures from neural networks are applied successfully in order to tune the parameters of membership functions.

The merging of these two fields has led to the emergence of neuro-fuzzy systems, which have been applied with promising results in the field of control-engineering. In order to improve dynamic and static performances of the systems characterized by nonlinearities and uncertainties, neuro-fuzzy controllers are used.

The present contribution is organized as follows. An introduction of the electrohydraulic systems with an emphasis on the control of such devices is realized in [Section 33.2](#). [Section 33.3](#) is devoted to the MM of electrohydraulic axes, and the subsequent sections treat the control of electrohydraulic axes through conventional methods ([Section 33.4](#)), fuzzy systems ([Section 33.5](#)), neural networks ([Section 33.6](#)), and neuro-fuzzy techniques ([Section 33.7](#)). Conclusions are given in [Section 33.8](#).

33.2 Generalities Concerning ROBI_3, a Cartesian Robot with Three Electrohydraulic Axes

The automated installation, which uses electrohydraulic axes, whose mathematical model is described in [section 33.3](#), is a Cartesian robot named ROBI_3. ROBI_3 has three identical electrohydraulic axes and is built from aluminium profiles [21]. The slides are actuated by hydraulic servoactuators (Rexroth). Slides move on the linear guideways with balls and two recirculation paths. The hydraulic supply installation is placed under the robot table and has a cooling and controlling installation with air. The mechanical structure of the robot is depicted in [Fig. 33.1](#). The three axes of ROBI_3 are identically controlled by the controlling software named TORCH, which runs in Windows. The 32-bit dSPACE controlling hardware endowed with 10 A/D and D/A interfaces is plugged into the PC and serves as the interface between the PC and each of the axes.

An electrohydraulic axis consists of a servovalve and a hydraulic cylinder and has a nonlinear structure. The control system of one axis consists of:

1. the controller represented by a personal computer endowed with a process card;
2. the electrohydraulic converter;
3. the actuator (a linear hydraulic servomotor (LHM));
4. the mechanical process to be controlled, characterized by the slade position;
5. the position transducer.

The control system of robot ROBI_3 is illustrated in [Fig. 33.2](#), where the presence of three electrohydraulic axes, as well as the structure of one axes, identical to the others, can be observed.

The corresponding mathematical model for one axis, on the basis of which the control of the robot is achieved, is described in [section 33.3](#). Through numerical simulations of the three axes of the robot, the necessary mechanical structure interface data is obtained.

Preliminary experiments with driven and controlled variable: position and velocity are made in order to achieve experience ([Figs. 33.2](#) and [33.3](#)). The diagram of a closed-loop position control with

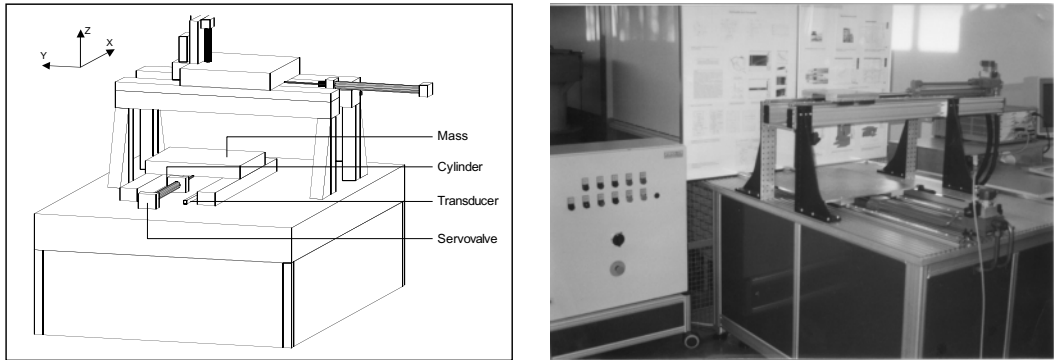

FIGURE 33.1 ROBI_3, a Cartesian robot with three axes [21]. (a) Design; (b) practical alignment.

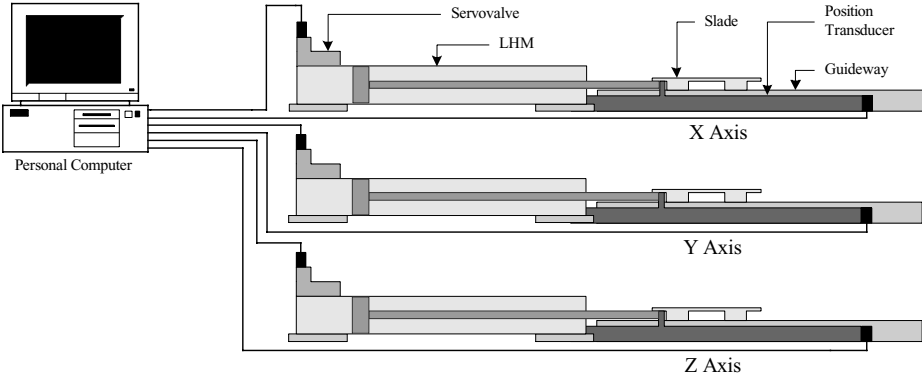

FIGURE 33.2 The control system of the robot [21,24].

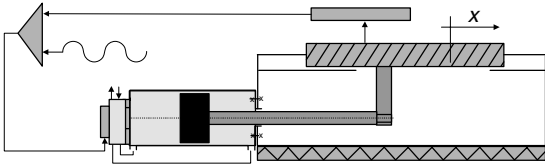

FIGURE 33.3 Diagram of a closed-loop position control with direct measurement.

direct measurement (driven by means of a servovalve) is shown in Fig. 33.3, and the closed-loop position control with indirect measurement at spindle (actuated by means of a servovalve) is shown in Fig. 33.4.

A volumetric Q-rate regulation with constant pressure ($Q \neq \text{const}; p @ \text{const}$) is shown in Fig. 33.5. However, this classic model, useful for application, was used only for preliminary results in simulation. One of the main reasons to use this is because we need a well-known mathematical model with well-studied behavior in order to test the controllers (neural and neuro-fuzzy, namely).

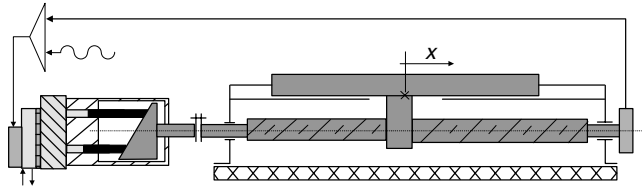

FIGURE 33.4 Closed loop-position control with indirect measurement.

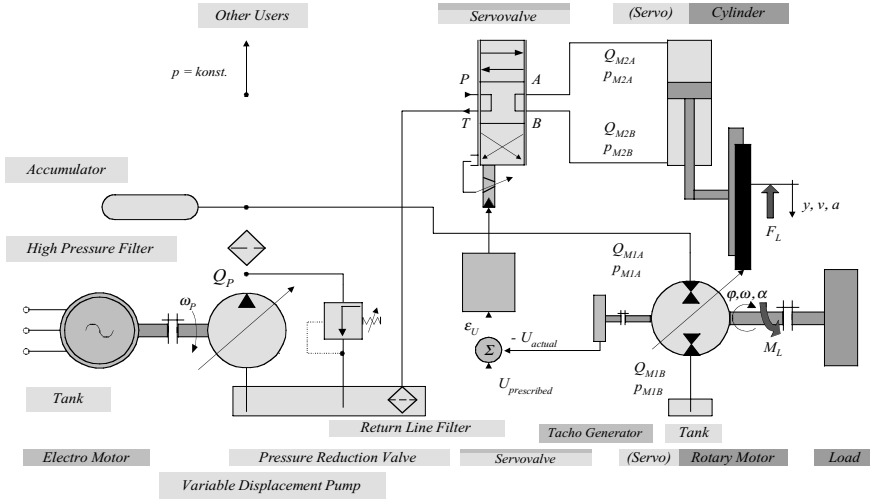

FIGURE 33.5 Volumetric Q-rate regulation with constant pressure.

33.3 Mathematical Model and Simulation of Electrohydraulic Axes

Section 33.3 deals with the analytical findings of the mathematical model (MM) of an electrohydraulic axis, a component part of robot ROBI_3. This method of analysis is advantageous because it offers the possibility to use this MM for other electrohydraulic axes as well, regardless of the different number of stages, and also allows the testing of dynamic performances of the axis at the design level.

In this section, the following were realized:

1. the static models of electrohydraulic system components (servo valve, hydraulic linear motor);
2. the parameters involved in MM, based on constructive and flowing regime characteristics;
3. the nonlinear MM of the proposed electrohydraulic system;
4. the structural scheme of the hydraulic axis in order to simulate its behavior (SIMULINK);
5. the investigations regarding MM, which certify the stability of the system and the fact that the modelled process is a rapid one.

Values of parameters that describe the MM are set based on hydraulic characteristics and on constructive parameters of the considered system.

The Extended Mathematical Model

The studied system consists of a servo valve and an asymmetric motor. In most cases, the control of an electrohydraulic axis is directed towards position control, velocity control, pressure control, or force control. The position control of the axis is studied. The position control loop for the proposed installation is illustrated in Fig. 33.6, together with the denomination of some data.

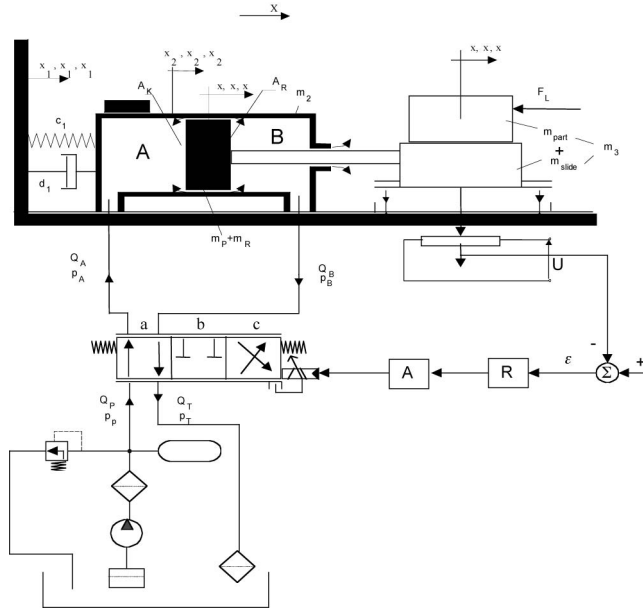

FIGURE 33.6 Control scheme of the servosystem.

Nonlinear Mathematical Model of the Servo Valve

As previously mentioned, the servo valve used at the proposed electrohydraulic axis has four paths and three positions. The servo valve has four active control edges at the second hydraulic stage. Three stages could be distinguished by this servo valve: the electromechanical, the mechanohydraulic, and the hydro-mechanical one. Regarded as a system, a servo valve is complex, with various types of nonlinearities being manifested. Different static and dynamic nonlinearities such as dead zone, jump in origin, saturation, Coulombian and Newtonian frictions with hysteresis, and asymmetry appear in each of these three levels and also in the actuator of the electrohydraulic motor. These were taken into account in the modeling of the servo valve and of the cylinder behavior.

For the studied servo valve, the circulation of the fluid is considered directed from the pump to the admission chamber A (Q_A) and from the discharge chamber B to the reservoir (Q_B). Figure 33.6 presents the control loop where the transducer is placed on the feedback path and the controller R and the amplifier A are on the direct path. Electrical signal (± 10 V or ± 300 mA) is converted into the displacement x_v of the valve, and in this way in a flow Q, which is transmitted to the linear hydraulic motor.

From the point of view of control characteristics, the number of active edges serves as a method of classification of slide valves [3]. A servo valve with four active control edges was considered. The lightly simplified mathematical model, which describes the functionality of the servo valve, consists of the following equations:

$$u(t) = L \cdot \frac{d i(t)}{dt} + R \cdot i(t) \quad (33.1)$$

where L [H], the inductance of electrical level; R [W], the resistance of electrical level; $u(t)$ [V], the control voltage; $i(t)$ [A], the control intensity.

$$m \cdot \ddot{x}_v(t) + d \cdot \dot{x}_v(t) + c \cdot x_v(t) = \sum F \quad (33.2)$$

where m [kg], the mass of valve; d [N/(m/s)], the linearized gradient of viscous friction for the piston of the valve; c [N/m], the coefficient of hydraulic elasticity; x_v [m], the spool displacement; $\sum F$ [N], the

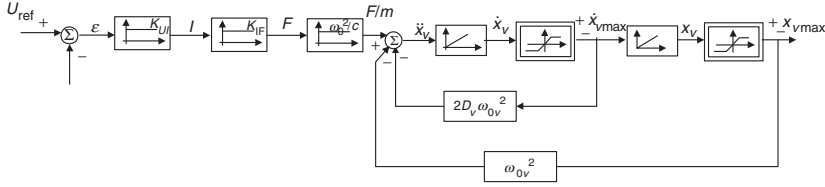

FIGURE 33.7 Nonlinear MM of the first stages of the servovalve.

resulting force, which actuates on the valve spool.

$$\ddot{x}_v(t) + 2 \cdot D_v \cdot \omega_{0v} \cdot \dot{x}_v(t) + \omega_{0v}^2 \cdot x_v(t) = \frac{\Sigma F}{m}$$

$$\ddot{x}_v(t) = k^* - 2 \cdot D_v \cdot \omega_{0v} \cdot \dot{x}_v(t) - \omega_{0v}^2 \cdot x_v(t) \quad \text{where } k^* = \frac{\Sigma F}{m} \quad (33.3)$$

The displacement x_v , obtained based upon the mentioned equations, is implemented in SIMULINK using the scheme from Fig. 33.7. This module of nonlinear MM includes two stages of electrohydraulic axis: the electrohydraulic and the hydromechanical one.

The corresponding equations for the four flows that go through the servovalve are

$$Q_{PA} = \alpha_D \cdot \pi \cdot D_v \cdot \sqrt{\frac{2}{\rho}} \cdot (x_0 + x_v(t)) \cdot \sqrt{p_P - p_A(t)}, \quad x_v \in [-x_0, x_{\max}]$$

$$Q_{AT} = \alpha_D \cdot \pi \cdot D_v \cdot \sqrt{\frac{2}{\rho}} \cdot (x_0 - x_v(t)) \cdot \sqrt{p_A(t) - p_T}, \quad x_v \in [-x_{\max}, x_0]$$

$$Q_{PB} = \alpha_D \cdot \pi \cdot D_v \cdot \sqrt{\frac{2}{\rho}} \cdot (x_0 - x_v(t)) \cdot \sqrt{p_P - p_B(t)}, \quad x_v \in [-x_{\max}, x_0]$$

$$Q_{BT} = \alpha_D \cdot \pi \cdot D_v \cdot \sqrt{\frac{2}{\rho}} \cdot (x_0 + x_v(t)) \cdot \sqrt{p_B(t) - p_T}, \quad x_v \in [-x_0, x_{\max}] \quad (33.4)$$

where Q_{PA} [m^3/s], the flow to the hydraulic motor, from pump to the chamber A of the motor; Q_{AT} [m^3/s], the flow from the chamber A to reservoir; Q_{PB} [m^3/s], the flow from pump to the chamber B of the motor; Q_{BT} [m^3/s], the flow from the chamber B to reservoir; α_D [-], the discharge coefficient; D_v [m], the spool's diameter; x_0 [m], the dimension of the lap of the spool; x_v [m], the spool's displacement; p_A [N/m^2], the fluid pressure in chamber A; p_B [N/m^2], the fluid pressure in chamber B [kg/m^3] fluids density. The flows, which are transmitted to LHM and evacuated from LHM, are Q_A and Q_B , which are computed as following:

$$Q_A = Q_{PA} - Q_{AT}, \quad Q_B = Q_{BT} - Q_{PB} \quad (33.5)$$

The lap of the spool is considered to be zero ($x_0 = 0$), and, therefore, the static characteristic is linear around the origin and also in the rest. With $Q_0 = \alpha_D \cdot \pi \cdot D_v \cdot \sqrt{2/\rho}$, the flow equations become

$$Q_{PA} = Q_0 \cdot x_v \cdot \sqrt{p_P - p_A}, \quad Q_{AT} = Q_0 \cdot (-x_v) \cdot \sqrt{p_A - p_T}$$

$$Q_{PB} = Q_0 \cdot (-x_v) \cdot \sqrt{p_P - p_B}, \quad Q_{BT} = Q_0 \cdot x_v \cdot \sqrt{p_B - p_T} \quad (33.6)$$

Nonlinear Mathematical Model of Linear Hydraulic Motor

The differential equations, based on which the MM of the linear hydraulic motor (LHM) was achieved, are

- i. the equation of the dynamic equilibrium of the forces reduced to the motor's rod, and
- ii. the equation of movement and flow continuity.

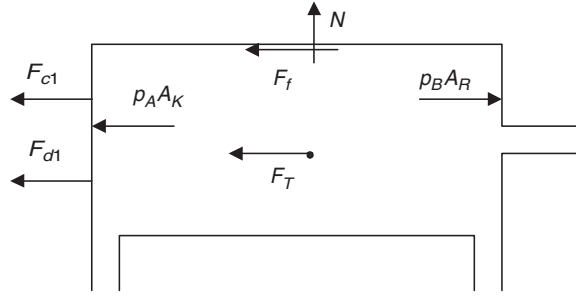

FIGURE 33.8 D'Alembert's principle applied to the cylinder.

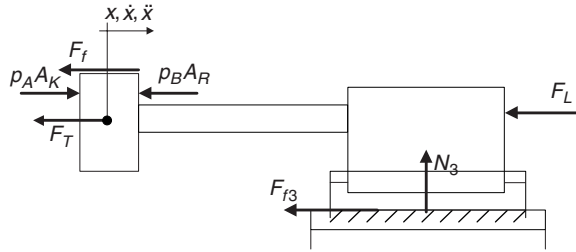

FIGURE 33.9 D'Alembert's principle applied to the rod, piston, and load.

Modeling the LHM, several simplifications (most of them concerning the Coulombian and Newtonian friction) were used. The forces that actuate on the LHM cylinder are depicted in Fig. 33.8:

Applying D'Alembert's principle, the equation of dynamic equilibrium of forces for the cylinder of LHM is

$$\dot{x}_2 = \frac{p_B \cdot A_R - p_A \cdot A_k + c_1 \cdot (x_1 - x_2) + d_1 \cdot (\dot{x}_1 - \dot{x}_2) + c_{fu} \cdot N \cdot \text{sgn}(\dot{x} - \dot{x}_2) + d_z \cdot (\dot{x} - \dot{x}_2)}{m_2 \cdot s} \quad (33.7)$$

where c_1 [N/m], the elasticity; d_1 [N/(m/s)], the linearized coefficient of the viscous Newtonian friction in the connection actuators' cylinder and wall; c_{fu} [-], the coefficient of the dry Coulombian friction in the cylinder and rod seals; d_z [N/(m/s)], the coefficient of Newtonian friction in the piston and rod seals; m_2 [kg], the cylinder mass; p_A [N/m²], the fluid pressure in the admission chamber A of the actuator; p_B [N/m²], the fluid pressure in the discharge chamber B of the actuator; A_K [m²], the piston active area in chamber A; A_R [m²], the piston active area in chamber B; N [N], the normal force, which determines the friction force between piston and cylinder; x [m], the piston displacement; x_1 [m], the wall displacement; and x_2 [m], the cylinder displacement.

The forces acting on the rod, piston, and working element are illustrated in Fig. 33.9

The velocity corresponding to the rod, piston, and mass m_3 (slade, guideway, and loading are considered stiff fastened) is inferred from the equilibrium equation:

$$\dot{x} = \frac{p_A \cdot A_K - p_B \cdot A_R - F_L - c_{fu} \cdot N \cdot \text{sgn}(\dot{x} - \dot{x}_2) - d_z \cdot (\dot{x} - \dot{x}_2) - c_{fu3} \cdot N_3 \cdot \text{sgn}(\dot{x} - \dot{x}_1) - d_3 \cdot (\dot{x} - \dot{x}_1)}{(m_p + m_T + m_3) \cdot s} \quad (33.8)$$

where m_p [kg], the piston mass; m_T [kg], the rod mass; m_3 [kg], load mass (reduced at the rod of piston); c_{fu3} [-], the coefficient of Coulombian friction between guide ways and slade; d_3 [N/(m/s)], the coefficient of Newtonian friction between guideways and slade; N_3 [N], the normal force which appears between loading and table; F_L [N], the loading force.

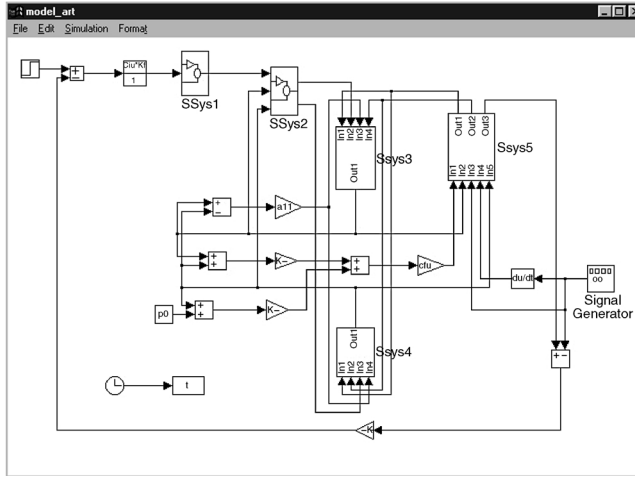

FIGURE 33.10 Electrohydraulic axis implemented in SIMULINK.

From the equations of continuity the pressures p_A and p_B are inferred:

$$\dot{p}_A = [Q_A - A_K \cdot (\dot{x} - \dot{x}_2) - a_{11} \cdot (p_A - p_B)] \cdot \frac{E_{ers}}{V_{0K} + A_K \cdot (x - x_2)} \quad (33.9)$$

$$\dot{p}_B = [A_R \cdot (\dot{x} - \dot{x}_2) + a_{11} \cdot (p_A - p_B) - a_{12} \cdot (p_B - p_0) - Q_B] \cdot \frac{E_{ers}}{(V_{0R} + A_R \cdot h) - A_R \cdot (x - x_2)} \quad (33.10)$$

where a_{11} , a_{12} [(N/m²)/(m³/s)], the gradients of leakages; $V_{0K,0R}$ [m³], the initial average volume of chambers A and B, respectively; E_{ers} [N/m²], the equivalent bulk modulus of oil; $p_{A,B}$ [N/m²], the fluid pressure in chambers A and B, respectively; and h [m], the stroke of the piston-rod.

The LHM operation is based on the equations described above, namely (33.7)–(33.10). The MM proposed in this section is implemented in SIMULINK 2.1/ MATLAB 5.1 and has the structure presented in Fig. 33.10.

The signal generator icon from the above figure generates the displacement of the wall x_1 , which has a sinusoidal form with the frequency 0.5 Hz and amplitude 0.0001 m.

The subsystems Ssys1 and Ssys2 have as outputs the valve displacement x_v , and the flows Q_A and Q_B , respectively. Ssys3 is the block that implemented Eq. (33.9), while the subsystem Ssys4 modelled Eq. (33.10). The equations that describe the displacement of the wall cylinder and the LHM piston are modelled by subsystem Ssys5. The reference signal is a step one whose values are in the range 0–10 V.

33.4 Conventional Controllers Used to Control the Electrohydraulic Axis

This section is organized as follows: the first part presents the bibliographic research concerning the traditional directions of the control system, and the second one contains the testing of several classic control structures (PID and control algorithms with Luenberger observer) through simulations of the electrohydraulic axis endowed with these controllers.

The testing of the MM is performed with SIMULINK and has a goal of the achievement of reference experimental results in order to perform a comparative study of classical controllers and advanced control structures applied to the electrohydraulic axis.

PID, PI, PD with Filtering

The conventional control structures used in this chapter are PI (proportional-integral), PID (proportional-integral-derivative), and PD (proportional-derivative) with filtering coefficient.

The transfer function of the PI controller has the following expression:

$$H_{PI} = \frac{U(s)}{\mathcal{E}(s)} = K_R \cdot \left(1 + \frac{1}{T_i \cdot s} \right) = K_R \cdot \frac{T_i \cdot s + 1}{T_i \cdot s} \quad (33.11)$$

K_R is the proportional factor, and T_i is the time constant of the integrative component.

The transfer function of the PID controller is described by the following equation:

$$H_{PID} = \frac{U(s)}{\mathcal{E}(s)} = K_R \cdot \left(1 + \frac{1}{T_i \cdot s} + T_d \cdot s \right) = K_R \cdot \frac{T_i \cdot T_d \cdot s^2 + T_i \cdot s + 1}{T_i \cdot s} \quad (33.12)$$

K_R and T_i have the same significance as previously mentioned, and T_d is the time constant of derivative component.

The transfer function corresponding to PD with filtering has the expression:

$$H_{PDF}(s) = \frac{U(s)}{\mathcal{E}(s)} = K_R \cdot \frac{1 + T_d \cdot s}{1 + \alpha \cdot T_d \cdot s} \quad (33.13)$$

where the coefficient α could have values in the range 0.1–0.125.

Generally speaking, PID controllers are commonly used in industrial control systems and, therefore, are well established. Nevertheless, the results obtained using a PID controller for complex control loops are not very satisfactory because it could be costly and time consuming to retune such regulators. PI controller is enough in situations where derivative action is not frequently used.

Observer

The theory of observers, started with the work of Luenberger and Ackermann, is fairly complete and comprehensive. For the proposed axis, an $(n - m - 1)$ order structure of the observer is adopted, where $n = 5$ represents the order of the system and $m = 1$ is the number of outputs [25]. The model of the servodrive is described by five state variables: two of them for the second-order model of the servovalve and the other three for the third-order servoactuator. The use of a linear observer as a parallel model reconstitutes the state-variables of the installation and delivers them to the controller. Two possibilities could be followed: with partial and with global reconstruction. The solution chosen was with partial reconstruction [12]. The complete system consists of the installation with nonlinearities, a parallel second-order model for the servovalve, a third-order linear servoactuator, a correction matrix for the observer, and a controller with five loops for the five state variables [23,25,26].

The block diagram of an electrohydraulic axis controlled with a third-order observer is shown in Fig. 33.11, where \mathbf{A} , \mathbf{b} , \mathbf{c}^T are the characteristic matrices of the linear system (electrohydraulic axis), \mathbf{k} is the correction matrix, and \mathbf{R} represents the matrix corresponding to the controller.

The simulation diagram of the electrohydraulic axis, controlled by a third-order observer, as it is depicted in SIMULINK, is illustrated in Fig. 33.12.

The algorithm used to compute the matrix \mathbf{k} and \mathbf{r} consists of the following steps:

- i. achievement of the MM for servovalve and servoactuator;
- ii. setting the state-variables of the process;
- iii. obtaining the controller upon the dynamics of the closed-loop system;
- iv. computing the correction matrix by using the desired poles for the observer [12].

LMM in the State of Space

The used variables are: x_1 , the rod position; x_2 , the rod velocity; x_3 , the rod acceleration; x_4 , the spool position; and x_5 , the spool velocity.

$$\begin{aligned}\dot{x}_1 &= x_2(t), & \dot{x}_2 &= x_3(t), & \dot{x}_4 &= x_5(t) \\ \dot{x}_3 &= -\omega_Z^2 x_2(t) - 2D_Z \omega_Z x_3(t) + k_Z \omega_Z^2 x_4(t) \\ \dot{x}_5 &= -\omega_V^2 x_4(t) - 2D_V \omega_V x_5(t) + k_V \omega_V^2 u(t)\end{aligned}\quad (33.16)$$

Thus the MM of the axis in state-space form becomes

$$\begin{aligned}\dot{\mathbf{x}}(t) &= \mathbf{A}\mathbf{x}(t) + \mathbf{b}u(t) \\ \mathbf{y}(t) &= \mathbf{c}^T \mathbf{x}(t)\end{aligned}\quad (33.17)$$

where

$$\mathbf{A} = \begin{pmatrix} 0 & 1 & 0 & 0 & 0 \\ 0 & 0 & 1 & 0 & 0 \\ 0 & -\omega_Z^2 & -2D_Z \omega_Z & k_Z & 0 \\ 0 & 0 & 0 & 0 & 1 \\ 0 & 0 & 0 & -\omega_V^2 & -2D_V \omega_V \end{pmatrix}, \quad \mathbf{b} = \begin{pmatrix} 0 \\ 0 \\ 0 \\ 0 \\ k_V \end{pmatrix}, \quad \mathbf{c}^T = (1 \ 0 \ 0 \ 0 \ 0) \quad (33.18)$$

Controller Design

The characteristic polynomial is obtained from $\det[s\mathbf{I} - (\mathbf{A}_C - \mathbf{b}_C \mathbf{r}^T)] = 0$, where \mathbf{A}_C and \mathbf{b}_C are the controllable forms of the matrices \mathbf{A} and \mathbf{b} . If $\mathbf{A} \neq \mathbf{A}_C$, the use of transformation matrix \mathbf{T} is advisable, in order to obtain \mathbf{A}_C and \mathbf{b}_C . Thus $\mathbf{A}_C = \mathbf{TAT}^{-1}$, and $\mathbf{b}_C = \mathbf{Tb}$. The matrix $\mathbf{F} = \mathbf{A}_C - \mathbf{b}_C \mathbf{r}^T$ has the form

$$\mathbf{F} = \begin{pmatrix} 0 & 1 & \dots & 0 \\ 0 & 0 & \dots & 0 \\ \cdot & \cdot & \dots & \cdot \\ 0 & 0 & \dots & 1 \\ -a_0 - r_1 & -a_1 - r_2 & \dots & -a_{n-1} - r_n \end{pmatrix} \quad (33.19)$$

The characteristic polynomial of the matrix \mathbf{F} is

$$s^n + (a_{n-1} + r_n)s^{n-1} + \dots + (a_1 + r_2)s + (a_0 + r_1) \quad (33.20)$$

The poles chosen for the closed-loop determine the polynomial

$$s^n + p_{n-1}s^{n-1} + p_{n-2}s^{n-2} + \dots + p_1s + p_0 \quad (33.21)$$

The polynomials (33.20) and (33.21) are identical; therefore, the coefficients of matrix \mathbf{r}_R^T are

$$r_\nu = p_{\nu-1} - a_{\nu-1}, \quad \nu = 1, \dots, n$$

If

$$\mathbf{A} = \mathbf{Ac}, \quad \mathbf{r}^T = \mathbf{r}_R^T$$

otherwise

$$\mathbf{r}^T = \mathbf{r}_R^T \mathbf{T} \quad (33.22)$$

Correction Matrix Design

The matrix \mathbf{F} is $\mathbf{F} = \mathbf{A}^* - \mathbf{K}\mathbf{c}^T$, where \mathbf{A}^* is the matrix of the observer. For \mathbf{F} the chosen poles are s_1, s_2, \dots, s_n , and

$$\det[s\mathbf{I} - \mathbf{F}] = (s - s_1)(s - s_2) \cdots (s - s_n) \quad (33.23)$$

$$\det[s\mathbf{I} - \mathbf{F}] = s^n + f_{n-1}s^{n-1} + \cdots + f_1s + f_0 \quad (33.24)$$

From these two equations, the coefficients k_1, k_2, \dots, k_n are obtained.

In this case, $\mathbf{c}^T = (1 \ 0 \ 0)$ and the matrix of the third observer is

$$\mathbf{A}^* = \begin{pmatrix} 0 & 1 & 0 \\ 0 & 0 & 1 \\ 0 & -\omega_z^2 & -2D_z \omega_z \end{pmatrix} \quad (33.25)$$

The correction matrix influences the transient behavior; the further the poles of \mathbf{F} from the poles of \mathbf{A}^* the quicker the response.

Simulation Results of Electrohydraulic Axis with Conventional Controllers

Based on the above algorithm in order to determine the correction matrix and the controller matrix, the SIMULINK implementation of the observer involves the following values:

$$r_1 = 19.95854, \quad r_2 = 0.069481, \quad r_3 = -7.06024 \times 10^{-4},$$

$$r_4 = -3.158688 \times 10^2, \quad r_5 = -3.451209 \times 10^{-1}$$

for the controller, and

$$k_1 = 1.67 \times 10^{-2}, \quad k_2 = 3.7028 \times 10^4, \quad k_3 = -6.969698 \times 10^6 \text{ for the correction matrix.}$$

When the reference signal is a step signal with $U = 10 \text{ V}$, the simulation results are shown in [Figs. 33.13](#) and [33.14](#)

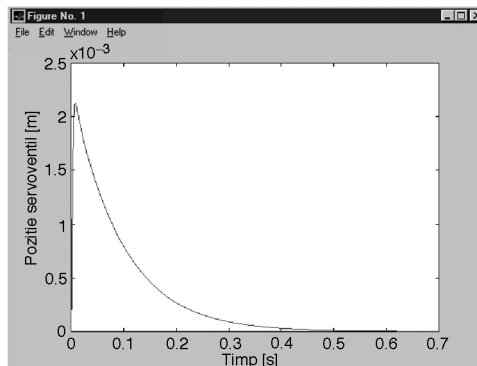

FIGURE 33.13 Position of servovalve for MM with observer.

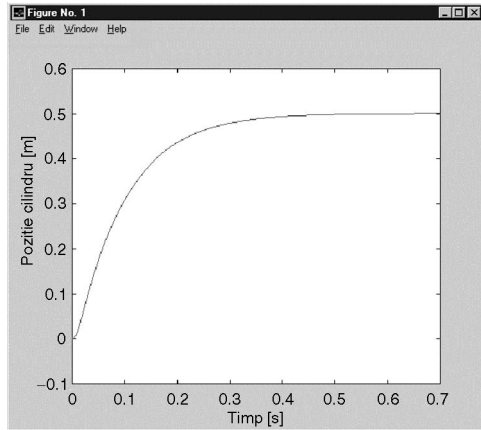

FIGURE 33.14 Cylinder position.

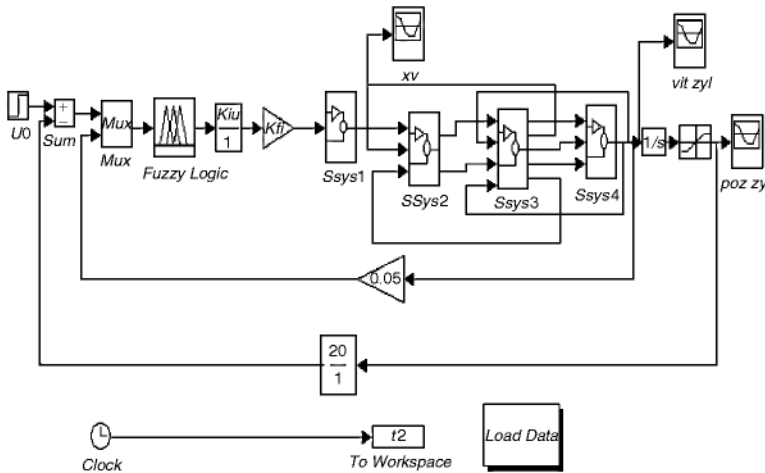

FIGURE 33.15 Electrohydraulic axis control with a fuzzy controller with two inputs.

33.5 Control of Electrohydraulic Axis with Fuzzy Controllers

Section 33.5 of this contribution is devoted to the presentation and the testing of nontraditional controllers based on fuzzy sets, which model the behavior of a human operator in the control process. The simulation results of an electrohydraulic axis with SUGENO and MAMDANI controllers are depicted. For the same number of inference rules extracted from the knowledge base, simulations proved that dynamic performances are improved for a fuzzy controller with two inputs.

The scheme achieved with SIMULINK to control the electrohydraulic axis with two inputs fuzzy controller and a MAMDANI or SUGENO inference is depicted in Fig. 33.15.

The results presented concern the simulation of the hydraulic axis endowed with a fuzzy controller, which is based on MAMDANI inference [59]. “Fuzzy Logic” toolbox gives the user the possibility to create MAMDANI or SUGENO fuzzy systems using graphic interfaces. FIS (Fuzzy Inference System) Editor, Membership Function Editor, and Inference Rules Editor are several of the tools available in SIMULINK. For instance, the corresponding FIS editor and the Membership Function Editor of each input for the proposed fuzzy controller with MAMDANI inference and two inputs are illustrated in Figs. 33.16 and 33.17

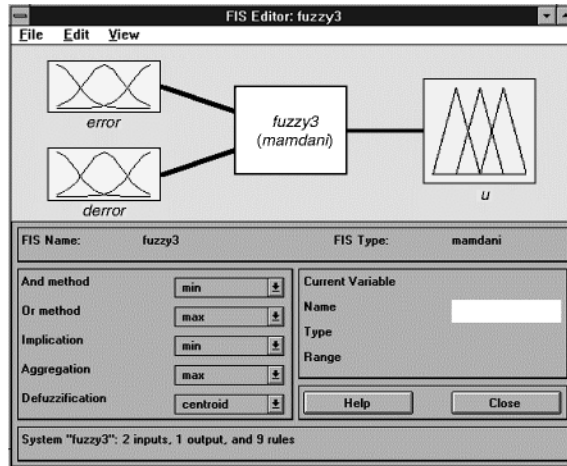

FIGURE 33.16 FIS Editor for fuzzy system based on MAMDANI inference.

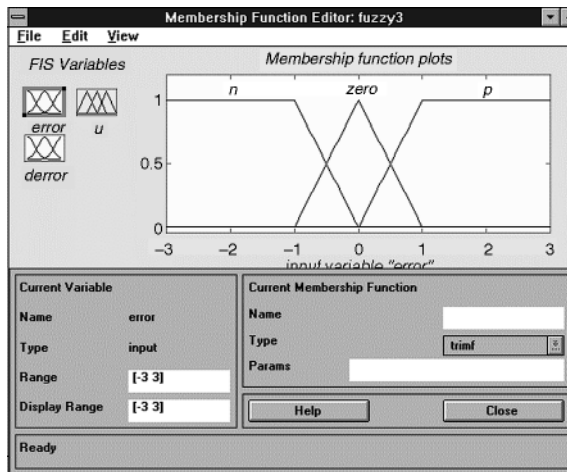

FIGURE 33.17 Membership function associated to the inputs.

For this fuzzy controller there were chosen nine inference rules, which could be visualized using the Inference Rules Editor of SIMULINK. Several simulation results of electrohydraulic axes obtained with the proposed fuzzy controller are shown in Figs. 33.18 and 33.19 and depict graphically the position and the velocity of the cylinder.

33.6 Neural Techniques Used to Control the Electrohydraulic Axis

Section 33.6 has as its goals: to emphasize MATLAB's possibilities of using its resources in order to design control systems based on advanced control techniques such as neural networks; to test through simulation these neural algorithms; and to verify performances of the neural control architecture applied to the studied electrohydraulic axis.

There are two main research directions involved in the neural control. One of these implies the developing of one controller going from a neural network, and the other one embeds several controllers

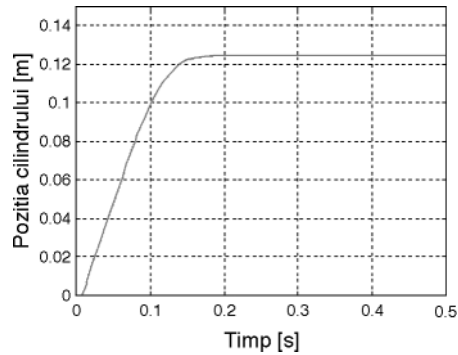

FIGURE 33.18 LHM position.

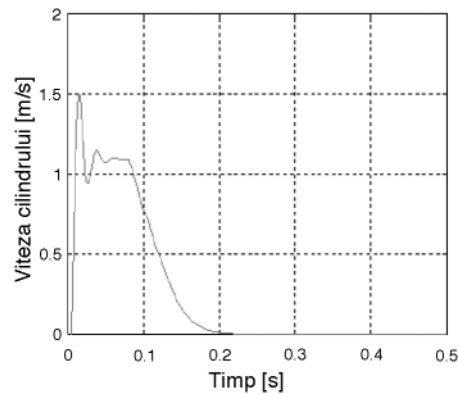

FIGURE 33.19 LHM velocity.

inside a neural network [50]. This section deals with the control of an electrohydraulic axis using a neural controller that has a widely spread structure, namely, multilayer perceptron (MLP).

Neural Control Techniques

Learning Based on Mimic

Inspired from biological systems, learning by mimic is applied to control systems. A supervised neural network can mimic the behavior of another system. A first method to develop a neural controller is to replicate a human controller. The neural controller tries to behave like the human operator. Neural training means learning the correspondence between the information received by the human operator and the control input (Fig. 33.20).

Inverse Learning

The purpose of inverse control is to control a system by using its inverse dynamic. In this case, the neural network receives the output of the system as input and has the input of the system as output. The system works in open loop and has to be in the region where the controller will operate. Inverse learning (Fig. 33.21) is an indirect approach to minimize the network output error instead of the overall system error.

Specialized Inverse Learning

According to Psaltis, who proposed in 1988 a *specialized inverse learning*, the neural network should be trained online in order to minimize the control error $e_y = r - y$ (see Fig. 33.22).

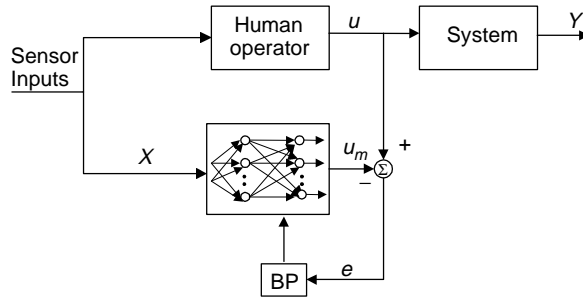

FIGURE 33.20 Diagram for learning based on mimic.

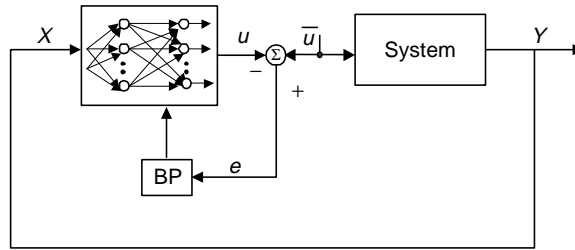

FIGURE 33.21 Training phase at inverse learning.

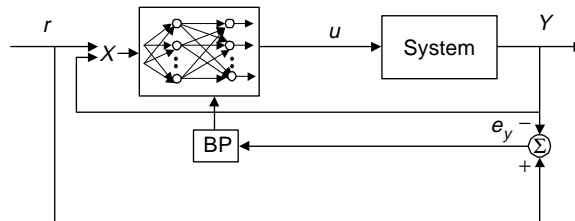

FIGURE 33.22 Specialized inverse control architecture (after [50]).

The neural controller used to control the position of an electrohydraulic axis is a *feed-forward* multi-layer neural network, whose learning algorithm is *back-propagation*. In order to adapt the weights which preserve the learned information, two steps are gone through with: a *forward* propagation procedure of the useful signal and a *backward* propagation of the error. The control structure is implemented in SIMULINK as it is shown in Fig. 33.23. The neural control of the electrohydraulic axis and the achievement of controller parameters are performed online.

A neural network with four layers, having two neurons on the first layer, a neuron on the last layer, and five neurons on each hidden layer, is proposed. The graphic characteristic corresponding to the axis position and obtained using the neural network described above is illustrated in Fig. 33.24.

33.7 Neuro-Fuzzy Techniques Used to Control the Electrohydraulic Axis

This chapter deals with several computer-aided design techniques of hybrid control algorithms. This paper concentrates on these types of algorithms, because the performances achieved through simulation of an electrohydraulic axis with a neuro-fuzzy controller are comparable or superior to those yielded by other control algorithms. Taking into account the novelty of neuro-fuzzy algorithms and the absence in

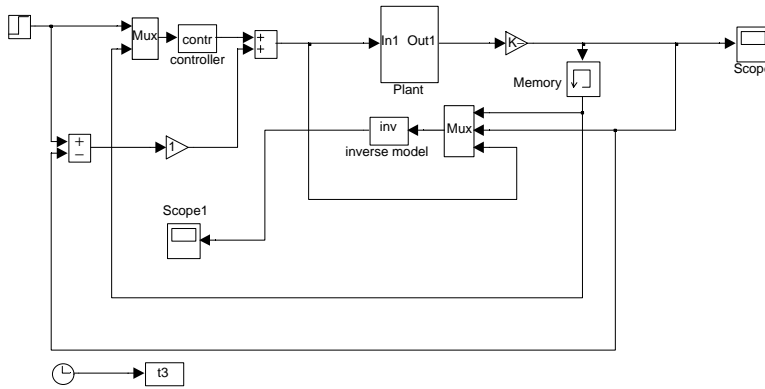

FIGURE 33.23 The control structure for proposed controllers.

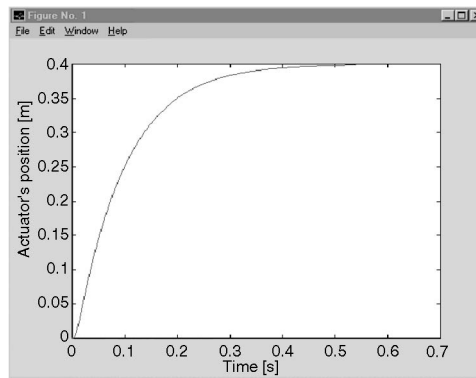

FIGURE 33.24 The axis position for $U = 8$ V input voltage.

SIMULINK of a toolbox devoted to them, the research was oriented to the achievement of a library of C++ programs, which can afford the use of SIMULINK in the design of such controllers. Thus, online adaptation procedures of fuzzy controller parameters are implemented. The comparative study of different classic and advanced algorithms is performed on the basis of integral squared error computed on the transitory horizon.

Because of the capability of fuzzy systems to treat imprecise information, they are strongly recommended in order to express knowledge in the form of linguistic rules. In this way, the human operator's knowledge, which is linguistic or numerical, is used to generate the set of fuzzy if-then rules as a basis for a fuzzy controller. A main drawback of fuzzy systems is the difficulty to design them based on a systematic methodology. To overcome this drawback, the learning procedures from neural networks are successfully applied in order to tune the parameters of membership functions. The merger of neural networks and fuzzy logic has led to the existence of neuro-fuzzy controllers. It can be asserted that neuro-fuzzy controllers embed essential features of both fuzzy systems and neural networks.

The proposed neuro-fuzzy controller has a structure based on the Takagi-Sugeno method and it is depicted in Fig. 33.25.

A learning procedure in fact represents a parameter estimation problem. The learning procedure for the proposed neuro-fuzzy controller is gradient-descendent. The method applied to design such a controller is called inverse learning in which an online technique is used to model the inverse dynamics of the plant. The obtained neuro-fuzzy model—the inverse dynamics of the plant—is used to generate control actions.

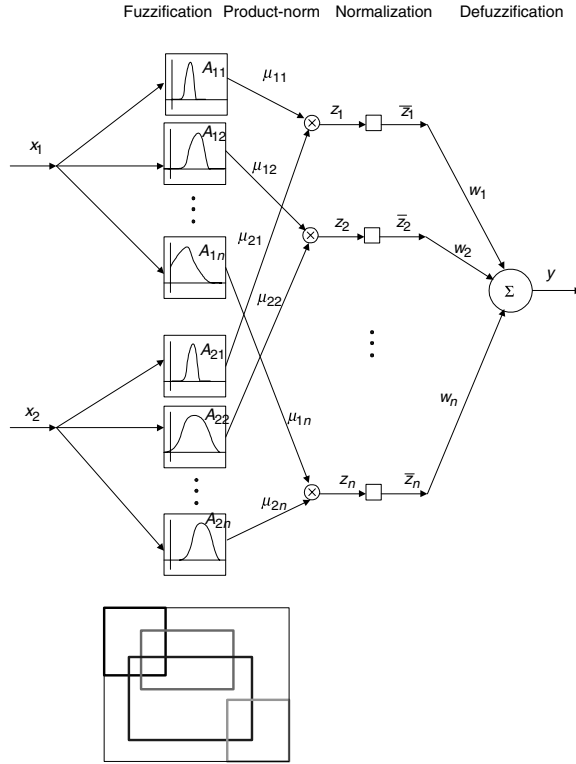

FIGURE 33.25 Structure of the neuro-fuzzy controller.

The neuro-fuzzy controller is a multilayer connectionist system, a multi-input and single-output fuzzy logic system. The network has three layers: one input layer with $n \times m$ units, one hidden layer with n units, and one output layer with one unit [15]. The partition used for this model is a scatter partition [33].

Figure 33.25 presents a particular case where the fuzzy controller has only two inputs and one output. In a general case, the fuzzy controller has m inputs and one output.

The fuzzy rule base contains a set of n linguistic rules in the form:

R_i : If x_1 is A_{1i} and x_2 is A_{2i}
 and...
 and x_m is A_{mi}
 then y is w_i , $i = 1, 2, \dots, n$

where i is the index of the rule; A_{ji} is a fuzzy set for the j th linguistic variable and the i th rule; and w_i is a number that represents the consequent part.

The membership functions assigned to each input are Gaussian functions. The centers of the membership functions are chosen such that these functions are uniformly distributed over the universe of discourse:

$$\mu_{ji} = e^{-\frac{(x_j - a_{ji})^2}{2b_{ji}^2}} \quad (33.26)$$

The fuzzy inference involved in this neuro-fuzzy controller is the product operator T-norm defined as an *and* conjunction. The firing strength of every rule is

$$z_i = \mu_{1i} \cdot \mu_{2i} \cdot \dots \cdot \mu_{mi}, \quad i = 1, \dots, n \quad (33.27)$$

The output is a crisp value obtained as a result of the evaluation of a center of gravity:

$$y = \frac{\sum_{i=1}^n z_i \cdot w_i}{\sum_{i=1}^n z_i} = \frac{z_1}{\sum_{i=1}^n z_i} \cdot w_1 + \frac{z_2}{\sum_{i=1}^n z_i} \cdot w_2 + \dots + \frac{z_n}{\sum_{i=1}^n z_i} \cdot w_n = \sum_{i=1}^n \tilde{z}_i \cdot w_i \quad (33.28)$$

The parameters to be estimated are obtained by finding the minimum of the following cost function:

$$J(k) = \frac{1}{2} \cdot (y(k) - y_d(k))^2 \quad (33.29)$$

where $y_d(k)$ is the desired output and $y(k)$ is the obtained response at time k .

To minimize this cost function, the stochastic approximation method is used. The learning procedure means the estimation of parameters and is based on the least-mean square algorithm. The parameters to be estimated are

$$p = (a_{11}, \dots, a_{nm}, b_{11}, \dots, b_{nm}, w_1, \dots, w_n) \quad (33.30)$$

The equations to adapt the parameters are the following:

$$\begin{aligned} a_{ji}(t+1) &= a_{ji}(t) - \lambda_a \frac{z_i}{\sum_{l=1}^n z_l} \cdot (y - y_d) \cdot (w_i - y) \cdot \frac{x_j - a_{ji}(t)}{b_{ji}^2} \\ b_{ji}(t+1) &= b_{ji}(t) - \lambda_b \frac{z_i}{\sum_{l=1}^n z_l} \cdot (y - y_d) \cdot (w_i - y) \cdot \frac{(x_j - a_{ji}(t))^2}{b_{ji}^3} \\ w_i(t+1) &= w_i(t) - \lambda_w \frac{z_i}{\sum_{l=1}^n z_l} \cdot (y - y_d) \end{aligned} \quad (33.31)$$

where the learning factors $\lambda_a, \lambda_b, \lambda_w$ are predefined.

In the learning process, parameters that could be modified are (a_{ij}, b_{ij}) which describe Gaussian functions, and w_j , the conclusion values. If the structure of the membership function is established, the only values that could be modified are w_j .

Control Structure

In order to design the neuro-fuzzy controller proposed above, the inverse learning method is applied. The control of an electrohydraulic axis involves the use of an online technique to model the inverse dynamics of the plant. The block diagram for online inverse learning is presented in Fig. 33.26.

This scheme is in open loop and it is also found by the Controller Output Error Method (COEM) [1] to online tune or adapt the parameters of a fuzzy controller. This method does not require the plant output error to be propagated at the input. There is another constraint, namely the controller has to be capable of stabilizing the plant before the commencement of tuning. To avoid this requirement, a modified COEM (MCOEM) [2] is used. The diagram block in this case is depicted in Fig. 33.27.

A proportional feedback controller P is introduced and in this situation the plant input is the sum of $u'(k)$ and $u_p(k)$. The consequent singletons are initialized to zero and the controller P is chosen in such a way that it stabilizes the plant. The structure and the parameters of inverse model and of neuro-fuzzy controller are identical.

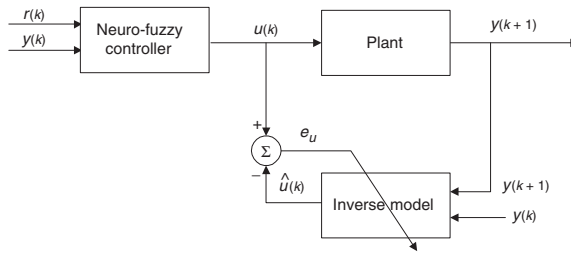

FIGURE 33.26 Diagram of control based on inverse learning.

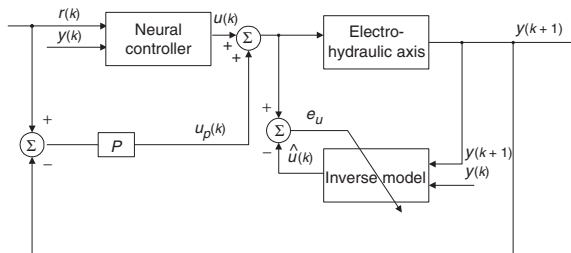

FIGURE 33.27 Block diagram for inverse learning with proportional controller.

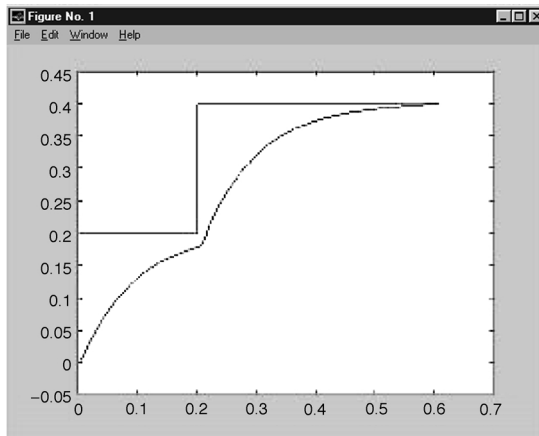

FIGURE 33.28 The position control with neuro-fuzzy controller.

There are two phases in the design of such a controller: the control and the adaptation. In the control phase, the plant output and the reference signal determine a control command $u(k)$. The plant input becomes $u(k)$, the sum of the $u(k)$ and $u_p(k)$. In the adaptation phase, the inverse model, which has inputs $y(k+1)$ and $y(k)$, produces the signal $\hat{u}(k)$ as an output. This signal is used to compute the error $e_u(k)$, which determines the value of the cost function $J(k)$ that has to be minimized.

$$J(k) = \frac{1}{2} \cdot e_u^2(k) = \frac{1}{2} \cdot (u(k) - \hat{u}(k))^2 \quad (33.32)$$

This procedure was used at the control of the electrohydraulic axis position, where the controller parameters are determined online. The actuator position obtained when the reference signal is changed from $U = 4 \text{ V}$ to $U = 8 \text{ V}$ is depicted in Fig. 33.28.

TABLE 33.1

| Regulator | IAE | ISE |
|-------------------------|--------|--------|
| PID (chapter 4) | 0.8042 | 3.4754 |
| PI (chapter 4) | 0.8006 | 3.4618 |
| PD (chapter 4) | 0.7928 | 3.4537 |
| Neural (chapter 6) | 0.8027 | 3.4622 |
| Neuro-fuzzy (chapter 7) | 0.7911 | 3.4501 |

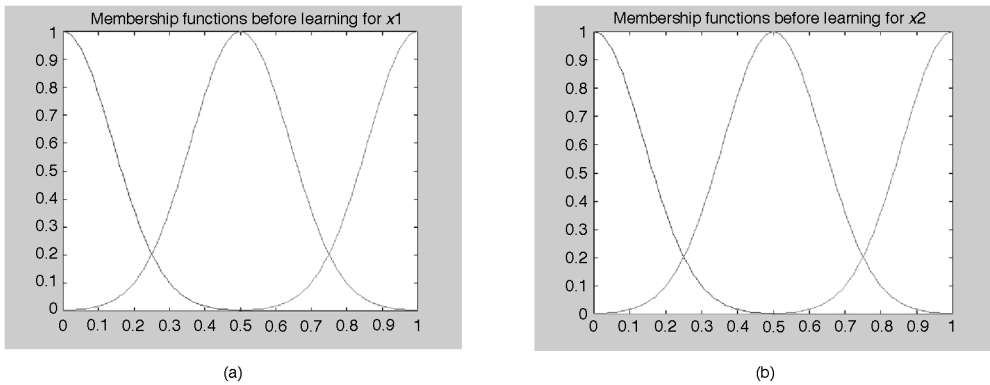

FIGURE 33.29 (a) Membership functions before learning for the variable x_1 , (b) Membership functions before learning for the variable x_2 .

In order to achieve a comparison of the modern control algorithms (included in this thesis) to the conventional structures, two spread integral criteria, namely, the integral of absolute error (IAE) performance index and the integral of squared error (ISE), are used. The results obtained applying these criteria are included in [Table 33.1](#).

According to previous results, it can be inferred that the described neuro-fuzzy controller exhibits superior performances compared to those obtained with the neural controller based on MLP, or with the classic controllers (PID, PI, PD with filtering) presented in this paper. The simulation results emphasize the neuro-fuzzy controller, arguing that it represents a very useful tool for practical applications with many nonlinearities.

Optimized results were obtained through variation of data sets and number of iterations. In order to test the performance of the proposed neuro-fuzzy controller, one nonlinear function given by an analytical equation was approximated. The membership functions of input variables x_1 and x_2 before learning are shown in [Figs. 33.29\(a,b\)](#). The surface obtained after simulation is depicted in [Fig. 33.30\(c\)](#). One may observe the accuracy of the reconstruction after 300 learning iterations by comparison with the surface to be obtained.

Sets of intermediary results obtained with different simulation data sets are presented below. Different data sets of simulations were used in order to achieve optimized results. Some of them are presented in [Figs. 33.30–33.34](#) without comment.

In order to obtain good performances from the model, 10 membership functions are used for each input variable. The learning factors λ_u , λ_b , λ_w were chosen as 0.01. The control algorithm is capable of handling the change in operating range. The results of the electrohydraulic axis simulation with the proposed neuro-fuzzy controller are obtained for various inputs. Those in time domain, results presented in [Figs. 33.35\(a,b\)](#), correspond to input voltages of 8 and 10 V.

1st set: $g_w = 0.1$; $g_a = 0.05$; $g_b = 0.05$; $nepoc = 100$; $nesant = 100$; $niter = 200$; $threshold\ error = 0.001$; $V_{max} = 0.04$.

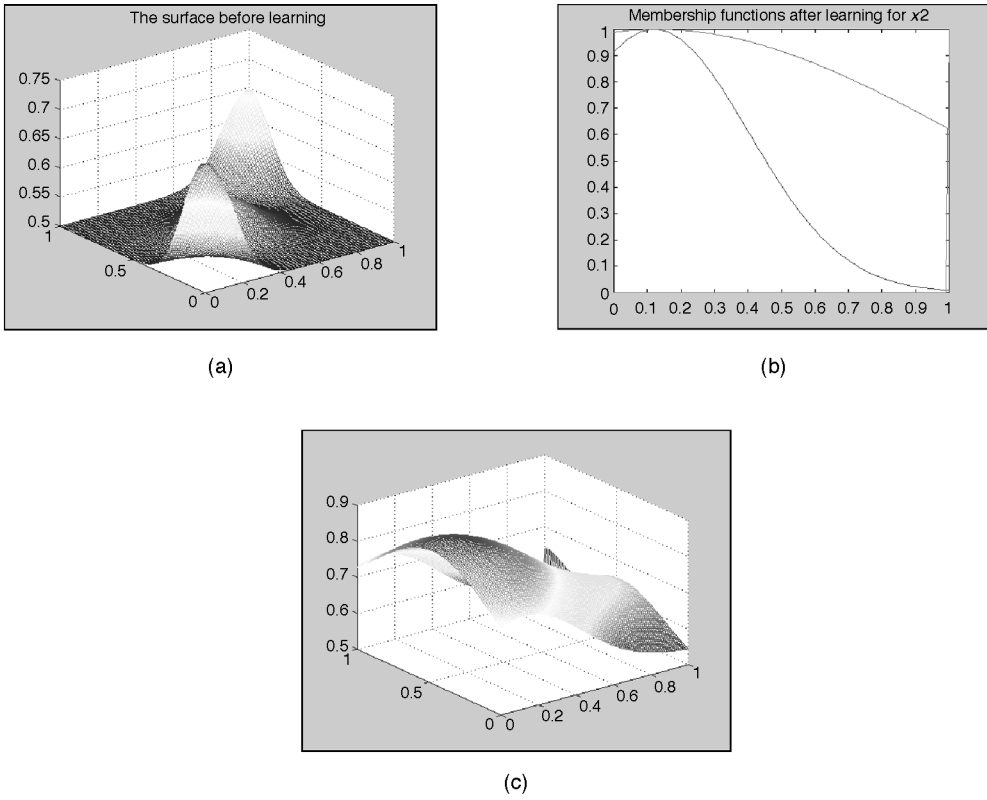

FIGURE 33.30 (a) The surface obtained after the first iteration, (b) Membership functions after learning for the variable x_2 , (c) The surface obtained after simulation.

2nd set: $g_w = 0.1$; $g_a = 0.07$; $g_b = 0.05$; $nepoc = 100$; $nesant = 21$; $niter = 200$; $threshold\ error = 0.001$; $V_{max} = 0.0475$.

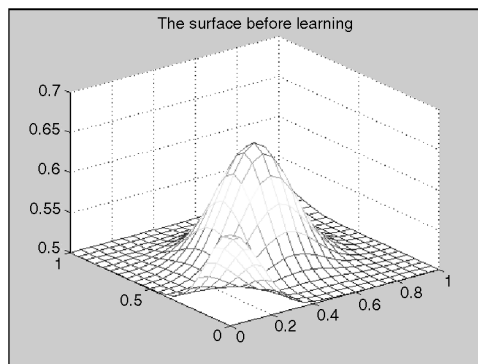

FIGURE 33.31 The surface obtained after the first iteration.

3rd set: $g_w = 0.5$; $g_a = 0.07$; $g_b = 0.03$; $nepoc = 200$; $nesant = 21$; $niter = 200$; $threshold\ error = 0.001$; $V_{max} = 0.047515$.

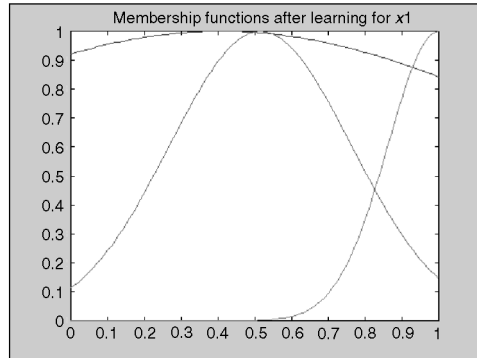

FIGURE 33.32 Membership functions after learning for the variable x_2 .

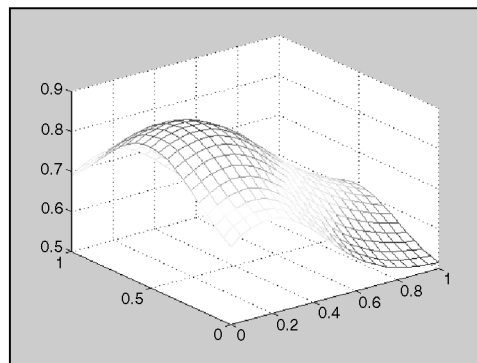

FIGURE 33.33 The surface obtained after learning.

33.8 Software Considerations

The MM of electrohydraulic axis studied in this thesis is supported by a physical installation existing in the mechatronics laboratory of UAS-Konstanz (see Fig. 33.1b). Two variants of nonlinear MM are set forth in Section 33.3 and add in static and dynamic nonlinearities that arise in the function of electrohydraulic axis [23, 58].

The MM of hydraulic drive presented in the structure of ROBI_3 was implemented in SIMULINK in order to study the dynamic behavior of the axis [26, 27]. The extended variant of MM hydraulic axis was done taking into account the relative motion of the constituent parts of this servodrive.

The neural and neuro-fuzzy controller (Takagi-Sugeno) was developed in Borland C++ and implemented in SIMULINK for controlling the electrohydraulic axis. SIMULINK offers the user a FUZZY LOGIC library that allows the designing and modeling of SUGENO or MAMDANI fuzzy inference systems. The lack of a dedicated software to design neuro-fuzzy controllers persuaded the implementation of such a controller in C++ and afterwards the use of it in SIMULINK [26,27,28].

The support for simulation, SIMULINK 2.1 and MATLAB 5.2 (under Windows), offers solutions to implement our controllers as modules and corresponding icon in a specialized toolbox. In our experiments, we used the facility offered by S-functions and C MEX in conjunction with Borland C++ 5.0 to compile them. We have chosen the C S-function because of the speed necessary to process the information in our block that implement the controller. The block that implements the controller has two inputs (even three inputs are available, though the adaptation process is more complicated) and one output.

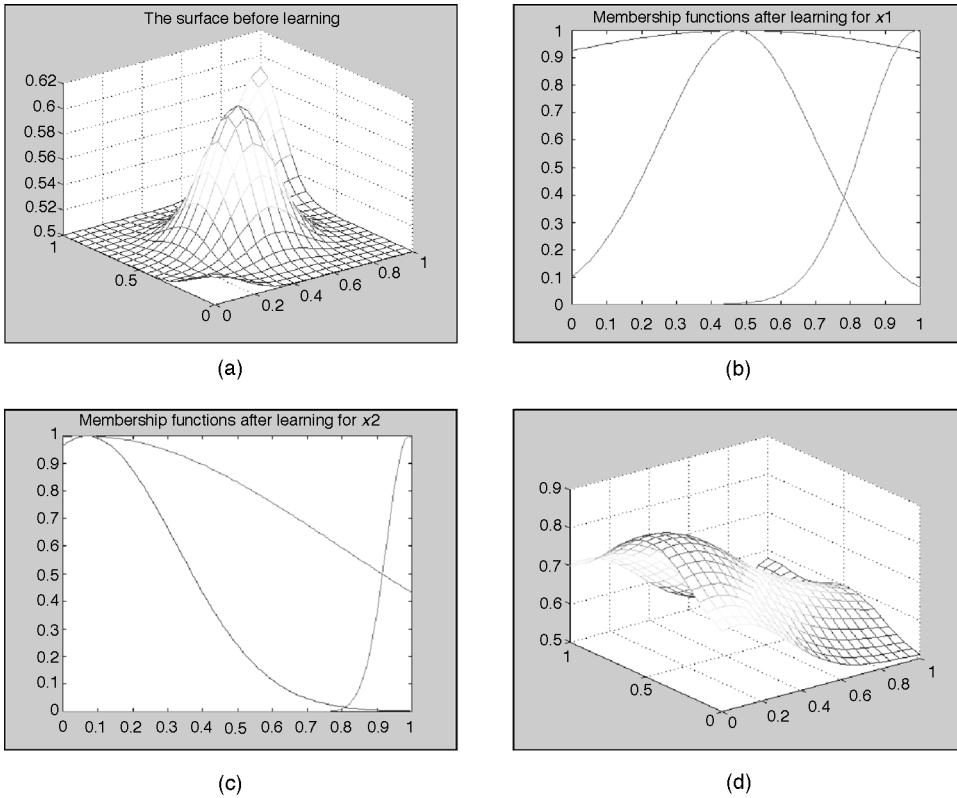

FIGURE 33.34 (a) The surface obtained after first iteration, (b) Membership functions after learning for the variable x_1 , (c) Membership functions after learning for the variable x_2 , (d) The surface after learning.

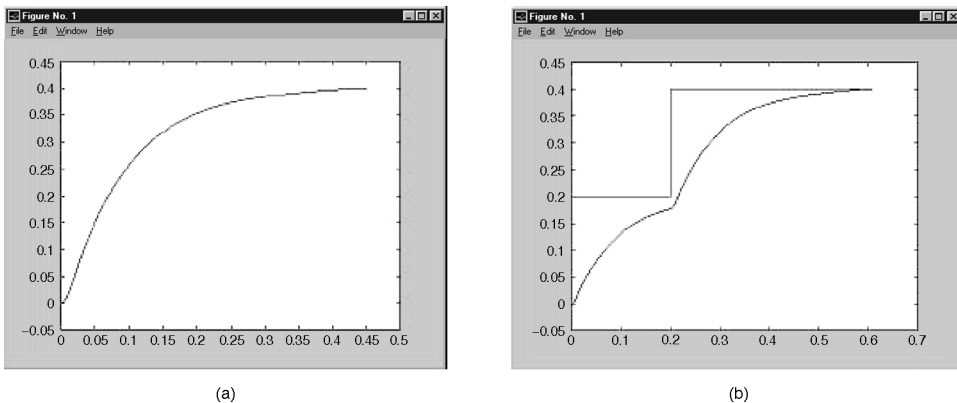

FIGURE 33.35 (a) The position control with neuro-fuzzy controller ($U = 8$ V), (b) The position control with neuro-fuzzy controller ($U = 10$ V).

The adapting parameters (weights, centers, and spread for Gaussian function) must be persistent. Declaring global, static or using the workspace in order to store the are useful techniques to accomplish the task.

The newest version of Simulink offers the possibility to write wrapper S-function, to use the callbacks functions, and as an alternative ADA or Fortran programming language.

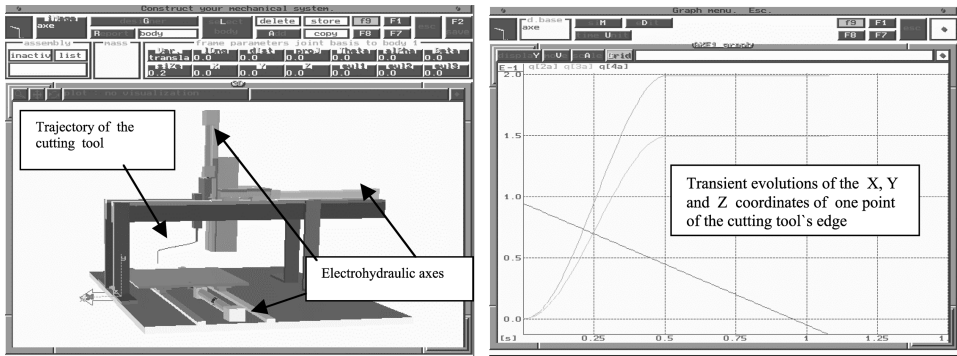

FIGURE 33.36 3-Axes Cartesian robot modeled, controlled, and simulated in SDS [21,24].

33.9 Conclusions

The research achieved as part of this chapter has, as an essential purpose, the development of improved control structure based on advanced techniques (neural and fuzzy), in relation to the conventional one. The studied electrohydraulic axis is a component of the Cartesian robot ROBI_3 implemented in the mechatronics laboratory of UAS-Constance. 3D-simulations with direct and inverse dynamics and implemented controllers by using the SDS-Modelling and Simulation software of the real installation were performed [21,23,25,28]. Model and simulation results are presented in Fig. 33.36.

As an overview, Section 33.1 deals with the introduction of this chapter. In Section 33.2, the most important aspects of electrohydraulic system control and of nonlinearities that arise with this type of installation are pointed out. The robot, ROBI_3, is presented from both a component and control perspective.

The mathematical model (MM) of ROBI_3's hydraulic axis is described in Section 33.3. The nonlinear MM is achieved based upon technical data of different components of installation and also taking into account theoretic assessments of electrohydraulic installation functionality. Simulation results of non-linear MM placed into a position loop are obtained with simulation environment SIMULINK/MATLAB. As a general remark, it should be mentioned that all simulations included in this chapter are achieved by using MATLAB/SIMULINK, while the advanced control algorithms (neural and neuro-fuzzy) are developed in Borland C++ 5.0.

Section 33.4 contains a short overview of the theory devoted to conventional controllers PID, PD, PI, and observer, followed by simulation results of the electrohydraulic axis endowed with the above control structures.

Following the scientific goal of this contribution, Section 33.5 reviews fuzzy system theory and presents simulations of electrohydraulic axis with fuzzy controllers. Fuzzy system theory has contributed greatly to system modeling, and the development of a theoretical frame appropriate to implement the qualitative reasoning specific to human beings. This kind of reasoning is very useful to model complex systems, which are characterized by nonlinearities or imprecise information. Simulation results of hydraulic axis are obtained using SUGENO and MAMDANI fuzzy controllers.

A short introduction of neural networks theory, the most widespread neural structures and also neural control techniques are presented in the beginning of Section 33.6. Neural networks work quantitatively, numerically. If fuzzy logic has an inference based on uncertainty, then neural networks learn by training, at the end of which the network will approximate a desired function. The analysis of trained NN involves many challenges, and as a result, the rules are usually not extracted from trained NN. Simulation results included in Section 33.6 are obtained with a multilayer NN.

Neuro-fuzzy systems preserve the characteristics of NN and also of fuzzy systems, and have been used successfully in control in recent years. Section 33.7 is devoted to the neuro-fuzzy system theory, to the presentation of neuro-fuzzy controller implemented in Borland C++ and applied in SIMULINK to

electrohydraulic axis, to the simulation results achieved in this case, and to the comparative study of conventional and modern controllers.

Section 33.8 contains a concise presentation of this chapter, the main contributions to the subject area presented, as well as a listing of perspective areas of interest in order to pursue further research in this direction.

Without intending to confine the parameters of this chapter, following is a listing of possible research directions and development perspectives that may be followed in future research endeavors:

- applying various controllers implemented in SIMULINK not only to control the electrohydraulic axis discussed, but also for systems with very complex structure which are involved in large hydraulic installations, offering the user a neuro-fuzzy controller's library;
- the hardware implementation of described neuro-fuzzy controller;
- continued research in the development of an optimal controller, systemically based (through the further study of stability utilizing linear matrix inequalities—LMI);
- the integration of presented controllers in software packages dedicated to hydraulic and pneumatic fields (for instance in HYPAS[23], DSH, etc.);
- the development of controller design in order to promote those controllers, which allow a better symbiosis between classical and advanced methods (neuro-fuzzy, genetic algorithms);
- the extension of preoccupations and extrapolation of research results regarding control of velocity, acceleration, pressure, flow, force, moment, and power.

References

1. Andersen, H.C., Lotfi, A., Tsoi, A.C. A new approach to adaptive fuzzy control: the controller output error method, *IEEE Trans. on Systems, Man, and Cybernetics*, SMC-27-B(4), August 1997.
2. Abonyi, J., Nagy, L., Szeifert, F. Indirect adaptive Sugeno fuzzy control, *Proceedings in Artificial Intelligence*, FNS'98, München, Germany, 19–20 martie.
3. Backé, W. *Systematik der hydraulischen Widerstandsschaltungen in Ventilen und Regelkreisen*. Krauskopf-Verlag, Mainz, 1974.
4. Costa Branco, P.J., Dente, J.A. *Inverse-Model Compensation Using Fuzzy Modeling and Fuzzy Learning Schemes*. Intelligent Engineering Systems through Artificial Neural Networks, Smart Engineering Systems: Fuzzy Logic and Evolutionary Programming, Ed. C.H. Dagli, M. Akay et al. Vol. 6, ASME Press, New York, pp. 237–242, 1996.
5. Brown, M., Harris, C. *Neuro-fuzzy Adaptive Modelling and Control*, Prentice-Hall, Englewood Cliffs, NJ, 1994.
6. Catana, I., Vasiliu, D., Vasiliu, N. *Servomecanisme electrohidraulice. Constructie, functionare, modelare, simulare si proiectare asistata de calculator*. U.P.B. Bucuresti, 1995.
7. Cybenko, G. *Mathematical Problems in Neural Computing*. Signal Processing Scattering and Operator Theory and Numerical Processing, Vol. 3, Kashoek, M.A., van Schupper, J.H., Ram, A.C. Ed., 1989, pp. 47–64.
8. Driankov, D., Hellendoorn, H., Reinfrank, M. *An Introduction to Fuzzy Control*. Springer-Verlag, Berlin, 1993.
9. Dubois, D., Prade, H., Ughetto, L. Checking the coherence and redundancy of fuzzy knowledge bases, *IEEE Trans. on Fuzzy Systems*, 5(5):398–417, 1997.
10. Dumitrache, I. sa. *Automatizari electronice*. Editura Didactica si Pedagogica, Bucuresti, 1993.
11. Dumitrache, I., Catana, I., Militaru, A. *Fuzzy Controller for Hydraulic Servosystems*. IFAC International Workshop on Trends in H& P Components & Systems, Chicago, IL, 1994.
12. Föllinger, O. *Regelungstechnik*. Dr. A. Hüting Verlag, Heidelberg, Germany, 1978.
13. Friedrich, A. *Logik und Fuzzy-Logik*. Expert-Verlag, 1997.

14. Ghaoui, L. El. Reduced-order multimodel control using linear matrix inequalities: sufficient conditions, *Proc. Od ACC 1993*, 1993, pp. 633–634.
15. Godjevac, J., Steele, N. Adaptive neuro-fuzzy controller for navigation of mobile robot, *International Symposium on Neuro-Fuzzy Systems AT'96*, Conf. Report, EPFL-Lausanne, 1996.
16. Gupta, M.M. *Fuzzy Logic and Neural Networks*, Proc. of the 2nd International Conference on Fuzzy Logic & Neural networks, Iizuka, Japan, 17–22 July, 1992, pp. 187–188.
17. Healey, M. *Principles of Automatic Control*. The English Universities Press Ltd., 1975.
18. Haykin, S. *Neural Networks*, MacMillan College Publishing Company, New York, 1994.
19. Ionescu, Fl. Computer aided design of hydraulic and electrohydraulic drive installations, *Proceed. 9th Triennial World IFAC Congress*, Budapest, Ungaria, Pergamon Press, Vol. 1, 1984, pp. 569–574.
20. Ionescu, Fl., Stoffel, B. *Contribution to the Automatic Generation of Mathematical Models for the Computer Assisted Analysis and Synthesis of Hydraulic Drive Systems*. Proceed. of the 2nd Intern. Conf. on Fluid Power, 19–21 March 1991, Tampere, Finland, pp. 469–482.
21. Ionescu, Fl., Haszler, Fl. *TORCH: A Control Software for Electrohydraulic Cartesian Robots*. Proceed. of the 6th Intern. IMEKO Symposium on Measurement and Control in Robotics, ICMR'96, Bruxelles, Belgium, 9–11 May, 1996, pp. 484–489.
22. Ionescu, Fl. *Non-Linear Problems in the Hydraulic Drive Systems*. 2nd World Congress of Nonlinear Analysts, Athena, Greece, 10–17 July 1996, Pergamon Press, Vol. 30, part 3, pp. 1447–1461.
23. Ionescu, Fl., Vlad, C.I. Tools of HYPAS for the control of electrohydraulic drive installations, *Proc. of 7th Symposium on Computer Aided Control Systems Design*, Gent, Belgia, 1997, pp. 311–316.
24. Ionescu, Fl., Borangiu, Th., Vlad, C.I. High integrated CAD strategies for control design of electrohydraulic systems, *Proc. 3rd IFAC Conference SSC*, Bucharest, 1997, pp. 390–395.
25. Ionescu, Fl., Vlad, C.I. *Hypas tools for the control of electro-hydraulic drive installations Journal a*, Vol. 38, No. 3, Belgium, 1997, pp. 38–41.
26. Ionescu, Fl., Vlad, C.I. Sugeno and hypas fuzzy-control solutions for electro-hydraulic drive installations, *Proceedings EUFIT'97*, Aachen, Germany, 8–11 Sept., Vol. 2, 1997, pp. 1238–1242.
27. Ionescu, Fl., Vlad, C.I., Arotaritei, D. Fuzzy and neuro-fuzzy HYPAS controllers implemented for an electro-hydraulic axis, *International ICSC Symposium on Engineering of Intelligent Systems EIS'98*, Tenerife, Spain, Feb. 11–13, 1998.
28. Ionescu, Fl., Arotaritei, D., Vlad, C.I. *Modelling of Nonlinearities, Signal Reconstruction and Predictive Solutions Applied in Mechatronics Systems by Using Neuro-Fuzzy Systems*, Internal Report, Department of Mechatronics, FH-University of Applied Sciences-Konstanz, 1998.
29. Ionescu, V., Varga, A. *Teoria Sistemelor. Sinteza robusta. Metode numerice de calcul*. Editura ALL, Bucuresti, 1995.
30. Isermann, R. *Digitale Regelsysteme*, Springer-Verlag, Berlin, 1987.
31. Isermann, R. *Zur Anwendung der Fuzzy-Logik in der Regelungstechnik*. Automatisierungstechnische Praxis (atp) Fuzzy-Control, 38, Oldenbourg Verlag, Germany, 1996.
32. Isermann, R. On fuzzy logic application for automatic control, supervision, and fault diagnosis, *IEEE Transactions on Systems, Man, and Cybernetics—Part A: Systems and Humans*, Vol. 28, No. 2, March 1998, pp. 221–235.
33. Jang, J.-S.R., Sun, C.-T., Mizutani, E. Neuro-fuzzy and soft computing, *A Computational Approach to Learning and Machine Intelligence*, Prentice-Hall, Englewood Cliffs, NJ, 1997.
34. Joh, J., Hong, S.K., Nam, Y., Chung, W.J. On the systematic design of Takagi-Sugeno fuzzy control systems, *International ICSC Symposium on Engineering of Intelligent Systems EIS'98*, Tenerife, Feb. 1998.
35. Kandel, E.R. *Nerves Cell and Behavior*, Principles of Neural Sciences, 3rd ed., 1992, pp. 18–36.
36. Knappe, H. Comparison of conventional and fuzzy-control of non-linear systems, In: Kruse, R., *Fuzzy Systems in Computer Science*, Verlag Vieweg, Wiesbaden, Germany, 1994.
37. Kokotovic, P.V. *Lectures Notes in Control and Information Sciences*. Springer-Verlag, Berlin, 1991.
38. Kosko, B. *Neural Networks and Fuzzy Systems*. Prentice-Hall, Englewood Cliffs, NJ, 1992.

39. Kovacic, Z., Balenovic, M., Bogdan, S. Sensitivity-based self-learning fuzzy logic for a servo-system, *IEEE Control Systems*, June, 1998.
40. Lippman, R. An introduction to computing with neural nets, *IEEE ASSPMagazine*, April 1987, pp. 4–22.
41. MATLAB 5.2. MathWorks Corp, USA. 1998.
42. Miller, Th., Sutton, R., Werbos, P.J. *Neural Networks for Control*, MIT Press, 1990.
43. Nauck, D., Klawonn, F., Kruse, R. *Neuronale Netze und Fuzzy-Systeme*. Grundlagen des Konnektionismus, Neuronaler Fuzzy-Systeme und der Kopplung mit wissensbasierten Methoden, Vieweg, 1994, Germany.
44. Nesterov, Y., Nemirovski, A. *Interior Point Polynomial Methods in Convex Programming: Theory and Applications*, SIAM, Philadelphia, 1994.
45. Pedrycz, W. *Fuzzy Control and Fuzzy Systems*, Wiley, New York, 2nd ed., 1993.
46. Piechnik, M., Feuser, A. *Simulation mit Komfort - HYVOS 4.0 und MOSIHS 1.0*, Ö & P, 38, 1994.
47. Postlethwaite, B.E. A model-based fuzzy controller, *Trans IChemE*, Vol. 72, Part A, Jan. 1994.
48. Postlethwaite, B.E. Building a model-based fuzzy controller, *Fuzzy Sets and Systems*, 79(1996), Elsevier.
49. Rehfeldt, K., Shöne, A., Büngener, N. *Einsatz von Fuzzy-Reglern zur Drehzahlregelung einer Hydraulikpumpe*, *Ölhydraulik und Pneumatic*, 36, Nr. 6, pp. 397–402, 1992.
50. Ronco, E., Gawthrop, P.J. *Neural Networks for Modelling and Control*. Technical Report: csc97008, Centre for System and Control, Dept. of Mechanical Engineering, Univ. of Glasgow, 10 Nov. 1997.
51. Simulink, Dynamic System Simulation for MATLAB, Writing S-functions, The Math Works Inc., 1998.
52. Sontag, E.D. Mathematical control theory, *Deterministic Finite Dimensional Systems*. Springer-Verlag, Berlin, 1990.
53. Takagi, T., Sugeno, M. Fuzzy identification of systems and its applications to modeling and control, *IEEE Trans. Systems, Man, and Cybernetics*, Vol SMC-15, No. 1, pp. 116–132, 1985.
54. Tanaka, K., Sugeno, M. Stability analysis and design of fuzzy control systems, *Fuzzy Sets and Systems*, Vol. 45, 1992, pp. 135–156.
55. Teodorescu, H.N. *Sisteme Fuzzy si Aplicatii*. Institutul Politehnic Iasi, Romania, 1989.
56. Tertisco, M., Penescu, C., Ionescu, G., Ceanga, E. *Identificarea Experimentala a Proceselor Automatizate*. Editura Tehnica, Bucuresti, 1971.
57. Viersma, T. J. *Analysis, Synthesis and Design of Hydraulic Servosystems and Pipelines*. Elsevier, Amsterdam-New York, 1980.
58. Vlad, C.I. Contributions to the Direct Computer Control of Electrohydraulic Axes for Industrial Robots. Technical University “Politehnica”, Bucharest, Romania, 1998.
59. Wang, L., Liu, G.P., Harris, C.J., Brown, M. *Advanced Adaptive Control*, Pergamon, 1997.
60. Werbos, B. *Overview of Design and Capabilities*. In *Neural Networks for Control*, pp. 59–65, MIT Press, MA, 1990.
61. Westcott, J.H. The minimum-moment-of-error-squared criterion: a new performance criterion for servo mechanisms, *Proc. of IEE.*, Measurements Section, pp. 471–480, 1954.
62. Yager, R., Zadeh, L. *Fuzzy Sets, Neural Networks and Soft Computing*, 1994.
63. Zadeh, Lotfi. *Fuzzy sets, Information & Control*, No. 8, pp. 338–353, 1965.
64. Zadeh, L., King-Sun Fu, Tanaka, K., Shimura, M. *Fuzzy Sets and their Applications to Cognitive and Decision Processes*. Academic Press, 1975.
65. Zimmermann, H.-J. *Fuzzy Sets Theory - and Its Applications*, Kluwer Academic Publishers, Dordrecht, The Netherlands, 1990.

34

Design Optimization of Mechatronic Systems

Tomas Brezina

Technical University of Brno

Ctirad Kratochvil

Technical University of Brno

Cestmir Ondrusek

Technical University of Brno

- 34.1 Introduction
- 34.2 Optimization Methods
 - Principles of Optimization • Parametric Optimization • General Aspects of the Optimization Process • Types of Optimization Methods • Selection of a Suitable Optimization Method
- 34.3 Optimum Design of Induction Motor (IM)
 - IM Design Introduction • Classical IM Design Evaluation • Description of a Solved Problem • Achieved Results
- 34.4 The Use of a Neuron Network for the Identification of the Parameters of a Mechanical Dynamic System
 - Practical Application

34.1 Introduction

Electromechanical systems form an integral part of mechanical and mechatronic systems. Their optimization is a necessary condition for a product to be competitive. In engineering practice, a large number of optimization and identification problems exist that could not be solved without the use of computers [5]. The present level of technological development is characterized by increasing the performance of machines with the production costs kept at a satisfactory level. The demands on the reliability and safety of operation of the designed machines are also considerable.

From practical experience we know that the dynamic properties of electromechanical systems have a considerable influence on their reliability and safety. On the other hand, the tendency to push the price of a machine down often leads to unfavorable dynamic properties that result in increased vibrations and noise during operation. Also, electrical properties dramatically deteriorate as the amount of active materials in a machine is reduced. The increased load leads to, among other things, excessive heat formation, which, in turn, has a negative effect on insulation, shortening the service life of a machine.

34.2 Optimization Methods

Principles of Optimization

The properties of electromechanical systems can be described mathematically using physical quantities. The degree of these properties is then described using mathematically formulated objective (preference) functions. Structural parameters ranging between limit values given as satisfying secondary conditions are the independent variables of these functions. The particular form of the functions depends on the type of machine and its mathematical description. The solutions of a mathematically formulated optimization

problem together with optimization methods allow a considerable number of different design variants of a machine to be calculated in a relatively short time. They also make it possible to perform these calculations at production planning stages for a prototype to possess the qualities given by a chosen criteria function. In this way, the design of a machine is not only analyzed but also modified and reconstructed in terms of its electromechanical properties with the aim to improve these properties as much as possible (or optimize them).

From a physical point of view, these are actually problems that, to a certain degree, are inverse to those of calculus. A problem of calculus assumes a fixed, mathematically described model of a real machine to be used for deriving its resulting properties. In problems of calculus, we define properties and try to find out which parameters of a chosen mathematical model possess those properties. In problems of parametric optimization, we look for those parameters that, by a chosen preference function, provide the best properties. It is clear that problems of synthesis and optimization are much more sophisticated than those of calculus.

Parametric Optimization

As the aim is to find the values of certain structural parameters of a machine, we shall deal with this notion in more detail. By a parametric optimization of electromechanical systems, we mean the process of finding those parameters of a mathematical description of the system (arranged in a vector \vec{p}) from a set P of admissible parameters at which a suitably selected objective (preference) function $\psi(p)$ of these parameters reaches its extreme.

The objective function $\psi(p)$ quantifies the degree of the properties of an electromagnetic system that has to be made extreme (the parameters with the best degree of this property have to be chosen). When defining an admissible set P , we are guided by the structural possibilities of changes in individual parameters (variables), or we can introduce secondary criteria of the type “the degree of properties may not exceed given critical limits.” The possibility of taking into consideration the structural changes of parameters leads to the so-called trivial (natural) constraints of the type $p_i^d \leq p_i \leq p_i^h$, where p_i^d is the lower and p_i^h the upper bound of the i th optimization variable. The introduction of secondary criteria leads to the definition of limiting functions q_i of optimization variables for which we have $q_i^d \leq q_i(p) \leq q_i^h$, where q_i^d is the lower and q_i^h is the upper bound of the relevant function.

Thus, from the mathematical point of view, parametric optimization of electromechanical systems is formulated as the problem of finding a point p in the admissible set P , at which the preference function ψ reaches its global extreme value (maximum or minimum) with regard to P . The admissible set is generally described by m inequalities defined by functions $q_j(p)$, where $j = 1, 2, \dots, m$. If $P = R^s$, where s is the number of variables to be optimized, we say that the optimization is unconditional. In all other cases we say that the optimization is conditional.

To solve the problem of optimizing the selected properties of a system, the following has to be done:

- a mathematical description has to be formulated,
- it has to be analyzed at the starting point,
- the desired form of the objective function ψ has to be specified,
- the optimization variables have to be selected,
- the desired form of the constraining functions q_j has to be specified,
- a suitable optimization method has to be selected,
- the resulting mathematically formulated optimization problem has to be solved, and
- using the mathematical model, the results have to be transformed back into the dynamic model (for dynamic problems only).

General Aspects of the Optimization Process

If the aim of an optimization process is to optimize several properties that simultaneously affect the system (such as minimizing the size values while respecting the electrical properties), we obtain a multi-criteria objective function. The objective function then takes the form of a weighted sum of single-criterion

functions. Each of these functions generally assumes its local minima at different points of the optimization parameter spaces. This is the reason why a multi-criteria function can have a large number of shallow local minima or is insensitive to changes in the optimization parameters. Due to this fact, the selection of an optimization method is of great importance. The result is averaged in the sense that several criteria may participate simultaneously in a reduction of the multi-criteria function, while some other criteria may increase.

A more suitable method may be to select a single-criterion objective function, including all criteria in the constraints. Only the most significant criterion is chosen for the objective function to be specified in the subsequent process. All other criteria included in the constraints are kept within specified limits without being optimized. Thus, the results of an optimization process are dependent on the degree of reduction of the admissible set given by the inequality-type constraints.

Generally, we specify the constraints in a form similar to the objective function

$$q_i(p) = f_i(p) - f_i^h, \quad i = 1, 2, \dots, m^* \quad (34.1)$$

Here f_i are suitable functions of a vector variable and f_i^h their maximum admissible values.

The selection of optimization variables is given by the sensitivity of the objective function to changes of relevant optimization variables. This sensitivity is described by the gradient vector of the objective function.

$$\text{grad } \psi(p) = \left[\frac{\delta\psi(p)}{\delta p_1}, \dots, \frac{\delta\psi(p)}{\delta p_s} \right]^T \quad (34.2)$$

Types of Optimization Methods

Standard Optimization Methods

Most practical problems lead to nonlinear (transcendental) systems of equations. These may only be solved using numerical optimization methods. According to the order of the derivatives used in the application of a method, numerical methods of finding local minima of functions of several variables may be divided into:

1. zero-order methods (comparative)
 - methods of co-ordinate comparison
 - simplex methods
 - stochastic methods
2. first-order methods (gradient and quasi-gradient)
 - methods of associated directions
 - variable-metric methods
3. second-order method (Newton method)

Stochastic Methods

These methods consist of calculating the values of the objective function at a large number of selected points. The points are selected by such criteria that each point in the space has an equal probability of being selected. The best points are then determined by comparing the function values. From the outlined strategy, it follows that these methods lead to computing the function values at a large number of points, which may protract the calculation. On the other hand, we can more easily reach the global optimum of the function to be optimized. These methods also comprise the evolution methods since the first solution population is generated completely by random. The difference only consists in the strategy of selecting better solutions.

Evolutional Optimization Methods

Since some problems are difficult to solve by standard numeric optimization methods, even if they converge to an acceptable optimum in a reasonable time, new approaches had to be developed. Therefore, a number of new methods have been designed based on the laws of natural genetics copying them in various degrees. These methods employ random generation of input parameters and so can be thought of as stochastic methods. In general, stochastic optimizing algorithms (including virtually all the evolutionary algorithms) optimize using multi-parameter function with “wild” behavior, that is, with many minima or with an unknown gradient. Stochastic optimization methods are necessarily slower than heuristic approaches, which take advantage of the fact that they know the type and details of the function to be optimized. Unless the conditions for the global optimum are previously known, we can never be sure whether we have reached the global optimum to be able to terminate the optimization process. However, stochastic optimization methods also bring numerous benefits. They are generally very well specified and thus applicable virtually to any problem, and they can get out of the trap of a local minimum. The evolutionary process of searching the space of potential solutions requires an equilibrium of two objectives:

- to find the nearest (mostly local) minimum as quickly as possible, and
- to search the space of all potential solutions in the optimum manner.

The methods differ in their orientation towards these two objectives and they can be roughly ordered in a sequence starting with methods tending to local minima to methods searching a large number of potential solutions:

1. Stochastic “hill climbing” algorithms,
2. Tabu search algorithms,
3. Simulated annealing algorithms, and
4. Genetic algorithms.

Hill Climbing Algorithm

This is the simplest optimization algorithm being a variant of the gradient method “without gradient” where the direction of the steepest climb is determined by searching the neighborhood. This algorithm also has all the drawbacks of gradient methods, in that it is very likely to end up in a local extreme without reaching the global minimum. Here the starting solution is generated at random. For the currently designed solution, a certain neighborhood is generated using a finite set of transformations and the best minimum is chosen from this neighborhood. The local solution obtained in this way is then used as the center of a new neighborhood in which the optimization is repeated. This process is iterated a specified number of times. In the course of this process the subsequent best solutions are recorded to be finally used as the resulting minimum. The basic drawback of this algorithm is that, after a number of iterations, it may revert to a local minimum that has already been passed in a previous step (the problem of looping). This problem can be avoided by running the algorithm several times with different randomly generated initial values to eventually choose the best result achieved.

Tabu Search Algorithm

At the end of the 1980s, Professor Fred Glover designed a new approach to solving the problem of finding the global minimum, which he called *tabu search*. At present, this method is among those used most frequently to solve combinatorial problems and problems of finding the global minimum. Based on the hill-climbing algorithm, it tries to eliminate the problem of looping. The hill-climbing algorithm is equipped with a so-called short-time memory, which, for a short previous interval of the algorithm history, remembers the inverse transformations to locally optimal solution transformations used to obtain the new centers in iterations. These inverse transformations are prohibited (tabu) when the new neighborhood is created for a given current solution. In this way, the looping caused by falling into the trap of a local minimum may substantially be reduced. A hill-climbing algorithm modified in this way systematically searches the entire area in which the global minimum of a function is to be found.

Simulated Annealing Algorithm

Apart from the stochastic methods and methods based on natural evolution, there is another possibility of simulating the evolution of systems based on the physical evolution of macroscopic systems. The annealing of a solid body in order to remove the internal stress is a simple example of this kind of evolution. For a physical interpretation of this process, consider a body that is heated until it reaches a high temperature. The temperature is then gradually lowered. The atoms of a body heated to a high temperature can easily overcome the local energetic barriers to reach equilibrium states. When the temperature is lowered, atoms are fixed in this state and the cooled off body is without internal stress.

This principle was used to design the method of simulated annealing. First, an initial temperature T_{\max} is set, whose value is important for the method to be efficient. The simulated annealing algorithm then searches the space of all potential solutions in a strongly stochastic way, also accepting the states that correspond to solutions worse than the current one. This property of simulated annealing is a characteristic feature of this method and provides a way of escaping from a local minimum trap, thus allowing the search of another area of the entire solution space. However, as the annealing temperature T is lowered, the probability of accepting worse states as well is diminishing. For small temperature values then, only solutions better than the current one are considered.

Genetic Algorithm (GA)

Genetic algorithms (GAs) are most frequently used to optimize the parameters of an unknown system whose mathematical description is either too complicated or unknown [5]. When applying a GA, it is mostly sufficient to know a function assigning a price to each individual in the population. This may be the error of the solution for randomly selected parameters during GA. Since a GA is looking for a maximum, the error, which, on the contrary, is being minimized, must be transformed into looking for a maximum. This may be done in several different ways: by subtracting the error from the maximum error occurring, by calculating the inverted value of the error, or by using another transforming function that approaches zero as the error approaches one. Increased attention should be paid to setting up the program implementing the pricing function since it consumes the most computing time compared with the other GA components.

Apart from general optimization problems, GAs are mostly applied to neural networks. Here the tendency is to employ GAs at two different levels. First, for finding suitable weights for a neural network and second, when optimizing the structure of a neural network, that is, when selecting the algorithm, the number of input neurons in the hidden layers, the number of hidden layers, etc. Using a genetic algorithm to optimize the parameters of another genetic algorithm (the size of the population, the number of crossbreedings, the extent of mutations, the frequency of mutations) is a very revolutionary idea (optimization of the computation time where the computation time is a pricing function of the GA). As far as applications of GAs to problems encountered in research of electric machines are concerned, GAs have been used to identify the parameters of the substitution diagram of an induction motor.

By way of conclusion, it may be added that genetic algorithms perform surprisingly well when all other algorithms fail, such as for incomplete problems where the computation time is an exponential or factorial function of the number of variables. There is no point in using GAs to optimize relatively simple functions or functions for which special algorithms exist for their description. Considering the necessity to calculate the function values for tens or hundreds of genetic chains in a population and the necessity to evaluate hundreds or even thousands of populations during a single run of the program, GAs are rather time-consuming.

Despite the positive results achieved by using GAs, it is clear that nature must use even more intricate and, at the same time, not very sophisticated methods. The GAs described above only correspond to very primitive examples observed in nature, particularly those related to asexual reproduction with a single chromosome. Since nature has taken billions of years to test its algorithms, it is highly efficient to further learn from it. It is interesting that it needs no mathematics to solve complicated problems of optimization. Nevertheless there are other optimization methods suitable to solve the problems of the design [2–4].

Selection of a Suitable Optimization Method

The standard gradient method is still one of the most frequently used methods. Gradient methods or even the standard non-gradient methods (such as the simplex method) are not suitable if the finding of the global minimum is required of a function with many local minima. Mostly, these methods only reach an insignificant minimum close to the starting point (the initial solution) in which they are trapped. This deficiency is mostly removed by repeatedly selecting at random the initial solution of an optimization problem and taking the best result for the solution. The stochastic character of this process can only be seen in the random selection of the initial solution. The subsequent optimization algorithm then proceeds without any randomness. Then the evolutionary optimization methods are thought of as stochastic ones despite their employing of a certain strategy when choosing the better points. The following are the main differences between a genetic algorithm and the more frequently used gradient method:

- GA performs no gradient computation, which might be difficult and time consuming particularly for large systems, and
- GA works with randomly generated solutions and may converge more quickly to the global minimum.

To optimize the draft design of an induction motor, an optimization method was employed using a genetic algorithm. This method is described in more detail in the following chapter.

34.3 Optimum Design of Induction Motor (IM)

IM Design Introduction

Actual design of an induction motor usually depends on the requirements of individual customers, who specifically define parameters which a designed machine should accomplish. In this way, with the same machine output, we can obtain different implementations that meet individual conditions more or less. It is possible to require a good quality of one parameter only with the deterioration of other parameters. We are going to deal with a design of motors of (0,6–200) kW outputs. Motors are designed for permanent load and with the project assignment the following input values are required:

Machine output P_n [kW], voltage U_{1n} [V], winding connection Y/D , number of poles $2p$ or rotation speed n [min^{-1}], grid frequency f [Hz], efficiency η [%], power factor $\cos \varphi$, insulation class, IP implementation, and the shape of the machine.

We consider squirrel-cage motors in closed implementation with framework and cooling ribs. There is a cast aluminum rotor cage. For the design, data such as conductors and slots dimension or magnetic characteristics deduced from tables and graphs that are given by the standard or by the manufacturer's measurement, are needed. The actual design is a compromise between individual design parameters, so that a resulting machine would have the best possible operating characteristics with a perfect heat and material utilization. The actual motor design is described in the following section.

Classical IM Design Evaluation

An induction motor design, when carried out manually, represents hundreds of calculations, which can last tens of hours even with an experienced constructor. As computers made their way into practically all branches of design and analysis, a series of programs which co-operate with a designer in an interactive fashion and speed up a calculation were created.

In spite of indisputable advantages of this design process, we have to realize that there is a remarkable quantity of various design implementations of the given motor which, more or less, achieve the required motor operating characteristics. This approximates the global minimum of an objective function, which evaluates the design quality.

Thus, the idea to create a program for searching the whole state space of all possible solutions and selecting such a variant, which is the most appropriate to an evaluating objective function (the required

TABLE 34.1 Generated Parameters List and Setup of Their Limits

| Parameter Name | Symbol | Dimension | High Limit | Low Limit |
|---------------------------------------|------------------|--------------------|---------------|---------------|
| Stator outside diameter | D_e | mm | User optional | User optional |
| Stator inside diameter | D | mm | User optional | User optional |
| Ideal iron length | l_i | mm | User optional | User optional |
| Air gap induction | $B\delta$ | T | 0.5 | 1.0 |
| Stator slot filling | k_{dri} | — | 0.6 | 0.75 (0.8) |
| Air gap size | δ | mm | 0.2 | 0.4 |
| Stator current density | σ_1 | A mm ⁻² | 3.0 | 15.0 |
| Rotor rod current density | σ_r | A mm ⁻² | 2.0 | 6.0 |
| Rotor ring current density | σ_k | A mm ⁻² | 2.0 | 4.0 |
| Teeth magnetic induction | B_z | T | 1.6 | 2.0 |
| Slot number per pole and stator phase | q_1 | — | 2.0 | 5.0 |

motor characteristics) using some of the optimization methods, was developed. The stochastic evolutionary method genetic algorithm was selected, because it searches the whole state space of all possible solution in a best way.

Description of a Solved Problem

Generated Parameters

The values given in Table 34.1 are recommended only, and, for the motors of outputs below 200 kW, they are mostly limiting values. Varying the parameter values or substituting one parameter for another is possible only by intervention in the program source text. Diameter limits D_e and D from the input file are considered only in the case that a motor design without regard to standardized axis height is required. In the case that standardized axis height is entered, these limits are calculated. Limits of an ideal rotor length are appropriate to enter as narrow as possible for faster convergence to a limit. But this is not a required condition. Generally, the lower the range of individual parameters, the faster the convergence to a global minimum, and the number of local minimums is lower.

Objective (Criterion) Function

It is not just the form of the objective function, but also the selection of optimized parameters that is important for good optimization results. Selected parameters must sufficiently describe a quality solution to the given problem. In the case of an induction motor design optimization task, the following parameters were selected:

| | |
|----------------------------|------------------------|
| Motor volume | V [dm ³] |
| Motor temperature rise | ϑ_n [K] |
| Motor nominal power factor | $\cos \varphi_n$ [—] |
| Motor nominal efficiency | η_n [—] |
| Torque overload capacity | m_{pn} [—] |

These parameters are most important for the quality of the design and describe the design sufficiently.

The total error is based on the relation given in Eq. (34.1), a sum of individual partial errors of each controlled parameter. If we put more emphasis on some parameter, we increase a corresponding weight coefficient, thus achieving its improvement in the final design. At the same time, values of other parameters will decrease. Finding an optimal setup of gain coefficients is one of the most important and difficult problems. The term “optimal setup” means that the designed motor has the highest power factor, efficiency, and torque overload capacity values at the minimal volume and simultaneously does not exceed a permitted temperature rise for a selected insulation class. We have the relationship

$$\begin{aligned} \varepsilon(\text{GR}_i) = & \text{abs}(kV \cdot V) + \text{abs}(k\vartheta(0.89\vartheta_d - \vartheta_n)) + \text{abs}(k_{\cos\varphi}(1 - \cos\varphi_n)) \\ & + \text{abs}(k\eta(1 - \eta_n)) + \text{abs}(k_{mp}(m_p + 1 - m_{pn})) \end{aligned} \quad (34.1)$$

TABLE 34.2 Input Values of 5.5 kW, 380 V Motor

| Quantity Name | Symbol | Dimension | Value |
|---------------------------------|----------------|-----------|-------|
| Nominal power output | P_n | W | 5500 |
| Nominal voltage | U_{1n} | V | 380 |
| Required power factor | $\cos \varphi$ | — | 0.81 |
| Required efficiency | η | — | 0.86 |
| Grid frequency | f | Hz | 50 |
| Motor axis height | H | mm | 132 |
| Number of pole pairs | p | — | 3 |
| Temperature class of insulation | TT | — | F |
| Torque overload capacity | m_p | — | 2 |

where k_V is the volume weight coefficient, k_{ϑ} is the temperature factor weight coefficient, $k_{\cos\varphi}$ is the power factor weight coefficient, k_{η} is the efficiency weight coefficient, k_{m_p} is the torque overload capacity weight coefficient.

Achieved Results

5.5 kW, 380 V Motor Design Description

During program development and tuning, an optimization was performed on the motor described in [Table 34.2](#). In this section we describe the results and problems encountered in the optimization process. The symbols and quantities, which are not explained in detail, were either used in the previous text or are listed at the list of used quantities at the beginning of the document. The motor input parameters are given in [Table 34.2](#).

Other Results

It follows from the physical principle that optimized quantities are closely related. Increase of a gain of one quantity results in a disadvantage of the quantities. Based on the performed optimizations, it can be concluded that two kinds of motors exist, depending on the content of iron and copper:

1. Motor with prevailing iron content, high stator current density, good power factor, for a price of worse efficiency of the motor and with slightly worse torque overload capacity than the second motor.
2. Motor with high copper content and conversely low stator current density, good efficiency, and worse power factor value. Torque overload capacity is good.

The type of motor is determined based on the setting of gain coefficients. A sum of temperature and power factor errors on one side impacts the sum of volume and efficiency errors on the other side. The torque overload capacity can be good for both kinds of motors.

Results of individual optimizations are listed in [Table 34.3](#), ordered by volume value from smallest to largest. Different varieties of motors were obtained, depending on values of gain coefficients. It is difficult to determine which solutions are good or bad, because the selections depend on actual customers' requirements. The solution that gives the best value of optimized quantity is marked in bold. Solution numbers 1, 5, 8, 23, and 25 can be considered successful from this perspective. The motor described above (solution no. 2) serves for depicting of the task. Previously-mentioned relations between individual quantities can be observed in [Table 34.3](#), which lists the optimization results without limiting the generated parameter, thus using the requirements in [Table 34.1](#).

Next, a motor optimization was performed with just one optimized parameter, when the gain of the other parameters was set equal to zero.

1. *Volume optimization.* In this case, the algorithm selected as the best solution motors with minimal dimensions, when parameters D_o , D , and l_i were converging to minimum preset limits.
2. *Temperature optimization.* The algorithm reached first reached a local minimum with temperature at the maximum based on the required insulation class, and mostly stayed on this value.

TABLE 34.3 Motor $P = 5.5$ kW, $U = 380$ V Solutions List, Without Generated Parameters Limited

| Number | V [dm ³] | ϑ [K] | $\cos\varphi$ [-] | η [-] | m_p [-] | Directory |
|--------|------------------------|-----------------|-------------------|--------------|-------------|-----------|
| 1 | 3.96 | 88.1 | 0.798 | 0.834 | 1.72 | Motor1 |
| 2 | 4.20 | 86.9 | 0.818 | 0.843 | 1.90 | Motor2 |
| 3 | 4.31 | 74.9 | 0.787 | 0.865 | 1.77 | Motor3 |
| 4 | 4.32 | 88.8 | 0.836 | 0.817 | 1.78 | Motor4 |
| 5 | 4.33 | 75.1 | 0.690 | 0.973 | 1.07 | Motor5 |
| 6 | 4.50 | 89.0 | 0.836 | 0.834 | 1.79 | Motor6 |
| 7 | 4.51 | 86.8 | 0.818 | 0.818 | 1.93 | Motor7 |
| 8 | 4.54 | 90.0 | 0.884 | 0.812 | 1.98 | Motor8 |
| 9 | 4.56 | 84.6 | 0.857 | 0.816 | 1.74 | Motor9 |
| 10 | 4.58 | 86.5 | 0.836 | 0.817 | 1.77 | Motor10 |
| 11 | 4.63 | 68.2 | 0.792 | 0.858 | 2.10 | Motor11 |
| 12 | 4.69 | 88.4 | 0.862 | 0.808 | 1.80 | Motor12 |
| 13 | 4.70 | 73.4 | 0.845 | 0.830 | 2.25 | Motor13 |
| 14 | 4.73 | 61.0 | 0.799 | 0.871 | 1.90 | Motor14 |
| 15 | 4.78 | 78.1 | 0.853 | 0.858 | 1.67 | Motor15 |
| 16 | 4.78 | 71.0 | 0.767 | 0.870 | 1.80 | Motor16 |
| 17 | 4.81 | 70.6 | 0.703 | 0.934 | 1.28 | Motor17 |
| 18 | 4.97 | 54.5 | 0.804 | 0.883 | 1.90 | Motor18 |
| 19 | 5.08 | 55.5 | 0.762 | 0.877 | 2.20 | Motor19 |
| 20 | 5.12 | 88.2 | 0.879 | 0.806 | 2.05 | Motor20 |
| 21 | 5.96 | 44.0 | 0.784 | 0.870 | 2.55 | Motor21 |
| 22 | 6.35 | 42.4 | 0.803 | 0.882 | 2.69 | Motor22 |
| 23 | 6.40 | 87.5 | 0.887 | 0.853 | 2.27 | Motor23 |
| 24 | 6.57 | 59.0 | 0.747 | 0.956 | 1.16 | Motor24 |
| 25 | 7.05 | 42.3 | 0.793 | 0.865 | 3.00 | Motor25 |
| 26 | 7.39 | 52.9 | 0.714 | 0.986 | 1.03 | Motor26 |

3. *Power factor optimization.* An effort to achieve the first type of motor (see above discussion) with low copper content, high current density σ_1 , worse value of efficiency. Torque overload capacity was good.
4. *Efficiency optimization.* The designed motor corresponded to the second type of motor (see above discussion) with prevailing copper content, low current density σ_1 , and good efficiency, however, with worse power factor values. Torque overload capacity was good.
5. *Torque overload capacity optimization.* The motor is designed with high number of slots for pole and phase, resulting in gradual spread of conductors on the perimeter. The motor can have prevailing iron or copper content depending on a local solution, to which it converged. It can have good values of power factor and efficiency for a price of machine volume increase.

34.4 The Use of a Neuron Network for the Identification of the Parameters of a Mechanical Dynamic System

The basic step used to solve the dynamic tasks by means of any type of modeling is to create a set of important quantities that include both the quantities describing structure, conditions, and the interactions of technical objects and the quantities that characterize the consequences (i.e., their demonstration and behavior).

The methods of creating the mathematical models in drive systems, in general an interactive process, utilize

- the applications of well-known physical principles that describe the phenomena in drive systems (e.g., the second Newton's principle, Kirchhoff's laws, etc.), or
- the applications of the methods based on artificial intelligence algorithms (e.g., genetic algorithms [1] and artificial neuron networks [6, 7]).

The theories on which the methods of artificial intelligence are based replace the “standard” analytical and numerical methods when

- these are the only theories which can solve the problem,
- they exhibit better properties from the point of view of the problem solution (e.g., a better conditionality considering the changes of input values), and
- they allow the problems to be solved more effectively.

The last case is typical when we want to approach the real operational conditions as close as possible. From various methods of artificial intelligence, the stochastic evolution algorithms and the artificial neuron networks are being increasingly utilized in the field of the modelling of drive interactive systems. In the following section, two methods are shown that are applied to the problems of the analysis of dynamic properties in drive systems.

The solution of dynamics by means of the algorithms of artificial intelligence represents a solution of the following partial problems:

- Specifying the set of important (relevant) quantities,
- Selecting the theory which is suitable to solve the problems,
- Arranging the relations among relevant quantities so that they allow the selected algorithm of artificial intelligence to be used,
- Generating the training data, and the selection of the method of teaching, for example, in neuron networks, and
- Testing the quality of the results reached and their evaluation.

Practical Application

Many identification methods are known and very often verified quite well in practical terms. The limit factors that make these procedures more difficult (e.g., the assumptions about system linearity, stationarity, and normality of the phenomena which occur in the systems, etc.) are also known. Hence, we have used an untraditional approach to the problem *f* identifying the dynamic properties in mechanical systems for which the use of neuron systems seems to be promising, and at the same time available for engineers' thinking.

A Practical Application—Gearbox

The first case that was analyzed is a vehicle gearbox. Inputs (engine load), outputs (frequency-amplitude spectra of torsional oscillations), and the gearbox structure were known. The ilete information was related to the selected parameters of stiffness and damping in the drive. Due to variable operational conditions, the magnitude of damping may vary enough to significantly affect output characteristics. If many experimental results are evaluated, some typical failures can be identified and their possible occurrence can be anticipated from output files. We have used the data that were measured in the real system. The frequency-amplitude spectrum of torsional oscillations was measured at the gearbox shaft, which is seated on four bearings with five speed gears (Fig. 34.1). Originally, the measurement was carried out to determine the resonance of frequency systems with the goal to reduce noise. The following parameters were set in the system:

Stiffness $K \in \{0.3, 12.0, \bullet\}$,

Damping $B \in \{-, 0, 0.3, 12.0\}$.

The measurements were done with testing frequencies $f = 512$ Hz and $f = 1024$ Hz. To record significant oscillation harmonics, the excitation frequency was flexible in both cases:

1. from 2.5 to 14.0 Hz in steps of 0.5 Hz, and
2. from 14.0 to 40.0 Hz in steps of 1.0 Hz.

Automobile gearbox

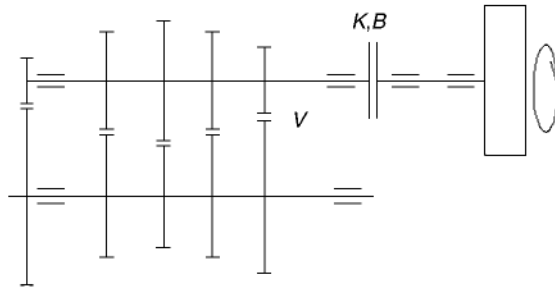

Sampling frequency $f = 512$ Hz
 $f = 1024$ Hz

Parameters:
 Stiffness $K = \{0.3, 12.0, \text{Inf.}\}$
 Damping $B = \{\text{None}, 0.0, 3.0, 12.0\}$
 Distance $V = \{0.0, 0.3\}$

Information base:
 360 measurements
 with several parameters K, B, V

FIGURE 34.1 Five speed gear.

TABLE 34.4 Expected Natural and Excitation Frequencies for the Gearbox

| Table of Expected Frequencies | | [Hz] |
|------------------------------------|-------------------------------------|-----------|
| Low frequencies | | up to 5.0 |
| Operational frequency (OF) (speed) | OF | 14.16 |
| | 2 \forall OF | 28.32 |
| | 3 \forall OF | 42.48 |
| Interharmonic frequency (IHF) | 0.5 \forall OF | 7.08 |
| | 1.5 \forall OF | 21.25 |
| | 2.5 \forall OF | 35.42 |
| Natural frequency (NF) | I.NF | 43.91 |
| | 0.5 \forall I.NF | 21.96 |
| | 2 \forall I.NF | 87.82 |
| | II.NF | 322.1 |
| | 0.5 \forall II.NF | 161.1 |
| | 2.0 \forall II.NF | 644.2 |
| Combination frequency (CF) | 2 \forall OF + 0.5 \forall I.NF | 50.28 |
| | OF + I.NF | 58.07 |
| | 2 \forall OF + I.NF | 72.23 |
| | 2 \forall OF + 2 \forall I.NF | 116.1 |
| Tooth frequency (TF) {TF = z.OF} | 1st speed gear | 184.1 |
| | 2nd speed gear | 325.7 |
| | 3rd speed gear | 424.9 |
| | 4th speed gear | 580.6 |

The spectrum always included 512 spectral lines. The measurement was repeated 360 times for different variations of the parameters K and B (the system adjustment). The values of natural and excitation frequencies, which are expected for the gearbox to be analyzed, are shown in Table 34.4.

Task Definition

The task was originally defined in the following way: to estimate the corresponding magnitudes of parameters K and B (this means, to recognize the adjustment of parameters used in the mechanical dynamic system) by means of the artificial neuron network on the basis of the frequency-amplitude

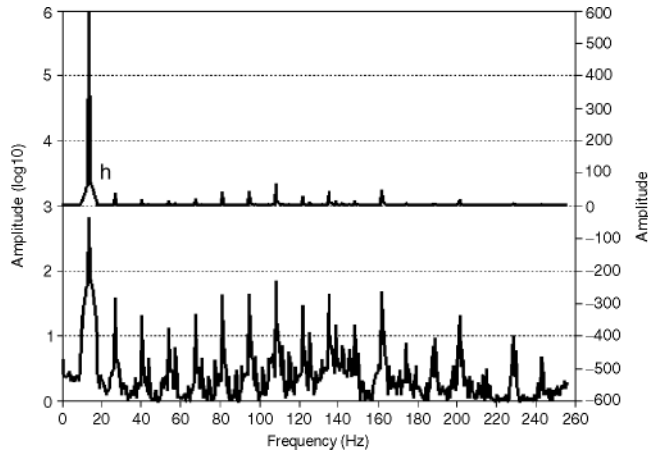

FIGURE 34.2 Stimulus vectors normalization (top, before normalization; bottom, after normalization).

spectrum of torsional shaft oscillations in the given system. A multilayer perceptron with three layers (i.e., input, hidden, and output) is used as the configuration of the neuron network. Select the signal neuron functions as the linear, hidden, and output layers of the logistic function, $f(x) = 1/(1 + e^{-x})$.

According to this definition, this is to identify the system parameters on the basis of the measured frequency-amplitude spectra. However, the parameters are taken from discrete sets (and very low), and the task could be redefined as the “standard” task of the spectrum classification according to seven attributes (each attribute corresponded to one of the possible values of the parameters K and B). The application of neuron networks to solve such a problem is more successful when compared to the solution of the original task.

The amplitudes of spectral lines were expressed in logarithm scale, and a reduction of spectral dynamics with an increase of their informative quality has been achieved. Considering the nonlinear nature of the activation neuron functions used, which extends beyond the saturation range for the input interval $(-0.5, 0.95)$, the network cannot respond well to stimulus vectors with a high range of the values in the individual components. This is illustrated in Fig. 34.2. The input network layer was configured to 512 input neurons. The amplitude logarithmic value of one spectral line was entered into each input. The individual neurons in the output layer correspond to the classification attributes. Because there are seven attributes, seven neurons were configured in the output layer.

The only-hidden layer was set as the arithmetic mean of the number of input and output neurons. Two hundred sixty neurons were configured to the only-hidden layer, as illustrated in Fig. 34.3. Each item corresponded to one measurement of the frequency spectrum (a stimulus vector) with a corresponding attribute vector (a vector of the required responses). The specific variation of the parameters was expressed by the required network response to two corresponding output neurons equal to 1, and the remaining output neurons equal to 0.

From the original 360 items, 36 items were randomly separated (10% of total) for the future tests. We ensured that the network tests would be carried out with the items that have not passed the training network process (the network was not trained to these situations). This is necessary to verify the generalization model properties. The training set was formed by the remaining 324 items. The sequential strategy of teaching was used, i.e., the items from the training set were used in the teaching process with the fixed sequence (cyclic passages through the training set). Taking into consideration the size of the neuron network to be configured, the method of feedback moment propagation has been selected as the teaching method that exploits only the information up to the first-order inclusively (the values of a special function—a teacher and his gradient), and it has not used Hessian or its estimate, which, in this case, would be very demanding.

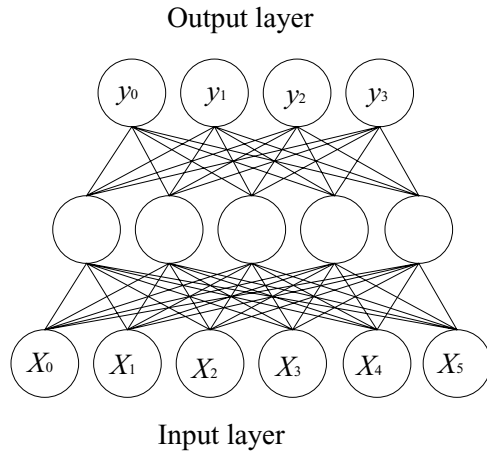

FIGURE 34.3 Network configuration (hidden layer contains neurons without labels).

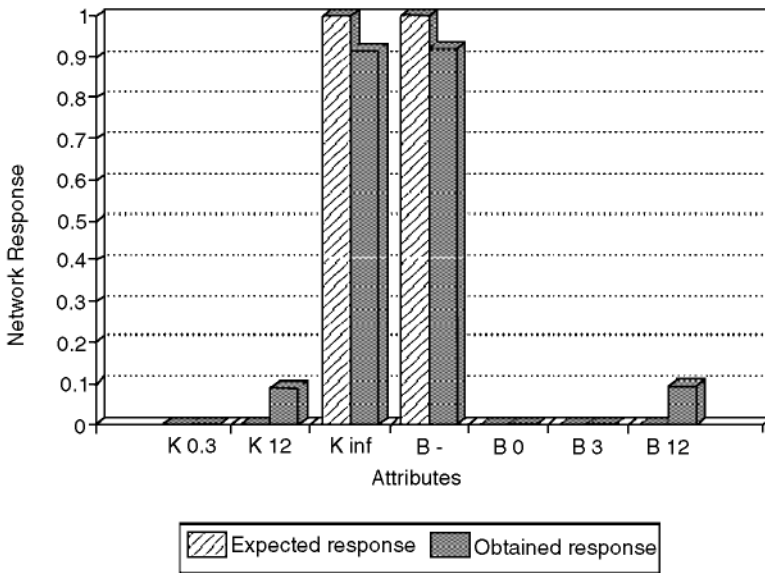

FIGURE 34.4 Successful response of neural net.

Results

The neuron model of the mechanical system has manifested a high rate of success during the verification by test sets. The network was taught with random selections of the test items. During testing of the individual models, the responses of the network were successful in 85–95% of all cases (see Figs. 34.4 and 34.5). Moreover, the estimate of the values K and B that correspond to the parameters is available within a couple of seconds for the frequency spectrum in the active mode. However, it is possible that a model with higher quality will be achieved if special optimizing techniques are used in the future.

In summary, the neuron model of the mechanical system described above can be assessed as usable in practical terms.

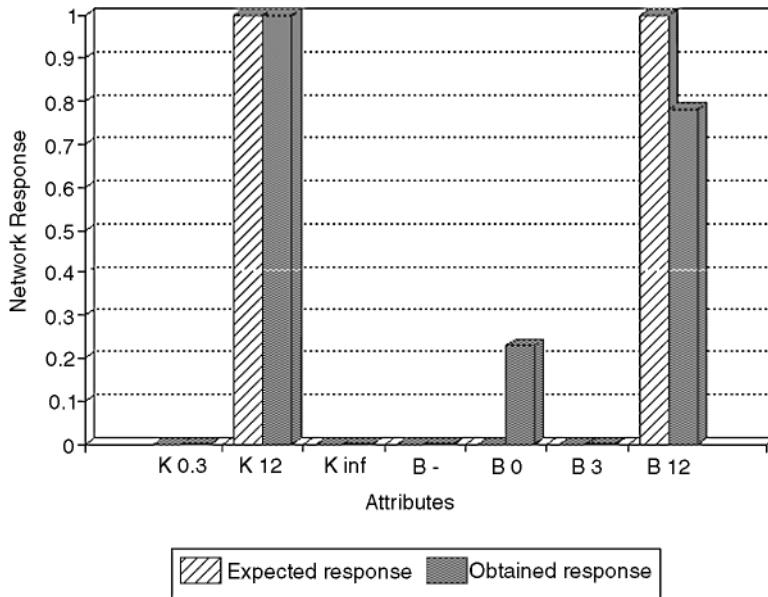

FIGURE 34.5 Failure response of neural net.

References

1. Goldberg, D., *Genetic Algorithms in Searching, Optimisation and Machine Learning*, Reading, MA: Addison-Wesley, 1989.
2. Glover, F., Lagunai, M., Marti, R., Fundamentals of scatter search and path relinking, *Control and Cybernetics*, pp. 653–684, 2000.
3. Glover, F., *Scatter Search and Star-Paths—Beyond the Genetic Metaphor*, pp. 125–137, New York: Springer-Verlag, September 1995.
4. Glover, F., Kelly, J.P., Langunai, M., Genetic algorithm and tabu search—hybrids for optimization, *Computers and Operations Research*, pp. 111–134, January 1995.
5. Lee, J., Hajela, P., Parallel genetic algorithm implementation in multidisciplinary rotor blade design, *Journal of Aircraft*, Vol. 33, No.5, pp. 962–969, September–October 1996.
6. Hagan, M.T., Demuth, H., Beale, M., *Neural Network Design*, Boston: PWS Publishing, 1996.
7. Kosko, B., *Neural Networks and Fuzzy Systems*, Englewood Cliffs, NJ: Prentice-Hall, 1992.
8. Ye, X., Loh, N., Dynamic system identification using recurrent radial basis function network, *Neural Networks Theory, Technology, and Applications*, New York: IEEE Technology Update Series, 1996.



Computers and Logic Systems

- 35 Introduction to Computers and Logic Systems** *Kevin Craig and Fred Stolfi*
Introduction: The Mechatronic Use of Computers • Mechatronics and Computer Modeling and Simulation • Mechatronics, Computers, and Measurement Systems • Mechatronics and the Real-Time Use of Computers • The Synergy of Mechatronics
- 36 Digital Logic Concepts and Combinational Logic Design** *George I. Cohn*
Introduction • Digital Information Representation • Number Systems • Number Representation • Arithmetic • Number Conversion from One Base to Another • Complements • Codes • Boolean Algebra • Boolean Functions • Switching Circuits • Expansion Forms • Realization • Timing Diagrams • Hazards • K-Map Formats • K-Maps and Minimization • Minimization with K-Maps • Quine–McCluskey Tabular Minimization
- 37 System Interfaces** *M.J. Tordon and J. Katupitiya*
Background • TIA/EIA Serial Interface Standards • IEEE 488—The General Purpose Interface Bus (GPIB)
- 38 Communications and Computer Networks** *Mohammad Ilyas*
A Brief History • Introduction • Computer Networks • Resource Allocation Techniques • Challenges and Issues • Summary and Conclusions
- 39 Fault Analysis in Mechatronic Systems** *Leila Notash and Thomas N. Moore*
Introduction • Tools Used for Failure/Reliability Analysis • Failure Analysis of Mechatronic Systems • Intelligent Fault Detection Techniques • Problems in Intelligent Fault Detection • Example Mechatronic System: Parallel Manipulators/Machine Tools • Concluding Remarks
- 40 Logic System Design** *M. K. Ramasubramanian*
Introduction to Digital Logic • Semiconductor Devices • Logic Gates • Logic Design • Logic Gate Technologies • Logic Gate Integrated Circuits • Programmable Logic Devices (PLD) • Mechatronics Application Example
- 41 Synchronous and Asynchronous Sequential Systems** *Sami A. Al-Arian*
Overview and Definitions • Synchronous Sequential System Synthesis • Asynchronous Sequential System Synthesis • Design of Controllers' Circuits and Datapaths • Concluding Remarks

- 42 Architecture** *Daniel A. Connors and Wen-mei W. Hwu*
Introduction • Types of Microprocessors • Major Components of a
Microprocessor • Instruction Set Architecture • Instruction Level Parallelism • Industry
Trends
- 43 Control with Embedded Computers and Programmable Logic
Controllers** *Hugh Jack and Andrew Sterian*
Introduction • Embedded Computers • Programmable Logic Controllers • Conclusion

35

Introduction to Computers and Logic Systems

Kevin Craig

Rennselear Polytechnic Institute

Fred Stolfi

Rennselear Polytechnic Institute

- 35.1 Introduction: The Mechatronic Use of Computers
- 35.2 Mechatronics and Computer Modeling and Simulation
- 35.3 Mechatronics, Computers, and Measurement Systems
- 35.4 Mechatronics and the Real-Time Use of Computers
- 35.5 The Synergy of Mechatronics

35.1 Introduction: The Mechatronic Use of Computers

Mechatronics is the synergistic combination of mechanical engineering, electronics, control systems, and computers. The key element in mechatronics is the integration of these areas through the design process. Synergism and integration in design set a mechatronic system apart from a traditional, multidisciplinary system. In a mechatronic system, computer, electronic, and control technology allow changes in design philosophy, which lead to better performance at lower cost: accuracy and speed from controls, efficiency and reliability from electronics, and functionality and flexibility from computers. Automotive engine-control systems are a good example. Here a multitude of sensors measure various temperatures, pressures, flow rates, rotary speeds, and chemical composition and send this information to a microcomputer. The computer integrates all this data with preprogrammed engine models and control laws and sends commands to various valves, actuators, fuel injectors, and ignition systems so as to manage the engine's operation for an optimum combination of acceleration, fuel economy, and pollution emissions.

In mechatronics, balance is paramount. The essential characteristic of a mechatronics engineer and the key to success in mechatronics design is a balance between two sets of skills:

- Modeling (physical and mathematical), analysis (closed-form and numerical simulation), and control design (analog and digital) of dynamic physical systems
- Experimental validation of models and analysis and understanding the key issues in hardware implementation of designs

In mechatronic systems, computers play a variety of roles. First, computers are used to model, analyze, and simulate mechatronic systems and mechatronic system components and, as such, are useful for control design. Second, computers, as part of measurement systems, are used to measure the performance

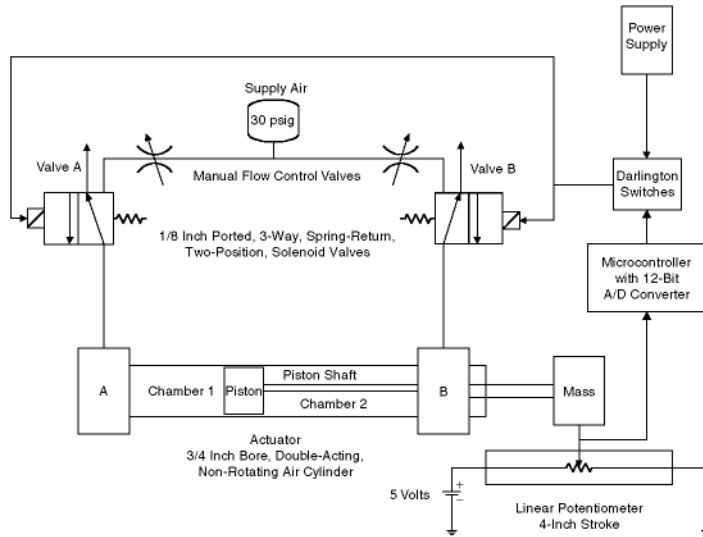

FIGURE 35.1 Pneumatic servomechanism.

of mechatronic systems, to determine the value of component parameters, and to experimentally validate models. Finally, computers or microcomputers form the central component in digital control systems for mechatronic designs. Thus, computers play an essential role in the two essential characteristics of the mechatronics balance and comprise a key component to mechatronic system designs. This is illustrated by the following example.

Consider the schematic of a pneumatic servomechanism, a computer-controlled, closed-loop positioning system, shown in Fig. 35.1. Pneumatic servomechanisms have the advantages of low cost, high power-to-weight ratio, ease of maintenance, cleanliness, and a readily-available and cheap power source. However, the disadvantages are high, nonlinear friction forces, deadband due to stiction, and dead time due to the compressibility of air. The design goal is to implement a fast, accurate, and inexpensive pneumatic-actuator system using inexpensive on/off solenoid valves, rather than expensive continuously-variable servo valves. To accomplish this task, one must completely understand the physical system, develop a physical model on which to base analysis and design, and experimentally determine and/or validate model parameters. One must then develop a mathematical model of the system, analyze the system, and compare the results of the analysis to experimental measurements to validate the model. One must then design a closed-loop position control system utilizing on/off, modified on/off, or pulse-width modulated control. Finally, one must implement the control system and experimentally validate its predicted performance.

A MatLab/Simulink model of this system is shown in Fig. 35.2. The mathematical model is highly nonlinear, as are the various control schemes. A computer numerical simulation is needed to understand the behavior of the system and the various control schemes. A data acquisition system is needed to take measurements of the various system inputs and outputs and validate the numerical simulation. And, a computer (a microcontroller in this case) is needed for the real-time implementation of the various control schemes. There are a variety of computer numerical simulation tools available, some requiring the detailed mathematical model while others enable virtual prototyping where the various system components are assembled on the computer screen with the component mathematical models given hidden in the background. There are also a variety of computer platforms on which to run the control algorithm, e.g., high-end PC using a DSP board and a real-time control-code generator; a microcontroller programmable in C or Basic with an analog-to-digital (A/D) converter and numerous digital input/output (I/O) ports; and a microchip implementation needed for product development.

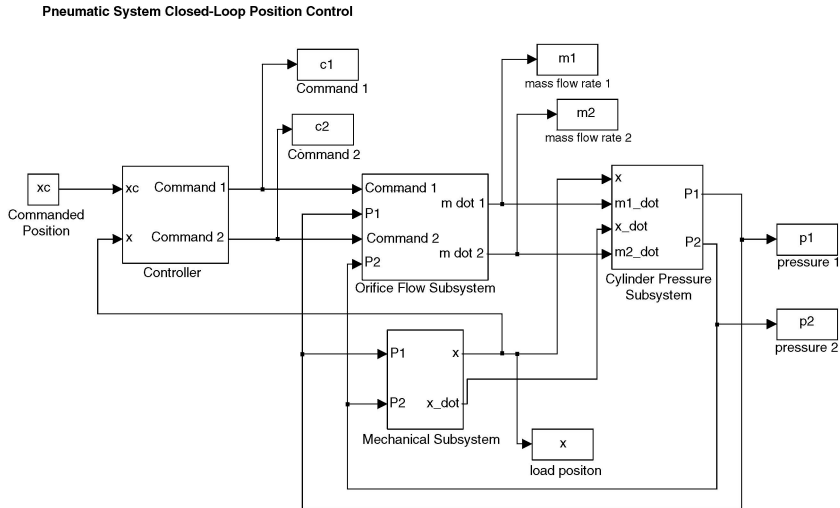

FIGURE 35.2 MatLab/Simulink model of the pneumatic servomechanism.

35.2 Mechatronics and Computer Modeling and Simulation

In design, balance is the key to success, i.e., balance between theory and practice and balance between modeling/analysis skills and hardware-implementation/measurement skills. Figure 35.3 illustrates the steps in a dynamic system investigation, which is the process that would be utilized to design a mechatronic system. The distinction between physical modeling and mathematical modeling is emphasized, as is the importance of both analytical and numerical solutions to the model equations. To generate a physical model, approximations must be made to the actual physical system. Small effects are neglected. The influence of the environment is ignored. Elements are assumed to be lumped instead of distributed. The dynamics are assumed to be linear. Parameters are assumed to be constant. Noise and uncertainty is ignored. These approximations have a direct influence on the mathematical model. Neglecting small effects limits the number of equations. Environmental independence reduces the complexity of the equations. Other approximations result in linear ordinary differential equations with constant coefficients. Neglecting uncertainty avoids the use of statistics in the model. In most cases, a design consideration is to develop the simplest model which adequately depicts the complexity of the system dynamics.

The predicted dynamic behavior of the model is only half the story, for these results, without experimental verification, are at best questionable, and at worst useless. Comparing the predicted dynamic behavior with the actual measured dynamic behavior is the key step in the dynamic system investigation process.

The steps in the dynamic system investigation process should be applied not only when an actual physical system exists (as in reverse engineering) and one desires to understand and predict its behavior, but also when the physical system is a concept in the design process that needs to be analyzed and evaluated. After recognizing a need for a new product or service, one uses past experience (personal and vicarious), awareness of existing hardware, understanding of physical laws, and creativity to generate design concepts. *The importance of modeling and analysis in the design process has never been more important than in this situation.* These design concepts can no longer be evaluated by the build-and-test approach because it is too costly and time consuming. Validating the predicted dynamic behavior in this case, when no actual physical system exists, becomes even more dependent on one's past hardware and experimental experience.

In physical modeling, one first specifies the physical system to be studied along with the system boundaries, input variables, and output variables. In modeling dynamic systems, we use engineering judgment and simplifying assumptions to develop a physical model. The complexity of the physical model depends on the particular need, e.g., system design iteration, control system design, control design

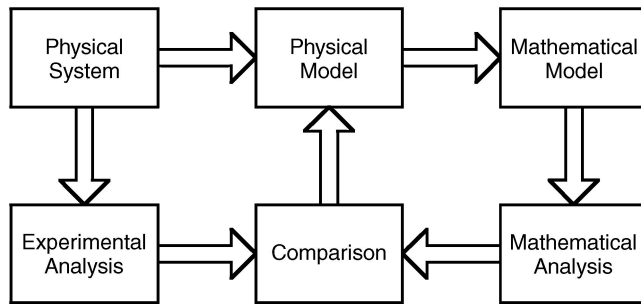

FIGURE 35.3 Dynamic system investigation process.

verification, physical understanding. The intelligent use of simple physical models requires that we have some understanding of what we are missing when we choose the simpler model over the more complex model. The astuteness with which these approximations are made at the onset of an investigation is the very crux of engineering analysis. A variety of engineering models may be developed based on the particular need. Always ask the question: “Why am I modeling the physical system and what is the range of operation that I wish my model to be valid for?” If the need is system-design iteration or control-system design, then a “*design model*” is needed, i.e., a physical model whose mathematical model is a linear ordinary differential equation with constant coefficients and, therefore, useful with a broad, highly-developed assortment of linear design techniques. If the need is design verification before actual hardware implementation, then a “*truth model*” is needed, i.e., a physical model that is as close to reality as possible; with nonlinear simulation tools available, almost any mathematical model can now be simulated. Iterations can then be performed using, as a starting point, the results of the work performed with the design model. Models only need to be valid for the particular range of operation of interest; low-order models then can often represent very complex, higher-order models very effectively. In practice, you may need a hierarchy of models of varying complexity: a very detailed truth model for final performance evaluation before hardware implementation, several less complex truth models for use in evaluating particular effects, and one or more design models.

35.3 Mechatronics, Computers, and Measurement Systems

Measurement systems or data acquisition systems may be used for a variety of purposes, and a computer plays an integral role in each.

1. *Monitoring of Processes and Operations.* Certain applications of measuring instruments may be characterized as having essentially a monitoring function, e.g., thermometers, barometers, and water, gas, and electric meters.
2. *Control of Processes and Operations.* An instrument can serve as a component of a control system. To control any variable in a feedback control system, it is first necessary to measure it. A single control system may require information from many measuring instruments, e.g., industrial machine and process controllers, aircraft control systems.
3. *Experimental Engineering Analysis.* In solving engineering problems, two general methods are available: theoretical and experimental. Many problems require the application of both methods and theory and experiment should be thought of as complementing each other. Further, all models need validation, and measurement systems offer a means to collect the data required for model validation.

The distinction among monitoring, control, and analysis functions is not clear-cut; the category that a given application may fit may depend somewhat on the engineer’s point of view and the apparent looseness of the classifications should not cause any difficulty. Rather it should be realized that computers,

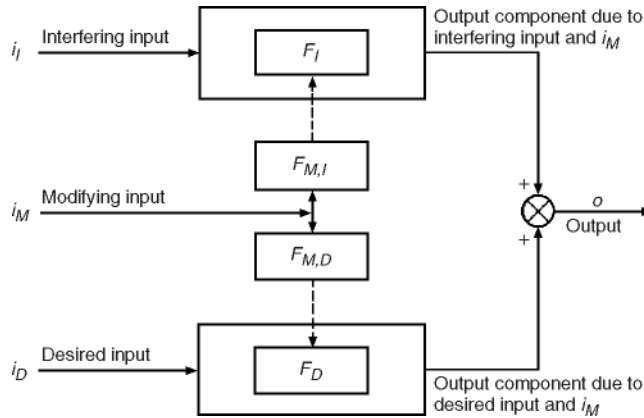

FIGURE 35.4 Input–output configuration of a measurement system.

as general purpose processing elements, can serve many functions in the processing of measured parameters from mechatronic systems and that these processing functions can be related to or unrelated to the modeling and control of such systems. Special purpose digital signal processing electronics are also used in measurement systems. High-speed digital signal processors (DSPs), for example, are used to collect input and output signals in the determination of transfer functions for mechatronic systems. The high speed allows the processing of simultaneous samples of the input and output for minimal phase error. The primary application for DSPs in mechatronic systems, however, is real-time control, discussed below.

Figure 35.4 is the input–output configuration of a measurement system. Input quantities are classified into three categories:

1. *Desired Inputs.* These are quantities that the instrument is specifically intended to measure.
2. *Interfering Inputs.* These are quantities to which the instrument is unintentionally sensitive. F_D and F_I are input–output relations, i.e., the mathematical operations necessary to obtain the output from the input. They represent different concepts depending on the particular input–output characteristic being described, e.g., a constant, a mathematical function, a differential equation, a statistical distribution function.
3. *Modifying Inputs.* These are quantities that cause a change in the input–output relations for the desired and interfering inputs, i.e., they cause a change in F_D and/or F_I . $F_{M,I}$ and $F_{M,D}$ represent the specific manner in which i_M affects F_I and F_D , respectively.

There are several methods for canceling or reducing the effects of spurious inputs. One method which relies upon computer processing of the signals is the method of calculated output corrections. This method requires one to measure or estimate the magnitudes of the interfering and/or modifying inputs and to know quantitatively how they affect the output. Then it is possible to calculate corrections, which may be added to or subtracted from the indicated output so as to leave (ideally) only that component associated with the desired input. Since many measurement systems today can afford to include a computer to carry out various functions, if sensors for the spurious inputs are provided, the computer can implement the method of calculated output corrections on an automatic basis.

35.4 Mechatronics and the Real-Time Use of Computers

We turn to the field of closed-loop control using a digital computer as the controller. Several comments are in order. First, a mechatronic system typically involves continuous variables. Elements rotate or translate in space. Fluids or gasses flow. Heat or energy is transferred. Computers are, by their nature, digital elements. Variables are represented in a computer by discrete values or simply by collections of zeroes and ones. For a computer to be used as the controller for a mechatronic system, therefore, the

continuous variables must be converted to discrete variables for processing and then back again to continuous variables. This might seem obvious. What is not so apparent is that the computer algorithm forms an inherent separation between the processing of the signals and the signals themselves, which is not true of other mechatronic system components. Even if digital logic elements are used (as discussed in this chapter) the signals are converted to discrete form, but the flow of information is still continuous through the elements. When a computer is used for the control element, this information flow is broken and buried in the computer algorithm. As an example, computer algorithms sometimes mimic continuous proportional-integral-derivative (PID) control laws. When the execution of this algorithm is analyzed, even if the effects of sampling and quantization are included, it is assumed that the signals are processed just as if they were being determined by continuous processing elements. In reality, if the computer code is examined at the machine level (i.e., not in the high level language in which it may be written), it would bear very little resemblance to a differential equation representation of the PID algorithm. This has practical implications both for modeling the exact operation of the computer as a control element and for validating that the computer code actually produces the desired response to signals.

Other issues are involved when the mechatronic system controller is implemented in software. Software execution is often asynchronous to the other time constants in the system (i.e., the software execution and system response are often not synchronized). Software can be made synchronous by syncing it to the sampler period, but this typically limits performance and is difficult if the computer is to be used for other tasks than control. Once a computer is contained as an element in a mechatronic system, there is a tendency to use some of the processing power to provide additional functionality or ease of use for the product. This additional code can affect, sometimes adversely, the operation of the real time controller execution. Testing of the code and safety of the code are also issues. The engineer has to determine that his system operates deterministically and safely for all possible combinations of input signals and for all possible states in the execution of the algorithm. For real-time systems, execution order for the code is often not predictable since it can be dependent on the particular combination of input signals. Simplicity of the code, providing for testability of the code, using established software quality assurance practices, and developing extensive documentation are ways to achieve system determinism and safety. Often, a hardware interlock, that is, a safety system utilizing electronic or mechanical hardware, is often included in software controlled systems.

Code operation has to be further verified as the code is modified and as the code is reused for systems other than that for which it was developed. Unlike other controllers, computer code is portable, but this requires more thought for its possible reuse. Using standard software packages, standard processors, modular code, and commercial real-time environments increases the possibility for reuse.

Besides the issues inherent in using computer code as the controller, there are issues involved whenever a digital processing component is incorporated into a mechatronic system. Further, there are considerations that must be taken into account whenever digital signals are processed. [Figure 35.5](#) shows a configuration useful for this discussion. The computer is important, but the computer “component” of many mechatronic machines and processes is often not the critical system element in terms of either technical or economic factors. Rather, components external to the computer, the actuators and sensors, the sampling system, and the anti-aliasing filter are more often the limiting factors in the system design.

Since both continuous (analog) and digital signals exist in computer-controlled systems, the signals in such a system can be classified as shown in the table below.

| Signal Classification | Discrete in Time | Continuous in Time |
|-------------------------|------------------|--------------------|
| Discrete in amplitude | D-D (digital) | D-C |
| Continuous in amplitude | C-D | C-C (analog) |

For analog signals, the precise value of the quantity (voltage, rotation angle, etc.) carrying the information is significant, meaning that the specific waveform of input and output signals is of vital importance. Conversely, digital signals are binary (on/off) in nature, and variations in numerical value are associated

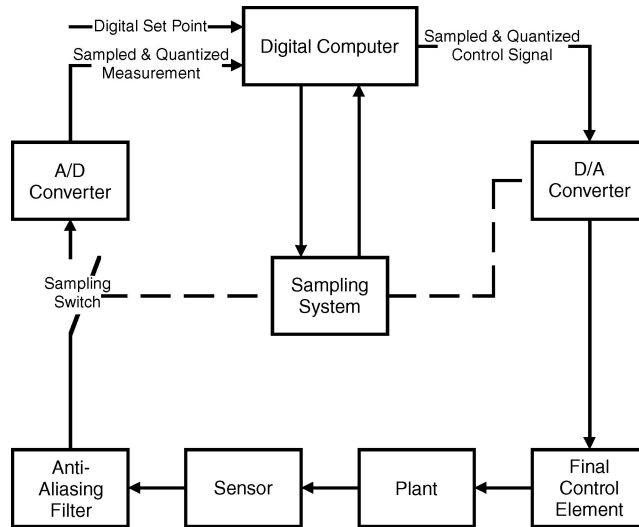

FIGURE 35.5 General computer-control configuration.

with changes in the logical state (true/false) of some combination of switches, for example, +2 V to +5 V represents ON state, 0 V to +0.8 V represents OFF state.

In digital devices, it is simply the presence (logical 1) or absence (logical 0) of a voltage within some wide range that matters; the precise value of the signal is of no consequence. Digital devices are therefore very tolerant of noise voltages and need not be individually very accurate, even though the overall system can be extremely accurate. When combined analog/digital systems are used, the digital portions need not limit system accuracy; these limitations generally are associated with analog portions and/or the analog-to-digital (A/D) conversion devices. Since most mechatronic systems are analog in nature, it is necessary to have both A/D converters and digital-to-analog (D/A) converters, which serve as translators that enable the computer to communicate with the outside analog world.

In most cases, the sensor and the final control element are analog devices, requiring, respectively, A/D and D/A conversion at the computer input and output. There are, of course, exceptions, e.g., stepper motor and optical encoder. In most cases, however, the sensors can be thought of as providing analog voltage output and the final control element will accept an analog voltage input.

The current trend toward using dedicated, computer-based, and often decentralized (distributed) digital control systems in mechatronic applications can be rationalized in terms of the major advantages of digital control:

- Digital control is less susceptible to noise or parameter variation in instrumentation because data can be represented, generated, transmitted, and processed as binary words, with bits possessing two identifiable states.
- Very high accuracy and speed are possible through digital processing. However, hardware implementation is usually faster than software implementation. Determining the time required to develop a system in software is notoriously difficult to estimate.
- Digital control can handle repetitive tasks extremely well, through programming.
- Complex control laws and signal conditioning methods that might be impractical to implement using analog devices can be programmed. Very sophisticated algorithms can be implemented digitally.
- High product reliability can be achieved by minimizing analog hardware components and through decentralization using dedicated computers for various control tasks.

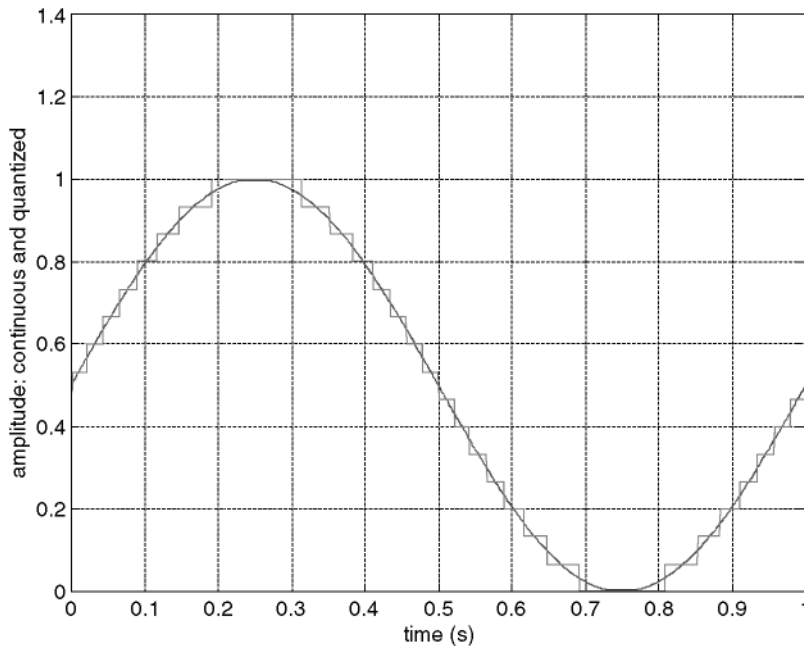

FIGURE 35.6 Simulation of a continuous and 4-bit quantized signal.

- Digital systems are more easily “programmed” and offer the ability to time-share a single processing unit among a number of different functions.
- Large amounts of data can be stored using compact high-density data storage methods.
- Data can be stored or maintained for very long periods of time without drift and without being affected by adverse environmental conditions. Digital control has easy and fast data retrieval capabilities.
- Fast data transmission is possible over long distances without introducing dynamic delays, as in analog systems.
- Digital processing uses low operational voltages (e.g., 0–12 V DC).
- Digital control has low overall component cost.

Further, from the standpoint of the mechatronic product, the inclusion of a computer means that additional system functions can be provided. The user can select from a range of operations. Additional features can be included. A user interface providing indications of operation can be added with minimal cost.

In a real sense, some of the problems of analysis and design of digital control systems (beyond the issues associated with software) are concerned with taking into account the effects of the sampling period, T , and the quantization size, q . If both T and q are extremely small (i.e., sampling frequency 50 or more times the system bandwidth with a 32-bit word size), digital signals are nearly continuous, and continuous methods of analysis and design can be used. It is most important to understand the *effects of all sample rates*, fast and slow, and the *effects of quantization* for large and small word sizes. Lower cost computers are typically slower and have a smaller word size. Figure 35.6 shows the effects of having too few quantization levels, i.e., too small a word size. The signal that will be processed by the controller has large errors over the original analog signal.

Figure 35.7 shows the effects of sampling. It is worthy to note that the *single most important impact* of implementing a control system digitally is often the delay associated with the D/A converter, i.e., $T/2$. This pure delay results in a substantial phase shift in the closed-loop feedback system and often limits the control operation.

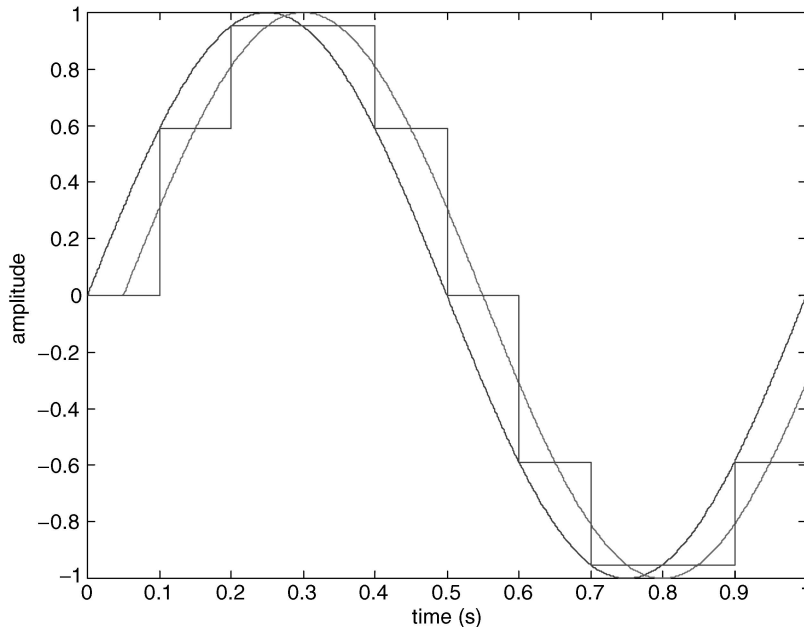

FIGURE 35.7 Continuous and D/A converter output.

In a feedback system, the analog signal coming from the sensor contains useful information related to controllable disturbances (relatively low frequency), but also may often include higher frequency “noise” due to uncontrollable disturbances (too fast for control system correction), measurement noise, and stray electrical pickup. Such noise signals cause difficulties in analog systems and low-pass filtering is often needed to allow good control performance. The phase shift from this filter also adversely affects control system stability.

Finally, in digital systems, a phenomenon called *aliasing* introduces some new aspects to the area of noise problems. If a signal containing high frequencies is sampled too infrequently, the output signal of the sampler contains low-frequency (“aliased”) components not present in the signal before sampling. This is illustrated in Fig. 35.8. If the higher frequency signal is sampled too infrequently, the result will be exactly the same values as the low frequency signal. From the standpoint of the controller, there is no way for the system to distinguish which signal is present. If we base our control actions on these false low-frequency components, they will, of course, result in poor control. The theoretical absolute minimum sampling rate to prevent aliasing is two samples per cycle; however, in practice, rates of about 10 are more commonly used. A high-frequency signal, inadequately sampled, can produce a reconstructed function of a much lower frequency, which cannot be distinguished from that produced by adequate sampling of a low-frequency function.

In all of the above, the word computer was used for the digital processing element. In electronics literature, a distinction is usually drawn between a microprocessor, microcomputer, DSP, and computer. There is no standard for what each of these terms can mean, but some insight can be gained by examining Fig. 35.9, which is a general block diagram for a computer. All computers have a means of getting input, a means of generating output, a means of controlling the flow of signals and operations, memory for data storage, and an arithmetic logic unit (ALU) which executes the instructions. The ALU and control elements are often called the central processing unit (CPU). Small computers, which just contain a CPU, are often called microprocessors. Memory for these computers is often attached to the microprocessor but in distinct electronic packages. Input and output to the microprocessor is often handled by electronics called peripherals. If the memory is included in the same package, the computer is called either a microcomputer or computer depending on its physical size. CPU and memory on a single electronics chip is

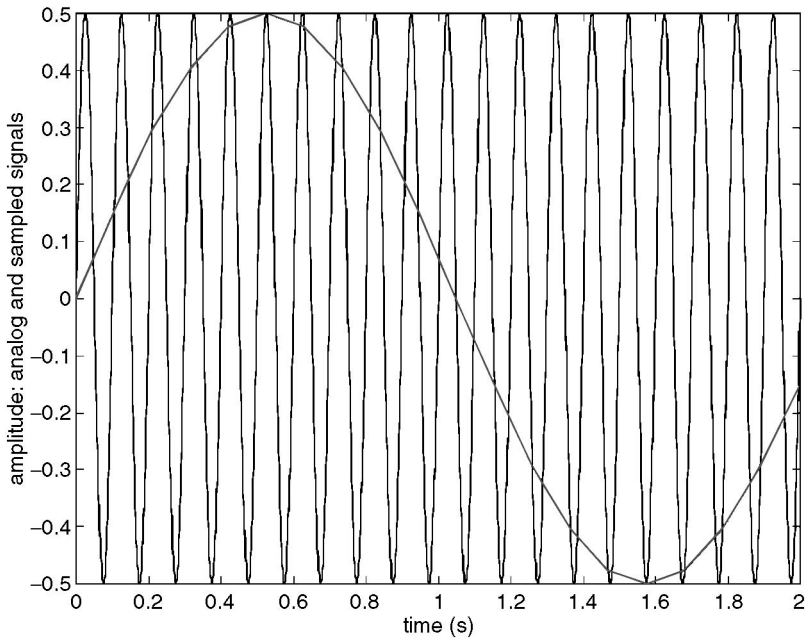

FIGURE 35.8 Simulation of continuous and sampled signal: aliasing.

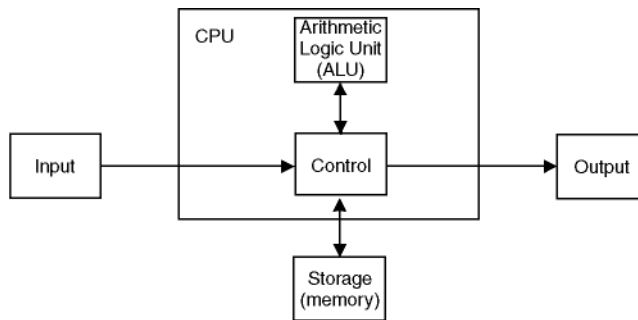

FIGURE 35.9 Elements of a computer.

often called a microcomputer. The reader should be aware that a single electronics package can contain many “chips,” which are connected by fine wires within the package. The overall package is still called a chip. Finally, if the A/D and D/A functions are provided in the same package, the computer is often called a DSP. However, these functions can also be contained in something which is called a microcomputer. DSPs are also computers which have a special instruction in the ALU called a multiply-accumulate (MAC) instruction even if the A/D and D/A are not present. Digital signal processing algorithms often involve MAC instructions and a computer, which can execute this instruction very effectively (in one instruction cycle of the computer), and are often called DSPs. To further complicate the situation, electronic devices called application specific integrated circuits (ASICs) exist. These devices can be custom made to perform a specific operation (such as a PID algorithm). ASICs can contain a CPU or memory or peripheral functions or even a MAC cell as part of its makeup. If the reader is thoroughly confused by this explanation, he probably has the proper grasp of the situation. However, he should be aware that diagrams like the one shown in Fig. 35.9 often accompany the electronic component so the internal capabilities can be determined.

Before leaving computers, one final point will be made. Memory in a computer can often be divided between program space and data space, as shown in Fig. 35.10. This representation is meant to be pictorial

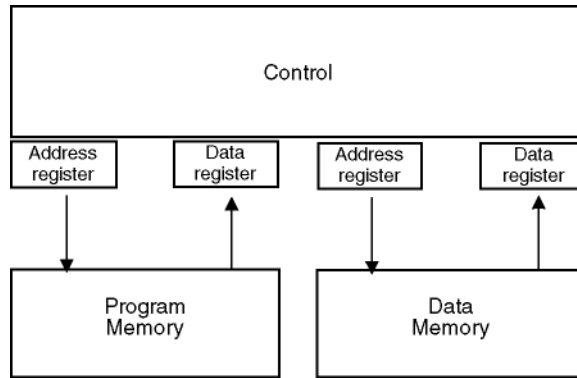

FIGURE 35.10 Computer memory organization.

rather than to define a specific computer architecture. In a von Neumann architecture, for example, the program memory and data memory share the same space and information busses. Whereas in a Harvard architecture, program memory and data memory are distinct (looking more like the figure). In either case, for a mechatronic system, one can think of the program (in program memory) as the set of instructions which tells the CPU how to manipulate data (in data memory) to produce an output. This view should emphasize the earlier point that the flow of signals in a mechatronic system becomes confused if a computer is to be used for real-time control.

Because of the low cost of modern microcomputers, the use of logic elements as discrete components in a mechatronic system has diminished. Microcomputers are often programmed to perform logic functions, which has the advantage that the operation can be altered in software rather than requiring electronic hardware changes. In analyzing this logic, of course, any of the traditional methods can be employed. The logic can be minimized via Karnaugh maps, for example. The only difference lies in the implementation of the algorithm. ASICs are also used to implement logic functions.

35.5 The Synergy of Mechatronics

As stated at the beginning of this section, mechatronics is the synergistic combination of mechanical engineering, electronics, control systems, and computers and the key element in mechatronics is the integration of these areas through the design process. The use of computers and logic elements as components in mechatronic systems will produce successful designs only if this synergy is achieved. The system must be designed as a system. Computers should never be an add-on component included when the design is complete. When computers are synergistically incorporated in the system, the power of the mechatronics approach to design is realized.

36

Digital Logic Concepts and Combinational Logic Design

- 36.1 Introduction
- 36.2 Digital Information Representation
- 36.3 Number Systems
- 36.4 Number Representation
- 36.5 Arithmetic
- 36.6 Number Conversion from One Base to Another
- 36.7 Complements
- 36.8 Codes
- 36.9 Boolean Algebra
- 36.10 Boolean Functions
- 36.11 Switching Circuits
- 36.12 Expansion Forms
- 36.13 Realization
- 36.14 Timing Diagrams
- 36.15 Hazards
- 36.16 *K*-Map Formats
- 36.17 *K*-Maps and Minimization
- 36.18 Minimization with *K*-Maps
- 36.19 Quine–McCluskey Tabular Minimization

George I. Cohn
*California State University,
Fullerton*

36.1 Introduction

Digital logic deals with the representation, transmission, manipulation, and storage of digital information. A digital quantity has only certain discrete values in contrast with an analog quantity, which can have any value in an allowed continuum. The enormous advantage digital has over analog is its immunity to degradation by noise, if that noise does not exceed a tolerance threshold.

36.2 Digital Information Representation

Information can be characterized as qualitative or quantitative. Quantitative information requires a number system for its representation. Qualitative does not. In either case, however, digitalized information is represented by a finite set of different characters. Each character is a discrete quanta of information. The set of characters used constitutes the alphabet.

TABLE 36.1 Notation for Numbers

| | Juxtaposition | Polynomial |
|----------|--|---------------------------------|
| Integer | $N = N_{n-1}N_{n-2} \circ N_1N_0$ | $N = \sum_{k=0}^{n-1} N_k R^k$ |
| Fraction | $F = F_{-1}F_{-2} \circ F_{-m+1}F_{-m}$ | $F = \sum_{k=-m}^{-1} F_k R^k$ |
| Real | $X = X_{n-1} X_{n-2} \circ X_1 X_0 \diamond X_{-1} X_{-1} \circ X_{-m+1} X_{-m}$ | $X = \sum_{k=-m}^{n-1} X_k R^k$ |

36.3 Number Systems

Quantitative information is represented by a number system. A character that represents quantitative information is called a **digit**. The number of different values which a digit may have is called the **radix**, designated by R . The symbols that designate the different values a digit can have are called numeric characters. The most conventionally used numeric characters are 0, 1, 2, ..., etc., with 0 representing the smallest value. The largest value that a digit may have in a number system is the **reduced radix**, $r = R - 1$. Different radix values characterize different number systems: with R different numeric character values the number system is R nary, with 2 it is binary, with 3 it is ternary, with 8 it is octal, with 10 it is decimal, and with 16 it is hexadecimal.

Any value that can be expressed solely in terms of digits is an **integer**. A negative integer is any integer obtained by subtracting a positive integer from a smaller integer. Any number obtained by dividing a number by a larger number is a **fraction**. A number that has both an integer part and a fraction part is a **real number**.

All of the digits in a *number system* have the same radix. The radix is the **base** of the number system. Presumably, the possession of 10 fingers has made the decimal number system the most convenient for humans to use. The characters representing the 10 values a decimal digit can have are 0, 1, 2, 3, 4, 5, 6, 7, 8, and 9. The binary number system is the most natural for digital electronic systems because a desired reliability for a system can be most economically achieved using elements with two stable states. The characters normally used to represent the two values a binary digit may have are 0 and 1. The hexadecimal number system (0, 1, 2, 3, 4, 5, 6, 7, 8, 9, A, B, C, D, E, and F; $R = 16$) is of importance because it shortens by a factor of four the string of digits representing the binary information stored and manipulated in digital computers.

36.4 Number Representation

Numbers that require more than one digit can be represented in different formats, as shown in [Table 36.1](#). Different formats facilitate execution of different procedures. Arithmetic is most conveniently done with the juxtaposition format. Theoretical developments are facilitated by the polynomial format.

36.5 Arithmetic

The most common arithmetic processes, addition, subtraction, multiplication, and division are conveniently implemented using multidigit notation. Development of formulation procedures is facilitated using the polynomial notation. Since the numbers are digital representations, the logic used to manipulate the numbers is *digital logic*. However, this is different than the logic of boolean algebra, which is what is usually meant by the term digital logic. The logic of the former is implemented in hardware by using the logic of the latter. The four basic arithmetic operations can be represented as functional procedures in equation form or in arithmetic manipulation form, as shown in [Table 36.2](#).

The arithmetic processes in the binary system are based on the binary addition and multiplication tables given in [Table 36.3](#).

[Table 36.4](#) gives binary examples for each of the basic arithmetic operations.

TABLE 36.2 Arithmetic Operations

| | Algebraic Form | Arithmetic Form |
|----------------|--|--|
| Addition | Sum = Augend + Addend | $\begin{array}{r} \text{Augend} \\ + \text{Addend} \\ \hline \text{Sum} \end{array}$ |
| Subtraction | Difference = Minuend – Subtrahend | $\begin{array}{r} \text{Minuend} \\ - \text{Subtrahend} \\ \hline \text{Difference} \end{array}$ |
| Multiplication | Product = Multiplicand × Multiplier | $\begin{array}{r} \text{Multiplicand} \\ \times \text{Multiplier} \\ \hline \text{Product} \end{array}$ |
| Division | Dividend/Divisor = Quotient + Remainder/Divisor | $\begin{array}{r} \text{Quotient} \quad \text{Remainder} \\ \text{Divisor} \overline{) \text{Dividend}} \end{array}$ |

TABLE 36.3 Single Digit Binary Arithmetic Table

| (a) Addition | (b) Multiplication |
|--|--|
| $\begin{array}{ c c } \hline 0 & 1 \\ \hline 0 & 1 \\ \hline 1 & 10 \\ \hline \end{array}$ | $\begin{array}{ c c } \hline 0 & 1 \\ \hline 0 & 0 \\ \hline 1 & 01 \\ \hline \end{array}$ |

TABLE 36.4 Binary Arithmetic Operation Examples

| | |
|---|--|
| <p><i>Addition:</i></p> $\begin{array}{r} 1100 \text{ carries} \\ 11100 \text{ augend} \\ + 1101 \text{ addend} \\ \hline 101001 \text{ sum} \end{array}$ | <p><i>Multiplication:</i></p> $\begin{array}{r} 1101 \text{ multiplicand} \\ \times 110 \text{ multiplier} \\ \hline 0000 \text{ partial product 1} \\ 1101 \text{ partial product 2} \\ 1101 \text{ partial product 3} \\ \hline 1001110 \text{ product} \end{array}$ |
| <p><i>Subtraction, borrow method:</i></p> $\begin{array}{r} \overset{10}{\cancel{1}}01 \text{ borrows} \\ \phantom{\cancel{1}}01 \text{ minuend} \\ - 10 \text{ subtrahend} \\ \hline \phantom{\cancel{1}}11 \text{ difference} \end{array}$ | <p><i>Division, with fraction remainder:</i></p> $\begin{array}{r} \text{ remainder} \\ \text{ quotient} \\ \underline{10010} \\ 1011 \overline{) 11001101} \text{ dividend} \\ \text{ divisor } 1011 \\ \underline{01110} \\ \underline{1011} \\ 0111 \end{array}$ |
| <p><i>Subtraction, payback method:</i></p> $\begin{array}{r} \overset{10}{1}01 \text{ borrows} \\ 01 \text{ minuend} \\ - 1 \text{ payback} \\ \hline -10 \text{ subtrahend} \\ \hline 11 \text{ difference} \end{array}$ | <p><i>Division, with remainder in quotient:</i></p> $\begin{array}{r} \text{ quotient} \\ \underline{.1010001 \dots} \\ 1011 \overline{) 11.0000000} \text{ dividend} \\ \text{ divisor } 1011 \\ \underline{1100} \\ \underline{1011} \\ \underline{010000} \\ \underline{1011} \end{array}$ |

36.6 Number Conversion from One Base to Another

The method of using series polynomial expansions for converting numbers from one base to another is illustrated in Table 36.5.

Evaluation of polynomials is more efficiently done with the *nested form*. The nested form is obtained from the series form by successive factoring of the variable from all terms in which it appears as shown in Table 36.6. The number of multiplications to evaluate the nested form increases linearly with the order of the polynomial, whereas the number of multiplications to evaluate the series form increases with the square of the order.

Conversion of integers between bases is more easily done using the lower order polynomials, Table 36.6(b), obtained by nesting. The least significant digit of the number in the new base is the remainder obtained after dividing the number in the old base by the new radix. The next least significant digit is the remainder obtained by dividing the first reduced polynomial by the new radix. The process is repeated until the most significant digit in the new base is obtained as the remainder, when the new radix no longer fits into the last reduced polynomial. This is more compactly represented with the arithmetic notation shown in Table 36.7 along with the same examples used to illustrate the polynomial series method.

TABLE 36.5 Series Polynomial Method for Converting Numbers Between Bases

| Method | Sample Conversion From | |
|--|--|---|
| | A Lower to a Higher Base | A Higher to a Lower Base |
| 1. Express number in polynomial form in the given base | $101.1_2 = 1 \times 2^2 + 0 \times 2^1 + 1 \times 2^0 + 1 \times 2^{-1}$ | $36.5_{10} = 3 \times 10^1 + 6 \times 10^0 + 5 \times 10^{-1}$ |
| 2. Convert radix and coefficients to the new base | $= 1 \times 4 + 0 \times 2 + 1 \times 1 + 1 \times 0.5$ | $= 11 \times 1010^1 + 110 \times 1010^0 + 101 \times 1010^{-1}$ |
| 3. Evaluate terms in the new base | $= 4 + 0 + 1 + 0.5$ | $= 11 \times 1010 + 110 + 101/1010$ $= 11110 + 110 + .1$ |
| 4. Add the terms | $101.1_2 = 5.5_{10}$ | $36.5_{10} = 100100.1_2$ |

TABLE 36.6 Nested Polynomials

| (a) Nested Polynomial via Iterated Factoring | (b) Lower Order Polynomials |
|---|------------------------------------|
| $N = N_{n-1}R^{n-1} + N_{n-2}R^{n-2} + \dots + N_2R^2 + N_1R + N_0$ | $N = N^{(1)}R + N_0$ |
| $N = (N_{n-1}R^{n-2} + N_{n-2}R^{n-3} + \dots + N_2R + N_1)R + N_0$ | $N^{(1)} = N^{(2)}R + N_1$ |
| $N = ((N_{n-1}R^{n-3} + N_{n-2}R^{n-4} + \dots + N_2)R + N_1)R + N_0$ | $N^{(2)} = N^{(3)}R + N_2$ |
| ⋮ | ⋮ |
| | $N^{(n-2)} = N^{(n-3)}R + N_{n-2}$ |
| $N = (\dots(N_{n-1})R + N_{n-2})R + \dots + N_2)R + N_1)R + N_0$ | $N^{(n-1)} = N_{n-1}$ |

TABLE 36.7 Radix Divide Method for Converting Numbers Between Bases

| Method | Sample Conversion From | |
|--|-----------------------------|--------------------------------|
| | A Higher to a Lower Base | A Lower to a Higher Base |
| $R \overline{) N}$ | $2 \overline{) 36}_{10}$ | |
| $R \overline{) N^{(1)}} \quad N_0$ | $2 \overline{) 18} \quad 0$ | |
| $R \overline{) N^{(2)}} \quad N_1$ | $2 \overline{) 9} \quad 0$ | $12 \overline{) 2012}_3$ |
| $R \overline{) N^{(3)}} \quad N_2$ | $2 \overline{) 4} \quad 1$ | $12 \overline{) 102} \quad 11$ |
| ⋮ | $2 \overline{) 2} \quad 0$ | $12 \overline{) 2} \quad 1$ |
| ⋮ | $2 \overline{) 1} \quad 0$ | $12 \overline{) 0} \quad 2$ |
| $R \overline{) N^{(n-1)}} \quad N_{n-2}$ | $0 \quad 1$ | |
| $R \overline{) 0} \quad N_{n-1}$ | $36_{10} = 100100_2$ | $2012_3 = 214_5$ |

TABLE 36.8 Radix Multiply Number Conversion Method (Terminating Case)

| Formalism | | Sample Conversion Between Bases | |
|---|---|---------------------------------|------------------------------------|
| Algebraic | Arithmetic | Higher to Lower | Lower to Higher |
| $F = F_{-1}F_{-2}F_{-3} \cdots F_{-m}$ | $F_{-1}F_{-2}F_{-3} \cdots F_{-m}$ $\times R$ | | 0.100101_2 $\times 1010$ |
| $R^*F = F_{-1} \cdot F_{-2}F_{-3} \cdots F_{-m}$ $= F_{-1} \cdot F^{(1)}$ | $F_{-1} \cdot F_{-2}F_{-3} \cdots F_{-m}$ $\times R$ | 0.125_{10} $\times 2$ | $101 \cdot 11001$ $\times 1010$ |
| $R^*F^{(1)} = F_{-2} \cdot F_{-3}F_{-4} \cdots F_{-m} = F_{-2} \cdot F^{(2)}$ | $F_{-2} \cdot F_{-3} \cdots F_{-m}$ $\times R$ | 0.25 $\times 2$ | $111 \cdot 1101$ $\times 1010$ |
| $R^*F^{(2)} = F_{-3} \cdot F_{-4}F_{-5} \cdots F_{-m} = F_{-3} \cdot F^{(3)}$ | \vdots | 0.5 $\times 2$ | $1000 \cdot 001$ $\times 1010$ |
| $R^*F^{(m-2)} = F_{-m+1} \cdot F_{-m}$ $= F_{-m+1} \cdot F^{(m-1)}$ | $F_{-m+1} \cdot F_{-m}$ $\times R$ | 1.0 | $1 \cdot 10$ $\times 1010$ |
| $R^*F^{(m-1)} = F_{-m}$ | F_{-m} | | $10 \cdot 1$ $\times 1010$ |
| | | $.125_{10} = .001_2$ | $.100101_2 = .578125_{10}$ |

TABLE 36.9 Nonterminating Fraction Conversion Example

| | |
|----------------------------------|------------------------|
| $0.1_{10} = 0.000110011 \dots_2$ | |
| $\times 2$ | |
| 0.2 | or more compactly |
| $\times 2$ | |
| 0.4 | $0.1_{10} = 0.00011_2$ |
| $\times 2$ | |
| 0.8 | |
| $\times 2$ | |
| 1.6 | |
| $\times 2$ | |
| 1.2 | |
| $\times 2$ | |
| 0.4 | |
| $\times 2$ | |
| 0.8 | |
| $\times 2$ | |
| 1.6 | |

Conversion of a fraction from one base to another can be done by successive multiplications of the fraction by the radix of the number system to which the fraction is to be converted. Each multiplication by the radix gives a product that has the digits shifted to the left by one position. This moves the most significant digit of the fraction to the left of the radix point, placing that digit in the integer portion of the product, thereby isolating it from the fraction. This process is illustrated in algebraic form in the left column of Table 36.8 and in arithmetic form in the next column. Two sample numeric conversions are shown in the next two columns of Table 36.8.

Table 36.8 deals only with terminating fractions, that is, the remaining fractional part vanishes after a finite number of steps. For a nonterminating case the procedure is continued until a sufficient number of digits have been obtained to give the desired accuracy. A nonterminating case is illustrated in Table 36.9. A set of digits, which repeat ad infinitum, are designated by an underscore, as shown in Table 36.9.

TABLE 36.10 Conversions Between Systems Where One Base Is an Integer Power of the Other Base

| | |
|---|--|
| (a) Conversion from high base to lower base | |
| B2. | $C5_{16} = 1011\ 0010\ .1100\ 0101_2$ |
| | $62.75_8 = 110\ 010\ .111\ 101_2$ |
| (b) Conversion from lower base to high base | |
| | $11\ 0010\ 0100.0001\ 1100\ 01_2 = 324.1C4_{16}$ |
| | $10\ 110\ 001.011111\ 01_2 = 261.372_8$ |

Conversion to base 2 from a base, which is an integer power of 2, can be most simply accomplished by independent conversion of each successive digit, as illustrated in [Table 36.10\(a\)](#). Inversely, conversion from base 2 to a base 2^k can be simply accomplished by grouping the bits into sets of k bits, each starting with the least significant bit for the integer portion and with the most significant bit for the fraction portion, as shown by the examples in [Table 36.10\(b\)](#).

36.7 Complements

Each number system has two conventionally used **complements**:

$$\begin{aligned} \text{radix complement of } N &= N^{RC} = R^n - N \\ \text{reduced radix complement of } N &= N^{rC} = N^{RC} - 1 \end{aligned}$$

where R is the radix and n is the number of digits in the number N . These equations provide complements for numbers having the magnitude N .

A positive number can be represented by a code in the two character machine language alphabet, 0 and 1, which is simply the positive number expressed in the base 2, that is, the code for the number is the number itself. A negative number requires that the sign be coded in the binary alphabet. This can be done by separately coding the sign and the magnitude or by coding the negative number as a single entity. [Table 36.11](#) illustrates four different code types for negative numbers. Negative numbers can be represented in the sign magnitude form by using the leftmost digit as the code for the sign (0 for + and 1 for -) and the rest of the digits as the code for the magnitude. Complements and biasing provide the means for coding the negative number as a single entity instead of having a discrete separate coding for the sign. The use of complements provides for essentially equal ranges of values for both positive and negative numbers. The biased representation can also provide essentially equal ranges for positive and negative values by choosing the biasing value to be essentially half of the largest binary number that could be represented with the available number of digits. The bias code is obtained by subtracting the biasing value from the code considered as a positive number, as shown in the rightmost column of [Table 36.11](#).

Complements enable subtraction to be done by addition of the complement. If the result fits into the available field size the result is automatically correct. A diagnostic must be provided to show that the result is incorrect if **overflow** occurs, that is, the number does not fit in the available field. [Table 36.12](#) illustrates arithmetic operations with and without complements. The two rightmost columns illustrate cases where the result overflows the 3-b field size for the magnitude. The overflow condition can be represented in terms of two carry parameters:

- C_0 , the output carry from the leftmost digit position
- C_1 , the output carry from the second leftmost digit position (the output carry from the magnitude field if sign magnitude representation is used)

If both of these carries are coincident (i.e., have the same value) the result fits in the available field and, hence, is correct. If these two carries are not coincident, the result is incorrect.

TABLE 36.11 Number Representations

| Available Codes | Positive Numbers | Signed Numbers Having the Specified Codes | | | |
|-----------------|------------------|---|------------------|------------------|----------|
| | | Sign Magnitude | One's Complement | Two's Complement | 111 bias |
| 1111 | 1111 | -111 | -000 | -001 | +1000 |
| 1110 | 1110 | -110 | -001 | -010 | +111 |
| 1101 | 1101 | -101 | -010 | -011 | +110 |
| 1100 | 1100 | -100 | -011 | -100 | +101 |
| 1011 | 1011 | -011 | -100 | -101 | +100 |
| 1010 | 1010 | -010 | -101 | -110 | +011 |
| 1001 | 1001 | -001 | -110 | -111 | +010 |
| 1000 | 1000 | -000 | -111 | -1000 | +001 |
| 0111 | 0111 | +111 | +111 | +111 | 000 |
| 0110 | 0110 | +110 | +110 | +110 | -001 |
| 0101 | 0101 | +101 | +101 | +101 | -010 |
| 0100 | 0100 | +100 | +100 | +100 | -011 |
| 0011 | 0011 | +011 | +011 | +011 | -100 |
| 0010 | 0010 | +010 | +010 | +010 | -101 |
| 0001 | 0001 | +001 | +001 | +001 | -110 |
| 0000 | 0000 | +000 | +000 | +000 | -111 |

TABLE 36.12 Comparison of Arithmetic With and Without Complements

| Sample Illustrations | $N = 7 - 5 = 2$ | $N = 5 - 7 = -2$ | $N = 5 + 7 = 12$ | $N = -5 - 7 = -12$ |
|---|---|--|---|---|
| Pencil and paper arithmetic (without complements) | $\begin{array}{r} 111 \\ -101 \\ \hline 10 \end{array}$ | $\begin{array}{r} (-111) \\ -(-101) \\ \hline -10 \end{array}$ | $\begin{array}{r} 101 \\ +111 \\ \hline 1100 \end{array}$ | $\begin{array}{r} (-101) \\ +(-111) \\ \hline -1100 \end{array}$ |
| Computer arithmetic with 2's complement | $\begin{array}{r} 0111 \\ +1011 \\ \hline \cancel{1}0010 \end{array}$ | $\begin{array}{r} 0101 \\ +1001 \\ \hline 1110 \end{array}$ | $\begin{array}{r} 0101 \\ +0111 \\ \hline 1100 \end{array}$ | $\begin{array}{r} 1011 \\ +1001 \\ \hline \cancel{1}0100 \end{array}$ |
| 4-binary digit working field (accommodates 3-b magnitude) | ↓ | ↓ | ↓ | ↓ |
| | Designates positive number | Designates negative number | Designates negative number | Designates positive number |
| Result | +010 | -010 | -100 | -100 |
| Veracity | True | True | False | False |
| Significant carries | $C_0 = 1$ $C_1 = 1$ | $C_0 = 0$ $C_1 = 0$ | $C_0 = 0$ $C_1 = 1$ | $C_0 = 1$ $C_1 = 0$ |
| Veracity condition or equivalently | $C_0 \equiv C_1$ $C_0 \odot C_1 = 1$ | $C_0 \equiv C_1$ $C_0 \odot C_1 = 1$ | $C_0 \neq C_1$ $C_0 \odot C_1 = 0$ | $C_0 \neq C_1$ $C_0 \odot C_1 = 0$ |

36.8 Codes

Various types of **codes** have been developed for serving different purposes. There are codes that enable characters in an alphabet to be individually expressed in terms of codes in a smaller alphabet. For example, the alphabet of decimal numeric symbols can be expressed in terms of the binary alphabet by the **binary-coded decimal (BCD)** or 8421 code shown in [Table 36.13](#). The 8421 designation represents the weight given to each of the binary digits in the coding process.

There are codes that facilitate doing arithmetic. The 2421 code can also be used to represent the decimal numeric symbols. The 2421 code has the advantage that the code for the reduced radix complement is

TABLE 36.13 Sample Codes

| Decimal Digits | BCD 8421 | 2421 | 2-out-of-5 | Parity | | Gray | | |
|----------------|----------|------|------------|--------|--------|-------|-------|-------|
| | | | | Even | Odd | 1-bit | 2-bit | 3-bit |
| 0 | 0000 | 0000 | 00011 | 0000 0 | 0000 1 | 0 | 00 | 000 |
| 1 | 0001 | 0001 | 00101 | 0001 1 | 0001 0 | 1 | 01 | 001 |
| 2 | 0010 | 0010 | 00110 | 0010 1 | 0010 0 | | 11 | 011 |
| 3 | 0011 | 0011 | 01001 | 0011 0 | 0011 1 | | 10 | 010 |
| 4 | 0100 | 0100 | 01010 | 0100 1 | 0100 0 | | | 110 |
| 5 | 0101 | 1011 | 01100 | 0101 0 | 0101 1 | | | 111 |
| 6 | 0110 | 1100 | 10001 | 0100 1 | 0110 0 | | | 101 |
| 7 | 0111 | 1101 | 10010 | 0111 1 | 0111 0 | | | 100 |
| 8 | 1000 | 1110 | 10100 | 1000 1 | 1000 0 | | | |
| 9 | 1001 | 1111 | 11000 | 1001 0 | 1001 1 | | | |

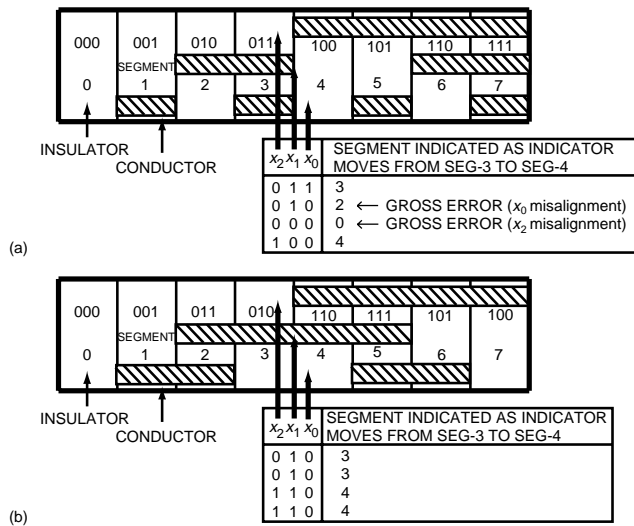

FIGURE 36.1 Eight-segment position sensor with slightly misaligned contacts: (a) binary code physical configuration, (b) Gray code physical configuration.

the same as the reduced radix complement of the code, and this is not true of the BCD code. Thus, the 2421 code facilitates arithmetic with multiple individually coded digit numbers.

There are codes designed to detect errors that may occur in storage or transmission. Examples are the even and odd parity codes and the 2-out-of-5 code shown in Table 36.13. The 2-out-of-5 error detection code is such that each decimal value has exactly two high digit values. Parity code attaches an extra bit having a value such that the total number of high bits is odd if odd parity is used, and the total number of high bits is even if even parity is used. An even number of bit errors are not detectable by a single bit parity code. Hence, single bit parity codes are adequate only for sufficiently low bit error rates. Including a sufficient number of **parity bits** enables the detection and correction of all errors.

There are codes designed to prevent measurement misrepresentation due to small errors in sensor alignment. **Gray codes** are used for this purpose. A Gray code is one in which the codes for physically adjacent positions are also **logically adjacent**, that is, they differ in only one binary digit. Gray codes can be generated for any number of digits by reflecting the Gray code for the case with one less digit, as shown in Table 36.13, for the case of 1, 2, and 3-bit codes. The advantage of a Gray scale coded lineal position sensor is illustrated in Fig. 36.1 for the eight-segment case.

36.9 Boolean Algebra

Boolean algebra provides a means to analyze and design binary systems and is based on the seven postulates given in Table 36.14. All other Boolean relationships are derived from these seven postulates. Expressed in graphical form, called *Venn diagrams*, the postulates appear more natural and logical. This benefit results from the two-dimensional pictorial representation freeing the expressions from the one-dimensional constraints imposed by lineal language format.

The OR and AND operations are normally designated by the arithmetic operator symbols $+$ and \diamond and referred to as sum and product operators in basic digital logic literature. However, in digital systems that perform arithmetic operations this notation is ambiguous and the symbols \vee for OR and \wedge for AND eliminates the ambiguity between arithmetic and boolean operators. Understanding the conceptual meaning of these boolean operations is probably best provided by set theory, which uses the union operator \cup for OR and the intersection operator \cap for AND. An element in a set that is the union of sets is a member of one set OR another of the sets in the union. An element in a set that is the intersection of sets is a member of one set AND a member of the other set in the intersection.

A set of theorems derived from the postulates facilitates further developments. The theorems are summarized in Table 36.15. Use of the postulates is illustrated by the proof of a theorem in Fig. 36.2.

TABLE 36.14 Boolean Postulates

| Postulate | Name | Meaning | Forms | |
|-----------|------------------|--|---|---|
| | | | (a) | (b) |
| 1 | Definition | \exists a set $\{K\} = \{a, b, \dots\}$ of two or more elements and two binary operators $\exists\{K\} = \{a, b, a+b, a \cdot b, \dots\}$ | OR $+$ \vee \cup | AND \cdot \wedge \cap |
| 2 | Substitution Law | $\text{expression}_1 = \text{expression}_2$ If one replaced by the other does not alter the value | | |
| 3 | Identity Element | \exists identity elements for each operator | $a + 0 = a$ | $a \cdot 1 = a$ |
| 4 | Commutativity | For every a and b in K | $a + b = b + a$ | $a \cdot b = b \cdot a$ |
| 5 | Associativity | For every $a, b,$ and c in K | $a + (b + c) = (a + b) + c$ | $a \cdot (b \cdot c) = (a \cdot b) \cdot c$ |
| 6 | Distributivity | For every $a, b,$ and c in K | $a + (b \cdot c) = (a + b) \cdot (a + c)$ | $a \cdot (b + c) = (a \cdot b) + (a \cdot c)$ |
| 7 | Complement | For every a in K \exists a complement in K \exists | $a + \bar{a} = 1$ | $a \cdot \bar{a} = 0$ |

TABLE 36.15 Boolean Theorems

| Theorem | | Forms | |
|---------|---------------------------|--|--|
| | | (a) | (b) |
| 8 | Idempotency | $a + a = a$ | $a \diamond a = a$ |
| 9 | Complement Theorem | $a + 1 = 1$ | $a \diamond 0 = 0$ |
| 10 | Absorption | $a + ab = a$ | $a(a + b) = a$ |
| 11 | Extra Element Elimination | $a + \bar{a}b = a + b$ | $a(\bar{a} + b) = ab$ |
| 12 | De Morgan's Theorem | $a + b = \bar{a} \diamond \bar{b}$ | $\overline{ab} = \bar{a} + \bar{b}$ |
| 13 | Consensus | $ab + \bar{a}c + bc = ab + \bar{a}c$ | $(a + b)(\bar{a} + c)(b + c) = (a + b)(\bar{a} + c)$ |
| 14 | Complement Theorem 2 | $ab + a\bar{b} = a$ | $(a + b)(a + \bar{b}) = a$ |
| 15 | Consensus 2 | $ab + a\bar{b}c = ab + ac$ | $(a + b)(a + \bar{b} + c) = (a + b)(a + c)$ |
| 16 | Consensus 3 | $ab + \bar{a}c = (a + c)(\bar{a} + b)$ | $(a + b)(\bar{a} + c) = ac + \bar{a}b$ |

TABLE 36.16 Number of Different Boolean Functions

| Variables n | Arguments 2^n | Functions 2^{2^n} |
|------------------|--------------------|------------------------|
| 0 | 1 | 2 |
| 1 | 2 | 4 |
| 2 | 4 | 16 |
| 3 | 8 | 256 |
| 4 | 16 | 65,536 |
| 5 | 32 | 4,194,304 |
| \vdots | \vdots | \vdots |

| | | |
|----|---------------------------------|--------------------------------|
| 1) | $x + x = x + x$ | IDENTITY |
| 2) | $= (x + x) \cdot 1$ | P3b IDENTITY ELEMENT EXISTENCE |
| 3) | $= (x + x) \cdot (x + \bar{x})$ | P7a COMPLEMENT EXISTENCE |
| 4) | $= x + x \cdot \bar{x}$ | P6a DISTRIBUTIVITY |
| 5) | $= x + 0$ | P7b COMPLEMENT EXISTENCE |
| 6) | $= x$ | P3a IDENTITY ELEMENT EXISTENCE |

FIGURE 36.2 Proof of Theorem 8: Idempotency (a): $x + x = x$.

| | | <table border="1"> <thead> <tr> <th>A</th> <th>B</th> <th>C</th> <th>$f(A, B, C)$</th> </tr> </thead> <tbody> <tr><td>0</td><td>0</td><td>0</td><td>0</td></tr> <tr><td>0</td><td>0</td><td>1</td><td>1</td></tr> <tr><td>0</td><td>1</td><td>0</td><td>0</td></tr> <tr><td>0</td><td>1</td><td>1</td><td>1</td></tr> <tr><td>1</td><td>0</td><td>0</td><td>1</td></tr> <tr><td>1</td><td>0</td><td>1</td><td>0</td></tr> <tr><td>1</td><td>1</td><td>0</td><td>1</td></tr> <tr><td>1</td><td>1</td><td>1</td><td>1</td></tr> </tbody> </table> | A | B | C | $f(A, B, C)$ | 0 | 0 | 0 | 0 | 0 | 0 | 1 | 1 | 0 | 1 | 0 | 0 | 0 | 1 | 1 | 1 | 1 | 0 | 0 | 1 | 1 | 0 | 1 | 0 | 1 | 1 | 0 | 1 | 1 | 1 | 1 | 1 |
|-----|---|--|--------------|---|---|--------------|---|---|---|---|---|---|---|---|---|---|---|---|---|---|---|---|---|---|---|---|---|---|---|---|---|---|---|---|---|---|---|---|
| A | B | C | $f(A, B, C)$ | | | | | | | | | | | | | | | | | | | | | | | | | | | | | | | | | | | |
| 0 | 0 | 0 | 0 | | | | | | | | | | | | | | | | | | | | | | | | | | | | | | | | | | | |
| 0 | 0 | 1 | 1 | | | | | | | | | | | | | | | | | | | | | | | | | | | | | | | | | | | |
| 0 | 1 | 0 | 0 | | | | | | | | | | | | | | | | | | | | | | | | | | | | | | | | | | | |
| 0 | 1 | 1 | 1 | | | | | | | | | | | | | | | | | | | | | | | | | | | | | | | | | | | |
| 1 | 0 | 0 | 1 | | | | | | | | | | | | | | | | | | | | | | | | | | | | | | | | | | | |
| 1 | 0 | 1 | 0 | | | | | | | | | | | | | | | | | | | | | | | | | | | | | | | | | | | |
| 1 | 1 | 0 | 1 | | | | | | | | | | | | | | | | | | | | | | | | | | | | | | | | | | | |
| 1 | 1 | 1 | 1 | | | | | | | | | | | | | | | | | | | | | | | | | | | | | | | | | | | |
| (a) | $f(A, B, C) = AB + A\bar{C} + \bar{A}C$ | | | | | | | | | | | | | | | | | | | | | | | | | | | | | | | | | | | | | |
| (b) | $f(0, 0, 1) = 0 \cdot 0 + 0 \cdot \bar{1} + \bar{0} \cdot 1$ $= 0 \cdot 0 + 0 \cdot 0 + 1 \cdot 1$ $= 0 + 0 + 1$ $= 1$ | (c) | | | | | | | | | | | | | | | | | | | | | | | | | | | | | | | | | | | | |

FIGURE 36.3 Example of forms for defining boolean functions: (a) boolean expression definition, (b) boolean expression evaluation, (c) truth table definition.

36.10 Boolean Functions

Boolean functions can be defined and represented in terms of boolean expressions and in terms of **truth tables** as illustrated in Fig. 36.3(a,c). Each form can be converted into the other form. The function values needed for the construction of the truth table can be obtained by evaluating the function as illustrated in Fig. 36.3(b). The reverse conversion will be illustrated subsequently.

For a given number of variables there are a finite number of boolean functions. Since each boolean variable can have two values, 0 or 1, a set of n variables has 2^n different values. A boolean function has a specific value for each of the possible values that the independent variables can have. Since there are two possible values for each value of the independent variables there are 2^{2^n} different boolean functions of n variables. The number of functions increases very rapidly with the number of independent variables, as shown in Table 36.16.

The 16 different boolean functions of the two independent variables are defined in algebraic form in Table 36.17 and in truth table form in Table 36.18.

36.11 Switching Circuits

Boolean functions can be performed by digital circuits. Circuits that perform complicated boolean functions can be subdivided into simpler circuits that perform simpler boolean functions. The circuits that perform the simplest boolean functions are taken as basic elements, called *gates* and are represented

TABLE 36.17 Functions of Two Variables Defined as Boolean Expressions

| | Name | Expression | Circuit Representation |
|----|-------------|---------------------------------------|------------------------|
| 0 | ALWAYS | 1 | |
| 1 | NEVER | 0 | |
| 2 | 1st Var | a | |
| 3 | 2nd Var | b | |
| 4 | NOT 1st Var | \bar{a} | |
| 5 | NOT 2nd Var | \bar{b} | |
| 6 | MIN-0/NOR | $\bar{a}\bar{b} = a \downarrow b$ | |
| 7 | MIN-1 | $a\bar{b}$ | |
| 8 | MIN-2 | $\bar{a}b$ | |
| 9 | MIN-3/AND | $a\bar{b}$ | |
| 10 | MAX-0/OR | $a\vee b$ | |
| 11 | MAX-1 | $a\vee\bar{b}$ | |
| 12 | MAX-2 | $\bar{a}\vee b$ | |
| 13 | MAX-3/NAND | $\bar{a}\bar{b} = a \uparrow b$ | |
| 14 | EXOR | $A \oplus b = a\bar{b} \vee \bar{a}b$ | |
| 15 | COIN | $a \ominus b = \overline{a \oplus b}$ | |

TABLE 36.18 Truth Tables for Two Variable Functions

| a | b | NOR | | AND | | | OR | | NAND | | | XOR | COIN | a | b | \bar{a} | \bar{b} | LO | HI |
|-----|-----|-------|-------|-------|-------|-------|-------|-------|-------|---|---|-----|------|-----|-----|-----------|-----------|----|----|
| | | m_0 | m_1 | m_2 | m_3 | M_0 | M_1 | M_2 | M_3 | | | | | | | | | | |
| 0 | 0 | 1 | 0 | 0 | 0 | 0 | 1 | 1 | 1 | 0 | 1 | 0 | 0 | 0 | 1 | 1 | 0 | 1 | |
| 0 | 1 | 0 | 1 | 0 | 0 | 1 | 0 | 1 | 1 | 1 | 0 | 0 | 0 | 1 | 1 | 0 | 0 | 1 | |
| 1 | 0 | 0 | 0 | 1 | 0 | 1 | 1 | 0 | 1 | 1 | 0 | 1 | 0 | 1 | 0 | 0 | 1 | 0 | 1 |
| 1 | 1 | 0 | 0 | 0 | 1 | 1 | 1 | 1 | 0 | 0 | 1 | 1 | 1 | 1 | 0 | 0 | 0 | 0 | 1 |

by specialized symbols. The circuit symbols for the gates that perform functions of two independent variables are shown in Table 36.17. The gates are identified by the adjective representing the operation they perform. The most common gates are the AND, OR, NAND, NOR, XOR, and COIN gates. The only nontrivial single input gate is the inverter or NOT gate. Gates are the basic elements from which more complicated digital logic circuits are constructed.

A logic circuit whose steady-state outputs depend only on the present steady-state inputs (and not on any prior inputs) is called a *combinational logic circuit*. To depend on previous inputs would require memory, thus a combinational logic circuit has no memory elements.

Boolean algebra allows any combinational logic circuit to be constructed solely with AND, OR, and NOT gates. Any combinational logic circuit may also be constructed solely with NAND gates, as well as solely with NOR gates.

36.12 Expansion Forms

The **sum of products (SP)** is a basic form in which all boolean functions can be expressed. The **product of sums (PS)** is another basic form in which all boolean functions can be expressed. An illustrative example is given in Figs. 36.4(b,c) for the example given in Fig. 36.4(a).

| TRUTH TABLE | | | |
|-------------|---|---|--------------|
| A | B | C | $f(A, B, C)$ |
| 0 | 0 | 0 | 0 |
| 0 | 0 | 1 | 1 |
| 0 | 1 | 0 | 0 |
| 0 | 1 | 1 | 1 |
| 1 | 0 | 0 | 1 |
| 1 | 0 | 1 | 0 |
| 1 | 1 | 0 | 1 |
| 1 | 1 | 1 | 1 |

| | |
|---|---|
| <p>(a) $f(A, B, C) = A(B + \bar{C}) + (\bar{A} + B)C$</p> | |
| <p>(b) P6b $\rightarrow f(A, B, C) = AB + A\bar{C} + \bar{A}C + BC$ T13a $\rightarrow f(A, B, C) = AB + A\bar{C} + \bar{A}C$</p> | <p>(c) P7b $\rightarrow f(A, B, C) = A(\bar{A} + B + \bar{C}) + (\bar{A} + B + \bar{C})C$ P6b $\rightarrow f(A, B, C) = (A + C)(\bar{A} + B + \bar{C})$</p> |
| <p>(d) P7a $\rightarrow f(A, B, C) = AB(C + \bar{C}) + A(B + \bar{B})\bar{C} + \bar{A}(B + \bar{B})C$ P6b $\rightarrow f(A, B, C) = ABC + AB\bar{C} + A\bar{B}C + \bar{A}BC + \bar{A}\bar{B}C$</p> | <p>(e) P7b $\rightarrow f(A, B, C) = (A + C + B\bar{B})(\bar{A} + B + \bar{C})$ P6a $\rightarrow f(A, B, C) = (A + B + C)(A + \bar{B} + C)(\bar{A} + B + \bar{C})$</p> |
| <p>(f) $f(A, B, C) = m_{111} + m_{110} + m_{100} + m_{011} + m_{001}$ $f(A, B, C) = \sum m(1, 3, 4, 6, 7)$</p> | <p>(g) $f(A, B, C) = M_{000} + M_{010} + M_{101}$ $f(A, B, C) = \prod(0, 2, 5)$</p> |

FIGURE 36.4 Examples of converting boolean functions between forms: (a) given example, (b) conversion to SP form, (c) conversion to PS form, (d) conversion to canonical SP form, (e) conversion to canonical PS form, (f) minterm notation/canonical SP form, (g) maxterm notation/canonical PS form.

Minterms are a special set of functions, none of which can be expressed in terms of the others. Each minterm has each of the variables in the complemented or the uncomplemented form ANDed together. An SP expansion in which only minterms appear is a canonical SP expansion. Figure 36.4(d) shows the development of the canonical SP expansion for the previous example. The canonical SP expansion may also be simply expressed by enumerating the minterms as shown in Fig. 36.4(f). Comparison of the truth table with the minterm expansion shows that each function value of 1 represents a minterm of the function and vice versa. All other function values are 0.

Maxterms are a special set of functions, none of which can be expressed in terms of the others. Each maxterm has each of the variables in the complemented or the uncomplemented form ORed together. A PS expansion in which only maxterms appear is a canonical PS expansion. Figure 36.4(e) shows the development of the canonical PS expansion for the previous example. The canonical PS expansion may also be simply expressed by enumerating the maxterms as shown in Fig. 36.4(g). Comparison of the truth table with the maxterm expansion shows that each function value of 0 represents a maxterm of the function and vice versa. All other function values are 1.

36.13 Realization

The different types of boolean expansions provide different circuits for implementing the generation of the function. A function expressed in the SP form is directly realized as an AND–OR **realization**, as illustrated in Fig. 36.5(a). A function expressed in the PS form is directly realized as an OR–AND realization as illustrated in Fig. 36.5(b). By using involution and deMorgan’s theorem the SP expansion can be expressed in terms of NAND–NAND and the PS expansion can be expressed in terms of NOR–NOR, as shown in Figs. 36.5(c,d). The variable inversions specified in the inputs can be supplied by either NAND or NOR gates, as shown in Figs. 36.5(g,h), which then provide the NAND–NAND–NAND and the NOR–NOR–NOR circuits shown in Figs. 36.5(i,j).

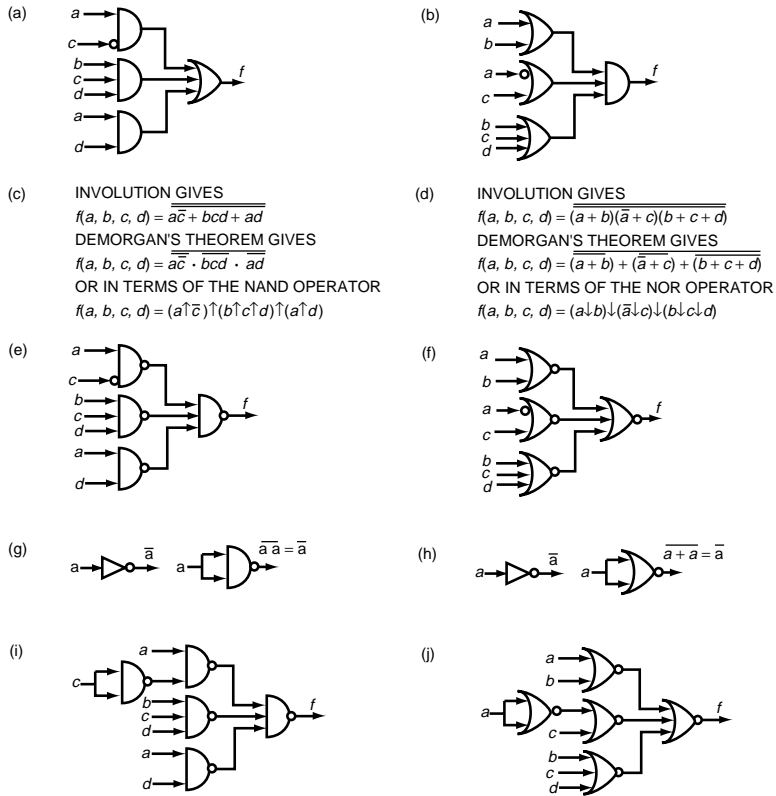

FIGURE 36.5 Examples of realizations based on various expansion forms: (a) AND-OR realization of $f(a, b, c, d) = a\bar{c} + bcd + ad$, (b) OR-AND realization of $f(a, b, c, d) = (a + b)(\bar{a} + c)(b + c + d)$, (c) AND-OR conversion to NAND-NAND, (d) OR-AND conversion to NOR-NOR, (e) NAND-NAND realization of $f(a, b, c, d) = a\bar{c} + bcd + ad$, (f) NOR-NOR realization of $f(a, b, c, d) = (a + b)(\bar{a} + c)(b + c + d)$, (g) NAND gate realization of NOT gate, (h) NOR gate realization of NOT gate, (i) NAND-NAND-NAND realization of $f(a, b, c, d) = a\bar{c} + bcd + ad$, (j) NOR-NOR-NOR realization of $f(a, b, c, d) = (a + b)(\bar{a} + c)(b + c + d)$.

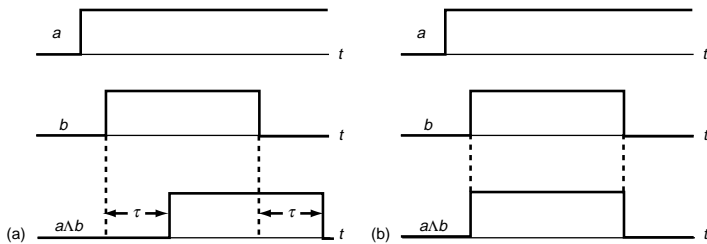

FIGURE 36.6 Timing diagrams for the AND gate circuit: (a) microtiming diagram, (b) macrotiming diagram.

36.14 Timing Diagrams

Timing diagrams are of two major types. A **microtiming diagram** has a time scale sufficiently expanded in space to display clearly the gate delay, such as shown in Fig. 36.6(a) for an AND gate. A **macrotiming diagram** has a time scale sufficiently contracted in space so that the gate delay is not noticeable, as shown in Fig. 36.6(b) for an AND gate.

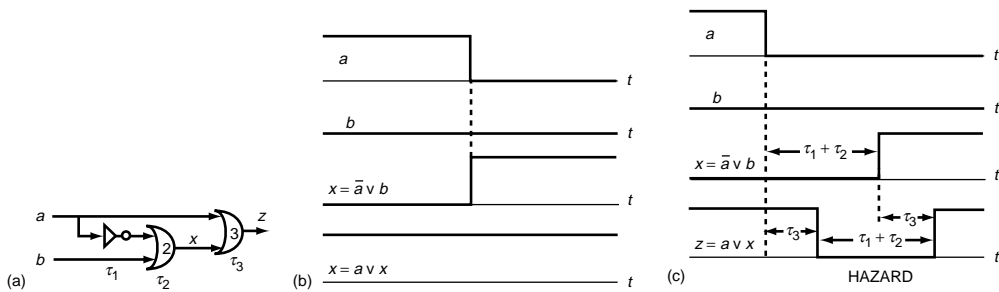

FIGURE 36.7 Example of a hazard (output variation) caused by unequal delay paths: (a) circuit for illustrating a hazard, (b) ideal case, no delays, $\tau_1 = \tau_2 = \tau_3 = 0$, no hazard introduced; (c) signal paths with different delays, $\tau_1 + \tau_2 > \tau_3$, hazard introduced.

The advantage of the macrotiming diagram is that larger time intervals can be represented in a given spatial size and they can be more quickly developed. The disadvantage is that they do not display the information required for speed limitation considerations.

36.15 Hazards

The variation in signal delays through different circuit elements in different paths may cause the output signal to fluctuate from that predicted by non-time-dependent truth tables for the elements. This fluctuation can cause an undesired result and, hence, is a *hazard*. This is illustrated in Fig. 36.7.

36.16 K-Map Formats

In a truth table the values of a boolean function are displayed in a one-dimensional array. A **K-map** contains the same information arranged in as many effective dimensions as there are independent variables in the function. The special form of the representation provides a simple procedure for minimizing the expression and, hence, the number of components required for realizing the function in a given form. The function is represented in a space that in a Venn diagram is called the *universal set*. The K-map is a special form of Venn diagram. The space is divided into two halves for each of the independent variables. The division of the space into halves is different for each independent variable. For one independent variable the space is divided into two different identical size regions, each of which represents a minterm of the function. For n independent variables the space is divided into 2^n different identical size regions, one for each of the 2^n minterms of the function. This and associated considerations are illustrated in a sequence of figures from Figs. 36.8–36.15.

Figure 36.8 shows one-variable K-map formats. Figure 36.8(a) shows the space divided into two equal areas, one for each of the two minterms possible for a single variable. The squares could also be identified by the variable placed external to the space to designate the region that is the domain of the variable, with the unlabeled space being the domain of the complement of the variable, as shown in Fig. 36.8(b). Another way of identifying the regions is by means of the minterm number the area is for, as shown in Fig. 36.8(c). Still another way is to place the values the variable can have as a scale alongside the space, as shown in Fig. 36.8(d). The composite labeling, shown in Fig. 36.8(e), appears redundant but is often useful because of the different modes of thought used with the different label types. Putting the actual minterm expressions inside each square is too cluttering and is rarely used except as an aid in teaching the theory of K-maps. The use of minterm numbers, although widely used, also clutters up the diagram, and the methodology presented here makes their use superfluous once the concepts are understood.

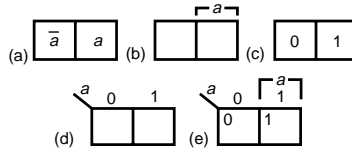

FIGURE 36.8 One variable *K*-map forms: (a) internal minterm labels, (b) external domain label, (c) internal minterm number labels, (d) external scale label, (e) composite labeling.

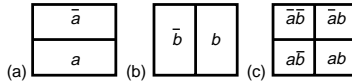

FIGURE 36.9 Two-variable *K*-map format construction: (a) domains for *a*, (b) domains for *b*, composite.

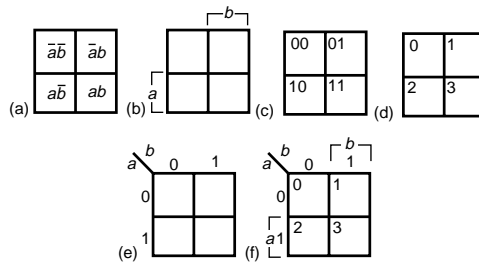

FIGURE 36.10 Two variable *K*-map formats: (a) minterm labels, (b) domain labels, (c) minterm binary labels, (d) minterm decimal labels, (e) scale labels, (f) composite labeling.

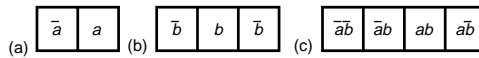

FIGURE 36.11 Two-variable *K*-map alternate format construction: (a) domains for *a*, (b) domains for *b*, (c) composite.

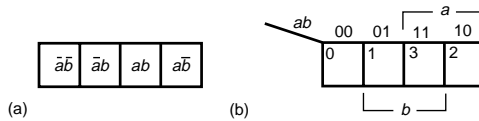

FIGURE 36.12 Two-variable *K*-map alternate format: (a) minterm labels, (b) composite labeling.

The organization of a two-variable *K*-map format is illustrated in Fig. 36.9. The space is subdivided vertically into two domains for the variable *a* and its complement, and is subdivided horizontally for the variable *b* and its complement, as shown in Figs. 36.9(a,b). The composite subdivisions for both variables together with the expressions for the two-variable minterms are shown in Fig. 36.9(c).

The different formats for identifying the areas for the two-variable case are shown in Fig. 36.10. Of particular interest is the comparison of the binary and decimal minterm number labels. The binary minterm number is simply the **catenation** of the vertical and horizontal scale number for the position. It is the use of this identity that makes internal labels in the square totally superfluous.

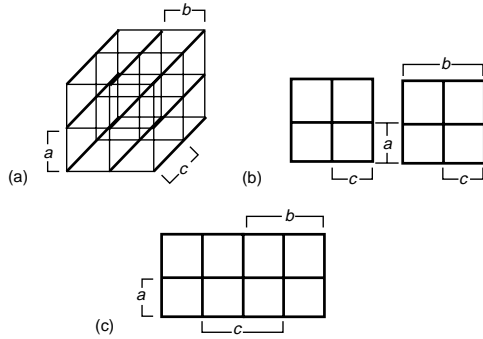

FIGURE 36.13 Three-variable K -map formats: (a) three-dimensional, (b) three-dimensional left and right halves, (c) two-dimensional.

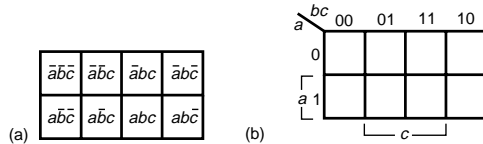

FIGURE 36.14 Three variable two-dimensional K -map formats: (a) minterm labels, (b) composite scale labels.

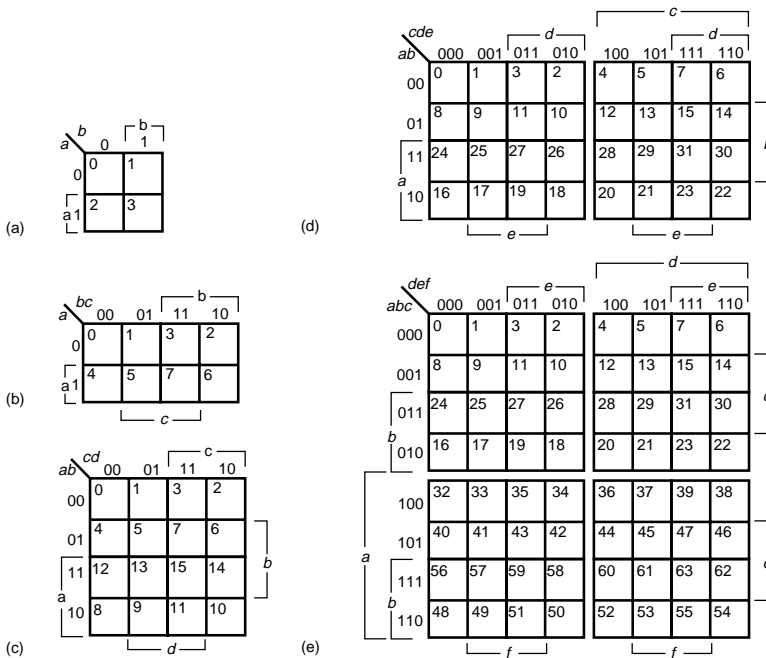

FIGURE 36.15 Formats for K -maps for functions of 2–6 independent variables with conformal coordinate scales: (a) two-variable case $f(a, b)$, three-variable case $f(a, b, c)$; (c) four-variable case $f(a, b, c, d)$; (d) five-variable case $f(a, b, c, d, e)$; (e) six-variable case $f(a, b, c, d, e, f)$.

An alternate way of subdividing the space for the two-variable case is illustrated in Fig. 36.11 and labeling alternatives in Fig. 36.12. The configuration employed in Fig. 36.9 uses two dimensions for two variables, whereas the configuration employed in Fig. 36.11 uses one-dimension for two variables. The two-dimensional configuration appears to be more logical and is more convenient to use than the one-dimensional configuration for the case of two variables. For the case of a larger number of variables the configuration in Fig. 36.12 offers special advantages, as will be shown.

The organization of three-variable *K*-map formats is illustrated in Fig. 36.13. It is logical to introduce an additional space dimension for each additional independent variable as depicted in Fig. 36.13(a); however, the excessive inconvenience of working with such formats makes them impractical. To make the mapping process practical it must be laid out in two dimensions. This can be done in two ways. One way is to take the individual slices of the three-dimensional configuration and place them adjacent to each other as illustrated in Fig. 36.13(b). Another way is to use the one-dimensional form for two variables, illustrated in Fig. 36.12, as shown in Fig. 36.13(c). For the case of three and four independent variables the format given in Fig. 36.13(c) is more convenient and for further independent variables that of Fig. 36.13(b) is convenient. These are all illustrated in Fig. 36.15. Labeling for three independent variables is given in Fig. 36.14.

The independent boolean variables in **conformal coordinate scales** have exactly the same order as in the boolean function argument list, as depicted in Fig. 36.15. Conformal assignment of the independent variables to the *K*-map coordinate scales makes the catenated position coordinates for a minterm (or maxterm) identical to the minterm (or max-term) number. Utilization of this identity eliminates the need for the placement of minterm identification numbers in each square or for a separate position identification table. This significantly decreases the time required to construct *K*-maps and makes their construction less error prone. The minterm number, given by the catenation of the vertical and horizontal coordinate numbers, is obvious if the binary or octal number system is used.

36.17 *K*-Maps and Minimization

A function is mapped into the *K*-map format by entering the value for each of the minterms in the space for that minterm. The function values can be obtained in various ways such as from the truth table for the function, the Boolean expression for the function, or from other means by which the function may be defined. An example is given for the truth table given in Fig. 36.4(a), which is repeated here in Fig. 36.16(a) and whose *K*-map is shown in various forms in Figs. 36.16(b–d).

The function can also be mapped into a conformally scaled *K*-map directly from the canonical expansion, this being essentially the same process as entering the minterms (or maxterms) from the truth table. The function may also be directly mapped from any PS or SP expansion form. Another means of obtaining the *K*-map is to formulate it as a function table, as illustrated for the multiplication of 1- and 2-b numbers in Fig. 36.17.

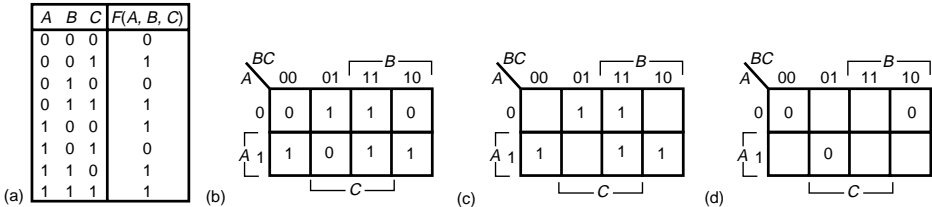

FIGURE 36.16 Three-variable *K*-map example: (a) truth table, (b) *K*-map with all values shown, (c) minterm *K*-map, (d) maxterm *K*-map.

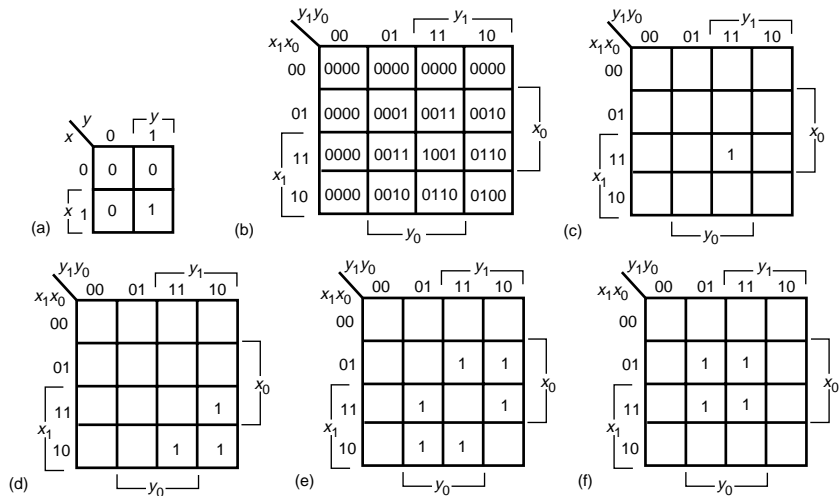

FIGURE 36.17 Examples of K -maps formulated as function tables: (a) K -map for the product of two 1-b numbers $P = x * y$; (b) composite K -map for the product of two 2-b numbers, $P_3 P_2 P_1 P_0 = x_1 x_0 * y_1 y_0$; (c) K -map for the digit P_3 of the product of two 2-b numbers; (d) K -map for the digit P_2 of the product of two 2-b numbers; (e) K -map for the digit P_1 of the product of two 2-b numbers; (f) K -map for the digit P_0 of the product of two 2-b numbers.

36.18 Minimization with K -Maps

The key feature of K -maps that renders them convenient for minimization is that minterms, which are spatially adjacent in the horizontal or vertical directions, are logically adjacent. Logically adjacent minterms are identical in all variables except one. This allows the two minterms to be combined into a single terms with one less variable. This is illustrated in Fig. 36.18. Two adjacent minterms combine into a first-order **implicant**. A first-order implicant is the combination of all of the independent variables but one. In this example, the first-order implicant expressed in terms of minterms contains eight literals but the minimized expression contains only three literals. The circuit realization for the OR combination of the two minterms has two AND gates and one OR gate, whereas the realization for the equivalent implicant requires only a single AND gate.

The combination of minterms into first-order implicants can be represented more compactly by using the single symbol minterm notation with the subscript that identifies the particular minterm expressed in binary, as illustrated in Fig. 36.18(d).

Two adjacent first-order implicants can be combined into a second-order implicant as illustrated in Fig. 36.19. A second-order implicant contains all of the independent variables except two. In general, an n th-order implicant contains all of the variables except n and requires an appropriately grouped set of 2^n minterms.

Minterms that are at opposite edges of the same row or column are logically adjacent since they differ in only one variable. If the plane space is rolled into a cylinder with opposite edges touching, then the logically adjacent edge pairs become physically adjacent. For larger numbers of variables using K -maps with parallel sheets, the corresponding positions on different sheets are logically adjacent. If the sheets are considered as overlaid, the corresponding squares are physically adjacent. The minimized expression is obtained by covering all of the minterms with the fewest number of largest possible implicants. A minterm is a zero-order implicant. Figure 36.20 illustrates a variety of examples. A **don't care** is a value that never occurs or if it does occur it is not used, and hence, it does not matter what its value is. Don't cares are also included to illustrate that they can be used to simplify expressions by taking their values to maximize the order of the implicants.

Maxterm K -maps can also be utilized to obtain minimized expressions by combining maxterms into higher order implicants, as illustrated for the example in Fig. 36.21.

36.19 Quine–McCluskey Tabular Minimization

The *K*-map minimization method is too cumbersome for more than six variables and does not readily lend itself to computerization. A tabular method, which can be implemented for any number of variables and which lends itself to computer program implementation, consists of the following steps:

1. List all the minterms in the boolean function (with their binary code) organized into groups having the same number of 1s. The groups must be listed in consecutive order of the number of 1s.
2. Construct the list of first-order implicants. Use flags to indicate which minterms, don't cares, or implicants go with which functions. (Only minterms in adjacent groups have the possibility of being adjacent and, hence, this ordering method significantly reduces the labor of compiling the implicants.)
3. Construct the list of second-order implicants and the lists of all higher order implicants, until no higher order implicants can be constructed.
4. Construct the *prime implicant chart*. The prime implicant chart shows what prime implicants cover which minterms.
5. Select the minimum number of largest prime implicants that cover the minterms.

This procedure is illustrated in Fig. 36.22 for the simultaneous minimization of two boolean functions.

| GIVEN $F(A, B, C, D) = \Sigma m(2, 6, 7, 8) + d(0, 4, 5, 12, 13)$ and $G(A, B, C, D) = \Sigma m(2, 4, 5) + d(6, 7, 8, 10)$ | | | | | | | | | | | | | |
|--|----------|-----------|-------|----|-----------------------------|-----------|-------|----|--------------|-----------------------------|-------|----|--|
| ZERO-ORDER IMPLICANT LIST. | | | | | FIRST-ORDER IMPLICANT LIST. | | | | | SECOND-ORDER IMPLICANT LIST | | | |
| NO. OF 1s | MIN-TERM | CODE ABCD | FLAGS | PI | IMPLICANTS | CODE ABCD | FLAGS | PI | IMPLICANTS | CODE ABCD | FLAGS | PI | |
| 0 | 0 | 0000 | F- | √ | 0, 2 | 00-0 | F- | √ | 0, 2, 4, 6 | 0-0 | F- | 1 | |
| | 2 | 0010 | FG | √ | 0, 4 | 0-00 | F- | √ | 0, 4, 8, 12 | -00 | F- | 2 | |
| 1 | 4 | 0100 | FG | √ | 0, 8 | -000 | F- | √ | 4, 5, 6, 7 | 01- | FG | 3 | |
| | 8 | 1000 | FG | √ | 2, 6 | 0-10 | FG | 5 | 4, 5, 12, 13 | -10- | F- | 4 | |
| | 5 | 0101 | FG | √ | 2, 10 | -010 | -G | 6 | | | | | |
| 2 | 6 | 0110 | FG | √ | 4, 5 | 010- | FG | √ | | | | | |
| | 10 | 1010 | -G | √ | 4, 6 | 01-0 | FG | √ | | | | | |
| | 12 | 1100 | F- | √ | 4, 12 | -100 | F- | √ | | | | | |
| | 7 | 0111 | FG | √ | 8, 10 | 10-0 | -G | 7 | | | | | |
| 3 | 13 | 1101 | F- | √ | 8, 12 | 1-00 | F- | √ | | | | | |
| | | | | | 5, 7 | 01-1 | FG | √ | | | | | |
| | | | | | 5, 13 | -101 | F- | √ | | | | | |
| | | | | | 6, 7 | 011- | FG | √ | | | | | |
| | | | | | 12, 13 | 110- | F- | √ | | | | | |

| | | | | | | | | | | | | | | | | | | | | | | | | | | | | | | | | | | | | | | | | | | | | | | | | | | | | | | | | | | | | | | | | | | | | | | | | | | | | | | | | | | | | | | | | | | | |
|--|----|---|---|---|---|---|---|---|---|--|---|--|---|---|---|---|---|---|---|--|---|---|---|---|--|--|--|--|--|--|---|---|--|--|--|---|--|--|--|--|---|---|--|--|--|--|--|--|---|---|---|--|--|--|--|--|--|--|--|--|---|----|---|---|--|--|---|--|--|--|---|--|--|--|--|--|--|--|--|--|---|--|--|--|--|--|--|--|--|--|--|
| <p style="text-align: center;">PRIME IMPLICANT CHART</p> <table border="1" style="margin-left: auto; margin-right: auto;"> <tr> <td></td> <td></td> <td colspan="4" style="text-align: center;">F</td> <td colspan="4" style="text-align: center;">G</td> </tr> <tr> <td>m</td> <td></td> <td>2</td> <td>6</td> <td>7</td> <td>8</td> <td>2</td> <td>4</td> <td>5</td> <td></td> </tr> <tr> <td>1</td> <td>+</td> <td>X</td> <td>X</td> <td></td> <td></td> <td></td> <td></td> <td></td> <td></td> </tr> <tr> <td>2</td> <td>+</td> <td></td> <td></td> <td></td> <td>X</td> <td></td> <td></td> <td></td> <td></td> </tr> <tr> <td>3</td> <td>+</td> <td></td> <td></td> <td></td> <td></td> <td></td> <td></td> <td>X</td> <td>X</td> </tr> <tr> <td>4</td> <td></td> <td></td> <td></td> <td></td> <td></td> <td></td> <td></td> <td></td> <td></td> </tr> <tr> <td>5</td> <td>++</td> <td>X</td> <td>X</td> <td></td> <td></td> <td>X</td> <td></td> <td></td> <td></td> </tr> <tr> <td>6</td> <td></td> <td></td> <td></td> <td></td> <td></td> <td></td> <td></td> <td></td> <td></td> </tr> <tr> <td>7</td> <td></td> <td></td> <td></td> <td></td> <td></td> <td></td> <td></td> <td></td> <td></td> </tr> </table> | | | F | | | | G | | | | m | | 2 | 6 | 7 | 8 | 2 | 4 | 5 | | 1 | + | X | X | | | | | | | 2 | + | | | | X | | | | | 3 | + | | | | | | | X | X | 4 | | | | | | | | | | 5 | ++ | X | X | | | X | | | | 6 | | | | | | | | | | 7 | | | | | | | | | | <p style="text-align: center;">MINIMUM SP EXPANSIONS</p> $F = P_2 + P_3 + P_5$ $= \overline{C}\overline{D} + \overline{A}B + \overline{A}C\overline{D}$ $G = P_3 + P_5$ $= \overline{A}B + \overline{A}C\overline{D}$ |
| | | F | | | | G | | | | | | | | | | | | | | | | | | | | | | | | | | | | | | | | | | | | | | | | | | | | | | | | | | | | | | | | | | | | | | | | | | | | | | | | | | | | | | | | | | | | | |
| m | | 2 | 6 | 7 | 8 | 2 | 4 | 5 | | | | | | | | | | | | | | | | | | | | | | | | | | | | | | | | | | | | | | | | | | | | | | | | | | | | | | | | | | | | | | | | | | | | | | | | | | | | | | | | | | | |
| 1 | + | X | X | | | | | | | | | | | | | | | | | | | | | | | | | | | | | | | | | | | | | | | | | | | | | | | | | | | | | | | | | | | | | | | | | | | | | | | | | | | | | | | | | | | | | | | | |
| 2 | + | | | | X | | | | | | | | | | | | | | | | | | | | | | | | | | | | | | | | | | | | | | | | | | | | | | | | | | | | | | | | | | | | | | | | | | | | | | | | | | | | | | | | | | | | | | |
| 3 | + | | | | | | | X | X | | | | | | | | | | | | | | | | | | | | | | | | | | | | | | | | | | | | | | | | | | | | | | | | | | | | | | | | | | | | | | | | | | | | | | | | | | | | | | | | | | |
| 4 | | | | | | | | | | | | | | | | | | | | | | | | | | | | | | | | | | | | | | | | | | | | | | | | | | | | | | | | | | | | | | | | | | | | | | | | | | | | | | | | | | | | | | | | | | | |
| 5 | ++ | X | X | | | X | | | | | | | | | | | | | | | | | | | | | | | | | | | | | | | | | | | | | | | | | | | | | | | | | | | | | | | | | | | | | | | | | | | | | | | | | | | | | | | | | | | | | |
| 6 | | | | | | | | | | | | | | | | | | | | | | | | | | | | | | | | | | | | | | | | | | | | | | | | | | | | | | | | | | | | | | | | | | | | | | | | | | | | | | | | | | | | | | | | | | | |
| 7 | | | | | | | | | | | | | | | | | | | | | | | | | | | | | | | | | | | | | | | | | | | | | | | | | | | | | | | | | | | | | | | | | | | | | | | | | | | | | | | | | | | | | | | | | | | |

FIGURE 36.22 Illustration of the Quine–McCluskey method of simultaneous minimization.

Defining Terms

Base: The number of different values a single digit may have. The number a digit must be multiplied by to move it one digit to the left, also called the radix.

Binary-coded decimal (BCD): Each decimal digit is expressed individually in binary form.

Catenation: Symbols strung together to form a larger sequence, as the characters in a word and the digits in a number.

Code: The representation in one alphabet of something in another alphabet.

Complement: The quantity obtained by subtracting a number from the largest quantity that can be expressed in the specified number of digits in a given number system.

Conformal: The same arrangement of a set of quantities in two different contexts.

Digit: A character that represents quantitative information.

Don't care: A value that can be represented either as a minterm or a maxterm.

Gray code: A set of codes having the property of logical adjacency.

Implicant: A first-order implicant is a pair of logically adjacent minterms. A second-order implicant is a set of logically adjacent first-order implicants and so on.

Integer: Any number that can be expressed solely in terms of digits.

Fraction: Any number divided by a larger number.

K-map: An arrangement of space into equal size units, each of which represents a minterm (or maxterm) such that each physically adjacent square is also logically adjacent.

Logically adjacent: Any two codes having the same number of digits for which they differ in the value of only one of the digits.

Macrotiming diagram: A graphical display showing how the waveforms vary with time, but with a time scale that does not have sufficient resolution to display the delays introduced by the individual basic elements of the digital circuit.

Maxterm: A function of a set of boolean variables that has a low value for only one combination of variable values and has a high value for all other combinations of the variable values.

Microtiming diagram: A graphical display showing how the waveforms vary with time, but with a time scale that has sufficient resolution to display clearly the delays introduced by the individual basic elements of the digital circuit.

Minterm: A function of a set of boolean variables that has a high value for only one combination of variable values and has a low value for all other combinations of the variable values.

Overflow: That part of a numerical operation result that does not fit into the allocated field.

Parity bit: An extra bit catenated to a code and given a value such that the total number of high bits is even for even parity and odd for odd parity.

Product of sums (PS): The AND combination of terms, which are OR combinations of boolean variables.

Prime implicant: An implicant that is not part of a larger implicant.

Radix: The number of different values that a digit can have in a number system.

Reduced radix: The largest value a digit can have in a number system. It is one less than the radix.

Real number: A number that has a fractional part and an integer part.

Realization: A circuit that can produce the value of a function.

Sum of products (SP): The OR combination of terms, which are AND combinations of Boolean variables.

Truth table: The table of values that a boolean function can have for which the independent variables considered as a multidigit number are arranged in consecutive order.

References

- Hayes, J.P. 1993. *Introduction of Digital Logic Design*. Addison-Wesley, Reading, MA.
- Humphrey, W.S., Jr. 1958. *Switching Circuits with Computer Applications*. McGraw-Hill, New York.
- Hill and Peterson. 1974. *Introduction to Switching Theory and Logical Design*, 2nd ed. Wiley, New York.
- Johnson and Karim. 1987. *Digital Design a Pragmatic Approach*. Prindle, Weber and Schmidt, Boston.
- Karnaugh, M. 1953. The map method for synthesis of combinational logic circuits. *AIEE Trans. Comm. Elec.* 72 (Nov.): 593–599.
- Mano, M.M. 1991. *Digital Design*. Prentice-Hall, Englewood Cliffs, NJ.
- McClusky, E.J. 1986. *Logic Design Principles*. Prentice-Hall, Englewood Cliffs, NJ.
- Mowle, F.J. 1976. *A Systematic Approach to Digital Logic Design*. Addison-Wesley, Reading, MA.
- Nagle, Carrol, and Irwin. 1975. *An Introduction to Computer Logic*, 2nd ed. Prentice-Hall, Englewood Cliffs, NJ.
- Pappas, N.L. 1994. *Digital Design West*, St. Paul, MN.
- Roth, C.H., Jr. 1985. *Fundamentals of Logic Design*, 3rd ed. West, St. Paul, MN.
- Sandige, R.S. 1990. *Modern Digital Design*. McGraw-Hill, New York.

Shaw, A.W. 1991. *Logic Circuit Design*. Saunders, Fort Worth, TX.

Wakerly, 1990. *Digital Design Principles and Practices*. Prentice-Hall, Englewood Cliffs, NJ.

Further Information

Further information on basic logic concepts and combinational logic design can be found in occasional articles in the following journals:

Lecture Notes in Computer Science (annual)

International Journal of Electronics (monthly)

IEEE Transactions on Education (quarterly)

IEEE Transactions on Computers (monthly)

IEEE Transactions on Software Engineering (monthly)

IEEE Transactions on Circuits and Systems 1. Fundamental Theory and Applications (monthly)

37

System Interfaces

- 37.1 Background
 - Terminology and Definitions • Serial vs. Parallel
 - Bit Rate vs. Baud Rate • Synchronous vs. Asynchronous • Data Flow-Control • Handshaking
 - Communication Protocol • Error Handling
 - Simplex, Half-Duplex, Full-Duplex • Unbalanced vs. Balanced Transmission • Point-to-Point vs. Multi-Point • Serial Asynchronous Communications
 - The Universal Asynchronous Receiver Transmitter (UART)
- 37.2 TIA/EIA Serial Interface Standards
 - RS-232 Serial Interface • Functional Description of Selected Interchange Circuits • RS-422 and RS-485 Interfaces
- 37.3 IEEE 488—The General Purpose Interface Bus (GPIB)
 - Introduction • GPIB Hardware • Controllers, Talkers, and Listeners • Interface Management Lines • Handshake Lines • Data Lines DIO1-DIO8 (8 lines) • Addressing of GPIB Devices

M.J. Tordon

The University of New South Wales

J. Katupitiya

The University of New South Wales

This chapter deals with asynchronous serial interfaces described by interface standards RS-232, RS-422, and RS-485 and with the general-purpose parallel interface bus described by IEEE-488 standard. The chapter also provides background information, terminology and parameters, which are important in the design of system interfaces for mechatronic systems.

37.1 Background

Modern mechatronic systems comprise a number of subsystems, which rely heavily on digital data communications. Different levels of complexity of these systems means that the requirement for data communications range from a simple communication between two devices to systems with a large number of subsystems, where each subsystem communicates directly or indirectly with other subsystems using a communication network. Depending on the proximity of subsystems, different requirements are placed on data communication channels, the physical implementation of channels, and interfaces between these devices. [Figure 37.1](#) shows a schematic diagram of a simple data communication system connecting two devices.

A data source creates the data to be transmitted to the destination system and may convert the data into a specific form. The originating system usually does not create the data in a form suitable for transmission over transmission lines. This is left to the transmitter, which transforms the data into a signal suitable for transmission over a specific type of transmission line. The transmission line is generally implemented using electrical wiring but can involve a variety of physical medium including radio frequency, infrared, and sound signals. A transmission line provides a physical medium connecting the two systems. A receiver accepts the

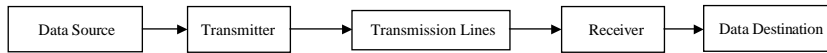

FIGURE 37.1 A schematic diagram of a simple data communication system.

signal and converts it to the data form suitable to be passed onto the destination system. A data destination processes the data in order to recover the original information. From the previous information, it follows that even in the case of a simple data communication system a number of subsystems is involved in the communication task.

Terminology and Definitions

Interface: The common boundary between two subsystems is called an interface, and as can be seen in Fig. 37.1, a number of interfaces can be involved even in a simple communication system.

Bit: The simplest form of data is one bit, which can take one of the two values 0 or 1, and hence is called binary data. All information in modern digital computers is stored in binary form.

Byte: A fixed number of bits (usually 8), which can be treated by a computer as a unit.

Character: Historically, the information is expressed in terms of characters. A character is a member of a character set. An example of a character set is the set of characters in the English language.

Character code: Individual characters from the selected character set are encoded in digital computers as binary numbers. One of the most widely used character set codes is the American Standard Code for Information Interchange (ASCII).

Serial vs. Parallel

The basic unit of information to be transferred between subsystems is usually a character. For short distances, multiple parallel lines can be used to carry out simultaneous transmission of all the bits of a character. For the transmission of data over long distances, the cost of multiple data lines is often prohibitive and it is normal to serialize the data so that it can be passed over a single data path as a stream of bits.

Bit Rate vs. Baud Rate

The speed of data transmission is usually expressed as a number of data bits transmitted per second and is called an effective bit rate with a unit bps. Larger units like kbps (1,000 bps) and Mbps (1,000,000 bps) are commonly used. The baud rate is a signaling rate and is expressed as a number of times per second that the signal transmitted over a data transmission line changes state. For systems using only two states, the signaling bit rate is equivalent to the baud rate. Distinction should be made between the effective data transmission bit rate and the signaling bit rate. In asynchronous serial communications, the effective data transmission bit rate can be significantly lower than the signaling bit rate because of the inclusion of start, stop, and parity bits. To maximize the transmission speed over a serial line, modern communication systems use signals with more than two states, thus achieving higher signaling bit rates. For example, if the transmission signal uses 16 states, then the signaling bit rate is four times higher than the baud rate. The terms baud rate, signaling bit rate, and effective data transmission rate are often used interchangeably which leads to confusion.

Synchronous vs. Asynchronous

For both parallel and serial interface, the problem of synchronization must be solved. The communication over a transmission line can be done either in synchronous or asynchronous communication mode. In synchronous communication mode, the transmission of data is synchronized with a clock; thus, the transmission is occurring at regular time intervals. Since the data transmission takes place at fixed times, the

completion of data transfer does not have to be acknowledged. In asynchronous transmission mode, the two systems are using clocks, that are not synchronized and may run at frequencies slightly out of step. Thus, for asynchronous systems, data validation requires a separate scheme called handshaking.

Data Flow-Control

Another problem in asynchronous communication systems is the speed of data processing. If one system is significantly slower in processing the data, a flow-control must be implemented to avoid data loss. Data flow-control may require additional handshaking. Similar problems may arise in multitasking systems in which, due to other tasks, the system is unable to handle incoming data during the period of high workload.

Handshaking

In order to ensure efficient transmission of data without errors, the sending system will use a separate signal to indicate that valid data has been presented to the interface. Because the instant at which the receiving device can process the data is not known, the sending device must wait for an acknowledgment signal before presenting new data to the interface. The handshaking can be implemented in either hardware or software.

Communication Protocol

Operation of a communication system is governed by a set of rules which must ensure reliable data transfer without errors and data loss. Such a set of rules is called a communication protocol.

Error Handling

Data transmitted over a communication line are subjected to noise and can thus be corrupted. Since it is essential to maintain the integrity of data, a number of different schemes for error detection have been developed. The simplest remedy after error detection is retransmission of the corrupted data. More sophisticated communication protocols can involve complex error correction schemes implemented at protocol level.

Simplex, Half-Duplex, Full-Duplex

In its simplest form, communication can be established with a single pair of wires. The data transmission mode, in which data can pass in one direction only, is called simplex or unidirectional channel. In most applications it is required that the communication takes place in both directions. If the cost of the data transmission line is high, it can be arranged that signals can pass in either direction over a single transmission line using additional circuitry on both ends of the transmission line but only in one direction at a time. This type of data communication mode is called half-duplex. Additional handshaking is required to implement the time sharing of the transmission line.

If signals can pass in either direction over a single transmission line simultaneously, the data communication mode is called full-duplex. An example of a full-duplex is a telephone line where the two channels are created as separate frequency bands. Cost permitting, two separate transmission lines can be established in which case the full-duplex communication is conducted over two simplex channels. This requires duplication of all the functions of a simple data communication system as shown in [Fig. 37.1](#).

Unbalanced vs. Balanced Transmission

Implementation of the electrical transmission line can take two basic forms, unbalanced (single-ended) or balanced (differential). For unbalanced operation, a single conductor is used to carry the signal voltage, which is referenced to a signal ground. The signal ground is usually common return for all signals in the interface. [Figure 37.2](#) shows an example of an unbalanced data transmission system with two channels and three wires. Symbol D represents driver and symbol R receiver. Unbalanced data transmission is

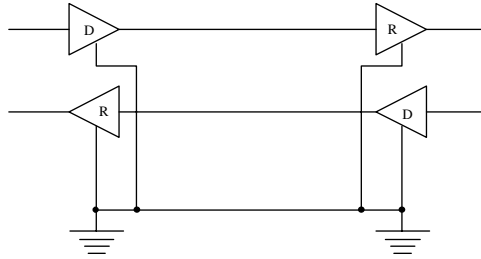

FIGURE 37.2 Example of an unbalanced data transmission.

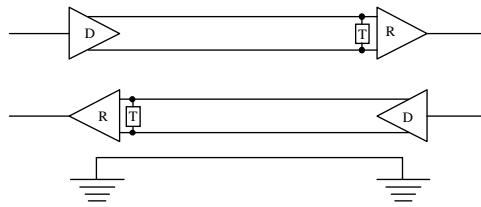

FIGURE 37.3 Example of a balanced data transmission.

relatively inexpensive because, for multiple signal lines, only one common line is required; however, this type of interface is susceptible to induced and ground noise and is not suitable for high-speed communication over long distances. The ground noise is associated with voltage drop in a common return line, while the induced noise comes from interfering electromagnetic fields. Both types of noise can come from external sources or from neighboring transmission circuits. A remedy can be the use of coaxial cable, shielded cable, and/or the use of separate return lines for individual signals. These additional measures tend to increase the cost of the interface.

The balanced (differential) transmission mode has much better noise immunity than the unbalanced mode. Two complementary signal lines carry the data signal. The implementation often involves two single-ended drivers driving a twisted-pair transmission line. Figure 37.3 shows an example of balanced data transmission with two channels and five wires. As in Fig. 37.2, symbol D represents driver and symbol R receiver. Symbol T represents termination resistor. Use of a termination resistor at the receiver end of the transmission line is critical for high-speed communications over long distances as unterminated transmission lines can cause severe distortion of signals. Both induced and ground noises appear on both conductors as common-mode signals that are rejected by the differential receiver. The differential signals carrying data are amplified while the common-mode noise signals are suppressed. As a result, the balanced data transmission lines can be used for longer distances with higher transmission rates. Both unbalanced and balanced interfaces shown in Figs. 37.2 and 37.3 represent two simplex interfaces, which can form one full-duplex point-to-point (see below) communication channel.

A good source of information on individual drivers and receivers is provided in the data sheets and application notes of semiconductor manufacturers [1,2].

Point-to-Point vs. Multi-Point

If communication takes place between two devices, we call such a communication link a point-to-point link. In mechatronic systems, it is often required for the master system to communicate with a number of subsystems. Cost permitting, a number of point-to-point data transmission lines can be implemented. In a point-to-point arrangement, the master system has a point-to-point connection to each individual subsystem, i.e., there is a separate port and communication line for each subsystem. This type of arrangement is shown in Fig. 37.4. The connection can also be arranged as a multi-point connection in which

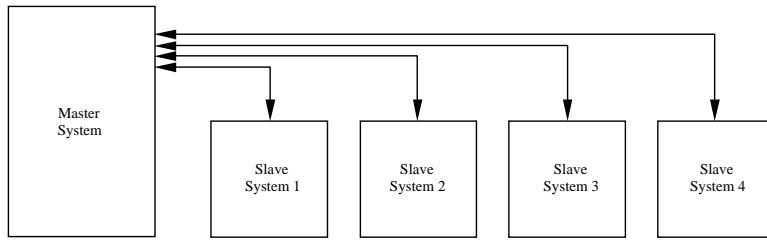

FIGURE 37.4 A point-to-point communication system with four subsystems.

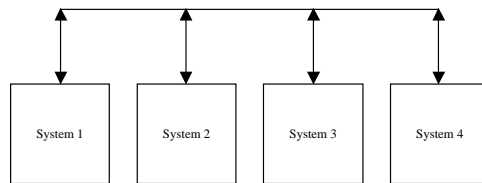

FIGURE 37.5 A multi-point communication system.

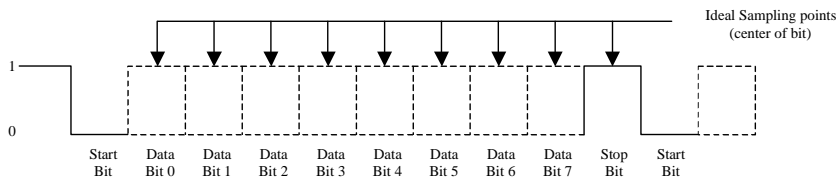

FIGURE 37.6 Asynchronous serial data format.

all devices are connected to a single transmission line, as shown in Fig. 37.5. This arrangement is a data communication network arrangement where data can be transmitted from any device to any other device on the network. All devices on the network must be equipped with a receiver and a transmitter. Transmitters must have a tri-state (high output impedance) capability so that they do not provide additional load to the line. When transmitters are not transmitting, they are virtually disconnected from the transmission line. Complex communication protocol is required to manage individual transmitters on the network. The major advantage of a multi-point arrangement is usually the lower cost of the network compared to the individual communication links. The disadvantage is a more complex communication protocol (which must deal with the identity of the transmitting and receiving devices) and a more complex interface.

Serial Asynchronous Communications

In asynchronous serial communications, the data are transmitted at irregular intervals as a bit stream. Individual characters coded as binary numbers are converted to serial data streams, which are framed with start and stop bits. Optionally, a parity bit is added to the stream. In general, a computer represents information in parallel form such as bytes and words while the majority of communications with external devices takes place serially. The task of the parallel-to-serial and serial-to-parallel conversion is performed by a special integrated circuit called a universal asynchronous receiver transmitter (UART) as described later (see Fig. 37.7).

Figure 37.6 shows an example of a typical data stream for asynchronous transmission. During idle time the line is in logical state 1 (for historical reasons also called “MARK”). The start of the data stream

is always indicated by the start bit, which has logical value 0 (also called “SPACE”). The start bit is followed by 5–8 data bits representing a character. The data bits are followed by an optional parity bit. The stream is terminated by one or two stop bits with logical value 1, which can be followed by idle line or the start bit of the next character. The idle line corresponds to logical state 1. A parity bit is an extra bit inserted after the data bits and before the stop bit(s). It is set according to the parity information of the data in the stream. For example, if an even parity is used, the parity bit is set such that total number of ones in the data stream including the parity bit is even. The parity bit is used by the receiver for error checking. The task of the receiver is to detect the start of the data stream and to correctly sample individual bits in the stream. After the detection of the start bit the receiver should sample individual bits, ideally at the mid point of each bit, as shown in Fig. 37.6. In the case of an ideal sampling, as shown in Fig. 37.6, the receiver is said to have distortion tolerance of 50%. In practice, the receiver of a UART is sampling incoming signals using the Baud Rate Generator frequency, which is 16 times higher than the corresponding baud rate used for transmission. The uncertainty in the detection of the start bit will reduce the distortion tolerance by 6.25% (1/16) to 43.75% [3].

If, for example, the receiver clock is 1% slower than the clock of the corresponding transmitter, the sampling time of the first data bit will be delayed by 1.5% of the bit time and the sampling time of the stop bit will be delayed by 9.5%. In this case, the distortion tolerance would be further reduced to 34.25%. If the receiver clock is slower by 5%, then the receiver may detect the start bit of the next character instead of the stop bit of the current character. This results in a framing error. The above example shows the significance of the accuracy of the clock speed and the reason why the data stream must be kept short in asynchronous transmission.

Other factors affecting the error-free communications include length and type of transmission line, speed of communications, parameters of line drivers, termination of transmission line, and the level of noise in the communication system.

The Universal Asynchronous Receiver Transmitter (UART)

The basic function of the UART is to facilitate parallel-to-serial and serial-to-parallel data conversion. The UART usually contains one transmitter and one receiver. The receiver and transmitter can operate simultaneously and independently. The UART can operate in full-duplex or half-duplex mode.

Parallel data from the host computer are converted to an asynchronous serial bit stream. The UART automatically adds a start bit, an optional parity bit, and the programmed number of stop bits, and sends the stream out through the transmitter serial data output (TxD) output pin. The parallel data are converted to a serial stream with the least significant bit shifted out first. Figure 37.7 shows a typical arrangement for UART. As can be seen, the UART uses TTL (transistor transistor logic) compatible interface. The TIA/EIA (see later) transmission line drivers and receivers are specific to a particular interface; thus, changing system interface means changing the transmission medium and the relevant drivers and receivers. The use of UART is independent of the transmission medium.

Serial data received on the receiver serial data input (RxD) pin is converted to parallel data. In the process the UART checks the start bit, parity bit (if any), and stop bit and reports any error conditions. Note that the UART is capable of generating all signals required for successful bit-serial asynchronous communications.

The UART can also report a number of error conditions, including receiver overrun, parity error, framing error, and break error. Receiver overrun error occurs when the bytes are received faster than the computer

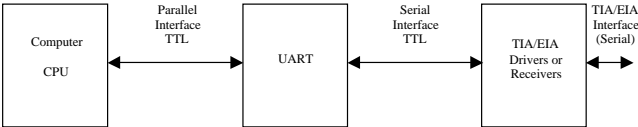

FIGURE 37.7 Typical arrangement for the UART.

processes them. The parity error is indicated if the parity of the bit stream changed during the communication process. Framing error is reported if the sampled stop bit is not at logic 1 level. The break error is reported if the communication line is idle for the time equivalent to the duration of at least one character.

Older types of UART devices such as 8250, 16450 had only one byte FIFO (first in first out) buffer and thus it was easy to overrun the receiver buffer. More recent devices are equipped with larger buffers providing more efficient communications. For example, device 16550D from National Semiconductor has a 16-byte receiver buffer and a 16-byte transmitter buffer and can operate at speeds up to 1.5 Mbps. Modern UARTs can also automatically handle tasks pertaining to multi-drop systems on a network.

37.2 TIA/EIA Serial Interface Standards

RS-232 Serial Interface

The RS-232 (Recommended Standard) was originally developed in 1962 by the Electronic Industries Association (EIA) as an interface between a computer and communication equipment. It is now jointly maintained by the Telecommunication Industries Association (TIA) and the EIA. The current version is designated as TIA/EIA 232-F (sixth revision) [4]. The Consulting Committee for International Telegraphs and Telephones (CCITT) issues recommendations that cover interfaces equivalent or similar to those issued by TIA/EIA.

Rapid development of computers created a demand for computer-to-computer communications over long distances. The switched public telephone network provided a readily available infrastructure for the communication task. Because computers generate digital data while the telephone network was designed for the transmission of voice signal, the digital signals from the computer had to be converted to a modulated signal which can be transmitted over the analog network. Modems (modulator/demodulator) are used to convert the digital signal into a modulated analog signal that is transmitted over the telephone line and converted back to digital signal by the modem at the other end of the telephone line. The RS-232 was designed as an interface between a computer and a modem. The formal name of the RS-232 standard is “Interface Between Data Terminal Equipment and Data Communication Equipment Employing Serial Binary Data Interchange,” in which the Data Terminal Equipment (DTE) represents the computer and the Data Communication Equipment (DCE) represents the modem. Figure 37.8 shows an example of the RS-232 interface in the system providing computer-to-computer communication over the switched telephone network. The computers at each end represent DTE and the modems represent DCE.

The RS-232 interface standard specifies mechanical, electrical, and functional characteristics of the DTE/DCE interface. The CCITT V.24 interface describes equivalent functional characteristics and relies on other standards for mechanical and electrical characteristics of the interface. The RS-232 standard is widely used in applications where it provides a direct point-to-point connection between two computers or computers and field elements of mechatronic systems in which case we are dealing with DTE to DTE interface. As this is a situation where a modem is not required, the cable used to connect a DTE to another DTE is called a “null modem” cable, which has internal built-in connections to fake the presence of a modem.

The mechanical characteristic is concerned with the actual physical connection of the DTE and DCE and involves specification of pin assignments and genders of the connectors. The RS-232 standard does not specify a connector type, but it is customary to use either 25-pin D-type (DB-25) connector, which

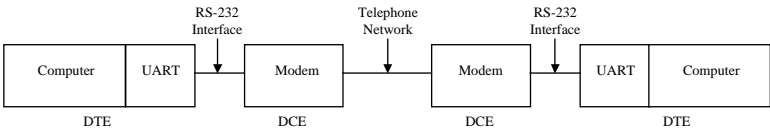

FIGURE 37.8 Data communication over a telephone network.

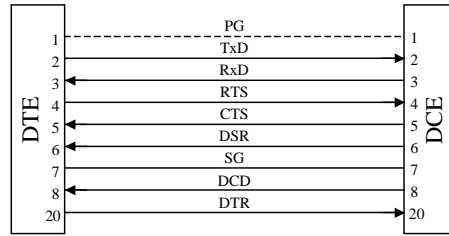

FIGURE 37.9 Pin assignment between a DTE and DCE.

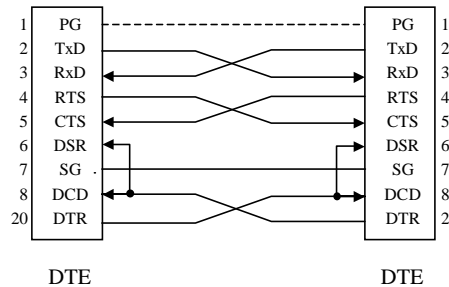

FIGURE 37.10 Example of a null modem cable pin assignment.

can accommodate all 25 pins, listed in the standard. In practice, a smaller number of pins are used; thus, as an alternative, a 9-pin D-type connector (DB-9) is often used. Please note that the pin assignment for DB-9 connector is not specified by RS-232 and is different from DB-25 pin assignment.

Figure 37.9 shows DB-25 connector pin assignments and the interconnection of selected circuits between a DTE and a DCE. Figure 37.10, on the other hand, shows an example of the DB-25 connector pin assignments and interconnection of selected circuits between two computers, i.e., two DTEs.

Functional Description of Selected Interchange Circuits

A full description of all signals as specified by the RS-232 standard is beyond the scope of this chapter. The reader is referred to the relevant standard [4]. We will describe the most common signals used in DTE/DCE and DTE/DTE interface. Please note that with the exception of the Protective Ground circuit and the Signal Ground circuit the circuits carry signals unidirectionally, as shown by arrows in Fig. 37.9. Functional characteristics specify the functions that are performed by individual interchange circuits.

Protective Ground (PG). This line ensures that the chassis of the DTE and DCE are on the same potential.

Transmitted Data (TxD). Transmission line-signal originating from the DTE propagates to DCE.

Received Data (RxD). Receiver line-signal originating from the DCE propagates to DTE.

Request to Send (RTS). This signal is used to condition DCE for data transmission. On a half-duplex channel the signal controls the direction of data transmission of the DCE (transmit or receive). On a one-way-only channel (simplex) and on the full-duplex channels this signal controls the transmit state of the DCE (transmit or nontransmit state). A signal originating from the DTE propagates to DCE.

Clear to Send (CTS). This signal indicates that the DCE is ready to receive and is the response to the asserted RTS signal. The signal is originating from the DCE and propagates to DTE.

Data Set Ready (DSR). This signal indicates that the DCE is ready to operate. The signal is originating from the DCE and propagates to DTE.

Signal Ground (SG). This line is a common ground return line for all other signals.

Data Carrier Detect (DCD). This signal indicates that the DCE is receiving a valid modulated signal from the DCE at the other end. The signal is originating from the DCE and propagates to the DTE.

Data Terminal Ready (DTR). This signal indicates that the DTE is powered up and ready to operate. This signal is originating from the DTE and propagates to DCE.

The RS-232 specifies unbalanced, unidirectional, point-to-point interface. The interconnection is done over a set of wires referred to as interchange circuits. The electrical characteristics specify voltage levels of signals, rate of change of signals, and line impedance of interchange circuits. The standard specifies Nonreturn to Zero (NRZ) coding of digital signals.

The standard requires that the drivers be designed such that for the terminator load resistance between 3 and 7 kW the drivers should be capable of delivering high-level voltages between +5 and +15 V and low voltages between -5 and -15 V. The electrical signals are designed to provide a 2 V margin in signaling levels. The receiver signals are defined as +3 to +15 V for high voltage and as -3 to -15 V for low voltage.

It should be noted that for the data interchange circuit the high level voltage is defined as logic 0 (SPACE), while the low level voltage is defined as logic 1 (MARK). For control signals, on the other hand, the high level voltage defines the ON state while the low level voltage defines the OFF state. The maximum rate of change of signal allowed on both data and signal lines is 30 V/ μ s.

The original standard has also specified the maximum length of cable as 15 m. This specification was replaced by the specification of the maximum allowed capacitive load of 2500 pF in the EIA/TIA-232-D. The maximum cable length is determined by the capacitance of the cable per unit length; thus, this parameter now defines indirectly the length of the interface cable. The RS-232 interface is rated at signaling rates in the range from 0 to 20 kbps. It should be noted that in practice a good design would allow greater distances and greater data rates than the ones specified by the standard.

RS-422 and RS-485 Interfaces

The TIA/EIA-422-B standard “Electrical Characteristics of Balanced Voltage Digital Interface Circuits” [5] defines electrical characteristics of RS-422 interface. The RS-422 specifies a unidirectional, single driver, terminated balanced interface. The standard allows multiple receivers (up to 10) on one line. [Figure 37.3](#) illustrates a typical point-to-point application of RS-422. As a result of improved noise immunity the RS-422 interface supports data rates up to 10 Mbps and cable length up to 1200 m, although not simultaneously. The maximum data rate of 10 Mbps is supported on a cable length up to 12 m, while a cable length of 1200 m supports data rates up to 100 kbps. Observe that the product of cable length and data rate is a limiting parameter of the interface. The transmission medium is a twisted-pair transmission line.

The TIA/EIA-485-A standard “Standard for Electrical Characteristics of Generators and Receivers for Use in Digital Multipoint Systems” [6] defines electrical characteristics of RS-485 interface. The RS-485 is a unique standard, which allows multiple nodes to communicate bidirectionally over a single twisted-pair transmission line. The RS-485 standard defines a low cost, multipoint balanced interface with electrical characteristic, supported cable types, cable length and data rates equivalent to those specified by the RS-422 standard. RS-485 parts are backward compatible and interchangeable with their equivalent RS-422 parts; however, RS-422 parts should not be used in RS-485 systems. RS-422 is usually used in point-to-point full-duplex communication systems, while RS-485 is used in multipoint half-duplex communication systems. The distinguishing feature of RS-485 drivers is their TRI-STATE capability, which allows the use of multiple drivers. The RS-485 has improved driver capability and input voltage range and supports up to 32 devices (drivers and/or receivers) on a single transmission line. [Figure 37.11](#) shows a typical RS-485 multipoint application.

It should be noted that both RS-422 and RS-485 are electrical standards only. They do not specify mechanical or functional requirements.

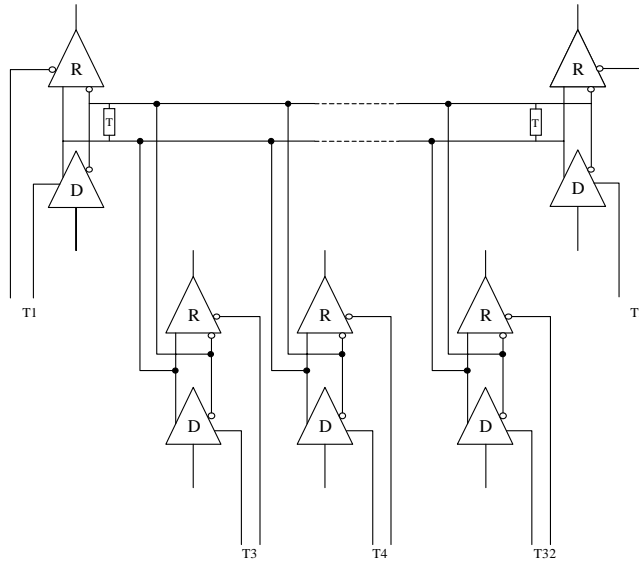

FIGURE 37.11 Example of an RS-485 multipoint application.

As mentioned earlier, data sheets and application notes of component suppliers provide an excellent source of information [1,2]. An excellent overview of practical data communications and interfacing for instrumentation and control is provided in [7]. Detailed discussion of design aspects of serial communications and interfacing based on RS-232 and RS-485 is given in [8]. It is recommended that for the full specification the designer should consult the relevant standards [4–6]. Additional information including design recommendations can be found in [9–11]. A good introduction and background theory to data communication and computer networks can be found in [12].

37.3 IEEE 488—The General Purpose Interface Bus (GPIB)

Introduction

The interface described by IEEE 488 standard, which will be referred to as GPIB in this chapter, is used to connect instruments to test and measurement systems. Examples of such instruments are digital voltmeters, storage oscilloscopes, printers, and plotters. In general, these instruments are called GPIB devices. These devices operate under the coordination of a controller. Most modern systems consist of a cluster of such devices connected to one or more computers. In such a system, one of the computers will become the controller.

Historically, the interface was developed by Hewlett–Packard in 1965. At that time, the interface was called HPIB, and a general standard did not exist. In 1975, it was formulated as IEEE 488 and was called IEEE Standard Digital Interface for Programmable Instrumentation. The standard specified the electrical, mechanical, and hardware aspects, i.e., the signals, their functioning, and purpose. Instrument manufacturers used the interface freely without adhering to a standard protocol in communicating with instruments. Instruments meant for the same purpose, yet manufactured by different manufacturers required widely varied commands. Some instruments made measurements in response to a command, while some other instruments of similar type made measurements without a command at all. Further, there were no agreed data formats between instruments sending data and instruments receiving data. This situation led to the development of an extension to the IEEE 488 standard. The new standard was published in 1987 and was

called IEEE 488.2 Standard Codes, Formats, Protocols, and Common Commands for Use with IEEE 488.1 (1987) [13], where IEEE 488.1 is the new name for the original IEEE 488 standard.

The IEEE 488.2 compliant devices must present data through data formats and codes specified in the standard. The standard also specifies a minimum set of mandatory control sequences or commands and suggests a few other optional commands. It also provides a standard status-reporting model that must be implemented by the instrument manufacturers so that determining the status of instruments will be easier for the instrument programmers.

Although not yet a standard, The Standard Commands for Programmable Instrumentation (SCPI) put together in 1990 agrees upon a standard set of commands for various instrument categories. Accordingly, all digital voltmeters manufactured by different manufacturers will respond to the same GPIB command.

GPIB Hardware

This section describes the electrical and mechanical specifications of the GPIB interface as well as the signal description and their purpose.

All GPIB devices are connected using a special cable with each end having the male as well as the female ends of the connector. This permits piggyback connections of cables. The devices can be connected either in a chained manner (i.e., device B connected to device A, device C connected to device B, etc.) or in a star configuration (i.e., device A, B, C, etc. connected to a common node). The connection configurations are shown in Fig. 37.12.

A maximum of 15 devices can be connected to the bus. The maximum separation between two devices is 4 m with an average separation of not more than 2 m. At least two-thirds of the devices connected must be powered on.

The GPIB cable consists of 24 wires. Eight of these lines are data lines, while three lines are used for handshaking. Another five lines are used for interface management and the remaining eight lines are ground lines. Among the ground lines are a cable shield line, a signal ground line, three ground return lines for the handshaking signals, and three other ground return lines for three of the interface management lines. All signals used are standard TTL signal levels with negative logic. The handshake lines and interface management lines are given in Table 37.1.

The operation of the individual lines is not important to the average user or programmer as their usage is taken care of by the controllers and the instruments that comply with IEEE 488.2 standard.

TABLE 37.1 Handshaking and Interface Management Lines

| Handshaking Lines | | Interface Management Lines | |
|-------------------|--------------------|----------------------------|-----------------|
| NRFD | Not ready for data | ATN | Attention |
| NDAC | Not data accepted | IFC | Interface clear |
| DAV | Data valid | REN | Remote enable |
| | | SRQ | Service request |
| | | EOI | End of identify |

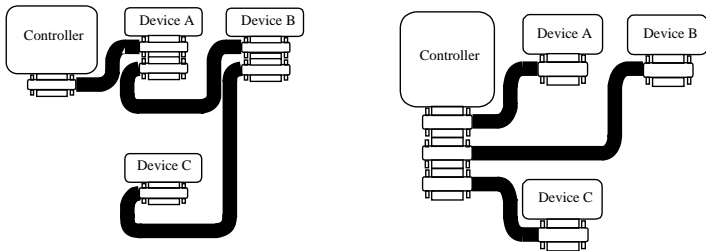

FIGURE 37.12 Linear and star configurations of connecting GPIB devices to a controller.

Controllers, Talkers, and Listeners

The controller carries out the general management of the bus. While there can be many controllers connected to the GPIB network, there can be only one controller-in-charge (CIC) which manages the bus at that given time. All information sent out by the controller on the data lines are called “commands” and all information sent out by other devices are termed “data.” The GPIB devices that send data any time are called “talkers” and the devices that receive data are called “listeners.” While there can be more than one listener operating at any given time, there can be only one talker operating at any given time. A system can have permanent talkers and permanent listeners; however, if the capability exists, a GPIB device can be a listener at one time and a talker at another time. A brief explanation of the signal lines is given below, as it would enhance our understanding of the operation of GPIB interface.

Interface Management Lines

Attention (ATN)

The ATN line is controlled by the CIC. When asserted, the signals on the data lines constitute a command signal and all devices must listen. When unasserted, the signals on the data lines represent data and are generally sent by a talker to one or more listeners.

Interface Clear (IFC)

The IFC line is asserted by the CIC to reset the GPIB bus. Upon receipt of this signal, all GPIB devices on the bus will initialize themselves.

Remote Enable (REN)

GPIB devices can be controlled either locally or remotely. The CIC asserts the REN line to bring all GPIB devices under remote programming mode. Thus, for example, the change of scale of a DVM can be carried out by a GPIB command instead of a front panel control.

Service Request (SRQ)

Any device other than a controller can asynchronously assert the SRQ line requesting service from the controller. The controller monitors the SRQ line and polls all devices to determine the device or devices requiring service.

End of Identity (EOI)

The EOI signal is used by a talker to indicate the end of the data message of the talker. It indicates to the listener(s) the end of the receiving data record.

Handshake Lines

In general, a data transfer with complete handshake gets through three stages: request or preparedness, data transfer, and acknowledgment. On some systems, where the stability of data on the data bus is questionable, a data valid signal may also be provided. On the GPIB bus, when a talker has to send data to a listener, the controller must address a device and instruct it to be the talker and then address one or more other devices and instruct them to be listeners. See later for “Addressing of GPIB Devices.”

Not Ready for Data (NRFD)

The NRFD line is controlled by the controller when sending commands or by the talker when sending data. A device that has been instructed to be a listener will unassert NRFD to indicate to the talker that it is ready to receive data. Of all the listeners, the slowest device will be the last to unassert NRFD and thus control the speed of data transfer.

Data Valid (DAV)

When all listeners have indicated their readiness to receive data by unasserting NRFD, the talker (or the controller when sending commands) will assert a DAV signal to indicate to all listeners that the data on the data lines DIO1-DIO8 are stable and may be read by the listeners. In response to a DAV signal, the listeners

may assert NRFD to halt any further data transmission by talkers until the data already transmitted has been received.

Not Data Accepted (NDAC)

The NDAC line driven by all listeners is the acknowledgment signal. When data has been received by all listeners, the NDAC line will be unasserted. The talker can then remove the data and unassert the DAV signal.

Data Lines DIO1-DIO8 (8 lines)

The data lines are controlled by the controller when issuing commands or by the talker. As soon as the controller instructs a particular device to be a talker, that device will place data on the lines DIO1-DIO8 and will wait for at least T1 seconds.

Addressing of GPIB Devices

All GPIB devices connected to a GPIB bus must have a unique GPIB address. A device can have a primary address as well as a secondary address. Most devices use a primary address only. The addresses are in the range 0–30 decimal. In general, the addresses on the instruments as well as the controller are set using switches. The controller instructs a device with a particular address to be a talker or a listener by sending a bit pattern on the data bus. The bit pattern is formed according to Table 37.2. The data bits are numbered from D7 to D0. The value of each bit is listed straight underneath. The letter A signifies 0 or 1. The five bits D4–D0 will form a bit pattern representing the address of the device. The letter X signifies a “don’t care” bit, which is not used. TA will be set to 1 if the controller is instructing the device to be a talker. LA will be set to 1 if the controller is instructing the device to be a listener. For example, if a particular device has the address 15 (decimal) and if the controller is instructing that device to be the talker, then the controller must send the following bit pattern over the data lines DIO8-DIO1.

Device with address 15 be the talker 0 1 0 0 1 1 1 1 = 4F (hex)

Similarly,

Device with address 0 be the listener 0 0 1 0 0 0 0 0 = 20 (hex)

“Untalk” the current talker 0 1 0 1 1 1 1 1 = 5F (hex)

“Unlisten” all listeners 0 0 1 1 1 1 1 1 = 3F (hex)

Note that Untalk and Unlisten commands look very similar to Talk and Listen commands; however, the address 31 (decimal) does not exist. Therefore, the address 31 is used to affect Untalk and Unlisten.

For the controllers, IEEE 488.2 Standard provides the Required and Optional Control Sequences. All controllers that comply with IEEE 488.2 must support all mandatory commands. The standard also provides the “Controller Protocols.” Protocols are formed by combining a set of control sequences. For example, FINDLSTN command will issue a set of control sequences to determine the existing listeners.

For the instruments, IEEE 488.2 specifies a set of mandatory commands and queries. For example, when the command “*RST” is received by IEEE 488.2 compliant instruments, they all must carry out an instrument reset. Similarly, upon receipt of “*STB?” command the instrument will send the status byte to the controller.

TABLE 37.2 Talker/Listener Addressing Commands

| D7 | D6 | D5 | D4 | D3 | D2 | D1 | D0 |
|----|----|----|----|----|----|----|----|
| X | TA | LA | A | A | A | A | A |

All mandatory common commands and queries, all required and optional control sequences as well as the controller protocols can be found in [14,15].

References

1. Goldie, J., Summary of well known interface standards, Application note AN-216, National Semiconductor, 1998, www.national.com.
2. Goldie, J., Comparing EIA-485 and EIA-422-A line drivers and receivers in multipoint applications, Application note AN-759, National Semiconductor, 1998.
3. McNamara, J.E., *Technical Aspects of Data Communication*, 3rd edition, Digital Press, 1988.
4. TIA/EIA-232-F, Interface between data terminal equipment and data communication equipment employing serial binary data interchange, TIA, EIA, 1997.
5. TIA/EIA-422-B, Electrical characteristics of balanced voltage digital interface circuits, TIA, EIA, 1995.
6. TIA/EIA-485-A, Standard for electrical characteristics of generators and receivers for use in digital multipoint systems, TEI, EIA, 1998.
7. Mackay, S.G., et al., *Data Communications for Instrumentation and Control*, IDC Techbooks, 2000.
8. Axelson, J., *Serial Port Complete*, Lakeview Research, Madison, 1998.
9. Goldie, J., Ten ways to bulletproof RS-485 interfaces, Application note AN-1057, National Semiconductor, 1996.
10. RS-422 and RS-485 Application Note, B&B Electronics Manufacturing Co., 1997, www.bb-elec.com.
11. DALLAS SEMICONDUCTOR, Application Note 83, Fundamentals of RS-232 Serial Communications, 1998.
12. Stallings, W., *Data and Computer Communications*, 6th ed., Prentice-Hall, Upper Saddle River, NJ, 2000.
13. ANSI/IEEE 488.1-1987 IEEE standard digital interface for programmable instrumentation institution of electrical and electronic engineers, New York, 1987.
14. ANSI/IEEE 488.2-1987 IEEE standard codes, formats, protocols and common commands, institution of electrical and electronic engineers, New York, 1987.
15. ANSI/IEEE 488.2-1992 IEEE standard codes, formats, protocols and common commands, and standard commands for programmable instruments. Institution of Electrical and Electronic Engineers, New York, 1992.

38

Communications and Computer Networks

- 38.1 A Brief History
- 38.2 Introduction
- 38.3 Computer Networks
Wide Area Computer Networks • Local and Metropolitan
Area Networks • Wireless and Mobile Communication
Networks
- 38.4 Resource Allocation Techniques
- 38.5 Challenges and Issues
- 38.6 Summary and Conclusions

Mohammad Ilyas
Florida Atlantic University

The field of communications and computer networks deals with efficient and reliable transfer of information from one point to another. The need to exchange information is not new but the techniques employed to achieve information exchange have been steadily improving. During the past few decades, these techniques have experienced an unprecedented and innovative growth. Several factors have been and continue to be responsible for this growth. The Internet is the most visible product of this growth and it has impacted the life of each and every one of us. This chapter describes salient features and operational details of communications and computer networks.

The contents of this chapter are organized in several sections. [Section 38.1](#) describes a brief history of the field of communications. [Section 38.2](#) deals with the introduction of communication and computer networks. [Section 38.3](#) describes operational details of computer networks. [Section 38.4](#) discusses resource allocation mechanisms. [Section 38.5](#) briefly describes the challenges and issues in communication and computer networks that are still to be overcome. Finally, [Section 38.6](#) summarizes the article.

38.1 A Brief History

Exchange of information (communications) between two or more entities has been a necessity since the existence of human life. It started with some form and shape of human voice that one entity can create and other(s) can listen to and interpret. Over a period of several centuries, these voices evolved into languages. As the population of the world grew, more and more languages were born. For a long time, languages were used for face-to-face communications. If there were ever a need to convey some information (a message) over a distance, someone would be briefed and sent to deliver the message to a distant site. Gradually, additional methods were developed to represent and exchange the information. These methods included symbols, shapes, and eventually alphabets. This development facilitated information recording and use of nonvocal means for exchanging information. Hence, preservation, dissemination, sharing, and communication of knowledge became easier.

Until about 150 years ago, all communication was via wireless means and included smoke signals, beating of drums, and use of reflective surfaces for reflecting light signals (optical wireless). Efficiency of

these techniques was heavily influenced by environmental conditions. For instance, smoke signals were not very effective in windy conditions. In any case, as we will note later, some of the techniques that were in use centuries ago for conveying information over a distance were similar to the techniques that we currently use. The only difference is that the implementation of those techniques is exceedingly more sophisticated now than it was centuries ago.

As the technological progress continued and electronic devices started appearing on the surface, the field of communication also started making use of the innovative technologies. Alphabets were translated into their electronic representations so that information could be electronically transmitted. Morse code was developed for telegraphic exchange of information. Further developments led to the use of the telephone. It is important to note that in earlier days of technological masterpieces, users would go to a common site where one could send a telegraphic message over a distance or could have a telephonic conversation with a person at a remote location. This was a classic example of resource sharing. Of course, human help was needed to establish a connection with remote sites.

As the benefits of the advances in communication technologies were being harvested, electronic computers were also emerging and making the news. Earlier computers were not only expensive and less reliable, they were also huge in size. For instance, the computers that used vacuum tubes were of the size of a large room and used roughly about 10,000 vacuum tubes. These computers would stop working if a vacuum tube burned out, and the tube would need to be replaced by using a ladder. On average, those computers would function for a few minutes before another vacuum tube's replacement was necessary. A few minutes of computer time was not enough to execute a large computer program. With the advent of transistors, computers not only became smaller in size and less expensive, but also more reliable. These aspects of computers resulted in their widespread applications. With the development of personal computers, there is hardly any side of our lives that has not been impacted by the use of computers. The field of communications is no exception and the use of computers has escalated our communication capabilities to new heights.

38.2 Introduction

Communication of information from one point to another in an efficient and reliable manner has always been a necessity. A typical communication system consists of the following components as shown in Fig. 38.1:

- Source that generates or has the information to be transported
- Transmitter that prepares the information for transportation
- Transmission medium that carries the information from one end to the other
- Receiver that receives the information and prepares it for delivering to the receiver
- Destination that takes the information from receiver and utilizes it as necessary

The information can be generated in analog or digital form. Analog information is represented as a continuous signal that varies smoothly in time. As one speaks in a microphone, an analog voice signal is generated. Digital information is represented by a signal that stays at some fixed level for some duration of time followed by a change to another fixed level. A computer works with digital information that has two levels (binary digital signals). Figure 38.2 shows an example of analog and digital signals. Transmission of

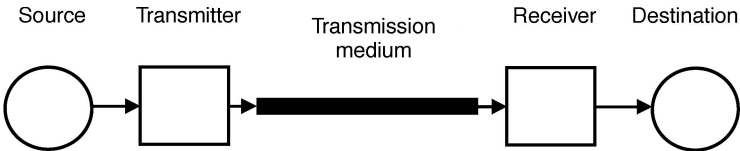

FIGURE 38.1 A typical communication system.

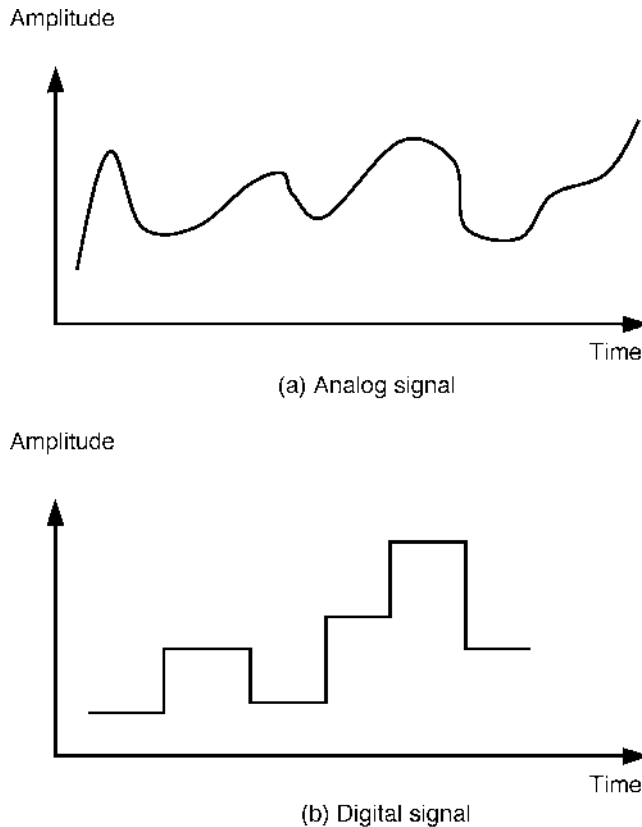

FIGURE 38.2 Typical analog and digital signals.

information can also be in analog or digital form. Therefore, we have the following four possibilities in a communication system [21]:

- Analog information transmitted as an analog signal
- Analog information transmitted as a digital signal
- Digital information transmitted as an analog signal
- Digital information transmitted as a digital signal

There may not be a choice regarding the form (analog or digital) of information being generated by a device. For instance, a voice signal as one speaks, a video signal as generated by a camera, a speed signal generated by a moving vehicle, and an altitude signal generated by the equipment in a plane will always be analog in nature; however, there is a choice regarding the form (analog or digital) of information being transmitted over a transmission medium. Transmitted information could be analog or digital in nature and information can be easily converted from one form to another.

Each of these possibilities has its pros and cons. When a signal carrying information is transmitted, it loses its energy and strength and gathers some interference (noise) as it propagates away from the transmitter. If the energy of the signal is not boosted at some intermediate point, it may attenuate beyond recognition before it reaches its intended destination. That will certainly be a wasted effort. In order to boost energy and strength of a signal, it must be amplified (in case of analog signals) and rebuilt (in case of digital signals). When an analog signal is amplified, the noise also becomes amplified and that certainly lowers expectations about receiving the signal at its destination in its original (or close to it) form. On the other hand, digital signals can be processed and reconstructed at any intermediate point and, therefore, the noise can essentially be filtered out. Moreover, transmission of information in digital form has many

other advantages including processing of information for error detection and correction, applying encryption and decryption techniques to sensitive information, and many more. Thus, digital information transmission technology has become the dominant technology in the field of communications [9,18].

As indicated earlier, communication technology has experienced phenomenal growth over the past several decades. The following two factors have always played a critical role in shaping the future of communications [20]:

- Severity of user needs to exchange information
- State of the technology related to communications

Historically, inventions have always been triggered by the severity of needs. It has been very true for the field of communications as well. In addition, there is always an urge and curiosity to make things happen faster. When electricity was discovered and people (scattered around the globe) wanted to exchange information over longer distances and in less time, the telegraph was invented. Morse code was developed with shorter sequences (of dots and dashes) for more frequent alphabets. That resulted in transmission of messages in a shorter duration of time. The presence of electricity and the capability of wires to carry information over longer distances led to the development of devices that converted human voice into electrical signal, and thus led to the development of telephone systems. Behind this invention was also a need/desire to establish full-duplex (two-way simultaneous) communication in human voice. As use of the telephone became widespread, there was a need for a telephone user to be connected to any other user, and that led to the development of switching offices. In the early days, the switching offices were operated manually. As the state of the technology improved, the manual switching offices were replaced by automatic switching offices. Each telephone user was assigned a telephone number for identification purposes and a user able to dial the number for the purpose of establishing a connection with the called party. As the computer technology improved and the computers became easier to afford and smaller in size, they found countless uses including their use in communications. The computers not only replaced the automatic (electromechanical) switching offices, they were also employed in many other aspects of communication systems. Examples include conversion of information from analog to digital and vice versa, processing of information for error detection and/or correction, compression of information, and encryption/decryption of information.

As computers became more powerful, there were many other applications that surfaced. The most visible application was the amount of information users started sharing among themselves. The volume of information being exchanged among users has been growing exponentially over the last three decades. As users needed to exchange such a mammoth amount of information, new techniques were invented to facilitate the process. There was not only a need for users to exchange information with others in an asynchronous fashion, there was also a need for computers to exchange information among themselves. The information being exchanged in this fashion has different characteristics than the information being exchanged through the telephone systems. This need led to the interconnection of computers with each other and that is what is called computer networks.

38.3 Computer Networks

A computer network is an interconnection of computers. The interconnection forms a facility that provides reliable and efficient means of communication among users and other devices. User communication in computer networks is assisted by computers, and the facility also provides communication among computers. Computer networks are also referred to as computer communication networks. Interconnection among computers may be via wired or wireless transmission medium [5,6,10,13,18].

There are two broad categories of computer networks:

- Wide area networks
- Local/metropolitan area networks

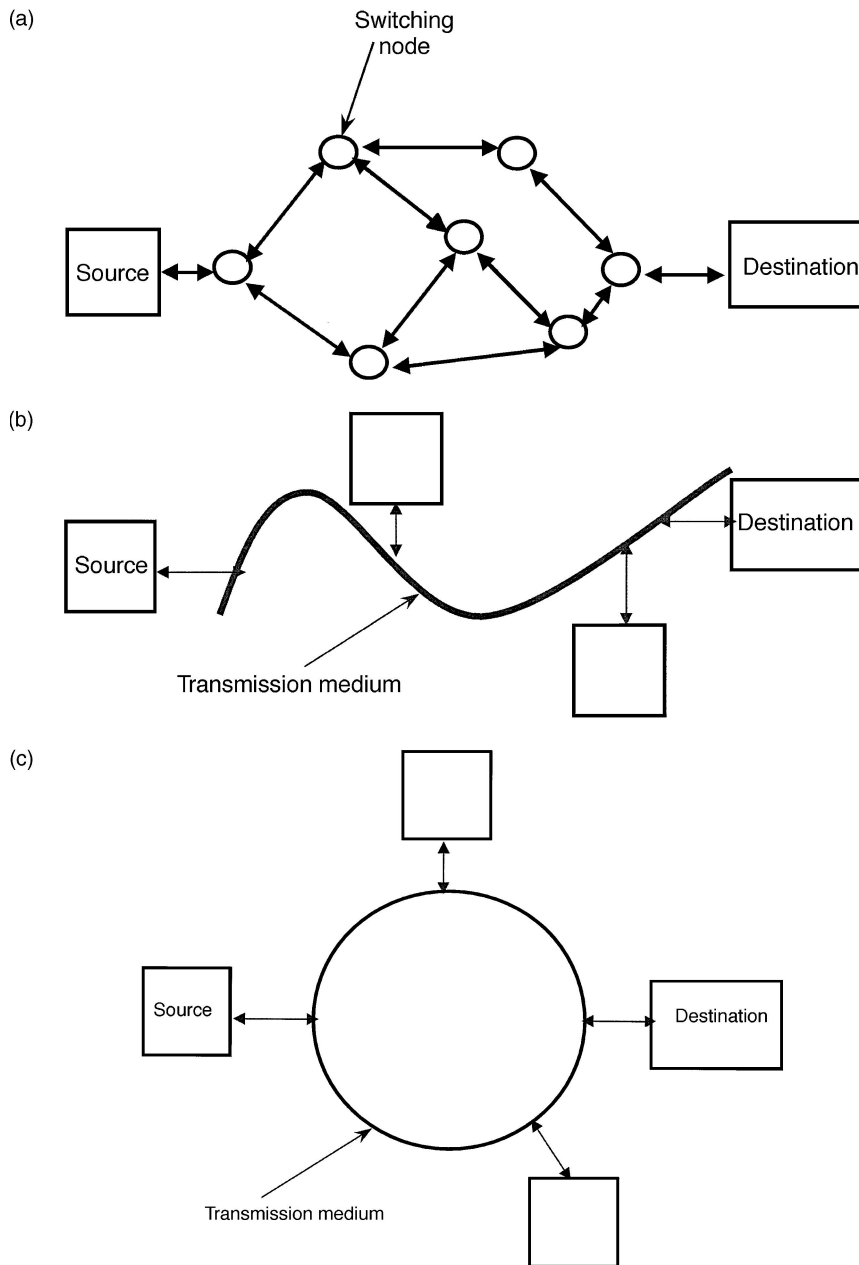

FIGURE 38.3 (a) A typical wide area computer communication network. (b) A typical local/metro area communication bus network. (c) A typical local/metro area communication ring network.

Wide area computer networks, as the name suggests, span a wider geographical area and essentially have a global scope. On the other hand, local/metro area networks span a limited distance. Local area networks are generally confined to an industrial building or an academic institution. Metropolitan area networks also have limited geographical scope but it is relatively larger than that of the local area networks [19]. Typical wide and local/metro area networks are shown in Fig. 38.3.

Once a user is connected to a computer network, that user can communicate with any other user also connected to the network at some point. It is not required for a user to be connected directly to another

user in order to communicate. In fact, in wide area networks, two communicating users will rarely be directly connected with each other. This implies that the users will be sharing the transmission links for exchanging their information. This is one of the most important aspects of computer networks. Sharing of resources improves utilization of the resources and is, of course, cost-effective as well. In addition to sharing the transmission links, the users will also share the processing power of the computers at the switching nodes, buffering capacity to store the information at the switching nodes, and any other resources that are connected to the computer network. A user who is connected to a computer network at any switching node will have immediate access to all the resources (databases, research articles, surveys, and much more) that are connected to the network as well. Of course, access to specific information may be restricted and a user may require appropriate authorization to access the information.

The information from one user to another may need to pass through several switching nodes and transmission links before reaching its destination. This implies that a user may have many options available to select one out of many sequences of transmission links and switching nodes to exchange information. That adds to the reliability of the information exchange process. If one path is not available, not feasible, or not functional, some other path may be used. In addition, for better and effective sharing of resources among several users, it is not appropriate to let any user exchange a large quantity of information at a time; however, it is not uncommon that some users may have a large quantity of information to exchange. In that case, the information is broken into smaller units known as packets of information. Each packet is sent toward its destination as a separate entity and then all packets are assembled together at the destination side to re-create the original piece of information [2].

Due to the resource sharing environment, users may not be able to exchange their information at any time they wish because the resources (switching nodes, transmission links) may be busy serving other users. In that case, some users may have to wait for some time before they begin their communication. Designers of computer networks should design the network so that the total delay (including wait time) is as brief as possible and that the total amount of information successfully exchanged (throughput) is as large as possible.

Many aspects must be addressed for enabling networks to transport users' information from one point to another. The major aspects are:

- Addressing mechanism to identify users
- Addressing mechanism for information packets to identify their source and destination
- Establishing a connection between sender and receiver and maintaining it
- Choosing a path or a route (sequence of switching nodes and transmission links) to carry the information from a sender to a receiver
- Implementing a selected route or path
- Checking information packets for errors and recovering from errors
- Encryption and decryption of information
- Controlling the flow of information so that shared resources are not over-taxed
- Informing the sender that the information has been successfully delivered to the intended destination (acknowledgment)
- Billing for the use of resources
- Ensuring that different computers running different applications and operating systems can exchange information
- Preparing information appropriately for transmission over a given transmission medium

This is not an exhaustive list of items that need to be addressed in computer networks. In any case, all such issues are addressed by very systematic and detailed procedures. The procedures are called communication protocols. The protocols are implemented at the switching nodes by a combination of hardware and software. It is not advisable to implement all these features in one module of hardware or software because that will become very difficult to manage. It is a standard practice that these features be divided into different

smaller modules and then these modules can be interfaced together to collectively provide implementation of these features. International Standards Organization (ISO) has suggested dividing these features into seven distinct modules called layers. The proposed model is referred to as Open System Interconnection (OSI) reference model. The seven layers proposed in the OSI reference model are [2]:

- Application layer
- Presentation layer
- Session layer
- Transport layer
- Network layer
- Data link layer
- Physical layer

The physical layer deals with the transmission of information on the transmission medium. The data link layer handles the information on a single link. The network layer deals with the path or route of information from the switching node where the source is connected to the switching node where the receiver is connected. It also monitors end-to-end information flow. The remaining four layers reside with the user equipment. The transport layer deals with the information exchange from the source to the sender. The session layer handles the establishment of a session between the source and the receiver and maintains it. The presentation layer deals with the form in which information is presented to the lower layer. Encryption/decryption of information can also be performed at this layer. The application layer deals with the application that generates the information at the source side and what happens to it when it is delivered at the receiver side.

As the information begins from the application layer at the sender side, it is processed at every layer according to the specific protocols implemented at that layer. Each layer processes the information and appends a header and/or a trailer with the information before passing it on to the next layer. The headers and trailers appended by various layers contribute to the overhead and are necessary for transportation of the information. Finally, at the physical layer, the bits of information packets are converted to an appropriate signal and transmitted over the transmission medium. At the destination side, the physical layer receives the information packets from the transmission medium and prepares them for passing these to the next higher layer. As a packet is processed by the protocol layers at the destination side, its headers and trailers are stripped off before it is passed to the next layer. By the time information reaches the application layer, it should be in the same form as it was transmitted by the source.

Once a user is ready to send information to another user, he or she has two options. He or she can establish a communication with the destination prior to exchanging information or he can just give the information to the network node and let the network deliver the information to its destination. If communication is established prior to exchanging the information, the process is referred to as connection-oriented service and is implemented by using virtual circuit connections. On the other hand, if no communication is established prior to sending the information, the process is called connectionless service. This is implemented by using a datagram environment. In connection-oriented (virtual circuit) service, all packets between two users travel over the same path through a computer network and, hence, arrive at their destination in the same order as they were sent by the source. In connectionless service, however, each packet finds its own path through the network while traveling towards its destination. Each packet will therefore experience a different delay and the packets may arrive at their destination out of sequence. In that case, the destination will be required to put all the packets in proper sequence before assembling them [2,10,13].

As in all resource sharing systems, allocation of resources in computer networks requires careful attention. The main idea is that the resources should be shared among users of a computer network as fairly as possible. At the same, it is desired to maintain the network performance as close to its optimal level as possible. The fairness definition, however, varies from one individual to another and depends upon how one is associated with a computer network. Although fairness of resource sharing is being evaluated, two performance parameters—delay and throughput—for computer networks are considered. The delay

is the duration of time from the moment information is submitted by a user for transmission to the moment it is successfully delivered to its destination. The throughput is the amount of information successfully delivered to its intended destination per unit time. Due to the resource sharing environment in computer networks, these two performance parameters are contradictory. It is desired to have the delay as small as possible and the throughput as large as possible. For increasing throughput, a computer network must handle increased information traffic, but the increased level of information traffic also causes higher buffer occupancy at the switching nodes and, hence, more waiting time for information packets. This results in an increase in delay. On the other hand, if information traffic is reduced to reduce the delay, that will adversely affect the throughput. A reasonable compromise between throughput and delay is necessary for the satisfactory operation of a computer network [10,11].

Wide Area Computer Networks

A wide area network consists of switching nodes and transmission links as shown in Fig. 38.3(a). Layout of switching nodes and transmission links is based on the traffic patterns and expected volume of traffic flow from one site to another site. Switching nodes provide the users access to a computer network and implement communication protocols. When a user is ready to transmit his or her information, the switching node, to which the user is connected, will establish a connection if a connection-oriented service has been opted. Otherwise, the information will be transmitted in a connectionless environment. In either case, switching nodes play a key role in determining the path of the information flow according to some well-established routing criteria. The criteria include performance (delay and throughput) objectives among other factors based on user needs. For keeping the network traffic within a reasonable range, some traffic flow control mechanisms are necessary. In late 1960s and early 1970s, when data rates of transmission media used in computer networks were low (a few thousand bits per second), these mechanisms were fairly simple. A common method used for controlling traffic over a transmission link or a path was an understanding that the sender would continue sending information until the receiver sent a request to stop. The information flow would resume as soon as the receiver sent another request to resume transmission. Basically the receiver side had the final say in controlling the flow of information over a link or a path. As the data rates of transmission media started increasing, this method was not deemed efficient. To control the flow of information in relatively faster transmission media, a sliding window scheme was used. According to this scheme, the sender will continuously send information packets but no more than a certain limit. Once the limit is reached, the sender will stop sending the information packets and will wait for the acknowledgment that the packets have been transmitted. As soon as an acknowledgment is received, the sender may send another packet. This method ensures that there are no more than a certain specific number of packets in transit from sender to receiver at any given time. Again, the receiver has control over the amount of information that the sender can transmit. These techniques for controlling the information traffic are referred to as reactive- or feedback-based techniques because the decision to transmit or not to transmit is based on the current traffic conditions.

Reactive techniques are acceptable in low to moderate data rates of transmission media. As the data rates increase from kilobits per second to megabits and gigabits per second, the situation changes. Over the past several years, there has been a manifold increase in data rates. Optical fibers provide enormously high data rates. Size of the computer networks has also experienced tremendous increase. The amount of traffic flowing through these networks has been increasing exponentially. Given that, the traffic control techniques used in earlier networks are not quite effective anymore [11,12,22]. One more factor that has added to the complexity of the situation is that users are now exchanging different types of information through the same network. Consider the example of the Internet. The geographical scope of the Internet is essentially global. Extensive use of optical fiber as transmission media provides very high data rates for exchanging information. In addition, users are using the Internet for exchanging any type of information they come across, including voice, video, and data. All these factors have essentially necessitated the use of a modified approach for traffic management in computer networks. The main factor leading to this change is that the information packets are moving so fast through the computer networks that any feedback-based (or reactive)

control will be too slow to be of any use. Therefore, some preventive mechanisms have been developed to maintain the information traffic inside a computer network to a comfortable level. Such techniques are implemented at the sender side by ensuring that only as much information traffic is allowed to enter the network as can be comfortably handled by the networks [1,20,22]. Based on the users' needs and state of the technology, providing faster communications for different types of services (voice, video, data, and others) in the same computer network in an integrated and unified manner has become a necessity. These computer networks are referred to as broadband integrated services digital networks (BISDNs). BISDNs provide end-to-end digital connectivity and users can access any type of communication service from a single point of access. Asynchronous transfer mode (ATM) is expected to be used as a transfer mechanism in BISDNs. ATM is essentially a fast packet switching technique where information is transmitted in the form of small fixed-size packets called cells. Each cell is 53 bytes long and includes a header of 5 bytes. The information is primarily transported using a connection-oriented (virtual circuit) environment [3,4,8,12,17].

Another aspect of wide area networks is the processing speed of switching nodes. As the data rates of transmission media increase, it is essential to have faster processing capability at the switching nodes. Otherwise, switching nodes become bottlenecks and faster transmission media cannot be fully utilized. When transmission media consist of optical fibers, the incoming information at a switching node is converted from optical form to electronic form so that it may be processed and appropriately switched to an outgoing link. Before it is transmitted, the information is again converted from electronic form to optical form. This slows down the information transfer process and increases the delay. To remedy this situation, research is being conducted to develop large optical switches to be used as switching nodes. Optical switches will not require conversion of information from optical to electronic and vice versa at the switching nodes; however, these switches must also possess the capability of optical processing of information. When reasonably sized optical switches become available, use of optical fiber as transmission media together with optical switches will lead to all-optical computer and communication networks. Information packets will not need to be stored for processing at the switching nodes and that will certainly improve the delay performance. In addition, wavelength division multiplexing techniques are rendering use of optical transmission media to its fullest capacity [14].

Local and Metropolitan Area Networks

A local area network has a limited geographical scope (no more than a few kilometers) and is generally limited to a building or an organization. It uses a single transmission medium and all users are connected to the same medium at various points. The transmission medium may be open-ended (bus) as shown in Fig. 38.3(b) or it may be in the form of a loop (ring) as shown in Fig. 38.3(c). Metropolitan area networks also have a single transmission medium that is shared by all the users connected to the network, but the medium spans a relatively larger geographical area, up to 150 km. They also use a transmission medium with relatively higher data rates. Local and metropolitan area networks also use a layered implementation of communication protocols as needed in wide area networks; however, these protocols are relatively simpler because of simple topology, no switching nodes, and limited distance between the senders and the receivers. All users share the same transmission medium to exchange their information. Obviously, if two or more users transmit their information at the same time, the information from different users will interfere with each other and will cause a collision. In such cases, the information of all users involved in a collision will be destroyed and will need to be retransmitted. Therefore, there must be some well-defined procedures so that all users may share the same transmission medium in a civilized manner and have successful exchange of information. These procedures are called medium access control (MAC) protocols.

There are two broad categories of MAC protocols:

- Controlled access protocols
- Contention-based access protocols

In controlled access MAC protocols, users take turns transmitting their information and only one user is allowed to transmit information at a time. When one user has finished his or her transmission, the next user begins transmission. The control could be centralized or distributed. No information collisions occur and, hence, no information is lost due to two or more users transmitting information at the same time. Examples of controlled access MAC protocols include token-passing bus and token-passing ring local area networks. In both of these examples, a token (a small control packet) circulates among the stations. A station that has the token is allowed to transmit information, and other stations wait until they receive the token [19].

In contention-based MAC protocols, users do not take turns transmitting their information. A user makes his or her own decision to transmit and also faces a risk of becoming involved in a collision with another station that also decides to transmit at about the same time. If no collision occurs, the information may be successfully delivered to its destination. On the other hand, if a collision occurs, the information from all users involved in a collision will need to be retransmitted. An example of contention-based MAC protocols is carrier sense multiple access with collision detection (CSMA/CD), which is used in Ethernet. In CSMA/CD, a user senses the shared transmission medium prior to transmitting its information. If the medium is sensed as busy (someone is already transmitting the information), the user will refrain from transmitting the information; however, if the medium is sensed as free, the user transmits the information. Intuitively, this MAC protocol should be able to avoid collisions, but collisions still do take place. The reason is that transmissions travel along the transmission medium at a finite speed. If one user senses the medium at one point and finds it free, it does not mean that another user located at another point of the medium has not already begun its transmission. This is referred to as the effect of the finite propagation delay of electromagnetic signal along the transmission medium. This is the single most important parameter that causes deterioration of performance in contention-based local area networks [11,19].

Design of local area networks has also been significantly impacted by the availability of transmission media with higher data rates. As the data rate of a transmission medium increases, the effects of propagation delay become even more visible. In higher speed local area networks such as Gigabit Ethernet, and 100-BASE-FX, the medium access protocols are designed to reduce the effects of propagation delay. If special attention is not given to the effects of propagation delay, the performance of high-speed local area networks becomes very poor [15,19].

Metropolitan area networks essentially deal with the same issues as local area networks. These networks are generally used as backbones for interconnecting different local area networks. These are high-speed networks and span a relatively larger geographical area. MAC protocols for sharing the same transmission media are based on controlled access. The two most common examples of metropolitan area networks are fiber distributed data interface (FDDI) and distributed queue dual bus (DQDB). In FDDI, the transmission medium is in the form of two rings, whereas DQDB uses two buses. FDDI rings carry information in one but opposite directions and this arrangement improves reliability of communication. In DQDB, two buses also carry information in one but opposite directions. The MAC protocol for FDDI is based on token passing and supports voice and data communication among its users. DQDB uses a reservation-based access mechanism and also supports voice and data communication among its users [19].

Wireless and Mobile Communication Networks

Communication without being physically tied-up to wires has always been of interest and mobile and wireless communication networks promise that. The last few years have witnessed unprecedented growth in wireless communication networks. Significant advancements have been made in the technologies that support wireless communication environment and there is much more to come in the future. The devices used for wireless communication require certain features that wired communication devices may not necessarily need. These features include low power consumption, light weight, and worldwide communication ability.

In wireless and mobile communication networks, the access to a communication network is wireless so that the end users remain free to move. The rest of the communication path could be wired, wireless,

or combination of the two. In general, a mobile user, while communicating, has a wireless connection with a fixed communication facility and rest of the communication path remains wired. The range of wireless communication is always limited and therefore the range of user mobility is also limited. To overcome this limitation, the cellular communication environment has been devised. In a cellular communication environment, a geographical region is divided into smaller regions called cells, thus the name cellular. Each cell has a fixed communication device that serves all mobile devices within that cell. However, as a mobile device, while in active communication, moves out of one cell and into another cell, service of that connection is transferred from one cell to another. This is called the handoff process [7,16].

The cellular arrangement has many attractive features. As the cell size is small, the mobile devices do not need very high transmitting power to communicate. This leads to smaller devices that consume less power. In addition, it is well known that the frequency spectrum that can be used for wireless communication is limited and can therefore support only a small number of wireless communication connections at a time. Dividing communication regions into cells allows the use of the same frequency in different cells as long as they are sufficiently far apart to avoid interference. This increases the number of mobile devices that can be supported. Advances in digital signal processing algorithms and faster electronics have led to very powerful, smaller, elegant, and versatile mobile communication devices. These devices have tremendous mobile communication abilities including wireless Internet access, wireless e-mail and news items, and wireless video (though limited) communication on handheld devices. Wireless telephones are already available and operate in different communication environments across the continents. The day is not far when a single communication number will be assigned to every newborn and will stay with that person irrespective of his/her location.

Another field that is emerging rapidly is the field of ad hoc wireless communication networks. These networks are of a temporary nature and are established for a certain need and for a certain duration. There is no elaborate setup needed to establish these networks. As a few mobile communication devices come in one another's proximity, they can establish a communication network among themselves. Typical situations where ad hoc wireless networks can be used are in the classroom environment, corporate meetings, conferences, disaster recovery situations, etc. Once the need for networking is satisfied, the ad hoc networking setup disappears.

38.4 Resource Allocation Techniques

As discussed earlier, computer networks are resource sharing systems. Users share the common resources as transmission media, processing power and buffering capacity at the switching nodes, and other resources that are part of the networks. A key to successful operation of computer networks is a fair and efficient allocation of resources among its users. Historically, there have been two approaches to allocation of resources to users in computer networks:

- Static allocation of resources
- Dynamic allocation of resources

Static allocation of resources means that a desired quantity of resources is allocated to each user who may use it whenever he or she needs to. If the user does not use his/her allocated resources, no one else can. On the other hand, dynamic allocation of resources means that a desired quantity of resources is allocated to users on the basis of their demands and for the duration of their need. Once the need is satisfied, the allocation is retrieved. In that case, someone else can use these resources if needed. Static allocation results in wastage of resources, but does not incur the overhead associated with dynamic allocation. Which technique should be used in a given situation is subject to the concept of supply and demand. If resources are abundant and demand is not too high, it may be better to have static allocation of resources; however, when the resources are scarce and demand is high, dynamic allocation is almost a necessity to avoid the wastage of resources.

Historically, communication and computer networks have dealt with both situations. Earlier communication environments used dynamic allocation of resources when users walked to a public call office to

make a telephone call or send a telegraphic message. After a few years, static allocation of resources was adopted, when users were allocated their own dedicated communication channels and these were not shared among others. In the late 1960s, the era of computer networks dawned with dynamic allocation of resources and all communication and computer networks have continued with this tradition to date. With the advent of optical fiber, it was felt that the transmission resources are abundant and can satisfy any demand at any time. Many researchers and manufacturers were in favor of going back to the static allocation of resources, but a decision to continue with dynamic resource allocation was made and that is here to stay for many years to come [10].

38.5 Challenges and Issues

Many challenges and issues are related to communications and computer networks that are still to be overcome. Only the most important ones will be described in this section.

High data rates provided by optical fibers and high-speed processing available at the switching nodes has resulted in lower delay for transferring information from one point to another. However, the propagation delay (the time for a signal to propagate from one end to another) has essentially remained unchanged. This delay depends only on the distance and not on the data rate or the type of transmission medium. This issue is referred to as latency vs. delay issue [11]. In this situation, traditional feedback-based reactive traffic management techniques become ineffective. New preventive techniques for effective traffic management and control are essential for achieving the full potential of these communication and computer networks [22].

Integration of different services in the same networks has also posed new challenges. Each type of service has its own requirements for achieving a desired level of quality of service (QoS). Within the networks any attempt to satisfy QoS for a particular service will jeopardize the QoS requirements for other services. Therefore, any attempt to achieve a desired level of quality of service must be uniformly applied to the traffic inside a communication and computer network and should not be intended for any specific service or user. That is another challenge that needs to be carefully addressed and its solutions achieved [13].

Maintaining security and integrity of information is another continuing challenge. The threat of sensitive information passively or actively falling into unauthorized hands is very real. In addition, proactive and unauthorized attempts to gain access to secure databases are also very real. These issues need to be resolved to gain the confidence of consumers so that they may use the innovations in communications and computer networking technologies to their fullest [13].

38.6 Summary and Conclusions

This chapter discussed the fundamentals of communications and computer networks and the latest developments related to these fields. Communications and computer networks have witnessed tremendous growth and sophisticated improvements over the last several decades.

Computer networks are essentially resource sharing systems in which users share the transmission media and the switching nodes. These are used for exchanging information among users that are not necessarily connected directly. There has been a manifold increase in transmission rates of transmission media and the processing power of the switching nodes (which are essentially computers) has also been multiplied. The emerging computer networks are supporting communication of different types of services in an integrated fashion. All types of information, irrespective of type and source, are being transported in the form of packets (e.g., ATM cells). Resources are being allocated to users on a dynamic basis for better utilization. Wireless communication networks are emerging to provide worldwide connectivity and exchange of information at any time.

These developments have also posed some challenges. Effective traffic management techniques, meeting QoS requirements, and information security are the major challenges that need to be surmounted in order to win the confidence of users.

References

1. Bae, J., and Suda, T., "Survey of traffic control schemes and protocols in ATM networks," *Proceedings of the IEEE*, Vol. 79, No. 2, February 1991, pp. 170–189.
2. Beyda, W., "Data communications from basics to broadband," Third Edition, 2000.
3. Black, U., "ATM: foundation for broadband networks," Prentice-Hall, Englewood Cliffs, NJ, 1995.
4. Black, U., "Emerging communications technologies," Second Edition, Prentice-Hall, Englewood Cliffs, NJ, 1997.
5. Chou, C., "Computer networks in communication survey research," *IEEE Transactions on Professional Communication*, Vol. 40, No. 3, September 1997, pp. 197–208.
6. Comer, D., "Computer networks and internets," Prentice-Hall, Englewood Cliffs, NJ, 1999.
7. Goodman, D., "Wireless personal communication systems," Addison-Wesley, Reading, MA, 1999.
8. Goralski, W., "Introduction to ATM networking," McGraw-Hill, New York, 1995.
9. Freeman, R., "Fundamentals of telecommunications," John Wiley & Sons, New York, 1999.
10. Ilyas, M., and Mouftah, H.T., "Performance evaluation of computer communication networks," *IEEE Communications Magazine*, Vol. 23, No. 4, April 1985, pp. 18–29.
11. Kleinrock, L., "The latency/bandwidth tradeoff in gigabit networks," *IEEE Communications Magazine*, Vol. 30, No. 4, April 1992, pp. 36–40.
12. Kleinrock, L., "ISDN-The path to broadband networks," *Proceedings of the IEEE*, Vol. 79, No. 2, February 1991, pp. 112–117.
13. Leon-Garcia, A., and Widjaja, I., "Communication networks, fundamental concepts and key architectures," McGraw Hill, New York, 2000.
14. Mukherjee, B., "Optical communication networks," McGraw-Hill, New York, 1997.
15. Partridge, C., "Gigabit networking," Addison-Wesley, Reading, MA, 1994.
16. Rappaport, T., "Wireless communications," Prentice-Hall, Englewood Cliffs, NJ, 1996.
17. Schwartz, M., "Broadband integrated networks," Prentice-Hall, Englewood Cliffs, NJ, 1996.
18. Shay, W., "Understanding communications and networks," Second Edition, PWS, 1999.
19. Stallings, W., "Local and metropolitan area networks," Sixth Edition, Prentice-Hall, Englewood Cliffs, NJ, 2000.
20. Stallings, W., "ISDN and broadband ISDN with frame relay and ATM," Fourth Edition, Prentice-Hall, Englewood Cliffs, NJ, 1999.
21. Stallings, W., "High-speed networks, TCP/IP and ATM design principles," Prentice-Hall, Englewood Cliffs, NJ, 1998.
22. Yuan, X., "A study of ATM multiplexing and threshold-based connection admission control in connection-oriented packet networks," Doctoral Dissertation, Department of Computer Science and Engineering, Florida Atlantic University, Boca Raton, Florida 33431, August 2000.

39

Fault Analysis in Mechatronic Systems

Leila Notash
Queen's University

Thomas N. Moore
Queen's University

- 39.1 Introduction
- 39.2 Tools Used for Failure/Reliability Analysis
- 39.3 Failure Analysis of Mechatronic Systems
- 39.4 Intelligent Fault Detection Techniques
- 39.5 Problems in Intelligent Fault Detection
- 39.6 Example Mechatronic System: Parallel Manipulators/Machine Tools
Parallel Architecture Manipulators (Based on a Paper by Huang and Notash 1999) • Tool Condition Monitoring
- 39.7 Concluding Remarks

39.1 Introduction

As the degree of automation increases, particularly intelligent automation, high reliability, fail-safe and fault tolerance become an essential part of the mechatronic system design. A mechatronic system is reliable if no failure and malfunction could result in an unsafe system; is safe if it causes no injury or damage to the operator, environment and system itself; is fail-safe if the system could be stopped safely after the failure; and is fault tolerant if the system could complete its task safely after any failure.

Fault/failure corresponds to any condition or component/subsystem degradation (sharp or graceful degradation) that affects the performance of a system such that the system cannot function as it is required. As the application of the mechatronic systems expands to areas such as highly dynamic/unstructured or space/remote environments, medical and high-speed applications, the necessity for the system to be fail-safe (could stop with no harm to the environment, operator, and itself) and fault tolerant (tolerate the failure and complete the assigned task) increases.

A mechatronic system is called fault tolerant if after any failures there will be no interruption in the task/operation of the system. Fault tolerance and high reliability could be achieved by using high quality components, through design and robust control, and by incorporating redundancy in the design of mechatronic systems. A mechatronic system consists of mechanical, electrical, computer, and control (hardware and software) subsystems. Therefore, their redundancy could be in the form of hardware redundancy (redundancy in sensing, actuation, transmission, communication, and computing), software redundancy, analytical redundancy, information redundancy, and time redundancy.

39.2 Tools Used for Failure/Reliability Analysis

The failure analysis techniques could be classified as inductive techniques and deductive techniques (Wolfe, 1978). Inductive techniques, such as decision or event trees and failure modes and effects analysis (FMEA), consider the possible states of components/subsystems and determine their effects on the system, i.e.,

identify the undesired state. Deductive analyses, such as fault tree analysis (FTA), involve investigation of possible desired state of the overall system and identify the component states that contribute to the occurrence of the undesired state, i.e., describe how the undesired state is achieved.

The event tree method is a pictorial representation of all the events (success or failures) that can occur in a system. Similar to other techniques, the event tree method can be used for systems in which all subsystems/components are continuously operating. This method is also widely used for systems in which some or all of the subsystems/components are in a standby mode with sequential operational logic and switching, such as safety oriented systems (Billinton and Allan, 1983).

FMEA is a bottom-up qualitative technique used to evaluate a design by identifying possible failure modes and their effects on the system, occurrence of the failure modes, and detection techniques. The history of FMEA goes back to the early 1950s when the technique was utilized in the design and development of flight control systems (Dhillon, 1983). Since then it has been widely used in the industry for specific designed systems with known knowledge of their components, subsystems, functions, required performance and characteristics, and so on. Criticality analysis (CA) is a quantitative method used to rank critical failure mode effects by taking into consideration the probability of their occurrence. FMECA is a design technique composed of FMEA and CA and provides a systematic approach to clarify hardware failures.

Fault tree analysis (FTA) is a top-down procedure which considers components in working or failed states, and it has been proven difficult to handle degraded component states. FTA can be used to obtain minimum cut sets, which define the modes of system failures and identify critical components. The reliability measures for the top event of FTA can be obtained provided that the failure data on primary events/failures is available.

39.3 Failure Analysis of Mechatronic Systems

The failure modes of a mechatronic system include failure modes of mechanical, electrical, computer, and control subsystems, which could be classified as hardware and software failures. The failure analysis of mechatronic systems consists of hardware and software fault detection, identification (diagnosis), isolation, and recovery (immediate or graceful recovery), which requires intelligent control.

The hardware fault detection could be facilitated by redundant information on the system and/or by monitoring the performance of the system for a given/prescribed task. Information redundancy requires sensory system fusion and could provide information on the status of the system and its components, on the assigned task of the system, and the successful completion of the task in case of operator error or any unexpected change in the environment or for dynamic environment.

The simplest monitoring method identifies two conditions (normal and abnormal) using sensor information/signal: if the sensor signal is less than a threshold value, the condition is normal, otherwise it is abnormal. In most practical applications, this signal is sensitive to changes in the system/process working conditions and noise disturbances, and more effective decision-making methods are required. Generally, monitoring methods can be divided into two categories: model-based methods and feature-based methods. In model-based methods, monitoring is conducted on the basis of system modeling and model evaluation. Linear, time-invariant systems are well understood and can be described by a number of models such as state space model, input–output transfer function model, autoregressive model, and autoregressive moving average (ARMA) model. When a model is found, monitoring can be performed by detecting the changes of the model parameters (e.g., damping and natural frequency) and/or the changes of expected system response (e.g., prediction error). Model-based monitoring methods are also referred to as failure detection methods.

Model-based systems suffer from two significant limitations. First, many systems/processes are non-linear, time-variant systems. Second, sensor signals are very often dependent on working conditions. Thus, it is difficult to identify whether a change in sensor signal is due either to the change of working conditions or to the deterioration of the process.

Feature-based monitoring methods use suitable features of the sensor signals to identify the operation conditions. The features of the sensor signal (often called the monitoring indices) could be time and/or

frequency domain features of the sensor signal such as mean, variance, skewness, kurtosis, crest factor, or power in a specified frequency band. Choosing appropriate monitoring indices is crucial. Ideally the monitoring indices should be: (i) sensitive to the system/process health conditions, (ii) insensitive to the working conditions, and (iii) cost effective. Once a monitoring index is obtained, the monitoring function is accomplished by comparing the value obtained during system operation to a previously determined threshold, or baseline, value. In practice, this comparison process can be quite involved. There are a number of feature-based monitoring methods including pattern recognition, fuzzy systems, decision trees, expert systems, and neural networks.

Fault detection and identification (FDI) process in dynamic systems could be achieved by analytical methods such as detection filters, generalized likelihood ratio (which uses Kalman filter to sense discrepancies in system response), and multiple mode method (which requires dynamic model of the system and could be an issue due to uncertainty in the dynamic model) (Chow and Willsky, 1984).

As mentioned above, the system failures could be detected and identified by investigating the difference between various functions of the observed sensor information and the expected values of these functions. In case of failure, there will be a difference between the observed and the expected behavior of the system, otherwise they will be in agreement within a defined threshold. The threshold test could be performed on the instantaneous readings of sensors, or on the moving average of the readings to reduce noise.

In a sensor voting system, the difference of the outputs of several sensors and each component (sensor or actuator) is included in at least one algebraic relation. When a component fails, the relations including that component will not hold and the relations that exclude that component will hold. For a voting system to be fail-safe and detect the presence of a failure, at least two components are required. For a voting system to be fail-operational and identify the failure, at least three components are required, e.g., three sensors to measure the same quantity (directly or indirectly). As Chow and Willsky (1984) pointed out, for the detection and identification of a single failure among m components at least $(m - 1)$ relations are required (more relations are preferred for better performance in the presence of noise).

39.4 Intelligent Fault Detection Techniques

The fault tolerant control (robust control and decision-making process) should include allowable performance degradation in the failed state, criticality and likelihood of the failure, urgency of response to failure, tradeoffs between correctness and speed of response, normal range of system uncertainty, disturbance environment, component reliability vs. redundancy, maintenance goals (mean-time-to-failure, mean-time-to-repair, maintenance-hour/operation-hour, etc.), system architecture, limits of manual intervention, and life-cycle costs (Stengel, 1991).

Fault detection could be achieved by redundancy in sensing (measurement) and actuation, parallel redundancy (e.g., dual sensors or actuators), analytical redundancy, and artificial intelligence (expert systems, artificial neural network, or integration of both techniques) combined with redundancy.

Stengel (1991) classified the analytical redundancy into direct and temporal redundancy. Direct redundancy consists of algebraic relationship among instantaneous outputs of sensors and is useful for sensor failure detection, but not for actuator failure detection. Temporal redundancy includes the relationship among histories of sensor outputs and actuator inputs (also comparison of the outputs of dissimilar sensors at different times). Temporal redundancy could be used for both sensor and actuator FDI, e.g., a sensor voting system with mixed displacement and velocity sensors could detect failures of both types of sensors. The computational complexity of temporal redundancy is higher compared to the direct redundancy case as it requires the dynamics of the system.

An expert system embodies in a computer the knowledge-based component of an expert skill in such a manner that the system can generate intelligent actions and advice and can, when required, justify to the user its line of reasoning. In general, an expert system is composed of three parts: an inference engine, a human-machine interface, and a knowledge base. The inference engine is the knowledge processor and is modeled after the expert's reasoning. The engine works with available information on a particular problem, coupled with the knowledge stored in the knowledge base to draw conclusions or recommendations.

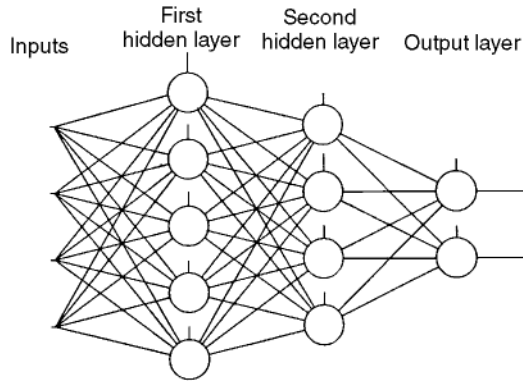

FIGURE 39.1 Architecture of a typical multilayer feedforward neural network.

The knowledge base contains highly specialized knowledge on the problem area as provided by the expert in the form of statistical analysis, empirical or semi-empirical rules, theoretic and computer simulation studies, and experimental testing. It includes problem facts, rules, concepts, and relationships.

Expert systems have obvious knowledge representation forms that make knowledge easy to manage, have the capability to explain their behavior, and can diagnose new faults using their knowledge bases. At the same time, self-learning is still a problem and computation time can be quite lengthy for difficult tasks.

A neural network is a highly nonlinear system with adaptation and generalization capabilities. There are many different architectures of neural networks; however, the multilayer feedforward neural network (refer to Fig. 39.1) is one of the most popular ones. This is because of the simplicity, availability of efficient learning methods, generalization capabilities, and noise tolerance of these networks. This network is a collection of simple, interconnected nodes, also known as neurons, which operate in parallel and store knowledge on the strength of connections between the individual nodes. Such a parallel computing network, inspired by the computational architecture of the human brain, has been successfully applied to intelligent tasks such as learning, speech synthesis, and pattern recognition. The input vector feeds into each of the first layer neurons, the outputs of this layer feed into each of the second layer neurons, and so on. The last layer, which generates output to the external world, is called the output layer. The hidden layers are not connected to the external world. Often the neurons are fully connected between the layers, i.e., every neuron in layer l is connected to every neuron in layer $l + 1$.

Training a neural network consists of the process of finding the set of interconnection weights (there is an interconnection weight associated with each neuron which modifies the input signal to that neuron in a specific manner), which results in a network output that satisfies a predefined criterion. Feedforward neural networks are trained using the backpropagation algorithm. This is a supervised training method. This means that the network will be presented with sample inputs and correct responses, called a training pattern. The network is then trained to reproduce the correct responses.

Neural networks have capabilities of association, memorization, error tolerance, self-adaptation, and multiple complex pattern processing. However, they cannot explain their own reasoning behavior and cannot diagnose new faults (those not already made available previously in training the network).

39.5 Problems in Intelligent Fault Detection

The fault detection scheme should be capable of detecting and identifying the failures correctly and promptly with minimum delays. This requires a reconfigurable robust controller. That is, the controller should distinguish between failures, uncertainties/inaccuracies in the model of the system, and disturbances such as sensor noise; and reduce the effect of measurement error and noise, uncertainties in the system model, and disturbances (even component failure) on the system output.

The sensor noise could be taken care of by statistical analysis on sensor readings. The uncertainties in the system model could be taken care of by estimating the effect of parameter uncertainties and compensating for it in the FDI system, or by minimizing the sensitivity of the FDI system to these uncertainties. The detection scheme should also be capable of monitoring the degradation of the system, as well as evolution and progress of failure over time (and predicting the failure), and responding to each accordingly.

39.6 Example Mechatronic System: Parallel Manipulators/Machine Tools

Parallel structured machine tools consist of multiple serial branches/legs acting in parallel on a common mobile platform with the spindle being connected to the mobile platform. Parallel manipulator-based devices have the advantages of not requiring actuation of base distal joints and of having their active joints acting in parallel on the mobile platform. These advantages can lead to parallel machine tools having desirable stiffness, accuracy, and dynamic characteristics, which, in turn, will provide high material removal rate (high product volume) with tight tolerances and in-process inspection capability (on-machine measurements of workpieces, fixtures, and tools during and after manufacturing process without breaking setups).

The failure analysis of parallel machine tools should include failures of parallel architecture, as well as failure of cutting tool, in addition to software failures.

Parallel Architecture Manipulators (Based on a Paper by Huang and Notash, 1999)

The following discussion will focus on the design orientated failure analysis of the mechanical system of parallel manipulators/machines.

Parallel manipulators consist of a base platform (stationary link), a mobile platform (end effector), and multiple branches/legs connecting the base and mobile platforms. Figure 39.2 depicts an example of a six-branch parallel manipulator.

The mechanical failure modes of manipulators could be classified as joint failure (component), link failure/breakage (component), branch failure (subsystem), end effector failure (subsystem), and device failure (system). Figure 39.3 represents the top level FTA of a three-branch parallel manipulator/machine.

Component Failures

Parallel (closed-loop) manipulators possess both active joints (joints that are sensed and actuated) and passive joints (unactuated joints which could be sensed or unsensed). Therefore, their failures could be due to the failures of active, passive sensed, or passive unsensed joints. The failure of any joint will cause

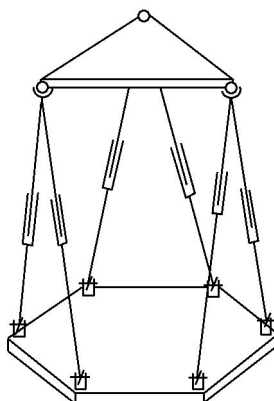

FIGURE 39.2 Example of a six-branch parallel manipulator/machine.

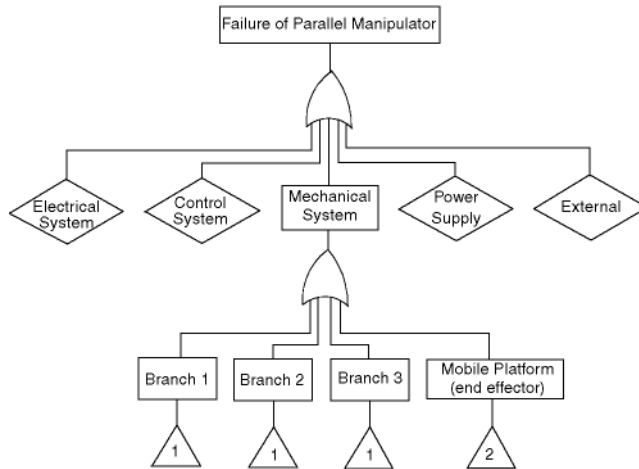

FIGURE 39.3 Top level fault tree for a three-branch parallel manipulator.

the failure of the parallel manipulator, unless the device is redundantly actuated/sensed or has a redundant unsensed joint(s) for the given task.

The common failure modes of active, passive sensed, and passive unsensed joints are the joint break and joint jam. The only failure modes of passive unsensed joints are the common joint failures. The failure modes of passive sensed joints include sensor failure, in addition to the common failure modes. In this case, the motion of the joint cannot be measured and the joint will be reduced to a passive unsensed joint. The major failure modes of active joints could be classified as actuator failure, transmission failure, and sensor failure. As a result of an actuator failure, the active joint degrades to a passive sensed joint, provided that the joint is back drivable; otherwise, the joint must be locked and the corresponding branch and the parallel manipulator will lose one DOF and an actuation. Because of a transmission failure, the actuator fails to drive the joint, and the active joint could only be used as a passive sensed joint. When the sensor of an active joint fails, although the actuator may operate properly, the motion of the joint cannot be controlled as there will be no reliable information available on the joint motion; hence, the active joint is degraded to a passive unsensed joint.

Subsystem Failures

The branches of a parallel device could be categorized as active or passive branches. An active branch possesses at least one active joint to provide a required force and to facilitate a suitable loci for the branch end location. A passive sensed branch has at least one sensed joint and its main function is to constrain the loci of the branch end position. Neither joint of a passive unsensed branch is sensed, and the branch is mainly used to constrain the motion of the mobile platform.

A branch of a parallel manipulator could fail because of component (link, joint) failures. As well, a branch will not follow its assigned path if it is in the workspace boundary, or at an internal singularity (where it loses one or more DOF). Therefore, the mechanical failure modes of a branch include branch break, loss of DOF, and loss of sensing/actuation.

Mechanical System Failures

A parallel manipulator could fail because of component and/or subsystem failures. Therefore, the mechanical failures of a parallel manipulator include loss of the DOF, loss of the actuation, loss of the motion constraint, and uncertainty configurations. A summary of the mechanical failure levels, modes, effects, and causes of parallel manipulators has been tabulated in [Table 39.1](#).

TABLE 39.1 Failure Modes of Parallel Manipulators and Their Effects

| Failure Levels | | Failure Modes | Failure Causes | Effects | |
|------------------|----------------|---------------------------|--|--|--|
| Components | Links | Break | Overload, fatigue, impact, material flaw | Reduction in number of branches | |
| | Joints | Common | Joint break | Overload, fatigue, impact, material flaw | Reduction in number of branches |
| | | | Joint jam | Deterioration, external interference | Reduction in DOF of corresponding branch |
| | Active | Active | Actuator failures | Depends on actuator type | Reduction in actuation, DOF if joint not back-drivable |
| | | | Transmission failures | Depends on transmission type | Reduction in actuation, DOF if joint not back-drivable |
| | | | Sensor failures | Depends on sensor type | Reduction in sensing, actuation, maybe DOF |
| | Passive sensed | Passive sensed | Sensor failures | Depends on sensor type | Reduction in sensing |
| | | | Passive unsensed | Common failures (break, jam) | Overload, fatigue, impact, material flaw; deterioration, external interference |
| | Branches | Common | Break | Joint/link break | Reduction in number of branches, maybe actuation and DOF, interference with other branches |
| | | | Loss of DOF | Joint jam, locked active joint, branch singularity | Reduction in DOF of manipulator |
| Active | | Active | Loss of actuation | Active joint failure | Reduction in actuation, maybe DOF |
| | | | Loss of sensing | Sensor failure | Reduction in actuation, degradation to passive branch |
| Passive sensed | | Passive sensed | Loss of sensing | Sensor failure | Reduction in sensing, degradation to passive unsensed branch |
| Passive unsensed | | Passive unsensed | Common failures (break, loss of DOF) | Joint/link break, joint jam, locked active joint, branch singularity | Reduction in constraint or DOF of manipulator |
| Manipulator | | Loss of DOF | Joint jam, branch singularity, branch interference | Insufficient DOF | |
| | | Loss of actuation | Active joint/branch failure | Degradation in force and motion capabilities | |
| | | Loss of constraint | Reduction in number of active branches | | Uncontrolled motion of manipulator |
| | | | Passive unsensed branch break | | Uncontrolled motion of manipulator |
| | | Uncertainty configuration | | Instantaneous uncontrolled motion of manipulator | |

Failure Identification

A fault tolerant manipulator should be capable of identifying a failure, as well as tolerating the failure. The failed component (mechanical system) of a parallel manipulator, e.g., a failed joint sensor, could be identified via the manipulator controller using the information provided by the sensors of the device. A joint sensor fault detection scheme for a class of fault tolerant parallel manipulators, based on redundant sensing of joint displacements and the comparison of forward displacement solutions, was presented in (Notash, 2000).

While the failure of active joints could be identified based on the information provided by the sensor(s) on the corresponding joint, failure of passive joints could be identified by monitoring the overall performance of the manipulator in the software. For a given parallel manipulator, the criteria for failure should be incorporated in the simulation software. For example, the loss of DOF due to workspace boundary could be monitored (similar to the joint limits and branch interference) and the manipulator could be stopped before it reaches its envelope to prevent potential failure and damage to the device. As well, all of the potential special (uncertainty) configurations of the manipulator should be identified, and the closeness to these singularities should be monitored as the device moves around within its workspace.

Fault Tolerance Through Redundancy

The fault tolerant capabilities of parallel manipulators could be improved by employing appropriate redundancies. Redundant sensing has been investigated for improving the fault tolerance capabilities of parallel manipulators, for simplifying the forward displacement analysis of these manipulators, and for facilitating fixtureless calibration of these devices. Redundancy in actuation has been considered for eliminating the uncertainty configurations of parallel manipulators. More work is required to develop methodologies for identifying the failed components of parallel manipulators with elements of redundancy, and compensating for their failures. For parallel manipulators, redundancy could be incorporated as redundant DOF (mobility), redundant sensing, and redundant actuation.

Redundant DOF could be achieved by incorporating additional joints into the parallel manipulator. A redundant DOF requires one more actuator on the parallel manipulator. This additional actuator is not considered as a redundant one because its failure will result in the failure of the parallel manipulator due to the loss of a required actuation. Redundancy in sensing could be obtained by sensing the existing passive unsensed joints of the manipulator, by adding a redundant passive sensed branch, or by using an external sensor such as a vision system. It should be noted that the information redundancy is achieved by redundant sensing, as well as by providing the task description of the manipulator, such as the Cartesian trajectory of the end effector (for robot path planning and machining operation). Redundancy in actuation could be accomplished by actuating the passive joints of the manipulator, or by adding an active branch (in addition to employing dual actuators).

Tool Condition Monitoring

An important element of the automated process control function is the real-time detection of cutting tool failure, including both wear and fracture mechanisms in machining operations. The ability to detect such failures online would allow remedial action to be undertaken in a timely fashion, thus ensuring consistently high product quality (quality of surface finish and dimensional precision) and preventing potential damage to the process machinery. The basic premise of any automated, real-time tool condition monitoring system is that there exists either a directly measurable, or a derived parameter, which can be related to advancing tool wear and/or breakage. Information about tool wear, if obtained online, can be used to establish tool change policy, adaptive control, economic optimization of machining processes, and full automation of machining processes.

In the ideal case, the system should be able to detect levels of wear well below those at which the tool would have to be replaced and should also be sensitive to relatively small changes in the level of wear. The latter characteristic would provide the system with the potential to “trend” the wear pattern and predict the amount of useful life left in the tool (allowable wear limit reached).

With respect to tool fracture, the system should be able to detect both small fractures, “chipping” phenomena, and catastrophic failure of a tool. Although prediction of such failures would be desirable, it is problematic whether this is a practical goal, at least in the near future. The number of variables, which determine the actual occurrence of tool fracture together with their complex interactions, and in many instances their underlying stochastic nature, make reliable prediction capabilities, at best, a long-term prospect in tool monitoring systems.

Cutting Tool Failure Monitoring Techniques

Tool condition monitoring systems are based upon either direct or indirect methods of quantifying the magnitude of tool failure.

The direct methods are those that utilize effects caused directly by tool failure. The direct methods, usually performed by means of optical, radiometric, pneumatic, or contact sensors can be effectively applied to the offline measurement of tool wear or breakage. However, such direct means of measuring tool failure have generally been found to be difficult to apply in practical shop floor applications. This is particularly true in those situations requiring online (real-time) monitoring capability.

Indirect methods of sensing tool failure depend upon the measurement of parameters, which are indirectly related to the condition of the cutting edge. For example, the cutting forces generated during a machining operation are dependent upon the condition of the tool’s cutting edge. Generally, as the tool edge wears the generated cutting forces increase. Thus, measurement of the cutting forces present during a machining operation provides an indication of the tool condition, i.e., increasing cutting forces indicates increasing wear. In reality the relationship can be very complex. Other parameters that have been studied to determine their suitability as indicators of cutting tool failure include spindle motor current, acoustic emissions, cutting tool temperature, and noise and vibration signals. It is also possible to measure cutting forces directly and then relate these values to the condition of the cutting tool. In fact, this is one of the more common indirect tool wear monitoring methods. It has been reported that cutting force signals are more sensitive to tool wear than vibration or power measurements. The general reliability of force measurements is another reason for their popularity in tool condition monitoring applications. To use cutting force measurements for practical tool monitoring systems, there is a need to relate these forces to the state of tool condition online. However, since the measured cutting forces are affected by both cutting edge condition and changes in cutting conditions (feed rate, cutting speed, and depth of cut), the detection of tool failure using measurements of these forces becomes quite challenging in practice.

System Characteristics

Whether a tool condition monitoring system employs direct or indirect measures of tool failure (automated, computer-based system or not), it must include a number of common features if it is to be truly practical. Figure 39.4 shows the block diagram of a generalized tool condition monitoring system (Braun, 1986).

In the *measurement* section, the physical parameter (or possibly, parameters) of interest is converted to a form that is appropriate for further manipulation by the system (generally a digitized representation of an electric analog signal).

Within the *processing* section, various techniques are implemented in order to suppress noise, compress information, and emphasize important features of the acquired signal. Typical methods include analog

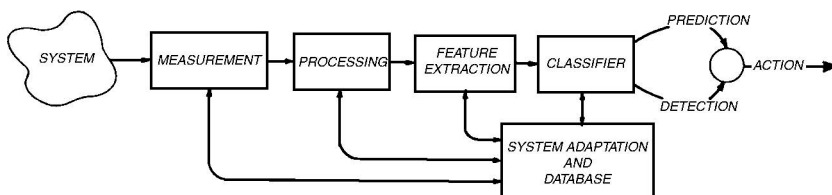

FIGURE 39.4 Block diagram of a generalized tool condition monitoring system.

or digital filtering, time domain averaging, Fourier transformation, parametric identification based on ARMA models, etc.

The purpose of the *feature extraction* section is to obtain a specific feature, or features, (often referred to as a feature vector), which can be used by the *classifier* to determine the specific type of failure and initiate appropriate corrective actions. Examples of features would include total power of the signal, crest factor value, power in a particular frequency range, frequency of the maximum peak, amplitude of the maximum peak, the autoregressive parameters of an ARMA model, etc. If multiple features are employed, they should be uncorrelated so that they provide independent indications of tool failure. When coupled with a hierarchical decision tree structure (or other appropriate structure) in the *classifier*, such multiple feature vectors can greatly improve the reliability of the tool monitoring system.

The *adaptation and database* section should not only efficiently manage all data storage and manipulation requirements but also provide the system, to as great a degree as possible, with the ability to learn from experience.

39.7 Concluding Remarks

It should be noted that the first and most practical step for increasing the reliability and improving the fault tolerance of mechatronic systems, e.g., a parallel machine, is by enhancing the existing design, or by improving the robustness of the design, such as using coupled joints while designing the architecture of the manipulator. Redundancies through redesign are recommended for the applications where the fail-safe system could be very crucial, or the down time should be minimum and previously scheduled, such as the medical applications or space operation. It is also worth mentioning that not any redundancy could improve the fault tolerance of a system with no modification to the architecture of the device.

It is noteworthy to emphasize the importance of fail-safe simulation software and controller for a fault tolerant mechatronic system, which requires a robust software capable of monitoring the performance of system and responding to any system failures (including mechanical, electrical, and control systems).

References

1. Billinton, R., and Allan, R.N., *Reliability Evaluation of Engineering Systems: Concepts and Techniques*, Plenum Press, 1987.
2. Braun, S. ed., *Mechanical Signal Analysis—Theory and Applications*, Academic Press, 1986.
3. Chow, E.Y., and Willsky, A.S., “Analytical redundancy and the design of robust failure detection systems,” *IEEE Trans. Automatic Control*, 29(7), 603–614, 1984.
4. Dhillon, B.S., *System Reliability, Maintainability and Management*, Petrocelli Books, 1983.
5. Huang, L., and Notash, L., “Failure analysis of parallel manipulators,” *Proc. 10th IFToMM Congress on Theory of Machines and Mechanisms*, pp. 1027–1032, June, 1999.
6. Notash, L., “Joint sensor fault detection for fault tolerant parallel manipulators,” *J. Robotic Systems*, 17(3), 149–157, 2000.
7. Stengel, R.F., “Intelligent failure-tolerant control,” *IEEE Control Systems*, pp. 14–23, June 1991.
8. Wolfe, W.A., “Fault tree analysis,” Atomic Energy of Canada, Report, 1978.

40

Logic System Design

- 40.1 Introduction to Digital Logic
Logic Switching Levels • Logic Gate Application
- 40.2 Semiconductor Devices
Diode • Bipolar Transistor • Field Effect Transistor (FET)
- 40.3 Logic Gates
- 40.4 Logic Design
Minimization • Dynamic Characteristics • Other Design Considerations
- 40.5 Logic Gate Technologies
Resistor–Transistor Logic (RTL) • Diode–Transistor Logic (DTL) • Transistor–Transistor Logic (TTL) • Emitter–Coupled Logic (ECL) • CMOS Logic
- 40.6 Logic Gate Integrated Circuits
- 40.7 Programmable Logic Devices (PLD)
- 40.8 Mechatronics Application Example

M. K. Ramasubramanian

North Carolina State University

40.1 Introduction to Digital Logic

In analog electronics, voltages and current represent variables that vary continuously from the allowable minimum to the maximum. These variables are measured, amplified, added, and subtracted through analog circuits to achieve the desired results. For instance, measurement of temperature using thermocouples requires the amplification of voltages generated to a suitable range, calibration of the voltage with measured temperatures, and outputting the results on a voltmeter to indicate temperature. In this design, it may be necessary to subtract an offset voltage, multiply with a gain factor depending on the temperature range. The amplification of voltages and current are accomplished easily with operational amplifiers and transistors, respectively. The measured temperature can be used as the feedback signal in a control loop for a mechatronic temperature control system. In digital electronics, the variables assume a binary state, assuming a value of 0 or 1. In the above example, we might want to shut the solenoid valve down if the temperature was below desired value and open the valve if the temperature was above that value. In this case, we simply require a TRUE or FALSE input to the question “Is the temperature above or below the threshold?” The representation of these types of variables in circuits, which assume binary values, and their manipulation to achieve desired results is the topic of discussion in this chapter.

Logic Switching Levels

In digital circuits, voltage levels indicate binary states where the HIGH or TRUE state is represented by the maximum voltage value, typically 5 V, and the LOW or FALSE state is represented by the minimum voltage value, typically 0 V. In Boolean logic, “1” represents TRUE and “0” represents FALSE. In practice, any voltage above a minimum input threshold, V_{IH} , is interpreted as logic HIGH and any voltage below

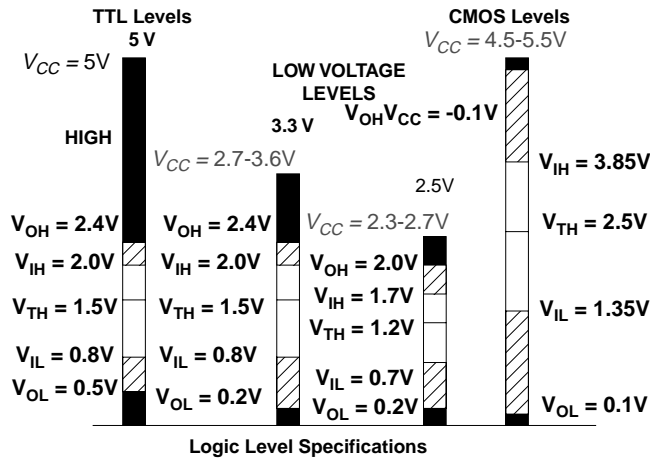

FIGURE 40.1 Switching levels for logic gates [1].

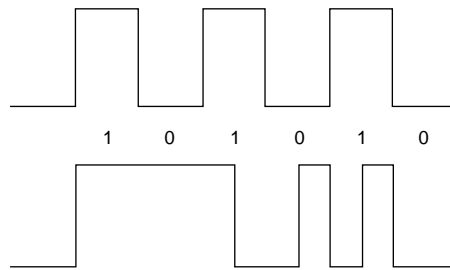

FIGURE 40.2 Periodic and nonperiodic logic level signals.

a maximum threshold, V_{IL} , is interpreted as logic LOW. The minimum output from a logic device for HIGH is represented by V_{OH} (different from V_{IH}), and maximum output level for a logic LOW is represented by V_{OL} (different from V_{IH}). These values depend on the type of logic device and a general chart of values for these parameters is shown in Fig. 40.1 [1]. V_{CC} is the supply voltage. The difference between the V_{OH} and V_{IH} , or V_{OL} and V_{IL} , is called the noise margin. It is important to design the logic circuit with the constraint that voltages will never fall in the region between V_{IH} and V_{IL} , which is called the forbidden region where the logic device will fail to interpret signals. The differences between switching levels for different technologies such as 5-V logic, 3.3-V logic, CMOS (complementary metal oxide semiconductor), and TTL (transistor–transistor logic) should all be considered when interfacing these systems with each other.

A logic variable can rapidly change states as shown by an ideal pulse train in Fig. 40.2. The variables can vary periodically or nonperiodically between 0 and 1. Logic gates read these signals as inputs, perform the appropriate Boolean operations among them, and generate the correct output at desired operating speeds. Robust design and use of logic functions and its implementation in circuits is an integral part of mechatronics design.

Logic Gate Application

Consider the example of an autonomous robot moving about on a table surface. The robot should move towards the destination denoted by a bright light source while avoiding obstacles and at the same time not falling off the edge. Assuming that we have three digital sensors, namely, obstacle detector,

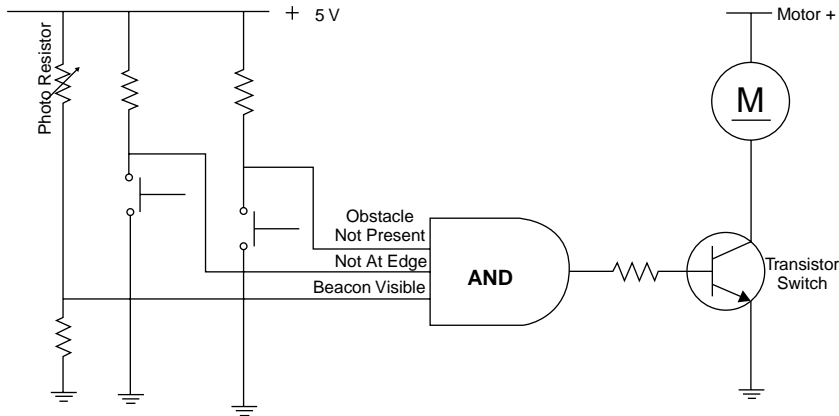

FIGURE 40.3 Forward motion logic implementation for a tabletop robot.

edge detector, and destination sensor, we can write a simple logic function for moving forward, as shown in Eq. (40.1). Of course, this is not the complete logic required for the robot to function properly. However, we focus on one aspect of the problem to illustrate the use of logic functions.

$$\text{MOVE FORWARD} = (\text{OBSTACLE NOT DETECTED}) \text{ AND } (\text{EDGE NOT DETECTED}) \text{ AND } (\text{BEACON IS VISIBLE}) \quad (40.1)$$

The input from the three sensors is interfaced to a logic circuit consisting of logic gates, in this simple example, a three-input AND gate and the output drives the motors. Of course, other cases of behaviors for the robot where the edge is found or the beacon is not visible or an obstacle is detected have to be worked out to make this circuit robust and worthwhile. Figure 40.3 shows an implementation of the logical statement expressed in Eq. (40.1).

40.2 Semiconductor Devices

Diode

In order to understand logic gates, it is important to develop a basic understanding of semiconductor devices, especially the diode and the transistor. A diode is a pn-junction, which means that the diode is made up of a p-type (electron deficient) material layer and an n-type (electron rich) material layer sandwiched together. When the positive terminal of a battery is connected to the p-side of the diode (anode) and the negative of the battery is connected to the n-side of the diode (cathode), then the diode is said to be forward biased as long as the voltage across the junction exceeds 0.7 V. When the terminals are reversed, the diode is said to be reverse biased and does not conduct until very high voltages are applied across the junction, known as the breakdown voltage. For all practical purposes, we can assume that a reverse-biased diode does not conduct. A schematic of a diode, its symbol, and a forward-biased circuit is shown in Fig. 40.4. When forward biased, the diode can be treated as a simple closed switch with a 0.7 V drop across it and when the diode is reverse biased, the diode is an open switch.

Bipolar Transistor

A bipolar transistor has three semiconductor layers. In an npn-transistor, a very thin p-layer is sandwiched between two n-layers. Transistor types and their symbols are shown in Fig. 40.5(a, b).

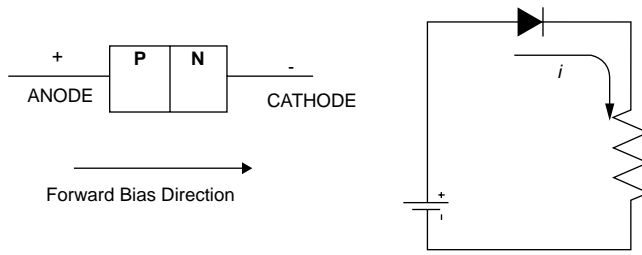

FIGURE 40.4 The diode and its behavior.

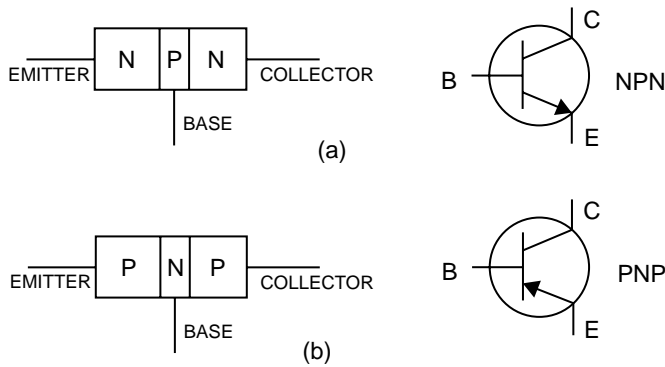

FIGURE 40.5 (a) npn-transistor symbol, (b) pnp-transistor symbol.

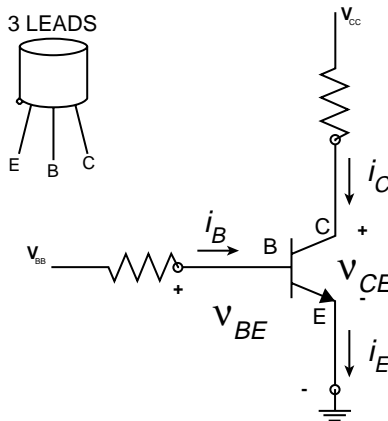

FIGURE 40.6 Schematic representation of the working of an npn-transistor.

There are three leads in a transistor, namely, the collector (C), emitter (E), and the base (B). For an npn-transistor in a circuit, as shown in Fig. 40.6, the base-emitter junction is forward biased and will conduct if the voltage V_{BE} exceeds the forward bias voltage for the pn-junction, typically 0.7 V. V_{BE} is increased by increasing the voltage at B. However, the base-collector junction is reverse biased as the collector C is at a higher potential. As current flows in the base-emitter loop, the electrons from the emitter

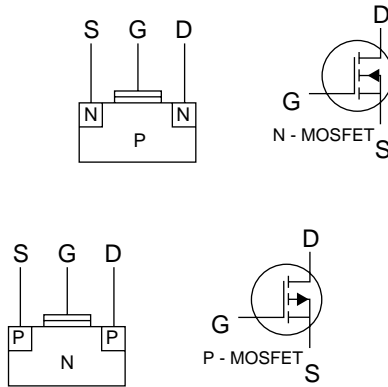

FIGURE 40.7 n- and p-channel MOSFETs and symbols.

flow into the base terminal by filling in the “holes” in the p-layer and subsequently releasing an electron from the p-layer out of the base terminal. However, because of a limited number of “holes” in the p-layer (which is very thin), the electrons from the emitter see a larger potential across the collector–emitter path and jump the junction. A large current, I_C , flows in the collector–emitter loop as a result. Thus, the transistor is a current amplifier. A small current flowing in the base–emitter loop, I_B , is amplified by typically a factor of about 100 in the collector–emitter path. As the current flow in the base–emitter is increased by increasing V_{BE} , the collector–emitter current increases by decreasing V_{CE} . Since the collector is connected to the power source, V_{CC} , and the emitter is connected to the ground, the device controls this current flow by controlling the drop in voltage across the collector–emitter junction, continuing to drop the voltage as the base–emitter current is increased. It is obvious that the voltage cannot drop below 0; in fact, it cannot drop below 0.2–0.35 V in a real device. Under these conditions, the transistor is said to be saturated and is acting as a closed switch. Circuits that are built with transistors in the saturating condition are called saturating circuits; for example, the TTL family of logic gates. Circuits that do not allow the transistor to saturate and find a stable operating point in the active region of the transistor are called nonsaturating circuits; for example, emitter-coupled logic (ECL) gates. The biggest advantage of a nonsaturating circuit is the speed with which states can be changed compared to a saturating circuit.

Field Effect Transistor (FET)

These devices are easier to make and uses less silicon. There are two major classes of FETs, namely, the junction FET (JFET) and the metal oxide semiconductor FET (MOSFET). In both cases, a small input voltage controls the output current with practically no input current. The three terminals are called the source (S), drain (D), and gate (G). [Figure 40.7](#) shows the symbols for the n- and p-channel enhancement type MOSFETs. MOSFET is the most popular of transistor technologies. A MOSFET gate has no electrical contact with the source and the drain. A silicon-dioxide layer insulates the gate. Electrical voltage applied at the gate attracts electrons to the region below the gate and provides an n-type channel in a p-type substrate for conduction between the drain and source. This is called the enhancement type of MOSFET. The other is the depletion-enhancement type where there is an n-channel present between the drain and source, but the channel resistance can be increased or decreased by applying either a negative or a positive voltage at the gate, respectively. Depletion-enhancement MOSFET symbols and function are described in [Fig. 40.8](#). MOSFET devices are slower than bipolar devices and are used in slower but high density circuits, due to ease of manufacture and use of less silicon.

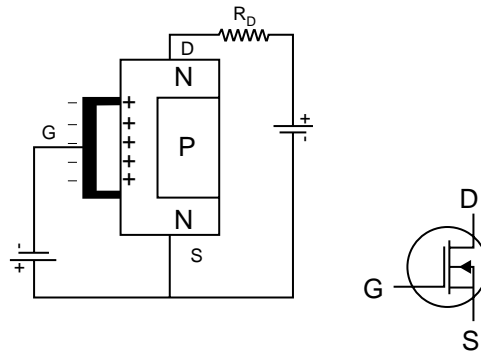

FIGURE 40.8 Depletion-enhancement type MOSFET.

40.3 Logic Gates

Logic gates are the basic building blocks of logic circuits and a computer. Mechatronic systems have a central computational element as well as specific logic functions implemented in hardware. A logic circuit consists of several logic gates working together. We will discuss the logic gates in general and as building blocks of mechatronic subsystems. Logic operations can be subdivided into two categories, namely, combinatorial and sequential. In the case of combinatorial logic circuits, the logic gates are used to produce an output based on instantaneous values of the inputs, whereas in the case of sequential logic circuits, the change in output depends on the present state as well as the state before the changes in input values, thus exhibiting memory behavior. Further, the sequential logic circuits can be synchronous or asynchronous. When the output changes synchronously with a clock input, it is said to be synchronous. When the inputs are read as soon as there is any change in it, it is called an asynchronous logic circuit.

There are three fundamental logic operations, namely the AND, OR, and NOT functions. Other logic operations are derived operations from these fundamental ones. The AND gate symbol and its truth table are shown in Fig. 40.9. The AND gate can have more than two inputs.

Figure 40.10 shows an OR gate. Here the output is HIGH when either of the inputs or both the inputs are HIGH. The OR gate can also have more than two inputs. Figure 40.11 shows an inverter, also known as a NOT gate. This gate takes one input and simply inverts the logic, i.e., a HIGH input is returned as LOW output and vice versa.

Other common logic gates that are derived from these fundamental ones are NAND, NOR, and Exclusive OR gates. NAND gate is a combination of AND and NOT gates; NOR is a combination of OR and NOT gates, and Exclusive OR can be generated with a combination of OR, NAND, and AND gates. Figures 40.12 through 40.14 show the derived gate types, namely the NAND, NOR, and XOR gates and their truth tables, respectively. The logic functions and their implementation into hardware using gates is the basic building block of a digital computer.

40.4 Logic Design

As in any design, it is important to keep it simple, robust, and cost effective. Mechatronics design or logic circuit design is no exception. When a logic function of a system is translated into relationships between inputs and outputs, it is not certain if the number of elements involved in realizing the design are the minimum or further simplification is possible. If the complexity is defined as the number of logic gates used, then the problem reduces to minimizing the logic function mathematically. However, if complexity is defined as the number of ICs used in the circuit (the amount of real estate occupied by the circuit), additional approaches have to be considered, namely using the same type of gate, as much

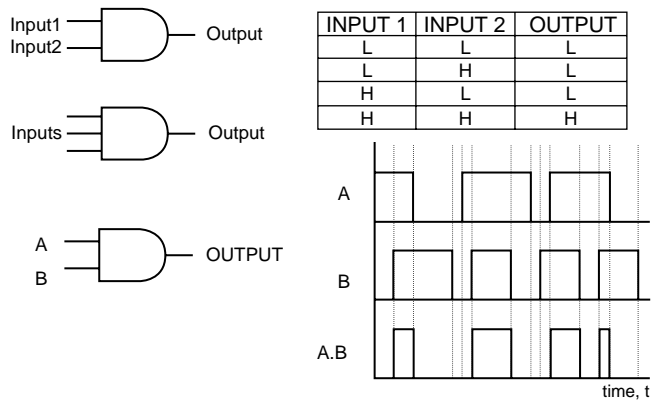

FIGURE 40.9 AND gate, symbol, and behavior.

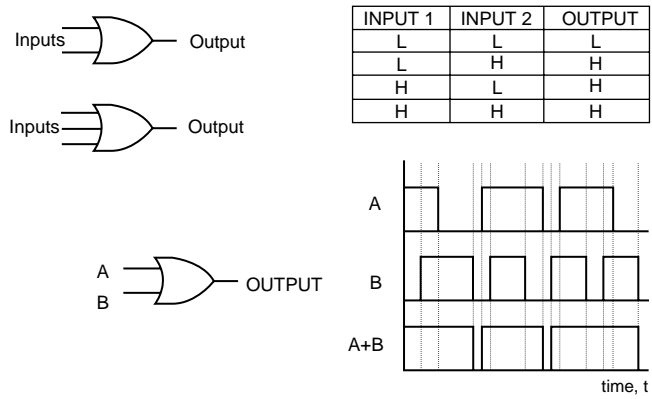

FIGURE 40.10 OR gate, symbol, and behavior.

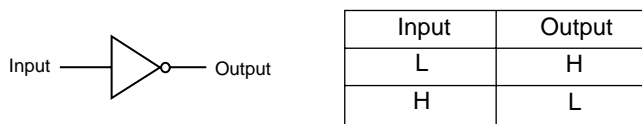

FIGURE 40.11 NOT gate or an inverter, symbol, and behavior.

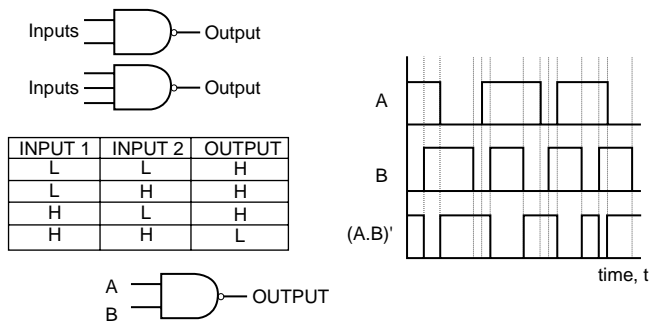

FIGURE 40.12 NAND gate, symbol, and behavior.

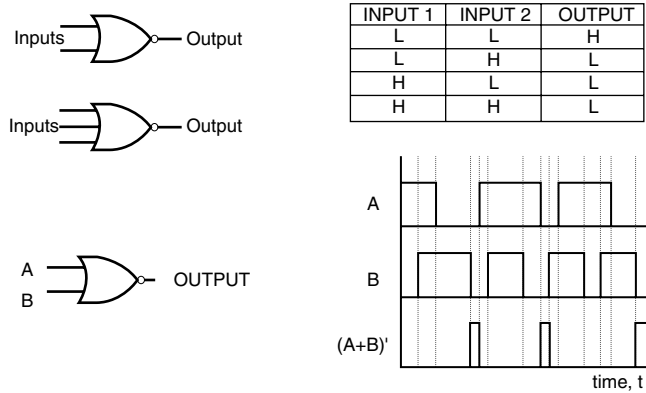

FIGURE 40.13 NOR gate, symbol, and behavior.

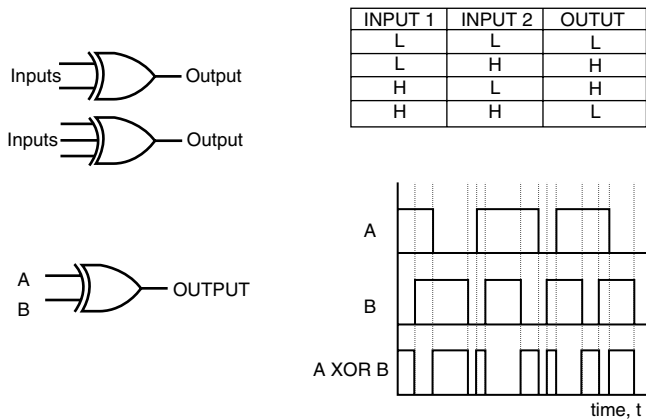

FIGURE 40.14 XOR gate, symbol, and behavior.

as possible, although it may not be minimal in terms of number of gates. This will be preferred over using less different types of gates necessitating use of more ICs, in which some of the gates are unused.

Minimization

A method for minimizing Boolean functions is the Karnaugh map (K-map). From a physical description of the problem, logic statements are written as shown in Eq. (40.1) for the tabletop robot problem. A truth table is generated showing the relationship between inputs and outputs. Let us take a truth table for a three-variable design, shown in Fig. 40.15.

The logical function can be written as

$$X = A'B'C' + A'BC' + ABC' + A'BC \quad (40.2)$$

An implementation of the function without any further consideration will require four 3-input AND gates, one 4-input OR gate, and three inverters. If we assume that both complemented and uncomplemented forms of the signal for each variable are available, we still end up with a complex two-level circuit

| INPUTS | | | OUTPUT |
|--------|---|---|--------|
| A | B | C | X |
| 0 | 0 | 0 | 1 |
| 0 | 1 | 0 | 1 |
| 1 | 0 | 0 | 0 |
| 1 | 1 | 0 | 1 |
| 0 | 0 | 1 | 0 |
| 0 | 1 | 1 | 1 |
| 1 | 0 | 1 | 0 |
| 1 | 1 | 1 | 0 |

FIGURE 40.15 Truth table for a logic circuit design and minimization.

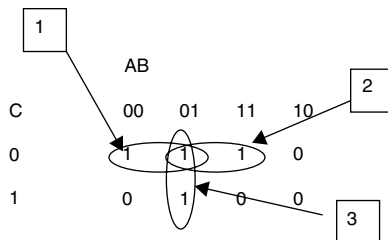

FIGURE 40.16 Karnaugh map for the logic design problem with three inputs and one output.

for what needs to be accomplished. Applying Karnaugh mapping, we can attempt to minimize the Boolean function and hence simplify the type and number of logic gates needed for circuit implementation.

The Karnaugh map is derived from the truth table shown in Fig. 40.15. The two variables AB are grouped for column designations and the third variable provides the row designation. The values are arranged in such a way that adjacent columns or rows differ by only 1 bit.

Figure 40.16 essentially represents the logic described in the truth table in Fig. 40.15. Because adjacent blocks in a K-map differ by 1 bit, the bit that changes is insignificant in a grouping of adjacent ones. In order to obtain the minimized function, adjacent ones on a K-map are identified by covering each one on the map at least once in a row or a column grouping, observing that in each case one variable is insignificant with respect to the value of X, the output. That variable is eliminated and the process is continued until all the groupings are evaluated. Finally, the reduced set of product terms is combined with an OR function to give the minimized function.

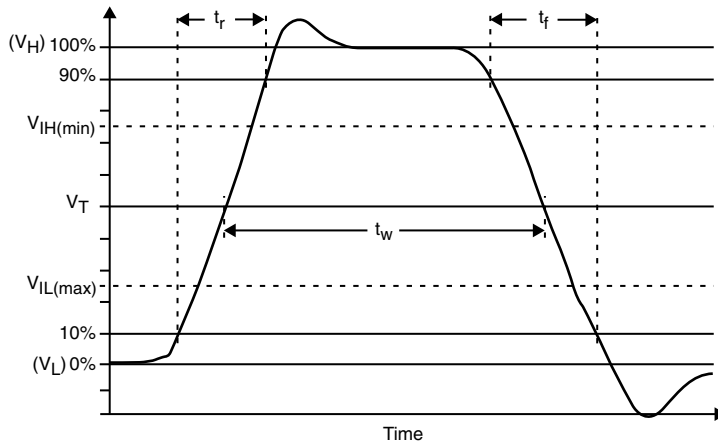

FIGURE 40.17 A real pulse and definition of characteristic parameters [2].

Figure 40.16 shows three sets of adjacent ones in rows and columns identified by circles around them and the following observations can be made:

- Group 1. Only variable B changes states. Hence, it can be eliminated and the minimized form for the grouping is $A'C'$.
- Group 2. Only variable A changes states. Hence, it can be eliminated and the minimized form of the grouping is BC' .
- Group 3. Only variable C changes states. Hence, it can be eliminated and the minimized form of the grouping is $A'B$.

Hence, the minimized form for the logic function is

$$X = A'C' + BC' + A'B$$

This can be implemented with one 2-input AND gate IC and one 3-input OR gate. A K-map is helpful in minimizing up to six variables.

Dynamic Characteristics

Having studied the logic function and obtaining a minimum, we can build the logic circuit. However, in order to ensure that the circuit will work as intended over the entire operating range, dynamic characteristics of logic circuits must be considered. It was stated earlier that the input signal can change rapidly in a system and the logic circuit should perform as intended at frequencies at which the system is expected to operate.

The correct functioning of the logic circuit when the inputs are changing rapidly is an important consideration in design. In our discussion thus far, we have assumed that the logic signal is an ideal square wave and that the logic gates function without any delay. Let us examine the effects of relaxing these two assumptions to obtain some insight into the dynamic behavior of logic circuits.

A real pulse is shown in Fig. 40.17 [2]. The rise time is denoted by t_r and fall time by t_f . The pulse further shows a settling time, overshoot, and undershoot when changing states. The signal amplitude is specified as the difference between the two stable signal levels for high (V_H) and low (V_L), i.e., from 100% to 0%, and t_w is the pulse width of the signal measured at 50% of the amplitude. t_{THL} , t_{TLH} are the transition times for the output signal to go from high to low and low to high, respectively. t_{pHL} and t_{pLH} are propagation delay times for high to low and low to high transitions, respectively. For medium speed operation, t_{pHL} and t_{pLH} are typically about 30 ns.

When an input to a logic gate changes states, the output lags behind by a characteristic time delay called the propagation delay, measured by the time difference between the input at 50% of the amplitude and the output at 50% of the amplitude. A simplified model of a real pulse for an inverter is shown in Fig. 40.18

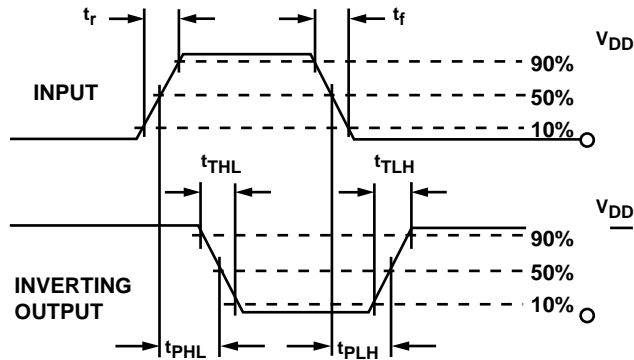

FIGURE 40.18 Propagation delay definition.

[3]. Values for the propagation, typically expressed in nanoseconds, are available in the datasheet for a device.

For a logic circuit, a propagation delay analysis is carried out by mapping out the total delay from input to output as the inputs change states, and identifying any static problems (frequency independent) and dynamic problems. Additional gates may be added to the circuit of the problem.

Other Design Considerations

The number of logic gates that a given gate can drive is called *fan-out* and the number of gates that can be connected to the input of a given gate is called *fan-in*. These data are given in the data sheet and should be adhered to. Further, minimizing the number of ICs needed in a logic circuit is an important consideration that might require modifying the design to use the same kind of gate although more numbers may be used than the minimum circuit identified with K-map analysis. Use of the same type of gates for compatibility between ICs is another design consideration in logic circuits.

40.5 Logic Gate Technologies

The first of the logic families that became commercially available was the resistor–transistor logic (RTL), where the transistor is used as a high-speed switch in circuits. Diode–transistor logic (DTL) and transistor–transistor logic (TTL) followed in the evolution. While the RTL and the DTL are obsolete, the TTL gates are still widely used. There are several variations of TTL logic, namely, the high-speed (H), low-power (L), Shottkey (S), and low-power Shottkey (LS). CMOS logic gates are an entirely different implementation of logic gates based on the complimentary metal-oxide semiconductor devices (CMOS) technology. These devices have low-power requirements and improved noise characteristics. These devices are extremely static sensitive and are easily damaged. A mixture of CMOS and bipolar processes resulted in the BiCMOS technology, using internal CMOS components and high-power bipolar outputs. Several different families evolved from the original BiCMOS processes [1].

Resistor–Transistor Logic (RTL)

Figure 40.19(a) shows an RTL inverter and Fig. 40.19(b) shows a NAND gate. The transistor is assumed to operate in the saturation mode. Because of the nature of a transistor, there is a minimum voltage drop across the collector–emitter junction at saturation and there is a minimum current required in the base–emitter loop to saturate the transistor. In Fig. 40.19(a), the output voltage is between 0.3 and 5.0 V. The NAND gate shown has an output of 0.6 V for logic LOW as the collector–emitter drop for the two transistors in series has to be added up. If we add an additional transistor to add an input, we have additional power dissipation and the output voltage is at 0.9 V for a logic LOW causing problems with

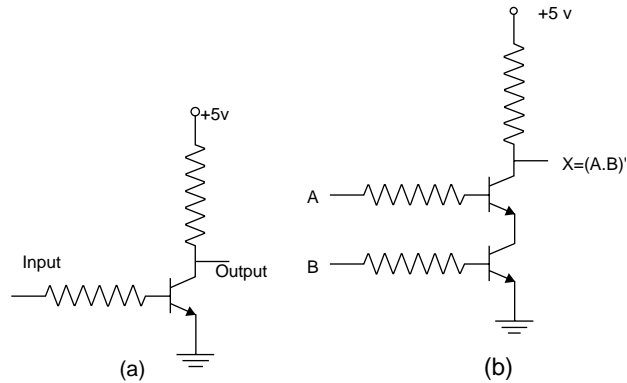

FIGURE 40.19 (a) Resistor–transistor NOT gate, (b) resistor–transistor NAND gate.

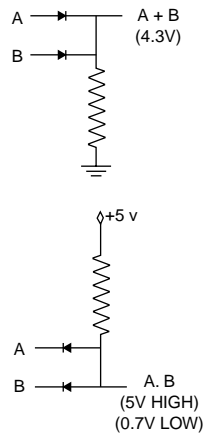

FIGURE 40.20 Diode–resistor logic.

the logic devices that it is driving. The logic function operation becomes unreliable as output can get into the forbidden region. Further, the presence of resistors in the base–emitter loop tends to slow the device. Because of these limiting characteristics, RTL gates are obsolete.

Diode–Transistor Logic (DTL)

Diodes themselves can be used to build logic gates for simple applications as shown in Fig. 40.20. The diode drops the voltage by 0.7 V across the pn-junction when conducting, resulting in 0.7 V for a LOW and 4.3 V for a HIGH at the output. It is readily seen that the cascading of several of these circuits will push the circuit into the forbidden region, resulting in erroneous logic. Moreover, the diode resistor logic cannot implement an inverter (NOT) function, and it is not practical to produce high density ICs with diodes and resistors. Because of these shortcomings, the diode-resistor logic gate is obsolete.

A DTL gate is shown in Fig. 40.21. Here, the diodes are used for the OR function and the transistor is used for the NOT function to give a NOR gate. Still the presence of the resistor at the base of the transistor causes power dissipation and reduces the speed of operation. Figure 40.22 shows an improved diode–transistor design that eliminates the bias resistor, thereby improving the speed of operation. DTL devices are obsolete owing to the same limitations discussed earlier.

Transistor–Transistor Logic (TTL)

In Fig. 40.22, it can be observed that the diodes at the input are forward biased while the diode at the base of the transistor is reverse biased when any input is LOW. On the other hand, when all inputs are HIGH, the base diode is forward biased and the transistor conducts, giving the NAND function.

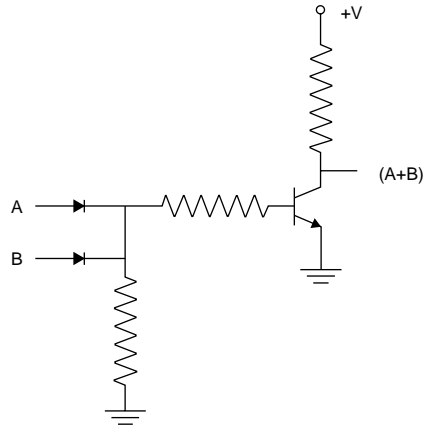

FIGURE 40.21 Diode–transistor logic NOR gate.

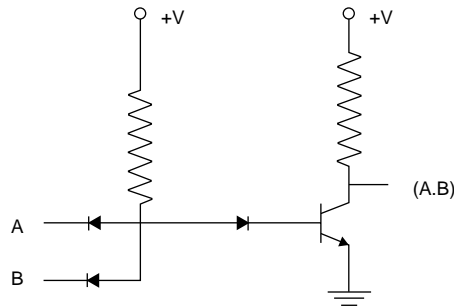

FIGURE 40.22 Improved diode–transistor NAND logic gate.

In a transistor npn, for example, the base–emitter is forward biased during conduction and collector–base is reverse biased. If we have a transistor with multiple emitter leads, then we can use the emitter–base junction for the input diodes. The base–collector junction is used for the base–diode in the DTL gate. The result is a TTL gate implementation of a NAND function in Fig. 40.23 [4].

Here, when any of the inputs is LOW, the base–emitter loop conducts and the emitter of the first stage transistor is at 0.2 V, giving HIGH for output at the inverter. When all the inputs are HIGH, the transistor multiple emitters (first stage) is cutoff. Therefore, all other transistors conduct with a logic LOW at output. The manufacturer’s data sheet for each device provides circuit diagrams, and all technical data including maximum and minimum input values, propagation delay, rise and fall times, fan-out, fan-in limitations, power consumption, and application suggestions. These are excellent sources of information for the designer.

Emitter-Coupled Logic (ECL)

Emitter-coupled logic (ECL) devices are bipolar devices in which the transistor is never saturated or completely shut off. The result is very high speed compared to TTL or CMOS implementations. The ECL gates are used in several applications where high speed is essential, for example, computer cache memory. Figure 40.24 shows a NOR/OR gate [5]. V_{CC} is connected to ground (0 V) while V_{EE} is connected to supply voltage, -5.2 V for better noise immunity. The transition time from one state to another is less than 1 ns, resulting in several gigahertz operating frequency when ECL gates are used.

Because the transistors are not fully saturated, the ECL gates output at HIGH and LOW are about -0.75 and -1.6 V, respectively. The bias voltage is set at the base of transistor Q_4 , the value is the average

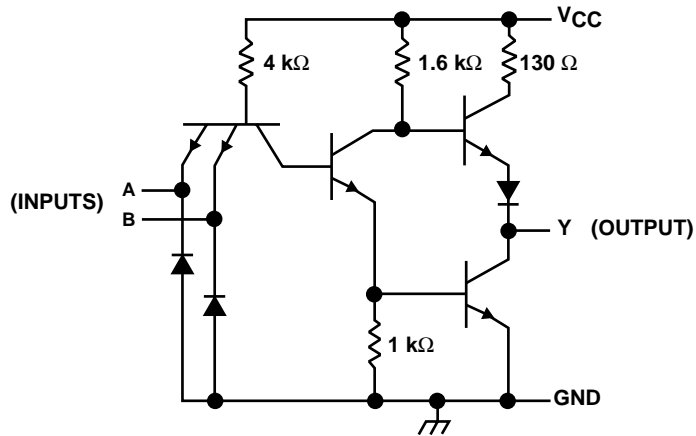

FIGURE 40.23 Transistor–transistor logic implementation of a NAND gate [4].

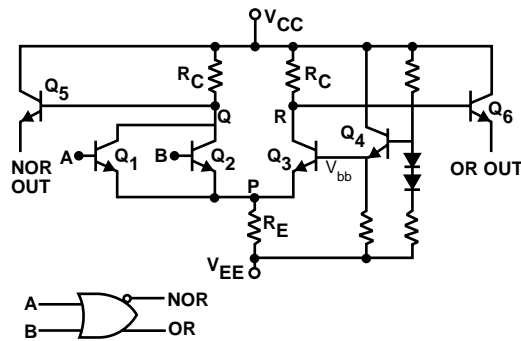

FIGURE 40.24 Emitter-coupled logic NOR/OR gate [5].

of HIGH and LOW values for the gate; in this case, the value would be -1.175 V. Next, the resistors are selected to control the current flow and prevent transistor saturation. When the signal at A or B is HIGH (-0.75 V), the transistors conduct. The voltage at point P becomes -1.5 V (V_{BE} of $Q_2 + V_A$). This reduces the difference between V_{bb} and the voltage at point P below the threshold for transistor Q_3 to conduct and hence it is off, raising the voltage at point R to 0 V. This turns transistor Q_6 on. With a V_{BE} threshold of 0.75 V, the measured OR output is -0.75 V, a logic HIGH. The value of resistance R_C and R_E are chosen so that the voltage at point Q is -0.85 V when transistor Q_1 or Q_2 is conducting. It is true when B is HIGH and A is LOW or when A and B are both HIGH. When both A and B are LOW, the transistors Q_1 and Q_2 are off and Q_3 conducts lowering the voltage at point P to -1.925 V. Voltage at point R is -0.85 V resulting in an OR output of -1.6 V at the OR output and -0.75 V at the NOR output.

Because of the constant operation of the transistors in the active region, there is continuous current draw and hence heat dissipation. The ECL devices draw four to five times the power of a comparable TTL device. Hence, this is used cautiously as front-end devices where speed is essential, while using HCMOS or TTL gates elsewhere. In order to mix ECL gates with TTL or CMOS devices, special level shifters are used, for example, National Semiconductor's 100325 Low Power ECL-to-TTL Translator. This device converts an ECL input (-0.75 (H) and -1.6 (L)) to a TTL output (2.4 V min. for HIGH and 0.5 V max. for LOW), while maintaining a rise or fall time of less than 1 ns.

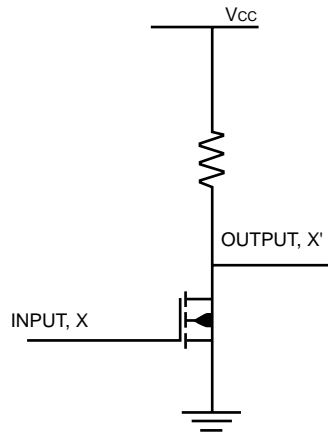

FIGURE 40.25 An NMOS inverter.

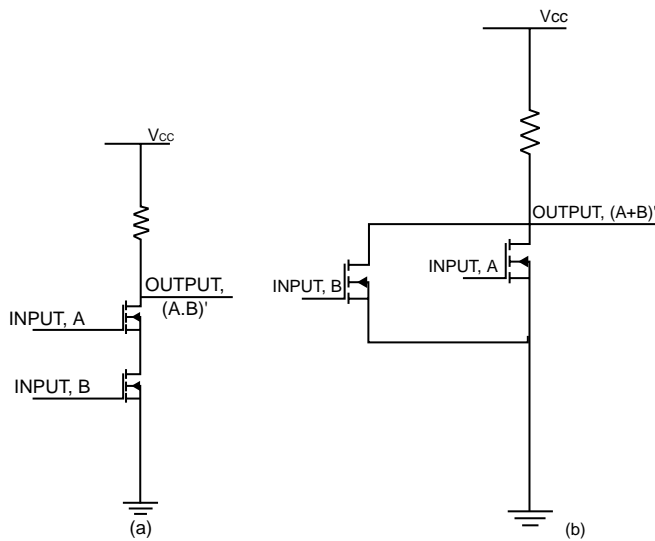

FIGURE 40.26 (a) An NMOS NAND gate, (b) an NMOS NOR gate.

CMOS Logic

As discussed earlier, MOSFET can be used as a transistor switch without significant power dissipation. NMOS logic gates are designed with n-MOSFETs and PMOS logic gates are designed with p-MOSFET transistors. As an example, an NMOS inverter is shown in Fig. 40.25. Figure 40.26(a) shows a logic NAND function when two n-MOSFETs are connected in series and Fig. 40.26(b) shows a parallel arrangement of two n-MOSFETs to give a NOR gate. The NMOS circuits shown have a pull-up resistor and a pull-down n-MOSFET. To eliminate the resistor, the pull-up side of the circuit is replaced with p-MOSFET. The modified NOT or inverter circuit is shown in a commercial implementation in Fig. 40.27 [3]. Additional diodes are shown for static protection of the device. This is known as a CMOS circuit since the pull-down and pull-up parts of the circuit have complimentary MOSFET devices. When two n-MOSFETs are connected in the pull-down side of the circuit in series, the pull-up resistor is replaced by two p-MOSFETs in parallel, and vice versa. A CMOS implementation of the NOR gate is shown in Fig. 40.28.

An important characteristic of CMOS gates is their low-power consumption as there is practically no current flow in both HIGH and LOW states. However, the device is slower than a bipolar transistor device.

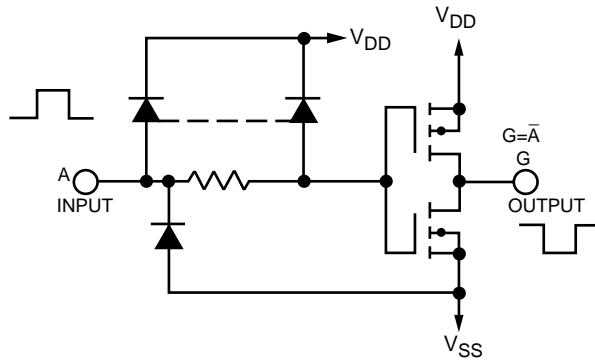

FIGURE 40.27 A CMOS inverter [3].

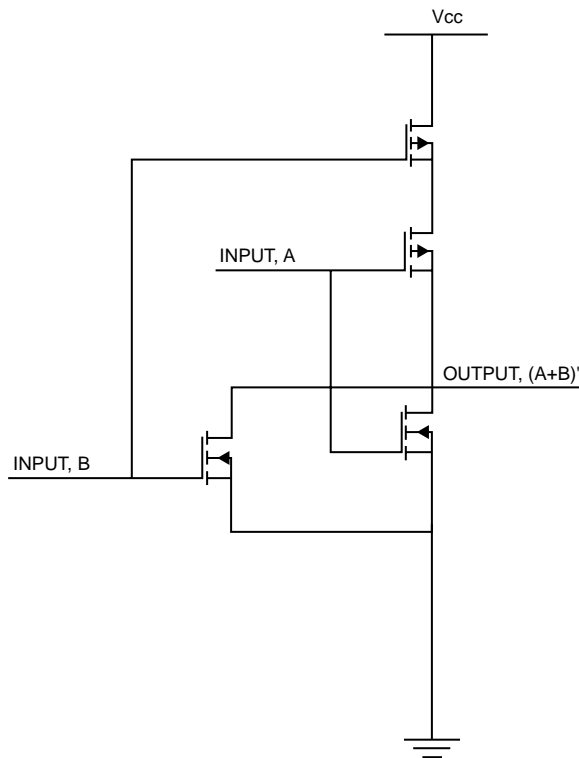

FIGURE 40.28 A CMOS NOR gate.

With decreasing transistor sizes due to advancements in fabrication technologies, the speed of CMOS devices continue to increase.

40.6 Logic Gate Integrated Circuits

A commercial logic gate ICs has several gates of the same type on it. For example, Fig. 40.29 shows a commercial quad-AND gate IC. The chip itself is powered with V_{cc} and GND pins, A and B pins are inputs, and the Y pins are the corresponding outputs. You can use one or all of the gates on a chip as needed.

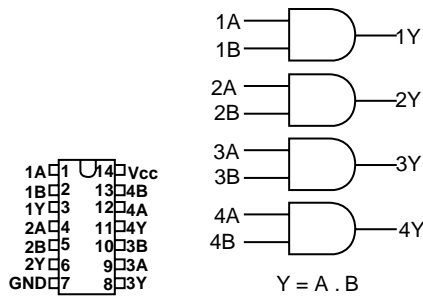

FIGURE 40.29 A DIP package of quad-AND gate IC.

The designation of the chips requires some attention. Let us take the Texas Instruments designations for an AND gate, namely, SN5408, SN54LS08, SN54S08, SN7408, SN74LS08, and SN74S08. While the designation shown on a device has much more information than what is shown here, the basic information that we should be aware of is the function designation (00 = NAND gate, 02 = NOR, 04 = Inverter, 08 = AND, etc.), and technology type (HC for high-speed CMOS, LS for low-power Schottky, etc.). For other notations used in chip designations, refer to the Texas Instruments Logic Selection Guide [1].

40.7 Programmable Logic Devices (PLD)

Programmable logic devices (PLDs) are ICs with several uncommitted logic gates in them, the connections among which are programmable based on the logic circuit design that needs to be implemented. This is especially helpful when very large circuits consisting of several thousands of logic gates have to be built and tested. For large circuit design and testing, it is not practical to use standard logic gate ICs since each IC has at most four or six logic gates on it, requiring large circuit boards and interconnects. The PLD consists of several hundred logic gates on it and the device design is programmable with a special programming hardware. When more than one PLD is used to implement a design, programmable interconnects are used between PLDs. One type of fully PLD, called the programmable logic array (PLA), consists of an AND level in the middle and an OR level at output, similar to a TTL single logic gate structure, with both layers being programmable. All input signals are connected to an inverter level, which provides both the normal and complemented values of input variables to the AND level. Appropriate connections are made at the AND level and at the OR level to produce the desired logic outputs. In this device all the levels are programmable.

A simpler version of PLD, called a programmable array logic (PAL) device, consists of a programmable AND layer and a fixed OR layer. This is easier and less expensive to manufacture, although it is not as flexible as a PLA. A variety of combinations is available to suit various needs. A schematic of a PLA is shown in Fig. 40.30 [6] where the connections to be made in the hardware are marked with an X. When programmed these connections will be made or “fused” and verified by the programming hardware.

40.8 Mechatronics Application Example

A driver circuit for a DC motor is a good example for the use of transistors and logic gates. The objectives of the design are the following:

1. The motor should drive forward and reverse at different speeds.
2. The motor should either coast to a stop or brake abruptly.
3. The motor should drive at different speeds, controllable by a microprocessor.

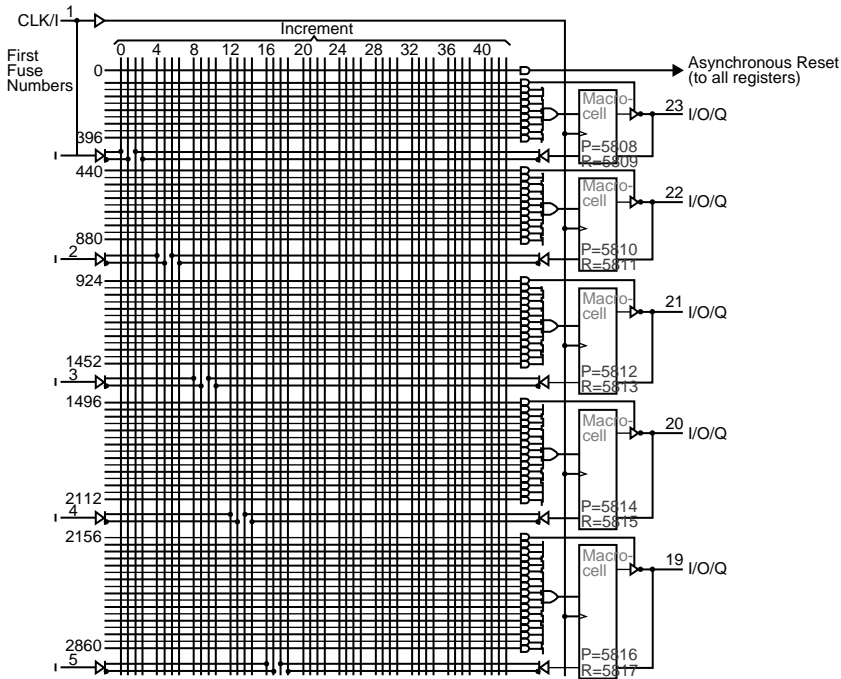
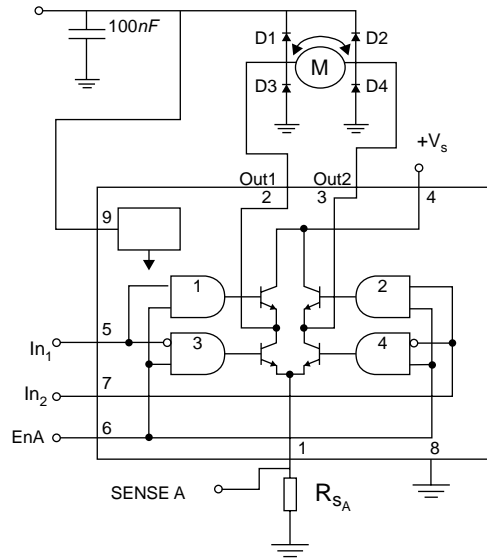

FIGURE 40.30 Programmable logic array (PLA) [6].

The complete logic and power circuit implementation of the solution to this design problem is shown in Fig. 40.31, which is known as the H-bridge. The motor is connected between the output pins (out1 and out2) [7]. The EN (enable) and IN1 (input 1) and IN2 (input 2) are the inputs. The behavior of the system is given by the adjacent table in Fig. 40.31. When the enable signal is LOW, regardless of the input states, all the AND gates are LOW, and the power transistors are all off and the motor is off. If the motor is moving when the enable line switches to LOW, the motor coasts to a stop. When the enable input is HIGH, it can be seen that when IN1 is high and IN2 is LOW, transistors 1 and 4 are on, and 2 and 3 are off. This drives the motor one way as the current can flow through the motor to the ground through the two diagonal transistors. Since transistors 2 and 3 are off, short circuit from power to ground is prevented. This is designed by inputting the complements of IN1 and IN2 to the AND gates driving transistors 3 and 4, respectively. When IN2 is HIGH and IN1 is LOW, the motor runs in the opposite direction (while the enable is HIGH). Since transistors 2 and 4 are closed and 1 and 3 are open, current flows in the opposite direction through the motor.

When enable is HIGH, and the inputs IN1 and IN2 are either turned HIGH or LOW at the same time while the motor is moving, then the motor terminals are forced to V_{cc} or ground. However, the motor power is off since IN1 and IN2 are LOW. Now, the motor is a generator trying to maintain a potential difference across its terminal as the rotor moves in a magnetic field. The emf generated is forced to the source or sink potential. This brings the motor to a rapid stop, identified as the fast stop or the braking function. Further, the IN1 and IN2 lines can be used for direction and braking functions, while the enable can be pulsed at different duty cycle levels (pulse width modulation) to achieve different speeds. Since the motor is free running when enable is LOW regardless of input, as EN is switched rapidly, the inertia of the rotor helps smooth out the motion. The selection of pulse repetition time (PRT) and arrangement of pulses within the PRT in a uniform fashion to produce desired PWM signals should be done to fine-tune the performance of this system.



| INPUTS | | FUNCTION |
|--------|---------------------------------------|-------------------------|
| ENA=H | In ₁ =H In ₂ =L | FORWARD |
| | In ₁ =L In ₂ =H | REVERSE |
| | In ₁ =In ₂ | FAST MOTOR STOP |
| ENA=L | In ₁ =X In ₂ =X | FREE RUNNING MOTOR STOP |

FIGURE 40.31 H-bridge motor driver circuit [7].

References

1. “Logic Selection Guide, First Half 2001,” Texas Instruments, Document sdyu001o.pdf. Source: www.ti.com.
2. “Designing with Logic,” Texas Instruments, Document sdyu009C.pdf. Source: www.ti.com
3. “CD4069UB Types- Quad-Inverter,” Texas Instruments, Datasheet, schs054.pdf, 1998. Source: www.ti.com.
4. “SN5400 Quadruple 2-Input Positive NAND-Gates,” Texas Instruments, Datasheet, sdls025.pdf, March 1988, Source: www.ti.com.
5. Koga, R., Crain, W.R., Hansel, S.J., Crawford, K.B., Pinkerton, S.D., Peozin, S.H., Moses, S.C., and Maher, M., “Ion Induced Charge Collection and SEU Sensitivity of Emitter Coupled Logic (ECL) Devices,” *IEEE Trans on Nuclear Science*, 42(6), 1823–1828, 1995.
6. High-performance *Impact-X™* Programmable Array Logic Circuits, TIBPAL22V10-7C, TI, 1995. Product datasheet.
7. “Dual Full-Bridge Driver L298,” SGS Thomson Microelectronics Datasheet. Source: www.st.com.

41

Synchronous and Asynchronous Sequential Systems

- 41.1 Overview and Definitions
Synchronous Sequential Systems • Flip-Flops and Latches • Mealy and Moore Models • Pulsed and Level Type Inputs • State Diagrams
- 41.2 Synchronous Sequential System Synthesis
Design Steps
- 41.3 Asynchronous Sequential System Synthesis
Design Steps
- 41.4 Design of Controllers' Circuits and Datapaths
- 41.5 Concluding Remarks

Sami A. Al-Arian
University of South Florida

41.1 Overview and Definitions

Traditionally, digital systems have been classified into two general classes of circuits: *combinational* and *sequential* systems. Combinational systems are logic circuits in which outputs are determined by the present values of inputs. On the other hand, sequential systems represent the class of circuits in which the outputs depend not only on the present value of the inputs, but also on the past behavior of the circuit. In most systems a clock signal is used to control the operation of a sequential logic. Such a system is called a *synchronous* sequential circuit. When no clock signal is used, the system is referred to as *asynchronous*.

Synchronous Sequential Systems

Figure 41.1 shows the general structure of a synchronous sequential system. The circuit has a set of primary inputs \underline{X} and produces a set of primary outputs \underline{Z} . In addition, it has sets of secondary inputs and outputs, \underline{Q}^+ and \underline{Q} , respectively. These sets of signals are inputs and outputs to state (or memory) elements or devices called *flip-flops* (FFs) or *latches*. The outputs of these devices constitute the present states \underline{Q} , while the inputs constitute the next states or \underline{Q}^+ . There are several types of such devices, as well as many variations of these types, namely, set-reset (SR), delay (D), trigger (T), and JK (a combination of SR and T) FFs and latches. Table 41.1 shows the behavior of each of these types.

Flip-Flops and Latches

The outputs of the FFs or latches, which are sequential devices, are determined by the present values of their inputs as well as the values of their present states. However, FFs are edge-triggered devices, meaning that state transitions might take place only during one clock cycle. This clock transition is either positive edge

TABLE 41.1 FF Behavior for SR, D, T, and JK Types

| FF Inputs | | | | SR | | D | | T | | JK | |
|-----------|---|---|----|-------------|----|---|----|---|----|----|----|
| SR | D | T | JK | Q | Q+ | Q | Q+ | Q | Q+ | Q | Q+ |
| 00 | 0 | 0 | 00 | 0 | 0 | 0 | 0 | 0 | 0 | 0 | 0 |
| 00 | 0 | 0 | 00 | 1 | 1 | 1 | 0 | 1 | 1 | 1 | 1 |
| 01 | 1 | 1 | 01 | 0 | 0 | 0 | 1 | 0 | 1 | 0 | 0 |
| 01 | 1 | 1 | 01 | 1 | 0 | 1 | 1 | 0 | 0 | 1 | 0 |
| 10 | | | 10 | 0 | 1 | | | | | 0 | 1 |
| 10 | | | 10 | 0 | 1 | | | | | 1 | 1 |
| 11 | | | 11 | | | | | | | 0 | 1 |
| 11 | | | 11 | Not allowed | | | | | | 1 | 0 |

Note: Q is present state, Q+ is next state.

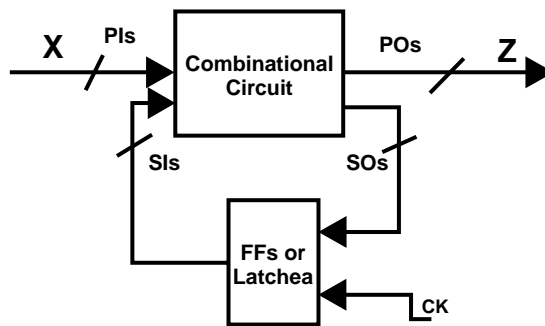

FIGURE 41.1 General model for sequential circuits.

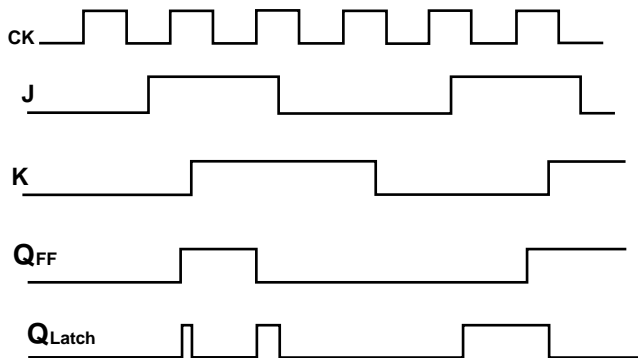

FIGURE 41.2 Timing diagram of JK FF and JK latch (note the transparent property in the latch).

(L to H transition) or negative edge (H to L transition). (The clock signal that causes the change in the state is usually referred to as the active clock edge.) On the other hand, a latch is a sequential device that might change the internal state of the device as long as the clock signal (or controlled input) is active (either active high or low). This property associated with latches is called the *transparent property*. [Figure 41.2](#) shows an example of a timing diagram of a JK FF and JK latch.

Mealy and Moore Models

Sequential circuits are also referred to as *finite state machines* (FSMs), which means that such circuits have a finite number of states to represent their behavior. Furthermore, FSMs are classified into two models: *Mealy* and *Moore*. Mealy circuits represent the class of circuits whose outputs (Z_m) depend on

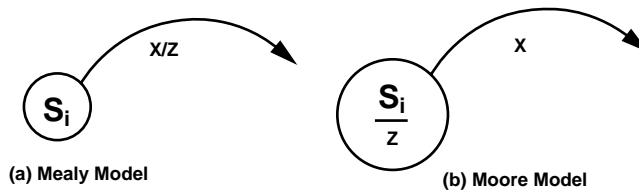

FIGURE 41.3 State diagrams for an FSM.

the present states (\underline{Q}) and the primary inputs (\underline{X}). On the other hand, Moore circuits represent the class of circuits whose outputs (\underline{Z}_M) depend only on the present states (\underline{Q}). An FSM could, of course, have both types in the same system.

Pulsed and Level Type Inputs

The inputs to any sequential system could be of two types: *pulsed* or *level*. A pulsed input (whether active low or high) is an input that makes a transition (L to H or H to L), and then returns back to its inactive state. A level input is an input that makes a single transition (L to H or H to L) and stays in that state until the input changes its value. The number of finite states that the system may have would most definitely depend on the type of inputs the system has, whether pulsed or level. Hence, there are four major types of sequential circuits:

1. *Pulsed synchronous*. Sequential systems that have pulsed input signals and clocked state elements.
2. *Level synchronous*. Sequential systems that have level input signals and clocked state elements.
3. *Pulsed asynchronous*. Sequential systems that have pulsed input signals and unclocked state elements.
4. *Level asynchronous*. Sequential systems that have level input signals and unclocked state elements.

State Diagrams

A *state diagram* is a tool used in sequential circuit synthesis. It represents the graphical representation of state transitions of the FSM. Each state is represented by a circle. If the machine is of Moore type, the output value is associated with the present state. However, if the machine is Mealy, then the output is associated with the present state and the input. Both types are illustrated in Fig. 41.3. The inputs are represented by arrows going from one state to another. For n inputs, the number of arrows going out of each state is 2^n for level type inputs, and n for pulsed type inputs. For example, if a sequential system has two level inputs X_1 X_2 , there would be four arrows coming out of each state representing 00, 01, 10, and 11 inputs. On the other hand, in a pulsed input system, such as in a vending machine design where the inputs are quarters (Q), dimes (D), and nickels (N), the number of arrows coming out of each state is 3 representing Q, D, and N inputs.

41.2 Synchronous Sequential System Synthesis

Let us design a synchronous sequential system that would meet the following requirements:

1. The circuit has four pulsed inputs X_1 , X_2 , X_3 , and X_4 , and one level output Z .
2. All changes in the circuit occur on the positive edge of the clock.
3. A level output ($Z = 1$) is to occur if the following sequence takes place: X_2 X_4 X_3 X_1 .
4. If two consecutive pulses of the same input pulse occur, the circuit would return back to the initial state.

Design Steps

There are six simple design steps as follows:

1. Given the above system specifications, the first step is to create the *state diagram* (SD). Figure 41.4 shows the state diagram for this problem. Note that there are five states (S_0 – S_4). Each state has four arrows representing the n pulsed inputs (X_1 – X_4). In addition, S_0 represents the initial state. Also note that new states are created as needed according to the system's specifications. It is not necessary to have the optimum number of states at this stage.
2. The next step is to translate the state diagram into a *state table* (ST), as shown in Table 41.2. Note that this step is a one-to-one mapping.
3. The next step is to minimize the number of states by creating the *reduced state table* (RST). There are several techniques that could be employed in this step, including inspection, partitioning, and the implication table. Two states are considered equivalent (and therefore could be merged) if (1) they go to the same next states under all inputs, and (2) they have the same outputs under all inputs. Once redundant or equivalent states are determined in this step, one can use the merger diagram in merging all redundant states where each state in the set is also equivalent to all other states in the same set of states. In this example, state S_4 is shown to be equivalent to state S_0 , as shown in the implication table in Fig. 41.5. Note that a check mark is put in the S_0 – S_4 box since both states have the same next states, as well as the same outputs under all the inputs. (Figure 41.6 shows an example of a merger diagram where several states were found to be equivalent because each was equal to all the others.)
4. The next step is *state assignment* (SA). State assignment is an important step because different assignments may yield different implementations and hence different costs. The number of distinct assignments (N_D) is equal to the following:

$$N_D = \frac{(2^{N_{FF}} - 1)!}{(2^{N_{FF}} - N_S)! N_{FF}!}$$

TABLE 41.2 State Table for Synchronous Sequential Design Example

| Present State | Next State/Output | | | |
|---------------|-------------------|---------|---------|---------|
| | X_1 | X_2 | X_3 | X_4 |
| S_0 | $S_0/0$ | $S_1/0$ | $S_0/0$ | $S_0/0$ |
| S_1 | $S_2/0$ | $S_0/0$ | $S_0/0$ | $S_0/0$ |
| S_2 | $S_0/0$ | $S_1/0$ | $S_0/0$ | $S_3/0$ |
| S_3 | $S_0/0$ | $S_1/0$ | $S_4/1$ | $S_0/0$ |
| S_4 | $S_0/0$ | $S_1/0$ | $S_0/0$ | $S_0/0$ |

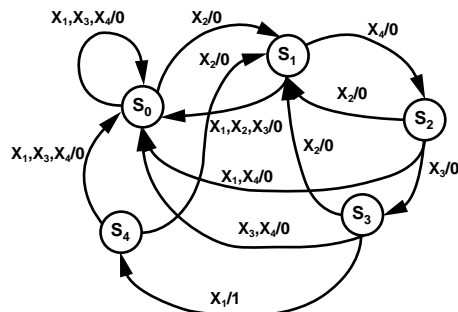

FIGURE 41.4 State diagram for synchronous sequential example.

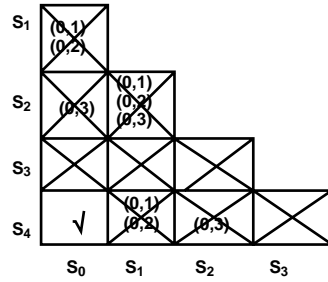

FIGURE 41.5 Implication table for synchronous example.

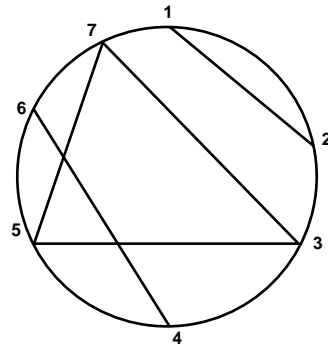

FIGURE 41.6 Merger diagram example: equivalent states (1, 2), (3, 5, 7), and (4, 6), seven states collapse to three distinct states.

where N_s represents the number of states in the RST, and N_{FF} represents the number of flip-flops. Note also that $2^{N_{FF}-1} < N_s < 2^{N_{FF}}$. Hence, the number of distinct assignments with only nine states and four flip-flops is over 10 million! Therefore, state assignments must adhere to some guidelines that would yield minimum implementations to optimize cost and reliability. The following is the set of three guidelines, which are listed according to their priority. The weight of each guideline could be set at 5 for guideline A, 3 for guideline B, and 1 for guideline C.

- Guideline A.* Present states that have the same next states under a given input, must be given adjacent assignments.
- Guideline B.* States that are next states for a present state under different inputs, must be given adjacent assignments
- Guideline C.* Present states that have the same outputs under all inputs must be given adjacent assignments.

The objective of these guidelines is to satisfy as much of these adjacencies as possible according to the weights given above. In the example given here, the following set of adjacencies is obtained from guidelines A and B (here guideline C is ignored).

Guideline A: $(S_0, S_1) \times 2$ (meaning two times), $(S_0, S_2) \times 3$, (S_1, S_2) , $(S_0, S_3) \times 3$, $(S_2, S_3) \times 2$, (S_1, S_3) . Guideline B: $(S_0, S_1) \times 3$, (S_0, S_2) , (S_0, S_3) , (S_1, S_3) .

Hence, the total weight for the following adjacencies is (S_0, S_1) : 19, (S_0, S_2) : 18, (S_0, S_3) : 18, (S_1, S_2) : 5, (S_2, S_3) : 10, (S_1, S_3) : 8. Therefore, the following assignments are given: $S_0 = 00$, $S_1 = 01$, $S_2 = 10$, and $S_3 = 11$, where the following adjacencies are satisfied: (S_0, S_1) , (S_0, S_2) , (S_1, S_3) , and (S_2, S_3) . Although this state assignment is not unique, it clearly yields efficient implementation.

5. In this step the FF type is chosen, and the next state as well as the output equations are derived. The next state equations are derived either through the characteristic equations, or through deriving the state transition table, where each FF input is determined for each state transition from present state to next state. The characteristic equations for the FFs are given in Fig. 41.7,

TABLE 41.3 FF Input Values for State Transitions

| Q | Q+ | S | R | D | T | J | K |
|---|----|---|---|---|---|---|---|
| 0 | 0 | 0 | d | 0 | 0 | 0 | d |
| 0 | 1 | 1 | 0 | 1 | 1 | 1 | d |
| 1 | 0 | 0 | 1 | 0 | 1 | d | 1 |
| 1 | 1 | d | 0 | 1 | 0 | d | 0 |

Note: Q is present state, Q+ is next state.

$$Q_{SR}^+ = S + R'Q \quad Q_D^+ = D$$

$$Q_T^+ = TQ' + T'Q \quad Q_{JK}^+ = JQ' + K'Q$$

FIGURE 41.7 FFs characteristic equations.

$$Q_2^+ = Q_2 Q_1' X_3 + Q_2' Q_1 X_4$$

$$Q_1^+ = Q_1 X_2 + Q_2' X_2 + Q_2 Q_1' X_3$$

$$Z = Q_2 Q_1 X_1$$

$$J_2 = Q_1 X_4 \quad K_2 = X_1 + X_2 + Q_1 X_3 + X_4$$

$$J_1 = X_2 + Q_2 X_3 \quad K_1 = X_1 + Q_2' X_2 + X_3 + X_4$$

FIGURE 41.8 Next states (Q_2^+ , Q_1^+), output (Z), and JK FF inputs equations.

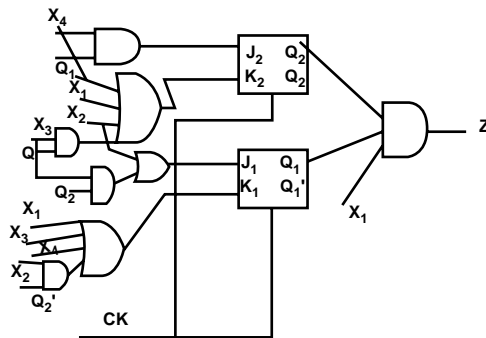

FIGURE 41.9 Implementation of synchronous design example.

while the state transition table for each type is given in Table 41.3. The next state and output equations for this example using JK FFs are shown in Fig. 41.8.

- The next step is implementation or realization. Figure 41.9 shows the implementation of this design using JK FFs.

Note that each term in the next state equation is obtained for each pulsed input using separate K-maps. If the inputs were of level type, the K-map for each FF input would then include all the primary inputs.

41.3 Asynchronous Sequential System Synthesis

Synchronous sequential circuits operate with clocks that control the total operation of the system. Such synchronous sequential circuits are called to operate in a *pulse mode* behavior. On the other hand, in an asynchronous sequential system, changes in the state of the system are not triggered by clock pulses. Instead, changes in the state of the system depend on changes in the primary inputs. However, since a good and reliable design requires the primary inputs to the circuit to change only one at a time, then such changes must allow enough time to elapse in order to reach a *stable state*. A stable state is achieved when all internal elements no longer change their values. A circuit that adheres to this behavior is called a *fundamental mode* circuit.

A main advantage of asynchronous circuits is their speed of operation. Since there is no clock (which must be at least as long as the slowest path in the circuit), the speed would be equal to the propagation path delay in the local portion of the circuit. Hence, the performance of the overall system could be enhanced. However, the major disadvantages of the asynchronous system are races and hazards, both static and dynamic. These race conditions and hazards make asynchronous circuits more difficult to deal with, and hence, they must be designed with care.

An asynchronous sequential synthesis is illustrated through the following example. Let us design a fundamental mode circuit that has two inputs (X_1, X_2) and one output Z . The output Z would change its value from 0 to 1 when X_2 changes its value from 1 to 0, while $X_1 = 1$. Likewise, the output Z would change its value from 1 to 0 when X_1 changes its value from 0 to 1, while $X_2 = 1$. Note that only one input at a time may change its value. Also note that a steady-state output occurs only when the state is stable. Otherwise, the output is a “don’t care” (illustrated in the flow table as –).

Design Steps

Similar to the synchronous system design, there are also six steps in designing this asynchronous system.

1. The first step is to create the initial *state diagram* (SD) and the *primitive flow table* (PFT) for the asynchronous system. Figure 41.10 and Table 41.4 show the SD and PFT for this example, respectively. Note that stable states are circled. In addition, the PFT may have only one stable state per row. Also note the new terminology for the asynchronous circuit. What was called a state table in a synchronous system is referred to as a flow table in an asynchronous system. Since only one input is allowed to change at a time, the entry to multiple input changes is “don’t care” or –/–. In this example, the PFT has six stable states 1–6.
2. The next step is to use the implication table for the PFT, as shown in Fig. 41.11. The implication table shows that (1, 2), (1, 3), (3, 5), and (4, 6) are compatible rows. That means that under each

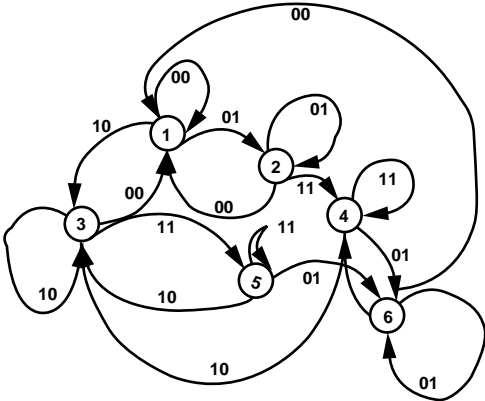

FIGURE 41.10 Primitive flow table for an asynchronous design example.

TABLE 41.4 Primitive Flow Table (PFT) for Asynchronous Design Example

| Previous Input | Present State | Next State / Output | | | |
|----------------|---------------|---------------------|---------|---------|---------|
| | | $X_2 X_1$ 00 | 01 | 11 | 10 |
| 00 | (1) | (1) / 0 | 2 / - | - / - | 3 / - |
| 01 | (2) | 1 / - | (2) / 0 | 4 / - | - / - |
| 10 | (3) | 1 / - | - / - | 5 / - | (3) / 0 |
| 11 | (4) | - / - | 6 / - | (4) / 0 | 3 / - |
| 11 | (5) | - / - | 6 / - | (5) / 1 | 3 / - |
| 01 | (6) | 1 / - | (6) / 1 | 4 / - | - / - |

TABLE 41.5 Reduced Flow Table (RFT) for Asynchronous Design Example

| Present State | Next State / Output | | | |
|---------------|---------------------|---------|---------|---------|
| | $X_2 X_1$ 00 | 01 | 11 | 10 |
| (A) | (A) / 0 | (A) / 0 | C / - | B / - |
| (B) | A / - | C / - | (B) / 1 | (B) / 0 |
| (C) | A / - | (C) / 1 | (C) / 0 | B / - |

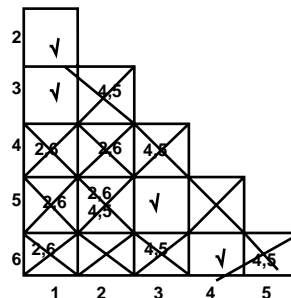

FIGURE 41.11 Implication table for the PFT.

input the stable states either go to the same next states and have the same outputs, or at least they do not contradict. Hence, the corresponding merger diagram shows that the PFT can be reduced to a 3-state *flow table*. The new reduced final states in the flow table are then the three nonbinary states, A, B, and C. State A is (1, 2), state B is (3, 5), and state C is (4, 6). Table 41.5 shows the reduced flow table. In this flow table, we have more than one stable state per row. Note that when states are combined, the “don’t care” entries are replaced with the actual states under a given input.

TABLE 41.6 Flow Table (FT) with an Added Cycle D to Eliminate A Critical Race

| State Assignment | Present State | Next State / Output | | | |
|------------------|---------------|---------------------|---------|---------|---------|
| | | X_2X_1 00 | 01 | 11 | 10 |
| 00 | (A) | (A) / 0 | (A) / 0 | C / - | B / - |
| 01 | (B) | A / - | D / - | (B) / 1 | (B) / 0 |
| 10 | (C) | A / - | (C) / 1 | (C) / 0 | B / - |
| 11 | (D) | - / - | C / - | - / - | - / - |

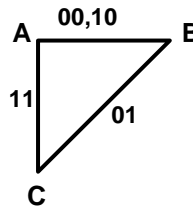

FIGURE 41.12 State transition. AB transitions are noncritical; AC, BC are critical transitions.

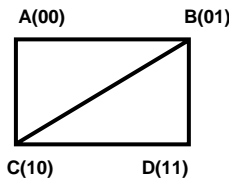

FIGURE 41.13 State transitions through cycle D. Note that B goes to C through cycle D.

3. The next step is the state assignment. Here again, each state must be given adjacent assignments if there is a state transition between any two stable states. As long as there are more than two stable states per row, then all transitions between the states are considered critical. Figure 41.12 shows all critical transitions between the stable states. Each line represents a transition with its corresponding input value indicated on the line. Note that input 00 is not a critical transition because it has only one stable state (A). But if a critical transition exists, we must have adjacent assignments in order to avoid the problem of a critical race, where we might end up in a different stable state when multiple input changes occur. Our state assignment in Fig. 41.12 shows that we must have three adjacencies (A, B), (A, C), and (B, C). But since we can have only two adjacencies with two variables, then we can either give multiple assignments per stable state or create cycles. The disadvantage of the first method is the fact that we may have more logic because of the added states, which would consequently add to the cost and reduce the performance (i.e., speed.) The second method is the creation of cycles. This method would also affect the performance with the added delay of cycles. In this example, an added cycle with no stable states is created between states B and C in order to ensure the transition between the two states. In this problem, state D is a cycle created between states B and C, as shown in Fig. 41.13. Hence, states B and C can only make transitions between them through the newly created cycle in state D. The new flow table is shown in Table 41.6.

TABLE 41.7 Encoded Excitation and Output Table

| Present State | Next State / Output | | | |
|---------------|---------------------|--------|--------|--------|
| | X_2X_1 00 | 01 | 11 | 10 |
| 00 | 00 / 0 | 00 / 0 | 10 / - | 01 / - |
| 01 | 00 / - | 11 / - | 01 / 1 | 01 / 0 |
| 10 | 00 / - | 10 / 1 | 10 / 0 | 01 / - |
| 11 | - / - | 10 / - | - / - | - / - |

$$Y_2^+ = D_2 = Y_2X_1 + Y_1X_2'X_1 + Y_1'X_2X_1$$

$$Y_1^+ = D_1 = X_2X_1' + Y_2'Y_1X_1$$

$$Z = Y_2X_2' + Y_1X_1$$

FIGURE 41.14 Excitation and output equations.

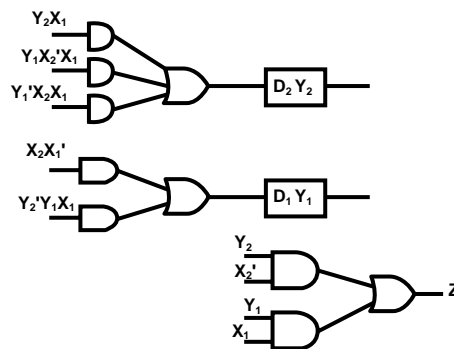

FIGURE 41.15 Implementation of asynchronous example.

4. The next step is the derivation of the encoded excitation and output tables. This is shown in Table 41.7. Again stable states are circled. While Y_2Y_1 represent the present state, $Y_2^+Y_1^+$ represent the next state.
5. The next step is to derive the corresponding excitation (or next state) as well as the output equations, as shown in Fig. 41.14.
6. A logical implementation or realization of the above equations is shown in Fig. 41.15.

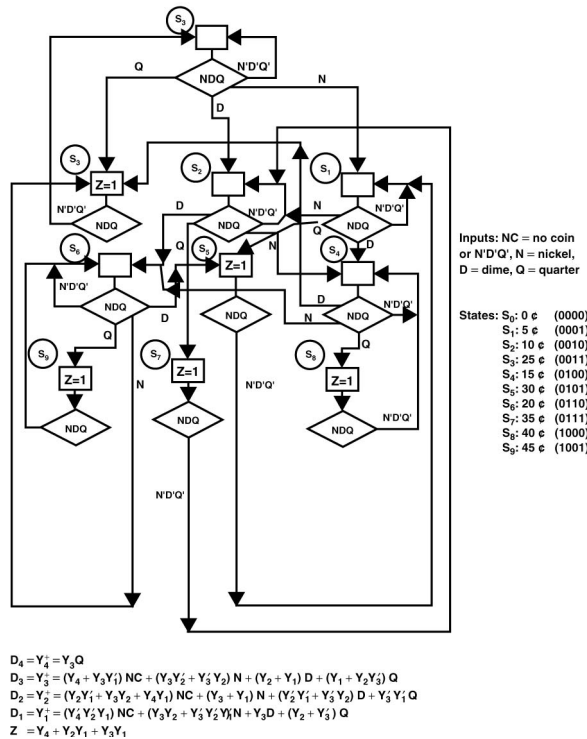

FIGURE 41.16 ASM chart and datapaths for synchronous design for vending machine controller, and FF input and output equations.

41.4 Design of Controllers' Circuits and Datapaths

Controller circuits could be designed using synchronous as well asynchronous circuits. In most cases, synchronous designs are preferred in order to avoid races and hazards. Asynchronous circuits are not recommended because the delays are not controlled by the designer. However, asynchronous circuits are at times unavoidable since they are much faster and because sometimes they do exist locally in a much larger synchronous system. A formal design methodology for controllers or processors is the use of the *algorithmic state machines* (ASM). An ASM diagram is a type of flowchart that can be used to represent the state transitions and the generated outputs for an FSM. Each state is represented by a rectangular box, while the inputs are tested through a diamond box. Outputs are indicated either as conditional with the use of an oval-shaped box (Mealy-type outputs) or unconditional inside the state boxes (Moore-type outputs.) The datapaths of the system are shown as transitions from state to state. In a synchronous system, state transitions take place with clock transitions. On the other hand, asynchronous systems may have state transitions when changes in inputs take place. A designer must analyze such a circuit very carefully in order to make sure that the circuit would operate according to its specifications, especially when sometimes asynchronous inputs are unavoidable.

As an example, let us design a controller circuit for a coffee machine. The cost of the coffee is 25 cents. Nickels (N), dimes (D), and quarters (Q) are accepted. However, no coin change is allowed. The output is dispensed immediately after 25 cents are deposited. Figure 41.16 shows the design steps, datapaths, and implementation of a synchronous controller circuit.

41.5 Concluding Remarks

Most digital designs are sequential systems. Such systems may be synchronous or asynchronous. Synchronous systems have a clock that controls the operation of the system. The performance of such a system is as good as the speed of its clock. But synchronous systems avoid the problems of hazards and races. On the other hand, asynchronous circuits and controllers are much faster but may include races. A race may occur whenever a state transition requires the change of two or more of the state variables simultaneously. The race is between different variables to see which one changes first. A critical race may force the circuit to end up in different stable states. Critical races may be eliminated by carefully studying and analyzing the circuit.

42

Architecture

Daniel A. Connors

*University of Colorado
at Boulder*

Wen-mei W. Hwu

*University of Illinois
at Urbana-Champaign*

- 42.1 Introduction
- 42.2 Types of Microprocessors
- 42.3 Major Components of a Microprocessor
 - Central Processor • Input/Output Subsystem • System Interconnection
- 42.4 Instruction Set Architecture
- 42.5 Instruction Level Parallelism
 - Dynamic Instruction Execution • Predicated Execution • Speculative Execution
- 42.6 Industry Trends
 - Computer Microprocessor Trends • Embedded Microprocessor Trends • Microprocessor Market Trends

42.1 Introduction

The microprocessor industry is divided into the computer and embedded sectors. Both computer and embedded microprocessors share aspects of computer design, instruction set architecture, organization, and hardware. The term “computer architecture” is used to describe these fundamental aspects and, more directly, refers to the hardware components in a computer system and the flow of data and control information among them. In this chapter, various types of microprocessors will be described, fundamental architecture mechanisms relevant in the operation of all microprocessors will be presented, and microprocessor industry trends discussed.

42.2 Types of Microprocessors

Computer microprocessors are designed for use as the central processing units (CPU) of computer systems such as personal computers, workstations, servers, and supercomputers. Although microprocessors started as humble programmable controllers in the early 1970s, virtually all computer systems built in the 1990s use microprocessors as their central processing units. The dominating architecture in the computer microprocessor domain today is the Intel 32-bit architecture, also known as IA-32 or X86. Other high-profile architectures in the computer microprocessor domain include Compaq-Digital Alpha, HP PA-RISC, Sun Microsystems SPARC, IBM/Motorola PowerPC, and MIPS.

Embedded microprocessors are increasingly used in consumer and telecommunications products to satisfy the demands for quality and functionality. Major product areas that require embedded microprocessors include digital TV, digital cameras, network switches, high-speed modems, digital cellular phones, video games, laser printers, and automobiles. Future improvements in energy consumption, fabrication cost, and performance will further enable new applications such as the hearing aid. Many experts expect that embedded microprocessors will form the fastest growing sector of the semiconductor business in the next decade.¹

Embedded microprocessors have been categorized into DSP processors and embedded CPUs due to historic reasons. DSP processors have been designed and marketed as special-purpose devices that are mostly programmed by hand to perform digital signal processing computations. A recent trend in the DSP market is to use compilers to alleviate the need for tedious hand-coding in DSP development. Another recent trend in the DSP market is toward integrating a DSP processor core with application-specific logic to form a single-chip solution. This approach is enabled by the fast increasing chip density technology. The major benefit is reduced system cost and energy consumption. Two general types of DSP cores are available to application developers today. Foundry-captive DSP cores and related application-specific logic design services are provided by major semiconductor vendors such as Texas Instruments, Lucent Technologies, and SGS-Thomson to application developers who commit to their fabrication lines. A very large volume commitment is usually required to use the design service. Licensable DSP cores are provided by small to medium design houses to application developers who want to be able to choose fabrication lines.

There are several ways that the needs of embedded computing differ from those of the more traditional general-purpose systems. Constraints on the code size, weight, and power consumption place stringent requirements on embedded processors and the software they execute. Also, constraints rooted in real-time requirements are often a significant consideration in many embedded systems. Furthermore, cost is a severe constraint on embedded processors.

Embedded CPUs are used in products where the computation involved resembles that of general-purpose applications and operating systems. Embedded CPUs have been traditionally derived from out-of-date computer microprocessors. They often reuse the compiler and related software support developed for their computer cousins. Recycling the microprocessor design and compiler software minimizes engineering cost. A trend in the embedded CPU domain is similar to that in the DSP domain: to provide embedded CPU cores and application specific logic design services to form single-chip solutions. For example, MIPS customized its embedded CPU core for use in Nintendo64, in return for engineering fees and royalty streams. ARM, NEC, and Hitachi offer similar products and services. Due to an increasing need to perform DSP computation in consumer and telecommunication products, an increasing number of embedded CPUs have extensions to enable more effective DSP computation.

Contrary to the different constraints and product markets, both computer and embedded microprocessors share traditional elements of computer architecture. These main elements will be described. Additionally, over the past decade, substantial research has gone into the design of microprocessors embodying parallelism at the instruction level, as well as aggressive compiler optimization and analysis techniques for harnessing this opportunity. Much of this effort has since been validated through the proliferation of mainstream general-purpose computers based on these technologies. Nevertheless, growing demand for high performance in embedded computing systems is creating new opportunities to leverage these techniques in application-specific domains. The research of Instruction-Level Parallelism (ILP) has developed a distinct architecture methodology referred to as Explicitly Parallel Instruction Computing (EPIC) technology. Overall, these techniques represent fundamental substantial changes in computer architecture.

42.3 Major Components of a Microprocessor

The main hardware of a microprocessor system can be divided into sections according to their functionalities. A popular approach is to divide a system into four subsystems: the central processor, the memory subsystem, the input/output (I/O) subsystem, and the system interconnection. [Figure 42.1](#) shows the connection between these subsystems. The main components and characteristics of these subsystems will be described.

Central Processor

A modern microprocessor's central processor system can typically be further divided into control, data path, pipelining, and branch prediction hardware.

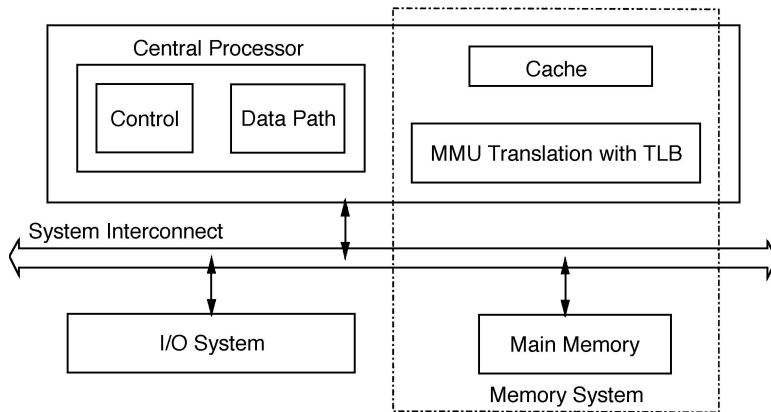

FIGURE 42.1 Architecture subsystems of a computer system.

Control Unit

The *control unit* of a microprocessor generates the control signals to orchestrate the activities in the data path. There are two major types of communication lines between the control unit and the data path: the control lines and the condition lines. The *control lines* deliver the control signals from the control unit to the data path. Different signal values on these lines trigger different actions in the data path. The *condition lines* carry the status of the execution from data path to the control unit. These lines are needed to test conditions involving the registers in the data path in order to make future control decisions. Note that the decision is made in the control unit, but the registers are in the data path. Therefore, the conditions regarding the register contents are formed in the data path and then shipped to the control unit for decision-making. A control unit can be implemented with hardwiring, microprogramming, or a combination of both.

In a hardwired design, each control unit is viewed as an ordinary sequential circuit. The design goals are to minimize the component count and to maximize the operation speed. The finite state machine is realized with registers, logic, and wires. Once constructed, the design can be changed only through physically rewiring the unit. Therefore, the resulting circuits are called *hardwired control units*. Due to design optimizations, the resulting circuits often exhibit little structure. The lack of structure makes it very difficult to design and debug complicated control units with this technique. Therefore, hardwiring is normally used when the control unit is relatively simple.

Most of the design difficulties in the hardwired control units are due to the effort of optimizing the combinational circuit. If there is a method that does not attempt to optimize the combinational circuit, the design complexity could be significantly reduced. One obvious option is to use either read-only memory (ROM) or random access memory (RAM) to implement the combinational circuit. A control unit whose combinational circuit is simplified by the use of ROM or RAM is called a *microprogrammed control unit*. The memory used is called *control memory (CM)*. The practice of realizing the combinational circuit in a control unit with ROM/RAM is called *microprogramming*. The concept of microprogramming was first introduced by Wilkes.

The idea of using a memory to implement a combinational circuit can be illustrated with a simple example. Assume that we are to implement a logic function with three input variables, as described in the truth table illustrated in Fig. 42.2(a). A common way to realize this function is to use Karnaugh maps to derive highly optimized logic and wiring. The result is shown in Fig. 42.2(b). The same function can also be realized in memory. In this method, a memory with eight 1-bit locations can be used to retain the eight possible combinations of the three-input variable. Location i contains an F value corresponding to the i th input combination. For example, location 3 contains the F value (0) for the input combination 011. The three input variables are then connected to the address input of the memory to complete the design (Fig. 42.2(c)). In essence, the memory implicitly contains the entire truth table. Considering the

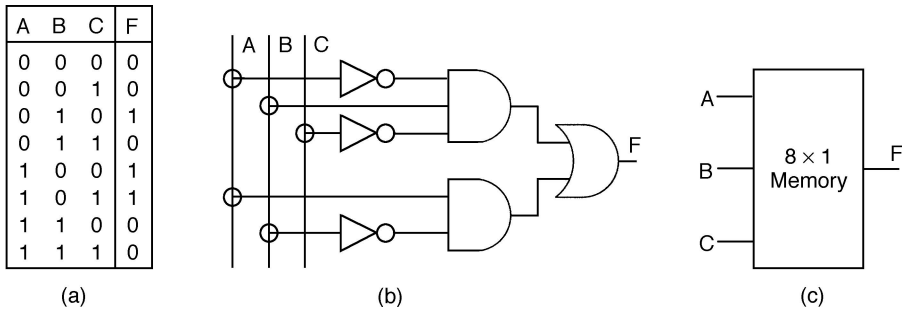

FIGURE 42.2 Using memory to simplify logic design: (a) Karnaugh map, (b) logic, (c) memory.

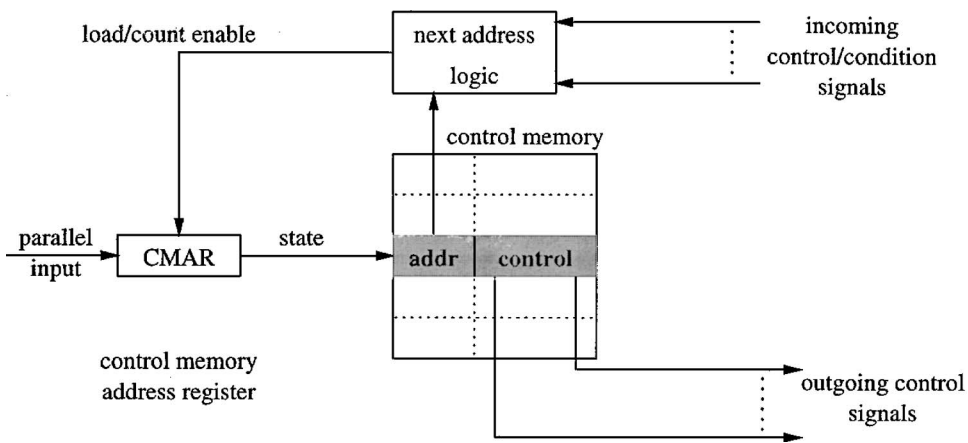

FIGURE 42.3 Basic model of microprogrammed control units.

decoding logic and storage cells involved in a 8×1 memory, it is obvious that the memory approach uses a lot more hardware components than the Karnaugh map approach. However, the design is much simpler in the memory approach.

Figure 42.3 illustrates the general model of a microprogrammed control unit. Each control memory location consists of an address field and some control fields. The address field plus the next address logic implements the combinational circuit for generating the next state value. The control fields implement the combinational circuit for generating the control signal. Both the control memory and the next address logic will be studied in detail in this section. The state register/counter has been renamed the *Control Memory Address Register* (CMAR) for an obvious reason: the contents of the register are used as the address input to the control memory. An important insight is that the CMAR stores the state of the control unit.

Data Path

The data path of a microprocessor contains the main arithmetic and logic execution units required to execute instructions. Designing the data path involves analyzing the function(s) to be performed, then specifying a set of hardware registers to hold the computation state, and designing computation steps to transform the contents of these registers into the final result. In general, the functions to be performed will be divided into steps, each of which can be done with a reasonable amount of logic in one clock cycle. Each step brings the contents of the registers closer to the final result. The data path must be equipped with a sufficient amount of hardware to allow these computation steps in one clock cycle. The data path of a typical microprocessor contains integer and floating-point register files, ten or more functional units

for computation and memory access, and pipeline registers. One must understand the concept of pipelining in order to understand the data paths of today's microprocessors.

Pipelining

In the 1970s, only supercomputers and mainframe computers were pipelined. Today, most commercial microprocessors are pipelined. In fact, pipelining has been a major reason why microprocessors today outperform supercomputers built less than 10 years ago. Pipelining is a technique to coordinate parallel processing of operations.² This technique has been used in assembly lines of major industries for more than a century. The idea is to have a line of workers specializing in different pieces of work required to finish a product. A conveying belt carries each product through the line of workers. Each worker will do a small piece of work on each product. Each product is finished after it is processed by all the workers in the assembly line.

The obvious advantage of pipelining is to allow one worker to immediately start working on a new product after finishing the work on a current product. The same methodology is applied to instruction processing in microprocessors. Figure 42.4(a) shows an example five-stage pipeline dividing instruction execution into Fetch (F), Decode (D), Execute (E), Memory (M), and Write-back (W) operations, each requiring various stage-specific logic. Between each stage is a stage register (SR) used to hold the instruction information necessary to control the instruction. A very basic principle of pipelining is that the work performed by each stage must take about the same amount of time. Otherwise, the efficiency will be significantly reduced because one stage becomes a bottleneck of the entire pipeline. Similarly, the time duration of the slowest pipeline stage determines the overall clock frequency of the processor. Due to this constraint and the characteristics of memory speeds, the five-stage pipeline model often requires some of the principle five stages to be divided into smaller stages. For instance, the memory stage may be divided into three stages, allowing memory accesses to be pipelined and the overall processor clock speed to be a function of a fraction of the memory access latency.

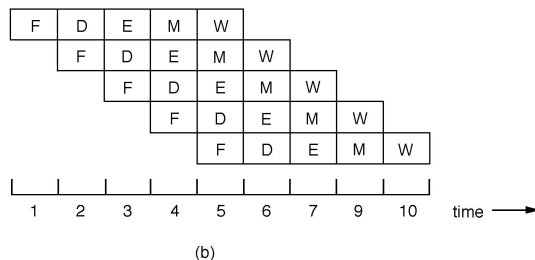
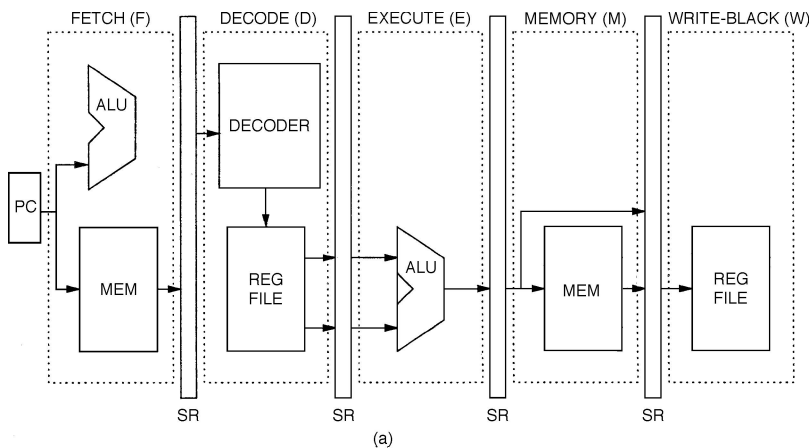

FIGURE 42.4 Pipeline architecture: (a) machine, (b) overlapping instructions.

The time required to finish N instructions in a pipeline with K stages can be calculated. Assume a cycle time of T for the overall instruction completion, and an equal T/K processing delay at each stage. With a pipeline scheme, the first instruction completes the pipeline after T , and there will be a new instruction out of the pipeline per stage delay T/K . Therefore, the delays of executing N instructions with and without pipelining, respectively, are

$$T * (N) \tag{42.1}$$

$$T + (T/k) * (N - 1) \tag{42.2}$$

There is an initial delay in the pipeline execution model before each stage has operations to execute. The initial delay is usually called *pipeline start-up delay* (P), and is equal to total execution time of one instruction. The speed-up of a pipelined machine relative to a nonpipelined machine is calculated as

$$\frac{P * N}{P + (N - 1)} \tag{42.3}$$

When N is much larger than the number of pipestages P , the ideal speed-up approaches P . This is an intuitive result since there are P parts of the machine working in parallel, allowing the execution to go about P times faster in ideal conditions.

The overlap of sequential instructions in a processor pipeline is shown in Fig. 42.4(b). The instruction pipeline becomes full after the pipeline delay of $P = 5$ cycles. Although the pipeline configuration executes operations in each stage of the processor, two important mechanisms are constructed to ensure correct functional operation between dependent instructions in the presence of data hazards. Data hazards occur when instructions in the pipeline generate results that are necessary for later instructions that are already started in the pipeline. In the pipeline configuration of Fig. 42.4(a), register operands are initially retrieved during the decode stage. However, the execute and memory stage can define register operands and contain the correct current value but are not able to update the register file until the later write-back execution stage. Forwarding (or bypassing) is the action of retrieving the correct operand value for an executing instruction between the initial register file access and any pending instruction's register file updates. Interlocking is the action of stalling an operation in the pipeline when conditions cause necessary register operand results to be delayed. It is necessary to stall early stages of the machine so that the correct results are used, and the machine does not proceed with incorrect values for source operands. The primary causes of delay in pipeline execution are initiated due to instruction fetch delay and memory latency.

Branch Prediction

Branch instructions pose serious problems for pipelined processors by causing hardware to fetch and execute instructions until the branch instructions are completed. Executing incorrect instructions can result in severe performance degradation through the introduction of wasted cycles into the instruction stream.

There are several methods for dealing with pipeline stalls caused by branch instructions. The simplest performance scheme handles branches by treating every branch as either *taken* or *not taken*. This treatment can be set for every branch or determined by the branch opcode. The designation allows the pipeline to continue to fetch instructions as if the branch was a normal instruction. However, the fetched instruction may need to be discarded and the instruction fetch restarted when the branch outcome is incorrect. *Delayed branching* is another scheme which treats the set of sequential instructions following a branch as delay slots. The delay-slot instructions are executed whether or not the branch instruction is taken. Limitations on delayed branches are caused by the compiler and program characteristics being unable to support numerous instructions that execute independent of the branch direction. Improvements have been introduced to provide *nullifying* branches, which include a predicted direction for the branch. When the prediction is incorrect, the delay-slot instructions are nullified.

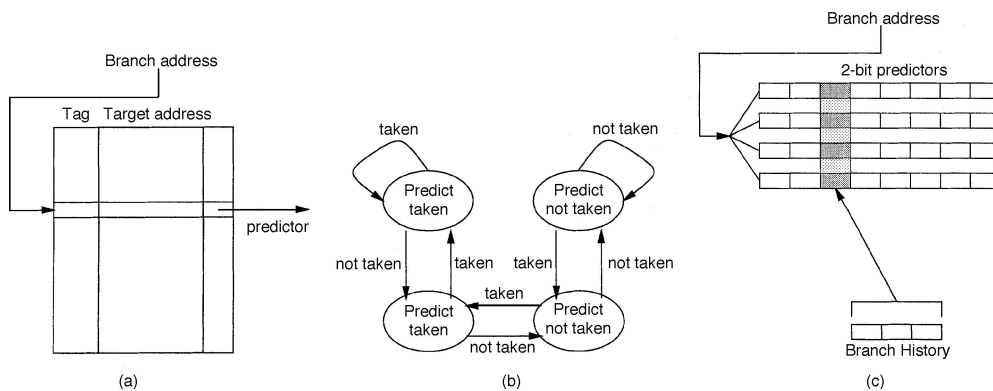

FIGURE 42.5 Branch prediction.

A more modern approach to reducing branch penalties uses hardware to dynamically predict the outcome of a branch. Branch prediction strategies reduce overall branch penalties by allowing the hardware to continue processing instructions along the predicted control path, thus eliminating wasted cycles. Efficient execution can be maintained while branch targets are correctly predicted. However, a large performance penalty is incurred when a branch is mispredicted. Branch target buffer is a cache structure that is accessed in parallel with the instruction fetch. It records the past history of branch instructions so that a prediction can be made while the branch is fetched again. This prediction method adapts the branch prediction to the run-time program behavior, generating a high prediction accuracy. The target addresses of the branch is also saved in the buffer so that the target instruction can be fetched immediately if a branch is predicted taken.

Several methodologies of branch target prediction have been constructed.³ Figure 42.5 illustrates several general branch prediction schemes. The most common implementation retains history information for each branch as shown in Fig. 42.5(a). The history includes the previous branch directions for making predictions on future branch directions. The simplest history is last taken, which uses 1-bit to recall whether the branch condition was taken or not taken. A more effective branch predictor uses a 2-bit saturating state history counter to determine the future branch outcome similar to Fig. 42.5(b). Two bits rather than 1 bit allows each branch to be tagged as strongly or weakly taken or not taken. Every correct prediction reinforces the prediction, while an incorrect prediction weakens it. It takes two consecutive mispredictions to reverse the direction (whether taken or not taken) of the prediction.

Recently, more complex two-level adaptive branch prediction schemes have been built, which use two levels of branch history to make predictions, as shown in Fig. 42.5(c). The first level is the branch outcome history of the last branches encountered. The second level is the branch behavior for the last occurrences of a specific pattern of branch histories. There are alternative ways of constructing both levels of adaptive branch prediction schemes, the mechanisms can contain information that is either based on individual branches, groups (set-based), and all (global). Individual formation contains the branch history for each branch instruction. Set-based information groups branches according to their instruction address, thereby forming sets of branch history. Global information uses a global history containing all branch outcomes. The second level containing branch behaviors can also be constructed using any of the three types. In general, the first-level branch history pattern is used as an index into the second-level branch history.

Memory Subsystem

The *memory system* serves as a repository of information in a microprocessor system. The processing unit retrieves information stored in memory, operates on the information, and returns new information back to memory. The memory system is constructed of basic semiconductor DRAM units called modules or banks.

There are several properties of memory, including speed, capacity, and cost that play an important role in the overall system performance. The speed of a memory system is the key performance parameter in the design of the microprocessor system. The *latency* (L) of the memory is defined as the time delay from when the processor first requests data from memory until the processor receives the data. *Bandwidth* (BW) is defined as the rate at which information can be transferred from the memory system. Memory bandwidth and latency are related to the number of outstanding requests (R) that the memory system can service:

$$BW = \frac{L}{R} \tag{42.4}$$

Bandwidth plays an important role in keeping the processor busy with work. However, technology tradeoffs to optimize latency and improve bandwidth often conflict with the need to increase the capacity and reduce the cost of the memory system.

Cache Memory

Cache memory, or simply cache, is a small, fast memory constructed using semiconductor SRAM. In modern computer systems, there is usually a hierarchy of cache memories. The top-level cache is closest to the processor and the bottom level is closest to the main memory. Each higher level cache is about 5–10 times faster than the next level. The purpose of a cache hierarchy is to satisfy most of the processor memory accesses in one or a small number of clock cycles. The top-level cache is often split into an instruction cache and a data cache to allow the processor to perform simultaneous accesses for instructions and data. Cache memories were first used in the IBM mainframe computers in the 1960s. Since 1985, cache memories have become a standard feature for virtually all microprocessors.

Cache memories exploit the principle of locality of reference. This principle dictates that some memory locations are referenced more frequently than others, based on two program properties. *Spatial locality* is the property that an access to a memory location increases the probability that the nearby memory location will also be accessed. Spatial locality is predominantly based on sequential access to program code and structured data. *Temporal locality* is the property that access to a memory location greatly increases the probability that the same location will be accessed in the near future. Together, the two properties ensure that most memory references will be satisfied by the cache memory.

There are several different cache memory designs: direct-mapped, fully associative, and set associative. Figure 42.6 illustrates the two basic schemes of cache memory, direct-mapped and set associative.

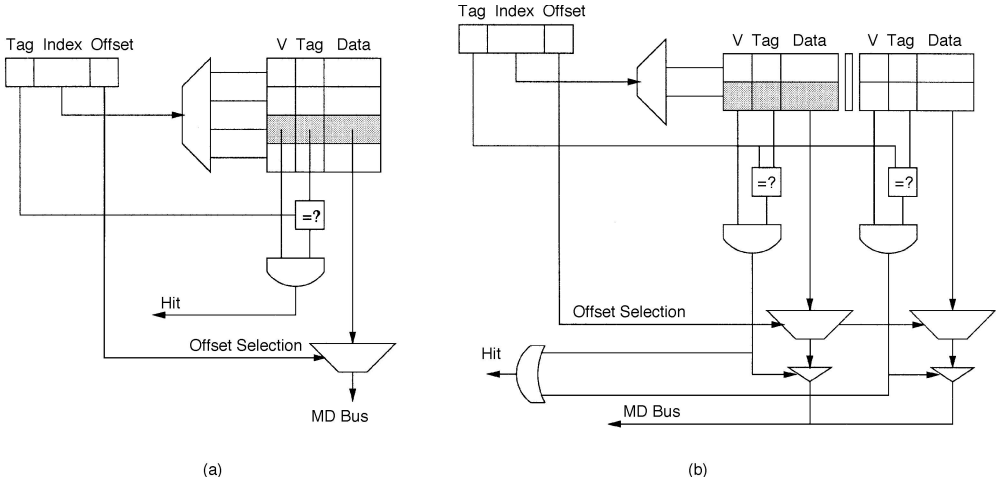

FIGURE 42.6 Cache memory: (a) direct-mapped design, (b) two-way set-associative design.

Direct-mapped cache, shown in Fig. 42.6(a) allows each memory block to have one place to reside within a cache. Fully associative cache, shown in Fig. 42.6(b), allows a block to be placed anywhere in the cache. Set-associative cache restricts a block to a limited set of places in the cache.

Cache misses are said to occur when the data requested does not reside in any of the possible cache locations. Misses in caches can be classified into three categories: conflict, compulsory, and capacity. Conflict misses are misses that would not occur for fully associative caches with LRU (least recently used) replacement. Compulsory misses are misses required in cache memories for initially referencing a memory location. Capacity misses occur when the cache size is not sufficient to contain data between references. Complete cache miss definitions are provided in Ref. 4.

Unlike memory system properties, the latency in cache memories is not fixed and depends on the delay and frequency of cache misses. A performance metric that accounts for the penalty of cache misses is *effective latency*. Effective latency depends on the two possible latencies, hit latency (L_{HIT}), the latency experienced for accessing data residing in the cache, and miss latency (L_{MISS}), the latency experienced when accessing data not residing in the cache. Effective latency also depends on the *hit rate* (H), the percentage of memory accesses that are hits in the cache, and the *miss rate* (M or $1 - H$), the percentage of memory accesses that miss in the cache. Effective latency in a cache system is calculated as

$$L_{\text{effective}} = L_{\text{HIT}} * H + L_{\text{MISS}} * (1 - H) \tag{42.5}$$

In addition to the base cache design and size issues, there are several other cache parameters that affect the overall cache performance and miss rate in a system. The main memory update method indicates when the main memory will be updated by store operations. In *write-through* cache, each write is immediately reflected to the main memory. In *write-back* cache, the writes are reflected to the main memory only when the respective cache block is replaced. Cache block allocation is another parameter and designates whether the cache block is allocated on writes or reads. Last, block replacement algorithms for associative structures can be designed in various ways to extract additional cache performance. These include LRU, LFU (least frequently used), random, and FIFO (first-in, first-out). These cache management strategies attempt to exploit the properties of locality. Spatial locality is exploited by deciding which memory block is placed in cache, and temporal locality is exploited by deciding which cache block is replaced. Traditionally, when cache service misses, they would *block* all new requests. However, *non-blocking* cache can be designed to service multiple miss requests simultaneously, thus alleviating delay in accessing memory data.

In addition to the multiple levels of cache hierarchy, additional memory buffers can be used to improve cache performance. Two such buffers are a streaming/prefetch buffer and a victim cache.² Figure 42.7 illustrates the relation of the streaming buffer and victim cache to the primary cache of a memory system.

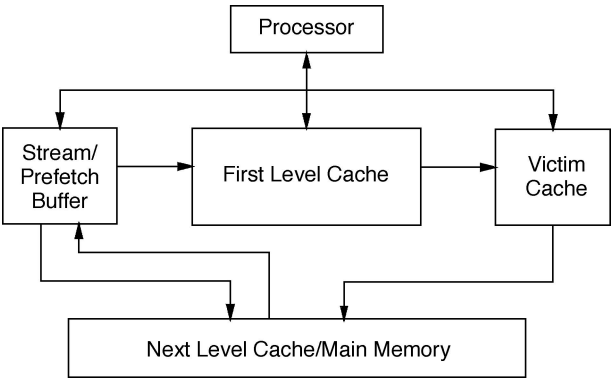

FIGURE 42.7 Advanced cache memory system.

A streaming buffer is used as a prefetching mechanism for cache misses. When a cache miss occurs, the streaming buffer begins prefetching successive lines starting at the miss target. A victim cache is typically a small, fully associative cache loaded only with cache lines that are removed from the primary cache. In the case of a miss in the primary cache, the victim cache may hold additional data. The use of a victim cache can improve performance by reducing the number of conflict misses. Figure 42.7 illustrates how cache accesses are processed through the streaming buffer into the primary cache on cache requests, and from the primary cache through the victim cache to the secondary level of memory on cache misses.

Overall, cache memory is constructed to hold the most important portions of memory. Techniques using either hardware or software can be used to select which portions of main memory to store in cache. However, cache performance is strongly influenced by program behavior and numerous hardware design alternatives.

Virtual Memory

Cache memory illustrated the principle that the memory address of data can be separate from a particular storage location. Similar address abstractions exist in the two-level memory hierarchy of main memory and disk storage. An address generated by a program is called a *virtual address*, which needs to be translated into a *physical address* or location in main memory. Virtual memory management is a mechanism, which provides the programmers with a simple uniform method to access both main and secondary memories. With virtual memory management, the programmers are given a virtual space to hold all the instructions and data. The virtual space is organized as a linear array of locations. Each location has an address for convenient access. Instructions and data have to be stored somewhere in the real system; these virtual space locations must correspond to some physical locations in the main and secondary memory. Virtual memory management assigns (or maps) the virtual space locations into the main and secondary memory locations. The mapping of virtual space locations to the main and secondary memory is managed by the virtual memory management. The programmers are not concerned with the mapping.

The most popular memory management scheme today is demand paging virtual memory management, where each virtual space is divided into pages indexed by the page number (PN). Each page consists of several consecutive locations in the virtual space indexed by the page index (PI). The number of locations in each page is an important system design parameter called page size. Page size is usually defined as a power of two so that the virtual space can be divided into an integer number of pages. Pages are the basic unit of virtual memory management. If any location in a page is assigned to the main memory, the other locations in that page are also assigned to the main memory. This reduces the size of the mapping information.

The part of the secondary memory to accommodate pages of the virtual space is called the swap space. Both the main memory and the swap space are divided into page frames. Each page frame can host a page of the virtual space. If a page is mapped into the main memory, it is also hosted by a page frame in the main memory. The mapping record in the virtual memory management keeps track of the association between pages and page frames.

When a virtual space location is requested, the virtual memory management looks up the mapping record. If the mapping record shows that the page containing requested virtual space location is in main memory, the management performs the access without any further complication. Otherwise, a secondary memory access has to be performed. Accessing the secondary memory is usually a complicated task and is usually performed as an operating system service. In order to access a piece of information stored in the secondary memory, an operating system service usually has to be requested to transfer the information into the main memory. This also applies to virtual memory management. When a page is mapped into the secondary memory, the virtual memory management has to request a service in the operating system to transfer the requested virtual space location into the main memory, update its mapping record, and then perform the access. The operating system service thus performed is called the page fault handler.

The core process of virtual memory management is a memory access algorithm. A one-level virtual address translation algorithm is illustrated in Fig. 42.8. At the start of the translation, the memory access algorithm receives a virtual address in a memory address register (MAR), looks up the mapping record,

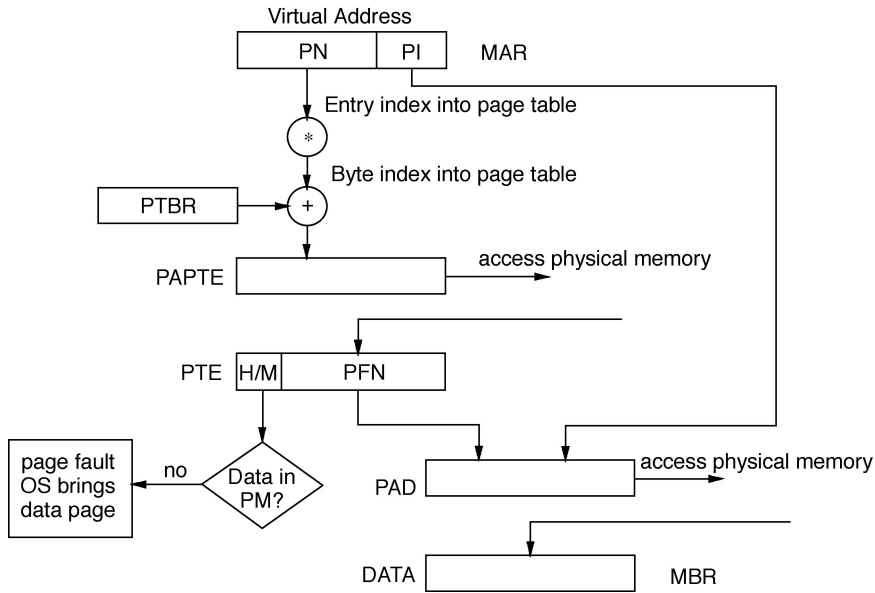

FIGURE 42.8 Virtual memory translation.

requests an operating system service to transfer the required page if necessary, and performs the main memory access. The mapping is recorded in a data structure called the page table located in main memory at a designated location marked by the page table base register (PTBR).

The page table index and the PTBR form the physical address (PAPTE) of the respective page table entry (PTE). Each PTE keeps track of the mapping of a page in the virtual space. It includes two fields: a hit/miss bit and a page frame number. If the hit/miss (H/M) bit is set (hit), the corresponding page is in main memory. In this case, the page frame hosting the requested page is pointed to by the page frame number (PFN). The final physical address (PAD) of the requested data is then formed using the PFN and PI. The data is returned and placed in the memory buffer register (MBR) and the processor is informed of the completed memory access. Otherwise (miss), a secondary memory access has to be performed. In this case, the page frame number should be ignored. The fault handler has to be invoked to access the secondary memory. The hardware component that performs the address translation algorithm is called the memory management unit (MMU).

The complexity of the algorithm depends on the mapping structure. A very simple mapping structure is used in this section to focus on the basic principles of the memory access algorithms. However, more complex two-level schemes are often used due to the size of the virtual address space. The size of the page table designated may be quite large for a range of main memory sizes. As such, it becomes necessary to map portions of page table into a second page table. In such designs, only the second-level page table is stored in a reserved region of main memory, while the first page table is mapped just like the data in the virtual spaces. There are also requirements for such designs in a multiprogramming system, where there are multiple processes active at the same time. Each processor has its own virtual space and therefore its own page table. As a result, these systems need to keep multiple page tables at the same time. It usually takes too much main memory to accommodate all the active page tables. Again, the natural solution to this problem is to provide other levels of mapping.

Translation Lookaside Buffer

Hardware support for a virtual memory system generally includes a mechanism to translate virtual addresses into the real physical addresses used to access main memory. A Translation Lookaside Buffer (TLB) is a cache structure, which contains the frequently used PTEs for address translation. With a TLB,

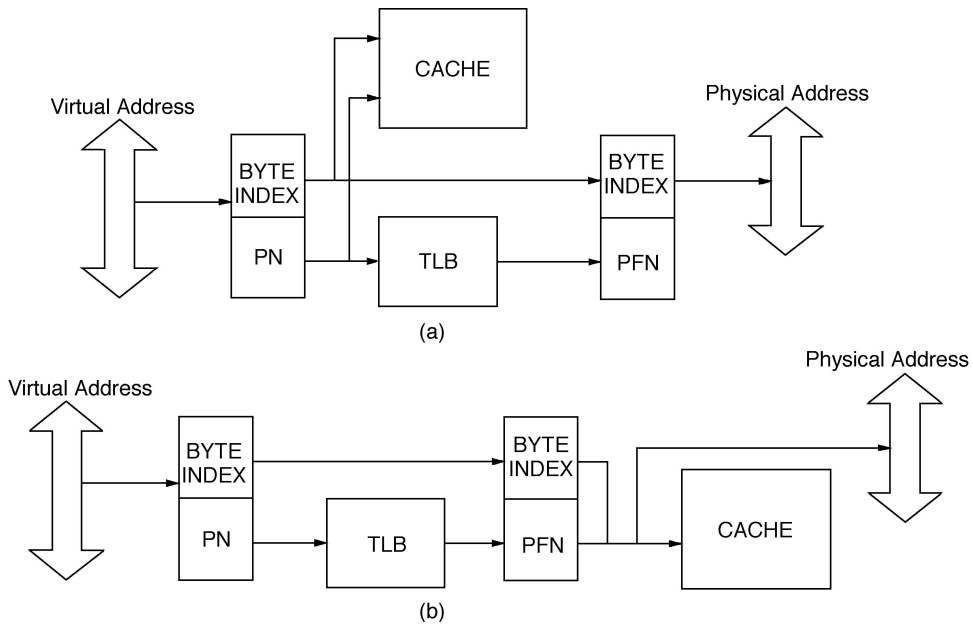

FIGURE 42.9 Translation Lookaside Buffer (TLB) architectures: (a) virtual cache, (b) physical cache.

address translation can be performed in a single clock cycle when TLB contains the required PTEs (TLB hit). The full address translation algorithm is performed only when the required PTEs are missing from the TLB (TLB miss).

Complexities arise when a system includes both virtual memory management and cache memory. The major issue is whether address translation is done before accessing the cache memory. In *virtual* cache systems, the virtual address directly accesses cache. In a *physical* cache system, the virtual address is translated into a physical address before cache access. [Figure 42.9](#) illustrates both the *virtual* and *physical* cache translation approaches.

A virtual cache system typically overlaps the cache memory access and the access to the TLB. The overlap is possible when the virtual memory page size is larger than the cache capacity divided by the degree of cache associativity. Essentially, since the virtual page index is the same as the physical address index, no translation for the lower indexes of the virtual address is necessary. Thus, the cache can be accessed in parallel with the TLB, or the TLB can be accessed after the cache access for cache misses. Typically, with no TLB logic between the processor and the cache, access to cache can be achieved at lower cost in virtual cache systems and multi-access per cycle cache systems can avoid requiring a multiported TLB. However, the virtual cache translation alternative introduces virtual memory consistency problems. The same virtual address from two different processes mean different physical memory locations. Solutions to this form of aliasing are to attach a process identifier to the virtual address or to flush cache contents on context switches. Another potential alias problem is that different virtual addresses of the same process may be mapped into the same physical address. In general, there is no easy solution; and it involves a reverse translation problem.

Physical cache designs are not always limited by the delay of the TLB and cache access. In general, there are two solutions to allow large physical cache design. The first solution, employed by companies with past commitments to page size, is to increase the set associativity of cache. This allows the cache index portion of the address to be used immediately by the cache in parallel with virtual address translation. However, large set associativity is very difficult to implement in a cost-effective manner. The second solution, employed by companies without past commitment, is to use a larger page size. The cache can be accessed in parallel with the TLB access similar to the other solution. In this solution, there are fewer

address indexes that are translated through the TLB, potentially reducing the overall delay. With larger page sizes, virtual caches do not have advantage over physical caches in terms of access time.

Input/Output Subsystem

The Input/Output (I/O) subsystem transfers data between the internal components (CPU and main memory) and the external devices (disks, terminals, printers, keyboards, scanners).

Peripheral Controllers

The CPU usually controls the I/O subsystem by reading from and writing into the I/O (control) registers. There are two popular approaches for allowing the CPU to access these I/O registers—I/O instructions and memory-mapped I/O. In an I/O instruction approach, special instructions are added to the instruction set to access I/O status flags, control registers, and data buffer registers. In a memory-mapped I/O approach, the control registers, the status flags, and the data buffer registers are mapped as physical memory locations. Due to the increasing availability of chip area and pins, microprocessors are increasingly including peripheral controllers on-chip. This trend is especially clear for embedded microprocessors.

Direct Memory Access Controller

A DMA controller is a peripheral controller that can directly drive the address lines of the system bus. The data is directly moved from the data buffer to the main memory, rather than from data buffer to a CPU register, then from CPU register to main memory.

System Interconnection

System interconnection is the facilities that allow the components within a computer system to communicate with each other. There are numerous logical organizations of these system interconnect facilities.

Dedicated links or point-to-point connections enable dedicated communication between components. There are different system interconnection configurations based on the connectivity of the system components. A complete connection configuration, requiring $N(N - 1)/2$ links, is created when there is one link between every possible pair of components. A *hypercube* configuration assigns a unique n -tuple $\{1, 0\}$ as the coordinate of each component and constructs a link between components whose coordinates differ only in one dimension, requiring $N \log N$ links. A *mesh* connection arranges the system components into an N -dimensional array and has connections between immediate neighbors, requiring $2N$ links.

Switching networks are a group of switches that determine the existence of communication links among components. A cross-bar network is considered the most general form of switching network and uses an $N \times M$ two-dimensional array of switches to provide an arbitrary connection between N components on one side to M components on another side using NM switches and $N + M$ links. Another switching network is the multistage network, which employs multiple stages of shuffle networks to provide a permutation connection pattern between N components on each side by using $N \log N$ switches and $N \log N$ links.

Shared buses are single links which connect all components to all other components and are the most popular connection structure. The sharing of buses among the components of a system requires several aspects of bus control. First, there is a distinction between bus masters, the units controlling bus transfers (CPU, DMA, IOP) and bus slaves, the other units (memory, programmed I/O interface).

Bus interfacing and bus addressing are the means to connect and disconnect units on the bus. Bus arbitration is the process of granting the bus resource to one of the requesters. Arbitration typically uses a selection scheme similar to interrupts; however, there are more fixed methods of establishing selection. Fixed-priority arbitration gives every requester a fixed priority, and round-robin ensures every requester the most favorable at one point in time. Bus timing refers to the method of communication among the system units and can be classified as either synchronous or asynchronous. Synchronous bus timing uses a shared clock that defines the time other bus signals change and stabilize. Clock sharing by all units allows the bus to be monitored at agreed time intervals and action taken accordingly. However, the synchronous system bus must operate at the speed of the slowest component. Asynchronous bus timing

allows units to use different clocks, but the lack of a shared clock makes it necessary to use extra signals to determine the validity of bus signals.

42.4 Instruction Set Architecture

There are several elements that characterize an instruction set architecture, including word size, instruction encoding, and architecture model.

Word Size

Programs often differ in the size of data they prefer to manipulate. Word processing programs operate on 8-bit or 16-bit data that correspond to characters in text documents. Many applications require 32-bit integer data to avoid frequent overflow in arithmetic calculation. Scientific computation often requires 64-bit floating-point data to achieve desired accuracy. Operating systems and databases may require 64-bit integer data to represent a very large name space with integers. As a result, the processors are usually designed to access multiple-byte data from memory systems. This is a well-known source of complexity in microprocessor design.

The endian convention specifies the numbering of bytes with a memory word. In the little endian convention, the least significant byte in a word is numbered byte 0. The number increases as the positions increase in significance. The DEC VAX and X86 architectures follow the little endian convention. In the big endian convention, the most significant byte in a word is numbered 0. The number decreases as the positions decrease in significance. The IBM 360/370, HP PA-RISC, Sun SPARC, and Motorola 680X0 architectures follow the big endian convention. The difference usually manifests itself when users try to transfer binary files between machines using different endian conventions.

Instruction Encoding

Instruction encoding plays an important role in the code density and performance of microprocessors. Traditionally, the cost of memory capacity was the determining factor in designing either a fixed-length or variable-length instruction set. Fixed-length instruction encoding assigns the same encoding size to all instructions. Fixed-length encoding is generally a characteristic of modern microprocessors and the product of the increasing advancements in memory capacity.

Variable-length instruction set is the term used to describe the style of instruction encoding that uses different instructions lengths according to addressing modes of operands. Common addressing modes included either register or methods of indexing memory. Figure 42.10 illustrates two potential designs found in modern use of decoding variable length instructions. The first alternative, in Fig. 42.10(a) involves an additional instruction decode stage in the original pipeline design. In this model, the first stage is used to

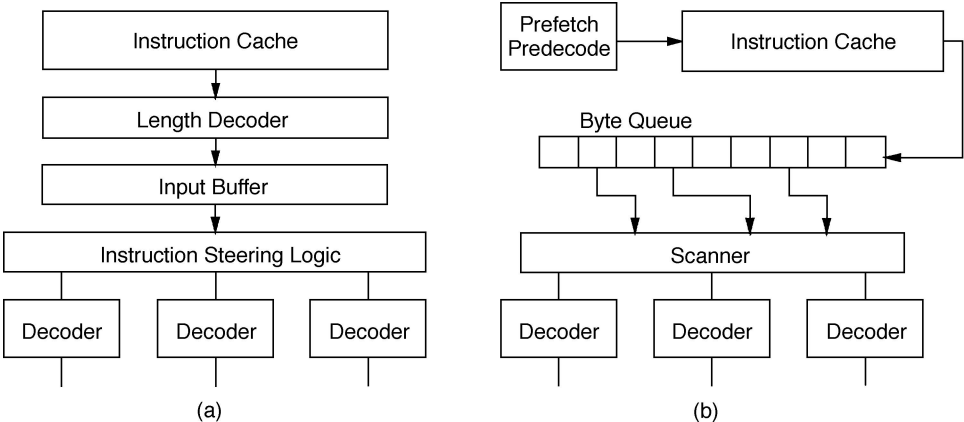

FIGURE 42.10 Variable-sized instruction decoding: (a) staging, (b) predecoding.

determine instruction lengths and steer the instructions to the second stage, where the actual instruction decoding is performed. The second alternative, in Fig. 42.10(b), involves predecoding and marking instruction lengths in the instruction cache. This design methodology has been effectively used in decoding X86 variable instructions.⁵ The primary advantage of this scheme is the simplification of the number of decode stages in the pipeline design. However, the method requires a larger instruction cache structure for holding the resolved instruction information.

Architecture Model

Several instruction set architecture models have existed over the last three decades of computing. First, CISC (complex instruction set computers) characterized designs with variable instruction formats, numerous memory addressing modes, and large numbers of instruction types. The original CISC philosophy was to create instructions sets that resembled high-level programming languages in an effort to simplify compiler technology. In addition, the design constraint of small memory capacity also led to the development of CISC. The two primary architecture examples of the CISC model are the Digital VAX and Intel X86 architecture families.

RISC (reduced instruction set computers) gained favor with the philosophy of uniform instruction lengths, load-store instruction sets, limited addressing modes, and reduced number of operation types. RISC concepts allow the microarchitecture design of machines to be more easily pipelined, reducing the processor clock cycle frequency and the overall speed of a machine. The RISC concept resulted from improvements in programming languages, compiler technology, and memory size. The HP PA-RISC, Sun SPARC, IBM Power PC, MIPS, and DEC Alpha machines are examples of RISC architectures.

Architecture models allowing multiple instructions to issue in a clock cycle are VLIW (very long instruction word). VLIWs issue a fixed number of operations conveyed as a single long instruction and place the responsibility of creating the parallel instruction packet on the compiler. Early VLIW processors suffered from code expansion due to instructions. Examples of VLIW technology are the Multiflow Trace and Cydrome Cydra machines. EPIC (explicitly parallel instruction computing) is similar in concept to VLIW in that both use the compiler to explicitly group instructions for parallel execution. In fact, many of the ideas for EPIC architectures come from previous RISC and VLIW machines. In general, the EPIC concept solves the excessive code expansion and scalability problems associated with VLIW models by not completely eliminating its functionality. Also, the trend of compiler controlled architecture mechanisms are generally considered part of the EPIC-style architecture domain. The Intel IA-64, Philips Trimedia, and Texas Instruments' C6X are examples of EPIC machines.

42.5 Instruction Level Parallelism

Modern processors are being designed with the ability to execute many parallel operations at the instruction level. Such processors are said to exploit ILP (instruction-level parallelism). Exploiting ILP is recognized as a new fundamental architecture concept in improving microprocessor performance, and there are a wide range of architecture techniques that define how an architecture can exploit ILP.

Dynamic Instruction Execution

A major limitation of pipelining techniques is the use of in-order instruction execution. When an instruction in the pipeline stalls, no further instructions are allowed to proceed to insure proper execution of in-flight instruction. This problem is especially serious for multiple issue machines, where each stall cycle potentially costs work of multiple instructions. However, in many cases, an instruction could execute properly if no data dependence exists between the stalled instruction and the instruction waiting to execute. Static scheduling is a compiler-oriented approach for scheduling instructions to separate dependent instructions and minimize the number of hazards and pipeline stalls. Dynamic scheduling is another approach that uses hardware to rearrange the instruction execution to reduce the stalls. The concept of dynamic execution uses hardware to detect dependences in the in-order instruction stream sequence and rearrange the instruction sequence in the presence of detected dependences and stalls.

Today, most modern superscalar microprocessors use dynamic out-of-order scheduling techniques to increase the number of instructions executed per cycle. Such microprocessors use basically the same dynamically scheduled pipeline concept, all instructions pass through an issue stage in-order, are executed out-of-order, and are retired in-order. There are several functional elements of this common sequence, which have developed into computer architecture concepts. The first functional concept is *scoreboarding*. Scoreboarding is a technique for allowing instructions to execute out-of-order when there are available resources and no data dependences. Scoreboarding originates from the CDC 6600 machine's issue logic, named the scoreboard. The overall goal of scoreboarding is to execute every instruction as early as possible.

A more advanced approach to dynamic execution is *Tomasulo's approach*. This scheme was employed in the IBM 360/91 processor. Although there are many variations on this scheme, the key concept of avoiding write-after-read (WAR) and write-after-write (WAW) dependences during dynamic execution is attributed to Tomasulo. In Tomasulo's scheme, the functionality of the scoreboarding is provided by the *reservation stations*. Reservation stations buffer the operands of instructions waiting to issue as soon as they become available. The concept is to issue new instructions immediately when all source operands become available instead of accessing such operands through the register file. As such, waiting instructions designate the reservation station entry that will provide their input operands. This action removes WAW dependences caused by successive writes to the same register by forcing instructions to be related by dependences instead of by register specifiers. In general, renaming of register specifiers for pending operands to the reservation station entries is called *register renaming*. Overall, Tomasulo's scheme combines scoreboarding and register renaming. *An Efficient Algorithm for Exploring Multiple Arithmetic Units*⁶ provides the complete details of Tomasulo's scheme.

Predicated Execution

Branch instructions are recognized as a major impediment to exploiting (ILP). Branches force the compiler and hardware to make frequent predictions of branch directions in an attempt to find sufficient parallelism. Misprediction of these branches can result in severe performance degradation through the introduction of wasted cycles into the instruction stream. Branch prediction strategies reduce this problem by allowing the compiler and hardware to continue processing instructions along the predicted control path, thus eliminating these wasted cycles.

Predicated execution support provides an effective means to eliminate branches from an instruction stream. Predicated execution refers to the conditional execution of an instruction based on the value of a Boolean source operand, referred to as the predicate of the instruction. This architectural support allows the compiler to use an *if-conversion* algorithm to convert conditional branches into predicate defining instructions, and instructions along alternative paths of each branch into predicated instructions.⁷ Predicated instructions are fetched regardless of their predicate value. Instructions whose predicate value is true are executed normally. Conversely, instructions whose predicate is false are nullified, and thus are prevented from modifying the processor state. Predicated execution allows the compiler to trade instruction fetch efficiency for the capability to expose ILP to the hardware along multiple execution paths.

Predicated execution offers the opportunity to improve branch handling in microprocessors. Eliminating frequently mispredicted branches may lead to a substantial reduction in branch prediction misses. As a result, the performance penalties associated with the eliminated branches are removed. Eliminating branches also reduces the need to handle multiple branches per cycle for wide issue processors. Finally, predicated execution provides an efficient interface for the compiler to expose multiple execution paths to the hardware. Without compiler support, the cost of maintaining multiple execution paths in hardware grows rapidly.

The essence of predicated execution is the ability to suppress the modification of the processor state based upon some execution condition. Full predication cleanly supports this through a combination of instruction set and microarchitecture extensions. These extensions can be classified as a support for suppression of execution and expression of condition. The result of the condition, which determines if

TABLE 42.1 Predicate Definition Truth Table

| P_{in} | Comparison | P_{out} | | | | | |
|----------|------------|-----------|-----------|------|-----------------|-------|------------------|
| | | U | \bar{U} | OR | \overline{OR} | AND | \overline{AND} |
| 0 | 0 | 0 | 0 | — | — | — | — |
| 0 | 1 | 0 | 0 | — | — | — | — |
| 1 | 0 | 0 | 1 | — | 1 | 0 | — |
| 1 | 1 | 1 | 0 | 1 | — | — | 0 |

an instruction should modify the state, is stored in a set of 1-bit registers. These registers are collectively referred to as the predicate register file. The values in the predicate register file are associated with each instruction in the extended instruction set through the use of an additional source operand. This operand specifies which predicate register will determine whether the operation should modify the processor state. If the value in the specified register is 1, or true, the instruction is executed normally; if the value is 0, or false, the instruction is suppressed.

Predicate register values may be set using predicate define instructions. The predicate define semantics used are those of the HPL Playdoh architecture.⁸ There is a predicate define instruction for each comparison opcode in the original instruction set. The major difference with conventional comparison instructions is that these predicate defines have up to two destination registers and that their destination registers are predicate registers. The instruction format of a predicate define is shown below.

$$pred_ <cmp> Pout1_{<type>}, Pout2_{<type>}, scr1, scr2(P_{in})$$

This instruction assigns values to $Pout1$ and $Pout2$ according to a comparison of $src1$ and $src2$ specified by $<cmp>$. The comparison $<cmp>$ can be: equal (eq), not equal (ne), greater than (gt), etc. A predicate $<type>$ is specified for each destination predicate. Predicate defining instructions are also predicated, as specified by P_{in} .

The predicate $<type>$ determines the value written to the destination predicate register based upon the result of the comparison and of the input predicate, P_{in} . For each combination of comparison result and P_{in} , one of the three following actions may be performed on the destination predicate: it can write 1, write 0, or leave it unchanged. There are six predicate types which are particularly useful, the unconditional (U), OR , and AND type predicates and their complements. Table 42.1 contains the truth table for these predicate definition types.

Unconditional destination predicate registers are always defined, regardless of the value of P_{in} and the result of the comparison. If the value of P_{in} is 1, the result of the comparison is placed in the predicate register (or its complement for \bar{U}). Otherwise, a 0 is written to the predicate register. Unconditional predicates are utilized for blocks, which are executed based on a single condition.

The OR -type predicates are useful when execution of a block can be enabled by multiple conditions, such as logical AND (&&) and OR (||) constructs in C. OR -type destination predicate registers are set if P_{in} is 1 and the result of the comparison is 1 (0 for \overline{OR}); otherwise, the destination predicate register is unchanged. Note that OR -type predicates must be explicitly initialized to 0 before they are defined and used. However, after they are initialized, multiple OR -type predicate defines may be issued simultaneously and in any order on the same predicate register. This is true since the OR -type predicate either writes a “1” or leaves the register unchanged, which allows implementation as a wired logical OR condition. AND -type predicates are analogous to the OR type predicate. AND -type destination predicate registers are cleared if P_{in} is 1 and the result of the comparison is 0 (1 for AND); otherwise, the destination predicate register is unchanged.

Figure 42.11 contains a simple example illustrating the concept of predicated execution. Figure 42.11(a) shows a common programming “if-then-else” construction. The related control flow representation of that programming code is illustrated in Fig. 42.11(b). Using if-conversion, the code in Fig. 42.11(b) is then transformed into the code shown in Fig. 42.11(c). The original conditional branch is translated into

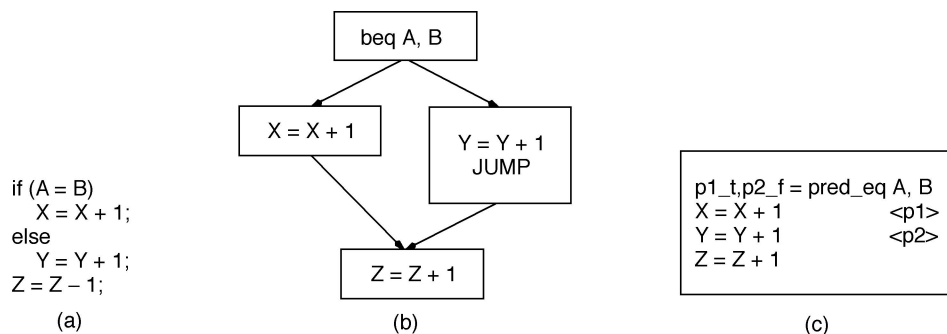

FIGURE 42.11 Instruction sequence: (a) program code, (b) traditional execution, (c) predicated execution.

pred_eq instructions. Predicate register *p1* is set to indicate if the condition ($A = B$) is true, and *p2* is set if the condition is false. The “then” part of the if-statement is predicated on *p1* and the “else” part is predicated on *p2*. The *pred_eq* simply decides whether the addition or subtraction instruction is performed and ensures that one of the two parts is not executed. There are several performance benefits for the predicated code. First, the microprocessor does not need to make any branch predictions since all the branches in the code are eliminated. This removes related penalties due to misprediction branches. More importantly, the predicated instructions can utilize multiple instruction execution capabilities of modern microprocessors and avoid the penalties for mispredicting branches.

Speculative Execution

The amount of ILP available within basic blocks is extremely limited in non-numeric programs. As such, processors must optimize and schedule instructions across basic block code boundaries to achieve higher performance. In addition, future processors must contend with both long latency load operations and long latency cache misses. When load data is needed by subsequent dependent instructions, the processor execution must wait until the cache access is complete.

In these situations, out-of-order machines dynamically reorder the instruction stream to execute non-dependent instructions. Additionally, out-of-order machines have the advantage of executing instructions that follow correctly predicted branch instructions. However, this approach requires complex circuitry at the cost of chip die space. Similar performance gains can be achieved using static compile-time speculation methods without complex out-of-order logic. Speculative execution, a technique for executing an instruction before knowing its execution is required, is an important technique for exploiting ILP in programs. Speculative execution is best known for hiding memory latency. These methods utilize instruction set architecture support of special speculative instructions.

A compiler utilizes speculative code motion to achieve higher performance in several ways. First, in regions of code where insufficient ILP exists to fully utilize the processor resources, useful instructions may be executed. Second, instructions at the beginning of long dependence chains may be executed early to reduce the computation’s critical path. Finally, long latency instructions may be initiated early to overlap their execution with other useful operations. Figure 42.12 illustrates a simple example of code before and after a speculative compile-time transformation is performed to execute a load instruction above a conditional branch.

Figure 42.12(a) shows how the branch instruction and its implied control flow define a control dependence that restricts the load operation from being scheduled earlier in the code. Cache miss latencies would halt the processor unless out-of-order execution mechanisms were used. However, with speculation support, Fig. 42.12(b) can be used to hide the latency of the load operation.

The solution requires the load to be speculative or nonfaulting. A speculative load will not signal an exception for faults such as address alignment or address space access errors. Essentially, the load is considered silent for these occurrences. The additional check instruction in Fig. 42.12(b) enables these

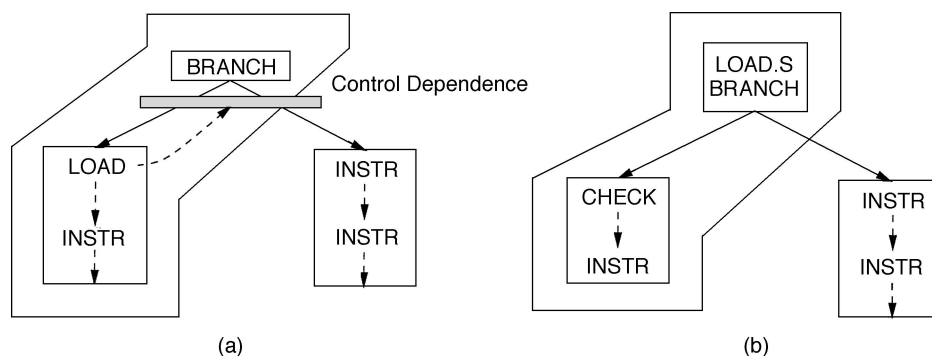

FIGURE 42.12 Instruction sequence: (a) traditional execution, (b) speculative execution.

signals to be detected when the original execution does reach the original location of the load. When the other path of branch's execution is taken, such silent signals are meaningless and can be ignored. Using this mechanism, the load can be placed above all existing control dependences, providing the compiler with the ability to hide load latency. Details of compiler speculation can be found in Ref. 9.

42.6 Industry Trends

The microprocessor industry is one of the fastest moving industries today. Healthy demands from the market have stimulated strong competition, which, in turn, have resulted into great technical innovations.

Computer Microprocessor Trends

The current trends in computer microprocessors include deep pipelining, high clock frequency, wide instruction issue, speculative and out-of-order execution, predicated execution, natural data types, large on-chip caches, floating point capabilities, and multiprocessor support. In the area of pipelining, the Intel Pentium II processor is pipelined approximated twice as deeply as its predecessor Pentium. The deep pipeline has allowed the clock Pentium II processor to run at a much higher clock frequency than Pentium.

In the area of wide instruction issue, the Pentium II processor can decode and issue up to three X86 instructions per clock cycle, compared to the two-instruction issue bandwidth of Pentium. Pentium II has dedicated a very significant amount of chip area to branch target buffer, reservation station, and reorder buffer to support speculative and out-of-order execution. These structures together allow the Pentium II processor to perform much more aggressive, speculative, and out-of-order executions than Pentium. In particular, Pentium II can coordinate the execution of up to 40 X86 instructions, which is several times larger than Pentium.

In the area of predicated execution, Pentium II supports a conditional move instruction that was not available in Pentium. This trend is furthered by the next generation IA-64 architecture where all instructions can be conditionally executed under the control of predicate registers. This ability will allow future microprocessors to execute control intensive programs much faster than their predecessors.

In the area of data types, the MMX instructions from Intel have become a standard feature of all X86 microprocessors today. These instructions take advantage of the fact that multimedia data items are typically represented with a smaller number of bits (8–16 bits) than the width of an integer data path today (32–64 bits). Based on an observation, the same operation is often repeated on all data items in multimedia applications—the architects of MMX specify that each MMX instruction performs the same operation on several multimedia data items packed into one integer word. This allows each MMX instruction to process several data items simultaneously to achieve significant speed-up in targeted applications. In 1998, AMD proposed the 3DNow! instructions to address the performance needs of 3-D

graphics applications. The 3DNow! instructions are designed based on the concept that 3-D graphics data items are often represented in single precision floating-point format and they do not require the sophisticated rounding and exception handling capabilities specified in the IEEE Standard format. Thus, one can pack two graphics floating-point data into one double-precision floating-point register for more efficient floating-point processing of graphics applications. Note that MMX and 3DNow! are similar in concepts applied to integer and floating-point domains.

In the area of large on-chip caches, the popular strategies used in computer microprocessors are either to enlarge the first-level caches or to incorporate second-level and sometimes third-level caches on-chip. For example, the AMD K7 microprocessor has a 64-KB first-level instruction cache and a 64-KB first-level data cache. These first-level caches are significantly larger than those found in the previous generations. For another example, the Intel Celeron microprocessor has a 128-KB second level combined instruction and data cache. These large caches are enabled by the increased chip density that allows many more transistors on the chip. The Compaq Alpha 21364 microprocessor has both: a 64-KB first-level instruction cache, a 64-KB first-level data cache, and a 1.5-MB second-level combined cache.

In the area of floating-point capabilities, computer microprocessors, in general, have a much stronger floating-point performance than their predecessors. For example, the Intel Pentium II processor achieves several times the floating-point performance improvements of the Pentium processor. For another example, most RISC microprocessors now have floating-point performances that rival supercomputer CPUs built just a few years ago.

Due to the increasing demand of multiprocessor enterprise computing servers, many computer microprocessors now seamlessly support cache coherence protocols. For example, the AMD K7 microprocessor provides direct support for seamless multiprocessor operation when multiple K7 microprocessors are connected to a system bus. This capability was not available in its predecessor, the AMD K6.

Embedded Microprocessor Trends

There are three clear trends in embedded microprocessors. The first trend is to integrate a DSP core with an embedded CPU/controller core. Embedded applications increasingly require DSP functionalities such as data encoding in disk drives and signal equalization for wireless communications. These functionalities enhance the quality of services of their end computer products. At the *1998 Embedded Microprocessor Forum*, ARM, Hitachi, and Siemens all announced products with both DSP and embedded microprocessors.¹⁰

Three approaches exist in the integration of DSP and embedded CPUs. One approach is to simply have two separate units placed on a single chip. The advantage of this approach is that it simplifies the development of the microprocessor. The two units are usually taken from existing designs. The software development tools can be directly taken from each unit's respective software support environments. The disadvantage is that the application developer needs to deal with two independent hardware units and two software development environments. This usually complicates software development and verification.

An alternative approach to integrating DSP and embedded CPUs is to add the DSP as a co-processor of the CPU. This CPU fetches all instructions and forwards the DSP instructions to the co-processor. The hardware design is more complicated than the first approach due to the need to more closely interface the two units, especially in the area of memory accesses. The software development environment also needs to be modified to support the co-processor interaction model. The advantage is that the software developers now deal with a much more coherent environment.

The third approach to integrating DSP and embedded CPUs is to add DSP instructions to a CPU instruction set architecture. This usually requires brand-new designs to implement the fully integrated instruction set architecture.

The second trend in embedded microprocessors is to support the development of single-chip solutions for large-volume markets. Many embedded microprocessor vendors offer designs that can be licensed and incorporated into a larger chip design that includes the desired I/O peripheral devices and application-specific integrated circuit (ASIC) design. This paradigm is referred to as system-on-a-chip design. A microprocessor that is designed to function in such a system is often referred to as a licensable core.

The third major trend in embedded microprocessors is aggressive adoption of high-performance techniques. Traditionally, embedded microprocessors are slow to adopt high-performance architecture and implementation techniques. They also tend to reuse software development tools, such as compilers from the computer microprocessor domain. However, due to the rapid increase of required performance in embedded markets, the embedded microprocessor vendors are now making fast moves in adopting high-performance techniques. This trend is especially clear in the DSP microprocessors. Texas Instruments, Motorola/Lucent, and Analog Devices have all announced aggressive EPIC DSP microprocessors to be shipped before the Intel/HP IA-64 EPIC microprocessors.

Microprocessor Market Trends

Readers who are interested in market trends for microprocessors are referred to *Microprocessor Report*, a periodical publication by MicroDesign Resources (www.MDRonline.com). In every issue, there is a summary of microarchitecture features, physical characteristics, availability, and pricing of microprocessors.

References

1. Turley, J., RISC volume gains but 68K still reigns, *Microprocessor Report*, vol. 12, pp. 14–18, Jan. 1998.
2. Hennessy, J.L. and Patterson, D.A., *Computer Architecture A Quantitative Approach*, Morgan Kaufman, San Francisco, CA, 1990.
3. Smith, J.E., A study of branch prediction strategies, *Proceedings of the 8th International Symposium on Computer Architecture*, pp. 135–14, May 1981.
4. Hwu, W.W. and Conte, T.M., The susceptibility of programs to context switching, *IEEE Transactions on Computers*, vol. C-43, pp. 993–1003, Sept. 1994.
5. Gwennap, L., Klamath extends P6 family, *Microprocessor Report*, Vol. 1, pp. 1–9, February 1997.
6. Tomasulo, R.M., An efficient algorithm for exploiting multiple arithmetic units, *IBM Journal of Research and Development*, vol. 11, pp. 25–33, Jan. 1967.
7. Allen, J.R. et al., Conversion of control dependence to data dependence, *Proceedings of the 10th ACM Symposium on Principles of Programming Languages*, pp. 177–189, Jan. 1983.
8. Kathail, V., Schlansker, M.S., and Rau, B.R., HPL PlayDoh architecture specification: Version 1.0, Tech. Rep. HPL-93-80, Hewlett-Packard Laboratories, Palo Alto, CA, Feb. 1994.
9. Mahlke, S.A. et al., Sentinel scheduling: a model for compiler-controlled speculative execution, *ACM Transactions on Computer Systems*, vol. 11, Nov. 1993.
10. *Embedded Microprocessor Forum* (San Jose, CA), Oct. 1998.

43

Control with Embedded Computers and Programmable Logic Controllers

Hugh Jack

Grand Valley State University

Andrew Sterian

Grand Valley State University

- 43.1 Introduction
- 43.2 Embedded Computers
 - Hardware Platforms • Hardware Interfacing • Programming Languages
- 43.3 Programmable Logic Controllers
 - Programming Languages • Interfacing • Advanced Capabilities
- 43.4 Conclusion

43.1 Introduction

Modern control systems include some form of computer, most often an embedded computer or programmable logic controller (PLC). An embedded computer is a microprocessor- or microcontroller-based system used for a specific task rather than general-purpose computing. It is normally hidden from the user, except for a control interface. A PLC is a form of embedded controller that has been designed for the control of industrial machinery. (See Fig. 43.1.)

A block diagram of a typical control system is shown in Fig. 43.2. The controller monitors a process with sensors and affects it with actuators. A user interface allows a user or operator to direct and monitor the control system. Interfaces to other computers are used for purposes such as programming, remote monitoring, or coordination with another controller.

When a computer is applied to a control application, there are a few required specifications. The system must always remain responsive and in control of the process. This requires that the control software be real-time so that it will respond to events within a given period of time, or at regular intervals. The systems are also required to fail safely. This is done with thermal monitoring for overheating, power level detection for imminent power loss, or with watchdog timers for unresponsive programs.

43.2 Embedded Computers

An embedded computer is a microprocessor- or microcontroller-based system designed for dedicated functionality in a specialized (i.e., nongeneral-purpose) electronic device. Common examples of embedded computers can be found in cell phones, microwave ovens, handheld computing devices, automotive systems, answering machines, and many other systems.

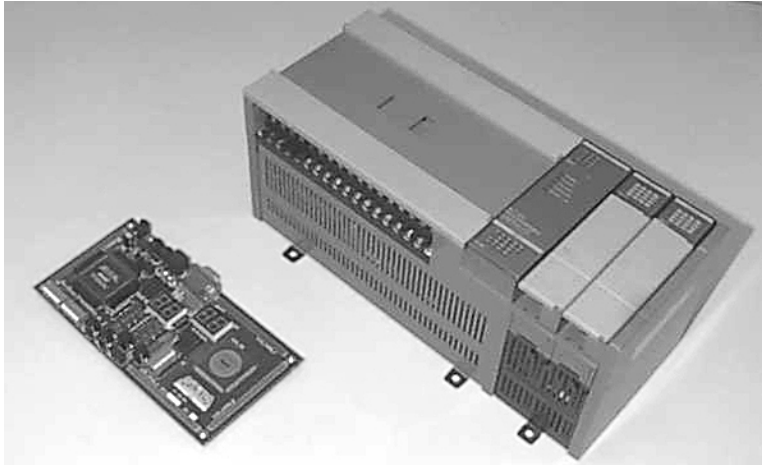

FIGURE 43.1 An embedded computer with an Altera FPGA (front-left) and an Allen Bradley SLC500 programmable logic controller (top-right).

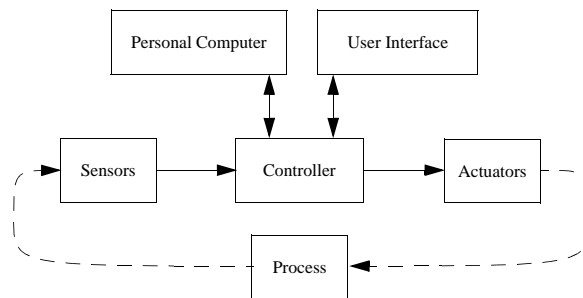

FIGURE 43.2 An example block diagram of a computer controlled application.

The design constraints and parameters for an embedded computer are usually different from those of a general-purpose computer. Although the latter is designed for maximum computing power and support for the latest interconnection and peripheral standards, an embedded computer is designed to be just powerful enough and to support only the interfaces and protocols that are specifically required. The constraints of an embedded computer design often include size, power consumption and heat dissipation, and cost.

Hardware Platforms

Microcontroller-Based Systems

Microcontrollers are closely related to the microprocessors that power today's general-purpose computers. They differ from microprocessors, in general, by being highly integrated, with built-in peripherals that minimize total system part count, having low power consumption, providing a small amount of on-chip RAM and ROM, and having several general-purpose input/output (I/O) lines available for instrument sensors and control. For this reason, a microcontroller-based embedded system may be designed with very few external components. In contrast, a microprocessor-based system requires external RAM, external peripherals, and I/O interfaces, and often dissipates so much heat that active cooling is required for proper operation.

The peripherals built into many microcontrollers include serial-line interfaces (such as RS232), timers, pulse generators, event counters, etc. These peripherals support many sensor and actuator control functions.

For example, pulse generators and timers can be used to construct stepper motor drive sequences. Microcontrollers are becoming increasingly specialized with respect to the data communication interfaces they support. While many support the ubiquitous RS232, SPI, and I²C protocols, recent microcontrollers have built-in support for interfaces such as USB.

In order to minimize power consumption, most microcontrollers have a special sleep or standby mode in which no instructions are executed and very little power is consumed. Microcontrollers can be programmed to awaken in response to an external event so that the program code is executed, and power consumed, only when necessary.

Microcontrollers are a very large semiconductor market due to the wide range and high volume of devices that use them. There are many manufacturers and models of microcontrollers, ranging from tiny 8-pin devices with minimal functionality and costing mere pennies, to large devices with hundreds of pins, many features, and much higher cost. This broad spectrum reflects the highly specific nature of an embedded computer and its design.

FPLD-Based Systems

Field-programmable logic devices (FPLDs) such as CPLDs (complex programmable logic devices) and FPGAs (field-programmable gate arrays) are a more recent alternative to microcontrollers for embedded computer design. An FPLD represents a programmable hardware device; the actual hardware functionality of the device is what is being designed. A microcontroller, in contrast, has fixed hardware functionality and is programmed with software. It is possible, however, to design an FPLD that behaves as a microcontroller, and is further programmed in software. The programmable hardware functionality, however, affords the designer a much greater degree of flexibility over a fixed hardware solution. The price for this flexibility, however, is complexity.

FPLDs may be designed from the ground up or may be composed of one or more predesigned core and peripheral blocks. It is possible, for example, to purchase microcontroller core functions, peripheral functions, etc. and assemble them to form a customized microcontroller on an FPLD with non-recurring engineering (NRE) costs that are much lower than a full custom chip design.

FPLDs can often be programmed “on-the-fly,” allowing for reconfigurable computing. This is a computing paradigm that reprograms a system at the hardware level while it is in operation, according to system demands. This means, for example, that the same hardware device can implement multiple bus protocols, interfaces, or algorithms as needed, rather than requiring a larger and more expensive device that supports all of the necessary functions but only uses one at a time.

Digital Signal Processing Systems

Digital signal processing (DSP) devices are in many ways similar to microcontrollers with respect to peripheral integration, power consumption, etc. but also have specialized hardware support for common DSP operations, such as filtering. DSP devices are ideal for use in systems that process speech and music, or for robust control and communications applications. The specialized hardware support of these devices means that they are capable of sustaining much higher effective computation rates (on signal processing tasks), but at the same clock speed and power dissipation as the more general-purpose microcontrollers.

Real-Time Systems

Most embedded systems must operate in *real time*, that is, they must respond in a timely fashion to external events such as user commands and sensor readings. When an absolute upper limit on response time is required (and guaranteed), the system is a *hard real-time system*; otherwise, it is a soft real-time system. Systems that have safety constraints, such as automotive and industrial control systems, are often hard real-time systems so that absolute maximum time delays can be computed and verified for safety-critical events.

Real-time computation is effected using *interrupts*. These are mechanisms supported by all common microcontrollers that cause a change in the flow of execution of the program when the interrupt occurs. The program that is executed in response to the interrupt is expected to respond in some way to the interrupt.

For example, an interrupt may occur when a digital logic level changes at a device pin, indicating a sensor condition, or it may occur when the user presses a button on a keypad, indicating that an action is desired and is to be performed immediately.

The implementation of a real-time software system may either be custom designed or may make use of a commercial real-time operating system (RTOS). Since the design of an interrupt-driven real-time system has many potential pitfalls, the usage of a mature RTOS can greatly speed development time.

Embedded Modules

The functionality of commercially available embedded computing modules has been steadily increasing. It is common to find powerful microcontrollers, an Ethernet interface, and basic Internet protocol support all combined in a very small form factor for less than \$50 in single quantities. This level of integration can greatly speed development time for network-enabled control or remote sensing applications.

Hardware Interfacing

Mechanical Switches

Switches are easily interfaced to digital logic with a resistor as shown in Fig. 43.3. The mechanical nature of the switch may lead to *bounce* or oscillation of the digital signal for a brief period during the switch opening/closing action. This bounce may be eliminated in the software or with a small amount of additional hardware.

Analog Inputs

Analog inputs that indicate one of the two conditions can be interfaced to a digital logic input with a simple comparator (Fig. 43.4). A threshold voltage is set with a resistor divider. The comparator generates a digital signal, which indicates whether the analog input voltage is above or below the threshold voltage. This approach can be used for sensors such as optical interrupters (for part counting, motor movement detection, etc.), temperature limit sensors, and many others.

When the analog voltage itself is of interest (as in, for example, temperature measurements), an analog-to-digital converter (ADC) can be used to provide either a serial or a parallel representation of the voltage with a precision ranging anywhere from 8 bits to 16 bits and above. A serial ADC may require as few as two digital I/O pins on a microcontroller for transferring data, while a parallel ADC requires at least as

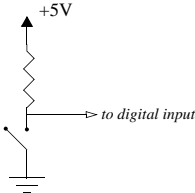

FIGURE 43.3 A mechanical switch is easily interfaced to a digital input on a microcontroller using a single resistor.

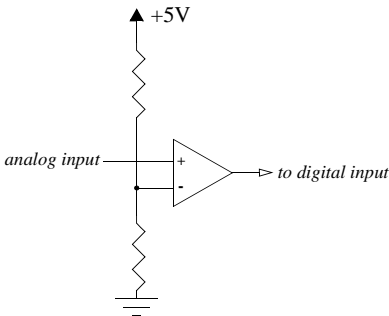

FIGURE 43.4 A digital input driven by a comparator detects whether an analog voltage signal is above or below a threshold voltage (set with a resistor divider network).

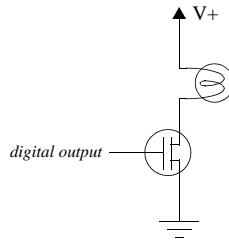

FIGURE 43.5 A digital output can control a high-current device (such as a lamp pictured to the right) using a transistor as a switch.

many pins as there are bits of resolution, but can transfer an entire analog reading in one transaction for faster throughput.

Some microcontrollers have built-in ADC peripherals with multiple input channels enabling highly integrated low-cost analog sensor systems.

Analog voltages that are very small may be amplified with an instrumentation amplifier prior to analog-to-digital conversion. Instrumentation amplifiers have very high gain and high impedance, and hence, are suitable for sensors with very weak driving voltages and currents.

Simple Actuators

Embedded computers are not usually capable of driving most practical actuators directly, since the latter often require voltages and currents not compatible with digital circuitry. As with sensors, however, some simple interface circuitry is all that is required. Simple on/off actuators such as lamps, LEDs, relay coils, etc. can be driven from a digital output, using a transistor as a switch, as shown in Fig. 43.5. The digital output controls the on/off state of the transistor, which, in turn, either allows or does not allow current to flow through the actuator.

Motors can also be controlled using transistors as interfaces between digital outputs and the high-current motor coils. The lamp in Fig. 43.5 can be replaced with a DC motor to allow simple on/off control of the motor. A set of four transistors arranged in an H-bridge configuration allows such a motor to rotate in either direction. Two H-bridge configurations can be used to control a stepper motor. In all cases, the speed and direction of rotation are under direct control of the embedded computer through its digital outputs.

Analog Outputs

For actuators that require a variable analog voltage or current, a digital-to-analog converter (DAC) can be used as an interface between the embedded computer and the actuator. As with ADCs, DACs are available in a variety of bit widths, conversion speeds, number of channels, etc. Often, the current driving capacity of these devices is not sufficient and an additional buffer amplifier is required to meet the current demands of the actuator.

Programming Languages

Embedded computers are most commonly programmed in low-level languages for maximum control over the hardware resources. The most time-critical sections of the code are generally programmed in assembly language, which is the lowest-level language understood by a microcontroller. The C language is generally used for higher-level structured programming. Even higher-level languages, such as C++ or Java, are not well suited for embedded programming as they require larger amounts of memory and are not designed for low-level access to hardware resources.

Figure 43.6 shows a fragment of an assembly language program written for the Microchip PIC 16F84A microcontroller. It enables power to a DC motor (through an external interface circuit) when two digital inputs are both at a logic 1 level. The code runs continuously, always checking for the status of the two digital inputs (which may be manual switches, current sensors, etc.).

The same code fragment written in C is shown in Fig. 43.7. The code is more compact and easier to read since C is a higher-level language than assembly.

| | | |
|----------|---------|---|
| loop: | | |
| btfss | PORTA,0 | Check digital input bit 0 of Port A |
| goto | turnoff | and disable motor if not 1 |
| btfss | PORTA,1 | Check digital input bit 1 of Port A |
| goto | turnoff | and disable motor if not 1 |
| | | |
| bsf | PORTB,5 | Enable motor by setting bit 5 of Port B |
| goto | loop | and check inputs again |
| turnoff: | | |
| bcf | PORTB,5 | Disable motor by clearing bit 5 of Port B |
| goto | loop | and check inputs again |

FIGURE 43.6 Fragment of assembly code for Microchip PIC 16F84A microcontroller. This code fragment examines two digital inputs (bits 0 and 1 of input Port A) and sets bit 5 of output Port B if both inputs are at a logic 1 level. The output can be used to enable or disable a DC motor with appropriate interface circuitry.

```

while (1) {
    if (PA0 && PA1) { // Check status of bits 0 and 1 in Port A
        PB5 = 1;    // Set bit 5 of Port B
    } else {
        PB5 = 0;    // Clear bit 5 of Port B
    }
}

```

FIGURE 43.7 Fragment of C code to effect the same functionality as the code in [Fig. 43.6](#).

43.3 Programmable Logic Controllers

The modern programmable logic controller (PLC) is the successor of relay-based controls. The technological shift began in the 1960s, when the limitations of electromechanical relay-based controllers drove General Motors to search for electronic alternatives. The answer was provided in 1970 by Modicon, who provided a microprocessor-based control system. The programming language was modeled after relay ladder logic diagrams to ease the transition of designers, builders, and maintainers to these new controllers. Throughout the 1970s the technology was refined and proven, and since the early 1980s they have become ubiquitous on the factory floor.

Most PLC components are in card form that can be interchanged quickly in the event of a failure. A typical PLC application has about one hundred inputs and outputs, but the scale of the applications varies widely. A small PLC costing \$200 might have six inputs and four outputs. A large application might involve multiple PLCs working together over an entire plant and collectively have tens of thousands of inputs and outputs. In general, the aggregated cost of PLC hardware per input and output is approximately \$10–\$50. This does not include the cost of sensors (typically \$50–\$100), actuators (typically \$50–\$200), installation (typically \$10–\$100), design, or programming.

Manufacturing control systems always require logical control and sometimes continuous control. Logical control involves the examination of binary inputs (on or off) from sensors and setting binary outputs to drive actuators. A simple example is a photosensor that detects a box on a conveyor and actuates an air cylinder to divert the box. Continuous control systems are used less frequently because of their higher costs and increased complexity. A typical continuous controller might use an analog output card (\$1000) to output a voltage to a variable frequency motor driver (\$1000) to control the velocity of a conveyor.

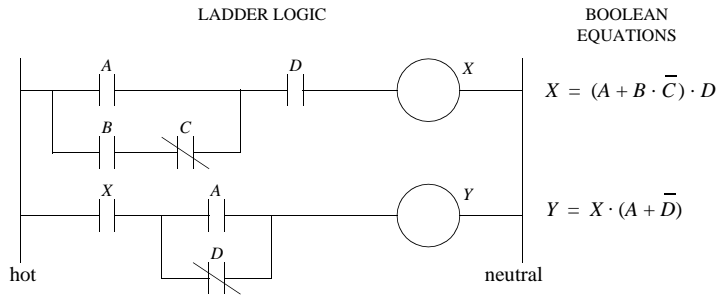

FIGURE 43.8 A simple ladder logic program with equivalent Boolean equations.

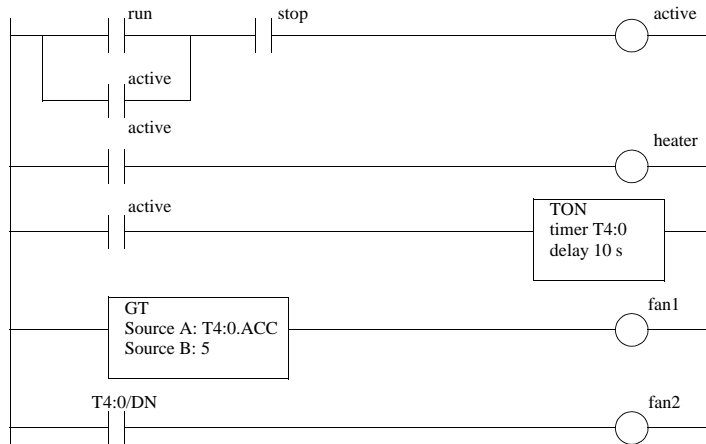

FIGURE 43.9 A complex ladder logic example.

Programming Languages

Every PLC can be programmed with ladder logic. Ladder logic uses input contacts (shown with two vertical lines) and output coils (shown with a circle). A contact with a slash through it represents a normally closed contact. In ladder logic, the left-hand rail is energized. When the contacts are closed in the right combinations, power can flow through the coil to the right-hand neutral rail.

Consider the ladder logic example in Fig. 43.8. It is assumed that the *hot* rail at the left side has power, and the right side rail is *neutral*. When the contacts are opened and closed in the right combinations they allow power to flow through the output coils, thus actuating them. The program logic is interpreted by working from the left side of the ladder. In the first rung if *A* and *D* are on, the output *X* will be turned on. This can also be accomplished by turning *B* on, turning *C* off, and turning *D* on. In the second, the output *Y* will be on if *X* is on and *A* is on, or *D* is off. Notice that the branches behave as OR functions and the contacts in line act as an AND function. It is possible to write ladder logic rungs as Boolean equations, as shown on the right-hand side of the figure.

The example in Fig. 43.8 contains only conditional logic, but Fig. 43.9 shows a more complex example of a ladder logic program that uses timers and memory values. When the *run* input is active, output *heater* will turn on, 5 s later *fan1* will turn on, followed by *fan2* at 10 s. The first rung of the program will allow the system to be started with a normally open *run* push button input, or stopped with a normally closed push button *stop*. All stop inputs are normally closed switches, so the contact in this rung needs to be normally open to reverse the logic. The output *active* is also used to branch around the *run* to seal-in the run state. The next line of ladder logic turns on an output *heater* when the system is active. The third

line will run a timer when *active* is on. When the input to the *TON* timer goes on, the timer *T4:0* will begin counting, and the timer element *T4:0.ACC* will begin to increment until the delay value of 10 s is reached, at this point the timer done bit *T4:0/DN* bit will turn on and stay on until the input to the timer is turned off. The fourth rung will compare the accumulated time of the timer and if it is greater than 5 the output *fan1* will be turned on. The final rung of the program will turn on *fan2* after the timer has delayed 10 s.

A PLC scans (executes) a ladder logic program many times per second. Typical execution times range from 5 to 100 ms. Faster execution times are required for processes operating at a higher speed.

The notations and function formats used in Fig. 43.9 are based on those developed by a PLC manufacturer. In actuality, every vendor has developed a different version of ladder logic.

IEC 61131-3 Programming Languages

The IEC 61131 standards (formerly IEC 1131) have been created to unify PLCs [3,5]. The major portions of the standard are listed below.

- IEC 61131-1 Overview
- IEC 61131-2 Requirements and Test Procedures
- IEC 61131-3 Data Types and Programming
- IEC 61131-4 User Guidelines
- IEC 61131-5 Communications
- IEC 61131-7 Fuzzy Control

The most popular part of the standard is the programming specification, IEC 61131-3. It describes five basic programming models including ladder diagrams (LD), instruction list (IL), structured text (ST), sequential function charts (SFC), and function block diagrams (FBD). These languages have been designed to work together. It is possible to implement a system using a combination of the languages, or to implement the same function in different languages. A discussion of ST, SFC, and FBD programs follows.

Structured Text

A structured text program is shown in Fig. 43.10. This program has the same function as the previous ladder logic example. The first line defines the program name. This is followed by variable definitions. The variables *run* and *stop* are inputs to the controller from sensors and switches. The variables *heater*,

```

PROGRAM example
VAR_INPUT
    run : BOOL ;
    stop : BOOL ;
END_VAR
VAR_OUTPUT
    heater : BOOL ;
    fan1 : BOOL ;
    fan2 : BOOL ;
END_VAR
VAR
    active : BOOL ;
    delay : TON ;
END_VAR
active := (run OR active) & stop ;
heater := active ;
delay(EN := active, PRE := 10) ;
IF ( delay.ACC > 5 ) THEN
    fan1 := 1 ;
ELSE
    fan1 := 0 ;
END_IF ;
fan2 := delay.DN ;
END_PROGRAM

```

FIGURE 43.10 A structured text program equivalent to Fig. 43.9.

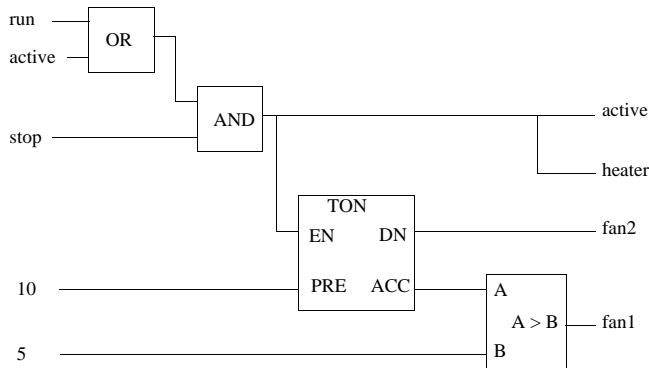

FIGURE 43.11 A FBD program equivalent to Fig. 43.9.

fan1, and *fan2* are outputs to the actuators in the system. The variables *active* and *delay* are internal to the program only.

The program section immediately follows the variable declarations. In the program the first two lines set the values of *active* and *heater*. The instruction *delay(...)* calls the instantiated timer. The argument *EN := active* sets the timer to run, and *PRE := 10* sets the timer delay to 10 s. The following lines use an “if” statement to set the value of *fan1*, using the accumulated timer value *delay.ACC*. The value of *fan2* is then set when the timer accumulator has reached the delay time and set the done bit *delay.DN*.

Structured text is popular and shows potential for eventually replacing ladder logic as the most popular programming language.

Function Block Diagrams

A data flow model is the basis of function block diagrams. In these programs, the data flows from the inputs on the left to the outputs on the right. The example in Fig. 43.11 is equivalent to the previous ladder logic example. The *OR* and *AND* functions are used to set the values of *active* and *heater*. The *TON* timer uses the enable *EN* and delay *PRE* inputs to drive the accumulator *ACC* and *DN* outputs. The *DN* output drives *fan2* while the *ACC* value is compared to the value of 5 to set the output *fan1*.

Data flow diagrams can be very useful for doing a high-level design of a control system.

Sequential Function Charts

An SFC is used to describe a system in terms of *steps* and *transitions*. A step describes a mode of operation or state in which some *action* is performed, normally setting outputs. Transitions determine the change of states, normally by examining inputs. (Note: Some readers may notice that SFCs are based on Petri nets.)

Figure 43.12 shows an example of an SFC to control storage tanks. When the controller is started and the *power* input goes true, it will empty the tanks. After that the *run* input will start cycles where both the tanks are filled and then emptied repeatedly.

In this example, the flow of control begins at the initial step *start*, and then moves to step *S1*. The action associated with the step is *R*, which will reset, or turn off the outputs *in_valve1* and *in_valve2*. The system will remain in step *S1* until the transition is fired by input *power*. After this there are two possible paths. If *empty1* and *empty2* are both true, the left-hand branch will be followed, otherwise the right-hand transition will fire and that branch will be followed. The left-hand branch sets the *run_light* on (with *S*), and turns off the *outlet_valve*. The right-hand branch will turn on *outlet_valves* until the inputs *empty1* and *empty2* are both on. At that point *run_light* will be turned on, and the *out_valves* turned off. Regardless of which branch was followed, the flow of execution will pause at the following transition until the input *run* becomes true.

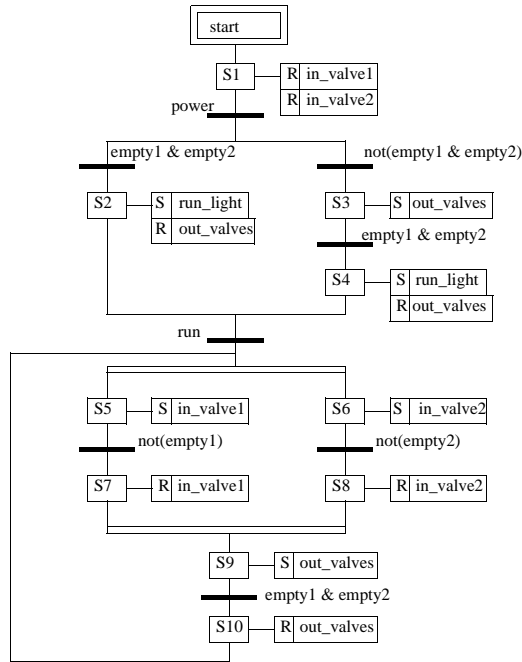

FIGURE 43.12 An SFC program for tank level control.

After the *run* transition is fired the flow of execution splits into both the left and right branches, as indicated by the two horizontal lines. The left branch fills one tank, while the right branch fills the other tank independently. When both branches are complete the flow of execution rejoins at the second set of horizontal lines, and then activates step *S9*. After step *S10* the flow of execution returns to the point after the *run* transition.

The SFC programming method differs from other programming methods in that the program is not expected to run completely in a single scan, while all others must run completely in each scan.

Interfacing

The installation and interfacing requirements for PLCs are driven by the need to protect people and equipment by failing safely. A typical wiring diagram for a PLC application is shown in Fig. 43.13. At the top of the diagram a transformer is used to step down a higher supply voltage. This is immediately followed by a power disconnect and fuses. The power is then split into left and right rails, much like the ladder diagrams discussed earlier. Line 10 shows a master power control for the system. This includes a normally open start button and a normally closed stop button. These switches control a master control relay (MCR) *C1*. Notice that if power is supplied to the coil *C1*, it will close the contacts *C1* on the same run and hold *C1* on until the stop button is pushed. Another set of contacts is used on the left rail to disconnect power from the inputs to the PLC and the DC power supply. This control circuitry external to the PLC is required so that the stop buttons of a control system are able to directly disconnect the power. This is often required by law.

In this example the PLC is powered with 120 V AC, connected between the power rails. There are two 120 V AC inputs from normally open push buttons. The 24 V DC power supply is input to the *V+* on the output terminals of the PLC, which will then switch output power to solenoid *S1* and indicator light *L1*.

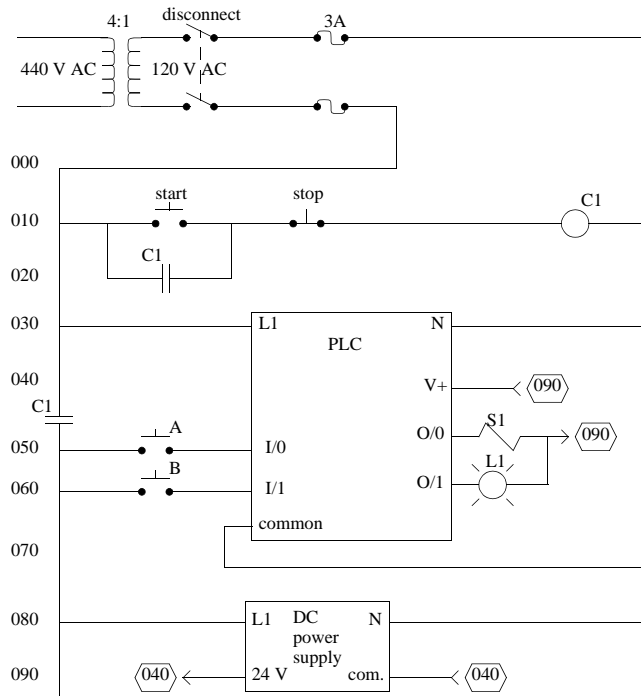

FIGURE 43.13 A PLC wiring example.

Advanced Capabilities

PLCs are often used in applications that go beyond basic logic solving. Some advanced programming and input/output (I/O) functions are listed below.

Calculations—The ability to do basic scientific calculations. Lower end PLCs only use integer math, while higher end PLCs also provide floating point math.

Analog I/O—Continuous voltage and current values can be input and output.

Feedback control—Proportional integral derivative (PID) controller calculations are provided as function blocks and can be used with analog I/O.

Communications—The ability to transmit data as strings over serial ports or to transfer parts of the PLC memory using proprietary protocols.

ASCII strings—Functions to manipulate ASCII strings.

System—Fault detection, status monitoring, interrupt routines, etc.

Fuzzy logic—Some PLCs include fuzzy set functions for nonlinear control problems.

At a minimum PLCs use communications for programming. But in many applications PLCs are used to communicate with other devices. In the past, most communications were based on proprietary, or closed, standards. More recently a few open communication standards have been developed and are supported by many vendors; these include Profibus, DeviceNet, CanBus, and ModBus. There has also been a trend to use more universal communication standards such as RS-232, RS-422, RS-485, and Ethernet. An example of an automation system is shown in Fig. 43.14. An RS-232 connection is used between a laptop computer (e.g., COM1) and PLC1 for programming. DH+ is used to connect PLC1, PLC2, and the HMI; it is a proprietary communication standard developed by Allen-Bradley. An operator can use the Human Machine Interface (HMI) to display data and accept operator input and communicate these values directly to both PLCs. Devicenet, an open automation standard, is used to connect PLC2 to a welding controller.

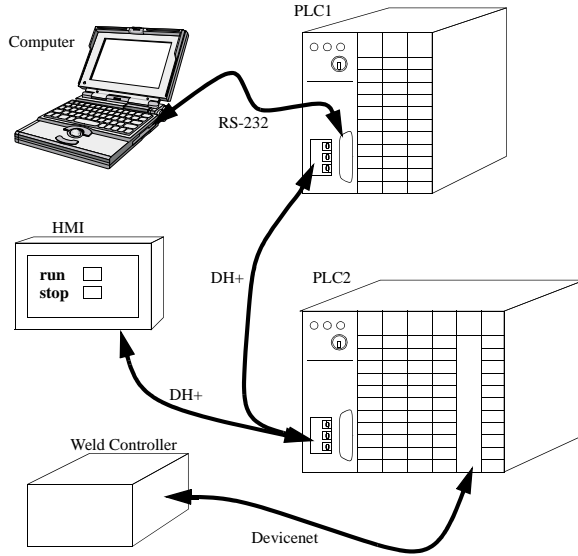

FIGURE 43.14 PLC communication example.

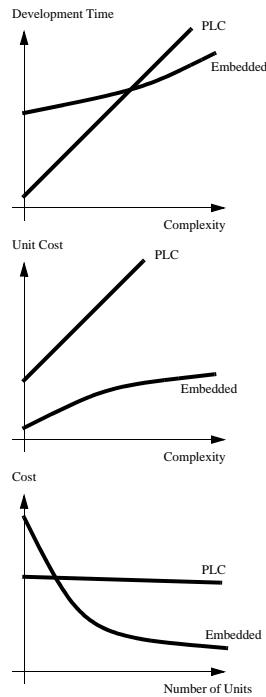

FIGURE 43.15 Relative trade-offs between control solutions.

43.4 Conclusion

PLCs and embedded controllers are complementary technologies and, when applied strategically, they will both provide low cost and reliable solutions to control problems. Figure 43.15 shows the relative trade-offs between the controllers. In general, an embedded controller requires more initial development time than a PLC for a simple system. As the system grows more complex, the embedded controller benefits

from the existence of software libraries and design tools. When using a PLC the cost of the purchased hardware will always be higher per unit. The development costs for an embedded computer will usually be higher, but these become minimal when amortized over a large number of units. As a result, embedded controllers are typically selected for applications that will be mass-produced and allow a greater development time, such as a toy robot. PLCs are often selected for applications that only require a few controllers and are to be completed in a relatively short time, such as the production machines to make a toy.

References

1. Bryan, L.A., Bryan, E.A., *Programmable Controllers*, Industrial Text and Video Company, 1997.
2. Filer, R., Leinonen, G., *Programmable Controllers and Designing Sequential Logic*, Saunders College Publishing, 1992.
3. Lewis, R.W., *Programming Industrial Control Systems using IES1131-3*, The Institution of Electrical Engineers, 1998.
4. Petruzella, E., *Programmable Logic Controllers*, Second Edition, McGraw-Hill, 1998.
5. *Programmable Controllers—Part 3: Programming Languages*, IEC 61131-3 Ed. 1.0, 1993.
6. Stenerson, J., *Fundamentals of Programmable Logic Controllers, Sensors and Communications*, Prentice-Hall, 1998.
7. Webb, J.W., Reis, R.A., *Programmable Logic Controllers, Principles and Applications*, Prentice-Hall, 1995.

VI

Software and Data Acquisition

- 44 **Introduction to Data Acquisition** *Jace Curtis*
- 45 **Measurement Techniques: Sensors and Transducers** *Cecil Harrison*
Introduction • Motion and Force Transducers • Process Transducers • Transducer Performance • Loading and Transducer Compliance
- 46 **A/D and D/A Conversion** *Mike Tyler*
Introduction • Sampling • ADC Specifications • DAC Specifications
- 47 **Signal Conditioning** *Stephen A. Dyer*
Linear Operations • Nonlinear Operations
- 48 **Computer-Based Instrumentation Systems** *Kris Fuller*
The Power of Software • Digitizing the Analog World • A Look Ahead
- 49 **Software Design and Development** *Margaret H. Hamilton*
The Notion of Software • The Nature of Software Engineering • Development Before the Fact • Experience with DBTF • Conclusion
- 50 **Data Recording and Logging** *Tom Magruder*
Overview • Historical Background • Data Logging Functional Requirements • Data-Logging Systems • Conclusions

44

Introduction to Data Acquisition

Jace Curtis

National Instruments, Inc.

The purpose of a data acquisition system is to capture and analyze some sort of physical phenomenon from the real world. Light, temperature, pressure, and torque are a few of the many different types of signals that can interface to a data acquisition system. A data acquisition system may also produce electrical signals simultaneously. These signals can either intelligently control mechanical systems or provide a stimulus so that the data acquisition system can measure the response. A data acquisition system provides a way to empirically test designs, theories, and real world systems for validation or research. [Figure 44.1](#) illustrates a typical computer-based data acquisition module.

The design and the production of a modern car, for instance, relies heavily on data acquisition. Engineers will first use data acquisition to test the design of the car's components. The frame can be monitored for mechanical stress, wind noise, and durability. The vibration and temperature of the engine can be acquired to evaluate the design quality. The researchers and engineers can then use this data to optimize the design of the first prototype of the car. The prototype can then be monitored under many different conditions on a test track while information is collected through data acquisition. After a few iterations of design changes and data acquisition, the car is ready for production. Data acquisition devices can monitor the machines that assemble the car, and they can test that the assembled car is within specifications.

At first, data acquisition devices stood alone and were manually controlled by an operator. When the PC emerged, data acquisition devices and instruments could be connected to the computer through a serial port, parallel port, or some custom interface. A computer program could control the device automatically and retrieve data from the device for storage, analysis, or presentation. Now, instruments and data acquisition devices can be integrated into a computer through high-speed communication links, for tighter integration between the power and flexibility of the computer and the instrument or device.

Since data acquisition devices acquire an electric signal, a transducer or a sensor must convert some physical phenomenon into an electrical signal. A common example of a transducer is a thermocouple. A thermocouple uses the material properties of dissimilar metals to convert a temperature into a voltage. As the temperature increases, the voltage produced by the thermocouple increases. A software program can then convert the voltage reading back into a temperature for analysis, presentation, and data logging. Many sensors produce currents instead of voltages. A current is often advantageous because the signal will not be corrupted by small amounts of resistance in the wires connecting the transducer to the data acquisition device. A disadvantage of current-producing transducers, though, is that most data acquisition devices measure voltage, not current. Generally, the data acquisition devices that can measure current use a very small resistance of a known value to convert the known current into a readable voltage. Ultimately, the device is then still acquiring a voltage.



FIGURE. 44.1

Analog signals for data acquisition can be grouped into two basic classes: random and deterministic. Data acquisition devices can both acquire and generate these types of signals. Random signals never repeat and have a flat frequency spectrum. Microphone static is an example of a random signal. A deterministic signal, unlike random signals, can be represented by a sum of sinusoids. Deterministic signals can be subdivided into periodic and transient signals. Periodic signals constantly repeat the same shape at regular intervals over time, while transient signals start and end at a constant level and do not occur at regular intervals. Transient signals are nonperiodic events that represent a finite-length reaction to some stimulus.

Digital input and output are commonly incorporated into data acquisition hardware for sensing contacts, controlling relays and lights, and testing digital devices. The most commonly used digital levels are TTL and TTL-compatible CMOS. These are both very common 5-V standards for digital hardware. Digital transfer rates to and from the data acquisition hardware vary from unstrobed to high speed. Unstrobed digital input and output involves setting digital lines and monitoring states by software command. This form of digital input and output is also known as static or immediate digital I/O. The maximum speed of an unstrobed I/O is highly dependent on the computer hardware, the operating system, and the application program. Pattern digital I/O refers to inputs and outputs of digital patterns under the control of a clock signal. The speed at which the data can be sent or received depends on the amount of data, the characteristics of the data acquisition hardware, and the computer speed.

The final type of I/O on computer-based data acquisition hardware is counter/timer I/O. Counter/timers are capable of measuring or producing very time-critical digital pulses. These pulses, like the digital input and output, are generally TTL or TTL-compatible CMOS. These components are used for measuring or producing a number of time-critical signals including event counting, pulse train generation, frequency-shift keying, and monitoring quadrature encoders. The two main characteristics of a counter/timer are the counter size and maximum source frequency. The counter size is generally represented in bits and determines how high a counter can count. For instance, a 32-bit counter can count $2^{32} - 1 = 4,294,967,295$ events before it returns the count value back to zero. The maximum source frequency represents the speed of the fastest signal the counter can count. An 80-MHz counter can count events that are as fast as 12.5 ns apart. An “event” is actually the rising or falling edge of a digital signal.

No real situation will ever have perfect signals or be completely free of noise. Signal conditioning is a method to remove, as much as possible, unwanted components of a digital or analog signal. A real analog signal usually comprises both deterministic and random signals, and a digital signal is not going to be perfectly square. Measurement hardware, particularly for high-frequency analog signals, is usually equipped with an antialiasing filter. This is a low-pass filter that blocks frequencies above the desired frequency range and increases the accuracy of the measurements. Digital and counter/timer lines are also commonly fitted with filters that remove spikes from the signal that could otherwise be mistakenly

counted as a rising or falling edge. Isolation is another type of signal conditioning that separates the measurement hardware circuitry from the signal being measured. This is done to remove large differences in electric potential between the measurement hardware and the signal, and it protects the measurement hardware from damage, given a large surge in voltage or current.

The heart of a data acquisition device is a digital-to-analog converter (DAC), an analog-to-digital converter (ADC), or some combination of the two. An ADC has a finite list of values which represents voltages. The purpose of the ADC is to select a value from this list, which is closest to an actual voltage at a specified time. The value is then transferred in binary format to a computer. Alternatively, a DAC can produce an analog voltage from a list of binary values. The voltage generated by a basic DAC stays the same until it receives another value from the computer. In order to acquire and produce analog waveforms, the DAC and ADC must activate at precise intervals. Consequently, measurement hardware has timing circuitry to produce a pulse train of a constant frequency to control the ADC and DAC.

The data that is transferred from the ADC and to the DAC travels to the computer over a bus. A bus is a group of electrical conductors that transfer information inside a computer. Some common examples of a bus are PCI and USB. The bus can carry both control information and binary measurement data to and from measurement hardware. One of the most important considerations in selecting a bus is bus transfer rate, usually expressed in megabytes per second (Mbytes/s). A single analog value could require less than 1 byte or as much as 4 bytes, depending on the type of measurement hardware. The bus is shared among multiple devices, so data acquisition devices often have on-board memory to serve as a holding place for data when the bus is not available. In very fast data acquisition routines, the memory can hold all the data, and at the end of the acquisition, all the data can be transferred to the computer for processing.

When data is acquired at high speeds on multiple channels, it is often important to understand the phase relationship from one signal to the next. If the signals are generated or acquired on multiple data acquisition devices, there are a number of ways to synchronize the systems and preserve relative phase relationships. One way is to share the ADC and DAC clock between the data acquisition devices. The real-time system integration bus (RTSI) is a bus that can connect multiple devices together to share timing circuitry among multiple devices. Phase-lock looping (PLL) is a more sophisticated synchronization method. A reference signal is supplied to all the data acquisition devices, and the internal clocks stay in phase with the reference signal. Consequently, the phase relationship can be reserved even if different measurement hardware is using different sampling or update speeds. Figure 44.2 is a diagram showing the components of a typical data acquisition hardware.

The difference between an actual analog voltage and the closest voltage from the list of binary values is called the quantization error. In a perfect digitizing measurement system free of noise, the quantization error would solely explain any difference between the actual voltage and the measured voltage. No measurement hardware and no environment, however, are perfect. The accuracy of an instrument describes the amount of uncertainty when considering quantization error, unavoidable system noise, and hardware imperfections. Accuracy is sometimes confused with precision. Precision refers to the amount of deviation in multiple measurements connected to a constant and level signal source. Even if an instrument is

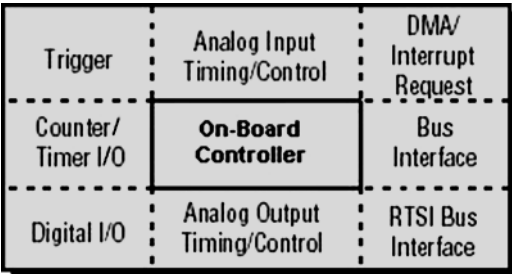

FIGURE 44.2

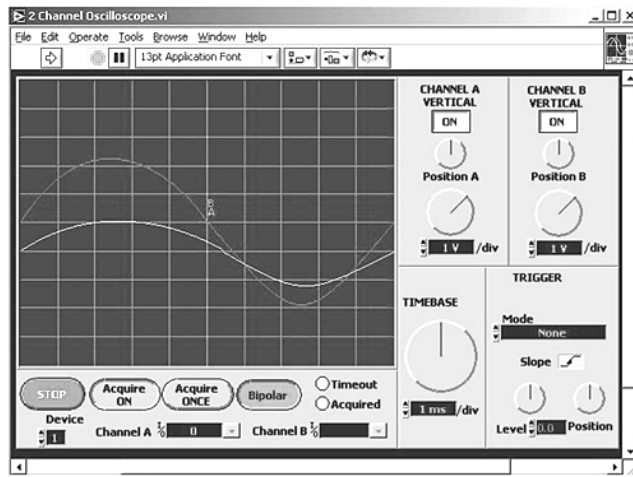

FIGURE 44.3

precise, it could still be inaccurate if the readings were consistent but significantly different than the actual value of the signal.

The accuracy of a data acquisition system can change with temperature, time, and usage. Data acquisition hardware can store on-board correction constants for offset and gain errors. An offset error is a constant difference between the measured and actual voltage, regardless of the voltage level. A gain error increases linearly as the measured voltage increases. Some data acquisition hardware also include an accurate voltage source on-board that can be periodically used as a reference to correct the gain and offset error parameters.

The final piece of a data acquisition system to understand is the software. The driver software is a set of commands that a programmer can incorporate into a program. The driver software is usually supplied by the manufacturer of the hardware and can be used in a variety of programming languages. A programmer can use a programming language to build an application from the driver software like the one in Fig. 44.3. The application is then ready for an end user to easily control and acquire data from the hardware—a custom instrument built specifically for the user’s needs.

45

Measurement Techniques: Sensors and Transducers

| | |
|------|--|
| 45.1 | Introduction |
| 45.2 | Motion and Force Transducers Displacement (Position) Transducers • Velocity Transducers • Acceleration Transducers • Force Transducers |
| 45.3 | Process Transducers Fluid Pressure Transducers • Fluid Flow Transducers (Flowmeters) • Liquid Level Transducers • Temperature Transducers |
| 45.4 | Transducer Performance |
| 45.5 | Loading and Transducer Compliance |

Cecil Harrison

University of Southern Mississippi

45.1 Introduction

An automatic control system is said to be *error actuated* because the **forward path** components (*comparator, controller, actuator, and plant or process*) respond to the error signal (Fig. 45.1). The error signal is developed by comparing the measured value of the **controlled output** to some **reference input**, and so the accuracy and precision of the controlled output are largely dependent on the accuracy and precision with which the controlled output is measured. It follows then that measurement of the controlled output, accomplished by a system component called the **transducer**, is arguably the single most important function in an automatic control system.

A transducer senses the magnitude or intensity of the controlled output and produces a proportional signal in an energy form suitable for transmission along the feedback path to the comparator. [The term proportional is used loosely here because the output of the transducer may not always be directly proportional to the controlled output; that is, the transducer may not be a linear component. In linear systems, if the output of the transducer (the measurement) is not linear, it is linearized by the signal conditioner.] The element of the transducer which senses the controlled output is called the *sensor*; the remaining elements of a transducer serve to convert the sensor output to the energy form required by the **feedback path**. Possible configurations of the feedback path include:

- Mechanical linkage
- Fluid power (pneumatic or hydraulic)
- Electrical, including optical coupling, RF propagation, magnetic coupling, or acoustic propagation

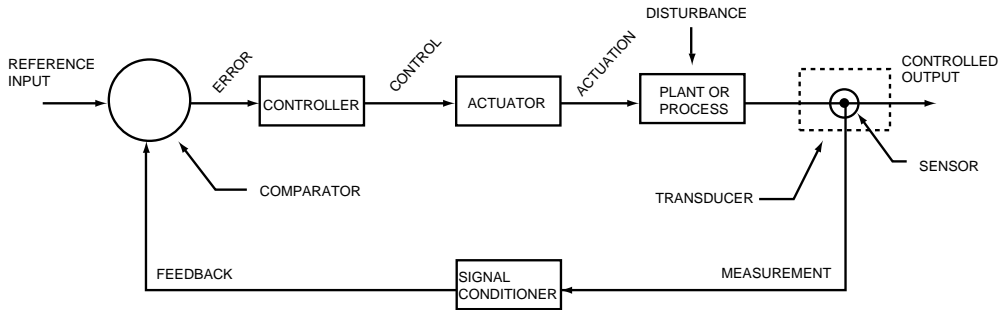

FIGURE 45.1 Functional block diagram of a canonical (standard) automatic control system.

Electrical signals suitable for representing measurement results include:

- DC voltage or current amplitude
- AC voltage or current amplitude, frequency, or phase (CW modulated)
- Voltage or current pulses (digital)

In some cases, representation may change (e.g., from a DC amplitude to digital pulses) along the feedback path.

The remainder of this discussion pertains to a large number of automatic control systems in which the feedback signal is electrical and the feedback path consists of wire or cable connections between the feedback path components. The transducers considered hereafter sense the controlled output and produce an electrical signal representative of the magnitude, intensity, or direction of the controlled output.

The **signal conditioner** accepts the electrical output of the transducer and transmits the signal to the comparator in a form compatible with the reference input. The functions of the signal conditioner include:

- Amplification/attenuation (scaling)
- Isolation
- Sampling
- Noise elimination
- Linearization
- Span and reference shifting
- Mathematical manipulation (e.g., differentiation, division, integration, multiplication, root finding, squaring, subtraction, or summation)
- Signal conversion (e.g., DC–AC, AC–DC, frequency–voltage, voltage–frequency, digital–analog, analog–digital, etc.)
- Buffering
- Digitizing
- Filtering
- Impedance matching
- Wave shaping
- Phase shifting

In cases in which part or all of the required signal conditioning is accomplished within the transducer, the transducer output may be connected directly to the comparator. [Connection of the transducer output directly to the comparator should not be confused with unity feedback. Unity feedback occurs when the cascaded components of the feedback path (transducer and signal conditioner) have a combined transfer function equal to 1 (unity).] In a digital control system, many of the signal conditioning functions listed here can also be accomplished by software.

Transducers are usually considered in two groups:

- **Motion** and **force transducers**, which are mainly associated with **servomechanisms**
- **Process transducers**, which are mainly associated with **process control** systems

As will be seen, most process transducers incorporate some sort of motion transducer.

45.2 Motion and Force Transducers

This section discusses those transducers used in systems that control motion (i.e., *displacement*, *velocity*, and *acceleration*). Force is closely associated with motion, because motion is the result of unbalanced forces, and so force transducers are discussed concurrently. The discussion is limited to those transducers that measure *rectilinear* motion (straight line motion within a stationary frame of reference) or *angular* motion (circular motion about a fixed axis). Rectilinear motion is sometimes called *linear* motion, but this leads to confusion in situations where the motion, though along a straight line, really represents a mathematically nonlinear response to input forces. Angular motion is also called *rotation* or *rotary motion* without ambiguity.

The primary theoretical basis for motion transducers is found in rigid-body mechanics. From the equations of motion for rigid-bodies (Table 45.1), it is clear that if any one of displacement, velocity, or

TABLE 45.1 Equations of Motion

| Continuous | Discrete $\Delta t = t_i - t_{i-1}$ |
|---|--|
| Rectilinear displacement: | |
| $x(t) = \int v(t) dt$ $= \iint a(t) dt$ | $x_i = x_{i-1} + \frac{v_i + v_{i-1}}{2} \cdot (\Delta t)$ $= 2x_{i-1} - x_{i-2} + \frac{a_i + 2a_{i-1} + a_{i-2}}{2} \cdot \frac{(\Delta t)}{2}$ |
| Angular displacement: | |
| $\theta(t) = \int \omega(t) dt$ $= \iint \alpha(t) dt$ | $\theta_i = \theta_{i-1} + \frac{\omega_i + \omega_{i-1}}{2} \cdot (\Delta t)$ $= 2\theta_{i-1} - \theta_{i-2} + \frac{\alpha_i + 2\alpha_{i-1} + \alpha_{i-2}}{2} \cdot \frac{(\Delta t)}{2}$ |
| Rectilinear velocity: | |
| $v(t) = \frac{d}{dt}x(t)$ $= \int a(t) dt$ | $v_i = \frac{x_i - x_{i-1}}{\Delta t}$ $= v_{i-1} + \frac{a_i + a_{i-1}}{2} \cdot (\Delta t)$ |
| Angular velocity: | |
| $\omega(t) = \frac{d}{dt}\theta(t)$ $= \int \alpha(t) dt$ | $\omega_i = \frac{\theta_i - \theta_{i-1}}{\Delta t}$ $= \omega_{i-1} + \frac{\alpha_i + \alpha_{i-1}}{2} \cdot (\Delta t)$ |
| Rectilinear acceleration: | |
| $a(t) = \frac{d}{dt}v(t)$ $= \frac{d^2}{dt^2}x(t)$ | $a_i = \frac{v_i - v_{i-1}}{\Delta t}$ $= \frac{x_i - 2x_{i-1} + x_{i-2}}{(\Delta t)^2}$ |
| Angular acceleration: | |
| $\alpha(t) = \frac{d}{dt}\omega(t)$ $= \frac{d^2}{dt^2}\theta(t)$ | $\alpha_i = \frac{\omega_i - \omega_{i-1}}{\Delta t}$ $= \frac{\theta_i - 2\theta_{i-1} + \theta_{i-2}}{(\Delta t)^2}$ |

acceleration is measured, the other two can be derived by mathematical manipulation of the signal within an analog signal conditioner or within the controller software of a digital control system.

Position is simply a location within a frame of reference; thus, any measurement of displacement relative to the frame is a measurement of position, and any displacement transducer whose input is referenced to the frame can be used as a position transducer.

Displacement (Position) Transducers

Displacement transducers may be considered according to application as *gross* (large) displacement transducers or sensitive (small) displacement transducers. The demarcation between gross and sensitive displacement is somewhat arbitrary, but may be conveniently taken as approximately 1 mm for rectilinear displacement and approximately $10'$ arc ($1/6^\circ$) for angular displacement. The predominant types of gross displacement transducers (Fig. 45.2) are:

- Potentiometers [Fig. 45.2(a)]
- Variable differential transformers (VDT) [Fig. 45.2(b)]
- Synchros [Fig. 45.2(c)]
- Resolvers [Fig. 45.2(d)]
- Position encoders [Fig. 45.2(e)]

Potentiometer-based transducers are simple to implement and require the least signal conditioning, but potentiometers are subject to wear due to sliding contact between the wiper and the resistance element and may produce noise due to wiper bounce [Fig. 45.2(a)]. Potentiometers are available with strokes ranging from less than 1 cm to more than 50 cm (rectilinear) and from a few degrees to more than 50 turns (rotary).

VDTs are not as subject to wear as potentiometers, but the maximum length of the stroke is small, approximately 25 cm or less for a linear VDT (LVDT) and approximately 60° or less for a rotary VDT (RVDT). VDTs require extensive signal conditioning in the form of phase-sensitive demodulation of the AC signal; however, the availability of dedicated VDT demodulators in integrated circuit (IC) packages mitigates this disadvantage of the VDT.

Synchros are rather complex and expensive three-phase AC machines, which are constructed to be precise and rugged. Synchros are capable of measuring angular differences in the positions (up to $\pm 180^\circ$) of two continuously rotating shafts. In addition, synchros may function simultaneously as reference input, output measurement device, feedback path, and comparator [Fig. 45.2(c)].

Resolvers are simpler and less expensive than synchros, and they have an advantage over RVDTs in their ability to measure angular displacement throughout 360° of rotation. In Fig. 45.2(d), which represents one of several possibilities for utilizing a resolver, the signal amplitude is proportional to the cosine of the measured angle at one output coil and the sine of the measured angle at the other. Dedicated ICs are available for signal conditioning and for conversion of resolver output to digital format. The same IC, when used with a *Scott-T transformer*, can be used to convert synchro output to digital format.

Position encoders are highly adaptable to digital control schemes because they eliminate the requirement for digital-to-analog conversion (DAC) of the feedback signal. The code tracks are read by track sensors, usually wipers or electro-optical devices (typically infrared or laser). Position encoders are available for both rectilinear and rotary applications, but are probably more commonly found as shaft encoders in rotary applications. Signal conditioning is straightforward for *absolute* encoders [Fig. 45.2(e)], requiring only a decoder, but position resolution depends on the number of tracks, and increasing the number of tracks increases the complexity of the decoder. *Incremental* encoders require more complex signal conditioning, in the form of counters and a processor for computing position. The number of tracks, however, is fixed at three [Fig. 45.2(f)]. Position resolution is limited only by the ability to render finer divisions of the code track on the moving surface.

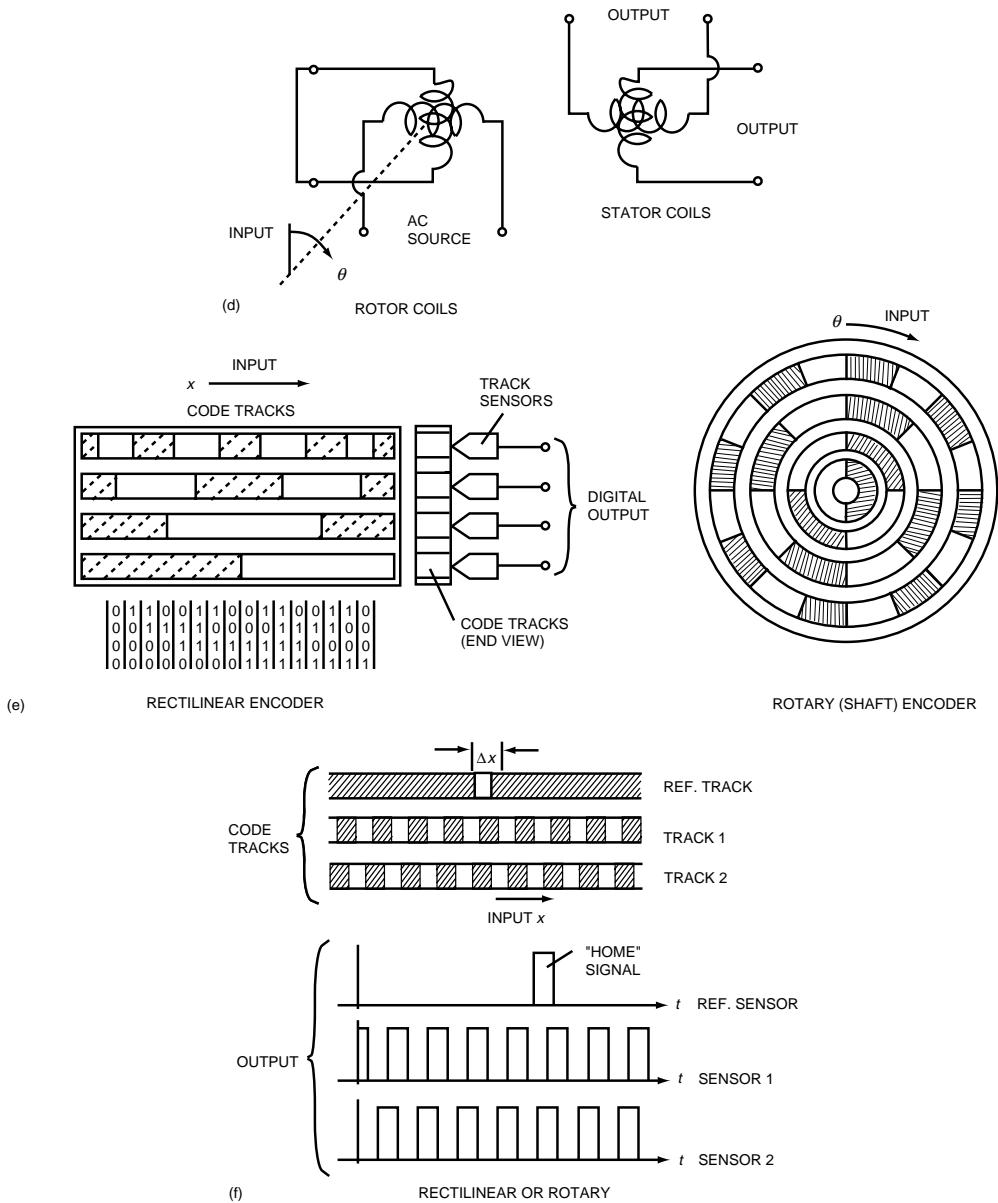

FIGURE 45.2 (Continued)

Figure 45.3(a) provides a simplified depiction of a differential capacitor used for sensitive displacement measurements. The motion of the input rod flexes the common plate, which increases the capacitance of one capacitor and decreases the capacitance of the other. In one measurement technique, the two capacitors are made part of an impedance bridge (such as a Schering bridge), and the change in the bridge output is an indication of displacement of the common plate. In another technique, each capacitor is connected to serve as tuning capacitor for an oscillator, and the difference in frequency between the two oscillators is an indication of displacement.

A strain gauge resistor is used to measure elastic deformation (strain) of materials by bonding the resistor to the material [Fig. 45.3(b)] so that it undergoes the same strain as the material. The resistor is

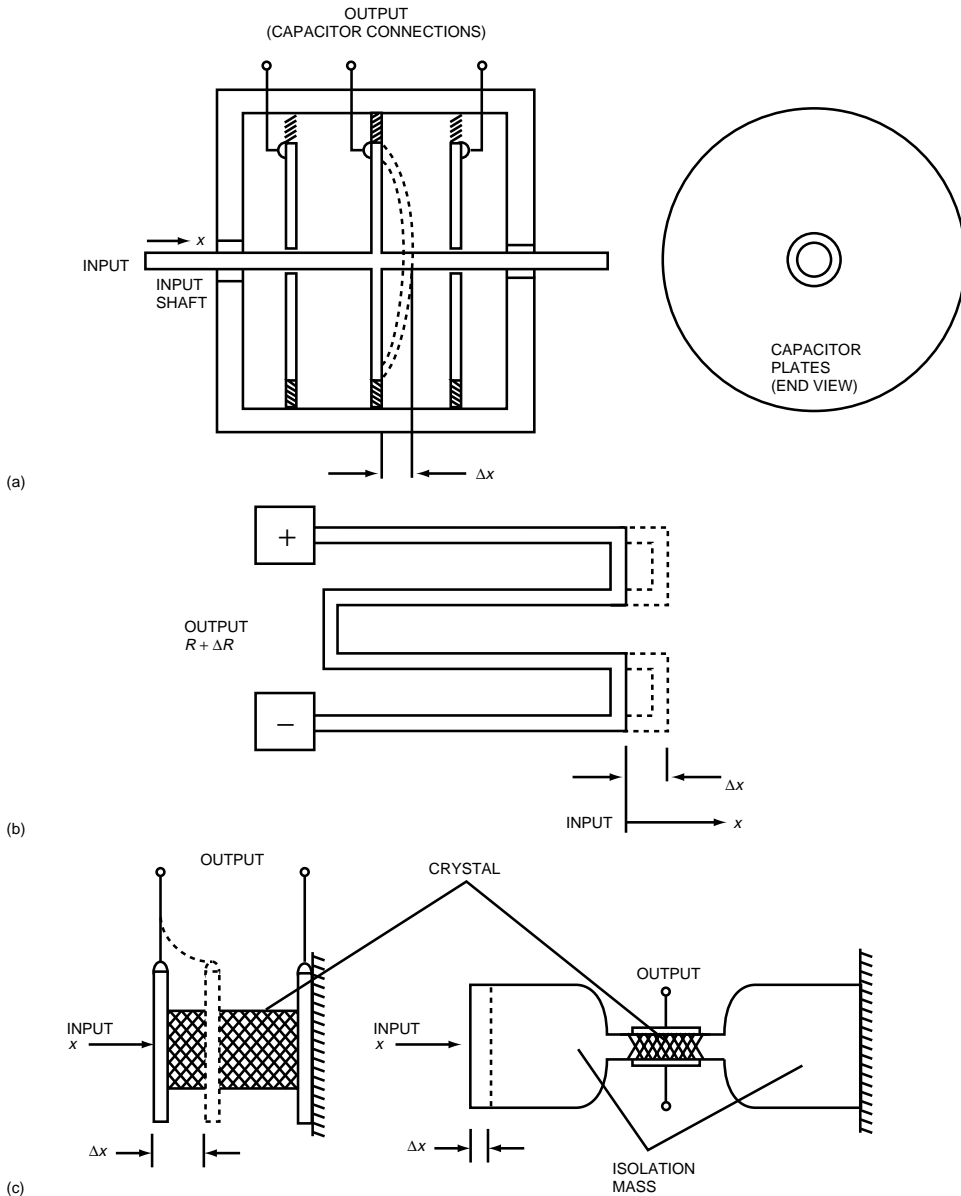

FIGURE 45.3 Sensitive displacement transducers: (a) differential capacitor, (b) strain gauge resistor, (c) piezoelectric crystals.

usually incorporated into one of the several bridge circuits, and the output of the bridge is taken as an indication of strain.

The piezoelectric effect is used in several techniques for sensitive displacement measurements [Fig. 45.3(c)]. In one technique, the input motion deforms the crystal by acting directly on one electrode. In another technique, the crystal is fabricated as part of a larger structure, which is oriented so that input motion bends the structure and deforms the crystal. Deformation of the crystal produces a small output voltage and also alters the resonant frequency of the crystal. In a few situations, the output voltage is taken directly as an indication of motion, but more frequently the crystal is used to control an oscillator, and the oscillator frequency is taken as the indication of strain.

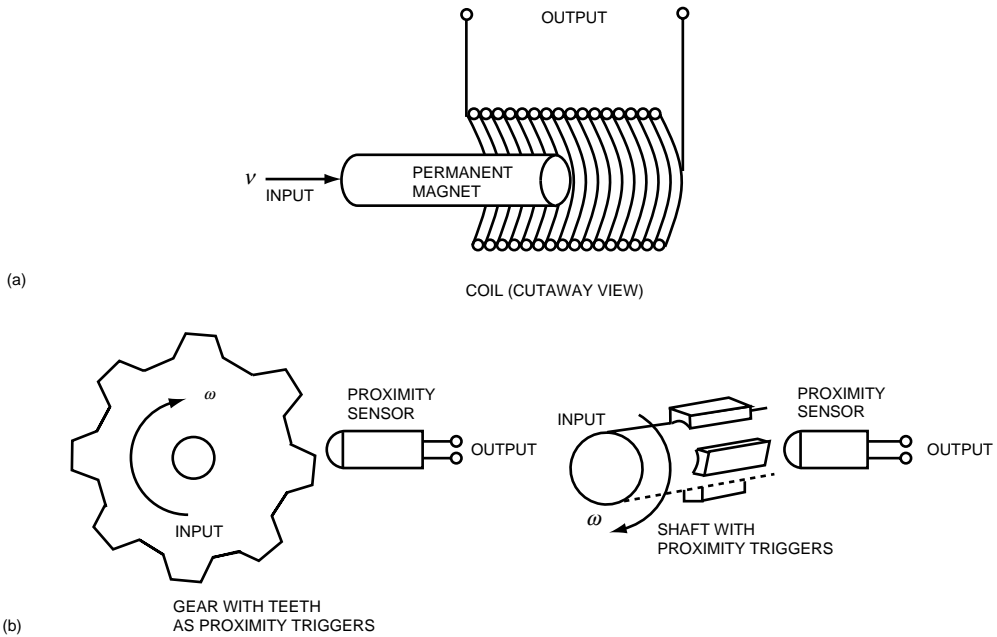

FIGURE 45.4 Velocity transducers: (a) magnet and coil, (b) proximity sensors.

Velocity Transducers

As stated previously, signal conditioning techniques make it possible to derive all motion measurements—displacement, velocity, or acceleration—from a measurement of any one of the three. Nevertheless, it is sometimes advantageous to measure velocity directly, particularly in the cases of short-stroke rectilinear motion or high-speed shaft rotation. The analog transducers frequently used to meet these two requirements are:

- Magnet-and-coil velocity transducers [Fig. 45.4(a)]
- Tachometer generators

A third category of velocity transducers, *counter-type velocity transducers* [Fig. 45.4(b)], is simple to implement and is directly compatible with digital controllers.

The operation of magnet-and-coil velocity transducers is based on Faraday’s law of induction. For a solenoidal coil with a high length-to-diameter ratio made with closely spaced turns of fine wire, the voltage induced into the coil is proportional to the velocity of the magnet. Magnet-and-coil velocity transducers are available with strokes ranging from less than 10 mm to approximately 0.5 m.

A tachometer generator is, as the name implies, a small AC or DC generator whose output voltage is directly proportional to the angular velocity of its rotor, which is driven by the controlled output shaft. Tachometer generators are available for shaft speeds of 5000 rpm, or greater, but the output may be nonlinear and there may be an unacceptable output voltage ripple at low speeds.

AC tachometer generators are less expensive and easier to maintain than DC tachometer generators, but DC tachometer generators are directly compatible with analog controllers and the polarity of the output is a direct indication of the direction of rotation. The output of an AC tachometer generator must be demodulated (i.e., rectified and filtered), and the demodulator must be phase sensitive in order to indicate direction of rotation.

Counter-type velocity transducers operate on the principle of counting electrical pulses for a fixed amount of time, then converting the count per unit time to velocity. Counter-type velocity transducers

rely on the use of a proximity sensor (*pickup*) or an incremental encoder [Fig. 45.2(f)]. Proximity sensors may be one of the following types:

- Electro-optic
- Variable reluctance
- Hall effect
- Inductance
- Capacitance

Two typical applications of counter-type velocity transducers are shown in Fig. 45.4(b).

Since a digital controller necessarily includes a very accurate electronic clock, both pulse counting and conversion to velocity can be implemented in software (i.e., made a part of the controller program). Hardware implementation of pulse counting may be necessary if time-intensive counting would divert the controller from other necessary control functions. A special-purpose IC, known as a *quadrature decoder/counter interface*, can perform the decoding and counting functions and transmit the count to the controller as a data word.

Acceleration Transducers

As with velocity measurements, it is sometimes preferable to measure acceleration directly, rather than derive acceleration from a displacement or velocity measurement. The majority of acceleration transducers may be categorized as *seismic* accelerometers because the measurement of acceleration is based on measuring the displacement of a mass called the *seismic element* (Fig. 45.5). The configurations shown in Figs. 45.5(a,b) require a rather precise arrangement of springs for suspension and centering of the seismic mass. One of the disadvantages of a seismic accelerometer is that the seismic mass is displaced during acceleration, and this displacement introduces nonlinearity and bias into the measurement. The force-balance configuration shown in Fig. 45.5(c) uses the core of an electromagnet as the seismic element. A sensitive displacement sensor detects displacement of the core and uses the displacement signal in a negative feedback arrangement to drive the coil, which returns the core to its center position. The output of the force-balance accelerometer is the feedback required to prevent displacement rather than displacement per se.

A simpler seismic accelerometer utilizes one electrode of a piezoelectric crystal as the seismic element [Fig. 45.5(d)]. Similarly, another simple accelerometer utilizes the common plate of a differential capacitor [Fig. 45.3(a)] as the seismic element.

Force Transducers

Force measurements are usually based on a measurement of the motion, which results from the applied force. If the applied force results in gross motion of the controlled output, and the mass of the output element is known, then any appropriate accelerometer attached to the controlled output produces an output proportional to the applied force ($F = Ma$). A simple spring-balance scale [Fig. 45.6(a)] relies on measurement of displacement, which results from the applied force (weight) extending the spring.

Highly precise force measurements in high-value servomechanisms, such as those used in pointing and tracking devices, frequently rely on gyroscope precession as an indication of the applied force. The scheme is shown in Fig. 45.6(b) for a gyroscope with gimbals and a spin element. A motion transducer (either displacement or velocity) on the precession axis provides an output proportional to the applied force. Other types of gyroscopes and precession sensors are also used to implement this force measurement technique.

Static force measurements (in which there is no apparent motion) usually rely on measurement of strain due to the applied force. Figure 45.6(c) illustrates the typical construction of a common force transducer called a *load cell*. The applied force produces a proportional strain in the S-shaped structural member, which is measured with a sensitive displacement transducer, usually a strain gauge resistor or a piezoelectric crystal.

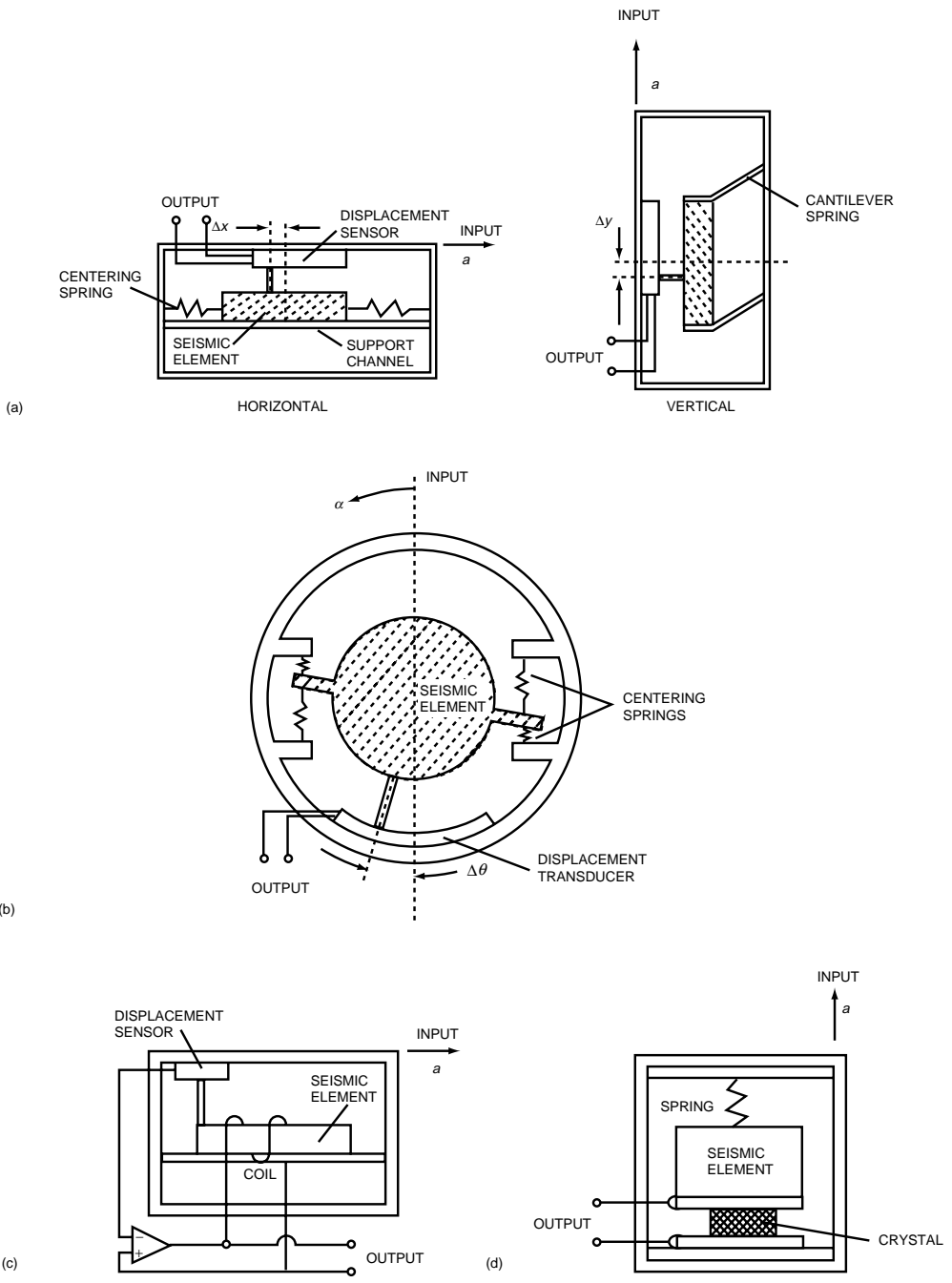

FIGURE 45.5 Seismic accelerometers: (a) rectilinear acceleration transducers, (b) rotary accelerometer, (c) force-balance accelerometer, (d) piezoelectric accelerometer.

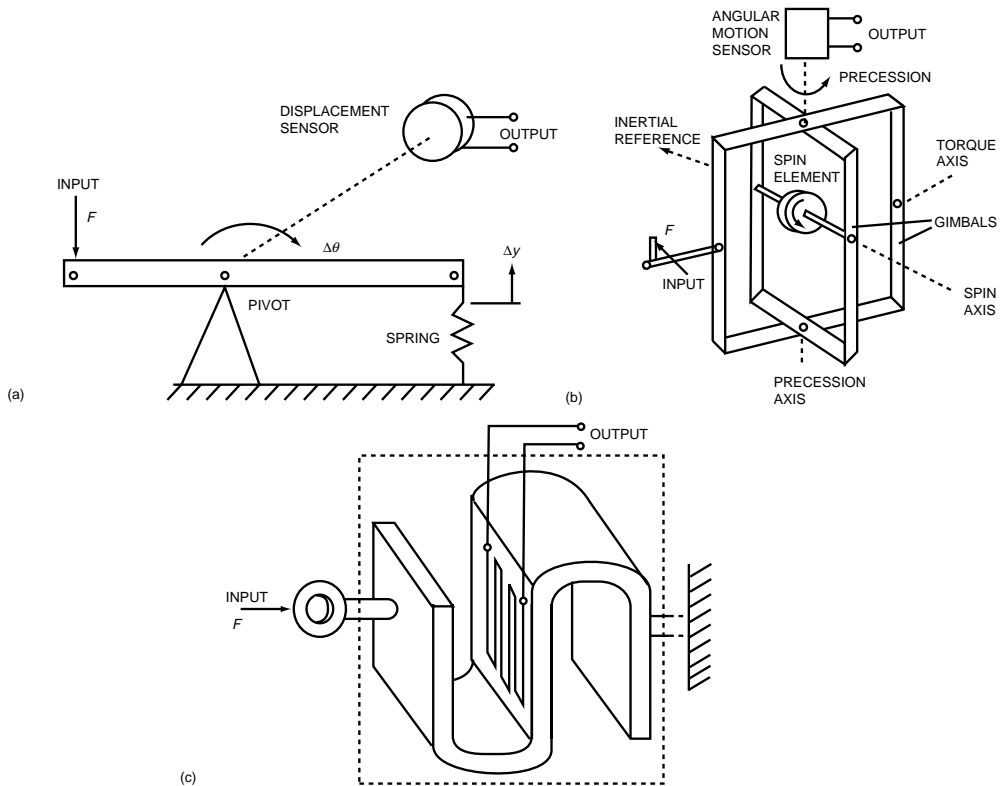

FIGURE 45.6 Force transducers: (a) spring scale, (b) gyroscope, (c) load cell.

45.3 Process Transducers

This section discusses transducers used in measuring and controlling the *process variables* most frequently encountered in industrial processes, namely,

- Fluid pressure
- Fluid flow
- Liquid level
- Temperature

Fluid Pressure Transducers

Most fluid pressure transducers are of the *elastic* type, in which the fluid is confined in a chamber with at least one elastic wall, and the deflection of the elastic wall is taken as an indication of the pressure. The *Bourdon tube* and the *bellows* are examples of elastic pressure transducers, which are used in laboratory-grade transducers and in some industrial process control applications. The fluid pressure transducer depicted in Fig. 45.7, which uses an elastic *diaphragm* to separate two chambers, is the type most frequently encountered in industrial process control. Diaphragms are constructed from one of a variety of elastic materials ranging from thin metal to polymerized fabric.

For gross pressure measurements, the displacement of the diaphragm is sensed by a potentiometer or LVDT; for more sensitive pressure measurements, any one of the three sensitive displacement sensors described earlier is used. In the most common configuration for sensitive pressure transducers, a strain gauge resistor with a rosette pattern is bonded to the diaphragm. In another configuration, the outer

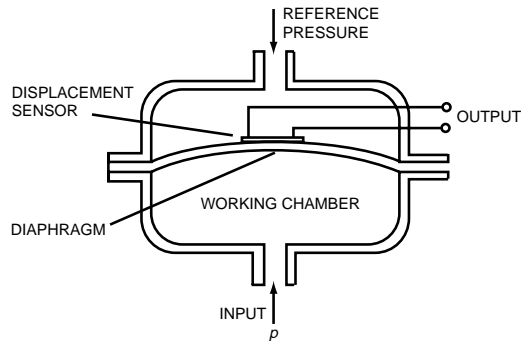

FIGURE 45.7 Diaphragm pressure transducer.

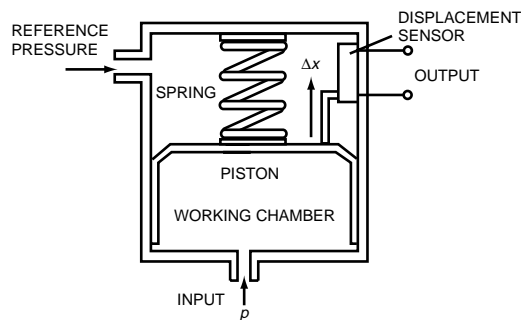

FIGURE 45.8 Piston-and-spring transducer.

walls of the pressure sensor serve as capacitor plates and the diaphragm serves as the common plate of a differential capacitor. In a very sensitive and highly integrated configuration, the diaphragm is a silicon wafer with a piezoresistive strain gauge and signal conditioning circuits integrated into the silicon.

High-vacuum (very low pressure) measurements, usually based on observations of viscosity, thermal conductivity, acoustic properties, or ionization potential of the fluid, will not be included in this discussion. Transducers used in high-pressure hydraulic systems [70 MPa (10,000 psi) or greater] are usually of the *piston and spring* type [Fig. 45.8].

In either of the pressure transducers, the output is actually a measure of the difference in pressure between the working chamber and the reference chamber of the transducer (i.e., $p_{\text{OUT}} = p - p_{\text{REF}}$). The measurement is called:

- An *absolute pressure* if the reference chamber is sealed and evacuated (i.e., $p_{\text{REF}} = 0$ and $p_{\text{OUT}} = p$)
- A *gauge pressure* if the reference chamber is vented to the atmosphere (i.e., $p_{\text{OUT}} = p - p_{\text{ATM}}$)
- A *differential pressure* if any other pressure is applied to the reference chamber

Fluid Flow Transducers (Flowmeters)

Flowmetering, because of the number of variables involved, encompasses a wide range of measurement technology and applications. In industrial processes, the term *fluid* is applied not only to gases and liquids, but also to flowable mixtures (often called *slurries* or *sludges*) such as concrete, sewage, or wood pulp. Control of a fluid flow, and hence the type of measurement required, may involve *volumetric* flow rate, *mass* flow rate, or flow direction. Gas flows may be *compressible*, which also influences the measurement technique. In addition, the condition of the flow—whether or not it is homogenous and clean (free of suspended particles)—has a bearing on flowmeter technology. Another factor to be considered is flow velocity; slow moving laminar flows of viscous material require different measurement techniques than

those used for high-velocity turbulent flows. Still another consideration is confinement of the flow. Whereas most fluid flow measurements are concerned with *full flow* through *closed channels* such as ducts and pipes, some applications require measurements of *partial flow* through *open channels* such as troughs and flumes. Only the most widely used flowmeters are considered here.

The major categories of flowmeters are:

- Differential pressure, constriction-type (venturi, orifice, flow nozzle, elbow (or pipe bend), and pitot static) (Fig. 45.9)
- Fluid-power (gear motors, turbines, and paddle wheels) (Fig. 45.10)

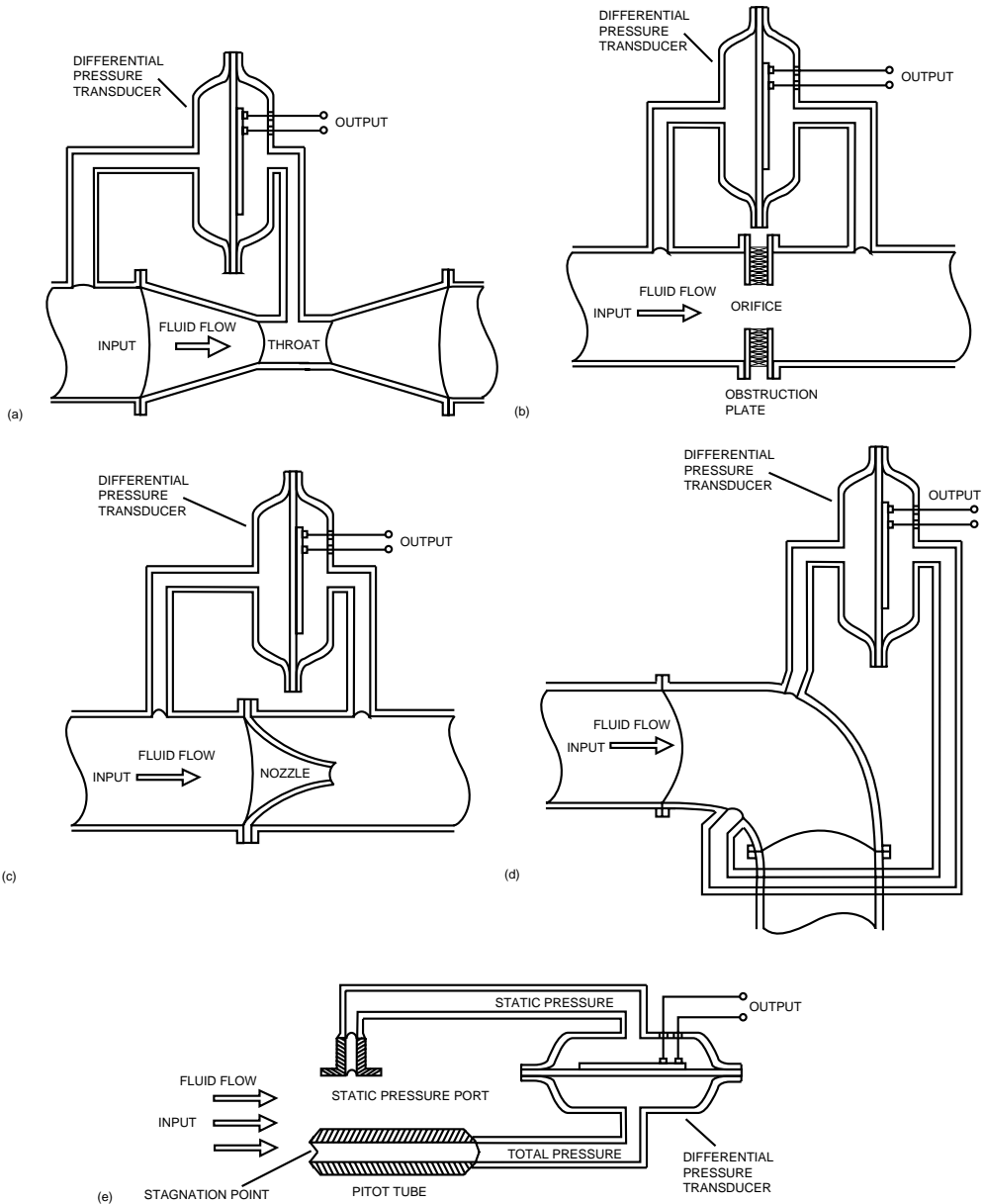

FIGURE 45.9 Differential pressure flowmeters: (a) Venturi flowmeter, (b) orifice flowmeter, (c) nozzle flowmeter, (d) pipebend (elbow) flowmeter, (e) pitot-static-flowmeter.

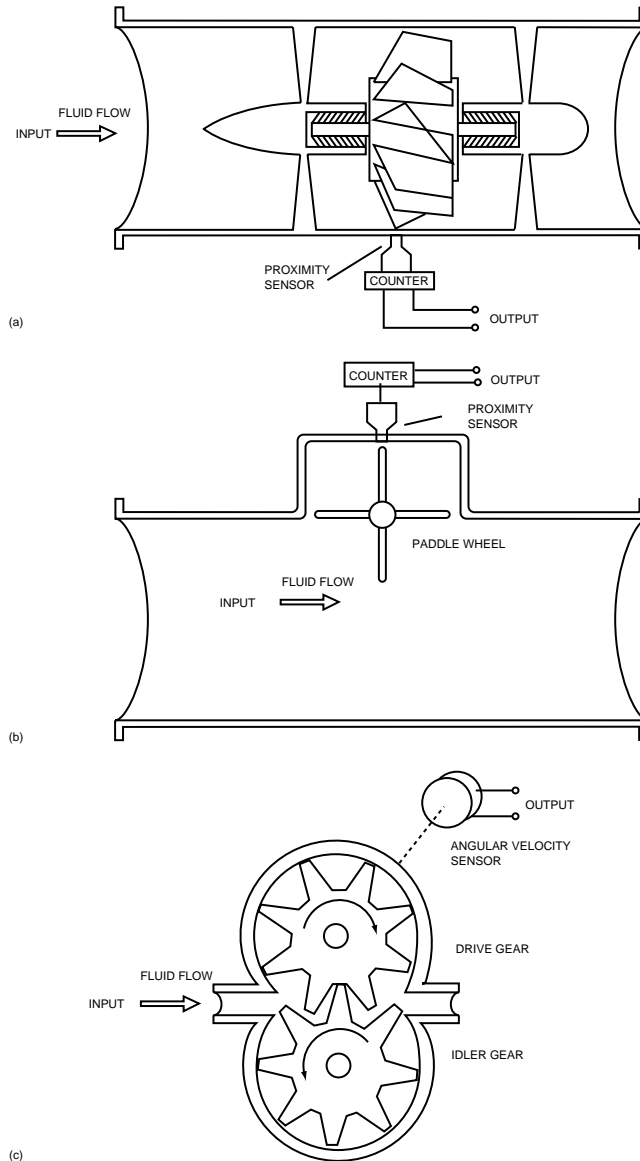

FIGURE 45.10 Fluid power flowmeters: (a) turbine flowmeter, (b) paddle wheel flowmeter, (c) gear motor flowmeter.

- Ultrasound (Fig. 45.11)
- Vortex shedding (Fig. 45.12)
- Thermal anemometer (Fig. 45.13)
- Electromagnetic (Fig. 45.14)
- Rotameter (variable-area in-line flowmeter) (Fig. 45.15)

Differential pressure flowmeters are suited to high- and moderate-velocity flow of gas and clean, low-viscosity liquids. Venturi flowmeters [Fig. 45.9(a)] are the most accurate, but they are large and expensive. Orifice flowmeters [Fig. 45.9(b)] are smaller, less expensive, and much less accurate than venturi flowmeters.

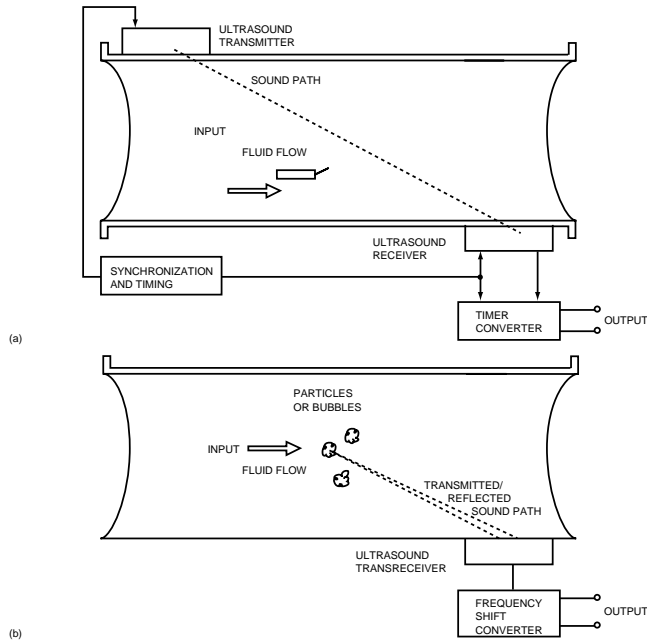

FIGURE 45.11 Ultrasound flowmeters: (a) Transmission-type ultrasound flowmeter, (b) doppler ultrasound flowmeter.

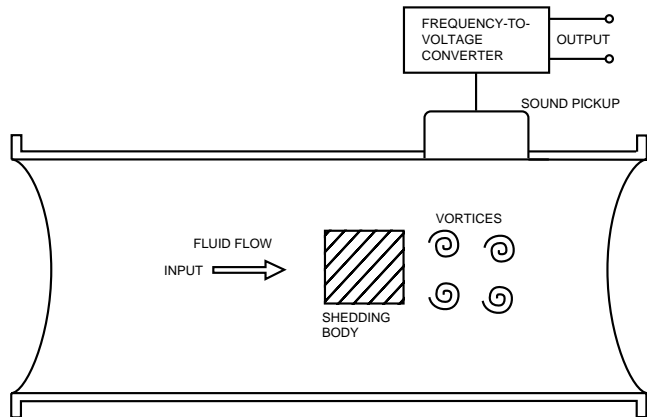

FIGURE 45.12 Vortex-shedding flowmeter.

Nozzle flowmeters [Fig. 45.9(c)] are a compromise between venturi and orifice flowmeters. Pipe-bend flowmeters [Fig. 45.9(d)], which can essentially be installed in any bend in an existing piping system, are used primarily for gross flow rate measurements. Pitot-static flowmeters [Fig. 45.9(e)] are used in flows which have a large cross-sectional area, such as in wind tunnels. Pitot-static flowmeters are also used in freestream applications such as airspeed indicators for aircraft.

Fluid-power flowmeters are used in low-velocity, moderately viscous flows. In addition to industrial control applications, turbine flowmeters [Fig. 45.10(a)] are sometime used as speed indicators for ships or boats. Paddle wheel flowmeters [Fig. 45.10(b)] are used both in closed- and open-flow applications such as liquid flow in flumes. Since a fluid-power gear motor [Fig. 45.10(c)] is a constant volume device, motor shaft speed is always a direct indication of fluid flow rate.

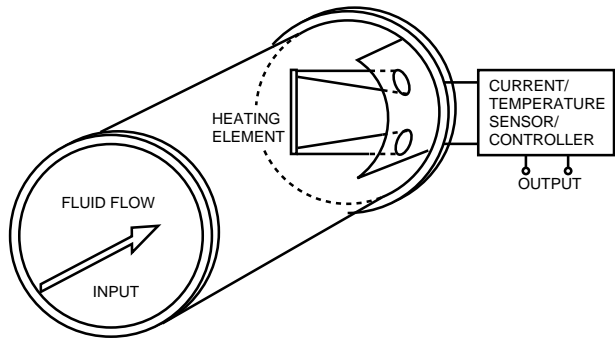

FIGURE 45.13 Thermal anemometer.

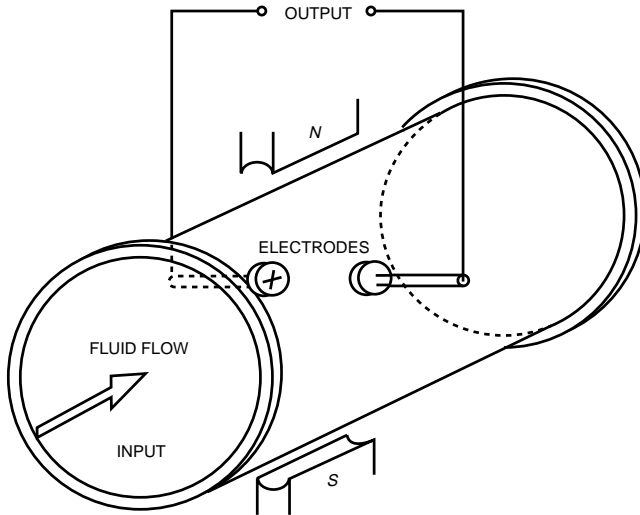

FIGURE 45.14 Electromagnetic flowmeter.

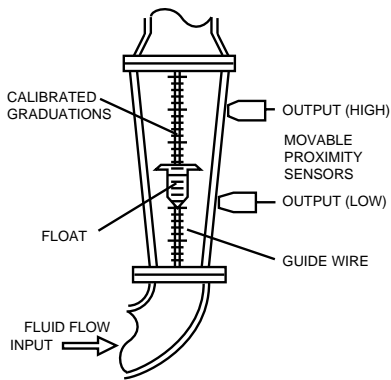

FIGURE 45.15 Variable-area in-line flowmeter (rotameter).

Ultrasound flowmeters of the transmission type [Fig. 45.11(a)], which are based on the principle that the sound transmission speed will be increased by the flow rate of the fluid, are used in all types of clean, subsonic flows. Doppler flowmeters [Fig. 45.11(b)] rely on echoes from within the fluid, and are thus only useful in dirty flows that carry suspended particles or turbulent flows that produce bubbles. Ultrasound flowmeters are nonintrusive devices, which can often be retrofitted to existing duct or pipe systems.

Vortex shedding flowmeters (Fig. 45.12) introduce a *shedding body* into the flow to cause production (*shedding*) of *vortices*. The sound accompanying the production and collapse of the vortices is monitored and analyzed. The dominant frequency of the sound is indicative of the rate of vortex production and collapse, and hence an indication of flow rate. Vortex shedding flowmeters are useful in low-velocity, nonturbulent flows.

Thermal anemometers (Fig. 45.13) are used in low-velocity gas flows with large cross-sectional area, such as in heating, ventilation, and air conditioning (HVAC) ducts. Convection cooling of the heating element is related to flow rate. The flow rate measurement is based either on the current required to maintain a constant temperature in the heating element, or alternatively on the change in temperature when the current is held constant.

Electromagnetic flowmeters (Fig. 45.14) are useful for slow moving flows of liquids, sludges, or slurries. The flow material must support electrical conduction between the electrodes, and so in some cases it is necessary to ionize the flow upstream from the measurement point in order to use an electromagnetic flowmeter.

Variable-area in-line flowmeters (Fig. 45.15), or *rotameters*, are sometimes referred to as sight gauges because they provide a visible indication of the flow rate. These devices, when fitted with proximity sensors (such as capacitive pickups) that sense the presence of the float, can be used in on–off control applications.

Liquid Level Transducers

Liquid-level measurements are relatively straightforward, and the transducers fall into the categories of *contact* or *noncontact*. Measurements may be *continuous*, in which the liquid level is monitored continuously throughout its operating range, or *point*, in which the liquid level is determined to be above or below some predetermined level.

The contact transducers encountered most frequently are:

- Float
- Hydrostatic pressure
- Electrical capacitance
- Ultrasound

The noncontact transducers encountered most frequently are:

- Capacitive proximity sensors
- Ultrasound
- Radio frequency
- Electro-optical

Float-type liquid level transducers are available in a wide variety of configurations for both continuous and point measurements. One possible configuration is depicted in Fig. 45.16 for continuous measurement and for both single- and dual-point measurements.

Hydrostatic pressure liquid level transducers may be used in either vented or pressurized applications (Fig. 45.17). In either case the differential pressure is directly proportional to the weight of the liquid column, since the differential pressure transducer accounts for surface pressure.

Capacitance probes [Fig. 45.18(a)] are widely used in liquid level measurements. It is possible, when the tank walls are metal, to use a single bare or insulated metal rod as one capacitor plate and the tank walls as the other. More frequently, capacitance probes consist of a metal rod within a concentric cylinder

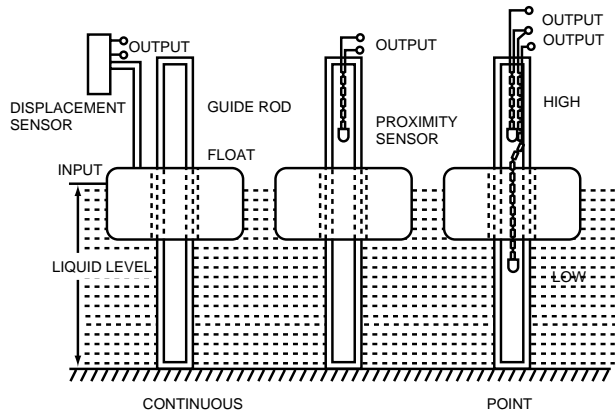

FIGURE 45.16 Float-type liquid level transducers.

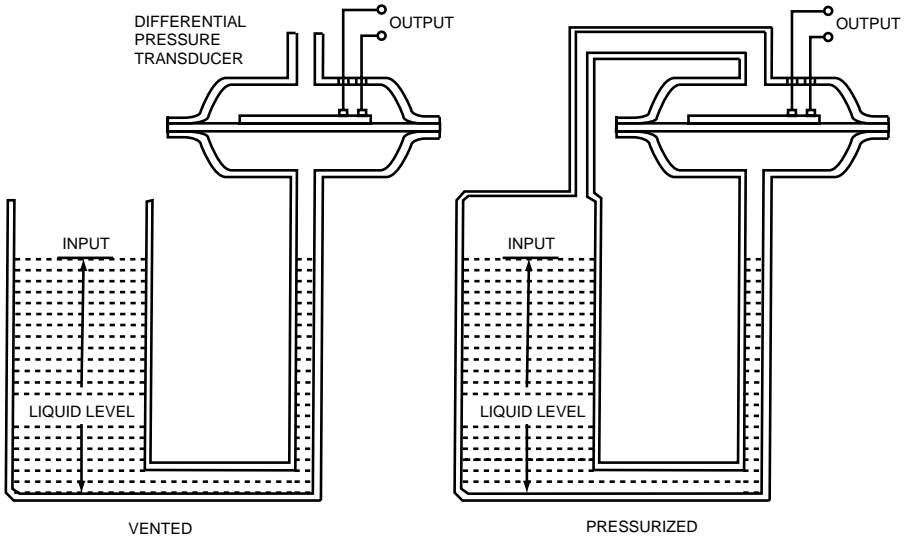

FIGURE 45.17 Hydrostatic pressure liquid level transducers.

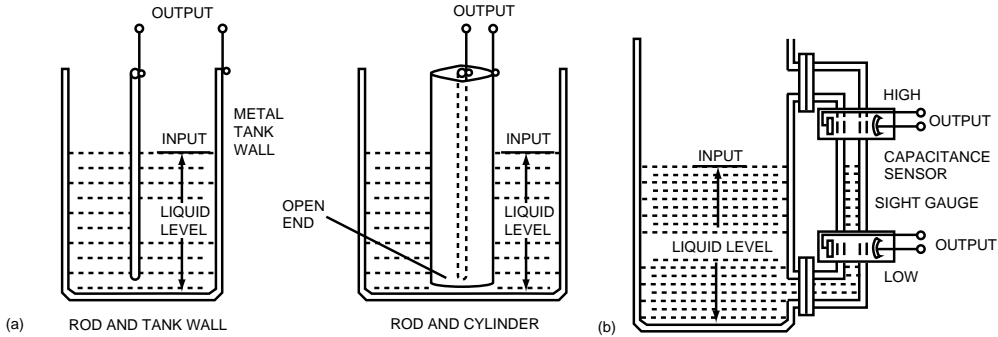

FIGURE 45.18 Capacitive-type liquid level transducers: (a) capacitive probes, (b) capacitive switches.

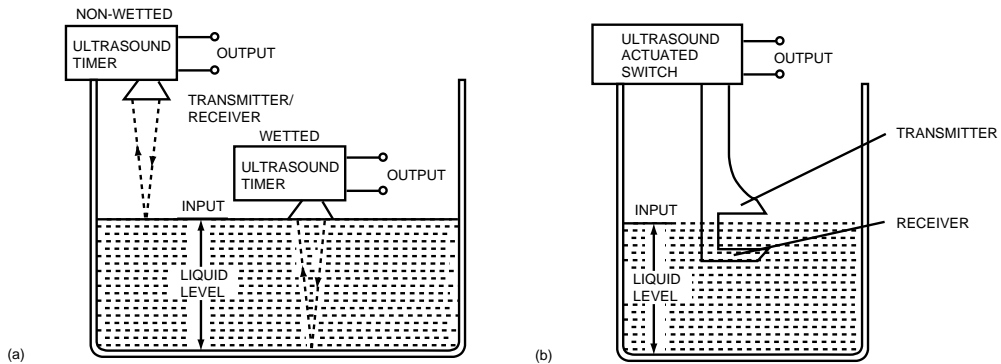

FIGURE 45.19 Ultrasound liquid level transducers: (a) echo-ranging liquid level transducer, (b) ultrasound switch.

open at the ends, which makes the transducer independent of the tank construction. An interesting application of this type of capacitance probe is as aircraft fuel quantity indicators. Capacitance switches can be utilized as depicted in Fig. 45.18(b) to provide noncontact point measurements of liquid level.

Ultrasound echo ranging can be used in either *wetted* (contact) or *nonwetted* (noncontact) configurations for continuous measurement of liquid level [Fig. 45.19(a)]. An interesting application of wetted transducers is as depth finders and fish finders for ships and boats. Nonwetted transducers can also be used with bulk materials such as grains and powders. Radio-frequency and electro-optic liquid level transducers are usually noncontact, echo ranging devices that are similar in principle and application to the nonwetted ultrasound transducer.

Ultrasonic transducers can also be adapted to point measurements by locating the transmitter and the receiver opposite one another across a gap [Fig. 45.19(b)]. When liquid fills the gap, attenuation of the ultrasound energy is markedly less than when air fills the gap. The signal conditioning circuits utilize this sharp increase in the level of ultrasound energy detected by the receiver to activate a switch.

Temperature Transducers

Temperature measurement is generally based on one of the following physical principles:

- Thermal expansion
- Thermoelectric phenomena
- Thermal effect on electrical resistance
- Thermal effect on conductance of semiconductor junctions
- Thermal radiation

(Strictly speaking, any device used to measure temperature may be called a thermometer, but more descriptive terms are applied to devices used in temperature control.)

Bimetallic switches (Fig. 45.20) are widely used in on-off temperature control systems. If two metal strips with different *coefficients of thermal expansion* are bonded together while both strips are at the same temperature, the bimetallic structure will bend when the temperature is changed. Although these devices are often called *thermal cutouts*, implying that they are used in normally closed switches, they can be fabricated in either normally closed or normally open configurations. The bimetallic elements can also be fabricated in coil or helical configurations to extend the range of motion due to thermal expansion.

Thermocouples are rugged and versatile temperature sensors frequently found in industrial control systems. A thermocouple consists of a pair of dissimilar metal wires twisted or otherwise bonded at one end. The *Seebeck effect* is the physical phenomena that accounts for thermocouple operation, so thermocouples are known alternatively as *Seebeck junctions*. The potential difference (*Seebeck voltage*) between the free ends of the wire is proportional to the difference between the temperature at the junction and

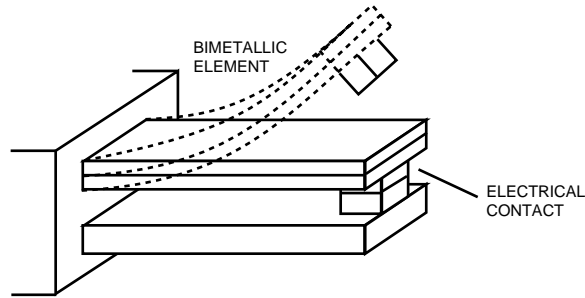

FIGURE 45.20 Bimetallic thermal switch.

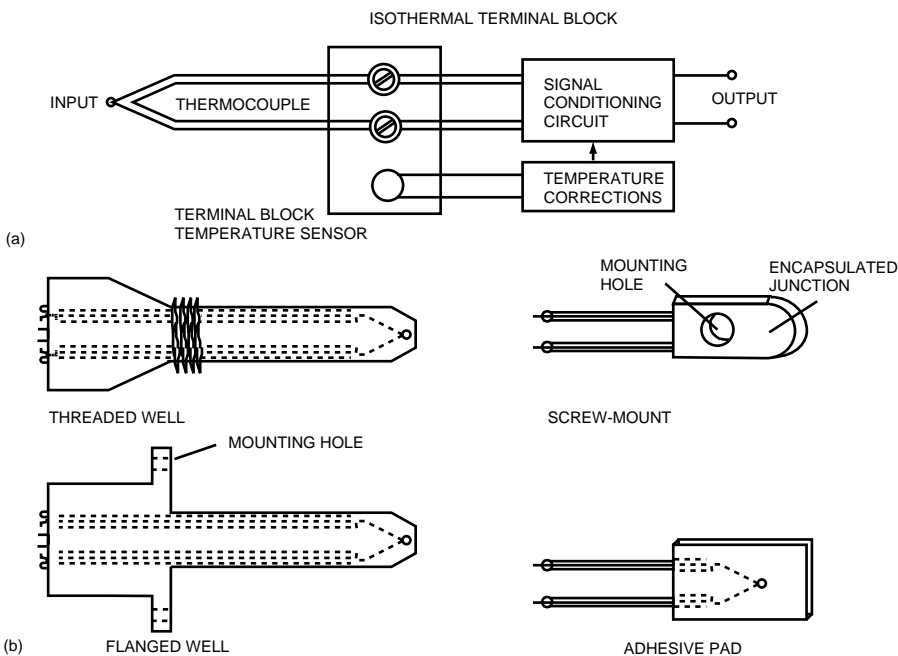

FIGURE 45.21 Thermocouples: (a) typical thermocouple connection, (b) some thermocouple accessories and configurations.

the temperature at the free ends. Thermocouples are available for measurement of temperature as low as -270°C and as high as 2300°C , although no single thermocouple covers this entire range. Thermocouples are identified as type B, C, D, E, G, J, K, N, R, S, or T, according to the metals used in the wire.

Signal conditioning and amplification of the relatively small Seebeck voltage dictates that the thermocouple wires must be connected to the terminals of a signal conditioning circuit. These connections create two additional Seebeck junctions, each of which generates its own Seebeck voltage, which must be canceled in the signal conditioning circuit. To implement cancellation to the corrections the following are necessary [Fig. 45.21(a)]:

- The input terminals of the signal conditioning circuit must be made of the same metal.
- The two terminals must be on an *isothermal terminal block* so that each Seebeck junction created by the connection is at the same temperature.
- The temperature of the terminal block must be known.

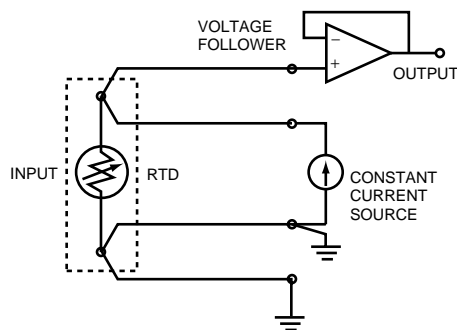

FIGURE 45.22 Typical resistance temperature detector (RTD) application.

The first two requirements are met by appropriate construction of the signal conditioning circuit. The third requirement is met by using a reference temperature sensor, probably an IC temperature transducer of the type described later.

Thermocouple and thermocouple accessories are fabricated for a variety of applications [Fig. 45.21(b)]. Protective shields (thermowells) are used to protect thermocouple junctions in corrosive environments or where conducting liquids can short circuit the thermocouple voltage; however, exposed (bare) junctions are used wherever possible, particularly when a fast response is essential.

Resistance temperature detectors (RTD) are based on the principle that the electrical *resistivity* of most metals increases predictably with temperature. Platinum is the preferred metal for RTDs, although other less expensive metals are used in some applications. The resistivity of platinum is one of the standards by which temperature is measured. The relatively good linearity of the resistivity of platinum over a wide temperature range (-200 to 800°C) makes platinum RTDs suitable for stable, accurate temperature transducers, which are easily adapted to control systems applications.

The disadvantage of the RTD is that the temperature-sensitive element is a rather fragile metal filament wound on a ceramic bobbin or a thin metal film deposited on a ceramic substrate. RTD elements are usually encapsulated and are rarely used as bare elements. The accessories and application packages used with RTDs are similar to those used with thermocouples [Fig. 45.21(b)].

Most platinum RTDs are fabricated so as to have a nominal resistance of $100\ \Omega$ at 0°C . The *resistance temperature coefficient* of platinum is approximately $3\text{--}4\ \text{m}\Omega/\text{W}/^{\circ}\text{C}$, so resolution of the temperature to within 1°C for a nominal $100\text{-}\Omega$ RTD element requires resolution of the absolute resistance within $0.3\text{--}0.4\ \Omega$. These resistance resolution requirements dictate use of special signal conditioning techniques to cancel the lead and contact resistance of the RTD element (Fig. 45.22). The circuit depicted in Fig. 45.22 is a variation of a 4-wire *ohmmeter*. Most RTDs are manufactured with four leads to be compatible with such circuits.

Thermistors are specially prepared metal oxide semiconductors that exhibit a strong *negative* temperature coefficient, in sharp contrast to the weak positive temperature coefficient of RTDs. Nominal thermistor resistance, usually specified for 25°C , ranges from less than $1000\ \Omega$ to more than $1\ \text{M}\Omega$, with sensitivities greater than $100\ \Omega/^{\circ}\text{C}$. Thus, the thermistor is the basis for temperature sensors that are much more sensitive and require less special signal conditioning than either thermocouples or RTDs. The tradeoff is the marked nonlinearity of the resistance-temperature characteristic. To minimize this problem, manufacturers provide packages in which the thermistor has been connected into a resistor network chosen to provide a relatively linear resistance-temperature characteristic over a nominal temperature range.

The development of thermistor technology has led to the IC temperature sensor in which the temperature-sensitive junction(s) and the required signal conditioning circuits are provided in a monolithic package. The user is only required to provide a supply voltage (typically $5\ \text{V DC}$) to the IC in order to obtain an analog output voltage proportional to temperature. Thermistors and IC temperature sensors

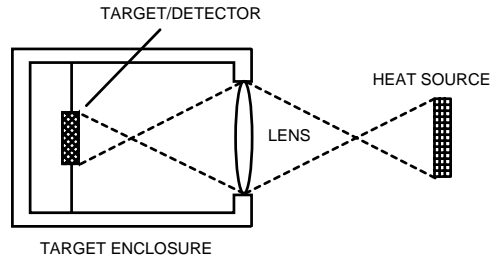

FIGURE 45.23 Schematic of the radiation thermometry scheme.

can be produced in very small packages, which permit highly localized temperature measurements. Some thermistors designed for biological research are mounted in the tip of a hypodermic needle. The shortcomings of both thermistor and IC temperature sensors are that they are not rugged, cannot be used in caustic environments, and are limited to temperatures below approximately 200°C.

Radiation thermometers are used for remote (noncontact) sensing of temperature in situations where contact sensors cannot be used. Operation is based on the principles of heat transfer through thermal radiation. Radiation thermometers focus the *infrared* energy from a heat source onto a *black body* (target) within the radiation thermometer enclosure [Fig. 45.23]. One of the contact temperature sensors described previously is incorporated into the target to measure the target temperature. The rise in temperature at the target is related to the source temperature. Typical radiation thermometers have standoff ranges (focal lengths) of 0.5–1.5 m, but instruments with focal length as short as 1 cm or as long as 10 m are available. Radiation thermometers are available for broadband, monochromatic, or two-color thermometry.

45.4 Transducer Performance

The operation of a transducer within a control system can be described in terms of its *static performance* and its *dynamic performance*. The static characteristics of greatest interest are:

- Scale factor (or sensitivity)
- Accuracy, uncertainty, precision, and system error (or bias)
- Threshold, resolution, dead band, and hysteresis
- Linearity
- Analog drift

The dynamic characteristics of greatest interest are:

- Time constant, response time, and rise time
- Overshoot, settling time, and damped frequency
- Frequency response

Static performance is documented through *calibration*, which consists of applying a known input (quantity or phenomenon to be measured) and observing and recording the transducer output. In a typical calibration procedure, the input is increased in increments from the lower range limit to the upper range limit of the transducer, then decreased to the lower range limit. The range of a component consists of all allowable input values. The difference between the upper and lower range limits is the *input span* of the component; the difference between the output at the upper range limit and the output at the lower range limit is the *output span*.

Dynamic performance is documented by applying a known change, usually a step, in the input and observing and recording the transducer output, usually with a strip recorder or a storage oscilloscope.

45.5 Loading and Transducer Compliance

A prime requirement for an appropriate transducer is that it be *compliant* at its input. Compliance in this sense means that the input energy required for proper operation of the transducer, and hence a correct measurement of the controlled output, does not significantly alter the controlled output. A transducer that does not have this compliance is said to *load* the controlled output. For example, a voltmeter must have a high-impedance input in order that the voltage measurement does not significantly alter circuit current and, hence, alter the voltage being measured.

Defining Terms

Controlled output: The principal product of an automatic control system; the quantity or physical activity to be measured for automatic control.

Feedback path: The cascaded connection of transducer and signal conditioning components in an automatic control system.

Forward path: The cascaded connection of controller, actuator, and plant or process in an automatic control system.

Motion transducer: A transducer used to measure the controlled output of a servomechanism; usually understood to include transducers for static force measurements.

Plant or process: The controlled device that produces the principal output in an automatic control system.

Process control: The term used to refer to the control of industrial processes; most frequently used in reference to control of temperature, fluid pressure, fluid flow, and liquid level.

Process transducer: A transducer used to measure the controlled output of an automatic control system used in process control.

Reference input: The signal provided to an automatic control system to establish the required controlled output; also called *setpoint*.

Servomechanism: A system in which some form of motion is the controlled output.

Signal conditioning: In this context, the term used to refer to the modification of the signal in the feedback path of an automatic control system; signal conditioning converts the sensor output to an electrical signal suitable for comparison to the reference input (setpoint); the term can also be applied to modification of forward path signals.

Transducer: The device used to measure the controlled output in an automatic control system; usually consists of a sensor or pickup and signal conditioning components.

References

- Bateson, R.N. 1993. *Introduction to Control System Technology*, 4th ed. Merrill, Columbus, OH.
- Berlin, H.M. and Getz, F.C., Jr. 1988. *Principles of Electronic Instrumentation and Measurement*. Merrill, Columbus, OH.
- Buchla, D. and McLachlan, W. 1992. *Applied Electronic Instrumentation and Measurement*. Macmillan, New York.
- Chaplin, J.W. 1992. *Instrumentation and Automation for Manufacturing*. Delmar, Albany, NY.
- Doebelin, E.O. 1990. *Measurement Systems Application and Design*, 4th ed. McGraw-Hill, New York.
- Dorf, R.C. and Bishop, R.H. 1995. *Modern Control Systems*, 7th ed. Addison-Wesley, Reading, MA.
- O'Dell, T.H. 1991. *Circuits for Electronic Instrumentation*. Cambridge Univ. Press, Cambridge, England, UK.
- Seippel, R.G. 1983. *Transducers, Sensors, and Detectors*. Reston Pub., Reston, VA.
- Webb, J. and Greshock, K. 1993. *Industrial Control Electronics*, 2nd ed. Macmillan, New York.

Further Information

Manufacturers and vendors catalogs, data documents, handbooks, and applications notes, particularly the handbook series (current year) by Omega Engineering, Inc.:

- The Flow and Level Handbook
- The Pressure, Strain, and Force Handbook
- The Temperature Handbook

Trade journals, magazines, and newsletters, particularly:

- Instrumentation Newsletter (National Instruments)
- Personal Engineering and Instrumentation News
- Test and Measurement News (Hewlett Packard)
- Test and Measurement World

46

A/D and D/A Conversion

- 46.1 Introduction
- 46.2 Sampling
- 46.3 ADC Specifications
 - Range • Resolution • Coding Convention • Linear Errors • Nonlinear Errors • Aperture Errors • Noise • Dynamic Range • Types of ADCs • Flash • Successive-Approximation Register • Multistage
 - Integrating • Sigma-Delta • Digital-to-Analog Converters • Updating
- 46.4 DAC Specifications
 - Range • Resolution • Monotonicity • Settling Time and Slew Rate • Offset Error and Gain Error • Architecture of DACs • Switching Network • Resistive Networks • Summing Amplifier

Mike Tyler

National Instruments, Inc.

46.1 Introduction

As computers began to gain popularity, engineers and scientists realized that computers could become a powerful tool. However, almost all real-world phenomena (such as light, pressure, velocity, temperature, etc.) are analog signals, and computers, on the other hand, rely on digital signals. Therefore, many companies began to invest in advancements in analog-to-digital and digital-to-analog converters (ADC and DAC). These devices have become the keystone in every measurement device. This chapter will examine the ADC and DAC on a functional level as well as discuss important specifications of each.

46.2 Sampling

In order to convert an analog signal into a digital signal, the analog signal must first be sampled. Sampling involves converting one value of a signal at a particular interval of time. Generally, conversions happen uniformly in time. For example, a digitizing system may convert a signal every 5 μs , or sample at 200 kS/s. Although it is not necessary to uniformly sample a signal, doing so provides certain benefits that will be discussed later.

A typical sampling circuit contains two major components: a track-and-hold (T/H) circuit and the ADC. Since the actual conversion in the ADC takes some amount of time, it is necessary to hold constant the value of the signal being converted. At the instance the sample is to be taken, the T/H holds the sample value even if the signal is still changing. Once the conversion has been completed, the T/H releases the value it is currently storing and is ready to track the next value.

One aspect of sampling that cannot be avoided is that some information is thrown away, meaning that an analog waveform actually has an infinite number of samples and there is no way to capture every value.

The major pitfall associated with this fact is called undersampling or sampling too slow. If a 10-kHz sine-wave is to be acquired and sampling only occurs at 5 kS/s, the true waveform will not be preserved. In fact, a waveform of a different frequency will result. The result of undersampling is often referred to as aliasing. According to the Nyquist theory, which deals with sampling, sampling should occur at a rate twice as high as the highest frequency component of the signal. In general, this theory just preserves the frequency of the signal; so if the shape of the waveform is desired, sampling should probably be at least 10 times as fast as the signal.

46.3 ADC Specifications

Range

The input range of an ADC is the span of voltages over which the ADC can make a conversion. For example, a common range for ADC is 0–5 V, meaning that the ADC can convert an input that is within 0–5 V. The end points of the low and high end of the range are called -full-scale and +full-scale (they are also referred to as rails). If the -full-scale is equal to 0 V, then the range is referred to as unipolar, and if the two full-scale values have the same magnitude, e.g., -5 V to +5 V, then the range of the ADC is referred to as bipolar. If an input voltage falls outside the range, the ADC is said to be overranged. In this case, most ADCs will return a value of the endpoint closest to the voltage.

Resolution

The resolution of a digitizer is the smallest detectable change in voltage; however, the resolution of an ADC usually refers to the number of binary bits it produces. For example, a 12-bit ADC represents a converted analog value, using 12 digital bits. This same 12-bit ADC can resolve a value to one of 4096 ($= 2^{12}$) different levels. Another common way to specify resolution is by decimal digits. A 6-digit voltmeter measuring on a 1-V scale could measure in 0.000001 V steps from -0.999999 V to 0.999999 V.

Coding Convention

The different formats an ADC can use represent its output and are known as coding convention. An ADC using binary coding produces all 0s at -full-scale and all 1s at +full-scale (e.g., a 3-bit converter would produce 000 through 111).

Linear Errors

Linear errors are the largest and most common errors in an ADC, and are easily corrected by simple calibration or by additions and multiplications by correction constants. Although linear errors do not distort the ADC transfer function, they can change the range over which the ADC correctly operates.

Nonlinear Errors

Unlike linear errors, nonlinear errors are more difficult to compensate for in either the analog or digital signal. The best way to mitigate nonlinear error is to choose a well-designed, well-specified ADC. Nonlinear errors are characterized by two different specifications: differential nonlinearity (DNL) and integral nonlinearity (INL).

DNL measures any irregularity in the code width (smallest detectable change) by comparing the actual change in value to the ideal value of one code width (or 1 LSB). INL measures the deviation from an ideal transfer line of the code transitions.

Another important specification of an ADC in regards to differential nonlinearity is if any codes are missing. A missing code can be thought of as a code with a width of 0 LSB (or a DNL of -1). If a code

is missing, the step size at that point in the transfer function is doubled, effectively cutting the local resolution of the ADC in half. Therefore, ADC datasheets will specify if the ADC has no missing codes.

Another way to capture the same information included in INL is a measurement called relative accuracy. Relative accuracy indicates how far away from the ideal the code transitions are (which is INL), but also includes how far any part of the transfer function, including quantization “staircase” error, deviates from ideal. In an ideal noiseless ADC, the worst case relative accuracy is always greater than the INL. However, if an ADC has some inherent noise and has noise (referred to as dither) added to the input, then the relative accuracy actually improves. The addition of noise to a quantizer tends to smooth the average transfer function that results in less of a “staircase” effect. This improvement in the transfer functions linearity comes at the expense of conversion errors caused by the added noise.

Aperture Errors

Aperture errors deal with the timing of the conversions themselves. All ADCs require some signal, generally a pulse train clock, to tell the ADC when to start a conversion. Inherently, some small amount of time will elapse when the ADC receives this convert signal and when the sample is held. This amount of time that lapses is called the aperture delay. Most ADCs have an aperture delay of just a few nanoseconds. However, most measurement devices have some other circuitry in front of the ADC, such as amplifiers, which have the effect of negating the aperture delay caused by the ADC. For example, if the ADC has a delay of 10 ns and the amplifier has a delay of 160 ns, the effective aperture delay of the system is -150 ns.

Another important time specification is jitter. Jitter (or aperture jitter) measures the difference in the amount of time between each sample. If a signal is sampled at 1 million samples per second (1 MS/s), the expected period between each sample would be exactly 1 μ s. The actual time between samples could vary from 1 μ s by as much as a few picoseconds to a nanosecond from cycle to cycle. Jitter can be caused by the clock source, digital clock circuitry, or S/H circuitry. The most common effect of jitter is to add interference at frequencies very close to the signal of interest.

Noise

Noise limits the ADC resolution because an interfering waveform is present in the input signal as it is being converted. The most common source of noise in a signal is thermal noise. Thermal noise is caused by the random nature of electrical components. With higher temperatures and resistances in components, the thermal noise will increase. Other common sources of noise are electromagnetically coupled to nearby circuitry, such as logic circuits and clocks. Generally, noise is specified in volts peak-to-peak or rms, or LSBs rms or peak-to-peak.

Quantization error, previously discussed, is sometimes referred to as quantization noise. Although quantization error is perfectly predictable with respect to the input signal, when a signal is fairly “busy” (meaning that each consecutive conversions do not result in many common bits of data) the quantization error becomes chaotic. When this occurs, the quantization error can be thought of as another source of random noise, whose statistical distribution is uniform from -0.5 to 0.5 LSB and whose standard deviation is $1/\sqrt{12}$ LSB. In spectral analysis, this is sometimes the dominant source of noise.

Once noise reaches the ADC, there are ways to process the noise out of the signal, provided that the noise is an independent signal. One of the most common ways to decrease noise in a DC measurement is to acquire a number of points and average the values. If the noise is white random noise, which has equal energy density at all frequencies, averaging will reduce the amount of noise by the square root of the number of samples averaged. If the noise is interfering with a repetitive waveform, the noise can be reduced by measuring a number of waveforms, using a level trigger and then averaging the waveforms. Most digital oscilloscopes have waveform averaging.

Most noise specifications for an ADC are for quiet, low-impedance signals. To preserve the noise performance of the ADC, the user must connect signals to the inputs with shielded cabling that keeps signals away from any electromagnetic interference.

Dynamic Range

Dynamic range is the ratio of largest to smallest signal the ADC can represent. The dynamic range is found by taking a full-scale signal value and comparing that to the smallest detectable noise level of the ADC. The dynamic range is usually expressed in decibels (dB) and can be found by the following formula:

$$\text{Dynamic Range} = 20\log(S/N)$$

where S is large signal level and N is noise level. The noise level includes quantization noise of the ADC, which for an ideal ADC is equal to $1/\sqrt{12}$ LSB rms. A full-scale sine wave has an amplitude of 2^{n-1} LSB or $2^{n-1}/\sqrt{2}$ (n = number of bits of the ADC). Therefore, an ideal ADC has a dynamic range of

$$\begin{aligned}\text{Dynamic Range} &= 20 \log(2^{n-1}/\sqrt{2} \text{ } 1/\sqrt{12}) \\ &= 6.0206n + 1.7609\end{aligned}$$

Since no ADC is ideal, the effective number of bits (ENOB) of an actual ADC can be calculated using the above equation. The ENOB represents the real world resolution of an ADC, and can be found with the following equation using dynamic range:

$$\text{NOB} = (\text{Dynamic Range} - 1.7609)/6.0206$$

For example, a 12-bit ADC with a dynamic range of 69 dB has an ENOB of 11.17 bits.

Types of ADCs

All ADCs accomplish the same fundamental task of taking an analog signal and converting it into a digital representation. Two crucial characteristics of an ADC are the speed at which conversions can be made and the resolution of the conversions. In most cases, this becomes a trade-off of speed vs. resolution. For example, a converter of 100 MS/s at 24 bits is not currently available, but there are 100 MS/s converters (probably at 8 bits) and 24-bit converters (probably at 1 kS/s). This makes it important to understand how the ADC will be used in order to match the correct converter for the application.

Despite the many different types of ADCs available, they all share some common characteristics. The heart of any ADC converter is the comparator. A comparator is a simple 1-bit ADC, which has two analog inputs and one digital output. One of the analog input signals is a reference voltage that has some known value. The other inputs will either be greater than or less than the known input value, and that will turn into a digital value of 1 or 0. Some ADCs are actually composed of multiple comparators, but the basic theory for each one is the same.

Flash

Flash ADCs are the fastest ADCs available, obtaining speeds in multiple gigasamples per second. However, true to the speed vs. resolution trade-off discussed, the flash converters generally have resolutions of 10 bits and below. A flash converter with n bits of resolution is composed of 2^{n-1} high-speed comparators operating in parallel, see Fig. 46.1. A string of 2^{n-1} resistors between two voltage references supplies a set of uniformly spaced voltages that span the input range, one for each comparator. The input voltage is then compared to each level simultaneously. The comparators then output a 1 for all voltages below the input voltage, and a 0 for all voltages above the input voltage. These resulting digital values are then fed into a logic convert to output an n -bit value.

Because of the simplicity of the design, flash converters are fast, but as the resolution of the converter is increased the number of comparators and resistors needed increases exponentially. Both the size

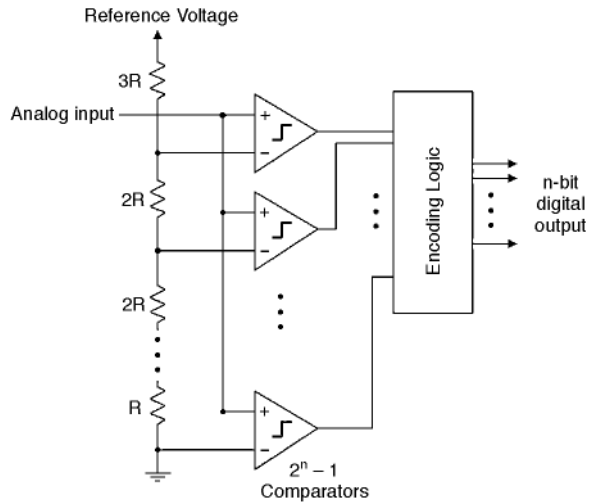

FIGURE 46.1 Flash ADC—A flash converter has 2^{n-1} comparators operating in parallel. It relies on the uniformity of the resistors for linearity.

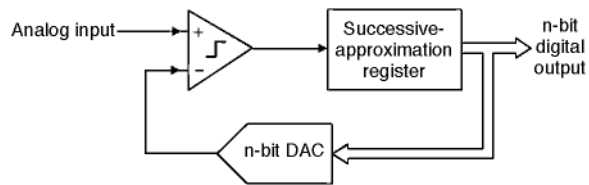

FIGURE 46.2 SAR ADC—A successive-approximation (SAR) converter has one comparator, which iterates through a series of “guesses” to determine a digital representation of the signal.

and power needed to operate the converter also increase exponentially as a result of increased resolution, and this way the converters are limited in their resolution. However, because string resistors’ values typically vary only a few percent from one another, the differential linearity of the flash ADC is quite good.

Successive-Approximation Register

Successive-approximation register (SAR) ADCs are the most common ADCs, having resolutions of 8–16 bits and speeds up to 10 MS/s. These ADCs are low-cost, and generally have good integral linearity. The SAR ADC architecture contains a high-speed DAC in a feedback loop, see Fig. 46.2. The SAR iterates the DAC through a series of levels, which are then compared to the input voltage. As the conversion progresses, the SAR builds the n -bit digital output as a result of these comparisons. When the SAR has finished, the output of the DAC is as close to the input signal as possible, and the digital input of the DAC becomes the output of the SAR ADC.

A good real world analogy to an SAR is a balance scale. If an object of unknown mass is placed on one side and continues to test a combination of weights until the scale is balanced, the weight of the object can be obtained.

The speed of the SAR ADC is limited by the rate at which the DAC can settle inside the feedback loop. In fact, the DAC must settle n times for every n bits of resolution desired in the ADC. In order to achieve faster rates, the SAR architecture can be used as the basis for a different ADC, the multistage.

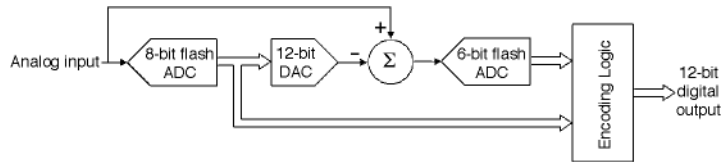

FIGURE 46.3 Multistage ADC—A multistage converter is a combination of the SAR and flash converters to provide faster sampling than the SARs and at a higher resolution than the flash converters could provide.

Multistage

In order to achieve higher rates than the SAR, multistage ADCs use the iterative approach of the SAR but reduce the number of comparisons needed to complete the conversion. In addition to the comparator, the multistage ADC uses low-resolution flash converters, see Fig 46.3. In the figure, the 6-bit flash is used to convert the residual errors from the 8-bit flash. These two outputs from the ADCs are then combined using digital logic to produce a 12-bit output.

Most multistage ADCs are actually pipelined ADC. Pipelined ADCs have the same architecture as a multistage ADC, but each flash converter contains a T/H at the input. This allows each stage to convert the residual error while the previous stage has moved on to the next sample. This way the whole converter can operate at the speed of the slowest stage, as opposed to the multistage that operates at a speed equal to the sum of all the stages.

Integrating

Integrating ADCs are the opposite of the flash converter. They are designed to return very high-resolution reading. As a trade-off, they operate at slower speeds. It is a very simple design; the integrating ADCs consist of an integrating amplifier, a comparator, a digital counter, and an extremely stable capacitor. The most common integrating ADC is the dual-slope. In this architecture, the capacitor is initially discharged to have no potential across it. At a set time, the input is applied across the capacitor and it begins to charge for a set period of time T_1 . Because of the properties of a capacitor, the rate of charge is proportional to the input voltage. After T_1 , the capacitor is switched to a negative reference voltage and begins to discharge at a rate proportional to the reference. The digital counter simply measures how much time it took for the capacitor to completely discharge T_2 . Since T_1 and the rate at which the capacitor discharges are both known values, the voltage of the input can be obtained by a simple ratio.

It is important to note that the convert is not actually measuring the input voltage itself. Instead, the ADC obtains the voltage by measuring time and using digital logic to calculate the input voltage. This method has the advantage of rejecting noise, such as periodic noise, to which other ADCs are susceptible. In addition, most integrating ADCs operate on a multiple of an AC line period (1/60 or 1/50 s) so that stray electromagnetic fields caused by power systems are cancelled.

Sigma-Delta

The sigma-delta (SD) ADC is one of the most popular types of ADC due to its fit on the speed vs. resolution curve. SD ADCs can provide 16–24 bits of resolution at sample rates of up to hundreds of thousands of samples per second. This speed and resolution makes them ideal for certain applications such as vibration and audio analysis; however, the process of integration causes the SD ADC to have poor DC accuracy. Figure 46.4 shows the design of an SD ADC. The heart of an SD ADC is actually a 1-bit ADC that samples at incredibly high rates. Typically, these 1-bit ADCs sample at 64 or 128 times the eventual sample rate, which is a process known as oversampling. In addition to the high-speed ADC, an SD architecture consists of an analog low-pass filter and a DAC all together in a feedback loop. The result forces otherwise unavoidable quantization noise into higher frequency bands. This resulting spectrum of the noise is part of a process called noise shaping. The output of this feedback loop, which is

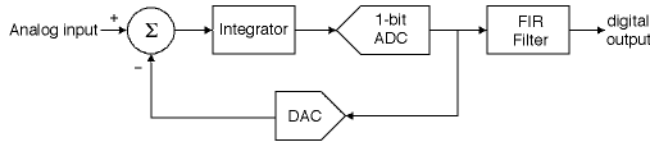

FIGURE 46.4 SD ADC—A sigma-delta converter uses a 1-bit comparator to determine the signal value. SD converters have great linearity by design, because the 1-bit ADC is perfectly linear, theoretically, since it can assume only one of two values.

actually just a stream of 1-bit conversions, is then fed to a digital filter. The digital filter then increases the resolution, reduces the data rate, and applies a low-pass digital filter to the data coming out of the feedback loop. After this process, the SD ADC has an output with high resolution and signals only in the frequency band of interest, eliminating most of the inherent electronic noise.

Digital-to-Analog Converters

The opposite of an ADC, which takes an analog value and produces a digital value, would be a device that takes digital values and creates analog values. A digital-to-analog converter (DAC) is a device that, given a digital representation of a signal, can create an analog signal at a specific voltage level. Although much of the theory behind ADCs discussed previously applies to DACs, a unique set of terms and phenomena do exist.

Updating

Updating can be thought of as the DAC equivalent to sampling. If a DAC is to generate a sine wave from a group of digital values, we need some way to specify how this waveform is to be generated. Simply put, the update rate is how many points per second that a DAC can output an analog value, generally given in samples per second, kilosamples per second, or million samples per second.

46.4 DAC Specifications

Range

The range of a DAC is identical to the definition of the range of an ADC. This refers to the voltage range of values that the DAC can output.

Resolution

The resolution of a DAC is specified identical to the ADC; however, the perspective is reversed. In an ADC, resolution defines how many digital bits would represent an analog value, thus giving us a level of granularity we could acquire. With a DAC, the resolution indicates how many digital bits need to be supplied to the DAC to operate and what granularity of signal we can produce.

Monotonicity

One of the most useful specifications of a DAC is the monotonicity. If a DAC is monotonic, this implies that as the digital value increases, the analog output value will also increase or at least stay the same. Conversely, a device is said to be nonmonotonic if one or more values of the analog output may actually be less than the values corresponding to codes having smaller weight. Many applications are sensitive to fine changes in output value; therefore, any DAC used needs to be monotonic on all bits.

Settling Time and Slew Rate

Settling time and slew rate together determine how rapidly a DAC can change the analog value it is outputting. Settling time refers to the amount of time it takes the output of the DAC to reach a specified accuracy level. Most DACs specify settling time as a full-scale change in voltage, from the smallest output value to the largest. Slew rate, specified in volt per second, is the maximum rate of change of the output of the DAC. Therefore, a DAC with a fast slew rate and a small settling time can generate high-frequency signals because an accurate voltage level can be obtained in a very small amount of time.

Offset Error and Gain Error

Offset error refers to the transfer characteristic of the DAC not outputting an analog value of 0 when the digital value of 0 is applied. The range from zero to full would be offset from the specified value because the offset would carry throughout the transfer function. The offset error can be thought of as a translation in the transfer line either up or down from the ideal. Gain error indicates a linear deviation from the ideal transfer line of a DAC. This can be caused by a variety of factors, which results in a change of slope from the ideal.

Architecture of DACs

Unlike ADCs, DACs do not implement a wide range of approaches to convert a digital input code to an analog value. Instead, almost all DACs use some combination of a switch network, resistive network, and summing amplifier. This is not to say that all DACs have the same design, but they are all based on the principle of switching.

Switching Network

The switching network of a DAC can be thought of as the heart of the conversion. Since digital bits are either on or off, these bits can be used to control single pole switches. These switches are then used to direct some form of analog circuitry to develop an analog value. For example, a 3-bit DAC would comprise three switches, one for each bit of input data. Depending on the code given, these switches would close in such a way to develop an analog value from a reference source that is equal to the digital representation, see Fig. 46.5. Depending on the design of the analog circuitry in the DAC, the switches may be connecting current or voltage references to a resistive network.

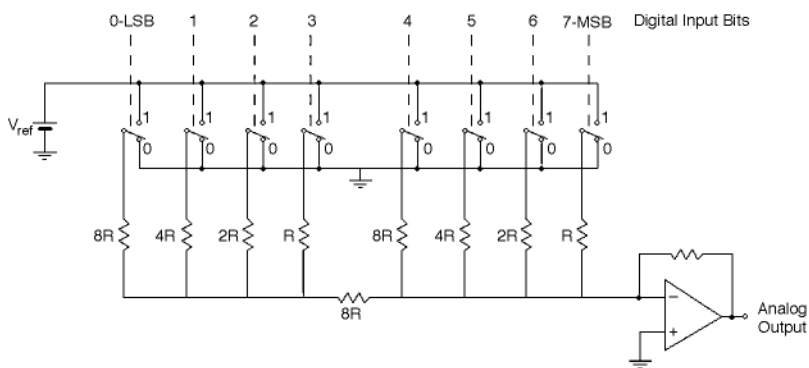

FIGURE 46.5 DAC architecture—Most digital-to-analog converters (DACs) follow a standard architecture of a switch network, a resistive network, and an amplifier.

Resistive Networks

Resistive networks in a DAC provide the varying levels of analog output voltage, which will form the output of the DAC. Although many different resistive schemes are used in DAC design, the basic principle is common in all of them. The one shown in Fig. 46.5 uses a dual resistor quad approach. In the figure, bits 0–3 and 4–7 are separated by a single resistor. These two independent groups are each a resistor quad with resistor values of $1R$ - $2R$ - $4R$ - $8R$ where R is equal to $10\text{ k}\Omega$ s. If any of the switches is in the 1 position, a current will develop across the resistor proportional to the resistors' value. Therefore, if bit 0 is on a current proportional to $1/1R$ is generated, whereas if switch 2 is on a current proportional to $1/4R$ would be generated. The resistor between the two quads has the effect of a 16:1 current attenuator, so that even though bit 4 would generate a current proportional to $1/1R$, once it gets to the amplifier it would appear to have a current proportional to $1/16R$. In this case, bit 0 would be the most significant bit (MSB), and bit 7 would be the least significant bit (LSB).

Summing Amplifier

The operational amplifier (op-amp) used in the DAC circuit of Fig 46.5 is acting as a summing amplifier. As the different bits generate a particular current, the op-amp is designed to collect the total current and would generate an output voltage. This output voltage of the op-amp is now an analog representation of the digital code which was fed to the DAC.

47

Signal Conditioning

Stephen A. Dyer
Kansas State University

- 47.1 Linear Operations
Amplitude Scaling • Impedance Transformation • Linear Filtering
- 47.2 Nonlinear Operations

Kelvin's first rule of instrumentation states, in essence, that the measuring instrument must not alter the event being measured. For the present purposes, we can consider the instrument to consist of an input transducer followed by a signal-conditioning section, which in turn drives the data-processing and display section (the remainder of the instrument). We are using the term *instrument* in the broad sense, with the understanding that it may actually be a measurement subsystem within virtually any type of system.

Certain requirements are imposed upon the transducer if it is to reproduce an event faithfully: It must exhibit amplitude linearity, phase linearity, and adequate frequency response. But it is the task of the signal conditioner to accept the output signal from the transducer and from it produce a signal in the form appropriate for introduction to the remainder of the instrument.

Analog signal conditioning can involve strictly *linear* operations, strictly *nonlinear* operations, or some combination of the two. In addition, the signal conditioner may be called upon to provide auxiliary services, such as introducing electrical isolation, providing a reference of some sort for the transducer, or producing an excitation signal for the transducer.

Important examples of linear operations include *amplitude scaling*, *impedance transformation*, *linear filtering*, and *modulation*.

A few examples of nonlinear operations include obtaining the *root-mean-square (rms) value*, *square root*, *absolute value*, or *logarithm* of the input signal.

There is a wide variety of building blocks available in either modular or integrated-circuit (IC) form for accomplishing analog signal conditioning. Such building blocks include operational amplifiers, instrumentation amplifiers, isolation amplifiers, and a plethora of nonlinear processing circuits such as comparators, analog multiplier/dividers, log/antilog amplifiers, rms-to-DC converters, and trigonometric function generators.

Also available are complete signal-conditioning subsystems consisting of various plug-in input and output modules that can be interconnected via universal backplanes that can be either chassis- or rack-mounted.

47.1 Linear Operations

Three categories of linear operations important to signal conditioning are amplitude scaling, impedance transformation, and linear filtering.

Amplitude Scaling

The amplitude of the signal output from a transducer must typically be scaled—either amplified or attenuated—before the signal can be processed.

Amplification

Amplification is generally accomplished by an *operational amplifier*, an *instrumentation amplifier*, or an *isolation amplifier*.

Operational Amplifiers

A conventional operational amplifier (op amp) has a differential input and a single-ended output. An *ideal* op amp, used often as a first approximation to model a real op amp, has infinite gain, infinite bandwidth, infinite differential input impedance, infinite slew rate, and infinite **common-mode rejection ratio (CMRR)**. It also has zero output impedance, zero noise, zero bias currents, and zero input offset voltage. Real op amps, of course, fall short of the ideal in all regards.

Important parameters to consider when selecting an op amp include:

1. DC voltage gain K_0 .
2. Small-signal **gain-bandwidth product (GBWP)** f_T , which for most op amps is $f_T \approx K_0 f_1$, where f_1 is the lower break frequency in the op amp's transfer function. The GBWP characterizes the closed-loop, high-frequency response of an op-amp circuit.
3. **Slew rate**, which governs the large-signal behavior of an op amp. Slew rates range from less than 1 V/ μ s to several thousand volts per microsecond.

Other parameters, such as input and output impedances, DC offset voltage, DC bias current, drift voltages and currents, noise characteristics, and so forth, must be considered when selecting an op amp for a particular application.

There are several categories of operational amplifiers. In addition to “garden-variety” op amps there are many op amps whose characteristics are optimized for one or more classes of use. Some categories of op amps include:

1. *Low-noise* op amps, which are useful in the portions of signal conditioners required to amplify very-low-level signals.
2. *Chopper-stabilized* op amps, which are useful in applications requiring extreme DC stability.
3. *Fast* op amps, which are useful when large slew rates and large GBWPs are required.
4. *Power* op amps, which are useful when currents of greater than a few mA must be provided to the op amp's load.
5. *Electrometer* op amps, which are used when very high ($>10^{13} \Omega$) input resistances and very low (<1 pA) input bias currents are required.

An introduction to op amps and basic circuit configurations occurs in essentially any modern text on circuit theory or electronics, and the reader can find detailed theoretical developments and many useful configurations and applications in Roberge (1975), Graeme et al. (1971), Graeme (1973, 1977), Horowitz and Hill (1989), and Stout and Kaufman (1976).

Instrumentation Amplifiers

Instrumentation amplifiers (IAs) are gain blocks optimized to provide high input impedance, low output impedance, stable gain, relatively high **common-mode rejection (CMR)**, and relatively low offset and drift. They are well suited for amplification of outputs from various types of transducers such as strain gages, for amplification of low-level signals occurring in the presence of high-level common-mode voltages, and for situations in which some degree of isolation is needed between the transducer and the remainder of the instrument.

Although instrumentation amplifiers can be constructed from conventional op amps [a three-op-amp configuration is typically discussed; see, for example, Stout and Kaufman (1976)], they are readily available and relatively inexpensive in IC form. Some IAs have digitally programmable gains, whereas others are programmable by interconnecting resistors internal to the IA via external pins. More-basic IAs have their gains set by connecting external resistors.

Isolation Amplifiers

Isolation amplifiers are useful in applications in which a voltage or current occurring in the presence of a high common-mode voltage must be measured safely, accurately, and with a high CMR. They are also useful when safety from DC and line-frequency leakage currents must be ensured, such as in biomedical instrumentation.

The isolation amplifier can be thought of as consisting of three sections: an input stage, an output stage, and a power circuit. All isolation amplifiers have their input stages galvanically isolated from their output stages. Communication between the input and output stages is accomplished by modulation/demodulation.

An isolation amplifier is said to provide two-port isolation if there is a DC connection between its power circuit and its output stage. If its power circuit is isolated from its output stage as well as its input stage, then the amplifier is said to provide three-port isolation. Isolation impedances on the order of $10^{10} \Omega$ are not atypical.

Isolation amplifiers are available in modular form with either two-port or three-port isolation. Both single-channel and multichannel modules are offered.

Attenuation

Although the majority of transducers are low-level devices such as thermocouples, thermistors, resistance temperature detectors (RTDs), strain gages, and so forth, whose outputs require amplification, there are many measurement situations in which the input signal must be attenuated before introducing it to the remainder of the system.

Voltage Scaling

Most typically, the signals to be attenuated take the form of voltages. Broadly, the attenuation is accomplished by either a *voltage divider* or a *voltage transformer*.

Voltage Dividers

In many cases a simple chain divider proves adequate. The transfer function of a two-element chain of impedances $Z_1(s)$ and $Z_2(s)$ is

$$\frac{V_o(s)}{V_{in}(s)} = \frac{Z_1(s)}{Z_1(s) + Z_2(s)}$$

where the output voltage $V_o(s)$ is the voltage across $Z_1(s)$ and the input voltage V_{in} is the voltage across the two-element combination.

Of course, the impedances of the source (transducer) and the load (the remainder of the system) must be taken into account when designing the divider network.

Resistive Dividers

If the elements in the chain are resistors, then the divider is useful from DC up through the frequencies for which the impedances of the resistors have no significant reactive components. For $Z_1(s) = R_1$ and $Z_2(s) = R_2$,

$$\frac{V_o(s)}{V_{in}(s)} = \frac{R_1}{R_1 + R_2}$$

Other configurations are available for resistive dividers. One example is the Kelvin–Varley divider, which has several advantages that make it useful in situations requiring high accuracy. For a detailed description, see Gregory (1973).

Capacitive Dividers

If the elements in the chain divider are capacitors, then the divider has as its transfer function

$$\frac{V_o(s)}{V_{in}(s)} = \frac{C_2}{C_1 + C_2}$$

This form of divider is useful from low frequencies up through frequencies of several megahertz. A common application is in the scaling of large voltages.

Inductive Dividers

If the elements in the chain divider are inductors, then an autotransformer results. Inductive dividers are useful over frequencies from a few hertz to several hundred kilohertz. Errors in the parts-per-billion range are achievable.

Voltage Transformers

Voltage transformers constitute one of the most common means of accomplishing voltage scaling at line frequencies. Standard double-wound configurations are useful unless voltages above about 200 kV are to be monitored. For very high voltages, alternative configurations such as the *capacitor voltage transformer* and the *cascade voltage transformer* are employed (Gregory, 1973).

Current Scaling

Current scaling is typically accomplished via either a current shunt or a current transformer.

A *current shunt* is essentially an accurately known resistance through which the current to be measured is passed. The voltage developed across the shunt as a result of the current is the quantity measured. Shunts are useful at DC and frequencies through the audio range. Two disadvantages are (1) the shunt consumes power, and (2) the measurement circuitry must be operated at the same potential as the shunt.

The *current transformer* overcomes the mentioned disadvantages of the current shunt. Typically, the current transformer consists of a specially constructed toroidal core upon which the secondary (sense) winding is wrapped and through which the primary winding is passed. A single-turn primary is commonly used, although multiturn primaries are available.

Other Attenuators

In addition to the aforementioned means of voltage and current scaling are attenuator pads, which provide, in addition to voltage or power reduction, the ability to be matched in impedance to the source and load circuits between which it is connected. The common pads include the T, L, and Π types, either balanced or unbalanced. Resistive attenuator pads are discussed in most textbooks on circuit design (e.g., Cuthbert, 1983). They are useful from DC through several hundred megahertz.

Impedance Transformation

Oftentimes the impedance of the transducer must be transformed to a value more acceptable to the remainder of the measurement system. In many cases maximum power must be transferred from the transducer's output signal to the remaining circuitry. In other cases it is sufficient to provide buffering that presents a very high impedance to the transducer, a very low impedance to the rest of the system, and a voltage gain of unity.

Matching transformers, passive matching networks such as attenuator pads, and unity-gain buffers are standard means of accomplishing impedance transformation. Unity-gain buffers are available in IC form.

Linear Filtering

Although, in general, digital signal processing offers many advantages over analog techniques for filtering signals, there are many relatively simple applications for which *frequency-selective analog filtering* is well suited.

Filters are used within signal conditioners (1) to reduce the effects of noise that corrupts the input signal, (2) as part of a demodulator, (3) to limit signal bandwidth, or (4) if the signal is to be sampled, to limit its bandwidth in order to prevent aliasing. These filters can be built either entirely of passive components or based on active devices such as op amps.

There are many good references that discuss methods of characterizing, specifying, and implementing frequency-selective analog filters. See Van Valkenburg (1960) for design of passive filters; for the design of active-RC filters, see Sedra and Brackett (1978) and Stephenson (1985).

47.2 Nonlinear Operations

There is a wide variety of nonlinear operations useful to signal-conditioning tasks. Listed below are some typical nonlinear blocks along with brief descriptions. Most of the blocks are available as ICs.

1. *Comparator.* A comparator is a two-input device whose output voltage, V_o , takes on one of two stable values, V_{o0} and V_{o1} , as follows:

$$V_o = \begin{cases} V_{o0}, & \text{if } V_2 < V_1 \\ V_{o1}, & \text{otherwise} \end{cases}$$

where V_1 and V_2 are the voltages at the two inputs.

2. *Schmitt trigger.* A Schmitt trigger is a comparator with hysteresis. It can be constructed from a comparator by applying positive feedback.
3. *Multiplier.* A two-input multiplier supplies an output voltage that is proportional to the product of its input voltages.
4. *Divider.* A two-input divider has as its output a voltage proportional to the ratio of its input voltages. The functions of multiplication and division are usually combined within a single device.
5. *Squarer.* A squarer has as its output a voltage proportional to the square of its input. Squarers can be constructed by a number of means: from multipliers, based on diode-resistor networks, based on FETs, and so forth.
6. *Square-rooter.* A square-rooter has as its output a voltage proportional to the square root of its input. A square-rooter can be built most easily from either a divider or a log/antilog amplifier.
7. *Logarithmic/antilogarithmic amplifier.* A log/antilog amplifier produces an output voltage proportional to the logarithm or the antilogarithm of its input voltage.
8. *True RMS-to-DC converter.* A true RMS-to-DC converter computes the square root of the average, over some interval of time, of the instantaneous square of the input signal. The averaging operation is generally accomplished via a simple low-pass filter whose capacitor is selected to give the desired interval.
9. *Trigonometric function generator.* Generators are available in IC form that produce as their outputs any of the standard trigonometric functions or their inverses, taken as functions of the differential voltage at the generator's inputs.
10. *Sample-and-hold and track-and-hold amplifiers.* A sample-and-hold amplifier (SHA) is a device that samples the signal at its input and holds the instantaneous value whenever commanded by a logic control signal. A track-and-hold amplifier is identical to an SHA but is used in applications where it spends most of its time tracking the input signal (i.e., in "sample" or "track" mode), in contrast to the SHA, which spends most of its time in "hold" mode.
11. *Precision diode-based circuits.* Circuits such as precision half-wave rectifiers, absolute-value circuits, precision peak detectors, and precision limiters are relatively easy to design and implement based on diodes and op amps. See Horowitz and Hill (1989), Stout and Kaufman (1976), and Graeme (1977).

A detailed description of these and other nonlinear circuit blocks can be found in Sheingold (1976).

Example

We provide briefly an example of a device that has embedded within it several signal-conditioning circuits. [Figure 47.1](#) shows the basic block diagram of a therapeutic ultrasound unit, which finds widespread use in physical medicine.

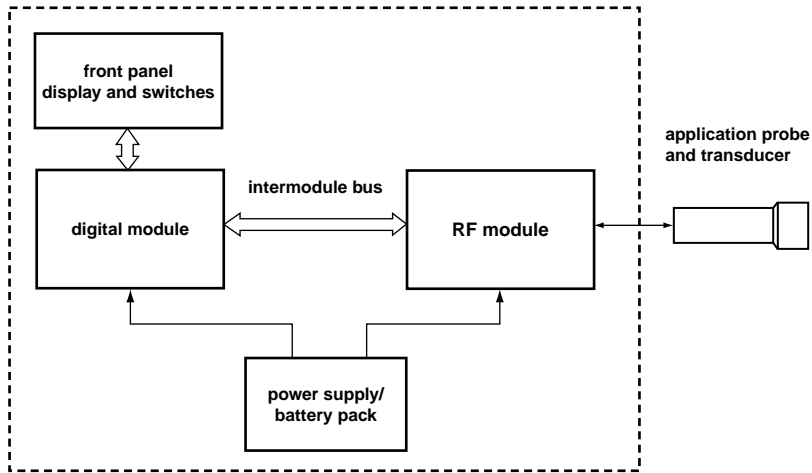

FIGURE 47.1 Basic block diagram of the therapeutic ultrasound unit discussed as an example.

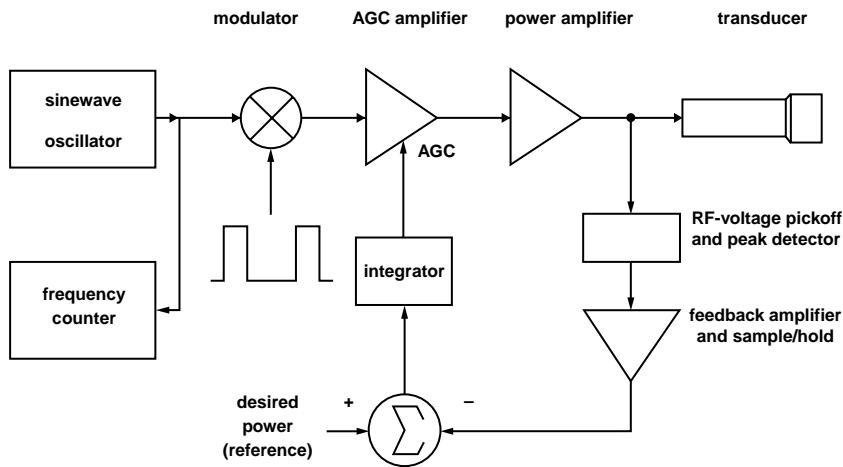

FIGURE 47.2 Simplified block diagram of the RF module used in the ultrasound unit of Fig. 47.1.

The particular unit being discussed consists of five principal subsystems:

1. An application probe and ultrasound transducer, which imparts ultrasonic energy to the tissue being treated. *Note that this transducer is NOT an input transducer such as has been discussed in relation to signal conditioners.*
2. A radio-frequency (RF) module, which provides electrical excitation to the ultrasound transducer.
3. Front-panel display and switches, which allow communication between the unit and its operator.
4. A microprocessor-based digital module, which orchestrates the overall control of the ultrasound unit.
5. A power supply/battery pack, which provides operating power to the unit.

We focus now on the RF module, whose basic block diagram is shown in Fig. 47.2. The module consists of a sine-wave oscillator that produces a signal at the resonant frequency of the transducer, a modulator that allows that signal to be pulse-modulated, and an amplifier with RF-voltage feedback. Incorporated in the amplifier are a power amplifier capable of driving the transducer and automatic-gain-control (AGC) circuitry required to adjust the output power to coincide with that selected by the operator. The AGC uses

a standard feedback-control loop to maintain a constant-voltage envelope on the RF signal output from the power amplifier.

Some of the signal conditioners employed within the RF module include the following:

1. The RF-voltage pickoff at the output of the power amplifier. The pickoff employs a half-wave rectifier, followed by a simple capacitive chain divider for voltage scaling.
2. A precision peak detector, which obtains the peak value of the output from the voltage divider during a modulation cycle and presents that value to the feedback loop.
3. An amplifier, having digitally selectable gain, which amplifies the output of the peak detector.
4. A sample-and-hold amplifier, used to hold the amplified output from the peak detector during the “off-time” of the modulator. The SHA is needed since the time constant of the peak detector is not sufficient to prevent significant “droop” during the off-time of the modulator.
5. An integrator (an example of frequency-selective filtering), which develops the control voltage for the AGC loop from the output of the differencer.
6. A current shunt, not shown in Fig. 47.2, which is used to monitor the DC current supplied to the power amplifier.

As can be seen from this simple example, several signal-conditioning functions may be employed within a single system, and the system itself might not even be an instrument!

Defining Terms

Common-mode rejection (CMR): CMRR given in decibels. $CMR = 20 \log|CMRR|$. CMR is a nonlinear function of common-mode voltage and depends on other factors such as temperature.

Common-mode rejection ratio (CMRR): The ratio of the differential gain to the common-mode gain of an amplifier.

Gain-bandwidth product (GBWP): The product of an amplifier’s highest gain and its corresponding bandwidth. Used as a rough figure of merit for bandwidth.

Slew rate: The maximum attainable time rate of change of an amplifier’s output voltage in response to a large step change in input voltage.

References

- Cuthbert, T. R. 1983. *Circuit Design Using Personal Computers*. John Wiley & Sons, New York.
- Graeme, J. G. 1973. *Applications of Operational Amplifiers*. McGraw-Hill, New York.
- Graeme, J. G. 1977. *Designing with Operational Amplifiers*. McGraw-Hill, New York.
- Graeme, J. G., Tobey, G. E., and Huelsman, L. P. (Ed.) 1971. *Operational Amplifiers*. McGraw-Hill, New York.
- Gregory, B. A. 1973. *An Introduction to Electrical Instrumentation*. Macmillan, London.
- Horowitz, P. and Hill, W. 1989. *The Art of Electronics*, 2nd ed. Cambridge University Press, New York.
- Roberge, J. K. 1975. *Operational Amplifiers*. John Wiley & Sons, New York.
- Sedra, A. S. and Brackett, P. O. 1978. *Filter Theory and Design: Active and Passive*. Matrix, Beaverton, OR.
- Sheingold, D. H. (Ed.) 1976. *Nonlinear Circuits Handbook*. Analog Devices, Norwood, MA.
- Stephenson, F. W. 1985. *RC Active Filter Design Handbook*. John Wiley & Sons, New York.
- Stout, D. F. and Kaufman, M. (Ed.) 1976. *Handbook of Operational Amplifier Circuit Design*. McGraw-Hill, New York.
- Van Valkenburg, M. E. 1960. *Introduction to Modern Network Synthesis*. John Wiley & Sons, New York.

Further Information

IEEE Transactions on Instrumentation and Measurement. Published bimonthly by the Institute of Electrical and Electronics Engineers.

IEEE Transactions on Circuits and Systems—II: Analog and Digital Signal Processing. Published monthly by the Institute of Electrical and Electronics Engineers.

- The Best of Analog Dialogue, 1967–1991*. 1991. Analog Devices, Norwood, MA. A collection of practical articles covering circuits, systems, and software for signal processing.
- Analog Devices Special Linear Reference Manual* and *Analog Devices Amplifier Reference Manual*. Presents an extensive selection of ICs, modules, and subsystems for signal conditioning.
- Pallás-Areny, R. and Webster, J. G. 1991. *Sensors and Signal Conditioning*. John Wiley & Sons, New York. Provides an excellent introduction to sensors and signal-conditioning circuits required by them.
- Sheingold, D. H. (Ed.) 1980. *Transducer Interfacing Handbook*. Analog Devices, Norwood, MA. Covers signal-conditioning techniques applicable to temperature, pressure, force, level, and flow transducers.

48

Computer-Based Instrumentation Systems

Kris Fuller

National Instruments, Inc.

48.1 [The Power of Software](#)

48.2 [Digitizing the Analog World](#)

48.3 [A Look Ahead](#)

Today's computer-based and networked measurement and automation systems contain powerful software that brings high-performance in a familiar environment. By using these systems, engineers lower their costs while increasing productivity and create more customized solutions that directly match their needs.

Electrical and electronics test instruments have always borrowed from contemporary technology that was widely used elsewhere. The jeweled movement of the nineteenth century used in clocks was first adapted to build analog meters. In the 1930s, when the variable capacitor, variable resistor, and vacuum tubes began to be widely accepted pieces of the radio, the first electronic instruments were introduced using the same components. As display technologies were improved for use on the first televisions, oscilloscopes and analyzers began using the same technology to display the user's measurements (see [Fig. 48.1](#)). These first steps toward computer-based instrumentation met significant challenges. Computerized instrument systems of the 1960s required custom hardware interfaces and low-level assembly languages. The development of standards, such as the introduction in 1976 of the general-purpose interface bus for instrument-to-computer connections, provided the foundation for revolutionary improvements in the development and use of computer-based instruments.

Using the general-purpose interface bus, engineers began writing programs, first in BASIC, then C-based languages, and ultimately graphical development environments, that transformed their computers into efficient instrument controllers that also had the capability of electronically storing data. In the 1980s, digitizers and computer plug-in boards for data acquisition became widely accepted alternatives to expensive standalone instruments. With this combination of software and hardware, engineers began creating "virtual instruments."

Throughout the 1980s and 1990s, the idea of virtual instruments gained wider acceptance as the power of desktop computers increased exponentially. First consumer and then corporate demand for faster, more efficient CPUs, more capable and compact ASICs, faster and larger hard drives, and more capable interface buses played right into the hands of those designing computer-based instrumentation systems.

Today's instrumentation systems are being greatly influenced by the personal computer and Internet revolutions. Personal computers are now equipped with powerful computational engines that can be combined with software to create a sophisticated measurement instrument. The data that are acquired by the computer-based instrumentation system can then be easily transferred to anyone anywhere in the world who is connected to the instrumentation machine via the Internet.

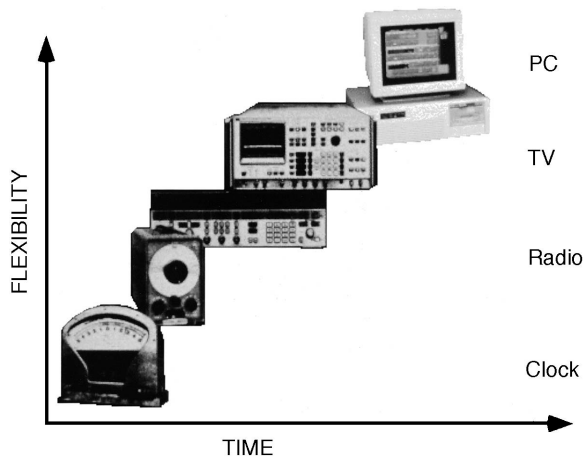

FIGURE 48.1 History of instrumentation.

With advanced software and fast processing and data transfer speeds, computers could recreate the input/output, signal conditioning, storage, digitizing, and analysis capabilities of traditional instruments, using data acquisition (DAQ) and other measurement devices. Moreover, these computer-based devices could experience continuous performance improvements at a much lower cost than traditional standalone instruments as the overall technology of the computer industry continually advanced. Using computer-based tools, engineers could update their instrumentation systems by simply buying a new computer.

To understand the flexibility of computer-based instrumentation, it is instructive to examine more closely the individual components of these systems. First let us examine the software.

48.1 The Power of Software

Modern computer-based instrumentation involves a sophisticated mix of software, from instrument drivers to development software to test management software that integrate seamlessly for a complete enterprise solution. Software lies at the heart of computer-based instrumentation systems. They provide the flexibility and interoperability to provide custom solutions for each application. Each scientist or engineer can use the software to customize the particular test application to meet individual needs. Using traditional instrumentation, the vendor defined the functionality, interface, and parameters of each instrument. These limitations are no longer as prevalent. Scientists and engineers can now define and change the functionality of instrumentation by updating the software or by changing individual hardware components. The interface and parameters the operator interacts with can also be customized to meet individual needs by manipulating the user interface created in the software.

Software used in today's computer-based instrumentation systems reside in one of three levels. Instrument drivers lie at the primary level of computer-based software architecture. Instrument drivers interact with hardware, pulling measurement data into the computer. They also encapsulate the code that handles the command creation and communication functions required to communicate across GPIB with standalone instruments. Instrument drivers make test systems more maintainable because they can be easily upgraded or changed whenever hardware changes are made.

The second level of the software architecture is made up of development software, which can build the graphical user interface (GUI) for a particular instrument or measurement device. The application software layer is also where the specific personality of the computer-based instrument is defined. The customization available at this level depends on the software tool being used. Some software is written for specific hardware, and the functionality, look, and personality are primarily fixed. More open development environments exist and allow the user to greatly customize the instrumentation system. National Instruments LabVIEWTM and Measurement StudioTM and Microsoft Visual Basic and Visual C++ are

examples of such development environments. Using either graphical-based programming or the traditional C-based languages, engineers can customize their measurement interfaces so that they contain only the knobs, switches, and graphs they need for performing high-level analysis and data display.

Since many different options exist when considering application software, it is important to understand the primary uses for this software. Choose a development environment that can be used to increase productivity and fulfill all requirements of the measurement application. National Instruments LabVIEW, Microsoft Visual Basic, and Microsoft Visual C are the most used software packages for instrumentation applications. National Instruments LabVIEW is a graphical development environment that has specific functions for many common measurements and rapid user interface development. Microsoft Visual Basic and Visual C are text-based languages popular in all types of software applications. To fully take advantage of these text-based development environments, measurement focused add-ins are available from several companies.

The third level of the software architecture is typically made up of a test executive, which manages the sequence or order that tests execute. They support several popular test codes and can generate reports using many mainstream software programs such as Microsoft Excel. These off-the-shelf test packages can reduce the cost of testing products while freeing engineers to concentrate on the kinds of tests they are running. They no longer need to spend valuable time building proprietary software that carries out test management functions.

48.2 Digitizing the Analog World

Before software can even begin to analyze measurement data, it must be converted from the analog world into the computer's way of thinking. This involves numerous types of hardware that digitize analog signals. As explained previously, when acquiring these signals from standalone instrument hardware, the instrument driver software arranges the data so that development software can perform an additional level of data analysis and presentation. However, other hardware such as plug-in measurement devices, programmable logic controllers (PLCs), distributed I/O systems, and devices that support USB, IEEE-1394, and serial communication can also acquire signals using their own set of driver software (see Fig. 48.2).

As noted previously, with today's technology, computer-based hardware can acquire signals at rates that often match or exceed that of standalone instruments, and computer-based measurement devices can digitize these signals at speeds and resolutions that rival traditional instruments. However, with computer-based technology, hardware integration with software produces some key differences. With this powerful combination, engineers can create instrumentation that specifically meets their needs. They define the features instead of an instrument vendor making those decisions for them. Once more, with computer-based devices, engineers can easily send data from their instruments across the Internet, using Ethernet and other standard computer-based technologies.

This flexibility, of course, brings choices. When choosing among the different types of measurement hardware, users must keep in mind their purpose or application. Acquiring high-speed signals, say up to 100 MHz, or rapidly changing signals, such as with sound or vibration analysis, can be done with digitizers and dynamic signal analyzers that plug-in to the computer via the PCI or PXI/CompactPCI bus. Making the right choice depends on the application.

Plug-in data acquisition boards have the advantage of being able to acquire data directly into the computer memory at very high speeds. One disadvantage to plug-in boards is that, by themselves, they do not provide an industrial interface for all transducers and signals. For example, thermocouples generate very small signals, and therefore their signals need to be linearized and require cold-junction compensation. Other applications may require particular signal conditioning features, like multiplexing to increase channel count, excitation for proper behavior, filtering to remove noise, isolation to protect the system from high voltage signals, or amplification for low-voltage signals. A specialized signal conditioning add-on is usually used in conjunction with a data acquisition board to fulfill the needs of connecting the computer to the external world.

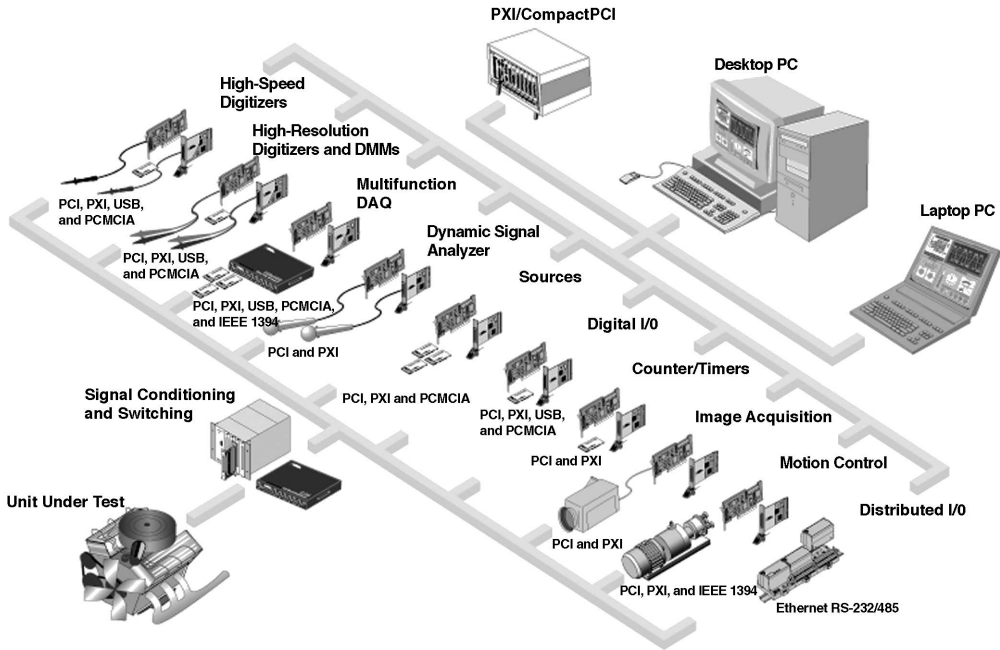

FIGURE 48.2

Some applications are in areas where having computers located adjacent to the measurements is not plausible. Distributed input–output devices are available for these types of applications. The digitizing and conditioning hardware is connected back to the computer via a serial, RF, or Ethernet connection.

Various types of measurements can be brought into the computer and sent from the computer in today’s measurement and automation applications. Image acquisition devices and motion controllers can also be integrated into most measurement applications.

48.3 A Look Ahead

Today’s software incorporates the power of the Internet and standard communication protocols, making the development of networked measurement applications simple, whether collecting data across the Web or publishing data via a Web browser.

This integration of the Web opens the door to new levels of software architecture that include entire enterprises. Engineers and scientists increasingly understand that acquiring and analyzing data is only a part of the equation. Data from these tests can be stored in central databases where it can be shared with peers. This sharing or management of data can lead to powerful efficiencies. Re-analysis of tests, comparisons of tests, and combinations of data can lead to new understandings and better decision-making.

Setting up these management systems requires a web of data collection, data repository, and reporting and analysis systems—all of which can be set up on computers.

Equally powerful changes are occurring with computer-based hardware. Embedded processors can now run real-time operating systems that perform deterministic tasks independently of the computer’s CPU.

Developing real-time applications now can occur on a familiar desktop computer and Microsoft Windows-based environment. It opens a whole wealth of applications to engineers who are not steeped in the intricacies of traditional real-time programming but need the demanding performance that it delivers.

The instrumentation industry has always leveraged common available technologies to create power test equipment. Computer-based technologies and the Internet have enabled the measurement and automation community to create more customized solutions that are more connected to the everyday world than ever before.

49

Software Design and Development^{*1}

Margaret H. Hamilton
Hamilton Technologies, Inc.

- 49.1 The Notion of Software
- 49.2 The Nature of Software Engineering
- 49.3 Development Before the Fact
Language • Technology • Process
- 49.4 Experience with DBTF
- 49.5 Conclusion

A software-based system can be neatly compared with a biological entity called a superorganism. Comprising software, hardware, peopeware and their interconnectivity (such as the Internet), and requiring all to survive, the silicon superorganism is itself a part of a larger superorganism—for example, a medical system including patients, drugs, drug companies, doctors, hospitals, and health care centers; a space mission including the spacecraft, the laws of the universe, mission control, and the astronauts; a system for researching genes including funding organizations, funds, researchers, research subjects, and genes; a financial system including investors, money, politics, financial institutions, stock markets, and the health of the world economy; or it could be just the business itself.

Whether that business be government, academic, or commercial, the software-based system, like its biological counterpart, must grow and adapt to meet rapidly changing requirements. And, like other organisms, the business has both physical infrastructure and operational policies, which guide and occasionally constrain its direction and the rate of evolution, which it can tolerate without becoming dysfunctional.

Compared to a biological superorganism, which may take many generations to effect even a minor hereditary modification, software can be modified immediately. This makes it far superior in this respect to the biological entity in terms of its evolutionary adaptability. Continuity of business rules and/or the physical infrastructure provides a natural tension between “how fast the software can change” and “how rapidly the overall system can accept change.” Software, the brain of the silicon superorganism, controls the action of the entire entity. Keep in mind, however, it was a human being that created the software.

In this chapter we will discuss the tenets of software, what it is and how it is developed, as well as the precepts of software engineering, which are the methodologies by which ideas are turned into software.²

¹ Parts of this chapter were taken from *Object Thinking: Development Before the Fact*, M. H. Hamilton and W. R. Hackler, in press.

²001, 001 Tool Suite, DBTF, Development Before the Fact, SOO, and System Oriented Objects are all trademarks of Hamilton Technologies, Inc.

49.1 The Notion of Software

Software is the embodiment of logical processes, whether in support of business functions or in control of physical devices. The nature of software as an instantiation of process can apply very broadly, when modeling complex organizations, or very narrowly as when implementing a discrete numerical algorithm. In the former case, there can be significant linkages between reengineering businesses to accelerate the rate of evolution—even to the point of building operational models, which then transition into application suites and thence into narrowly focused implementations of algorithms, as above. Software thus has a potentially wide range of application, and that well designed has a potentially long period of utilization.

While some would define software as solely the code that a programming language generates from the compilation process, a broader and more precise definition includes requirements, specifications, designs, program listings, documentation, procedures, rules, measurements, and data as well as the tools used to create, test, optimize, and implement the software.

That there is more than one definition of software is a direct result of the confusion about the very process of software development itself. A 1991 study by the Software Engineering Institute (SEI) [1] amplifies this rather startling problem. SEI developed a methodology for classifying an organization's "software process maturity" into one of five levels which range from Level 1, the initial level (where there is no formalization of the software process), to Level 5, the optimizing level where methods, procedures, and metrics are in place with a focus toward continuous improvement in software reliability. The result of this study showed that fully 86% of organizations surveyed in the United States were at Level 1 where the terms "ad-hoc," "dependent on heroes," and "chaotic" are commonly applied. And, given the complexity of today's Internet-based applications, it would not be surprising to see the percentage of Level 1 organizations increase.

Creating order from this chaos requires an insightful understanding into the component parts of software as well as the development process. Borrowing again from the world of natural science, an entelechy is something complex that emerges when a large number of simple objects are put together. For example, one molecule of water is rather boring in its utter lack of activity. But pour a bunch of these molecules into a glass and there is a ring of ripples on the water's surface. If many of these molecules are combined, the result is an ocean. So too software. By itself, a line of code is a rather simple item. But combine many lines and the result is a complex program. Add additional programs and the result could be a system that can put a person on the moon.

Although the whole is indeed bigger than the sum of its parts, one must still understand those parts if the whole is to work in an orderly and controlled fashion. Like a physical entity, software can "wear" as a result of maintenance, changes in the underlying system, and updates made to accommodate the requirements of the ongoing user community. Entropy is a significant phenomenon in software, especially for Level 1 organizations.

Software at the lowest programming level is termed source code. This differs from executable code (i.e., which can be executed by the hardware to perform one or more specified functions) in that software is written in one or more programming languages and cannot, by itself, be executed by the hardware. A programming language is a set of words, letters, numerals, and abbreviated mnemonics, regulated by a specific syntax, used to describe a program to a computer. There are a wide variety of programming languages, many of them tailored for a specific type of application. C, one of today's more popular programming languages, is used in engineering as well as business environments while object-oriented languages such as C++ [2] and Smalltalk have been gaining acceptance in both of these environments. More recently, Java [3] has been gaining acceptance. In fact, it has become a language of choice for Internet-based applications. In the recent past, engineering applications have often used programming languages such as FORTRAN, HAL (or HAL/s) for NASA space applications, and Ada for government applications while commercial business applications have favored COBOL (COmmon Business Oriented Language). For the most part one finds that in any given organization there are no prescribed rules, other than those related to what is most popular at the moment, which dictate which languages are to be used. And, as one might expect, a wide diversity of languages is being deployed.

The programming language, whether it be C++, Java, Visual BASIC, C, FORTRAN, HAL/s, COBOL, or something else, provides the capability to code such logical constructs as that having to do with:

- *User Interface.* Provides a mechanism whereby the ultimate end-user can input, view, manipulate, and query information contained in an organization's computer systems. Studies have shown that productivity increases dramatically when visual user interfaces are provided. Known as GUIs (graphical user interfaces), each operating system provides its own variation. Some common graphical standards are Motif for UNIX systems and Microsoft Windows for PC-based systems.
- *Model Calculations.* Perform the calculations or algorithms (step-by-step procedures for solving a problem) intended by a program, e.g., process control, payroll calculations, or a Kalman filter.
- *Program Control.* Exerts control in the form of comparisons, branching, calling other programs, and iteration to carry out the logic of the program.
- *Message Processing.* There are several varieties of message processing. Help-message processing is the construct by which the program responds to requests for help from the end-user. Error-message processing is the automatic capability of the program to notify and then recover from an error during input, output, calculations, reporting, communications, etc. And, in object-oriented development environments, message processing implies the ability of program objects to pass information to other program objects.
- *Moving Data.* Programs store data in a data structure. Data can be moved between data structures within a program, moved from an external database or file to an internal data structure or from user input to a program's internal data structure. Alternatively, data can be moved from an internal data structure to a database or even to the user interface of an end-user. Sorting and formatting are data moving operations used to prepare the data for further operations.
- *Database.* A collection of data (objects¹) or information about a subject or related subjects, or a system (for example, an engine in a truck or a personnel department in an organization). A database can include objects, such as forms and reports or a set of facts about the system (for example, the information in the personnel department needed about the employees in the company). A database is organized in such a way so as to be easily accessible to computer users. Its data is a representation of facts, concepts, or instructions in a manner suitable for processing by computers. It can be displayed, updated, queried, printed, and reports can be produced from it. A database can organize data in several ways including in a relational, hierarchical, network, or object-oriented format.
- *Data Declaration.* It describes data and data structures to a program. An example would be associating a particular data structure with its type (for example, data about a particular employee might be of type person).
- *Object.* A person, place, or thing, which could be physical or abstract. An object contains other more primitive objects (or data) and a set of operations to manipulate objects (or data). When brought to life, it knows things (called attributes) and can do things (to change itself or interact with other objects). For example, in a robotics system a robot object may contain the functions to move its own armature to the right, while it is coordinating with another robot to transfer yet another object. Objects can communicate with each other through a communications medium (e.g., message passing, radio waves, Internet).
- *Real-Time.* A software system that satisfies critical timing requirements. The correctness of the software depends on the results of computation, as well as on the time at which the results are produced. Real-time systems can have varied requirements such as performing a task within a specific deadline and processing data in connection with another process outside of the computer. Applications such as transaction processing, avionics, interactive office management, automobile systems, and video games are examples of real-time systems.

¹Data and object are used interchangeably throughout this chapter to define information in a software program.

- *Distributed.* Any system in which a number of independent, interconnected processes can cooperate. The client/server model is one of the most popular forms of distribution in use today. In this model, a client initiates a distributed activity and a server carries out that activity.
- *Simulation.* The representation of selected characteristics of the behavior of one physical or abstract system by another system. For example, a software program can simulate an airplane or an organization or another software program.
- *Documentation.* It includes the description of requirements, specification, and design as well as written or generated documentation, which describe how each program within the larger system operates and can be used; and comments which describe the operation of the program that are stored internally in the program.
- *Tools.* The software programs used to design, develop, test, analyze, or maintain system designs or another software program and its documentation. They include code generators, compilers, editors, database management systems (DBMS), GUI builders, debuggers, operating systems, and software development and systems engineering tools referred to in the 1990s as computer-aided software engineering (CASE) tools and now often referred to as life-cycle design or life-cycle development environments, which combine a set of tools, including some of those listed above.

Although the reader should by now understand the dynamics of a line of source code, where that line of source code fits into the superorganism of software is dependent upon many variables. This includes the industry the reader hails from as well as the software development paradigm used by the organization.

As a base unit, a line of code can be joined with other lines of code to form many things. In a traditional software environment many lines of code form a program, sometimes referred to as an application program or just plain application. But lines of source code by themselves cannot be executed. First, source code must be run through what is called a compiler to create an object code. Next, the object code is run through a linker which is used to construct an executable code. Compilers are programs themselves. Their function is twofold. The compiler first checks the source code for obvious syntax errors and then, if it finds none, creates object code for a specific operating system. UNIX, Linux (a spinoff of UNIX), and NT are all examples of operating systems. An operating system can be thought of as a supervising program that controls the application programs that run under its control. Since operating systems (as well as computer architectures) can be different from each other, the object code resulting from the source code compiled for one operating system cannot be executed under a different kind of operating system—without a recompilation.

Solving a complex business or engineering problem often requires more than one program. One or more programs that run in tandem to solve a common problem is known collectively as a system. The more modern technique of object-oriented development dispenses with the notion of the program altogether and replaces it with a classification-oriented concept of an object.

Where a program can be considered a critical mass of code, which performs many functions in the attempt to solve a problem with little consideration for object boundaries, an object is associated with the code to solve a particular set of functions having to do with just that type of object. By combining objects, like molecules, it is possible to create more organized systems than those created by traditional means. Software development becomes a speedier and less error-prone process as well. Since objects can be reused, once tested and implemented, they can be placed in a library for other developers to reuse. The more objects in the library, the easier and quicker it is to develop new systems. And since the objects being reused have, in theory, already been warranted (i.e., they've been tested and made error-free), there is less possibility that object-oriented systems will have major defects.

The process of writing programs and/or objects is known as software development, or software engineering. It is composed of a series of steps or phases, collectively referred to as a development life cycle. The phases include (at a bare minimum) the following: an analysis or requirements phase, where the business problem is dissected and understood; a specification phase, where decisions are made as to how the requirements will be fulfilled (e.g., deciding what functions are allocated to software and what functions are allocated to hardware); a design phase, where everything from the GUI to the database to

the output is designed or selected as part of a design; an implementation or programming phase, where one or more tools are used to write and/or generate code; a testing (debugging) phase, where the code is tested against a business test case and errors in the program are found and corrected; an installation phase, where the systems are placed in production; and a maintenance phase, where modifications are made to the system. But different people develop systems in different ways. These different paradigms make up the opposing viewpoints of software engineering.

49.2 The Nature of Software Engineering

Engineers often use the term “systems engineering” to refer to the tasks of specifying, designing, and simulating a non-software system such as a bridge or electronic component. Although software may be used for simulation purposes, it is but one part of the systems engineering process. Software engineering, on the other hand, is concerned with the production of nothing but software.

In the 1970s industry pundits began to notice that the cost of producing large-scale systems was growing at a high rate and that many projects were failing or, at the very least, resulting in unreliable products. Dubbed the software crisis, its manifestations were legion and the most important include the following:

- *Programmer Productivity.* In government in the 1980s, an average developer using C was expected to produce 10 lines of code per day (an average developer within a commercial organization was expected to produce 30 lines a month); today the benchmark in the government is more like 2 to 5 lines a day while at the same time the need is dramatically higher than that, perhaps by several orders of magnitude, ending up with a huge backlog. Programmer productivity is dependent upon a plethora of vagaries—from expertise to complexity of the problem to be coded to the size of the program that is generated. The science of measuring the productivity of the software engineering process is called metrics. Just as there are many diverse paradigms in software engineering itself, there are many paradigms of software measurement. Today’s metric formulas are complex and often take into consideration the following: cost, time to market, productivity on prior projects, data communications, distributed functions, performance, heavily used configuration, transaction rate, online data entry, end-user efficiency, online update, complex processing, reusability, installation ease, operational ease, and multiplicity of operational sites.
- *Defect Removal Costs.* The same variables that affect programmer productivity affect the cost of “debugging” the programs and/or objects generated by those programmers. It has been observed that the testing and correcting of programs consumes a large share of the overall effort.
- *Development Environment.* Development tools and development practices greatly affect the quantity and quality of software. Most of today’s design and programming environments contain only a fragment of what is really needed to develop a complete system. Life-cycle development environments provide a good example of this phenomena. Most of these tools can be described either as addressing the upper part of the life cycle (i.e., they handle the analysis and design) or the lower part of the life cycle (i.e., they handle code generation). There are few integrated tools on the market (i.e., that seamlessly handle both upper and lower functionalities). There are even fewer tools that add simulation, testing, and cross-platform generation to the mix. Rare are the tools that seamlessly integrate system design to software development.
- *GUI Development.* Developing GUIs is a difficult and expensive process unless the proper tools are used. The movement of systems from a host-based environment to the workstation and/or PC saw the entry of countless GUI development programs onto the marketplace. But the vast majority of these GUI-based tools do not have the capability of developing the entire system (i.e., the processing component as opposed to merely the front-end). This leads to fragmented and error-prone systems. To be efficient, the GUI builder must be well integrated into the software development environment.

The result of these problems is that most of today’s systems require more resources allocated to maintenance than to the original development of that system. Lientz and Swanson [4] demonstrate that the problem is, in fact, larger than the one originally discerned during the 1970s. Software development is

indeed complex, and the limitations on what can be produced by teams of software engineers given finite amounts of time, budgeted dollars, and talent have been amply documented by Jones [5].

Essentially the many paradigms of software engineering attempt to rectify the causes of declining productivity and quality. Unfortunately, this fails because current paradigms treat symptoms rather than the root problem. In fact, software engineering is itself extremely dependent upon both the software and hardware as well as the business environments upon which they sit [6].

SEI's process maturity grid very accurately pinpoints the root of most of our software development problems. The fact that a full 86% of organizations studied remain at the ad hoc or chaotic level indicate that only a few organizations (the remaining 14%) have adopted any formal process for software engineering. Simply put, 86% of all organizations react to a business problem by just writing codes. If they do employ a software engineering discipline, in all likelihood it is one that no longer fits the requirements of the ever-evolving business environment.

In the 1970s, the "structured methodology" was popularized. Although there were variations on the theme (i.e., different versions of the structured technique included the popular Gane-Sarson method and Yourdon method), for the most part, it provided a methodology to develop usable systems in an era of batch computing. In those days, online systems with even the dumbest of terminals were a radical concept and GUIs were as unthinkable as the fall of the Berlin Wall.

Although times have changed and today's hardware is one thousand times more powerful than when structured techniques were introduced, this technique still survives. And it survives in spite of the fact that the authors of these techniques have moved on to more adaptable paradigms, and more modern software development and systems engineering environments have entered the market.

In 1981, Finkelstein and Martin popularized "information engineering" [7] for the more commercially oriented users (i.e., those whose problems to be solved tended to be more database centered) which, to this day, is quite popular among mainframe developers with an investment in CASE strategies of the 1990s. Information engineering is essentially a refinement of the structured approach. However, instead of focusing on the data so preeminent in the structured approach, information engineering focuses on the information needs of the entire organization. Here business experts define high-level information models, as well as detailed data models. Ultimately, the system is designed from these models.

Both structured and information engineering methodologies have their roots in mainframe-oriented commercial applications. Today's migration to client/server technologies (where the organization's data can be spread across one or more geographically distributed servers while the end-user uses his or her GUI of choice to perform local processing), disables most of the utility of these methodologies. In fact, many issues now surfacing in more commercial applications are not unlike those that needed to be addressed earlier in the more engineering-oriented environments such as telecommunications and avionics.

Client/server environments are characterized by their diversity. One organization may store its data on multiple databases, program in several programming languages, and use more than one operating system, and hence, different GUIs. Since software development complexity is increased 100-fold in this new environment, a better methodology is required. Today's object-oriented techniques solve some of the problems. Given the complexity of the client/server environment, code trapped in programs is not flexible enough to meet the needs of this type of environment. We have already discussed how coding via objects rather than large programs engenders flexibility as well as productivity and quality through reusability. But object-oriented development is a double-edged sword.

While it is true that to master this technique is to provide dramatic increases in productivity, the sad fact of the matter is that object-oriented development, if done inappropriately, can cause problems far greater than problems generated from structured techniques. The reason for this is simple. The stakes are higher. Object-oriented environments are more complex than any other, the business problems chosen to be solved by object-oriented techniques are far more complex than other types of problems, and there are few if any conventional object-oriented methodologies and corollary tools to help the development team develop good systems. There are many flavors of object orientation. But with this diversity comes some very real risks. As a result, the following developmental issues must be considered before the computer is even turned on.

- Integration is a challenge and needs to be considered at the onset. With traditional systems, developers rely on mismatched modeling methods to capture aspects of even a single definition. Whether it be integration of object to object, module to module, phase to phase, or type of application to type of application, the process can be an arduous one. The mismatch of products used in design and development compounds the issue. Integration is usually left to the devices of myriad developers well into development. The resulting system is sometimes hard to understand and objects are difficult to trace. The biggest danger is there is little correspondence to the real world. Interfaces are often incompatible and errors usually propagate throughout development. As a result, systems defined in this manner can be ambiguous and just plain incorrect.
- Errors need to be minimized. Traditional methods including those that are object oriented can actually encourage the propagation of errors, such as propagating errors through the reuse of objects with embedded and inherited errors throughout the development process. Errors must be eliminated from the very onset of the development process before they take on a life of their own.
- Languages need to be more formal.² Although some languages are formal and others are friendly, it is hard to find languages both *formal* and *friendly*. Within environments where more informal approaches are used, lack of traceability and an overabundance of interface errors are a common occurrence. Recently, more modern software requirements languages have been introduced (for example, the Unified Modeling Language, UML [8]), most of which are informal (or semi-formal); some of these languages were created by “integrating” several languages into one. Unfortunately, the bad comes with the good—often, more of what is not needed and less of what is needed; and since the formal part is missing, common semantics need to exist to reconcile differences and eliminate redundancies.
- The syndrome of locked-in design needs to be eliminated. Often, developers are forced to develop in terms of an implementation technology that does not have an open architecture, such as a specific database schema or a GUI. Bad enough is to attempt an evolution of such a system; worse yet is to use parts of it as reusables for a system that does not rely on those technologies. Well thought-out and formal business practices and their implementation will help minimize this problem within an organization.
- Flexibility for change and handling the unpredictable must be dealt with up front. Too often it is forgotten that the building of an application must take into account its evolution. Users change their minds, software development environments change, and technologies change. Definitions of requirements in traditional development scenarios concentrate on the application needs of the user, but without consideration of the potential for the user’s needs or environment to change. Porting to a new environment becomes a new development for each new architecture, operating system, database, graphics environment, or language. Because of this, critical functionality is often avoided for fear of the unknown, and maintenance, the most risky and expensive part of a system’s life cycle, is left unaccounted for during development. To address these issues, tools and techniques must be used to allow cross technology and changing technology, as well as provide for changing and evolving architectures.
- Developers must prepare ahead of time for parallelism and distributed environments. Often, when it is known that a system is targeted for a distributed environment, it is first defined and developed for a single processor environment and then redeveloped for a distributed environment—an unproductive use of resources. Parallelism and distribution must be dealt with at the very start of the project.
- Resource allocation should be transparent to the user. Whether or not a system is allocated to distributed, asynchronous, or synchronous processors and whether or not two or ten processors are selected, with traditional methods, it is still up to the designer and developer to be concerned

²See Defining Terms for definition of formal.

with incorporating such detail into the application. There is no separation between the specification of what the system is to do vs. how the system does it. This results in far too much implementation detail to be included at the level of design. Once such a resource architecture becomes obsolete, it is necessary to redesign and redevelop those applications which have old designs embedded within them.

- Automation that minimizes manual work needs to replace “make work” automated solutions. In fact, automation itself is an inherently reusable process. If a system does not exist for reuse, it certainly does not exist for automation. But most of today’s development process is needlessly manual. Today’s systems are defined with insufficient intelligence for automated tools to use them as input. In fact, automated tools concentrate on supporting the manual process instead of doing the real work. Typically, developers receive definitions, which they manually turn into code. A process that could have been mechanized once for reuse is performed manually again and again. Under this scenario, even when automation attempts to do the real work, it is often incomplete across application domains or even within a domain, resulting in incomplete code such as shell code. The generated code is often inefficient or hardwired to a particular kind of algorithm, an architecture, a language, or even a version of a language. Often partial automations need to be integrated with incompatible partial automations or manual processes. Manual processes are needed to complete unfinished automations.
- Run-time performance analysis (decisions between algorithms or architectures) should be based on formal definitions. Conventional system definitions contain insufficient information about a system’s run-time performance, including that concerning the decisions between algorithms or architectures. System definitions must consider how to separate the system from its target environment. Design decisions, where this separation is not taken into account, thus depend on analysis of results from ad hoc “trial and error” implementations and associated testing scenarios.
- The creation of reliable reusable definitions must be promoted, especially those that are inherently provided. Conventional requirements definitions lack the facilities to help find, create, use, and ensure commonality in systems. Modelers are forced to use informal and manual methods to find ways to divide a system into components natural for reuse. These components do not lend themselves to integration and, as a result, they tend to be error-prone. Because these systems are not portable or adaptable, there is little incentive for reuse. In conventional methodologies, redundancy becomes a way of doing business. Even when methods are object oriented, developers are often left to their own devices to explicitly make their applications object oriented. This is because these methods do not support all that is inherent to the process of object orientation.
- Design integrity is the first step to usable systems. Using traditional methods, it is not known if a design is a good one until its implementation has failed or succeeded. Usually, a system design is based on short-term considerations because knowledge is not reused from previous lessons learned. Development, ultimately, is driven towards failure. The solution is to have an inherent means to build reliable, reusable definitions.

Once these issues are addressed, software will cost less and take less time to develop. But time is of the essence. These issues are becoming compounded and even more critical as developers prepare for the distributed environments that go hand in hand with the increasing predominance of Internet applications.

With respect to the challenges described above, an organization has several options, ranging from one extreme to the other. The options include: (1) keep things the same; (2) add tools and techniques that support business as usual, but provide relief in selected areas; (3) bring in more modern but traditional tools and techniques to replace existing ones; (4) use a new paradigm with the most advanced tools and techniques that formalizes the process of software development, while at the same time capitalizing on software already developed; or (5) completely start over with a new paradigm that formalizes the process of software development and uses the most-advanced tools and techniques.

49.3 Development Before the Fact

Thus far, this chapter has explained the derivation of software and attempted to show how it has evolved over time to become the true “brains” of any automated system. But, like a human brain, this software brain must be carefully architected to promote productivity, foster quality, and enforce control and reusability.

Traditional software engineering paradigms fail to see the software development process from the larger perspective of the superorganism described at the beginning of this chapter. It is only when we see the software development process as made of discrete, but well-integrated, components can we begin to develop a methodology that can produce the very benefits that have been promised by the advent of software decades ago.

Software engineering, from this perspective, consists of a methodology as well as a series of tools with which to implement the solution to the business problem at hand. But even before the first tool can be applied, the software engineering methodology must be deployed to assist in specifying the requirements of the problem. How can this be accomplished successfully in the face of the issues needed to be addressed outlined in the last section? How can this be accomplished in situations where organizations must develop systems that run across diverse and distributed hardware platforms, databases, programming languages, and GUIs when traditional methodologies make no provision for such diversity? And how can software be developed without having to fix or “cure” those myriad of problems, which result “after the fact” of that software’s development?

What is required is a radical revision of the way we build software, an approach that understands how to build systems using the right techniques at the right time. First and foremost, it is a preventative approach. This means it provides a framework for doing things right the first time. Problems associated with traditional methods of design and development are prevented “before the fact” just by the way a system is defined. Such an approach would concentrate on preventing problems of development from even happening rather than letting them happen “after the fact,” and fixing them after they have surfaced at the most inopportune and expensive point in time.

Consider such an approach in its application to a human system. To fill a tooth before it reaches the stage of a root canal is curative with respect to the cavity, but preventive with respect to the root canal. Preventing the cavity by proper diet prevents not only the root canal, but the cavity as well. To follow a cavity with a root canal is the most expensive alternative, to fill a cavity on time is the next most expensive, and to prevent these cavities in the first place is the least expensive option.

Preventiveness is a relative concept. For any given system, be it human or software, one goal is to prevent, to the greatest extent and as early as possible, anything that could go wrong in the life cycle process.

With a preventative philosophy, systems would be carefully constructed to minimize development problems from the very outset. A system could be developed with properties that controlled its very own design and development. One result would be reusable systems that promote automation. Each system definition would model both its application and its life cycle with built-in constraints—constraints that protect the developer, but yet do not take away his flexibility.

The philosophy behind preventative systems is that reliable systems are defined in terms of reliable systems. Only reliable systems are used as building blocks, and only reliable systems are used as mechanisms to integrate these building blocks to form a new system. The new system becomes reusable for building other systems.

Effective reuse is a preventative concept. That is, reusing something (e.g., requirements or code) that contains no errors to obtain a desired functionality avoids both the errors and the cost of developing a new system. It allows one to solve a given problem as early as possible, not at the last moment. But to make a system truly reusable, one must start not from the customary end of a life cycle, during the implementation or maintenance phase, but from the very beginning.

Preventative systems are the true realization of the entelechy construct where molecules of software naturally combine to form a whole much greater than the sum of its parts. Or one can think of constructing systems from the tinker toys of our youth. One recalls that the child never errs in building

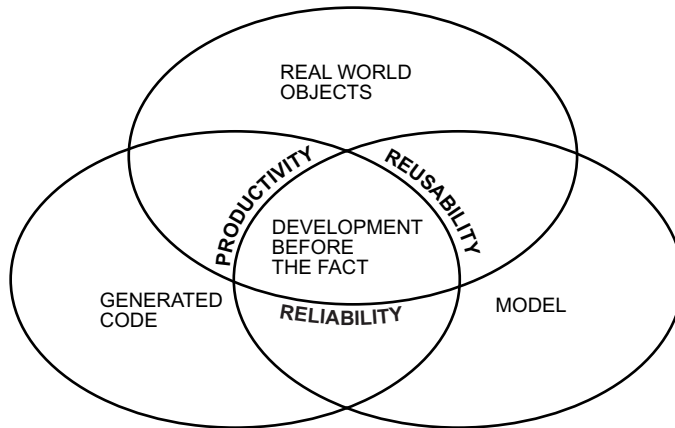

FIGURE 49.1 The development before the fact paradigm.

magnificent structures from these tinker toys. Indeed, tinker toys are built from blocks that are architected to be perpetually reusable, perfectly integratable, and infinitely user-friendly.

One approach that follows this preventative philosophy is development before the fact (DBTF), as shown in Fig. 49.1. Not yet in the mainstream, it has been used successfully by research and “trail blazer” organizations and is now being adopted for more commercial use. This technology is described in order to illustrate, by example, the potential that preventative approaches have.

Where traditional approaches begin the process of developing software after the fact, the DBTF paradigm is very much about beginnings. It was derived from the combination of steps taken to solve the problems of traditional systems engineering and software development. DBTF includes a technology, a language, and a process (or methodology) based on a formal theory.

Language

Once understood, the characteristics of good design can be reused by incorporating them into a language for defining any system (i.e., not just a software system). One language based on DBTF is a formalism for representing the mathematics of systems. A system defined with this language has properties that come along “for the ride” that in essence control its own destiny. Based on a theory (DBTF) that extends traditional mathematics of systems with a unique concept of control, this formal, but friendly language has embodied within it a natural representation of the physics of time and space. With this language, every object is a system-oriented object (SOO), an integration that includes aspects of being function oriented (including dynamics) and object oriented. Instead of systems being object oriented, objects are systems oriented. All systems are objects and all objects are systems.

Because of this, many things heretofore not believed possible with traditional methods are possible. A DBTF system inherently integrates all of its own objects (and all aspects, relationships, and viewpoints of these objects) and the combinations of functionality, including timing, using these objects; maximizes its own reliability and flexibility to change (including the change of target requirements, static and dynamic architectures, and processes and as well reconfiguration in real time); capitalizes on its own parallelism and traceability; supports its own run-time performance analysis; and maximizes the potential for its own reuse (providing inherent resource allocation and reuse without need for the designer’s intervention); and it provides the ability to automate design and development wherever and whenever possible. Each DBTF system is defined with built-in quality, built-in productivity, and built-in control.

The language—meta-language, really—is the key to DBTF. Its main attribute is to help the designer reduce the complexity and bring clarity into his thinking process, turning it into the ultimate reusable, which is wisdom itself. It can be used to define any aspect of any system and integrate it with any other aspect.

The crucial point is that these aspects are directly related to the real world and, therefore, the same language can be used to define system requirements, specifications, design, and detailed design for functional, resource, and resource allocation architectures throughout all levels and layers of seamless definition, including hardware, software, and peopleware.

This language based on DBTF can be used to define organizations of people, missile or banking systems, cognitive systems, as well as real-time or database environments and is, therefore, appropriate across industries, academia, or government.

Technology

Real-world experience sets the stage for the DBTF technology. Having evolved over three decades, the theory has roots in the worlds of systems theory, formal methods, and object technology. The DBTF technology embodies the theory, the language supports its representation, and its automation supports its application and use. Each is evolutionary (in fact, recursively so), with experience feeding the theory and the theory feeding the language, which in turn feeds the automation. All are used, in concert, to design systems and build software.

The DBTF approach had its beginnings in 1968 with an empirical analysis of the Apollo space missions. A better way was needed to define and develop systems than the ones being used and available because the existing ones (just like the traditional ones today) did not solve the pressing problems. Research for developing software for man-rated missions led to the finding that interface errors accounted for approximately 75% of all errors found in the flight software during final testing (in traditional development, the figure is as high as 90%). Such errors include data flow, priority, and timing errors from the highest levels of a system to the lowest level of detail. Each error was categorized according to how it could be prevented just by the way a system is defined. This work led to a theory and methodology for defining a system that would eliminate all interface errors.

The first technology derived from this theory concentrated on defining and building reliable systems. Having realized the benefits of addressing one major issue, such as reliability, research continued to evolve by addressing other major issues the same way, that is, just by the way a system is defined [9–11].

DBTF is a function- and object-oriented approach based on a unique concept of control, which is lacking in any other software engineering paradigm. The foundations are based on a set of axioms and on the assumption of a universal set of objects. Each axiom defines a relation of immediate domination. The union of the relations defined by the axioms is control. Among other things, the axioms establish the relationships of an object for invocation, input and output, input and output access rights, error detection and recovery, and ordering during its developmental and operational states. [Table 49.1](#) summarizes some of the properties of objects within DBTF systems.

Process

Where software engineering fails is in its inability to grasp that not only the right paradigm (out of many paradigms) must be selected, but that the paradigm must be part of an environment that provides an integrated automated means to solve the problem at hand. What this means is that the paradigm must be coupled with an integrated system of tools with which to implement the results of utilizing that paradigm to develop the model of the system.

Essentially, the paradigm generates the model and a toolset must be provided to generate the system. DBTF provides this next-generation capability.

This DBTF approach is used throughout a life cycle, starting with requirements and continuing with functional analysis, simulation, specification, analysis, design, system architecture design, algorithm development, implementation, configuration management, testing, maintenance, and reverse engineering. Its users include end users, managers, system engineers, software engineers, and test engineers.

The DBTF process combines mathematical perfection with engineering precision. Its purpose is to facilitate the “doing things right in the first place” development style, avoiding the “fixing wrong things up” traditional approach. Its automation is developed with the following considerations: error prevention

TABLE 49.1 System Oriented Object Properties of Development Before the Fact

Quality (better, faster, cheaper)

- Reliable
- Affordable

Reliable (better)

- In control and under control
- Based on a set of axioms
 - domain identification (intended, unintended)
 - ordering (priority and timing)
 - access rights: Incoming object (or relation), outgoing object (or relation)
 - replacement
- Formal
 - consistent, logically complete
 - necessary and sufficient
 - common semantic base
 - unique state identification
- Error free (based on formal definition of “error”)
 - always gets the right answer at the right time and in the right place
 - satisfies users and developers intent
- Handles the unpredictable
- Predictable

Affordable (faster, cheaper)

- Reusable
- Optimizes resources in operation and development
 - in minimum time and space
 - with best fit of objects to resources

Reusable

- Understandable, integratable and maintainable
- Flexible
- Follows standards
- Automation
- Common definitions
 - natural modularity
 - natural separation (e.g., functional architecture from its resource architectures);
 - dumb modules
 - an object is integrated with respect to structure, behavior and properties of control
 - integration in terms of structure and behavior
 - type of mechanisms
 - function maps (relate an object’s function to other functions)
 - object type maps (relate objects to objects)
 - structures of functions and types
 - category
 - relativity
 - instantiation
 - polymorphism
 - parent/child
 - being/doing
 - having/not having
 - abstraction
 - encapsulation
 - replacement

Handles the unpredictable

- throughout development and operation
- Without affecting unintended areas
- Error detect and recover from the unexpected
- Interface with, change and reconfigure in asynchronous, distributed, real-time environment

Flexible

- Changeable without side effects
- Evolvable
- Durable
- Reliable
- Extensible
- Ability to break up and put together
 - one object to many: modularity, decomposition, instantiation
 - many objects to one: composition, applicative operators, integration, abstraction
- Portable
 - secure
 - diverse and changing layered developments
 - open architecture (implementation, resource allocation, and execution independence)
 - plug-in (or be plugged into) or reconfiguration of different modules
 - adaptable for different organizations, applications, functionality, people, products

Automation

- the ultimate form of reusable
- formalize, mechanize, then automate
 - it
 - its development
 - that which automates its development

Understandable, integratable and maintainable

- Reliable
- A measurable history
- Natural correspondence to real world
 - persistence, create and delete
 - appear and disappear
 - accessibility
 - reference
 - assumes existence of objects
 - real time and space constraints
 - representation
 - relativity, abstraction, derivation
- Provides user friendly definitions
 - recognizes that one user’s friendliness is another user’s nightmare
 - hides unnecessary detail (abstraction)
 - variable, user selected syntax
 - self teaching
 - derived from a common semantic base
 - common definition mechanisms
- Communicates with common semantics to all entities
- Defined to be simple as possible but not simpler

(continued)

TABLE 49.1 System Oriented Object Properties of Development Before the Fact (Continued)

| | |
|---|---|
| relation including function | • Defined with integration of all of its objects (and all aspects of these objects) |
| typing including classification | |
| form including both structure and behavior (for object types and functions) | • Traceability of behavior and structure and their changes (maintenance) throughout its birth, life and death |
| -derivation | • Knows and able to reach the state of completion |
| deduction | -definition |
| inference | -development of itself and that which develops it |
| inheritance | -analysis |
| | -design |
| | -implementation |
| | -instantiation |
| | -testing |
| | -maintenance |

Note: all underlined words point to a reusable.

Source: Hamilton, M., "Software Design and Development," *The Electronics Handbook*, CRC Press, Boca Raton, FL, 1996. With permission.

from the early stage of system definition, life cycle control of the system under development, and inherent reuse of highly reliable systems. The development life cycle is divided into a sequence of stages, including requirements and design modeling by formal specification and analysis, automatic code generation based on consistent and logically complete models, test and execution, and simulation.

The first step in building a DBTF system is to define a model with the language. This process could be in any phase of the developmental life cycle, including problem analysis, operational scenarios, and design. The model is automatically analyzed to ensure it was defined properly. This includes static analysis for preventive properties and dynamic analysis for user-intent properties.

In the next stage, the generic source code generator automatically generates a fully production-ready and fully integrated software implementation for any kind of application, consistent with the model, for a selected target environment in the language and architecture of choice. If the selected environment has already been configured, the generator selects that environment directly; otherwise, the generator is first configured for a new language and architecture.

Because of its open architecture, the generator can be configured to reside on any new architecture (or interface to any outside environment), e.g., to a language, communications package, an Internet interface, a database package, or an operating system of choice; or it can be configured to interface to the users own legacy code. Once configured for a new environment, an existing system can be automatically regenerated to reside on that new environment. This open architecture approach, which lends itself to true component-based development, provides more flexibility to the user when changing requirements or architectures, or when moving from an older technology to a newer one.

It then becomes possible to execute the resulting system. If it is software, the system can undergo testing for further user-intent errors. It becomes operational after testing. Application changes are always made to the requirements/specification definition—not to the code (the developer does not even need to change the code). Target architecture changes are made to the configuration of the generator environment (which generates one of a possible set of implementations from the model)—not to the code. If the real system is hardware or peopleware, the software system serves as a simulation upon which the real system can be based. Once a system has been developed, the system and the process used to develop it are analyzed to understand how to improve the next round of system development.

Seamless integration is provided throughout from systems to software, requirements to design to code to tests to other requirements and back again; level to level and layer to layer. The developer is able to trace from requirements to code and back again.

Given an automation that has these capabilities, it should be of no surprise that an automation of DBTF has been defined with itself and that it continues to automatically generate itself as it evolves with

TABLE 49.2 A Comparison

| Traditional (After the Fact) | DBTF (Before the Fact) |
|---|--|
| <i>Interface errors (over 75% of all errors)</i> | <i>No interface errors</i> |
| Most found after implementation | All found before implementation |
| Some found manually | All found by automatic and static analysis |
| Some found by dynamic runs analysis | Always found |
| Some never found | |
| <i>Ambiguous requirements</i> | <i>Unambiguous requirements</i> |
| Informal or semiformal language | formal, but friendly language |
| Different phases, languages, and tools | All phases, same language and tools |
| Different language for other systems than for software | Same language for software, hardware and any other system |
| <i>Automation supports manual process</i> | <i>Automation does real work</i> |
| Mostly manual documentation, programming, test generation, traceability, etc. | Automatic documentation, programming, test generation, traceability, etc. |
| | 100% code automatically generated for any kind of software |
| <i>No guarantee of function integrity after implementation</i> | <i>Guarantee of function integrity after implementation</i> |
| <i>Systems not traceable or evolvable</i> | <i>Systems traceable and evolvable</i> |
| Locked in products, architectures, etc. | Open architecture |
| Painful transition from legacy | Smooth transition from legacy |
| Maintenance performed at code level | Maintenance performed at spec level |
| <i>Reuse not inherent</i> | <i>Inherent reuse</i> |
| Reuse is adhoc | Every object a candidate for reuse |
| Customization and reuse are mutually exclusive | Customization increases reuse pool |
| <i>Mismatched objects, phases, products, architectures and environment</i> | <i>Integrated & seamless objects, phases, products, architectures, and environment</i> |
| System not integrated with software | System integrated with software |
| Function oriented <u>or</u> object oriented | System oriented objects: integration of function, timing, <u>and</u> object oriented |
| | GUI integrated with application |
| GUI not integrated with application | Simulation integrated with software code |
| Simulation not integrated with software code | <i>Automation defined with and generated by itself</i> |
| <i>Automation not defined and developed with itself</i> | #1 in all evaluations |
| <i>Dollars wasted, error prone systems</i> | <i>Better, faster, cheaper systems</i> |
| Not cost-effective | 10 to 1, 20 to 1, 50 to 1...dollars saved |
| Difficult to meet schedules | Minimum time to complete |
| Less of what you need and more of what you don't need | No more, no less of what you need |

changing architectures and changing technologies. Table 49.2 contains a summary of some of the differences between the more modern preventative paradigm and the traditional approach.

A relatively small set of things is needed to master the concepts behind DBTF. Everything else can be derived, leading to powerful reuse capabilities for building systems. It quickly becomes clear why it is no longer necessary to add features to the language or changes to a developed application in an ad hoc fashion, since each new aspect is ultimately and inherently derived from its mathematical foundations.

49.4 Experience with DBTF

That preventative development is a superior alternative has been proven rather dramatically in several experiments. DBTF has been through many evaluations and competitions conducted and sponsored by leading academic institutions, government agencies, and commercial organizations. In every evaluation and competition this alternative came out on top. What set this alternative apart from the others was that it provided a totally integrated system design and development environment, whereas the traditional

methods resulted in an informal, difficult to integrate (including application modules as well as the products used to implement them), fragmented, more manual, and “after the fact” life-cycle process.

The National Test Bed of the U.S. Department of Defense sponsored an experiment in which it provided a development problem to each of three contractor/vendor teams chosen from a large pool of vendors and development environments, based upon a well-defined set of requirements. The application was a real-time, distributed, multiuser, client server system, which needed to be defined and developed under the government 2167A guidelines.

All teams were able to complete the first part, the definition of preliminary requirements. Two teams completed the detailed design. But only one team was able to generate complete, integrated, and fully production-ready code automatically; a major portion of this code was running in both C and Ada at the end of the experiment [12]. The team that was able to generate the production-ready code was using the 001 Tool Suite, a development environment based on the DBTF methodology.

49.5 Conclusion

Businesses that expected a big productivity payoff from investing in technology are, in many cases, still waiting to collect. A substantial part of the problem stems from the manner in which organizations are building their automated systems. While hardware capabilities have increased dramatically, organizations are still mired in the same old methodologies that saw the rise of the behemoth mainframes. Old methodologies simply cannot build the new systems.

There are other changes as well. Users demand much more functionality and flexibility in their systems. And given the nature of many of the problems to be solved by this new technology, these systems must also be error-free as well.

Where the biological superorganism has built-in control mechanisms fostering quality and productivity, until now the silicon superorganism has had none. Hence, the productivity paradox.

Often, the only way to solve major issues or to survive tough times is through nontraditional paths or innovation. One must create new methods or new environments for using new methods.

Innovation for success often starts with a look at mistakes from traditional systems. The first step is to recognize the true root problems, then categorize them according to how they might be prevented. Derivation of practical solutions is a logical next step. Iterations of the process entail looking for new problem areas in terms of the new solution environment and repeating the scenario. That is how DBTF came into being.

With DBTF all aspects of system design and development are integrated with one systems language and its associated automation. Reuse naturally takes place throughout the life cycle. Objects, no matter how complex, can be reused and integrated. Environment configurations for different kinds of architectures can be reused. A newly developed system can be safely reused to increase even further the productivity of the systems developed with it.

The paradigm shift occurs once a designer realizes that many of the old tools are no longer needed to design and develop a system. For example, with one formal semantic language to define and integrate all aspects of a system, diverse modeling languages (and methodologies for using them), each of which defines only part of a system, are no longer necessary. There is no longer a need to reconcile multiple techniques with semantics that interfere with each other.

DBTF can support a user in addressing many of the challenges presented in today’s software development environments. There will, however, always be more to do to capitalize on this technology. That is part of what makes a technology like this so interesting to work with. Because it is based on a different premise or set of assumptions (set of axioms), a significant number of things can and will change because of it. There is the continuing opportunity for new research projects and new products. Some problems can be solved, because of the language, that could not be solved before. Software development as we know it will never be the same. Many things will no longer need to exist—they, in fact, will be rendered extinct, just as that phenomenon occurs with the process of natural selection in the biological system. Techniques for bridging the gap from one phase of the life cycle to another become obsolete. Testing procedures and tools

for finding most errors are no longer needed because those errors no longer exist. Tools to support programming as a manual process are no longer needed.

Compared to the development using traditional techniques, the productivity of DBTF developed systems has been shown to be significantly greater. Upon further analysis, it was discovered that the larger and more complex the system, the greater the productivity—the opposite of what one finds with traditional systems development. This is, in part, because of the high degree of DBTF's support of reuse. The larger a system, the more it has the opportunity to capitalize on reuse. As more reuse is employed, productivity continues to increase. Measuring productivity becomes a process of relativity—that is, relative to the last system developed.

Capitalizing on reusables within a DBTF environment is an ongoing area of research interest. An example is understanding the relationship between types of reusables and metrics. This takes into consideration that a reusable can be categorized in many ways. One is according to the manner in which its use saves time (which translates to how it impacts cost and schedules). More intelligent tradeoffs can then be made. The more we know about how some kinds of reusables are used, the more information we have to estimate costs for an overall system. Keep in mind also that the traditional methods for estimating time and costs for developing software are no longer valid for estimating systems developed with preventative techniques.

There are other reasons for this higher productivity as well, such as the savings realized and time saved due to tasks and processes that are no longer necessary with the use of this preventative approach. There is less to learn and less to do—less analysis, little or no implementation, less testing, less to manage, less to document, less to maintain, and less to integrate. This is because a major part of these areas has been automated or because of what inherently take place because of the nature of DBTF's formal systems language.

In the end, it is the combination of the technology and that which executes it that forms the foundation of successful software. Software is so ingrained in our society that its success or failure will dramatically influence both the operation and the success of an organization. For that reason, today's decisions about systems engineering and software development have far-reaching effects.

Software is a relatively young technological field that is still in a constant state of change. Changing from a traditional software environment to a preventative one is like going from the typewriter to the word processor. Whenever there is any major change, there is always the initial overhead needed for learning the new way of doing things. But, as with the word processor, progress begets progress.

Collective experience strongly confirms that quality and productivity increase with the increased use of properties of preventative systems. In contrast to the “better late than never” after the fact philosophy, the preventive philosophy behind DBTF is to solve—or if possible, prevent—a given problem as early as possible. Finding a problem statically is better than finding it dynamically. Preventing it by the way a system is defined is even better. Better yet is not having to define (and build) it at all.

Reusing a reliable system is better than reusing one that is not reliable. Automated reuse is better than manual reuse. Inherent reuse is better than automated reuse. Reuse that can evolve is better than one that cannot evolve. Best of all is reuse that ultimately approaches wisdom itself. Then, have the wisdom to use it.

The answer continues to be in the results just as in the biological system; and the goal is that the systems of tomorrow will inherit the best of the systems of today.

References

1. Software Engineering Institute. *Capability Maturity Model*, Pittsburgh, PA: Carnegie, Mellon University, 1991.
2. Stroustrup, B., *The C++ Programming Language*, Reading, MA: Addison-Wesley, 1997.
3. Gosling, J., Joy, B., and Steele, G., *The Java Language Specification*, Reading, MA: Addison-Wesley, 1996.
4. Lientz, B.P., and Swanson, E.B., *Software Maintenance Management*, Reading, MA: Addison-Wesley, 1980.
5. Jones, T.C., *Program Quality and Programmer Productivity*, IBM Tech. Report TR02.764 January: 80, San Jose, CA: Santa Teresa Labs, 1977.

6. Keyes, J., *Handbook of E-Business*, Chapter F5, Hamilton, M., Defining e...com for e-Profits, RIA, 2000.
7. Martin, J., and Finkelstein, C.B., *Information Engineering*, Carnforth, Lancs, U.K.: Savant Institute, 1981.
8. Booch, G., Rumbaugh, J., and Jacobson, I., *The Unified Modeling Language User Guide*, Addison-Wesley, 1999.
9. Hamilton, M., "Inside Development Before the Fact," *Electronic Design*, April 4, 1994, ES.
10. Hamilton, M., "Development Before the Fact in Action," *Electronic Design*, June 13, 1994, ES.
11. Keyes, J., *The Ultimate Internet Developers Sourcebook*, AMACOM, to be published Fall 2001.
12. Software Engineering Tools Experiment-Final Report, Vol. 1, Experiment Summary, Table 1, Page 9, Department of Defense, Strategic Defense Initiative, Washington, D.C., 20301-7100, October 1992.

Defining Terms

Data Base Management System (DBMS): The computer program that is used to control and provide rapid access to a database. A language is used with the DBMS to control the functions that a DBMS provides. For example, SQL is the language that is used to control all of the functions that a relational architecture-based DBMS provides for its users, including data definition, data retrieval, data manipulation, access control, data sharing, and data integrity.

Graphical User Interface (GUI): The ultimate user interface, by which the deployed system interfaces with the computer most productively, using visual means. Graphical user interfaces provide a series of intuitive, colorful, and graphical mechanisms that enable the end-user to view, update, and manipulate information.

Interface: A point of access in a boundary between objects or programs or systems. It is at this juncture that many errors surface. Software can interface with hardware, humans, and other software.

Methodology: A set of procedures, precepts, and constructs for the construction of software.

Metrics: A series of formulas that measure such things as quality and productivity.

Software Architecture: The structure and relationships among the components of software.

Formal: A system defined in terms of a known set of axioms (or assumptions); it is, therefore, mathematically based (e.g., a DBTF system is based on a set of axioms of control). Some of its properties are that it is consistent and logically complete. A system is consistent if it can be shown that no assumption of the system contradicts any other assumption of that system. A system is logically complete if the assumptions of the method completely define a given set of properties. This assures that a model of the method has that set of properties. Other properties of the models defined with the method may not be provable from the method's assumptions. A logically complete system has a semantic basis (i.e., a way of expressing the meaning of that system's objects). In terms of the semantics of a DBTF system, this means it has no interface errors and is unambiguous, contains what is necessary and sufficient, and has a unique state identification.

Further Information

Hamilton, M. and Hackler, W. R., *Object Thinking: Development Before the Fact*, In Press.

Krut, Jr., B. "Integrating 001 Tool Support in the Feature-Oriented Domain Analysis Methodology" (CMU/SEI-93-TR-11, ESC-TR-93-188). Pittsburgh, PA: Software Engineering Institute, Carnegie-Mellon University, 1993.

Ouyang, M. and Golay, M. W., "An Integrated Formal Approach for Developing High Quality Software of Safety-Critical Systems," Massachusetts Institute of Technology, Cambridge, MA, Report No. MIT-ANP-TR-035., September, 1995.

McCauley, B. "Software Development Tools in the 1990s," AIS Security Technology for Space Operations Conference, July 1993, Houston, TX.

Hamilton, M. and Hackler, W. R., *Towards Cost Effective and Timely End-to-End Testing*, HTI, prepared for Army Research Laboratory, Contract No. DAKF11-99-P-1236, July 17, 2000.

Keyes, J., *Internet Management*, Chapters 30–33, on 001-developed systems for the Internet, Auerbach, Boca Raton, FL, 2000.

50

Handbook of Mechatronics—Data Recording and Logging

Tom Magruder
National Instruments

- 50.1 Overview
- 50.2 Historical Background
- 50.3 Data Logging Functional Requirements
 - Acquisition • Sensors • Signal Connectivity • Signal Conditioning • Conversion • Online Analysis • Logging and Storage • Offline Analysis • Display • Report Generation • Data Sharing and Publishing
- 50.4 Data-Logging Systems
 - Software Options • Hardware Options
- 50.5 Conclusions
 - Related Information

50.1 Overview

Data logging and recording is a very common measurement application. In its most basic form, data logging is the measurement and recording of physical or electrical parameters over a period of time. These parameters can be temperature, strain, displacement, flow, pressure, voltage, current, resistance, power, or any of a wide range of other measurement types. Real-world data-logging applications are typically more involved than just acquiring and recording signals, typically involving some combination of online analysis, offline analysis, display, report generation, and data sharing. Also, many data-logging applications are beginning to require the acquisition and storage of other types of data. One example would be recording sound and video in conjunction with the other parameters measured during an automobile crash test.

Data logging is used in a broad spectrum of applications. Chemists record data like temperature, pH, and pressure when performing experiments in a lab. Design engineers log performance parameters like vibration, temperature, and battery level to evaluate product designs. Civil engineers record strain and load on bridges over time to evaluate safety. Geologists use data logging to determine mineral formations when drilling for oil. Breweries log the conditions of their storage and brewing facilities to maintain quality.

The list of applications for data logging goes on and on, but all of these applications have similar common requirements. The purpose of this chapter is to provide a general background on data logging, discuss the various functional requirements that are common to most logging applications, and examine some of the modern hardware and software options available that allow scientists and engineers to implement powerful PC-based data-logging systems.

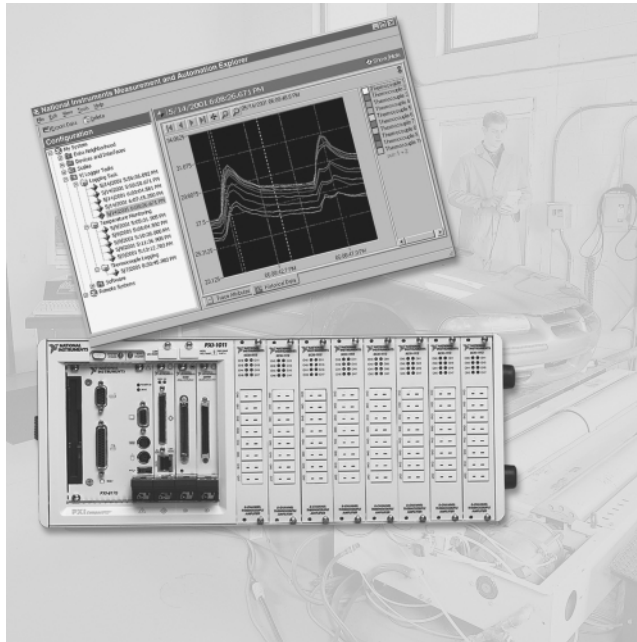

FIGURE 50.1 PC-based data-logging application—performance testing of refrigerator designs.

50.2 Historical Background

The earliest form of data logging involved taking manual measurements from analog instruments like thermometers and manometers. These measurements were recorded into a written log, along with the time of observation. To view trends over time, people manually plotted their measurements on paper. In the late nineteenth century, it became possible to begin automating this process with machines, and strip chart recorders evolved. Strip chart recorders are analog instruments that translate electrical impulses from sensors into mechanical movement of an arm. A pen is attached to the arm, and long rolls of paper are moved at a constant rate under the pen. The result is a paper chart displaying the parameters measured over the course of time. Strip chart recorders were a great leap over manual data logging, but still had drawbacks. For example, translating the traces on the paper into meaningful engineering measurements was tedious at best, and the data that was recorded took up reams and reams of paper.

With the development of the personal computer in the '70s and '80s, people began to leverage computers for analysis of data, data storage, and report generation. The need to bring data into the PC brought about a new type of equipment for data logging, the dataloggers. Dataloggers are stand-alone box instruments that measure signals, convert to digital data, and store the data internally. This data must be transferred to the PC for analysis, permanent storage, and report generation. Data is typically transferred either by manually moving a storage device, like a floppy, from the datalogger to the computer, or by connecting the datalogger to the PC through some communications link, like serial or Ethernet.

In the 1990s, a further evolution in data logging took place, as people begin to create PC-based data-logging systems. These systems combine the acquisition and storage capabilities of stand-alone dataloggers with the archiving, analysis, reporting, and display capabilities of modern PCs. PC-based logging systems finally enabled full automation of the data logging process. The move to PC-based data-logging systems was enabled by the following three technological enhancements:

1. Increasing reliability of PCs
2. Steadily decreasing cost of hard drive space on PCs

3. PC-based measurement hardware that could meet or exceed measurement capabilities of stand-alone dataloggers

Today, PC-based logging systems provide the widest range of measurement types, analysis capabilities, and reporting tools. The remainder of this chapter will focus on the functionality necessary to implement a PC-based data-logging system.

50.3 Data Logging Functional Requirements

Every data-logging application, from fifteenth century monks manually recording weather patterns to twenty-first century physicists logging the experimental parameters of a fusion reactor test, can be broken down into a set of five common functional requirements, illustrated in Fig. 50.2. Acquiring is the process of actually measuring the physical parameters and bringing them into your logging system. Online analysis consists of any processing done to the data while you are acquiring. It includes alarms, data scaling, and sometimes control, among others. Logging or storing the data is an obvious requirement of every data-logging system. Offline analysis is everything that is done with the data after it has been acquired in order to extract useful information from it. The final functional block is made up of display, reporting, and data sharing. These are all the “miscellaneous” requirements that fill out the functionality of a data-logging system. Let’s examine how each of these functional blocks is addressed with modern PC-based data-logging systems.

Acquisition

The acquisition function is one of the most critical components of every data-logging system. In a PC-based system, the acquisition is accomplished by the measurement hardware, which can be further broken down into sensors, signal connectivity, signal conditioning, and analog-to-digital (A/D) conversion, as shown in Fig. 50.3. Each of these topics is covered in more detail in other chapters of this book; so only a high-level overview will be given here.

Sensors

A wide variety of sensors are used to convert physical parameters into electrical signals. Temperature sensors such as thermocouples, RTDs, or thermistors are some of the most common sensors used in data-logging applications. Other widespread sensors are flowmeters, pressure transducers, strain gauges, accelerometers, and microphones, to name a few. Proper selection and installation of sensors is beyond the scope of this chapter.

Signal Connectivity

After sensors are installed, they must be connected to the data-logging system. Signal connectivity is the component of your measurement hardware that allows you to connect your sensors to your logging system. Screw terminals, which allow you to connect bare wires from sensors directly to your logging

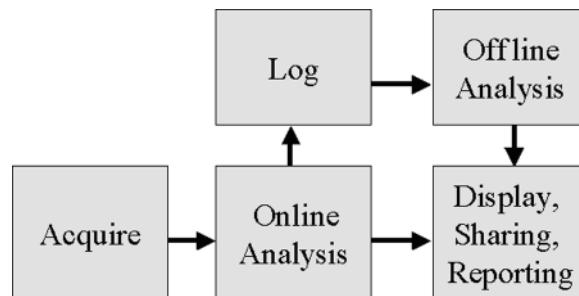

FIGURE 50.2 Basic elements of a data-logging system.

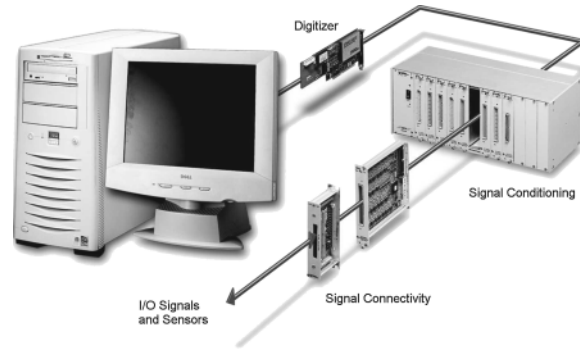

FIGURE 50.3 Measurement hardware components of PC-based data-logging system.







| | | | |
|--|--|--|---|
|  |  |  |  |
| Thermocouple | BNC | SMB | 9-Pin D-Sub |
|  |  |  |  |
| Banana Jack | Lemo | Mil | Strain Relief |

FIGURE 50.4 Examples of signal connectivity options.

system, are the most basic form of connectivity. Screw terminals are a good choice for general-purpose use, particularly when you need to connect a large number of signals into a small amount of space. The disadvantage of screw terminals is that they are time consuming to connect and difficult to reconfigure. Figure 50.4 shows some other standard connectivity options that are designed to make connecting and disconnecting sensors less labor-intensive. Minithermocouple connectors are a widely used connectivity option for thermocouples. BNC and SMB connectors are commonly used when electrical shielding is required for noise immunity. Banana jacks are often used when measuring current, resistance, or higher voltages. The sensor provider typically defines the connectivity options available for a sensor, and it is up to you to choose measurement hardware that can accept that connectivity.

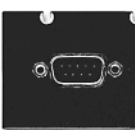
Signal Conditioning

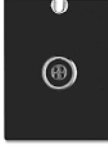
Signal conditioning is one of the most important and most overlooked components of a PC-based data-logging system. Many sensors require special signal conditioning technology. For example, signals from a thermocouple are very low voltage and require amplification, filtering, and linearization. Other sensors, like strain gauges and accelerometers, require power in addition to amplification and filtering, while other signals may require isolation to protect the system from high voltages. No single stand-alone datalogger can provide the flexibility required to make all of these measurements. However, with front-end signal conditioning, you can combine the necessary technologies to bring these various types of signals into a single PC-based data-logging system.

Most signals require some form of preparation before they can be digitized. As previously mentioned, thermocouple signals involve very small voltage levels that must be amplified before they can be digitized. Other sensors, such as RTDs, thermistors, strain gauges, or accelerometers, require electrical power to operate. Even pure voltage signals can require special technologies to block large common-mode signals or to allow you to safely measure high voltages. All of these preparation technologies are forms of signal conditioning. Because of the vast array of signal-conditioning technologies, the role and need for each technology can quickly become confusing. A list of common types of signal conditioning, their functionality, and examples of when you need them are given below.

- *Amplification.* When the voltage levels you are measuring are very small, amplification is used to maximize the effectiveness of your digitizer. By amplifying the input signal, the conditioned signal uses more of the effective range of the A/D converter. This allows better accuracy and resolution of the measurement. Typical sensors that require amplification are thermocouples and strain gauges.
- *Attenuation.* Attenuation is the opposite of amplification. It is necessary when the voltages to be digitized are outside the input range of the digitizer. This form of signal conditioning divides the input signal so that the conditioned signal is within the range of the A/D converter. Attenuation is necessary for measuring high voltages.
- *Isolation.* Voltage signals outside the range of the digitizer can damage the measurement system and harm the operator. For that reason, isolation is usually required in conjunction with attenuation to protect the system and the user from dangerous voltages or voltage spikes. Isolation may also be required when the sensor is on a different electrical ground plane from the measurement sensor (such as a thermocouple mounted on an engine).
- *Multiplexing.* Typically, the digitizer is the most expensive part of a data acquisition system. Multiplexing allows you to automatically route multiple signals into a single digitizer, providing a cost-effective way to greatly expand the signal count of your system. Multiplexing is necessary for any high channel count application.
- *Filtering.* Filtering is required to remove unwanted frequency components from a signal. This prevents aliasing and reduces signal noise. Thermocouple measurements typically require a low-pass filter to remove power-line noise from the signals. Vibration measurements normally require a higher-frequency low-pass filter to remove high-frequency signal components that are above the range of the acquisition system.
- *Excitation.* Many sensor types, including RTDs, strain gauges, and accelerometers, require some form of power to make a measurement. Excitation is the signal conditioning technology required to provide this power. This excitation can be a voltage or current source, depending on the sensor type.
- *Linearization.* Some types of sensors produce voltage signals that are not linearly related to the physical quantity they are measuring. Linearization is the process of interpreting the signal from the sensor as a physical measurement. This can be done either with signal conditioning or through software. Thermocouples are the classic example of a sensor that requires linearization.
- *Cold-junction compensation.* Another technology that is required for thermocouple measurements is cold-junction compensation (CJC). Any time a thermocouple is connected to a data acquisition system, the temperature of the connection must be known in order to calculate the true temperature the thermocouple is measuring. A built-in CJC sensor must be present at the location of the connections.
- *Simultaneous sampling.* When it is critical to measure multiple signals at exactly the same moment in time, simultaneous sampling is required. Front-end signal conditioning can provide a much more cost-effective simultaneous sampling solution than purchasing a digitizer with those capabilities. Typical applications that might require simultaneous sampling include vibration measurements and phase-difference measurements.

Most sensors require a combination of the above signal conditioning technologies. Again, the thermocouple is the classic example because it requires amplification, linearization, cold-junction compensation,

filtering, and sometimes isolation. Ideally, a good PC-based data-logging platform should give you the ability to select the type of signal conditioning that is needed for your application. In some systems, front-end signal conditioning is an option, but in other systems, front-end signal conditioning is a necessity to make the required measurements. As a rule of thumb, your measurement system should include front-end signal conditioning if you are planning to use any of the following: thermocouples, RTDs, thermistors, strain gauges, LVDTs, accelerometers, switching, multiplexing, mixed low-voltage/high-voltage signals, current inputs, or resistance inputs.

Conversion

After physical parameters have been converted into electrical signals and properly conditioned, it is time to convert the analog electrical signals into digital values and pass those values back to the computer. The A/D conversion can be accomplished with either a plug-in data acquisition (DAQ) board, or it can be integrated into a single package with the conditioning and connectivity. For more details on the conversion process, please refer to Chapters 6.1 and 6.3 of this book.

The combination of sensors, signal connectivity, signal conditioning, and A/D conversion makes up the measurement hardware portion of a data-logging system. In a PC-based system, the measurement hardware is configured and controlled through software, and it is critical to use software that is designed to integrate smoothly with all components of your data-logging system.

Online Analysis

The next functional component in a typical data-logging system is online analysis. In PC-based systems, online analysis is accomplished through software. Many different forms of online analysis can be needed in various data-logging applications. We will discuss some of the most common ones here.

Channel scaling is the conversion of the raw binary values returned by the acquisition system into properly scaled measurements with appropriate engineering units. One example is computing temperature (in $^{\circ}\text{C}$) from a thermocouple reading. The digitizer returns binary measurements of the thermocouple voltage and the cold-junction sensor voltage. The software converts the binary measurements into voltages, and then uses a thermocouple conversion formula to compute temperature. Similar channel scaling routines are used for strain gauges, RTDs, accelerometers, and others. Fortunately, modern PC-based measurement software handles most scaling functions automatically.

Another important online analysis function is alarming and event management. This includes monitoring a channel and providing some notification if preset limits are exceeded. This notification can be as basic as turning on a warning light, or as complex as paging someone with information about the problem. Alarming can also include an automated response to certain events. For example, a data-logging system could shut down a machine being monitored if the oil temperature exceeded a certain limit.

A wide range of online analysis functionality can be required in different data-logging applications. This functionality could include feedback control systems or advanced signal analysis. Only PC-based data-logging systems have the flexibility to implement these differing requirements.

Logging and Storage

The logging (or storage) functional block is, by definition, required in every data-logging system. Methods of storing data vary widely across different systems. Strip chart recorders use paper, traditional dataloggers can use internal nonvolatile memory, floppy disks, or a variety of other mediums. PC-based data-logging systems typically use the hard drive of the PC, although they can also use tape drives, network drives, RAID drives, and other more exotic options.

Software is of critical importance in PC-based data-logging systems, because well-written logging software determines how data is stored, how quickly data can be written to disk, and how efficiently disk space is used. Logging software also gives you data management capabilities, such as changing data formats, archiving data, and connecting to databases.

The data storage format has a strong link to the performance and ease-of-use of your data-logging system. There are three general formats that are commonly used for storage in data-logging systems: ASCII text files, binary files, and databases.

ASCII text files are the most common and flexible form of data storage. Text files for data-logging applications are typically made up of a header section and columns of data. The header section gives information like channel names, units, test equipment, and user comments. The first data column is usually the time stamp of each sample, and it is followed by another column for each channel being logged. Text files are useful because they can be opened or imported into almost any software packages, and they are easily transferred between operating systems. Some disadvantages of text files are that they use disk space inefficiently, and they require additional processing overhead to write and read from files. ASCII text files are commonly used when the speed of the acquisition is slow (<1000 samples per second), the total amount of data to log is not large, and the user needs to easily share data between different software applications.

Binary files are the most efficient method of data storage. With binary files, the raw bytes that the computer is using to store data in memory are written directly to the file. This data takes up considerably less space than the same information written in ASCII text format, and it requires much less processor overhead than formatting into text. Binary files cannot be viewed in common software applications like MS Excel. Instead, they must be translated by a software routine into meaningful data. With PC-based data-logging systems you can log scaled data that is already processed into correct engineering units, or you can log the raw binary values returned by the digitizer. The raw binary values representing the A/D conversions of each sample returned from a 16-bit DAQ device take up 16-bits, or 2 bytes, of memory. The channel scaling routines in your logging software automatically convert this raw data into a real number that represents the physical value you measured. Scaled data is typically handled inside your data-logging software as a double precision floating-point value, which refers to a data type taking up 8 bytes of memory on most computer systems.

For performance reasons, some high-speed data-logging systems might log the raw binary values to disk, along with the necessary scaling constants to convert them to scaled data at a later time. Figure 50.5 shows the relationship between logging raw binary, scaled binary, and ASCII text. Binary files take up less space and allow greatly improved stream-to-disk speed. Raw binary files can be less than one-tenth the size of a text file containing the same information. The disadvantage of binary files is that they typically must be translated to another format before they can be shared between different application types.

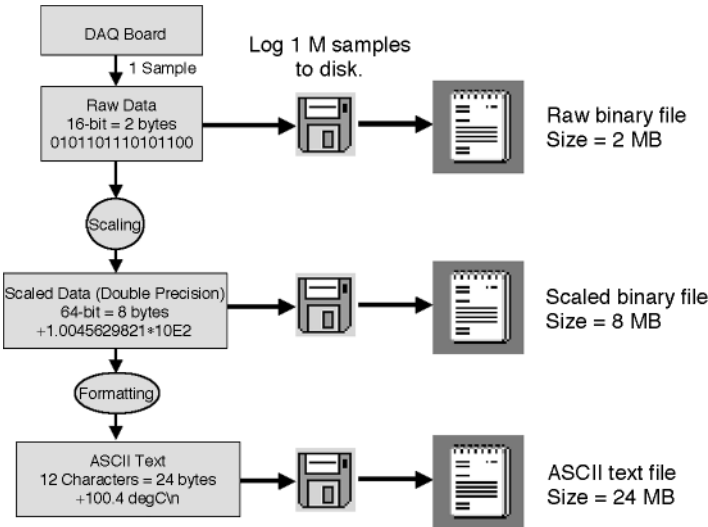

FIGURE 50.5 Data storage file size example.

Many data-logging software packages log data into databases. Databases are typically binary files that provide a structured format for inserting and retrieving data. They are optimized for efficiently handling large amounts of data and for searching through information in the database without loading everything into memory. Databases also are often designed to allow easy backup and archiving of data, and multiple user access. They usually have software methods to make it easy to import data into different software packages for analysis and report generation. In many ways, databases are the ideal storage format for PC-based data-logging systems. Two disadvantages of using databases for storage are that they add increased complexity, and they are difficult to implement if starting from scratch.

Many different storage media types are used for data logging. Stand-alone dataloggers can use on-board nonvolatile memory, floppy disks, PCMCIA memory cards, tapes, or a variety of other options. PC-based data-logging systems usually rely on the computer's internal hard disk. This is possible because of the trends towards more reliable and higher capacity hard drives. The 20 GB (and larger) hard drives that are readily available today make hard drives one of the most economical storage devices. It is still advisable to periodically back up or archive data stored on a local hard drive.

High-speed data-logging applications (more than 1 M samples per second) can start to exceed the write-to-disk speeds of normal PC hard drives. One of the advantages of PC-based logging systems is that you can move to more high-performance storage devices and higher performance computers, often with little or no modifications to your logging software or measurement hardware. One type of high-performance storage devices is the RAID (redundant array of independent disks) controller. RAID controllers use multiple hard drives in concert to greatly enhance the combined stream-to-disk speed and to provide improved data integrity. Audio-visual (AV) drives are another type of storage device that is used for high-speed data logging. AV drives are optimized for streaming large amounts of audio and video information to disk, and this optimization also makes them well suited for high-performance data-logging applications. Finally, some companies make custom hardware that allows DAQ devices to stream data across the computer's PCI bus, directly into device storage. The stream-to-disk rates of these devices are limited by the available bandwidth of the PCI bus, which has a theoretical maximum of 132 MB/s on most computer systems.

Offline Analysis

Offline analysis is performing mathematical functions on data after it has been acquired in order to extract important information. Types of offline analysis can include computing basic statistics of measured parameters, as well as more advanced functions such as the frequency content of signals and order analysis. Offline analysis can be integrated with the rest of the data-logging application, or it can occur separately through stand-alone analysis software packages. Often, offline analysis is combined with the report generation, historical display, and data-sharing functions.

Display

Most data-logging applications require some form of display to view the measurements that are being recorded. The display function can be further broken down to viewing live data and historical data. Live data display is necessary if you need to view data as it is being acquired. Many stand-alone dataloggers have a live data display integrated into the box with them. Historical display lets you view data that was previously acquired. Most stand-alone dataloggers require you to move the data to a PC for historical viewing. PC-based data-logging applications allow you to combine both live display and historical display into the same user interface. Data-viewing utilities should provide an intuitive user interface, scrolling and zooming capabilities, cursors, and general customization features. [Figure 50.6](#) is an example of a typical historical data display found with commercially available software.

Report Generation

Report generation is a function that is often not considered part of the data-logging application. In reality, almost every data-logging application requires some form of reporting capabilities, for the simple reason that if you're recording the data, somebody needs to see it in a presentable format. Report generation

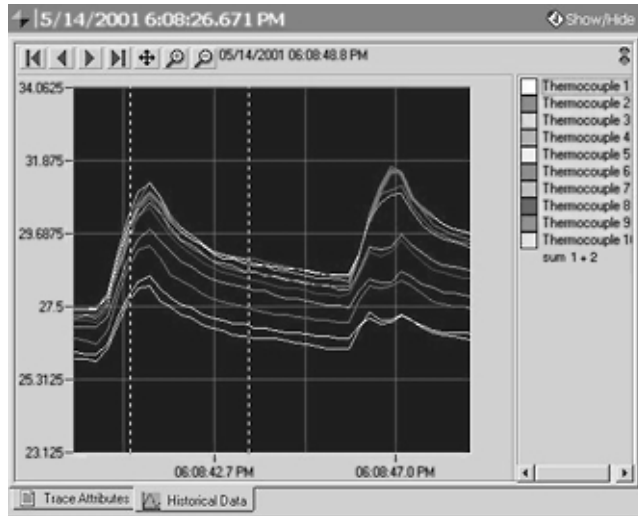

FIGURE 50.6 Example of historical data display from National Instruments VI Logger software.

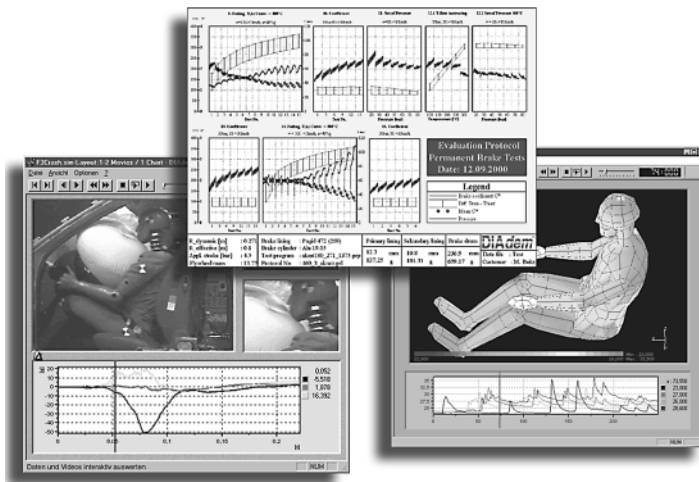

FIGURE 50.7 Advanced report generation capabilities with National Instruments DIAdem software package.

can be integrated into PC-based data-logging applications for increased efficiency. The logging application can be set up to periodically generate predefined reports and distribute them to the appropriate people. Powerful commercial software is available, which is designed to give you advanced capabilities for analyzing data and generating reports from your measurements. Figure 50.7 shows an example of some of the report generation capabilities possible with commercially available packages. When choosing software for report generation, it is critical that it integrate smoothly with the rest of your data-logging software. Ideally, the logging software should be able to pass data directly to the report generation application and trigger automatic reports.

Data Sharing and Publishing

In order for data that has been logged to be useful, it must be available to the right people. With the networking capabilities found in modern data-logging software, sharing data and publishing it to the network no longer requires a degree in computer science. Logging applications can be set up to publish

live data to the network, as it is acquired, periodically e-mail both raw data and analyzed results to key personnel, or automatically post reports to a Web page.

In widely distributed data-logging applications, each logging node can publish its measurements to the network, and a main computer can serve as the central collection facility. The central computer retrieves the measurements from each node, combines them for further analysis, logs the results for permanent archiving, and periodically generates reports analyzing the data.

50.4 Data-Logging Systems

Now that we've seen the functional components of a data-logging system, let's examine how these components can be implemented in real systems. All PC-based data-logging systems are made up of hardware and software. The measurement hardware handles the acquisition portion of the logging application, and the hardware choice defines channel count, sensor type, acquisition speed, and measurement accuracy. The measurement software, in addition to controlling the hardware, also handles the online analysis, logging, offline analysis, display, reporting, and data sharing.

Software Options

Choosing software is one of the most critical steps when defining a PC-based data-logging system. Your logging system depends on software to give you a productive, flexible solution. The measurement software must be designed to integrate seamlessly with your hardware. In addition to the basic task of acquiring data and logging it to disk, your software should provide tools to handle configuration of measurement hardware, scaling of data from channels, and calibration of your system. The software should allow you to complete your entire application—including report generation, analysis, archiving, and sharing. There are two general categories of software that can be used for PC-based data-logging applications—turnkey software, also known as configuration-based software, and application development environments.

Turnkey packages are ready-to-run data-logging software applications that interface with your measurement hardware to acquire and log data. These applications provide a user-friendly environment for configuring your logging task and getting up and running quickly. A good configuration-based data-logging software package should provide:

- *Intuitive user interface.* The software configuration should be through a Windows-based, menu-driven interface with easily accessible help functions and tutorials.
- *Automatic data storage and archiving.* One of the primary functions of any data-logging software package is to handle the storage of the data. It should automatically store the data in an efficient manner, and the software should provide a method for backing up and archiving data.
- *Capability to export data.* At a minimum, the software package should allow you to export data to ASCII text files so you can import it into other packages. More advanced data-logging software packages will allow data to automatically be transferred into common databases and analysis programs.
- *Alarming and event management.* The data logging software must provide the capability to handle alarms and events. This includes detecting if a signal is over or under a limit, outside of a range, or inside of a range. If an alarm occurs, the software should allow a range of actions, such as sending pages or performing some type of digital or analog output.
- *Display and trending tools.* All turnkey logging software packages need to have a good interface for viewing both live and historical data. This interface must let you scroll through data, zoom-in on regions of interest, and see long-term trends in data.

A disadvantage of configuration-based applications is that, unless there is a method for customization, you are locked into the functionality provided by the manufacturer. If your measurement needs change, and you need to add a different type of signal, you can be out of luck if your turnkey software doesn't support that measurement type. Also, if you want to integrate offline analysis, report generation, and

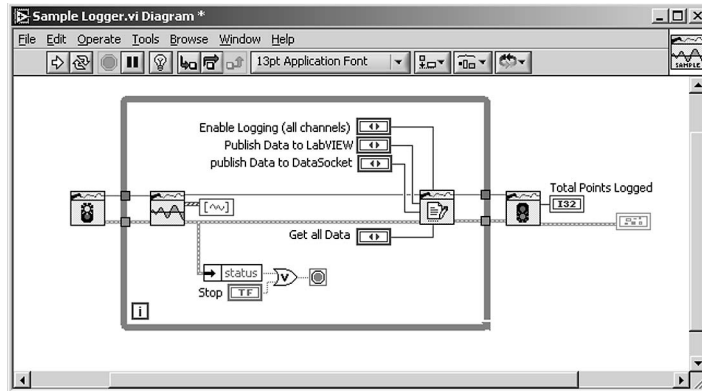

FIGURE 50.8 Example of graphical programming of data-logging applications with National Instruments LabVIEW.

network connectivity into your data-logging application, a closed turnkey software application can make that difficult. On the other hand, there are turnkey software applications that provide methods for customization with popular application development tools. These customizable logging software packages provide the best of both worlds, allowing you to get up and running quickly with your logging application, and also giving you a method for integrating more advanced functionality at a later date.

Application development tools are the other option available for developing PC-based data-logging systems. Development tools can range from text-based programming languages to graphical programming environments. Figure 50.8 is an example of the software code for a data-logging application developed in a graphical programming environment. Development tools allow you to build your own customized data-logging application that does exactly what you need. Application development tools give you the abilities to modify your application as your needs change, integrate customized analysis and report capabilities with your logging application, and fully automate your data-logging system.

When developing data-logging applications, it is advisable to choose a development environment with productivity features that enable you to create powerful PC-based logging systems. Some features to look for when evaluating application development tools are:

- *Wide range of graphical user interface components.* Developing user interface components, such as graphs, displays, and controls, from scratch is extremely time consuming. You should choose a development environment that contains high quality user interface components.
- *Tight integration with measurement hardware.* It is critical that you use software designed to work with your measurement hardware. Not only does proper software integration result in significantly shorter development times, but it also helps ensure you get measurements you can trust.
- *Analysis functions.* One of the primary reasons for custom developing a data-logging software application is to integrate advanced analysis functions. A good application development environment will provide a wide range of analysis functions to handle almost any need.
- *Network connectivity.* In today's networked environment, the ability to connect your data-logging application to the Web can be very important. Your application development software should provide tools to make publishing results to the network a trouble-free process.
- *Report generation.* Your application development environment should either allow you to generate reports automatically, or allow programmatic control of external report generation packages.

The choice between turnkey software and development tools depends on the complexity of your data-logging application and the amount of customization required. With either choice, it is important to use a software vendor that specializes in connecting measurements to computers and that provides high quality service and support.

Hardware Options

Many different hardware platforms are available for data-logging systems. The platform choice depends on your requirements for size, operating environment, and installation. Although the combinations are nearly endless, platforms for PC-based data-logging can be broadly broken down into four categories: portable, desktop, rack mount/industrial, and distributed. One of the key benefits of PC-based data-logging systems is that the same data-logging software scales across all of these platforms.

Portable data-logging solutions are needed in a variety of applications, such as in-vehicle data logging or field-testing of equipment. Portable PC-based solutions use laptops for the computer, and measurement hardware that is designed to be easily portable. Figure 50.9 shows a portable, PC-based data-logging system from National Instruments. The digitizer is a plug-in PCMCIA data acquisition card, which cables to small, laptop-sized boxes for signal conditioning and connectivity. Portable systems are typically limited to less than 40 channels due to size constraints.

Desktop systems, like the one shown previously in Fig. 50.3, use measurement hardware designed to work with standard desktop PCs. Desktop systems are ideal for a wide range of laboratory-based data-logging applications, such as validation testing of new product designs. Since fixed desktop systems are not as constrained by size, the signal connectivity and conditioning functions are typically accomplished by a modular front-end signal conditioning system that provides the capability to measure a wide range of sensor and signal types and to easily expand to log hundreds of channels.

Many times desktop systems take up too much space or do not fit well in environments like large laboratories or manufacturing facilities. In these cases, the more compact and clean solution of a modular industrial PC, based on the PXI or CompactPCI standard, might be a more appropriate data-logging solution. Figure 50.10 is an example of a PXI-based data-logging system. One modular system contains the PC, DAQ board, signal conditioning, and connectivity. These systems are designed to be rack-mountable, so they can be cleanly installed into an industrial or laboratory environment.

Finally, some data-logging systems need to be distributed away from the PC. This is the case when you need to log data from multiple locations around a facility, such as when logging the performance parameters of a chemical plant. Distributed logging systems should be compact so they can be mounted

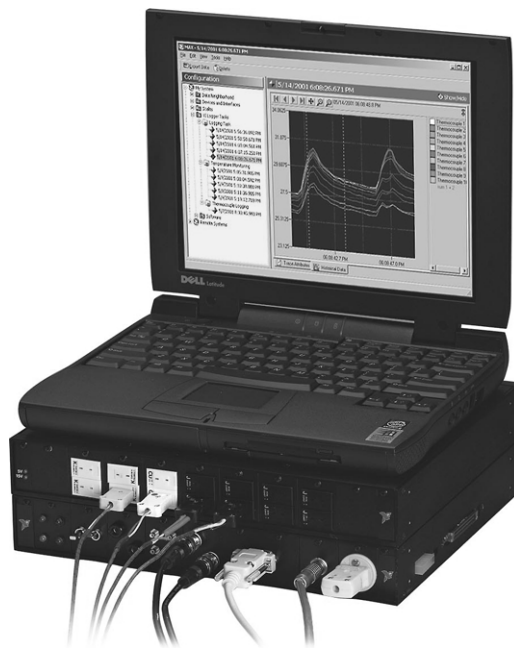

FIGURE 50.9 Portable PC-based data-logging system.

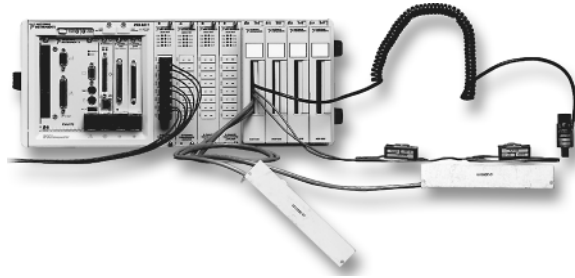

FIGURE 50.10 Rack-Mount industrial PC-based data-logging system.

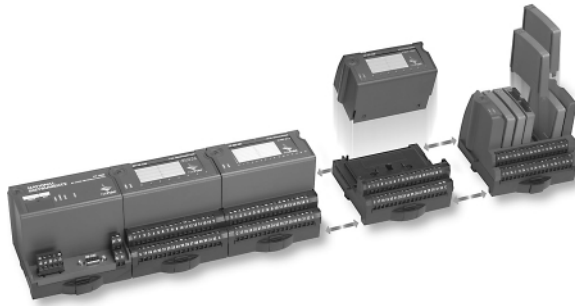

FIGURE 50.11 Distributed data-logging system.

unobtrusively, and they typically must operate in extended temperature ranges. With distributed logging systems, you typically have multiple measurement nodes that communicate back to a central computer through a communications link such as RS-485 or Ethernet. [Figure 50.11](#) is an example of a distributed logging system.

The choice of logging platform depends on the requirements of your data-logging system, and some systems might require using multiple platforms together. With properly designed hardware and software, data-logging systems can scale from simple, low channel count laboratory systems up to very high channel count, distributed industrial logging systems.

50.5 Conclusions

Data logging allows scientists and engineers to evaluate a variety of phenomena, from weather patterns to factory performance. PC-based data-logging systems provide the most flexibility, customization, and integration. To define a data-logging system, you must evaluate your requirements for acquisition, online analysis, logging, offline analysis, display, report generation, and data sharing. Based on these requirements, you can choose data-logging software and hardware to meet your needs.

Related Information

More information about PC-based data-logging systems is available from National Instruments in the form of white papers, application notes, customer solutions, and product information. Visit www.ni.com and search for “data logging” to view available information.