

Toshiharu Taura
Yukari Nagai
Editors



Design Creativity 2010

Extra
Materials
extras.springer.com



Design Creativity 2010

Toshiharu Taura · Yukari Nagai
Editors

Design Creativity 2010



Toshiharu Taura
Kobe University
Department of Mechanical Engineering
Rokkodai-cho
Nada-ku
657-8501 Kobe
Japan
taura@kobe-u.ac.jp

Yukari Nagai
Japan Advanced Institute of Science and Technology
School of Knowledge Science
Asahidai 1-1 Nomi-city
923-1292 Ishikawa
Japan
ynagai@jaist.ac.jp

Additional material to this book can be downloaded from <http://extra.springer.com>

ISBN 978-0-85729-223-0

e-ISBN 978-0-85729-224-7

DOI 10.1007/978-0-85729-224-7

Springer London Dordrecht Heidelberg New York

British Library Cataloguing in Publication Data

A catalogue record for this book is available from the British Library

Library of Congress Control Number: 2010938960

© Springer-Verlag London Limited 2011

Morae is a registered trademark of TechSmith Corporation, 2405 Woodlake Drive, Okemos, United States, 48864-5910

Microsoft is a registered trademark of Microsoft Corporation, One Microsoft Way, Redmond, Washington 98052-6399, United States of America

Apart from any fair dealing for the purposes of research or private study, or criticism or review, as permitted under the Copyright, Designs and Patents Act 1988, this publication may only be reproduced, stored or transmitted, in any form or by any means, with the prior permission in writing of the publishers, or in the case of reprographic reproduction in accordance with the terms of licences issued by the Copyright Licensing Agency. Enquiries concerning reproduction outside those terms should be sent to the publishers.

The use of registered names, trademarks, etc. in this publication does not imply, even in the absence of a specific statement, that such names are exempt from the relevant laws and regulations and therefore free for general use.

The publisher makes no representation, express or implied, with regard to the accuracy of the information contained in this book and cannot accept any legal responsibility or liability for any errors or omissions that may be made.

Cover design: eStudioCalamar, Girona/Berlin

Printed on acid-free paper

Springer is part of Springer Science+Business Media (www.springer.com)

Preface

What is ‘Design Creativity’? Design Creativity is assumed to be different from the notion of merely ‘Creativity’. This question is believed to be strongly related to the question ‘Why do and can human beings “Design”?’. Design, Creativity, and Human beings are related to each other, and each can be explained with the help of the other two. However, their interrelationships have as yet not been clarified.

Each relationship may provide essential and fruitful knowledge for understanding Design, Creativity, and Human beings. For example, the nature of Design can be investigated through Creativity and vice versa. Furthermore, the characteristics of Human beings are assumed to be discernable through these investigations.

‘Design Creativity’ is expected to be instrumental in not only addressing the social problems we are facing but also evoking an innate appreciation for beauty and happiness in our minds.

ICDC (International Conference on Design Creativity) is the official conference promoted by the Design Creativity Special Interest Group (SIG) of the Design Society. The SIG was established in 2007; since then, its ambit has expanded to include engineering design, industrial design, artificial intelligence, linguistics, and cognitive science. ICDC provides a forum for discussion of the nature and potential of design creativity from both theoretical and methodological viewpoints.

ICDC2010 is the first conference which was held in Kobe, from 29 November to 1 December. ICDC2010 includes panel discussions on the ‘directions for design creativity research’; these discussions conclude a series of three panel discussions held at ICED’09 in the USA, DESIGN 2010 in Croatia, and ICDC2010 in Kobe. The aim of these discussions is to develop directions for future research on design creativity. The opinion papers are invited from the panelists of the panel discussion at ICDC2010, and they constitute the former portion of this book.

The latter portion of this book comprises 32 papers which were presented in the podium session. Nearly 100 papers were submitted for the conference, and each paper was reviewed by more than three reviewers. On the basis of the reviewers’ comments, 32 of the papers were selected for the podium session from the viewpoint of the style and content of the paper. We would like to thank all the reviewers listed on the subsequent pages for their kind efforts. We would also like to express our sincere gratitude to Dr. Georgi V. Georgiev for his devoted contribution toward editing this book. Finally, we would like to acknowledge that this conference is supported by Kobe University and Japan Advanced Institute of Science and Technology.

Toshiharu Taura
Kobe University

Yukari Nagai
Japan Advanced Institute of Science and Technology

November 2010

Table of Contents

List of Referees	xi
Directions for Design Creativity Research (Invited Papers)	1
Discussion on Direction of Design Creativity Research (Part 1) - New Definition of Design and Creativity: Beyond the Problem-Solving Paradigm <i>Toshiharu Taura and Yukari Nagai</i>	3
Discussion on Direction of Design Creativity Research (Part 2) - Research Issues and Methodologies: From the Viewpoint of Deep Feelings and Desirable Figure <i>Yukari Nagai and Toshiharu Taura</i>	9
Future Directions for Design Creativity Research <i>John S. Gero</i>	15
Systematic Procedures Supporting Creativity - A Contradiction? <i>Udo Lindemann</i>	23
Better, Not Catchier: Design Creativity Research in the Service of Value <i>Gabriela Goldschmidt</i>	29
Using Evolved Analogies to Overcome Creative Design Fixation <i>Steven M. Smith, Julie S. Linsey and Andruid Kerne</i>	35
Design Creativity Research: From the Individual to the Crowd <i>Mary L. Maher</i>	41
Motivation as a Major Direction for Design Creativity Research <i>Amaresh Chakrabarti</i>	49
Design Research and Designing: The Synergy and The Team <i>Yong Se Kim</i>	57
Theories on Design Creativity	61
Not from Scratch: The DMS Model of Design Creativity <i>Gabriela Goldschmidt</i>	63

Influence of Environmental Information on Expert-perceived Creativity of Ideas <i>Daniel Collado-Ruiz and Hesamedin Ostad-Ahmad-Ghorabi</i>	71
Towards a New Theory for Design Activity Reasoning <i>Denis Choulier</i>	79
Design Process and Cognition 1	87
An Approach to Measuring Metaphoricity of Creative Design <i>Hung-Hsiang Wang and Jung-Hsuan Chan</i>	89
Interrelations between Motivation, Creativity and Emotions in Design Thinking Processes – An Empirical Study Based on Regulatory Focus Theory <i>Madeleine Kröper, Doris Fay, Tilmann Lindberg and Christoph Meinel</i>	97
Conceptual Design and Cognitive Elements of Creativity: Toward Personalized Learning Supports for Design Creativity <i>Yong Se Kim, JongHo Shin and Yun Kyoung Shin</i>	105
Analogical Design Computing	113
DANE: Fostering Creativity in and through Biologically Inspired Design <i>Swaroop Vattam, Bryan Wiltgen, Michael Helms, Ashok K. Goel and Jeannette Yen</i>	115
Development of a Catalogue of Physical Laws and Effects Using SAPPhIRE Model <i>Srinivasan V. and Amaresh Chakrabarti</i>	123
Measuring Semantic and Emotional Responses to Bio-inspired Design <i>Jieun Kim, Carole Bouchard, Nadia Bianchi-Berthouze and Améziiane Aoussat</i>	131
Design of Emotional and Creative Motion by Focusing on Rhythmic Features <i>Kaori Yamada, Toshiharu Taura and Yukari Nagai</i>	139
Design Synthesis	147
Create Adaptive Systems through “DNA” Guided Cellular Formation <i>George Zouein, Chang Chen and Yan Jin</i>	149
Developing a Coding Scheme to Analyse Creativity in Highly-constrained Design Activities <i>Elies A. Dekoninck, Huang Yue, Thomas J. Howard and Christopher A. McMahon</i>	157
Effectiveness of Brainwriting Techniques: Comparing Nominal Groups to Real Teams <i>Julie S. Linsey and Blake Becker</i>	165
Methods and Tools for Design Creativity	173
Front End Industrial Design (FE-ID) - Developing New Tools and Models for Industrial Designers to Operate at the Front End of New Product Development <i>Paul W. Wormald</i>	175
Virtuality – Offering Opportunities for Creativity? <i>Anthony Williams, Ning Gu and Hedda Haugen Askland</i>	183
Thinking Inside the Box: Model, Tool, Team and Setting for Building Design <i>Wim Zeiler</i>	191
Signs of Collaborative Ideation and the Hybrid Ideation Space <i>Tomás Dorta, Annemarie Lesage, Edgar Pérez and J.M. Christian Bastien</i>	199

Design Process and Cognition 2	207
Creativity: Depth and Breadth <i>Barbara Tversky and Juliet Y. Chou</i>	209
Research Methodology for the Internal Observation of Design Thinking through the Creative Self-formation Process <i>Yukari Nagai, Toshiharu Taura and Koutaro Sano</i>	215
Design as a Perception-in-Action Process <i>Katja Tschimmel</i>	223
Verbal Stimuli in Design Creativity: A Case-study with Japanese Sound-symbolic Words <i>Céline Mougenot and Katsumi Watanabe</i>	231
Visual Representation in Design	239
Creative Collaborative Strategies of Remote Sketching on Design <i>Luz-Maria Jimenez-Narvaez and Arturo Segrera</i>	241
Creation of New Fashion Illustration Painting Techniques by Use of India-ink Painting Techniques: Research into Line Drawing Techniques of Expression in Fashion Illustrations <i>Sachiko Nagasawa, Shin'ya Nagasawa and Kazunari Morimoto</i>	249
How Uncertainty Helps Sketch Interpretation in a Design Task <i>Winger S.W. Tseng and Linden J. Ball</i>	257
The Complementary Role of Representations in Design Creativity: Sketches and Models <i>Alejandro Acuna and Ricardo Sosa</i>	265
Design Education	271
A Creativity Environment for Educational Engineering Projects when Developing an Innovative Product: A Case Study <i>Karl Hain, Christoph Rappl and Markus Fraundorfer</i>	273
The Metaphor of an Ensemble: Design Creativity as Skill Integration <i>Newton S. D'souza</i>	281
Coaching the Cognitive Processes of Inventive Problem Solving with a Computer <i>Niccolò Becattini, Yuri Borgianni, Gaetano Cascini and Federico Rotini</i>	289
Creative Engineering Design Aspects given in a Creativity Training Course <i>Joaquim Lloveras, Miguel-Angel Saiz, Carlos García-Delgado, Jairo Chaur, Lluís Claudi, Anna Barlocci and Laura Carnicero</i>	297
Design Image and Inspiration	305
Differential Approach of Design Image and Similarity Cognition <i>Yi Ting Huang and Hung-Hsiang Wang</i>	307
Poetry and Design: Disparate Domains but Similar Processes <i>Erin L. Beatty and Linden J. Ball</i>	315
Design by Customer: a Management of Flexibilities <i>Risdiyono and Pisut Koomsap</i>	323
Author Index	329

List of Referees

Tomasz Arciszewski (USA)
Tomas Backstrom (Sweden)
Herbert Birkhofer (Germany)
Carole Bouchard (France)
Jean-Francois Boujut (France)
Julia Brewis (South Africa)
Anders Brix (Denmark)
David Brown (USA)
Nick Bryan-Kinns (UK)
Matthew Campbell(USA)
Linda Candy (Australia)
Hernan Casakin (Israel)
Gaetano Cascini (Italy)
Amaresh Chakrabarty (India)
John Clarkson (UK)
Steve Culley(UK)
Andy Dong (Australia)
Kees Dorst (Australia)
Alex Duffy (UK)
Gills Fauconnier (USA)
Ernest Edmonds (Australia)
Elena Mulet Escrig (Spain)
Mads Nygaard Folkmann (Denmark)
Haruyuki Fujii (Japan)
Shuichi Fukuda (USA)
Georgi V. Georgiev (Japan)
John Gero (Australia)
Ashok K. Goel (USA)
Gabriela Goldschmidt (Israel)
Samuel Gomes (France)
Ewa Grabska (Poland)
Ian Gwilt (Australia)
Karl Hain (Germany)
Sean Hanna (UK)
Noe Vargas Hernandez (USA)
Imre Horvath(Nethrelands)
Tom Howard (UK)
Norio Ishii (Japan)
Luz Maria Jiménez (Canada)
Yan Jin (USA)
Jeff Kan (Singapore)
Harrison HM. Kim (USA)
Yong Se Kim (Korea)
Masakazu Kobayashi (Japan)

Larry Leifer (USA)
Pascal Le Masson (France)
Udo Lindemann (Germany)
Julie Linsey (USA)
Joachim Lloveras (Spain)
Mary Lou Maher (USA)
Dorian Marjanović (Croatia)
Ann McKenna (USA)
Chris McMahon (UK)
Harald Meerkamm (Germany)
Gavin Melles (Australia)
Celine Mougnot (France)
Tamotsu Murakami (Japan)
Paul Murty (Australia)
Yukari Nagai (Japan)
Hideyuki Nakashima (Japan)
Margareta Norell (Sweden)
Koichi Ootomi (Japan)
Panos Papalambros (USA)
Jesenska Pibernik (Croatia)
Lubomir Popov (USA)
Vesna Popovic (Australia)
Lily H. Shu (Canada)
Masaki Suwa (Japan)
Yoram Reich (Israel)
Asko Riitahuhta (Finland)
Paul Rodgers (UK)
Pertti Saariluoma (Finland)
Kristina Shea (Germany)
Yoshiki Shimomura (Japan)
Steven Smith (USA)
Ricardo Sosa (Mexico)
Masahiro Takatsuka (Australia)
Hsien-Hui Tang (Taiwan)
Toshiharu Taura (Japan)
Katja Tschimmel (Portugal)
Barbara Tversky (USA)
Hung-Hsiang Wang (Taiwan)
Bert Willems (Netherlands)
Anthony Williams (Australia)
Terry Winograd (USA)
Hideyoshi Yanagisawa (Japan)
Wim Zeiler (Netherlands)
Yong Zeng (Canada)

Directions for Design Creativity Research (Invited Papers)

Discussion on Direction of Design Creativity Research (Part 1) - New Definition of Design and Creativity:
Beyond the Problem-Solving Paradigm

Toshiharu Taura and Yukari Nagai

Discussion on Direction of Design Creativity Research (Part 2) - Research Issues and Methodologies:
From the Viewpoint of Deep Feelings and Desirable Figure

Yukari Nagai and Toshiharu Taura

Future Directions for Design Creativity Research

John S. Gero

Systematic Procedures Supporting Creativity - A Contradiction?

Udo Lindemann

Better, Not Catchier: Design Creativity Research in the Service of Value

Gabriela Goldschmidt

Using Evolved Analogies to Overcome Creative Design Fixation

Steven M. Smith, Julie S. Linsey and Andruid Kerne

Design Creativity Research: From the Individual to the Crowd

Mary L. Maher

Motivation as a Major Direction for Design Creativity Research

Amaresh Chakrabarti

Design Research and Designing: The Synergy and The Team

Yong Se Kim

Discussion on Direction of Design Creativity Research (Part 1) - New Definition of Design and Creativity: Beyond the Problem-Solving Paradigm

Toshiharu Taura¹ and Yukari Nagai²

¹ Kobe University, Japan

² Japan Advanced Institute of Science and Technology, Japan

Abstract. This article discusses the meanings of “design” and “creativity.” First, the authors provide a historical review of the terminologies of “design” and “creativity” used in the field of design research. On the basis of this review, they aim to formulate a fundamental perspective of design for our future society that does not focus on the notion of efficiency and is not restricted by the framework of a problem-solving process. Next, they redefine design as the process of composing a desirable figure toward the future on the basis of their classifications of design as drawing, problem solving, and pursuit of the ideal. Finally, they identify the meanings of such a new definition of design in order to find the essential areas of research for design in the future post-industrial society.

Keywords: design, design creativity, design theoretics, post-industrial society, definition of design

1 Introduction

In this article, we discuss the meanings of “design” and “creativity.” The word “design” is increasingly being used in a variety of societal contexts—for example, career design, sleep design, and community design. The definition of design has continued to change along with the times. One reason that we affirm this evolution of the definition of design is to develop a new meaning of design for our future society. In particular, we aim to clarify the meanings of design through a comparison of two different eras: those of industrial society and post-industrial society. Based on a survey of the literature, we investigate the historical change in the definition of design. We then consider the generation that will follow the post-industrial society. We consider the stream of industrial change that has progressed from the first form of industry (agriculture) and the second form (manufacturing) to the third form of industry (service); this progression is a result of our orientation based on the notion of high efficiency. According to the movement of this stream, the next inclination in the third form of industry will still be oriented toward

efficiency. Thus far, “design” has played the role of providing a method of acceleration for obtaining increased efficiency in our industrial society. For most designed products, the expectation is that they must “be easy to use,” “be convenient,” “be cheap,” “consume low energy,” or “be easy to understand,” all of which involve the notion of efficiency.

In contrast, there is another view of design that aims to achieve goals other than that of efficiency, namely, to foster an improved sense of well being or richness of the heart of the society. These goals are more deeply related to our spiritual dimension than to our material wealth. Considering this aspect, design assumes a totally different meaning from its previous definition, which represents the dominant industrial perspective. Therefore, we consider it impossible to conceive of design by merely extending or elaborating the previous definition. This does not imply that no previous design was related to richness of the heart, as there have been certain previous types of design that have fostered spiritual values. However, it is still possible to view the history of design in the rough terms presented above. In addition, we should never consider efficiency as solely a negative influence, but should respect that role for what it has to offer. However, if the times change such that we can be released from a sole belief in efficiency, other important meanings of design can then arise, and it is these that we wish to shed light on. If such a time has come, then design can truly be discussed in greater depth, and we can see the society of the next generation in terms of a new perspective of design.

2 Survey of Definitions of Design

We have identified that design and creativity are inseparably connected to each other. As Herbert Simon said, because design can still be about transforming existing situations into preferred ones, in the field of design research, design is usually explained as being

an activity to formulate a design solution for a purpose (Simon, 1973). The process of design has been seen as a process of rational problem solving. However, such a definition can be considered to be a tentative one in terms of transcendent or historical views. In this section, we review the previously dominant definitions of design.

2.1 Genealogic View of Definitions of Design

The word “design” means a “plan,” a “pattern,” a “composition,” or an “intention.” It originally came from the French word “desinare,” which was derived from the Latin word, “signum.” Words in several other languages are also used in a way that is similar to the English word “design” (Ulrich, 2007). The meanings of design basically involve two phases: the mental plan for something, and then the creation of forms. In “Design Dictionary” (Ernhoff and Marshall, 2008), we learn that Leonardo da Vinci founded an academy that was dedicated to design. The idea of design still seemed to express something like styling, as we understand it, because it meant “the arrangement of lines and shapes as decoration,” but that was following a very old tradition with a meaning limited to the perspectives of the crafts era. Indeed, the meanings of design reflected the society of that time. In the modern era, design is explained as being “developed through the actions of key individuals responding to the new potentials and fears associated with developments in technology and to changing socioeconomic and political conditions and contexts” (Design Dictionary, P106). The most remarkable change leading to this new definition was the Industrial Revolution at the end of 18th century. In tune with the new ethos of the industrial revolution, the meaning of design changed, with an emphasis upon its more constructive aspect, as it was understood more as an engineering-based process. Around 1919, the Bauhaus and other new design movements arose in many places in Europe, all of which shared quite similar goals, namely “beauty,” “wealth,” and “efficiency.” It was thought that the best way to integrate these three goals was to establish a reasonable “standard.” Thus, “beauty” came to be understood as a rational value, in the sense of aesthetics having true worth. With the flourishing of industrial society that came afterwards, the definition of design changed in order to embrace the now-common large-scale manufacturing process (Asimow, 1962). The definition was again modified to be consistent with the problem-solving processes of industry. In fact, the framework of the problem-solving process became aligned with the methodologies of design in the industrial era, especially in terms of its management (Jerrard et al.,

1998). Most design researchers used frameworks based on a problem-solving process model to explain the rational design process of that time. Indeed, design can be seen as an example of a process of construction whose aim is to solve ill-structured problems that lack clarity in terms of both the existing situation and the desired outcome. When people cannot see how to attain goals, they may develop methods that connect intermediate goals in order to do so. In large-scale manufacturing such as shipbuilding, for example, the entire process aims to solve a problem that is too complicated in its entirety, but which can be broken down into hierarchic, simpler, more manageable sub-problems (Simon, 1999). Thus, the engineering designs used in shipbuilding are methods of structuring the overall project into many partial problems. To identify rational methods for solving such complex problems (namely “design problems”), classification of the sub-problems and a systematic overview are required, particularly in engineering design (Eide et al., 2008). Thus, a field of design methodology has been established on the basis of such a problem-solving framework and systematic approach (Archer, 1965; Cross, 1984; Batazit, 2004). This field mainly addresses methods of “problem re-structuring” or “problem shifting” in order to attain the goals of “the design problems.” In the field of design methodology, a basic model of design that represents the three main steps of design, namely analysis, synthesis, and evaluation, became popular and was developed in several ways (Goldschmidt, 1999; Batazit, 2004). March has classified the patterns of design problems and design reasoning (March, 1976). Coyne and others represented a definition of designers whose purpose was to change the existing situation in order to create a desired situation by means of physical change (Coyne et al., 1990). Their approach considered that design knowledge should be representative, and they suggested that design activities should be “descriptions of the functions of artifacts” that would then fulfill their expected functions.

However, as time passed, such definitions of design changed. When society entered the post-industrial era, the definition of design gradually became separated from the manufacturing process, a change that had been anticipated by design researchers. Indeed, as middle as the 1970s, Nigel Cross projected such a change and posed the message to his colleagues of how to commit to and contribute to the new society. His essential suggestion was, “to consider whether we are now entering a post industrial society and consequently in need of a post-industrial design process” (Lawson, 2006).

To adapt to the needs of post-industrial design, Cross (2006) proposed a new view of the ability to

design that he expressed as “designerly ways of knowing.” The capacities of design were considered to be more general than before, more like the capacity to “think,” which included the talent of knowing “how to see.” Design knowledge was also considered as an ability because it constituted a strategic form of knowledge that provided methods of problem solving based on previous solutions.

Another view of the meaning of design was proposed from the perspective of business and management. Ulrich and Eppinger (2007) expressed the view that design is formed in the real world. Because the market in the real world represents consumers’ actual selection of products, it can be seen as a process similar to that of evolution. Therefore, design can be defined as a process of product evolution that is governed by the decisions made by the society.

The above description is a brief overview of the history of how design has been defined over recent centuries. This history can be considered as the development of the “problem-solving process” in the era of industrial society. In this article, we call such a view of design “a problem-solving paradigm.” Now, that view and the framework it represented must give way to the next step of progress.

A serious problem that has been pointed out is that the paradigm of an analytical view that is in accord with the view of a “problem-solving process” does not work in the post-industrial society that is now being born from the social sciences and economics. In addition, it has been suggested that people in today’s society need creativity more than before in order to overcome the difference in the old and new paradigms. However, the question of what kind of creativity is necessary for this new society remains unanswered. This article, therefore, will next discuss the important issue of creativity.

2.2 Genealogic View of Definitions of Creativity

In the field of design research, two kinds of creativity have been discussed. One kind of creativity is related to the process of design, while the other is related to the products that are the result of the design process. In the former, the emphasis is on rational decision-making to find a design solution within a framework of problem solving. Cross (2006) has reported many cases of creative leaps that are made during the design process, expansions of awareness that may have been caused by the release from a mental fixation.

The role of visual information is considered to be conducive to such releases from mental fixations. In fact, it has been supposed that experts have actual knowledge of how to break such fixations. Until now,

analogical reasoning has been given the most attention because it relates to the problem-solving process (Findler, 1981; Goldschmidt, 1990; Visser, 1996; Ball and Christensen, 2009). Many studies have reported that metaphors and visual images are effective for analogical reasoning (Goldschmidt 1994;), and expert designers seem to understand the roles that these metaphors and visual images play. These studies have claimed that the capacity for visual thinking might be particularly expanded in the cognitive process of designers, referring to the theory of Rudolf Arnheim (1969). Goldschmidt has identified the effects of the ideas that occur (concepts) to the ones on the abstraction level during the design process, which she relates to creativity by carrying out experimental studies. These results were obtained through experimental observation of architectures’ design protocols. Such experimental observation of design process has been called “design protocol studies” and informs cognitive features of the creative design process (Kan and Gero, 2009).

There are other standards as well with which to evaluate creativity. For instance, the value of the diversity of products or the speed at which goals are achieved is often used as evaluation items in assessments of creativity (in the Encyclopedia of Creativity).

In addition, Eppinger and Ulrich (2007) suggested that the actual results of marketing express the values of creativity of designed products in the real world. They have also suggested that diverse productions affect our power to create products in the next generation.

On the other hand, the creativity of designed products or the ideas governing them have usually been evaluated in terms of novelty and practicality, two criteria offered by the study of Sternberg and Lubert (1999). They described creativity as the ability of produce work that is both novel and appropriate. Gero (2007) has added the notion of “unexpected” to these criteria in the evaluation of creativity in design.

As we pointed out earlier, design has been discussed mainly within a framework of problem solving. In such a framework, ability means the ability to analyze problems, which is of course a necessary skill in the problem-solving process. However, in the post-industrial society, a form of creativity is required that is different from the old problem-solving paradigm. We would say that this ability is the capacity for creativity in design. However, what this exactly means must be clarified in our contemporary context. Therefore, we will next re-consider how this term might be newly defined.

3 New Definition of Design and Creativity

3.1 Classification of Design

As a foundation for this new definition, we first classify design into three categories: drawing, problem solving, and the pursuit of an ideal.

Category A: Drawing

The term “design” is widely thought of as the expression of images in the form of pictures or sketches; in other words, it is strongly associated with art or drawing. This is how the term is typically considered in its most popular and general use. Although drawing seems to be creative, the drawing process cannot create a truly new output, because drawing itself is a process that involves only the transformation of a design image (an abstract concept imagined in the designer’s mind) into a concrete figure or shape. Thus, it is creative only in that it entails imagining a nonexistent figure or shape. Therefore, the essential nature of its creativity lies in the design image that the figure or shape then represents.

Category B: Problem solving

In our review of the history of design, the notion of design comes to the fore when we address the process or act of designing rather than its results in the form of sketches and drawings, particularly since the development of industry to its present degree. In this case, we have thus far considered the design process mainly within the framework of problem solving. However, the problem-solving process itself cannot really create a new goal. Therefore, our next concern is with the question, “how do we determine the desired goal?” We can have obvious goals (problems) that need to be achieved, such as finding solutions for natural disasters. Similarly, in the case in which we need to meet customer requirements that are clearly spelled out, it is also easy to set goals. However, there are sometimes cases in which the goals themselves are unclear.

Category C: Pursuit of the ideal

We can also use the term “design” to mean the pursuit of certain ideals, a definition whose meaning differs from the predominant definition of design as the solving of obvious problems. For example, from a social perspective, design involves the notion of pursuit of an ideal. Moreover, the term “pursuit of an ideal” contains within it the notion of the future, as opposed to the problem-solving perspective that is usually used in the context of current problems. We can identify one distinct feature of design as being

something that is aroused within us and is supported by the requisite criteria of our ideals. It involves the presence of a process of abstraction in an ideal environment. Moreover, it recognizes designs that conform to our perspective of the “future” and “something that is meant to be”—that is, something that only human beings can conceive of.

3.2 New Definition of Design and Creativity

Based on the above consideration, we would re-define design as the process of “composing a desirable figure toward the future.”

Regarding this definition, we will first discuss what we mean by “toward the future.” The notion of the future is, of course, extremely abstract. For example, we can never draw an exact picture of the future. We can imagine what things may be like in the future, but it is impossible to visualize a precise notion of the future itself. This kind of highly abstract notion can only be represented in language. In the context of design, the future has two meanings. One meaning is a future that we can grasp inductively, such as a marketing forecast. The other meaning is the wish or desire for recognition/expression that is led by inner feeling, as in art. In our re-definition of design, we consider that the latter meaning is the more important of the two.

Next, we discuss what we mean by a “desirable figure.” It is this part that determines the object of design. There are two kinds of desirable figures: obvious goals in the case of a problem-solving process, and an ideal image in the case of the pursuit of an ideal. As suggested above, in our re-definition of design, we consider this latter object of design to be of greater importance. In this case, a feeling of resonance in the mind can be a reason for an ideal image. One important point regarding artifacts is the notion of “naturalness.” We often assume that the process of making artifacts should come naturally to humans. However, there is no common process that resonates with human beings, even though we create artifacts by copying them from the natural world. In contrast, there are some things that differ from what is found in nature but nevertheless resonate within the human mind. Music is a good example. Music is composed of man-made sounds, most of which differ from natural sounds such as the sound of a breeze or a bird’s song. In fact, music resonates in the human mind, where it makes a deep and natural impression. It is in the human mind that the desirable figure of the artifact originates. Therefore, in order to realize a desirable figure, it is necessary to identify the sources of deep feelings in the human mind.

Finally, we will discuss the idea of “composing,” because it provides an explanation for the process of design. In design, one of the typical processes is the composition of parts, because the way in which we create products differs from the process of creation in the natural world. A method for such an integration of existing concepts (in other words, “concept synthesis”) is well known (Finke et al., 1992; Taura and Nagai, 2005; Nagai and Taura 2009). For the integration of existing concepts (concept synthesis), particularly in the pursuit of desirable figures, it is not enough to just carefully analyze the given goals. It is also necessary to imagine the desirable figure in the future, and there must be an intrinsic motivation that resonates with one’s inner feelings. In this article, we use the term “composing” to embrace just such motivations.

On the basis of the above definition, we define design creativity as the degree to which a desirable figure is realized. In this approach, novelty may be implemented as a by-product of this pursuit, but not as a causal factor of creativity. Thus, if a new idea is proposed merely on account of its uniqueness, we cannot say that this partakes of the aim for desirable figures.

4 Meaning of New Definition of Design

We will now discuss the meaning of our new definition of design as compared to its previous definition.

First, we consider the ability to design from the viewpoint of creativity. We can understand that problem-solving ability (category B) is related to “innovation,” in which the novel idea for a problem-solving plan that is difficult to conceive is finally realized. A plan might also be considered innovatory if it is not particularly novel but involves difficulties that must be overcome in its realization. Within the framework of a problem-solving process, a problem is defined as the difference between the current state and the desired goal. Thus, the process of developing a solution to achieve the goal is synonymous with the design process. In many cases, the solution can be found by analyzing the gap between the current state and the design goal. In other words, it can be said that the solution lies hidden in the gap. Therefore, the ability to solve problems can be considered to be an analytical skill.

On the other hand, based on the new definition of design advanced in this article, it is important for the ideal image to be pursued. Designers must have the ability to compose the ideal functions of the future, or the ability to compose an interface that will evoke an

ideal impression in the recipient’s mind. As mentioned in the previous section, ability in composition is needed in order to create ideal images in design.

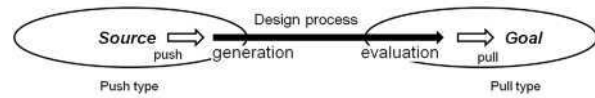

Fig. 1. Extended model of the design process

We have proposed an extended model of the design process that involves two dynamics: a “push” type and a “pull” type (Taura and Nagai, 2009). Figure 1 shows the extended model. On the basis of this model, the design process as we define it can be explained as the process of composing a design image that is being “pushed” from the source of deep feelings that resonate with our inner minds. The design image is the same as “a concept,” as referred to earlier. Thus, a push-type design process is the process of composing “a concept” that represents a desirable figure. In contrast, a “pulled” process is a problem-solving process that is “pulled” forward from a predetermined goal. As we consider the process of composing a desirable concept, our emphasis will be on the roles of a push-type process.

Next, we discuss our new definition of design from the viewpoint of “characteristics of humans.” Although we confess that the boundary here is a bit ambiguous, our scope of interest is those actions that only a human being is able to perform. We suppose that other animals (such as monkeys) can probably perform a certain degree of problem solving. In fact, it is well known that monkeys use tools in their food taking, a behavior that is certainly a sort of problem solving. The notion of design that we defined above, by contrast, is something that could never be done by monkeys. These are things that only a human can do: to imagine a desirable figure, to conceive of things using abstract notions like “the future,” or to compose a new concept with a high level of intelligence.

We can understand that the post-industrial society has revealed our deepest human wish. Humans need to imagine desirable figures that express a “better sense of well-being” or “richness of the heart.” It can become possible for us to have such figures when we approach the process of design with an understanding of our new definition of its meaning. It can be said that post-industrial society indicates that the new meanings of design is centered in what this paper presents as category C, namely the pursuit of an ideal.

5 Conclusion

In order to identify the meanings of design, we have discussed the terminology of design and creativity based on a historical review. Following a classification of design that consists of three categories—drawing (category A), problem solving (category B), and pursuit of the ideal (category C), we discussed the importance of design in the pursuit of an ideal (category C) in our future society, as compared to design within the framework of a problem-solving process (category B).

We have re-defined design as being the process of composing a desirable figure toward the future.

On the basis of this new definition of design, we will next propose design theoretics to formulate a framework for studying design in our future society, after the passing of the post-industrial era. The pertinent and essential research issues will also be addressed, and will be introduced in Part 2 of our article.

References

- Archer B, (1965) Systematic method for designers. London: The design council (republished 1984, in *Developments in Design Methodology*, ed. Cross N)
- Arnheim R, (1969) *Visual Thinking*. University of California Press
- Asimow M, (1962) *Introduction to Design*. Prentice-Hall
- Ball LJ, Christensen BT, (2009) Analogical reasoning and mental simulation in design: two strategies linked to uncertainty resolution. *Design Studies* 30(2):169–186
- Bayazit N, (2004) *Investigating Design: A Review of Forty Years of Design Research*. *Design Issues* 20(1):16–29, MIT Press
- Coyne D, Rosenman M, Radford D, Balachandran M, Gero J, (1990) *Knowledge Based Design Systems*. Addison-Wesley Publishing Company Ltd.
- Cross N, (1975) *Design and Technology*. Open University Press
- Cross N, (1984) Introduction. in *Developments in Design Methodology*, John Wiley & Sons Ltd.
- Cross N, (1989) The nature and unnature of design ability. *Design Studies* 11(3):127–140
- Cross N, (2006) *Designerly Ways of Knowing*. Birkhauser
- Eide A, Jenison R, Northup L, Mashaw L, (2001) *Introduction To Engineering Design and Problem Solving*. Mcgraw-Hill's Best-Basic Engineering Series and Tools
- Erlhoff M, Marshall T, (2008) *Design Dictionary*. Board of International Research in Design, Birkhauser Verlag AG
- Findler NV, (1981) Analogical reasoning in design process. *Design Studies* 2(1):45–51
- Finke RA, Ward TB, Smith SM, (1992) *Creative Cognition: Theory, Research, and Applications*. Cambridge, MA: MIT Press
- Gero JS, (2007) on his talk “Design Creativity”, ICED07 SIG Design Creativity Workshop
- Goldschmidt G, (1990) Linkography: Assessing design productivity. In Trapp R, (Ed.), *Cybernetics and systems* 90:291-298, Singapore: World Scientific
- Goldschmidt G, (1994) On visual design thinking: the vis kids of architecture. *Design Studies* 15(2):158–174
- Goldschmidt G, (1999) Design. In *Encyclopedia of creativity*, Runco MA, Pritzker SR, (eds.), Academic Press, 525–535
- Jerrard B, Newport R, Trueman M, (1998) *Managing New Product Innovation*. CRC Press, Taylor & Francis
- Kan JWT, Gero JS, (2009) Using the FBS ontology to capture semantic design information in design protocol studies. In McDonnell J, Lloyd P, (Eds), *About: Designing. Analysing Design Meetings*, CRC Press, 213–229
- Lawson B, (2006) *How designers think*, fourth edition. Architectural Press
- March L, (1976) *The logic of design and the question of value*. The Architecture of Form, Cambridge University Press
- Nagai Y, Taura T, Mukai F, (2009) Concept blending and dissimilarity: Factors for creative concept generation process. *Design Studies* 30(6):648–675
- Simon HA, (1973) The structure of ill-structured problems. *Artificial Intelligence* 4:181–200 (Republished 1984)
- Simon HA, (1999) *The Sciences of the Artificial*. Third Edition, Cambridge, MA: MIT Press
- Sternberg R, Lubart T, (1999) The concept of creativity: Prospect and Paradigms. *Handbook of Creativity*, Cambridge University Press
- Taura T, Nagai Y, (2005) Primitives and Principles of Synthetic Process for Creative Design-Taxonomical Relation and Thematic Relation. In *Computational and Cognitive Models of Creative Design VI*, Gero JS, Maher ML, (Eds.), 177–194
- Taura T, Nagai Y, (2009) *Design Creativity: Integration of Design Insight and Design Outsight*. Special Issue of Japanese Society for the Science of Design 16-2(62):55–60
- Ulrich KT, Eppinger S, (2007) *Product Design and Development* 4. McGraw Hill Book Co.
- Ulrich KT, (2007) *Design: creation of artifact in society*. <http://opim.wharton.upenn.edu/~ulrich/designbook.html>
- Visser W, (1996) Two functions of analogical reasoning in design: a cognitive-psychology approach. *Design Studies* 17(4):417–434
- Visser W, (2006) *The Cognitive Artifacts of Designing*. London: Lawrence Erlbaum Associates, Publishers

Discussion on Direction of Design Creativity Research (Part 2) - Research Issues and Methodologies: From the Viewpoint of Deep Feelings and Desirable Figure

Yukari Nagai¹ and Toshiharu Taura²

¹ Japan Advanced Institute of Science and Technology, Japan

² Kobe University, Japan

Abstract. On the basis of our definition of design as “composing a desirable figure towards the future,” research issues and methodologies are discussed in this article. First, we point out three research issues, which we call the inside-outside issue, the issue of the abstraction process, and the back-and-forth issue. Throughout this discussion, these issues will help us to identify the significance of a concept-composing process (concept synthesis) that is “pushed” from the source of deep feelings. Next, these issues serve to introduce three potential methodologies of design research, namely, internal observation, computational simulation, and theoretical modeling. Further, the authors demonstrate an example of the design of a desirable motion by assuming that an emotional and creative motion extends beyond the images produced by the human ordinal imagination, which in order to resonate with the feelings residing deep within us. Finally, they indicate open issues for further discussion.

Keywords: design, design creativity, design theoretics, research methodology, deep feelings

1 Introduction

In the previous article, we have identified the features of design and creativity in post-industrial society and proposed a new definition of design as “composing a desirable figure toward the future” a definition that is expected to extend beyond the framework of a problem-solving paradigm (Taura and Nagai, 2010). We designate the discipline of design with regard to this definition as “design theoretics.”

We discuss the key issues in design theoretics. First, we point out the research issues. Next, we introduce potential methodologies. Further, we demonstrate an example of the desirable design.

2 Research Issues in Design Theoretics

According to our new definition, the design process is explained as being the process of composing a desirable image while being pushed from the source of deep feelings. By focusing on these characteristics, we are then able to systematize our approach to research issues in design theoretics.

Design theoretics is concerned with the three main issues: (1) the inside-outside issue, (2) the issue of the abstraction process, and (3) the back-and-forth issue. (1) and (2) are related to space issues—(1) is a horizontal issue and (2) is a vertical issue—whereas (3) is related to the issue of time.

2.1 Inside-outside Issue in Design Thinking

The inside-outside issue in design thinking is divided into three sub-issues, as follows:

1. Boundary determination from inside or from outside
2. Intrinsic motivation versus extrinsic motivation
3. Perspectives from inside or from outside

The first sub-issue regards from which direction the boundary of thought space is determined, that is, whether from the inside or from the outside. “Autopoiesis” (which means self-creation), as applied to organization, explains that boundaries will be determined from the inside (Maturana and Varela, 1980). On the basis of autopoiesis, Winograd and Flores (1989) has introduced the framework of a network system that is formed in a topological manner (namely, autonomy). Winograd asserted the importance of software engineering in the planning of an interactive system as a form of information design

(Winograd, 1996). On the other hand, the process of creating art can be viewed as a self-referential process or a self-recognition process, because during the creative process, it is impossible to separate the artist from the created work (Hass, 2008). These are thought-provoking ideas that arise from this sub-issue, and we suppose that the boundary of the thought space of design can be determined from the inside (Nagai and Taura, 2006; Taura and Nagai, 2009).

The second sub-issue regards the motivation of the design. Many previous studies of human creative activities have reported the important role of motivation, in particular, the role of intrinsic motivation (Maslow, 1970; Amabile, 1985; Deci and Ryan, 1985; Sternberg, 1988; Conti and Amabile, 1999). Such motivation is related to the state of absorption of people who are deeply engaged in creative activity, which is totally different from the experience of extrinsic motivation of those working to obtain their reward from outside (Loewenstein, 1994; Csikszentmihalyi, 1996).

The third sub-issue deals with the location from where design thinking is captured. This is related to our observations on design. With regard to the first sub-issue, it seems impossible to observe the activity of design thought from outside because the thought space is determined from inside. It is also difficult to observe this activity at the time people are actually absorbed, as mentioned with regard to the second sub-issue. Therefore, we must say that research into the process of deep design thinking meets with difficulty or limitation. An innovative, creative research methodology is required to respond to the challenge of this sub-issue.

2.2 Issue of Abstraction Process in Design Thinking

Composing a new concept by synthesizing multiple abstract concepts is a sophisticated activity (Rothenberg, 1979; Ward et al., 1997; Sternberg and Lubert, 1999; Taura and Nagai, 2009). For example, if we knew only the two concepts of “red pencil” and “yellow car,” we could derive abstract concepts from them such as “red colored objects” and “moving objects.” We could then manipulate these abstract concepts to form new abstract concepts such as “a moving object with a red color” (such as a red car) and “a non-moving object whose color is not red” (such as a black pencil).

In General Design Theory (GDT), the concept regarding entity (entity concept) is modeled as an element, and the abstract concepts are modeled as a class (subset of elements) in set theory (Yoshikawa,

1981). The process of synthesizing multiple abstract concepts is modeled as the process of finding the intersection of these classes corresponding to each entity concept. Here, the process of abstraction is considered to be the process of extracting a number of common attributes (features) from a number of existing objects (Taura and Nagai, 2009). In the above example, the attributes (feature) of “red color” or “moving” are extracted. Even apart from the context of GDT, this notion of abstraction has been widely accepted.

On the other hand, there is another meaning of “abstract.” This is the meaning used in art, for example, in the term “abstract painting.” In this usage, abstract paintings are drawn neither from the attributes of objects nor from the simpler representation of the object (Nagai and Taura, 2009). Such paintings are perhaps conceived in the mind of the artist. We consider such a process to be definitely connected with the desirable figure we have elaborated in our new definition of design.

2.3 Back-and-forth Issue in Design Thinking

We have explained the concept-composing process as being the synthesis of a number of concepts (concept synthesis). However, it is extremely difficult to select the appropriate concepts (base concepts) to be synthesized before designing, because the appropriateness of these concepts can only be evaluated after they have been synthesized and the design product has been evaluated. We designate this issue as the “back and forth issue.”

In certain cases, the back-and-forth issue can take the form of a spatial issue. For example, consider the situation when we attempt to identify a beam of light that passes through a reflection in a mirror (Figure 1). If we attempt to predict the path of the beam based on the knowledge that “a beam of light travels along the path that takes the shortest time,” we are unable to evaluate whether or not a path takes the shortest time before the beam has actually travelled.



Fig. 1. Path of the beam through a reflection in a mirror

However, if we apply the knowledge that “the angle of incidence is equal to the angle of reflection,” then it becomes possible to calculate the path of the light beam before we actually observe the travelling beam. In this case, the back-and-forth issue from the viewpoint of time is converted into a spatial issue.

GDT provides a rigorous method in this area. In GDT, the design process is defined as a mapping from the function space, where the specification is described and a design solution is evaluated, to the attribute space, where the design solution is described. To effectively search a design image (design solution), it is necessary to determine an appropriate searching space, and in particular, to determine the classes (subsets of entity concepts) that are used to search for the design image. With regard to this issue, it is expected that the introduction of a metric into the design space (function space and searching space) and the preservation of the similarity between these two spaces, make it possible to effectively search for a design image. In other words, if two concepts are close to each other in the searching space, under the condition that the same concepts are close to each other in the function space (evaluation space), then the search for a design image may be effective (Figure 2). This rule is valid only when the design image is searched for using a neighborhood search method.

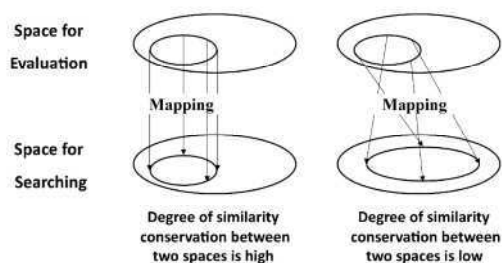

Fig. 2. Preservation of the similarity between evaluation space and searching space

Taura identified the above method of converting the back-and-forth issue into a spatial issue by applying it to the function decomposition process in design (Taura, 2008). In the initial stage of the design process, the required functions are generally decomposed into a few partial functions. Although this process is not always necessary when finding design images, its usefulness in the design process is well recognized. Not only has its importance been indicated in an empirical study, but its rationale has also been analyzed in a theoretical study.

3 Research Methodologies of Design Theoretics

One particular feature of design is to compose a design image that is a new concept that has never before existed. It is thus more important to discuss the consideration of concepts during the composing process than to simply discuss the resulting concept. Based on this belief, we have conducted challenging research on creative design and will now introduce some examples in this article.

3.1 Internal Observation of Design Thinking

As mentioned above, to observe the design thinking from an inner perspective is quite difficult when people are deeply engaged in their work. The reason for this is that when they are absorbed in their work, it is assumed that they have entered into the mental state known as “flow” (Csikszentmihalyi, 1990). The external observation of the design thinking may fail to grasp it because it is pushed from intrinsic motivation. Thus, it may be impossible to observe design thinking from either an internal or an external perspective. To surmount this barrier, we have tried to formulate a methodology on the basis of the idea that a method of inner observation is valid when the occurrence of the self-forming process (the process of forming the self) is confirmed during the observing process. Here, the “observed self” may be different from that of “the self” (the self when observation is not taking place).

We would propose a challenging method, whose characteristics are as follows. First of all, the method is based on reports. Second, it involves both an outer perspective and an inner perspective. Third, the method identifies the occurrence of novel motifs through the integration of both perspectives. The key factor that reveals the effectiveness of this method is whether or not the self-forming process is identified, that is, whether or not the occurrence of certain novel motifs (observed self) during the design process is identified. We can obtain significant results by carrying out a long-term experiment using the above research method, and report these results in detail in another paper (Nagai et al., 2010).

3.2 Computational Simulations

When observation is difficult, computational simulation is a methodology that is commonly applied. With the recent rapid development of computer science, the possibility of simulating the design thought process has become stronger. We have paid attention to semantic networks as a framework in which to simulate the process concept composition. In

fact, we have developed a method for simulating a concept-generating process. In this method, we focus on the notion of association between concepts. Concept association is assumed to be a key notion in design thinking during concept synthesis (Figure 3). We attempted to actualize this association process in a semantic network (Yamamoto et al., 2009).

Another application of this method is the investigation of the impressions evoked by designed products. When designing products, designers need to create products that evoke feelings that are congenial to the emotional impressions of consumers (Feng et al., 2009); in other words, the products should be preferred by most people. We assume that there are certain kinds of emotional impressions that a user receives from a product that will affect that user's preference. We therefore focus on the impressions that may underlie the "surface impressions" that a user ordinarily receives when viewing a product, which we refer to as "deep impressions." We consider that certain "deep factors" may function in tandem with affective processing and result in the development of preferences. In order to construct a methodology for capturing deep impressions, we developed a method of constructing a "virtual impression network" using a semantic network (Taura et al., 2010).

The aim of these simulations is not only to reproduce design thinking or the process of receiving impressions but also to precisely determine a desirable design process and design products virtually.

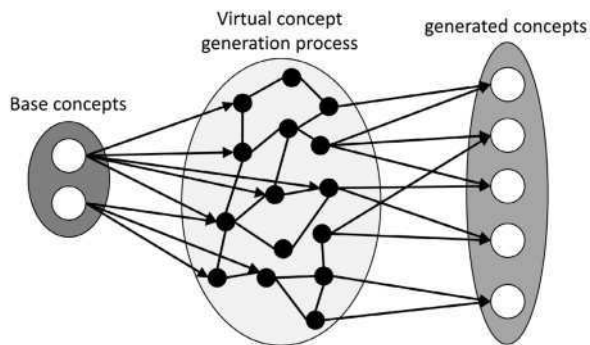

Fig. 3. Virtual concept generation process

3.3 Theoretical Modeling

There is another research methodology that addresses a desirable design process or designed product theoretically, making reference to philosophy, mathematics, and aesthetics. General Design Theory (GDT) is a good example. In GDT, the "ideal design

space" is defined as one in which all the elements of the entity set are known and each element can be described by abstract concepts without ambiguity. The ideal design space is found to be a Hausdorff space, which is a separate space in which, for example, a red pencil (red and non-moving) can be distinguished from a yellow car (yellow and moving). Furthermore, the condition of separate space makes it possible for the design space to be a metric space, which is the basis of the preservation of the similarity between spaces, as described in the previous section. This discussion would suggest that the formation of ideal design knowledge generates the potential to promote the design process.

In another case, the notion of a particle is an example of such an ideal model. It provided an explanation of practical dynamics that formed a strong basis for the development of engineering from that point forward. However, we should note that the notion of a particle is nothing more than a notion. That is, such an object that has mass but not volume cannot exist.

Here, we would like to emphasize the fact that the knowledge of ideal design and the notion of a particle both involve an "ideal" situation. Furthermore, it can be said that while these models are completely different from actual phenomena, they are extremely useful to explain many actual phenomena.

Based on the above considerations, we can infer that the notion of "desirable" may be different from the notion of "existable," that is, from what can actually exist. A desirable design process or desirable design product need not necessarily exist.

We should note that design research has not yet taken to pursuing such a desirable model. Such an endeavor should be encouraged in the future.

4 Example of Design Pursuing Desirable Figure

We will introduce our recent trial design, which involves the design of a motion by focusing on rhythmic features. We are developing a method for designing an emotional and creative motion that resonates with deep feelings (Yamada et al., 2010). This study is based on the hypothesis that motion that is beyond ordinary human imagination may produce emotional impressions that resonate with deep feelings. The proposed method involves an analogy with natural objects, the blending of motions, and an emphasis on rhythmic features. In order to design an emotional and creative motion, we attempt to construct a computer system that implements the proposed method. An experiment to verify the effectiveness of

the proposed method and the validity of our hypothesis was performed.

An interesting result we have seen is that designed motions that seem to come from beyond our ordinary imagination are evaluated as being more “impressive” (as evoking deeper feelings). This result is consistent with the idea mentioned in the previous section, namely that desirable design need not necessarily be “existable.”

5 Conclusion and Open Issues for Future Work

In this article, we have discussed the key issues in design theoretics. First, we pointed out three research issues: the inside-outside issue, the issue of the abstraction process, and the back-and-forth issue. Next, we introduced three potential research methodologies of design, namely internal observation, computational simulation, and theoretical modeling. Further, we demonstrated an example of the design of a desirable motion with the findings that designed motions that seem to come from beyond our ordinary imagination are evaluated as being more “impressive” (as evoking deeper feelings).

Throughout the discussion in this article, “deep feelings” and “desirable” are found to be key notions. Furthermore, these two notions interact with each other.

As a result, the following questions present themselves as open issues.

- What are “deep feelings”?
- What is the notion of “desirable figure”?
- How can we capture “deep feelings”?
- How can we capture the notion of “desirable figure”?

We expect that these open issues will be explored as the subject of ongoing discussion.

References

- Amabile TM, (1985) Motivation and creativity: Effects of motivational orientation on creative writers. *Journal of Personality and Social Psychology* 48(2):393–399
- Conti R, Amabile T, (1999) Motivation/Drive. In *Encyclopedia of Creativity*, Runco MA, Pritzker SR, (eds.) Vol 2, Academic Press
- Csikszentmihalyi M, (1990) *Flow: The psychology of optimal experience*. New York: Harper & Row
- Csikszentmihalyi M, (1996) *Creativity: Flow and the psychology of discovery and invention*. New York: Harper Collins
- Deci EL, Ryan RM, (1985) *Intrinsic Motivation and Self-Determination in Human Behavior*. Perspectives in Social Psychology, Springer
- Hass L, (2008) *Merleau-Ponty’s Philosophy*. Bloomington and Indianapolis: Indiana University Press
- Loewenstein G, (1994) The psychology of curiosity: A review and reinterpretation. *Psychological Bulletin* 116(1):75–98
- Maslow A, (1970) *Motivation and Personality*. New York: Harper (First edition: 1954)
- Maturana HR, Varela FJ, (1980) *Autopoiesis and Cognition: the Realization of the Living*. Boston: Springer, D Reidel
- Nagai Y, Taura T, (2006) Formal Description of Conceptual Synthesizing Process for Creative Design. In *Design Computing and Cognition 2006 (DCC’06)*, edited by Gero JS, Springer, 443–460
- Nagai Y, Taura T, (2009) Design motifs: Abstraction driven creativity. *Special Issue of Japanese Society for the Science of Design* 16-2(62):13–20
- Nagai Y, Taura T, Sano K, (2010) Research Methodology for the Internal Observation of Design Thinking through the Creative Self-formation Process. *Design Creativity* 2010, Springer, 215–222
- Rothenberg A, (1979) *The emerging goddess*. Chicago: University of Chicago Press
- Sternberg R, Lubart T, (1999) *The concept of creativity: Prospect and Paradigms*. Handbook of Creativity. Cambridge University Press
- Sternberg RJ, (1988) The nature of creativity, *Contemporary psychological perspectives*. New York: Cambridge University Press
- Taura T, (2008) A solution to the back and forth problem in the design space forming process—a method to convert time issue to space issue. *Artifact* 2(1):27–35
- Taura T, Nagai Y, (2009) Design Creativity: Integration of Design Insight and Design Oversight. *Special Issue of Japanese Society for the Science of Design* 16-2(62):55–60
- Taura T, Nagai Y, (2010) Discussion on Direction of Design Creativity Research (Part 1) - New Definition of Design and Creativity: Beyond the Problem-Solving Paradigm. *Design Creativity* 2010, Springer, 3–8
- Taura T, Yamamoto E, Fasiha MYN, Nagai Y, (2010) Virtual impression networks for capturing deep impressions. *Design Computing and Cognition 2010 (DCC’10)*, Springer 559–578
- Ward TB, Smith SM, Vaid J, (1997) *Creative thought: An investigation of conceptual structures and processes*. Washington, DC: American Psychological Association
- Winograd T, (1996) *Bringing Design to Software*. NY: ACM press, Addison-Wesley
- Winograd T, Flores F, (1986) *Understanding Computers and Cognition—A new foundation for Design*. Norwood
- Yamada K, Taura T, Nagai Y, (2010) Design of Emotional and Creative Motion by Focusing on Rhythmic Features. *Design Creativity* 2010, Springer, 139–146
- Yamamoto E, Goka M, Fasiha MYN, Taura T, Nagai Y, (2009) Virtual Modeling of Concept Generation Process for Understanding and Enhancing the Nature of Design Creativity. *Proceedings of ICED’09: International Conference on Engineering Design*, on CD-ROM

Yoshikawa H, (1981) General Design Theory and a CAD System. In Sata and Warman (eds.), Man-Machine Communication in CAD/CAM, Proceedings of the IFIP WG5.2-5.3 Working Conference 1980 (Tokyo): 35-57

Zhou F, Nagai Y, Taura T, (2009) A concept network method based on analysis of impressions formation: Color schemes of uniforms from impressions of seasons. Proceeding of International Association of Societies of Design Research IASDR'09, on CD-ROM

Future Directions for Design Creativity Research

John S. Gero

Krasnow Institute for Advanced Study, USA

Abstract. This paper commences with a brief overview of where the creativity may lie in the enterprise of designing artifacts. It puts forward the concept that design creativity is not a unitary concept and needs to be treated multi-dimensionally by stating that design creativity may be in multiple locations. The paper then proceeds to present a brief overview of what has been researched and how it is has been researched. It classifies what has been researched under: design processes, cognitive behavior and interactions. This is followed by the articulation of future directions for design creativity research in the areas of: design processes; cognitive behavior; social interaction; cognitive neuroscience; measuring design creativity and test suites of design tasks.

Keywords: creative design, users, social interaction, design processes, design computing, design cognition, future directions, cognitive neuroscience.

1 Introduction

Creativity is highly valued in Western society. Creative products and processes are thought to be the basis of transformations in economic value and of human values. Schumpeter introduced the term “creative destruction” to capture the concept of how creativity has the capacity to produce bifurcational changes while at the same time dramatically changing the value of what went before. Design creativity research focuses on developing an understanding of the creativity of designs as a precursor to improving the generation of designs that are deemed to be creative.

This position paper commences with a brief overview of where creativity may lie in the overall enterprise of designing. It proposes seven potential loci. This is followed by a brief overview of what has been studied by researchers in terms of design creativity. The methods used to study design creativity are listed. This leads to the final part that outlines a number of future directions for design creativity research and posits a set of research questions for each of the directions.

2 Where Can Design Creativity Be?

Where can the creativity be? Although this is an obvious question it is surprisingly difficult to answer. There are seven hypotheses that are candidate answers to this question:

- in the design;
- in the assessor of the design;
- in the design process that produced the design;
- in the designer;
- in the interaction between the user and the design;
- in the society in which the design sits; and
- in the interaction amongst all of the above.

Given that there are multiple hypotheses about where the creativity might be implies that design creativity is not a unitary concept and needs to be treated multi-dimensionally (Amabile, 1983; Amabile, 1996; Boden, 1994; Boden, 2004; Coyne et al., 1987; Csikszentmihalyi, 1997; Dacey et al., 1998; Dasgupta, 1994; Feldman et al., 1994; Gero and Maher, 1993; Gloor, 2006; Heilman, 2005; Hofstadter, 1995; Kaufman and Sternberg, 2010; Partridge and Rowe, 1994; Runco, 2006; Runco and Albert, 1990; Runco and Pritzker, 1999; Sawyer, 2006; Shirky, 2010; Simonton, 1984; Sternberg, 1999; Weisberg, 1993).

2.1 Creativity is in the Design

The design itself would appear to be the most obvious place to locate design creativity. It is common to hear the phrase “that design is creative”. A design can be assessed for its creativity against a set of criteria. Typically such assessment criteria include novelty, utility and surprise. This could lead to the conclusion that the creativity lies in the artifact. However, since the utterer is making the claim this supplies insufficient evidence to support the concept that all the creativity lies in the design as it involves an assessor separate from the design. Since all cases of the assessment of creativity involve assessors it is may not

possible to test whether the creativity lies in the design as some or all may lie with the assessor.

2.2 Creativity is in the Assessor of the Design

If creativity does not simply lie in the design itself it may be that creativity is an interpretation of a design by the assessor. The assessor may be a consumer of the design or a professional commentator and generally does not specify the criteria they use in their assessment. This turns creativity from an inherent property of the design to a property of the assessor of the design. The consequence of this is that different assessors would assess the creativity of a design differently. There is evidence for this assertion.

2.3 Creativity is in the Design Process that Produced the Design

Since designing is a process it can be suggested that there is some special process or processes – “creative processes” – that result in creative designs. This is a commonly held view. It has the attraction that it can be readily studied. Typical creative processes are: combination, analogy, induction, mutation, and first principles. The resulting designs still need to be assessed but are considered more likely to be assessed as creative.

2.4 Creativity is in the Designer

Many designers are recognized as being regularly and consistently able to produce creative designs. It may be that it is the unique characteristics of those designers that make them consistently creative. That some designers are consistently creative is recognized socially when their names are used to promote the design itself.

2.5 Creativity is in the Interaction between the User and the Design

It may be that creativity is an affordance (in the Gibsonian sense) between the user and the design and as a consequence is the result of an interaction between the user and the design. This means that the creativity is in neither the design nor the user but is a consequence of the interaction of the user with the design. That interaction could take many forms. It could be a derivation by the user of the behavior of the design. It could be an ascription by the user to the design. It could be a mixture of both of these.

2.6 Creativity is in the Society in which the Design Exists

It may that creativity is a construction that is an outcome of social interactions between members of a society. For example a person need not own and use a product in order to comment on it. As a consequence it comes primarily from the society based on some interaction with the design.

2.7 Creativity is in the Interaction between the Design, the Users/Assessors and Society

It may that creativity lies in the interactions between users, assessors and the design within a society. The consequence of this is that creativity becomes a situated, constructive act. Situated means that the social interactions of individuals depend on their view of the world at that time and this guides their interactions. Constructive means that any assessment is not simply a recall of past assessments but is generated based on the past and the current situation to meet expectations that come from the situation.

This last notion of design creativity subsumes the notions of the creativity being in the assessor, creativity being in the designer, creativity being in the interaction between the user and the design and creativity being in the society within which the design exists. What it does not cover directly is the notion that creativity is in the process.

3 What Has Been Researched

All seven of these hypotheses for the location of creativity in design creativity have been studied at various levels of intensity and detail (Bonnardel, 2000; Christiaans, 1992; Dorst and Cross, 2001; Gero, 1996; Gero, 2000; Gero and Maher, 1993; Liu, 2000; Saunders and Gero, 2002; Sosa and Gero, 2005; Sosa et al., 2009; Suwa et al., 2000; Tang and Gero, 2002). However, in terms of scientific studies the primary focus has been on the following, although the other loci has been investigated often using a humanities paradigm:

- design processes;
- cognitive behavior; and
- interactions.

3.1 Studying Design Processes

The study of creative design processes has been a major research area in design science. It has taken four paths depending on the source of the idea being modeled:

- models simulating conjectures based on perceived human creative design processes;
- models simulating results from empirical studies of human creative design processes;
- models simulating conjectures based on purely abstract constructs; and
- models of human creative design processes based on empirical results.

3.1.1 Models simulating conjectures based on perceived human creative design processes

There is considerable anecdotal evidence that designers use a variety of defined processes as they produce designs that are deemed in some way to be creative. This anecdotal evidence is not necessarily founded on empirical results. The conjecture is based on an agreed perception of human behavior. The model aims to use processes that bear some relation to those that might be used by a human designer within a highly limited situation. For example, it is not known how designers combine design concepts to form a new design concept that is not simply a union of the two initial concepts. However, a number of processes have been postulated and implemented to study this conjecture.

3.1.2 Models simulating results from empirical studies of human creative design processes

Here the focus is on producing results of the kind that humans have been shown to produce. An example area is visual emergence, where the aim is to be able to produce the same visual emergence that humans are capable of producing within a specified domain.

3.1.3 Models simulating conjectures based on purely computational constructs

Here the focus is on processes drawn from computational constructs that bear no relation to human cognition or behavior. Examples of computational constructs that are not modeled on human behavior include evolutionary systems and simulated annealing.

3.1.4 Models of human creative design processes based on empirical studies

Here the focus is on modeling human cognitive behavior. The most well developed example is that of analogy, which is considered one of the basic human creative processes.

3.2 Studying Cognitive Behavior

Studies of human cognitive behavior have been directed at trying to understand what are the

parameters that play a role in producing or impeding creative behavior. There have been studies on analogy, combination of ideas and incubation as well as on fixation, amongst others. These have built on studies of cognitive characteristics and cognitive styles of the designers.

The results of such cognitive studies have not yet produced results that allow an unequivocal connection to be made between unique parameters and creativity, although there is increasing empirical evidence for the roles that some specific parameters do play.

3.3 Studying interactions

Interactions between designers and their tools and the interactions between designers as they collaborate are two streams of interaction research.

Studies of the interactions between designers and their tools focus on the change in cognition when using a tool, the change in behavior and the change in the results produced. Most of the studies have been at a foundational level rather than focusing specifically on design creativity.

Few studies of designers collaborating have focused on creativity although team behavior has been studied from a creativity viewpoint, where the team members were not designers in the traditional sense.

4 How Design Creativity Has Been Researched

Three methodological approaches have been used to research design creativity:

- computational modeling
- input-output experiments with human designers
- protocol studies of human designers

4.1 Computational Modeling

Computational modeling is the basis of the field labeled design computing. Computational modeling provides the opportunity both to test specific ideas and, more generally, to build a laboratory within which to test a range of ideas.

4.1.1 Computational modeling of creative design processes

This has been the most fruitful area of design creativity research. Computational models of conjectured human creative processes have provided researchers with insight into how such processes might be utilized to produce designs, although always in a

highly circumscribed environment. Computational models of results from empirical studies of human creative design processes are much fewer largely because there are very few such studies. Computational models of processes based on computational constructs only have a widespread currency. Computational models of human creative design processes based on empirical studies have proven to be very successful where the results of such studies have been robust.

4.1.2 Computational laboratories for creative design research

This is a relatively new modeling area that is the outgrowth of the use of multiple, social agents, where agents are computational constructs with a degree of autonomy. Agents can be used to model players in a system. Their interactions produce system-level behaviors both intentional and extensional. Such a system can act as a laboratory for the investigation of the effect of parameters and their variations without directly programming the output behaviors.

4.2 Cognitive Modeling

4.2.1 Input-output experiments with human designers

Input-output experiments take the designer as a black box and examine the effects they produce in the output when the input is changed. An example of such an approach is the studies on design fixation, where fixation inhibits creativity.

4.2.2 Protocol studies of human designers

Protocol studies in design cognition involve having designers verbalize as they design and converting their verbalization into semantic symbols. These symbols can then be analyzed in multiple ways to inform the cognition of creative designing. Protocol studies have proven to be a popular research method in the study of the cognition of human designers.

5 Future Directions for Design Creativity Research

Designing is not a unitary act. It involves multiple fields of knowledge and multiple classes of processes and is practiced in multiple disciplines in what may appear to be in different ways. As a consequence it is difficult to have a widely accepted agreement on its definition. Similarly, creativity is not a unitary concept and this may explain the difficulty in producing a universally agreed definition of it. However, it is

claimed that contributing to the notion of design creativity are the issues of:

- design processes;
- cognitive behavior;
- social interaction;
- cognitive neuroscience;
- measuring design creativity; and
- test suites of design tasks.

Although the first three of these classes of issues, have already been the focus of previous study, they provide the basis for future directions for design creativity research. The fourth is a novel dimension.

5.1 Design Processes

Design processes continues to be a fruitful research direction for design creativity. Sources for design processes will include empirical results from studying humans and nature. Future research questions for design processes for design creativity include:

- what are the human creative design processes?
- can design by analogy be made more generally useful?
- what can be generalized from design by analogy with nature – biomimetic design?
- what are collaborative creative design processes?
- what are team creative design processes?
- what are collective design processes?
- what are the differences between a user designing and a designer designing?

5.1.1 Human creative design processes

The current knowledge of human creative design processes is limited. Determining the set of these processes still remains a research question. How designers use these processes is not well understood. Future research questions related to creative design processes include:

- what is the set of processes used during creative designing?
- are there unique configurations of processes that contribute to creative designing?
- what is the effect of teaching these processes on performance and outcomes?
- what is the effect of experience of using these processes on performance and outcomes?

5.1.2 Design by analogy

Analogy is well-developed process utilized in creative designing. Current approaches to design by analogy make use of concepts from structure mapping, which

assumes that the representation of the source and target are congruent and hence the matching process is directly applicable. Future research questions in design by analogy include:

- how can representations of potential sources be constructed to match the target's representation?
- can the representation of the target be constructed to match that of the potential source?
- does context change the process used for locating potential sources?
- what is the effect of context on matching in potential sources?
- does experience change the process used for locating potential sources?

5.1.3 Biomimetic design

Biomimetic design is a specialization of design by analogy where the sources come from natural biology. Future research questions in biomimetic design include:

- can the biological processes that produce desired behaviors be generalized?
- can different biological processes that produce the same behavior be identified?
- can a set of biological processes be accessed through intended behaviors?
- is there a base set of biological processes involved in the production of most of the behaviors?

5.1.4 Collaborative design processes

Collaborative design occurs when two or more designers work on producing a design through their interactions. The designers do not make a team, where a team involves the development of a continuing common ground of understanding the behaviors of others members of the team. Collaborative design occurs when two or more designers, who have not worked together previously and there is no expectation that they will work together again, are brought together for the production of a single design over a relatively short period. Future research questions for collaborative design processes for design creativity include:

- what are the effects of synchronous compared to asynchronous collaboration?
- what are the effects of co-location compared to remote location?
- what are the effects of the use of tools?
- what are the effects of asymmetry in the decision-making roles of the collaborators?

5.1.5 Team design processes

Teams are groups of designers who are formally constituted and who develop a continuing common ground with each other. Future research questions for team design processes for design creativity include:

- how do team mental models develop?
- what are the process and outcome effects of changing team membership?
- what are the process and outcome effects of structured versus unstructured teams?
- how does team expertise develop?
- what are the process and outcome effects of having team members work as members of other teams asynchronously with the current team?

5.1.6 Collective design processes

Collective design distinguishes itself from both collaborative design and team design in that the designers who form a collective primarily interact with each other through the emerging design. Such designers do not need to know each and therefore they are only judged by their performance not by their demography. Future research questions for collective design processes for design creativity include:

- what motivates people to join collective design?
- how do collective designers partition design tasks?
- how do collective designers reach a consensus?

5.1.7 User design processes

Many product suppliers offer the opportunity to the user to design or customize some aspects of their product. Future research questions for user design processes for design creativity include:

- do users customize differently to designers?
- do users customize "better" designs than designers?
- does user customization improve user satisfaction?

5.2 Cognitive Behavior

Current studies of the cognitive behavior of creative designing have produced results that have not been sufficiently robust (in the sense of controlled experiments), not generalizable (since many were case studies), have been too narrow in scope, and not transferable (since different dimensions were used to collect and analyze the results) to generate adequate conclusions. Future research into the cognitive

behavior of design creativity must first address the following procedural issues.

5.2.1 Robustness

Robustness implies improved experimental design through better use of controls and reductions of confounding variables. Many published results from the design cognition literature are not reproducible because of a lack of attention to these issues.

5.2.2 Statistical reliability

Statistical reliability implies the need to move from individual case studies to populations of subjects, the reasons for case studies have included the cost of carrying out reliable studies so better tools are required to reduce these costs.

5.2.3 Scope

The scope of many studies has been limited to single designers. These are case studies from which general conclusions cannot be drawn. Studies of single designers do not allow for either lateral or longitudinal studies, which limits the applicability of any results.

5.2.4 Generalizability

Generalizability implies one or more generally used coding schemes when using protocol studies and a set of commonly used measurements to allow for comparisons across studies. A lack of such commonly used approaches has limited the utility of any results produced.

5.2.5 Future research questions in cognitive behavior

Once the above issues have been addressed cognitive behavior of the creative design can be explored more fully. Future research questions in cognitive behavior of design creativity include:

- are there unique cognitive processes that contribute to design creativity?
- are there unique combinations of ordinary processes that contribute to design creativity?
- what is the effect of tool use on the cognitive behavior involved in design creativity?
- what is the effect of interactions with other designers on the cognitive behavior involved in design creativity?
- what is the effect of interactions with the evolving design on the cognitive behavior involved in design creativity?
- what is the effect of interactions with the users of the design on the cognitive behavior involved in design creativity?
- what is the effect of education on the cognitive behavior involved in design creativity?

- what is the effect of experience on the cognitive behavior involved in design creativity?
- what are the cognitive behavior differences between a single designer and a designer working within a team?
- what are the cognitive behavior differences between having incubation breaks and continuous design sessions?
- how can the cognition of collective design be measured?
- what is the empirical support for the situated cognition view of creative design?

5.3 Social Interaction

Creative designing is the consequence of a variety of social interactions, where social interactions means that the interaction that occurs is not programmed and has the capacity to change value systems of the interactees. Interactions of interest include: social interactions between designers; social interactions between designers and consumers; social interactions between designers and the society in which they sit. Future research questions in studying the social interactions in design creativity include:

- what are metrics for social interactions?
- what value changes occur as a result of social interactions?
- what is the cognition of social interaction?
- what is the effect of differing channels of social interaction on design creativity?

5.4 Cognitive Neuroscience

Cognitive neuroscience is that part of brain science that studies the brain while it is carrying out cognitive acts and attempts to correlate brain behavior with that cognition. The cognitive neuroscience of design creativity is an open research field and is the fourth future direction for design creativity research. Future research questions in studying the cognitive neuroscience of design creativity include:

- are there unique structures involved in design creativity?
- assuming there are unique structures involved in design creativity, are they the same in different design disciplines?
- assuming there are unique structures involved in design creativity do they change with education?

- assuming there are unique structures involved in design creativity do they change with experience?
- assuming there are unique structures involved in design creativity are they different in novices and experts?
- are there unique neural pathways involved in design creativity?
- assuming there are unique neural pathways involved in design creativity, are they different in different disciplines?
- assuming there are unique neural pathways involved in design creativity, do they change with education?
- assuming there are unique neural pathways involved in design creativity, do they change with experience?
- assuming there are unique neural pathways involved in design creativity, are they different in novices and experts?
- if there are no unique structures nor unique pathways associated with design creativity, are there significant differences in either structure or neural pathways to ordinary design?
- if there are no unique structures nor unique pathways associated with design creativity, are there significant differences in either structure or neural pathways between novices and experts?
- if there are no unique structures nor unique pathways associated with design creativity, are there significant differences in either structure or neural pathways as education proceeds?
- if there are no unique structures nor unique pathways associated with design creativity, are there significant differences in either structure or neural pathways between designers in different disciplines?

5.5 Measuring Design Creativity

There are inadequate measures of design creativity. Since the claim is made that design creativity is a multidimensional set of concepts it is appropriate to consider the measurement of design creativity from a multidimensional view. The most common measures relate to the product and are often qualitative measures of novelty, utility and sometimes surprise. Future research on measuring the creativity of designs needs to quantify these measures in a coherent manner.

Design creativity changes the values of the users and even observers. There is insufficient research on this aspect of creativity. Future research questions in measuring design creativity include:

- what are design creativity measurement metrics for designed artifacts?
- what are design creativity measurement metrics for design processes?
- what are design creativity measurement metrics for users?
- what are design creativity measurement metrics for societal creativity?

5.6 Test Suites of Design Tasks

Studying designing is different to studying many other human activities because when each designer is given the same set of design requirements the results of each designer is and is expected to be different. A different paradigmatic view is required if comparisons of designing are to be made. It is common to have a suite of problems to which a solution method can be applied and a set of metrics that are used to measure the performance of the method. Typical metrics include: how close to the correct solution the method reaches, how long it takes and how much resources are consumed in reaching its solution. In designing there is no correct solution. The time taken to complete a design is largely a function of the resources available rather than a characteristic of the requirements. Similarly the resources expended are largely a function of the resources available rather than a characteristic of the requirements of even of the design produced.

However, it is still appropriate to have test suites of design tasks but to utilize different measurement metrics to measure design creativity of the process, the product and the changes produced in the user, the designer and in society generally. Future research questions in determining test suites of design tasks for design creativity include:

- what are appropriate metrics for design tasks?
- what is an appropriate ontology of design tasks?
- what makes for appropriate design tasks at the function level?
- what makes for appropriate design tasks at the behavior level?
- what makes for appropriate design tasks at the structure level?

6 Conclusions

Design creativity remains a relatively under-researched area, as a consequence there are numerous research questions to be raised and answered to develop an understanding of design creativity. The results of this research will lead not only to an

understanding of design creativity but will provide the foundations for the development of tools to support design creativity and potentially to augment it.

Designing is one of the value adding activities in a society. It has the potential to improve the economic condition as well as the human condition and make lives better. Research into design creativity is a lever that magnifies design. Research into the following areas will produce benefits:

- design processes;
- cognitive behavior;
- social interaction;
- cognitive neuroscience;
- measuring design creativity; and
- test suites of design tasks.

There continues to be a lack of qualified researchers in this field. The field needs to attract more researchers and they need to come from disparate fields to progress.

Acknowledgements

The ideas in this paper are founded on research funded by the Australian Research Council grant no: DP0559885; DARPA grant no: BAA07-21; and US National Science Foundation grant nos: SBE-0750853; CNS-0745390; IIS-1002079; and SBE-0915482.

References

- Amabile T, (1983) *The Social Psychology of Creativity*. Springer-Verlag
- Amabile T, (1996) *Creativity in Context*. Westview Press
- Boden MA, (1994) *Dimensions of Creativity*. MIT Press
- Boden MA, (2003) *The Creative Mind: Myths and Mechanisms*. Routledge
- Bonnardel N, (2000) Towards understanding and supporting creativity in design: analogies in a constrained cognitive environment. *Knowledge-Based Systems* 13(7-8):505-13
- Christiaans H, (1992) *Creativity in Design, the Role of Domain Knowledge in Designing*. Lemma BV
- Coyne RD, Rosenman MA, Radford AD, Gero JS, (1987) Innovation and creativity in knowledge-based CAD. In Gero JS, (ed.), *Expert Systems in Computer-Aided Design*, North-Holland, 435-465
- Csikszentmihalyi M, (1997) *Creativity, Flow and the Psychology of Discovery and Invention*. HarperCollins
- Dacey JS, Lennon K, Fiore LB, (1998) *Understanding Creativity: the Interplay of Biological, Psychological, and Social Factors*. Jossey-Bass
- Dasgupta S, (1994) *Creativity in Invention and Design: Computational and Cognitive Explorations of Technological Originality*. Cambridge University Press
- Dorst K, Cross N, (2001) Creativity in the design process: co-evolution of problem-solution. *Design Studies* 22(5): 425-437
- Feldman DH, Csikszentmihalyi M, Gardner H, (1994) *Changing the World: A Framework for the Study of Creativity*. Praeger
- Gero JS, (1996) Creativity, emergence and evolution in design. *Knowledge-Based Systems* 9(7):435-448
- Gero JS, (2000) Computational models of innovative and creative design processes. *Technological Forecasting and Social Change* 64(2-3):183-196
- Gero JS, Kannengiesser U, (2009) Understanding innovation as a change of value systems, in Tan R, Gao G, Leon N (eds), *Growth and Development of Computer-Aided Innovation*, Springer, 249-257
- Gero JS, Maher ML, (eds.), (1993) *Modeling Creativity and Knowledge-based Creative Design*. Lawrence Erlbaum Associates
- Gloor P, (2006) *Swarm Creativity*. Oxford University Press
- Heilman K, (2005) *Creativity and the Brain*. Psychology Press
- Hofstadter DR, (1995) *Fluid Concepts and Creative Analogies: Computer Models of the Fundamental Mechanisms of Thought*. Basic Books
- Kaufman J, Sternberg R, (2010) *The Cambridge Handbook of Creativity*. Cambridge University Press
- Liu Y-T, (2000) Creativity or novelty? Cognitive-computational versus social-cultural. *Design Studies* 21(3):261-276
- Partridge D, Rowe J, (1994) *Computers and Creativity*. Intellect
- Runco MA, (2006) *Creativity: Theories and Themes*. Academic Press
- Runco MA, Albert RS, (1990) *Theories of Creativity*. Sage Publications: Newbury Park
- Runco MA, Pritzker S, (1999) *Encyclopedia of Creativity*. Academic Press
- Saunders R, Gero JS, (2002) How to study artificial creativity. in T Hewett and T Kavanagh (eds), *Creativity and Cognition 2002*, ACM Press, 80-87
- Sawyer K, (2006) *Explaining Creativity: The Science of Human Innovation*. Oxford University Press
- Shirky C, (2010) *Cognitive Surplus: Creativity and Gnerosity in a Connected Age*. Penguin
- Simonton DK, (1984) *Genius, Creativity, and Leadership: Historiometric Inquiries*. Harvard University Press
- Sosa R, Gero JS, (2005) A computational study of creativity in design. *AIEDAM* 19(4):229-244
- Sosa R, Gero JS, Jennings K, (2009) Growing and destroying the worth of ideas. *C&C'09 Proceedings of Conference on Creativity and Cognition*, ACM, 295-304
- Sternberg RJ, (1999) *Handbook of Creativity*. Cambridge University Press
- Suwa M, Gero JS, Purcell T, (2000) Unexpected discoveries and s-inventions of design requirements: Important vehicles for a design process. *Design Studies* 21(6):539-567
- Tang H-H, Gero JS, (2002) A cognitive method to measure potential creativity in designing. in Bento C, Cardoso A, Wiggins G, (eds) *Workshop 17 - Creative Systems: Approaches to Creativity in AI and Cognitive Science*, ECAI-02, Lyon, 47-54
- Weisberg RW, (1993) *Creativity: Beyond the Myth of Genius*. WH Freeman

Systematic Procedures Supporting Creativity - A Contradiction?

Udo Lindemann
Technical University Munich, Germany

Abstract. Creativity is often addressed within fine arts, schools, industry, society, politics etc., but there is no unique kind of creativity required. For example, a child may use its creativity on one side for a nice painting or on the other side for the disassembly of a kitchen device. In industry creativity has to be more focused on given problems and obstacles. There is a discussion about creativity of individuals, teams or organizations. In the end, individuals including their subjective pictures of the situation are forming creativity. Flexibility as well as structured procedures will help engineering designers to find the right balance based on the given situation and capabilities. A few examples from daily business in industry underline some of these aspects.

Keywords: creativity, systematic procedures, focused creativity, goal orientation, influences on creativity

1 Introduction

This is a discussion paper based on a number of observations in private situations, in industry as well as in university. In addition, several research projects and a wide range of literature are influencing this paper, too.

A number of models describing mechanisms of creativity or procedures of supporting creativity have been published. There is a large number of creativity supporting methods described in literature as well. In daily industrial practice the situation is different, “brainstorming” seems to be one of the favorite methods, although researchers in psychology as well as a number of consultants claim that brainstorming (at least as it usually is performed) is one of the weakest creativity supporting methods at all.

Even as children we were creative without any knowledge of methods. Based on our genes, the education, experience and so forth, the capabilities have changed. Individuals are forming creative behavior, processes and results. Their progress will be based on a lot of influences and their guideline will be their subjective picture of the situation and the goals.

There are fields of creativity where we expect it, like in fine arts, architecture, music etc. A composer has to be creative in a specific way, which is different from the kind of creativity we expect from conduc-

tors. And there are other fields of creativity. Officers in the Department of Finances together with politicians often are creative in finding new ways for additional taxes. Military staff has to be creative in attacking their enemies. And last but not least engineers have to be creative to find efficient ways of solving their problems. Not in all cases the results are accepted or even acceptable by others. On the shadow sides of life, too, we may observe creativity like in cheating, terrorism etc. All that means that creativity is ambivalent.

Creativity is often discussed as one of the most important fundamental of our economic and individual well-being. If we look at some of today’s global key questions like energy, water, food, mobility, environment, crime, war, and terrorism and if we want to improve the situation in total we are confronted with extremely high complexity, as there are a lot of interdependencies we have to be aware of. If we look at a problem like cost reduction of an electric motor, we have to look at the availability and price development of material, labor cost, improvement of tools etc. Again, we have to be aware of the complexity of this system.

Developing target oriented creativity in the right direction is based on sufficient understanding of the situation, the problem to be solved and the resulting target itself.

2 Modeling Creativity

Models of creativity have been published by different authors. One example is shown in figure 1, which is based on a specific understanding of our individual memory and thinking processes. There is an observation and based on that a goal to be accomplished. Then we have to work on immersion, which is followed by some unconscious process of incubation and suddenly there is an illumination. Sometimes this model explains creative processes.

In other cases we have to bridge barriers, which gives us a different kind of a model (shown later in figure 8).

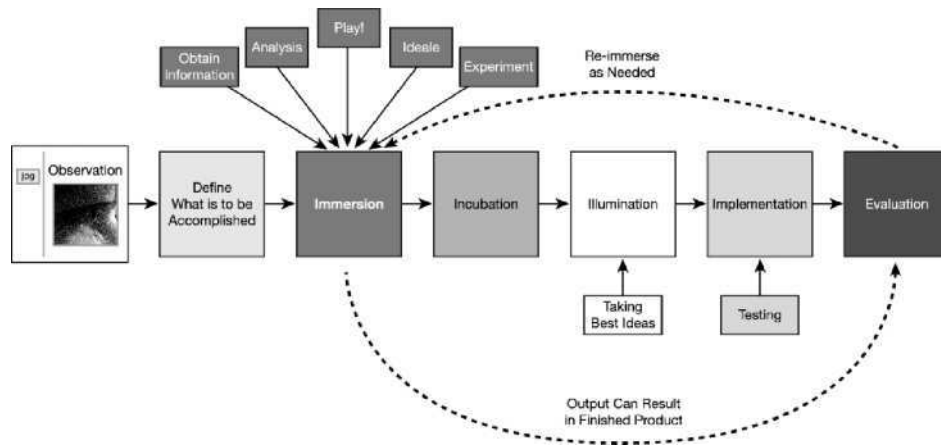

Fig. 1. Idea generating procedure (Plishka, 2009)

Chakrabarti (Chakrabarti, 2006) published a model regarding important influences (figure 2). The key influences of this model address flexibility, knowledge and motivation and in addition, there are some situational influences.

The author of this paper collected a number of possible influences documented in a simple tree structure (figure 3). This listing is not complete, it just shows the large amount of influences that may be of importance.

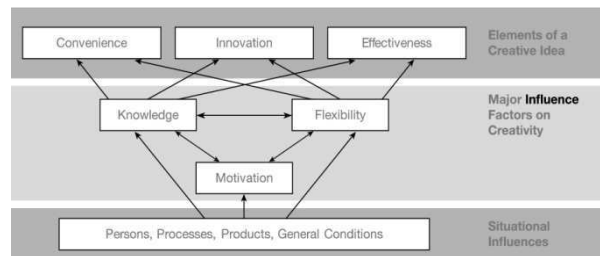

Fig. 2. Major influence factors on creativity (Chakrabarti, 2006)

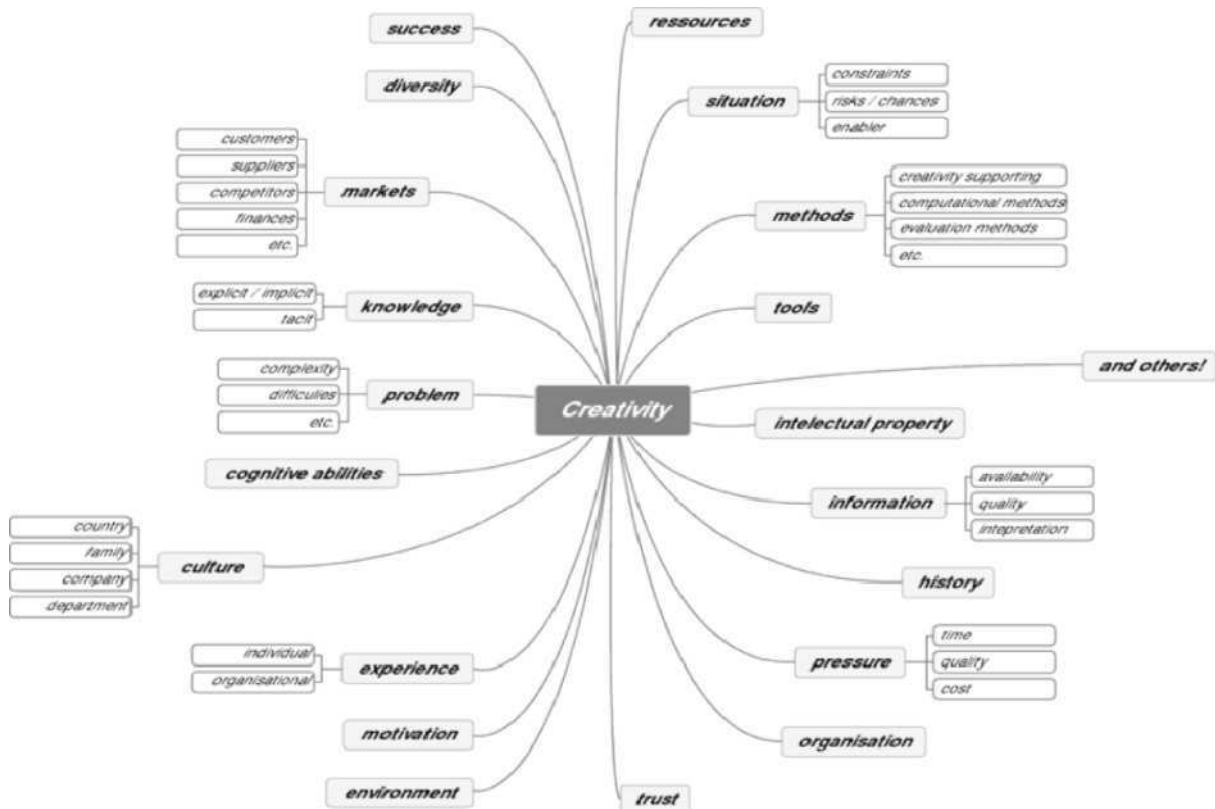

Fig. 3. Influence factors on creativity

Additionally, there are interdependencies between at least some of these influences, which are not shown in figure 3. Overall, we may recognize that creativity is a complex topic.

Having all these models it may be confusing at least for practitioners, as we quite often find these models documented without stating the purpose of it.

Models may be the basis for teaching and learning, but models also may be of importance in research to understand at least some aspects of the unknown or intransparent complex world.

3 Improve Creative Processes

How to foster creativity under industrial boundary conditions in the right direction? This is one of the key questions in industry when the aspect of innovation is addressed. The discussion of four industry related examples in engineering design will present a basic idea of supporting creative processes by means of systematic approaches.

3.1 New Solutions for Elastic Couplings

The first example is positioned in the market of elastic couplings. The field is well established, a large number of solutions is available and well documented. One question is whether there may be some other solution principles with interesting features? How to find them?

The proposed method is the multi-dimensional ordering scheme, the coupling example is shown in Figure 4. There are input and output, transmitting elements and the arrangement describing the known solutions.

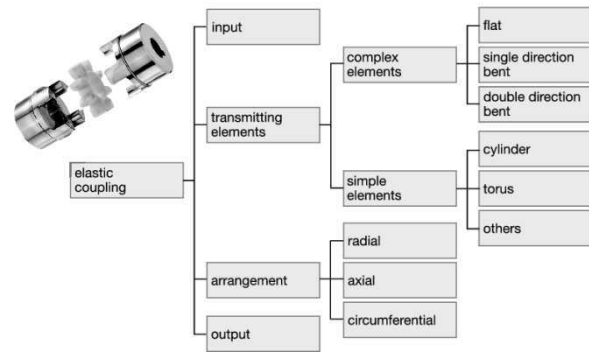

Fig. 4. Coupling (example¹⁾) and the structure of possible ordering criteria

Based on that, all solutions available on the market or documented in patents can be generated by selection of solution elements within this scheme. Interesting aspects are the missing solution elements (“white spots”) like those in the lower part of figure 5 or the identification of further ordering criteria and new configurations. Picture 6 shows some ideas for solutions regarding the “white spots” within the scheme.

Eingang	Übertragungselemente								Anordnung				Ausgang	
	komplizierte Körper sonstige		vom Torus	vom Zyl.	Zahl der Ringe	einfache Körper		einfach gekrümmt		radial	axial	am Umfang		
						doppelt gekrümmt								
					1									
					2									
					3									
					4									
					5									
					6									
					7									
					8									
					9									
					10									

Fig. 5. Ordering scheme

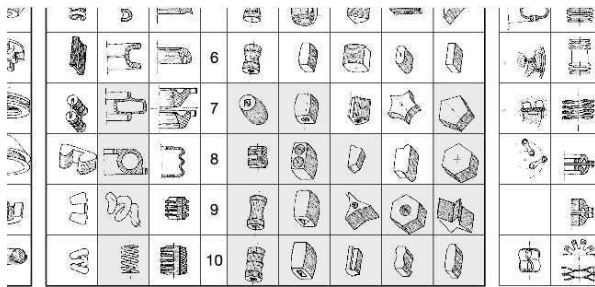

Fig. 6. Additional solution elements

The conclusion out of this example: Creativity has been directed to think about filling up “white spots”. In front of the overwhelming number of different known solution of complete couplings it will be nearly impossible to come up with new ideas. The whole problem was cut into small pieces of pure geometric variation. As a follow up task the configuration of new concepts including the evaluation has to be undertaken.

3.2 Development of a High Pressure Pump

The second example is addressing the difficulty of developing a high pressure pump for a large variety of customers and applications, and the target to limit the number of variants. This pump is produced cost sensitive in high volume series production.

In this situation, the management decided that the knowledge of the dependencies within the product would help to get a better understanding. The direct dependencies between parts have been collected with the help of BOM and workshops, to get data with high quality. Figure 7 (left side) shows the representation of this data by strength based graphs. The elements are shown as boxes and the dependencies as arrows. A large number of parts are highly connected, others are linked to the system only by one interdependency in one or both directions. The latter are candidates for

standardization. Within the next step these elements are removed from the graph representation and the result is shown in figure 7 (right-hand side). Now the structure is much clearer for interpretation. There are 4 different sub-areas: elements belonging to low pressure, to high pressure, to the flange (within blue circles) and the remaining building the “bridge” between the others.

The identification of the “bridge” elements led to the definition of some kind of a platform and three modules (high pressure, low pressure and flange).

The conclusion out of this example: Generating a better and transparent understanding of the structure helped to overcome the mental limitations based on experience and to define a more robust product structure. Cost pressure helped to use this structural analysis to get a much better understanding of the product and of consequences resulting from decisions made in product development. In addition, some of the implicit knowledge of experienced staff became explicit, which was to the benefit of other team members. Creativity was focused on much clearer targets than before.

3.3 Improve Vacuum Cleaner Sucking Device

Example three is dealing with the question of generating of an innovative solution for a known and optimized product like a vacuum cleaner sucking device. This is a task with high risk and it may be time consuming.

In this case, the decision was to try out the biomimetics path to overcome the barriers mainly build by experience. In addition, this device has not been within the focus of engineering designers at least in most of the companies. Figure 8 shows the model of getting around a barrier within our mind by transferring the problem to another level or area. Some of the work is indicated: sucking in nature led to the fly and its trunk with some interesting detail geometry.

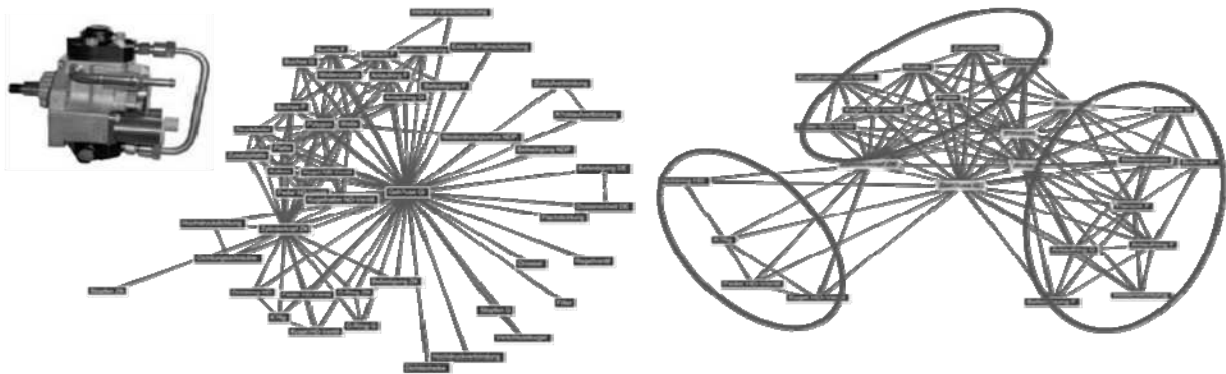

Fig. 7. Structure analysis of a High Pressure Pump (Lindemann, 2009)

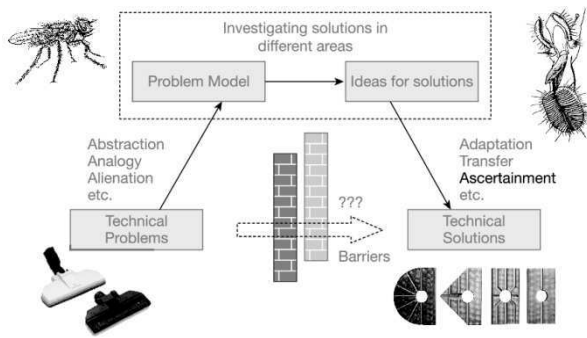

Fig. 8. Biomimetics as workaround (Gramann, 2004)

Coming back to the technical solution some orienting tests are indicated. Among other ideal suppliers in nature the tongue of cochlea was of interest.

Based on the findings a first demonstrator (figure 9, left side) has been built and tested. During the first cleaning path there was an improvement of more than 20% compared to an industry standard solution. Further development steps (example in figure 9, right-hand side) have been taken including the creation of new test standards focusing energy efficiency.

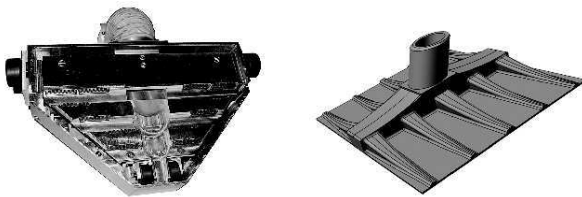

Fig. 9. First demonstrator and an example for further development (Gramann, 2004, Stricker, 2006)

The conclusion out of this example: Overcoming the mental barriers caused by our experience and the modification of boundary conditions (testing standards) were the most important drivers in this process. In addition, it was helpful that some team

members were able to understand biological phenomena at least up to a certain extent. An important condition was the culture within the company regarding new and innovative ideas.

3.4 Improve the Properties of a Device in Late Development Phases

The development of a complex product (safety systems of passenger cars) comes near to its end, when engineers recognize that they have to improve one of the properties of a specific sub-system, which may be called “A”. Most of the sub-systems of the whole product have already been proven either by simulation or by physical tests. Now there are two possibilities under discussion: the sub-system “A” itself or some of the other sub-system influencing “A” may be changed. Pressure regarding time, quality and cost is extremely high.

Usually, engineers started to change the system based on their experience or test results. Usually they managed to solve the specific problem, maybe after some iterations. Caused by these changes, additional problems regarding functions or properties arose, which were quite often detected later and independently of the above described changes.

The key question is, where to change and modify the system with limited efforts and risks? Figure 10 shows an extract of the whole system with elements (subsystems) and dependencies. The left part shows the complete dependency-set of sub-system “A” at the bottom with all dependencies to other sub-systems. This helps to check the impact of changes in “A” within the whole system. The coloring indicates the passive sum of an influence matrix and supports the planning of the procedure of influence checking. The graph on the right-hand side in figure 10 shows only those elements, which have not yet been proven at this time. Based on that checking, cost, time and quality related possibilities of changing the influence of other

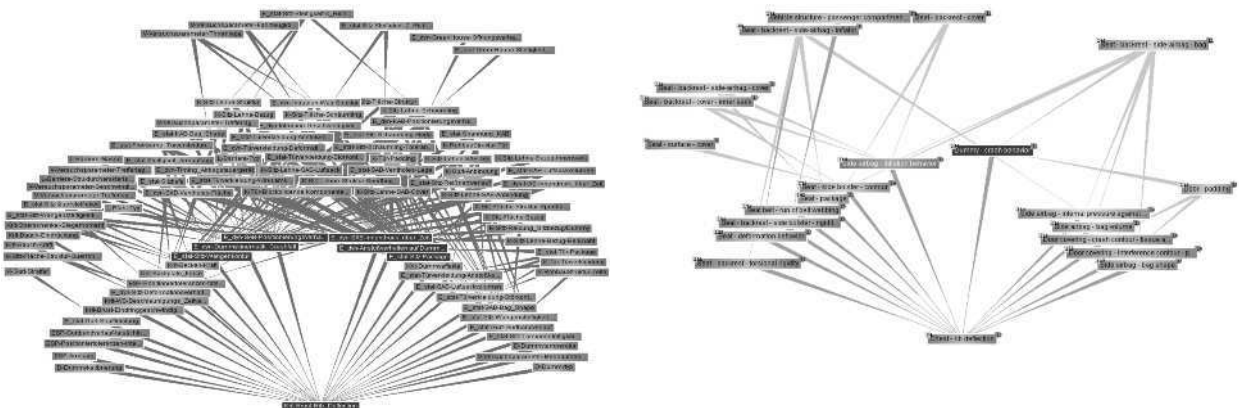

Fig. 10. Interdependencies of one sub-system (Herfeld, 2007)

sub-systems on “A” are supported.

The conclusion out of this example: Getting an understanding of the system structure helped to see possible impacts resulting from changes. Even on this abstract level a number of hints regarding potential risks have been elaborated. Creativity was oriented on less critical and less risky measures during the improvement process.

4 Discussion and Conclusion

One of the most important aspects of creativity in engineering design is dealing with problems, barriers and alternatives. Understanding the true problem and the situation is sometimes work intensive but helps to get a better and more transparent view. Dealing with barriers may be work intensive, if the steps to be taken are large, for example because of fixed mindsets.

The ability to be creative is highly related to individuals and there are a lot of influences that might hinder or foster creative processes.

Creativity is a characteristic of individuals; organizations, history, experience and a lot of boundary conditions (the situation) are influencing these characteristics. One of the key questions is to improve the capabilities to be creative in the target oriented way to achieve the requirements.

Systematic procedures have a good potential to support these creative processes in engineering design. This is also valid for many other disciplines like creating a sculpture, writing an opera or planning a new building. The required flexibility is an argument against strictly predefined procedures.

Creativity supporting methods and procedures have to be generic!

In the end, there are a number of research questions regarding the nature of creativity and additionally regarding the effects of influences including the interdependencies between different influences.

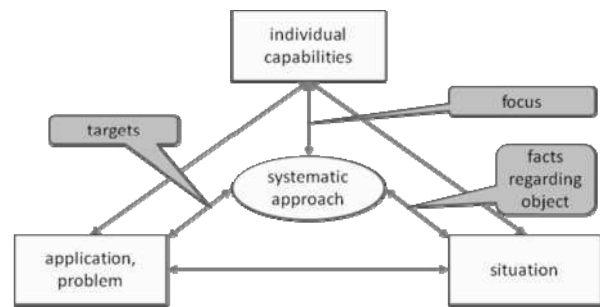

Fig. 11. Systematic approach supporting creativity

More empirical and systematic research together with experts in psychology and sociology is required. This research should start with a clear focus on individuals, seeing teams and organization as influence factors.

References

- Chakrabarti A, (2006) Defining and Supporting Design Creativity. International Design Conference - DESIGN 2006. Dubrovnik, Croatia
- Gramann J, (2004) Problemmodell und Bionik als Methode. Dr.-Hut München 2004. Dissertation at Technical University of Munich
- Herfeld U, Fürst F, Braun T, (2007) Managing Complexity in Automotive Safety Development. Proceedings DSM-Conference 2007, Shaker Aachen
- Lindemann U, Maurer M, Braun T, (2009) Structural Complexity Management – An Approach for the Field of Product Design. Springer: Berlin
- Plishka M, (2010) seen in March 2010 under <http://zenstorming.files.wordpress.com>
- Stricker H, (2006) Bionik in der Produktentwicklung unter der Berücksichtigung menschlichen Verhaltens. Dr.-Hut München 2006. Dissertation at Technical University of Munich

¹⁾ Fig. 4.: Photo of DELTA Antriebstechnik GmbH, www.delta-antriebstechnik.de

Better, Not Catchier: Design Creativity Research in the Service of Value

Gabriela Goldschmidt

Technion – Israel Institute of Technology, Israel

Abstract. This article outlines applied and basic design creativity research as practiced today and as it is seen in the future, in light of the high demand for creativity and innovation coming from business, and the changing conceptualization of creativity in our society. Design creativity is seen as indispensable but also dangerous when misinterpreted and misused and when there are no robust ethical rules to go by. It is proposed that research draw lessons from the current *Design Thinking* method, and in particular its stress on problem finding through observation of users, and continuous prototyping. Thus research is approached as a design task where the goal is to arrive at better design, that carries value for users, and not catchy design with insufficient regard for real, relevant users' needs and aspirations.

Keywords: applied research, basic research, business, design creativity, Design Thinking, ethics, observation, prototyping, users

1 Why is Design Creativity Important?

In a recent article in *Newsweek*, entitled *The creativity crisis*, Po Bronson and Ashley Merryman report a survey among a large number of CEOs, which “identified creativity as the No. 1 “leadership competency” of the future.”¹ Following up a few weeks later, Thomas Friedman wrote in the *New York Times*: “We live in an age when the most valuable asset any economy can have is the ability to be creative – to spark and imagine new ideas...”² The fact that the arguably most important weekly and daily papers in the United States associate creativity so strongly with leadership and economic value, attests to a consensus regarding the indispensability of creativity

in today’s society, in all walks of life. Success in almost any initiative requires creative thinking.

The current *Design Thinking Movement*, in good currency in business environments even quite distant from traditional design fields, focuses on innovation. Once again, the underlying tenet is that in today’s economy innovativeness is the key to competitiveness. The well known design consultancy *IDEO* is doing a lot more today than design tangible products. *IDEO* also tackles problems such as helping a bank to augment its business through a revolutionary scheme by which purchases are rounded up to the next dollar sum and the difference is put in a savings account; increasing voluntary blood donation by providing an interactive experience for donors; and consulting health authorities on youth obesity prevention.³ Design Thinking is a method for designing products, systems, services and experiences, taught today in design as well as business schools. It is based on problem finding through observation, teamwork, and continuous prototyping, with the single most important goal of innovating. Innovation, we should remember, is contingent on creativity.

Therefore, creativity is important – in a way it makes the world turn round, especially the business world. And since so many things in our world are designed, design creativity definitely merits today, more than ever, thorough studying and research.

2 Why is Design Creativity Dangerous?

We have seen why it is increasingly important to research design creativity; we now direct our attention to some caveats that should be borne in mind when asking ourselves what research should be conducted,

¹ <http://www.newsweek.com/2010/07/10/the-creativity-crisis.html>

² <http://www.nytimes.com/2010/08/04/opinion/04friedman.html>

³ Personal knowledge.

and toward which aims. We consider two factors that may lead to grim outcomes.

2.1 All That Glitters is Not Gold

The first factor is the misinterpretation of creativity wherein it stands for novelty and originality alone. We know that to be creative, a product must also be useful or functional; usefulness and functionality may be quite widely interpreted, but this component is nevertheless indispensable.

In a culture that applauds innovation this is sometimes forgotten and designers come up with designs or redesigns that boast 'new' and 'original' features which are there just for the sake of being classified as being 'novel'. Very often practicality is not seriously tested, or even properly considered. This applies to all types of designed entities, from small consumer products to large-scale buildings and towns. Time and again we encounter water kettles with uncomfortable handles and spouts that pour water everywhere but into the designated receptacle; and we enter multi-million buildings in which it is impossible to find our way, work in acceptable environmental conditions, or see the entire stage from every seat if the building is a performance hall (the acclaimed Sydney Opera House is a case in point). Society 'licenses' star designers and architects to compromise users' needs and aspirations, or at least forgives them for major transgressions in this respect, due to their perceived creativity. Moreover, individuals, companies and public agencies are willing to pay more for such products, which are conceived as being 'cool'. Stevens (1998) proposed a distinction between the profession and field of architecture; most 'regular' architects work in the client-oriented profession, whereas a few 'signature architects' see themselves, and are seen by others, as working in the field of architecture that is eminence rather than client oriented. It may be possible to argue that in some very rare occasions this approach is justified and in the long run society benefits from unusual works of design that despite many shortcomings have much to offer (including in the economic realm, as such buildings tend to become tourist attractions). In most cases, though, this should be seen as a failure.

However, a large number of designers and architects without outstanding talents see themselves as belonging to the privileged group that Stevens calls 'the favored circle'; they believe they have the right to focus on design novelty with less regard for people's needs. Differences in taste notwithstanding, many a time such buildings are also judged by many to be in poor taste, if not outrageously ugly, intimidating, wasteful, out of place, or otherwise no more than

momentarily catchy, at best. For obvious reasons we cannot give concrete examples here. As researchers of design creativity we probably cannot change this, but we can point out what misuse or even abuse of the 'creative license' is, and discourage it.

2.2 Ethics

A second type of danger in the rush for creative design is a purely ethical one. Can designers accept any commission? Obviously they do; architects design prisons and worse detention camps, and sometimes serve corrupt and cruel regimes for which they build monumental edifices. Engineers design weapons and industrial designers turn out dangerous vehicles, toys, and a host of environmentally unsustainable products. In all design fields we find under-designed or unnecessarily over-designed and consequently malfunctioning and/or overpriced gadgets of all sorts. Often these products are shipped out immaturely with their flaws just in order for a 'new model' to reach the market as early as possible. The question of ethics in design is very complex (Gorman, 1998) and this author admittedly does not know how to solve it. Maybe we should start by incorporating ethics into design education, and consider a designers' pledge like the Hippocratic Oath taken by doctors who swear to practice medicine ethically. This may be desirable regardless of design creativity and its research, but is particularly important in guiding goals and assessments in design creativity research.

3 Applied Research

Most of the work we encounter in design creativity research is applied. This is not only understandable, but also very logical, given the pressure from the marketplace to come up with tools and methods to augment creativity in design as a vehicle for economic success. Creativity, it is argued, enhances originality and novelty, and sometimes also practicality. Many methods have been proposed for idea generation in design, aimed at increasing creativity; from brainstorming and its derivatives (Isaksen et al., 1994; Osborn, 1953; Parnes, 1992), through methods developed specifically for design, mostly in engineering, like for example Gallery (vanGundy, 1988) and C-Sketch (e.g., Higgins, 1994; vanGundy, 1988); for partial overviews see for example Shah and Smith (2003) and McFadzean (1998).

As mentioned earlier, the latest method to hit the headlines is Design Thinking, which is meant to do more than support the generation of a large number of original ideas. Design Thinking denotes a method for

general use in the process of devising innovative solutions for products, spaces, services (including 'experiences') or systems. More than anything, it is a business strategy (Brown, 2009; Lockwood, 2009; Martin, 2009; Verganti, 2009) and the term 'design thinking' is somewhat of a buzzword today, although what it suggests is by no means new to designers and design educators. Nevertheless, as regards research into design creativity Design Thinking is worth our attention because of three of its core dictums: problems are defined based on observation; problem solving, development and designing are always carried out by teams; and last but not least – candidate solutions are constantly prototyped, at different levels of detail and accuracy: "prototype until you puke", as one acute observer noted.⁴ Whenever possible these prototypes are physical 3-D objects, including very rough ones, later tested and assessed by real users.

Design Thinking, a method now taught to design and business students, is based much more on insight and experience than on research, yet in terms of implementation it is arguably more successful than all research-based engineering creativity tools put together. Is there a lesson to be drawn from this? We think that yes, there is. The single most important lesson that Design Thinking teaches us is that *finding* problems is based on intensive real-life observation of human beings and their behavior. This is a better guarantee than can be obtained in other way of the relevance of a problem. All too often researchers pose a problem that seems important *to them*, without checking its relevance to potential users or others to be affected by the outcome, or testing the proposals on these constituencies on the fly. Is this not why we have thousands of research reports accumulating dust in drawers? Yes, users and potential users may make mistakes and misjudge proposals for various reasons, but the odds are they would make fewer mistakes than a few researchers who think they know enough about these users without testing their assumptions.

Our proposal is to treat research a little like design: first get a good enough idea. Design Thinking teaches how to get that idea through observation. Then experiment as much as possible, and prototyping-test cycles are proposed as the most viable experimentation mode. If one is aiming at providing a creativity enhancement tool, as most design creativity research

does, such a tool would need to go through many more cycles of testing than is currently habitual. Should it always be done by teams? Here we would say: it depends. Teams that work well together have the advantage of fast feedback loops and motivational power, especially in the 'quick and dirty' prototyping activity typical of initial design explorations, and – we suggest – also design research activities. But idea generation by individuals should not be ruled out, if based on proper observations and submitted to rigorous testing.

4 Basic Research

Although not prevalent, there is also basic design creativity research, and this is fortunate. It is fortunate because as in other fields, some 'what' and 'why' questions are no less important than the typical 'how' or 'when' questions we ask when we perform implied research. Basic research in design is often interdisciplinary and incorporates knowledge and competencies from other fields; in the case of design creativity research we can think of e.g., psychology (cognitive, organizational and developmental), anthropology, computer science, business administration, and more. Basic research may be theoretical or empirical; in both cases it potentially helps pose relevant goals for implied research. Areas such as the structure and nature of the design space (Woodbury and Burrow, 2006), visual and spatial cognition and reasoning in design (Gero et al., 2004); mental models in design problem solving and team processes and communication in design (Badke-Schaub et al., 2007), are some examples. They give rise to more concrete questions such as, for example, in the realm of design communication: what is the role of gestures (Visser, 2010)? Or in the realm of representation: what is the role of sketching and visual reasoning (Goldschmidt, 1994)? Or, in reasoning: which stimuli enhance or block creativity, and under what conditions (Purcell and Gero, 1996)? Research on such topics does not normally lead to immediate applicable practical results in the form of design support tools, but it expands our knowledge, it helps avoid wrong assumptions and occasionally it opens up new frontiers for further basic as well as applied research.

Why do we need to carry out interdisciplinary research? Take for example the question of stimuli and their effect on design creativity. We can show empirically that this or that type of stimulus has more or less positive or negative effect, but we often ignore the situated contingency of the probabilities of such effects, which may qualify any results we obtain. In

⁴ Blog by Bob Sutton: *Work Matters*.
http://bobsutton.typepad.com/my_weblog/2010/01/-engineering-as-a-driving-force-behind-the-design-thinking-movement.html
 accessed Aug. 2010.

basic research, we may want to also ask: how are diverse stimuli processed in the mind? Or in the brain? Needless to say, to do so we need knowledge from cognitive and/or neurocognitive science, which is best obtainable in an interdisciplinary research framework.

5 A Changing Perception of Creativity

Until not long ago creativity was seen as a trait with which a blessed few are endowed. We subscribed to a romantic notion of creativity as God-given, exercised when the muse is kind enough to visit the privileged. Today we tend to have a much more inclusive view of creativity; it is believed that everyone is creative to a certain degree and the task of research and education is to discover and facilitate the conditions under which people can bring to play their creative potentials. Boden (1994) has appropriately distinguished between two kinds of creativity, H-creativity, which refers to outstanding contributions at the level of society at large, and P-creativity, which is more modest but much more widespread and refers to creativity in its more quotidian sense. It is mostly the latter that we tend to embrace today, and this is what we endeavor to encourage and bring out. In the information technology era in which we live many more people are invited to contribute to creative processes, and the new concept of *crowdsourcing* (Howe, 2009), for example, is a good reflection of this tendency. Many people believe creativity can be taught and some of the above-mentioned programs attempt to do precisely that, in the area of design.

In our opinion one can definitely help people realize their potential by lifting predicaments and creating favorable conditions, but we think that all but every 'how to' design creativity-enhancing program is in fact just a 'best practice' guide. This is fortunate, in fact, because what we should encourage is good design practice leading to good results that hold value, and not curtailed practices that lead to catchy results with no value attached to them. Design creativity research should definitely build on the fact that information, which empowers all who seek to be creative and innovative, is now freely accessible by just about everybody. In fact the increasing rate in which information is made available is so great that already now it is not easy to sort out relevant information and discard the rest. Some predictions have it that in 2020

available information will double itself every 73 days!⁵ Seeking out the relevant may become ever so difficult, and since creativity rests on knowledge, which in turn is closely related to information, this is a concern that we should keep in mind in design creativity research.

Our point here is that practice appears to be way ahead of research already today. Creativity research, basic and applied, must be very much aware of this in planning research agendas.

6 Some Concluding Remarks

Design creativity has been one of the most sought-after topics in design and design thinking research. Most of this work is implied research – researchers try to prove, empirically and otherwise, that incorporating certain procedures into the design process (or in parallel to it, or preceding it) has a positive effect on design creativity, measured in one way or another. This is a healthy response to the increasing hunger of the business world for ever more innovative and creative ideas and products. The great demand for innovation has now spread from industry and business also into policy making in a large number of fields, and as we learned from *Newsweek*, creativity is a prerequisite for leadership. Possibly to the great surprise of the corporate and political world, it was designers who have proven to be able to deliver the goods: they devised the Design Thinking method which, with help from thinkers in other disciplines, appears to be successful in really making a difference. It is successful because it avoids the merely catchy and glittery, and focuses on the good – the real gold: that is, solutions that really impact people's lives, and not just momentarily; solutions that facilitate a life that is healthier, easier, more pleasant, that boasts value. However, Design Thinking has reached so much popularity that its deep design roots are in danger of being overlooked and its proposed procedures stand the risk of being over-simplified and reduced to a set of formal procedures, a 'checklist' that might present just about any process as conforming to Design Thinking.

It is time for the design creativity research community to step in forcefully and demonstrate that research, both basic and applied, can be very meaningful. To do so *we must treat research as a*

⁵ Nicklas Lundbald, Head of Public Policy at Google, in a public lecture at Stanford University, Aug. 11, 2010.

design task, and be creative about how we carry out our research. This means shaping very good research questions, of real relevance, following a very thorough acquaintance with, and understanding of, both the field and new research etiquettes. We must beware of fashionable, populist or catchy questions and ask good questions, if we are to achieve real value. In basic research in particular, this requires not only great insights but also patience, courage and the willingness to defer recognition: Nobel laureates are often rewarded for stubborn work carried out for years on non-mainstream topics that other people considered too risky or not sufficiently rewarding. In applied research this requires a very accurate assessment of real need: we want to avoid hard work that ends in drawers collecting dust or, worse, is met with the question: so what?

Let the design creativity research community step into the leadership position it ought to occupy, and which it now has a unique opportunity to inhabit, because the world has finally caught up with us. But let us do so by raising the threshold of our research standards and our ethical awareness, and by re-shaping and upgrading the manner in which we carry out and assess our efforts.

References

- Badke-Schaub P, Neumann A, Laure K, Mohammed S, (2007) Mental models in design teams: a valid approach to performance in design collaboration? *CoDesign* 3(1):5–20
- Boden MA, (1994) What is creativity? In Boden MA (ed) *Dimensions of creativity*. Cambridge, MA: MIT Press: 75–117
- Brown T, (2009) *Change by design: how design thinking transforms organizations and inspires innovation*. NY: HarperBusiness
- Gero JS, Tversky B, Knight T, (eds.) *Visual and spatial reasoning in design III*. Sydney: Key Centre of Design Computing and Cognition, University of Sydney
- Goldschmidt G, (1994) On visual design thinking: The vis kids of architecture. *Design Studies* 15(2):158–174
- Gorman ME, (1998) *Transforming nature: ethics, invention and design*. Boston: Kluwer Academic Publishers
- Higgins JM, (1994) *101 Creative problem solving techniques*. Winter Park, FL: The New Management Publishing Company
- Howe J, (2009) *Crowdsourcing: Why the power of the crowd is driving the future of business*. NY: Crown Press
- Isaksen SG, Dorval KB, Treffinger DJ, (1994) *Creative approaches to problem solving*. Dubuque, IA: Kendall & Hunt
- Lockwood T, (ed.) (2009) *Design Thinking: Integrating Innovation, Customer Experience, and Brand Value*. Design Management Institute. NY: Allworth Press
- Martin RL, (2009) *The design of business: why design thinking is the next competitive advantage*. Cambridge, MA: Harvard Business School
- McFadzean E, (1998) The creativity continuum: towards a classification of creative problem solving. *Creativity and Innovation Management* 7(3):131–139
- Osborn AF, (1953) *Applied imagination*. NY: Scribner
- Parnes SJ, (1992) *Creative problem solving and visionizing*. In Parnes SJ (ed.), *Source book for creative problem-solving: a fifty year digest of proven innovation processes*. Buffalo, NY: Creative Education Foundation Press:133–154
- Purcell AT, Gero JS, (1996) Design and other types of fixation. *Design Studies* 17(4): 363–383
- Shah JJ, Smith SM, (2003) Metrics for measuring ideation effectiveness. *Design Studies* 24(2):111–134
- Stevens G, (1998) *The favored circle: the social foundations of architectural distinction*. Cambridge, MA: MIT Press
- vanGundy AB, (1988) *Techniques for structured problem solving* (2nd edition). NY: Van Nostrand Reinhold Company
- Verganti R, (2009) *Design driven innovation: changing the rules of competition by radically innovating what things mean*. Cambridge, MA: Harvard Business School
- Visser W, (2010) Function and form of gestures in a collaborative design meeting. In Kopp S, Wachsmuth I (eds.) *Gesture in embodied communication and human-computer interaction*. Berlin: Springer:61–72
- Woodbury RF, Burrow AL, (2006) Whither design space? *AIEDAM* 20(2):63–82

Using Evolved Analogies to Overcome Creative Design Fixation

Steven M. Smith, Julie S. Linsey and Andruid Kerne
Texas A&M University, USA

Abstract. Human cognition is critically important in all creative conceptual design. People are susceptible to design fixation, blocks or impassés caused by a variety of unconscious cognitive processes. Insight that resolves fixation can be triggered by accidentally encountered cues, but designers cannot know in advance which environmental triggers are most appropriate. Two domains, patents and life forms, encompass countless well-tested mechanisms for solving environmental problems. A patent database and a compendium of life forms could provide rich sources of analogies that might trigger insight, thereby overcoming design fixation.

Keywords: creativity, cognition, fixation, incubation, insight, analogy, biological

1 Designers Are People

It may seem obvious, once you see it written down or spoken aloud, that designers are humans. Therefore, every design that is created is conceptualized by a human mind, which is the purview of cognitive psychology. Cognitive psychologists conduct experiments to test theories about cognitive structures (such as “working memory” or “mental models”) and cognitive processes (such as “encoding” or “visualization”). The various ways in which cognitive structures and processes collaborate to produce creative ideas is referred to as “creative cognition” (e.g., Finke, Ward and Smith, 1992; Smith, Ward and Finke, 1995). Rather than focusing on some singular “creative process,” the creative cognition approach portrays creative thinking as a set of skills, operations, and methods for producing creative ideas.

Creative cognition, that is, creative thinking engages many different cognitive mechanisms. Some of the more prominent ones include problem solving, conceptualization, analogical reasoning, inductive inference, conceptual combination, and visualization. These cognitive mechanisms are found in essentially all humans; what is special about creative cognition are not these underlying structures and processes, but rather the ways in which individuals engage them. Different domains of creativity, such as business,

musical performance, or science, may have very different ways in which creative contributions are produced and discovered, and even within a single discipline, different individuals may utilize different approaches for thinking creatively. Nonetheless, there are a few universals that appear in virtually all domains and individuals, and scientists have studied these regularities to better understand creative cognition.

2 Cognitive Fixation

Cognitive fixation refers to a potentially resolvable block or impediment to reaching the goal of one’s mental activity, something that blocks completion of different types of cognitive operations, including many processes and structures involved in memory, problem solving, and creative ideation (e.g., Chrysikou and Weisberg, 2005; Jansson and Smith, 1991; Purcell and Gero, 1996; Smith and Blankenship, 1989, 1991). The cognitive operations that cause fixation are usually adaptive.

An unconscious cognitive system that reacts to stimuli and situations, enabling automatic responses to long-practiced skills like reading, driving, or recognizing familiar faces. This system provides the means for “offloading” (cognitively) the processing of those frequent responses to the automatic system, rather than using up resources of the conscious explicit system. This offloading allows more resources for the conscious (explicit) system for complex tasks, ones that are not represented by rote responses. The representations that, through one’s learned skills, can be offloaded to an unconscious system is adaptive; consequently, the rare inappropriate use of unconsciously-processed knowledge is difficult to detect. A persistent and implicit use of knowledge that is inappropriate and counterproductive is a good definition of fixation.

2.1 Implicit Memory

Implicit memory, an unconscious memory system, remains intact even in amnesic patients who have poor explicit memory, our conscious memory system. After reading a list of words that includes the word ANALOGY, most people, including amnesiacs, find it easy to complete the word fragment A _ _ L _ G Y a short time later. Having recently seen the solution word, their implicit memory brings the correct solution ANALOGY immediately to mind, without the need for deliberate attempts to think of a solution. Smith & Tindell (1997), and later, others (e.g., Lustig & Hasher, 2001; Leynes, Rass & Landau, 2008; Kinoshita & Towgood, 2001), showed that the word fragment A _ L _ _ G Y is particularly difficult to solve, and for the same reason; in this case, implicit memory brings instantly to mind the incorrect answer, ANALOGY, which orthographically resembles the correct answer, ALLERGY. Smith & Tindell showed that people cannot avoid this type of cognitive fixation even when they are explicitly warned about it.

2.2 Problem Solving

Studies of fixation effects in creative problem solving (Kohn and Smith, 2009; Smith and Blankenship, 1989, 1991) found that showing subjects inappropriate hints interferes with the ability to solve creative puzzle problems, such as Remote Associates Test problems. In these experiments, participants had to think of solution words that were remotely related to all three test words in each puzzle problem. Participants who read non-solution words that were closely related to test words were significantly less able to think of the appropriate remote associate solution words.

2.3 Creative Idea Generation

People who have seen or heard inappropriate “hints” have a difficult time going beyond those hints in creative idea generation tasks (e.g., Landau and Lehr, 2004; Smith, Ward and Schumacher, 1993). When participants in experiments first viewed examples of ideas, they often incorporated the features of the examples in the creative ideas they sketched, a conformity effect. Conformity effects occurred even when participants were asked to think of ideas as different from the examples as possible. These studies show that hints or examples can constrain the creative process. Furthermore, as in the Smith and Tindell (1997) experiments, this conformity effect cannot be voluntarily avoided; fixating ideas are apparently brought to mind by implicit memory processes.

2.4 Brainstorming

Brainstorming refers to creative ideation or idea generation activities done as collaborative groups. The practice of brainstorming, as well as other group creative ideation techniques, has become increasingly popular since the method was originally conceived (Osborn, 1957; Parnes and Meadow, 1950). Scientific evidence, however, has shown that group brainstorming is less productive than individual brainstorming (Diehl and Stroebe, 1987, 1991), comparing real groups with nominal groups (i.e., the summed products of the same number of individuals who work individually). A productivity deficit in group brainstorming has been reported often; that is, nominal groups generate more non-redundant ideas than do real groups. Kohn and Smith (2010) showed that such deficits are caused in part by fixation and conformity effects, because group members can become fixated on the ideas they hear from others in their group.

2.5 Design Fixation

Studies of design fixation show that the fixation and conformity effects that occur when people solve puzzles or generate creative ideas can be observed when people design new objects or devices to fulfill specified design functions (Jansson and Smith, 1991). Examples of flawed designs (the flaws were not pointed out or explained to students) that were shown to engineering design students were often incorporated in students’ designs when they were asked to design new bicycle carriers, and measuring cups for visually impaired persons. Although students were instructed not to give designs with drinking straws or mouthpieces in a spill-proof coffee cup, many who saw an example of such a design (Fig 1 panel c) produced designs with those explicitly forbidden flaws. Design fixation effects were also observed in professional engineers, as well. Engineers who were shown a highly flawed design for a biomechanical device incorporated the exemplified flaws in their own designs. Some of the example designs used to induce design fixation in Jansson and Smith’s (1991) study are shown in Figure 1.

Exemplified flaws frequently appeared in participants’ sketches when they designed ideas for new types of a. bicycle carriers; b. measuring cups for the blind; c. an inexpensive spill-proof coffee cup; d. a biomechanical device for taking samples of material in the intestine.

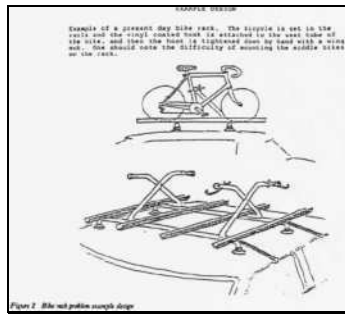

a

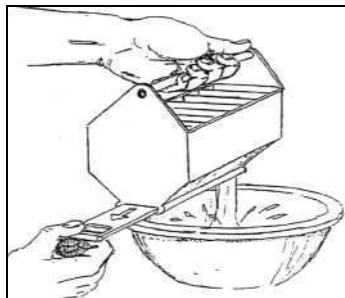

b

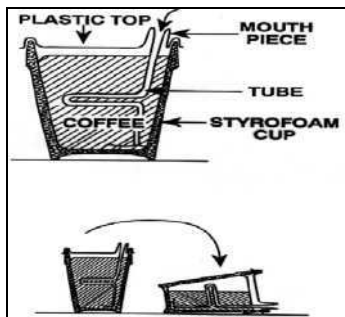

c

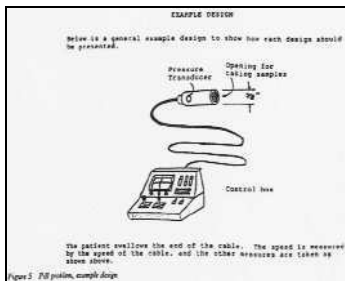

d

Fig. 1. Flawed example designs shown to designers in Jansson and Smith's (1991) experiments.

3 Incubation & Insight

Insight means a deep understanding of the innermost workings of a problem, which may include critical ideas that can solve difficult problems. When such an understanding springs to mind in a sudden realization, it is referred to as an insight experience, an aha experience, or a eureka moment. Insight experiences are unexpected, yet they are useful for finding ideas critical for solving seemingly intractable problems. Historically significant insights have provided unanticipated solutions to scientific problems, ideas for new products, methods for business practices, and history-changing inventions.

Incubation effects occur when insightful ideas or solutions of problems are realized after difficult problems temporarily are put aside. Anecdotal reports of everyday insight effects are quite common, as when someone puts aside a crossword puzzle when progress is at an impasse, and then instantly realizes the correct answer when they return to the puzzle. A sudden realization that characterizes incubation effects can be an unexpected insight or an unexpected memory. Research has demonstrated incubation effects in memory (Choi and Smith; 2005; Smith and Vela, 1991), creative problem solving (Kohn and Smith, 2009; Smith and Blankenship, 1989, 1991; Vul and Pashler, 2007), brainstorming (Kohn and Smith, 2010), and creative design (Smith, Kohn, and Shah, 2010).

The two theories best supported by scientific evidence are the forgetting fixation theory (Smith, 1994, 1995) and the opportunistic assimilation theory (Seifert et al., 1995). The opportunistic assimilation theory states that insightful ideas are triggered by stimuli that are serendipitously encountered some time after repeated failures have sensitized one to an unsolved problem. Thus, this theory focuses on hints that point the problem solver towards successful solutions. The forgetting fixation theory states that fixation is a precondition for observing incubation effects; in the absence of fixation, problem solutions are realized in straightforward ways. By putting fixation out of mind, at least temporarily, one can apprehend the problem without the counterproductive influences of inappropriately applied knowledge. This explanation focuses not on pointing towards a solution, but rather on releasing the problem solver from counterproductive work.

3.1 Forgetting Fixation

To forget fixation does not require that inappropriately used knowledge is deleted from one's knowledge or memory. Forgetting fixation means to think of the fixated problem without the inappropriate

information coming to mind. For example, if you are fixated on using a certain approach for solving a physics problem, and that approach is inappropriate for a particular problem, you need not delete that knowledge from memory to solve the problem; you must simply put the fixated approach out of mind when you apprehend the problem in question.

3.2 Environmental Triggers

There are many examples of how a clue, accidentally encountered in an unexpected context, triggered an important insight into the solution of a problem. For example, the idea for Velcro came from burrs collected accidentally on a hike through the Alps. As mentioned previously, NASA engineer James Crocker's idea for the Hubble space telescope repair was triggered by a chance encounter he had with an adjustable shower head. An inventor or designer sensitized to problems due to initial failures might stumble onto important clues, as described by the opportunistic assimilation theory (Seifert et al., 1995). In many historic examples, such as those described earlier, it is also the case that unexpected insights usually happen in contexts outside of the workplace. The unusual contexts in which historical insights occur may have caused problem solvers to think of problems in different ways, overcoming the initial fixation. Thus, we have a scientific dilemma: Can fixation be overcome better by shifting contexts, to facilitate thinking about a problem differently, or by exposure to provocative environmental stimuli?

There are fundamental flaws, however, for applying this method as a solution to design fixation. The first problem is that there are so many stimuli in any environment, and of the nearly infinite stimuli one stumbles across every day, which one is the relevant one? The problem is by no means trivial. Second, any one stimulus can be encoded in a very large number of ways. Take, for example, a pair of pliers. It could be encoded as a tool, a grasping tool, a tool for increasing leverage, a piece of metal, a conductive material, a plumb weight, a paperweight, a wedge, a piece of property owned by a carpenter, a human artifact, a substitute for a wrench or a vise-grips, a utensil that could be used to grasp food or dead bugs or a hot pan. Which representation is the one that will help the fixated problem solver? Finally, it is not clear where one should look for a rich source of clues that could trigger insights. A park? A subway station? The internet? What is needed is a place to look for relevant clues that have a good chance of triggering solutions to one's fixated problem.

4.2 Analogy & Design

We propose that a rich source of potentially relevant ideas that could help overcome design fixation is the world of analogy. For example, Crocker's idea for the Hubble space telescope repair was an analogy with an adjustable shower head. Velcro was based on an analogy to burrs. A support for a highway overpass might be based on an analogy to a waiter's hand carrying a heavy tray. Nonetheless, simply looking for *any* analogy in the world does not narrow the search for a rich source of potentially useful clues for overcoming design fixation. What analogies are most appropriate for a given design problem?

A method for helping engineers identify linguistically remote (cross-domain) analogies, the WordTree Design-by-Analogy Method (Linsey et al., 2008; Linsey, et al., 2009), is based on the cognitive principles of analogical retrieval. Design problems are represented in multiple linguistic representations at various levels of abstraction to maximize the number of appropriate analogues.

5 Well-Tested Analogies

Analogies can be based on mechanisms that have been well-tested, and that reliably solve certain problems. Two types of well-tested mechanisms, those found in a patent database, and those found in the domain of biology, are proposed as potential remedies to design fixation. These mechanisms are quite varied and highly imaginative. This speculative proposal is not to adopt these mechanisms by simply plugging them in to one's design, but rather to examine them in a more general abstract manner, the way that analogies can provide useful structure for conceptual design.

One type of database that could be very useful for triggering ideas that might remediate design fixation is a patent database. The patent approval process is clearly one that rigorously tests the efficacy of patented ideas. Such ideas utilize a variety of mechanisms to solve longstanding problems. Accessing patent databases, therefore, provides a rich domain of well-tested ideas that could potentially help the designer overcome design fixation. Linsey et al. (2008) have described the basis of remote analogical transfer from such a database.

Another type of database that could provide a vast source of mechanisms suitable for analogical transfer would be a compendium of life forms, including microorganisms. The long process of evolution, that is, random variation and adaptive selection, has provided a first rate testing ground for the efficacy and adaptability of these life forms. These biological

mechanisms can provide a rich source of life-based solutions to longstanding environmental problems, such as those related to locomotion, energy transfer, temperature regulation, self-repair, and so on.

Should the designer simply peruse these databases, the way shoppers browse through a mall or readers browse through bookstores or libraries? Perhaps, but we speculate that there may be better ways to find remedies for design fixation, ways that narrow the search for ideas to the most relevant ones that the designer may not have considered. Specifically, the WordTree Method (Linsey et al., 2008; Linsey, et al., 2009) uses abstracted versions of design functions to focus a search for relevant analogues to design problems. Applied to rich sources of adaptive mechanisms, such as patent databases and life form collections, we speculate that designers could have a useful remedy for overcoming design fixation.

References

- Choi H, Smith SM, (2005) Incubation and the resolution of Tip-of-the-tongue states. *The Journal of General Psychology* 132(4):365–376
- Chrysikou EG, Weisberg RW, (2005) Following the wrong footsteps: fixation effects of pictorial examples in a design problem-solving task. *Journal of Experimental Psychology, Learning, Memory and Cognition* 31(5):1134–1148
- Diehl M, Stroebe W, (1987) Productivity loss in brainstorming groups: Toward the solution of a riddle. *Journal of Personality Social Psychology* 53:497–509
- Diehl M, Stroebe W, (1991) Productivity loss in idea-generating groups: Tracking down the blocking effect. *Journal of Personality and Social Psychology* 61:392–403
- Finke RA, Ward TB, Smith SM, (1992) *Creative Cognition: Theory, Research, and Applications*. Cambridge, MA: MIT Press
- Jansson D, Smith S, (1991) Design fixation. *Design Studies* 12(1):3–11
- Kinoshita S, Towgood K, (2001) Effects of dividing attention on the memory-block effect. *Journal of Experimental Psychology: Learning, Memory, and Cognition* 27:889–895
- Kohn NW, Smith SM, (2009) Partly versus completely out of your mind: effects of incubation and distraction on resolving fixation. *Journal of Creative Behavior* 43(2):102–118
- Kohn NW, Smith SM, (2010) Collaborative fixation: Effects of others' ideas on brainstorming. *Applied Cognitive Psychology*
- Landau JD, Lehr DP, (2004) Conformity to experimenter-provided examples: Will people use an unusual feature? *Journal of Creative Behavior* 38(3):180–191
- Landau JD, Leynes PA, (2006) Do explicit memory manipulations affect the memory blocking effect? *American Journal of Psychology* 119:463–479
- Leynes PA, Rass O, Landau JD, (2008) Eliminating the memory blocking effect. *Memory* 16(8):852–872
- Linsey J, Tseng I, Fu K, Cagan J, Wood K, (2009) Reducing and perceiving design fixation: Initial results from a NSF-sponsored workshop. *International Conference on Engineering Design*, Stanford, California
- Linsey J, Wood K, Markman A, (2008) Increasing Innovation: Presentation and Evaluation of the WordTree Design-by-Analogy Method. *ASME IDETC Design Theory Methodology Conference*, New York
- Osborn A, (1957) *Applied imagination*. New York: Scribner
- Parnes SJ, Meadow A, (1959) Effects of “brainstorming” instructions on creative problem solving by trained and untrained subjects. *Journal of Educational Psychology* 50:171–176
- Purcell AT, Gero JS, (1996) Design and other types of fixation. *Design Studies* 17(4):363–383
- Seifert CM, Meyer DE, Davidson N, Patalano AL, Yaniv I (2005) Demystification of cognitive insight: Opportunistic assimilation and the prepared-mind perspective. In Sternberg RJ, Davidson JE, (Eds.), *The nature of insight*, 65–124, Cambridge, MA: MIT Press
- Smith SM, (1994) Getting Into and Out of Mental Ruts: A theory of Fixation, Incubation, and Insight. In Sternberg RJ, Davidson JE, (Eds.), *The Nature of Insight*, Cambridge, MA: MIT Press
- Smith SM, (1995) Fixation, incubation, and insight in memory and creative thinking. In *The Creative Cognitive Approach*. Smith SM, Ward TB, Finke RA, (Eds.), 135–156, Cambridge, MA: The MIT Press
- Smith SM, Blankenship SE, (1989) Incubation effects. *Bulletin of the Psychonomic Society* 27(4):311–314
- Smith SM, Blankenship SE, (1991) Incubation and the persistence of fixation in problem solving. *American Journal of Psychology* 104:61–87
- Smith SM, Kohn NW, Shah JJ, (in press) What you see is what you get: Effects of provocative stimuli in creative invention. In *Studying design creativity*, Gero JS, (Ed.) Springer Press
- Smith SM, Tindell DR, (1997) Memory blocks in word fragment completion caused by involuntary retrieval of orthographically similar primes. *Journal of Experimental Psychology: Learning, Memory and Cognition* 23(2):355–370
- Smith SM, Vela E, (1991) Incubated reminiscence effects. *Memory Cognition* 19(2):168–176
- Smith SM, Ward TB, Finke RA, (1995) *The Creative Cognitive Approach*. Cambridge, MA: MIT Press
- Smith SM, Ward TB, Schumacher JS, (1993) Constraining effects of examples in a creative generation task. *Memory Cognition* 21:837–845
- Vul E, Pashler H, (2007) Incubation benefits only after people have been misdirected. *Memory Cognition* 35(4):701–710

Design Creativity Research: From the Individual to the Crowd

Mary L. Maher
University of Sydney, Australia

Abstract. Research in design creativity has focused on individual creativity and on creativity in a collaborative or organizational setting. Collective design and crowdsourcing creativity differ from individual and collaborative creative design by building on the foundations of social computing so that individuals are motivated to contribute voluntarily. Research that improves our understanding and support for these phenomena is a trajectory from existing creativity and design research methods and models that study individuals and teams to studying crowds. Three directions for research in crowdsourcing creativity are: technology development, creative design processes, and evaluating creativity.

Keywords: creative processes, evaluating creativity, collective intelligence, crowdsourcing

1 Introduction

Research in design creativity has focused on individual creativity and on creativity in a collaborative or organizational setting. This paper looks at how research based on individuals and teams can provide direction for understanding design creativity in large scale collective intelligence. In this paper, collective intelligence refers to the phenomena of using social computing and crowdsourcing as the approach to generating creative designs. Creative design from collective intelligence can best be described by a continuum for sourcing creative ideas: from the individual to the crowd.

- *Individual:* An individual is the source of a creative design.
- *Team:* A team is selected to develop a creative design.
- *Self-selected Teams:* A design challenge is announced and teams form to address the challenge: one or more teams are selected to develop their creative design.
- *Crowd:* A challenge is announced and through crowdsourcing and social computing, individuals, groups, and teams contribute ideas in response to the challenge and each other to develop one or more creative designs.

Creativity is a topic of philosophical and scientific study considering the scenarios and human characteristics that enable creativity as well as the properties of computational systems that enhance or simulate creative behavior. When studying creativity, we can study how creativity occurs focusing on the *processes* that produce creative designs and we can study what makes a design creative focusing on how we *evaluate* a design to determine if it is creative. There are at least three ways in which creativity research is focussed:

- *human creativity:* psychological studies of creative people and their characteristics or cognitive studies of people performing tasks in which creativity can be observed possibly using prescribed methods or computer tools;
- *computational creativity:* philosophical studies and artificial intelligence studies of computational systems that are based on models or theories of creativity expressed in a formal language such as search spaces and algorithms;
- *creativity in organizations:* the study of methods, environments, and leadership behaviors that encourage creativity and innovation in the workplace.

Creativity is explored and studied in the context of educational environments using students as subjects and in professional contexts using professionals as the subjects. In both educational settings and professional organizations individuals are selected to work on projects. The results of research on creativity in organizations provides guidelines for stimulants and obstacles to creativity as well as informs organizations on how to compose project teams to encourage creativity (Amabile et al., 1996). Similarly, research studies have established a set of behaviors and guidelines for leadership that encourages creativity (e.g. Politis, 2003). Computer supported collaborative work (CSCW) is a research field that studies how groups are supported with computational systems that facilitate communication and collaboration. Some of these studies consider whether the new collaborative

technology enhances creativity. For example, Kim and Maher (2008) study the impact of tangible user interfaces on the collaborative design process for evidence of the problem finding behaviors associated with creativity.

Crowdsourcing, or more generally collective intelligence, invites anyone to participate in a project, or challenge. In crowdsourcing, the organization and corresponding work environment is replaced with a distributed, self-organizing, and potentially large number of people volunteering their time. People self organize rather than fitting in to an established organizational structure with established leadership roles. Howe (2009) describes why crowdsourcing should be so appealing to organizations by quoting Bill Joy, co-founder of Sun Microsystems: “No matter who you are, most of the smartest people work for someone else”. Examples of crowdsourcing creative design solutions are

- Myoo Create¹, a web site that crowdsources solutions to sustainable and social challenges;
- Quirky², a web site that crowdsources product design;
- Threadless³, a web site that crowdsources t-shirt designs; and
- Top Coder⁴, a web site that crowdsources software design and development.

This paper explores research directions for creativity in design that may lead to a better understanding of the self-organizing phenomena of crowdsourcing creativity in three categories: technologies that support and encourage crowdsourcing, creative processes in crowdsourcing environments, and evaluating designs as creative or routine in crowdsourcing environments.

2 Understanding Creativity in Design

One approach to studying creativity in design is to describe and understand the processes that generate potentially creative artifacts, which focus on the cognitive behavior of a creative person or team, or the properties of a computational system that can generate creative designs. Another approach is research that leads to characteristics or metrics to evaluate the

results of an individual or team to determine if a design is creative.

2.1 Understanding Creative Processes

When describing creative processes there is an assumption that there is a space of possibilities. Boden (2003) refers to this as a conceptual space and describes such spaces as structured styles of thought. In computational systems such a space is called a state space. How these spaces are changed, or the relationship between the set of known artifacts, the space of possibilities, and the potentially creative artifact, is the basis for describing processes that can generate potentially creative artifacts.

There are many accounts of the processes by which a potentially creative artifact can be produced. The processes for generating potentially creative artifacts are described generally by Boden (2003) as three ways in which creative artifacts can be produced:

- combination,
- exploration,
- transformation.

Each of these are described in terms of the way in which the conceptual space of known artifacts provides a basis for producing a creative artifact and how the conceptual space changes as a result of the creative artifact.

Computational processes for generating potentially creative designs are articulated by Gero (2000) as:

- combination,
- transformation,
- analogy,
- emergence,
- first principles.

These processes can become operators for generating artifacts that explore, expand or transform the relevant state space.

Shah, Smith, and Vargas-Hernandez (2003) associate creative design with a process they call ideation. They show that processes that generate more ideas are more likely to produce creative designs.

Research in understanding creative processes is done by interviewing or observing creative designers or establishing experiments that study the cognitive processes while a person is engaged in a design task. This research requires collecting data during the design session and analyzing the data using grounded theory or hypothesized models of creative processes. In the final section of this paper, a method for collecting and analyzing data in crowdsourcing creativity is proposed.

¹ <http://www.myoocreate.com/>

² <http://www.quirky.com/>

³ <http://www.threadless.com/>

⁴ <http://www.topcoder.com/>

2.2 Evaluating Potentially Creative Designs

While processes associated with creative design provide insight into the nature of creativity and provide a basis for computational creativity, they have little to say about how we know if the result of the process, a potentially creative artifact, is creative. The articulation of process models for generating creative designs does not provide an evaluation of the product of the process and is insufficient for evaluating if a potentially creative design is creative.

Most definitions or evaluations of creativity, including definitions in the dictionary, include novelty as an essential aspect of creativity. Some definitions state that value is the umbrella criteria and novelty, quality, surprise, typicality, and others are ways in which we characterize value for creative artifacts. For example, Boden (2003) claims that novelty and value are the essential criteria and other aspects, such as surprise, are kinds of novelty or value. Wiggins (2006) often uses value to indicate all valuable aspects of a creative artifact, yet provides definitions for novelty and value as different features that are relevant to creativity. Oman and Tumer (2009) combine novelty and quality to evaluate individual ideas in engineering design as a relative measure of creativity.

Several researchers consider unexpectedness, or surprise, to be a relevant feature of creativity. Wiggins (2006) argues that surprise is a property of the receiver of a creative artifact, that is, it is an emotional response. Wiggins' view of surprise is similar to the definition of value because the interpretation lies outside the description of the artifact. Boden (2003) claims that surprise is a kind of novelty. In this paper, surprise is a separate essential criterion for evaluating a potentially creative artifact because it is possible for something to be novel and valuable, but not be surprising. Since unexpectedness is associated with creativity and is different operationally from both novelty and value, then novelty and value are not sufficient.

According to Maher (2010), novelty, value, and surprise are distinct features of a creative artifact:

- *Novelty* is based on a comparison of a description of the potentially creative artifact to other artifacts in the same conceptual space.
- *Value* is a derivative feature that requires an interpretation of the potentially creative artifact from outside the description of the artifact.
- *Surprise* is a feature that is based on expectations and so is a function of the attributes of the potentially creative artifact in comparison to other artifacts (like novelty), but also depends on a projection or expected value

that lies outside the description of the artifacts (like value).

Research in evaluating potentially creative designs is typically done by asking individuals to report on their own creativity and/or by asking a selected group of experts for their opinion on the design. By establishing a common set of features that are essential for a design to be creative, it may be possible to compare across the different design disciplines in crowdsourcing environments. In the final section of this paper, an approach for evaluating the results of crowdsourcing creativity is presented.

3 Collective Intelligence in Design

Crowdsourcing is part of a larger phenomenon called Collective Intelligence. Collective intelligence (or CI) is an emergent phenomenon that has long existed and evolved in human cultures. The term collective intelligence is commonly used to characterize the phenomenon of large numbers of people contributing to a single project and exhibiting intelligent behavior. The phenomenon is not new but it is being defined and redefined as new variations on the theme are emerging on the Internet at an increasing rate.

Collective intelligence can be described along a continuum: from aggregating the knowledge or contributions of individuals, a kind of collected intelligence, through to collaboration among individuals with the goal of producing a single, possibly complex output as a kind of collective intelligence. Rather than thinking of collected intelligence and collective intelligence as two separate entities, we can view them as two ends of a continuum, as illustrated in Fig. 1, where the degree of direct interaction between individuals and their contributions differs. Systems may lie anywhere along this continuum as they incorporate more or less collaboration.



Fig. 1. The collective intelligence continuum (adapted from Maher, Paulini and Murty, 2010)

Collected intelligence, on the left side of the continuum in Fig. 1, describes systems in which an individual contributes to a specific challenge. Each solution or outcome for a design challenge is not synthesized with other solutions and therefore stands

alone. Quirky is an example of collected intelligence where anyone can contribute a product design. The underlying principle behind collected intelligence lies with individuals providing a single solution based on their own interpretation of the specific challenge. Collective intelligence, on the right side of Fig. 1, involves both collaboration and synthesis: individuals collaborate in the production of the solutions and individual solutions are synthesized for a synergistic solution. Top Coder is an example of this type of collective intelligence where anyone can contribute to the complex task of software design.

Quirky is a web site that uses crowdsourcing for product design. Anyone can submit, influence, or purchase a product design. Each submitted product design is critiqued by the community, which often includes improving the product design. The community can vote for the designs they like best by committing to a pre-sale. The reasons for participating are on the quirky web site: “candidacy to be next week's Quirky product, detailed community comments and feedback, real-time analytics and demographic profile of supporters and non-supporters, if chosen, your product could be on the market in as few as 10 days, influence that will earn you at least 4-12¢ of every dollar your product ever makes, an excited community as your product's evangelists.” Designs are contributed and modified by an individual, and collaboration occurs through critique.

Top Coder is implemented as a website that uses social computing and crowdsourcing for software design and development. Individuals can compete for prize money or post a project for others to complete. Social computing support is provided in the discussion forum pages, which not only supports social interaction, but also learning from the community. Unlike Quirky, Top Coder presents complex software design problems that are decomposed and synthesized by the community. An individual may contribute a portion of the design, but a single individual does not propose a total solution. Individuals can collaborate on a submission, and the finished product is the successful integration of many smaller parts.

4 Research Directions for Creative Design Emerging from Collective Intelligence

Design challenges are placed on collective intelligence web sites in order to crowdsource creative solutions. We can see from the Myoo Create web site that companies are looking at crowdsourcing as a way of bringing new ideas to a company or to solve a long standing challenging problem that has not been solved within the organization. For example, Myoo is

specifically interested in challenges that incorporate sustainable design as an essential and integral part of the requirements; where Quirky is open to any significantly innovative idea. There are many open research questions that could inform this kind of creative design that fall into the following categories:

- *Technology development*: What are the design considerations for a web site that successfully motivates people to contribute to crowdsourcing creativity? A principle of crowdsourcing is that there needs to be a crowd: while a small percentage of people are highly creative, a small percentage of a large number is still a large number.
- *Creative design processes* in crowdsourcing creativity: Does collective intelligence as a process look similar to individual or team intelligence when working towards creative design? Understanding how the process of crowdsourced creativity develops could help determine what sort of problems are suitable for crowdsourcing.
- *Evaluating creativity* in collective intelligence: Does collective intelligence produce more creative designs than individual or team intelligence? Establishing a common metric for evaluating creativity allows us to compare potentially creative designs independently of their domain or source.

4.1 Technology Development

Recent studies of the social construction of knowledge in social computing environments such as wikipedia (eg Nov 2007) provide a basis for understanding how and why the internet is a technology that facilitates collective intelligence and encourages people to volunteer their time. Shirky (2008) provides an overview of many examples of how the internet encourages people to volunteer their time to make the world a better place. Malone et al. (2009) reports on a study of successful collective intelligence web sites and proposes a design pattern approach for formalizing the development of technology for collective intelligence. Research in computer supported collaborative design also provides insight into how technology can support crowdsourcing creative designs.

Maher, Paulini, and Murty (2010) present a conceptual space for extending our understanding of computer supported individual and collaborative design to collective intelligence in design, shown in Fig. 2.

In this conceptual space there are three dimensions that frame technology development for collective design:

- *Representation*: Computer support for design implies that there is an external representation of the design solution that facilitates individual and collaborative design. For crowdsourcing creativity, this representation is essential for encouraging the community to contribute, evaluate and analyze ideas and solutions.
- *Communication*: Providing facilities for people to communicate is essential for collaborative and collective design.
- *Motivation*: There are many ways in which the design of the web site for crowdsourcing can motivate individuals to contribute.

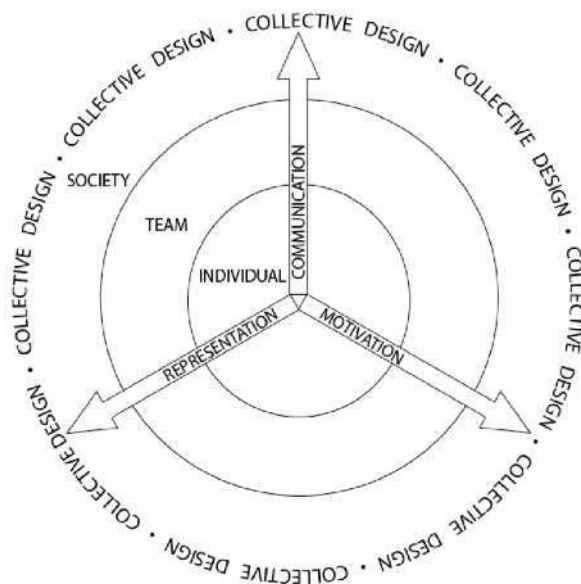

Fig. 2. Conceptual space for collective design (Maher, Paulini and Murty, 2010)

Research directions for technology development include identifying patterns that lead to successful collective creativity, developing frameworks that identify this type of design environment as a conceptual space for design of new environments, and understanding how different aspects of new technology encourage and facilitate creativity.

4.2 Creative Design Process

Cognitive studies of individual designers and design teams have lead to numerous models of design cognition. The use of protocol analysis as a basis for studying designers has produced many interpretations of the design process and creativity. In individual

design, the protocol data is a continuous stream of verbal utterances (think aloud method), gestures, actions, etc, collected during (concurrent) or after (retrospective) a design session. In team design, similarly, the protocol data is a continuous stream of verbal utterances (communication content), gestures, actions, etc collected during a collaborative design session. This method easily translates to studying collective intelligence by using the list of comments associated with a specific design challenge and a proposed design solution.

So far, crowdsourcing creative design has the following characteristics: a design challenge is announced, individuals respond with their proposed design solutions, the crowd comments on the proposed designs in a discussion forum, the crowd votes and/or a group of experts select one or more designs to be developed further. This process has two distinct parts: individual creativity and collective creativity. During the individual creativity phase, the designer works offline and does not leave a trace of their design process. Studying this phase of the design process is similar to studying individual designers. During the collective creativity phase, the crowd (including the designer) communicates via a discussion board, leaving a trace of their thoughts about the proposed design. This aspect of the design process can be studied by analyzing the text in the discussion forum.

Table 1 show an excerpt of a discussion about a design challenge posted on myoo. The discussion is segmented so that a single segment is a single sentence in the discussion. Each segment is coded, in this example, using four categories:

- *Ideation*: the comment suggests an idea to improve the design
- *Analysis*: the comment analyzes some aspect of the design
- *Evaluation*: the comment provides an evaluation of the design
- *Support*: the comment shows that the person likes this design

The total for each of the codes in this section of the discussion shows that ideation dominates the discussion. While this is not a significant sample, it shows that the discussion forum can support ideation, an important characteristic of creative processes.

Research directions for developing a better understanding of the design processes that emerge from crowdsourcing creativity include collecting data from web sites that crowdsource creative solutions, developing appropriate analysis methods, and using coding schemes that are also used for protocol studies of individuals and teams of designers. This will

provide a basis for comparing crowdsourcing to individual and collaborative design.

4.3 Evaluating Creative Design

Research on the characteristics of a creative design provides a basis for evaluating creative designs regardless of their source. Maher (2010) presents three essential criteria for evaluating creativity, regardless of the domain or source of creativity: novelty, surprise, and value. Novelty can be formalized as a measure of distance from known artifacts, allowing novelty to be measured using an algorithm for distance measure in a state space or by asking people to evaluate their perception of the novelty of the design. Surprise is an aspect of creativity that we recognize when we say that something is creative because it does not meet our expectations for the next novel artifact in its class. Surprise can be measured using pattern matching algorithms that look for variations across one or more attributes in a sequence of designs. When this pattern matching can be formalized as an algorithm, surprise can be recognized computationally. However, if we accept surprise as an essential criteria for creativity, it should be included in human evaluation of proposed designs. Value is a characteristic of creativity that reflects our individual or social recognition that a highly novel, random act or result is not sufficient for us to judge something as being creative. Measuring value is based on a set of performance criteria that can be adapted by the introduction of new performance possibilities in a creative artifact. Again, value can be measured computationally, or surveyed from individuals as we see in current studies of creativity and sites that crowdsource creativity.

Research directions for developing a better understanding of creativity in crowdsourcing include evaluating several design solutions using the same criteria, such as novelty, value, and unexpectedness, and comparing the responses across individual, team, and crowdsourced creativity.

Acknowledgements

Paul Murty and Mercedes Paulini contributed greatly to the ideas in this paper through our many discussions of collective intelligence in design. This paper references the papers we have jointly published, but the papers only reflect a small part of our joint development of ideas that frame the use of collective intelligence in design.

References

- Amabile TM, Conti R, Coon H, Lazenby J, Herron M, (1996) Assessing the work environment for creativity. *Academy of Management Journal* 39:1154–1184
- Boden M, (2003) *The Creative Mind: Myths and Mechanisms*. Routledge, 2nd edition
- Gero JS, (2000) Computational Models of Innovative and Creative Design Processes. *Technological Forecasting and Social Change* 64:183–196
- Howe J, (2009) *Crowdsourcing: Why the Power of the Crowd is Driving the Future of Business*. Three Rivers Press
- Kim MJ, Maher ML, (2008) The Impact of Tangible User Interfaces on Spatial Cognition During Collaborative Design. *Design Studies* 29(3):222–253
- Maher ML, (2010) Evaluating Creativity in Humans, Computers, and Collectively Intelligent Systems. In *Proceedings of the DESIRE'10 Conference: Creativity and Innovation in Design*, Christensen BT, Boztepe S, Kristensen T (eds), ACM International Conference Proceedings Series, 22–28
- Maher ML, Paulini M, Murty P, (2010) Scaling up: From individual design to collaborative design to collective design. In *Design Computing and Cognition DCC'10*, Gero JS (ed), Springer, 581–600
- Malone TW, Laubacher R, Dellarocas C, (2009) Harnessing crowds: Mapping the genome of collective intelligence. MIT Sloan School Working Paper 4732-09, available online: <http://ssrn.com/abstract=1381502>, accessed 07/01/10
- Nov O, (2007) What Motivates Wikipedians? *Communications of the ACM* 50(11):60–64
- Oman S, Tumer I, (2009) The Potential of Creativity Metrics for Mechanical Engineering Concept Design. In *Proceedings of the 17th International Conference on Engineering Design (ICED'09)*, Norell Bergendahl M, Grimheden M, Leifer L, Skogstad P, Lindemann U, (eds) 2:145–156
- Politis JD, (2004) Transformational and Transactional Leadership Predictors of the ‘Stimulant’ Determinants to Creativity in Organisational Work Environments. *Electronic Journal of Knowledge Management*, 2/2, <http://www.ejkm.com/volume-2/v2i2/v2-i2-art3.htm>
- Shah J, Smith S, Vargas-Hernandez N, (2003) Metrics for measuring ideation effectiveness. *Design Studies* 24(2):111–134
- Shirky C, (2009) *Here Comes Everybody: The Power of Organizing Without Organizations*. Penguin (Non-Classics)
- Wiggins G, (2006) A Preliminary Framework for Description, Analysis and Comparison of Creative Systems. *Knowledge-Based Systems* 19:449–458

Table 1. Analysis of online discussion for crowdsourcing creativity

Person	Comment	Ideation	Analysis	Evaluation	Support
P1	If the Waffler really can make waffle cups, I can hardly wait to fill them with Ben and Jerry's pistachio ice cream....my favorite kind of dessert!				1
	And if it can shape bread into cups and toast them, I'll like the Waffler ever more!	1			1
P2	Why not give 2 sets of plates with it and charge extra for another set.	1			
	Maybe have two basic designs waffle and pancake and then make other designs that can be submitted by users.	1			
P3	I was thinking about bacon (happens a lot) and I realized you could use the waffle shot plate to make little bacon shot cups.	1			
	You would lay a bit down for the bottom of the cup and twist and wind the rest up in a cylinder shape in the space used for waffle shots.	1			
	Great fillers could be chicken, eggs, waffle bits...etc.	1			
P4	Your definitely making me hungry				1
P5	I love waffles but the main reason i don't make waffles is because of the mess.		1		
	The runoff channel looks way too small.			1	
	It would be nice if the waffle making part were separate from the heating element so you could just stick the waffle making part in the dishwasher.	1			
	Something along the lines of this one? http://www.waffleironworld.com/nemco-7020.html	1			
P5	Another idea for cleanup - make the heating element easily removeable.	1			
	Have a heating plate on top and bottom make it so you can slide the entire heating/electrical unit out of the waffle iron so you can submerge the rest of it in water or your dishwasher.	1			
P6	Yes exactly!				1
	REA				1
P7	So maybe I'm a little late for this but I'm not to sure that shots will cook correctly and even if they do if they will stand.			1	
	I guess drinking an ounce of syrup will be a new college trend but I really don't get it.			1	
	Has anyone tested the ability to create a 1 oz shot glass out of batter.			1	
	It seems as though this one has gotten away from us.			1	
	IMHO the KISS method should be reapplied.	1			
Totals		11	1	5	5

Motivation as a Major Direction for Design Creativity Research

Amaresh Chakrabarti
Indian Institute of Science, Bangalore, India

Abstract. This paper views products of designing as outcomes of the effects of knowledge (i.e. product knowledge) and flexibility (i.e. process knowledge, with which to structure and modify product knowledge), both of which influence and are influenced by motivation. While knowledge aspects received substantial attention in the past, motivation received far less attention. This paper argues that design creativity research should focus on this area: identify major motivational factors, their relationships, how they affect design creativity, and how this understanding could be used to enhance creativity education and practice.

Keywords: Design creativity, motivation, creative lineages, milieus, individuals

1 Introduction

In his famous bestseller “Outliers”, Malcolm Gladwell (Gladwell, 2008), identifies the broad influences on what makes people successful, which could be classified into: ability, opportunity, and effort. Taking examples of people from diverse areas such as Beatles in music, Bill Gates in business, or Joe Flom in law, he argues that while ability is an essential ingredient for success, opportunity plays a significant role. Opportunities include for Bill Gates, for instance, to have: affluence of his parents to put him in the Lakeside school where only the most privileged could join; the exclusive computational facility at Lakeside school in Seattle where he studied; to work on these computers for long hours at the school; or the opportunity that arose due to development in 1975 of a minicomputer kit called Altair 8800, the year Bill Gates turned 21 – the right age to take advantage of the resulting PC revolution access. Also, it is crucial, Gladwell argues, to have put in substantial effort, in his estimate about 10,000 hours, into preparing for and working towards exploiting the opportunity.

Inspired by the work of (Lewis, 1981), we had earlier proposed three broad baskets of factors that might be responsible for design creativity: knowledge, flexibility and motivation (Chakrabarti, 2006):

- **Knowledge:** this refers to the product knowledge of the creative agent under focus, e.g. knowledge of how devices work, phenomena happen, etc;
- **Flexibility:** this refers to the process knowledge of the creative agent under focus – knowledge using which product knowledge is processed;
- **Motivation:** this refers to the factors that influence the amount of effort the agent puts in to develop and actualise product and process knowledge.

Taking the common definition of design creativity as the “ability or process of developing novel and useful ideas, solutions or products” (Sarkar and Chakrabarti, 2007), and taking the view that the three broad influences on success – ability, opportunity and effort, will also influence the usefulness of a product, we see that only two of the three influences are addressed by the three proposed baskets of factors. While creative ability in design is influenced by knowledge of two kinds – product and process, the effort that will be spent into developing and actualizing this ability is influenced by both knowledge and motivation. The baskets of factors do not seem to have much influence on opportunity. The realm of design creativity research, therefore, can encompass factors that could potentially affect two of the above three influences: *ability* and *effort*, with opportunity largely remaining out of bounds. Three points are noted about these baskets of factors:

- Both product and process knowledge and their actualisation are essential for design creativity;
- Motivation helps develop as well as actualise these knowledge types;
- The relationships between motivation and knowledge are synergistic – having motivation helps development and actualisation of knowledge, while having knowledge helps motivation for its (further) development and actualisation. The negative effects, of not having motivation or knowledge, are also synergistic.

2 Motivation as a Research Direction

Current research into creativity primarily focuses on definitions and measures of creativity, and on processes of ideation and their support. For instance, there is a large variety of definitions of creativity, its various components, and how to measure creativity, see (Sarkar, 2007) for a compilation. There is extensive work on understanding the product, process and ability aspects of creativity, i.e., what parameters in the product, process or ability of an agent or a group of agents relate to creativity (e.g. Davies, 1999). Also, a variety of methods for enhancing various aspects of creativity, mainly ideation, have been developed, e.g. Brainstorming (Osborn, 1963), Synectics (Prince, 1970), or TRIZ (Terninko et al., 1998). Analyzing current work on creativity from the viewpoint of the three major influences – product knowledge, process knowledge, and motivation for developing and actualising these, we see that while some aspects of product and process knowledge have been researched in depth, motivational factors for design creativity are much less investigated. Motivational factors, therefore, form the research direction in design creativity research that we wish to propose in this paper.

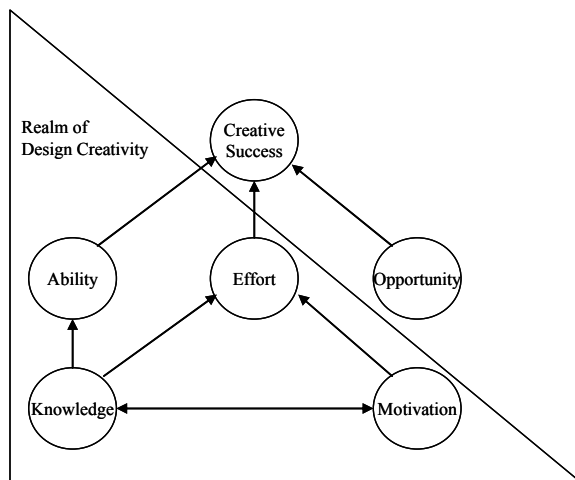

Fig. 1. Factors influencing creative success

2.1 Internal or External Reward or Punishment

We identify two broad groups of motivational factors: motivation for external reward (or against internal punishment), and motivation for internal reward (or against internal punishment). With inspiration from Abraham Maslow's pyramid expressing the hierarchy of human needs (Maslow, 1954), we take these two as increasingly more refined motivations for action.

We start at the first level: motivation for or against internal reward or punishment. If reward and punishment are taken as the two extremes of the same scale, this category can be referred to as *motivation for internal reward*. Three broad elements are proposed, which by no means are exhaustive: fulfilment of *curiosity* (e.g. Can that be achieved?), fulfilment of *ideals* (e.g. I want to save the planet), or taking up *challenge* (Let us see if we can achieve that).

At the second level, motivation is fuelled by external rewards: recognition/fame, wealth/money, power/influence, social-life/companionship/love, etc.

As in Maslow's pyramid, motivations may well start at the lower level, and go to the higher level as the needs in the lower level are already fulfilled.

Saunders and Gero (2001) speak of curiosity as a major motivational force in creativity. Curiosity is seen as a trait that derives pleasure from fulfilment, and shifts focus to something else to continue with this pleasure-deriving activity. Anecdotal literature is replete with references to curiosity, e.g., Feynman (Feynman, 1985) speaks about his childhood being curious of how nature works. The story of George de Mestral (Website1, abbreviated WS1) – inventor of Velcro (WS2) – is well-known for how his curiosity got the better of his irritation, to find how the burdock burrs that kept sticking to his clothes and his dog's furs during a hunting trip to the Alps in 1941 clung so well to fabric, which led to the invention of Velcro.

Fulfilment of ideals could also be seen as a major motivation. The work of Karl Marx, for instance, was driven strongly by his ideals of social equity. Many artists, e.g. Gauguin (WS3), Mondrian (WS4), or Klee (WS5) had been driven by strong ideals. Gauguin was drawn to primitivism in his endeavour to reach beauty in its purest form untouched by civilization; Mondrian strove for basic forms of beauty through his use of simple, monochromatic, geometric shapes; or Klee's works of art had been driven by his urge to evoke spirituality. In engineering, Alec Issigonis (WS6) have been driven by his "hate for large cars", a prime internal motivation for developing his most famous design Morris Minor "Mini".

The third source of internal motivation proposed is challenge. What the rewards are is a matter of further research: one possibility is the pleasure derived from the fun and excitement of carrying on the challenge, and those associated with the release at the point of succeeding the challenge. Watson – co-discoverer of the double-helix structure of the DNA – was driven by his perceived competition from Linus Pauling in a race to the Nobel Prize for this work (Watson, 1968). Thomas Alva Edison was quoted as saying "I never did a day's work in my life. It was all fun." (WS7).

2.2 A Preliminary Model of Motivational Cycle

A preliminary model of motivation called **DisMART** (acronym for **Dis**content-**Motivation**-**Action**-**Reward**-**Tendency**) is proposed below. It is based on the assumption that motivation is influenced by *discontent* – the difference between the perceived current state of things and the state of things as intended by the agent, and the *tendencies* of the agent; a greedy agent may be more affected by lack of wealth than knowledge. The resulting *motivation* – the urge to act, influences *action*, which influences the extent of *reward* or punishment; as a result, both current and intended state of things, as perceived by the agent, change, fuelling a new cycle of motivation and action. Reward is influenced also by ability and opportunity, but these are excluded from this model to focus on motivation.

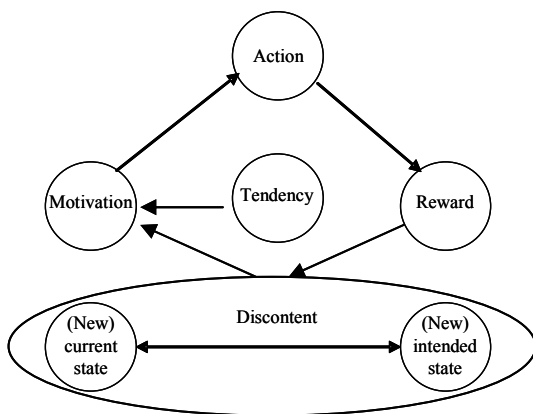

Fig. 2. DisMART model of motivational cycle

2.3 Research Issues

There is a host of research issues to be asked in the context of design creativity, namely:

- What are the factors that influence motivation?
- What are the relationships among these? For instance, how do external motivations relate to the internal motivations and so on?
- What is the process of rise and fall of motivations? Is there a threshold of something that triggers motivation, satisfaction of which upto a level allowing continuation of motivation, beyond which it may be demotivating?
- What happens if motivations lead to achievement or failure? What is gained or lost as a result?

2.4 Research Approaches

Many approaches could be taken to carry out research in this direction. I propose three, analysis of: creative individuals, creative milieus, and creative lineages.

Not surprisingly, creative individuals have been used often for creativity studies; e.g. Csikszentmihalyi (1997) used this to study societal aspects of creativity; Amabile (1983) used experts in studies on assessing creativity. I propose using information on them in studying motivations for design creativity, with two broad methods: historical case studies of lives of creative designers; and interviews/surveys of creative designers. The two approaches are somewhat complementary: the former helps analyse lives and work of individuals who are no more, while the latter help analysis of current personalities. The former provides longitudinal studies into the complexities of growth and maturity of the individuals, while the latter helps delve deeper into their minds. A combination, where possible, might give a more complete picture.

The second approach is to explore creative milieus to understand the motivating factors. This could be done by identifying the motivational elements valued and nurtured in these environments, and how well these relate to the creative successes of the individuals trained in the environments. In the context of development of modern science, an interesting example is Cambridge University in general, and its Trinity College in particular. As an indicator of scientific creativity, the university had 87 affiliates with Nobel Prize, of which 32 were affiliated to Trinity alone. What did Cambridge do that produced such a staggering number of creative ideas with consistency? Different types of milieus may have to be explored to understand creativity related to design of different types: MIT may be an interesting case to look for technological creativity, while TU Delft may be interesting to study creativity in industrial design.

The third approach is to follow cultural lineage of creative designers – the “Guru-Shishya Parampara” or master-pupil continuity with consistent creativity, and identify what leanings were passed on to ensure this.

3 Preliminary Explorations

We undertake three demonstrative explorations in this section, into the kind of research we propose should be carried out in depth: into creative lineages, on creative milieus, and on creative individuals.

3.1 Creative Lineages

For this exploration, I looked into the lineage of my own PhD supervisor – Thomas P. Bligh – who is an outstanding engineering designer and entrepreneur. Dr. Bligh received a B.Sc. and an MSc in Mechanical Engineering from the University of Witwatersrand, South Africa. After 4 years as a senior research engineer in the Mining Research Laboratories of the Chamber of Mines of South Africa, he returned to study for a Ph.D. in Physics on gaseous detonations at very high Pressures and their application to a rock breaking device. In 1972, he joined the Civil Engineering Department of University of Minnesota as an Assistant Professor, and worked on enhanced recovery of oil and gas, geothermal energy and energy conservation in buildings. He proposed the idea of earth sheltered buildings and started the ‘Underground Space Centre’ to design and research these structures. There are now over 60,000 such houses in the U.S.A. alone. In 1976 he joined the Mechanical Engineering Department at University of Minnesota to work on heat transfer in porous media (i.e. earth) and solar energy; one of his concentrator designs was used in the largest solar heating and cooling project to date. This led to the design and construction of the new earth sheltered Civil and Mineral Engineering Building at University of Minnesota, for which he received the ‘Outstanding Engineering Achievement of 1983’ award from the American Society of Civil Engineers. By this time he moved to the Mechanical Engineering Department at Massachusetts Institute of Technology as an Associate Professor. He was consultant to U.S. Windpower, who built the first ‘wind farm’ (of 2000 machines) in California. In 1986, he joined Cambridge University Engineering Department to teach design, and research into design and performance prediction of multi-hulls, design synthesis, and vision-assisted robots for Human Genome programme. Biopik – a vision-assisted robot became the product around which he co-initiated BioRobotics – a start-up in 1990s that became one of the top 20 fastest growing companies in the UK.

Dr. Bligh has a long term interest in underwater photography; he designed and built several underwater cameras, and won numerous awards for his underwater photographs taken using these cameras. He also designed, built and sailed many boats, with a specialist interest in catamarans. In 2000 he launched Lady Bounty - a 14 metre ocean racing/cruising catamaran – built to his own designs. Lady Bounty was launched in the summer of 2000 and caused a sensation when exhibited at the Southampton Boat Show. Since then, a number of production catamarans based on the same design have been completed, including Dazzler, which came first in the 75th Anniversary RORC Non-Stop

Round Britain and Ireland Race. Dr. Bligh sailed over 25000 miles on this boat. He retired from Cambridge in 2002, lives in Cornwall, and is an Emeritus Fellow of Gonville & Caius College, Cambridge (WS8).

Exploration of the creative lineages of Dr. Bligh (born 1941) yielded the following. His advisor was Prof. Frank R.N. Nabarro (1916-2006) – a renowned physicist, a Fellow of the Royal Society (FRS), and a pioneer of solid-state physics (WS9). He worked under Sir Nevill F. Mott (1905-1996) – a Nobel Laureate in Physics in 1977 for work on the electronic structure of magnetic and disordered systems, esp. amorphous semiconductors. Mott (WS10) studied in St John’s College, Cambridge under the tutelage of physicist Sir Ralph H. Fowler (1889-1944) (WS11), who supervised 3 Nobel Laureates and 15 FRS. Fowler (WS12-13) had two mentors: Archibald V. Hill and Ernest Rutherford. Lord Rutherford (1871-1937) was a British-New Zealander chemist and physicist (WS14) who became known as the father of nuclear physics, a Nobel laureate in Chemistry in 1908 for his investigations into disintegration of elements, and chemistry of radioactive substances. Hill (1886-1977) was a British physiologist and biophysicist who jointly received the 1922 Nobel Prize for Medicine for discoveries concerning the production of heat in muscles (WS17). Rutherford was a student of Joseph J. Thomson (1856-1940) – a British physicist and 2006 Nobel laureate in physics (WS15-16), who discovered the electron and isotopes, and invented the mass spectrometer. Thomson’s advisor was Lord Rayleigh (1842-1919), another Cambridge-based English physicist who received the Nobel Prize in physics for co-discovering Argon. He also discovered what are now called Rayleigh scattering and Rayleigh waves (WS18-19).

Lord Rayleigh had two advisors: Edward J. Routh and Sir George G. Stokes (WS20); both had William Hopkins as an advisor. Stokes (1819-1903) was a mathematician and physicist, who at Cambridge made important contributions to fluid dynamics (e.g. Navier–Stokes equations), optics, and mathematical physics (e.g. Stokes’ theorem). He became President of the Royal Society (WS21). Edward Routh (1831-1907), an FRS, was an English mathematician – an outstanding coach for students preparing for the Mathematical Tripos examination of Cambridge University, who (WS22) contributed to systematizing the mathematical theory of mechanics and developing modern control systems theory. William Hopkins (1793-1866) was a mathematician and a geologist, and an outstanding teacher with an impressive array of students e.g. Francis Galton and James Clark Maxwell, (WS23). He contributed to the theory that a solid forms the interior of the Earth, and was responsible for defining the field of Physical Geology (WS24).

Advisor to William Hopkins was Adam Sedgwick (1785–1873) (WS25) – one of the founders of modern geology, and an FRS. He had two mentors: Thomas Jones and John Dawson (WS26). Thomas Jones (1756–1807) was Head Tutor at Trinity and an outstanding teacher of mathematics (WS27). John Dawson (1734–1820) was both a mathematician and a surgeon. He tutored 12 students to become Senior Wranglers (Toppers in Mathematics Tripos Examinations in Cambridge University). He studied the orbit of the moon, corrected serious errors in the calculations of the distance of the earth from the sun, and confirmed an error in Newton's precession calculations (WS28). Thomas Jones' advisors were Thomas Postlethwaite and John Cranke (WS29). Postlethwaite (1731–1798) was an English clergyman and Cambridge mathematician, who became Master of Trinity in 1789, and university Vice-Chancellor in 1791 (WS30). John Cranke (1746–1816), also an English mathematician and clergyman, became a Fellow of Trinity in 1772, and acted as a tutor in mathematics (WS31). Postlethwaite's advisor, Stephen Whisson (1710–1783) (WS32), was a tutor at Trinity, and coached 72 students in the 1744–1754 period. Advisor to John Cranke is unknown (WS33).

Stephen Whisson's advisor was Walter Taylor (1700–1744) – a Fellow at Trinity who coached 83 students. He was later appointed as the Regius Professor of Greek (WS34–35). Robert Smith (1689–1768) – advisor to Walter Taylor – was an English mathematician and music theorist, who became Master of Trinity, and Plumian Professor of Astronomy (WS36). His adviser was Roger Cotes – an English mathematician with an FRS (1682–1716), and advisee of Sir Isaac Newton. He proofread the second edition of Newton's famous book, the *Philosophiæ Naturalis Principia Mathematica* (Principia). He first introduced what is now known as Euler's formula, and invented the Newton–Cotes formulas. He was the first Plumian Professor at Cambridge (WS37–38).

Cotes' advisor – Sir Isaac Newton (1643–1727) was an English physicist, mathematician, astronomer, and natural philosopher – one of the most influential people in human history. His 1687 publication of the *Principia* is among the most influential books in the history of science, laying the groundwork for most of classical mechanics. Newton built the first practical reflecting telescope, developed a theory of colour, formulated an empirical law of cooling and studied the speed of sound. In mathematics, he is credited, with Gottfried Leibniz, for developing differential and integral calculus (WS39–40). He was a Fellow of Trinity, President of the Royal Society, Lucasian Professor at Cambridge, and Master of the Royal Mint.

Newton had two advisors: Benjamin Pulleyn and Isaac Barrow (WS41). Barrow (1630–1677) was an

English mathematician who contributed to the early the development of infinitesimal calculus, and discovered the fundamental theorem of calculus. Newton went on to develop calculus in its modern form (WS42); Barrow was a Fellow and Master of Trinity, and the first Lucasian professor at Cambridge. While his mentor at Cambridge was James Duport, Isaac Barrow learnt mathematics by working under Vincenzo Viviani in Florence, and Gilles Personne de Roberval in Paris (WS43). Viviani (1622–1703) was an Italian mathematician and scientist, a pupil of Evangelista Torricelli and a disciple of Galileo Galilei. After Torricelli's death, Viviani was appointed to fill his position at the Accademia dell'Arte del Disegno in Florence. In 1660, Viviani and Giovanni Alfonso Borelli conducted an experiment to determine the speed of sound. Timing the difference between seeing the flash and hearing the sound of a cannon shot at a distance, they calculated a value of 350 m/s, considerably better than the previous value of 478 m/s obtained by Pierre Gassendi. In 1661, he experimented with the rotation of pendulums, 190 years before Foucault (WS44). Viviani's advisor was Galileo di Vincenzo Bonaiuti de' Galilei, or Galileo Galilei, as commonly known (WS45). Galileo (1564–1642) was an Italian physicist, mathematician, astronomer and philosopher who played a major role in the Scientific Revolution. His achievements include improvements to the telescope and consequent astronomical observations, and support for Copernicanism. Galileo is called 'the father of modern science' (WS46). The motion of uniformly accelerated objects was studied by Galileo as the subject of kinematics. His contributions to observational astronomy include the telescopic confirmation of the phases of Venus, the discovery of the four largest satellites of Jupiter, and the observation and analysis of sunspots. Galileo also worked in applied science and technology.

Galileo's mentor was Ostilio Ricci (1540–1603) – (WS47) an Italian mathematician and a professor in Florence at the Accademia delle Arti del Disegno. Galileo was enrolled at the University of Pisa, in order to study medicine. Instead, he became more interested in mathematics after meeting Ostilio Ricci (WS48). Ricci studied under Niccolò Tartaglia Fontana (1499/1500–1557), who was a mathematician, engineer, surveyor and bookkeeper from the Republic of Venice. He was the first to apply mathematics to investigate the paths of cannonballs, his work later validated by Galileo's studies on falling bodies. He was largely self-taught, which perhaps explains why his mentors could not be traced (WS49–50).

A striking feature of this lineage is the remarkable consistency in the quality of creative outputs of its members. It would be interesting to find out what the messages from the mentors have been, and whether a

consistent set of messages emerge. Some mentors have been outstanding in nurturing students. For instance, Ralph Fowler –mentor of Mott – guided 64 students, 15 of whom became FRS, and 3 won the Nobel Prize! My research points to the curiosity and readiness of these people to ask questions, irrespective of the area of enquiry, as a major driving force. While this lineage mainly has researchers in natural sciences, exploring design creativity should focus on designer lineages.

3.2 Creative Milieus

We looked into three very different milieus: all three are identified as important cultures of creativity in (Larsson, 2002). In Cambridge University - first environment explored – the colleges, the meadows, the river and its long walks seem to play an important role in fostering creativity. One tradition in Cambridge has been to build cultures that promote communication. Max Perutz and Piotr Capitsa – both Cambridge Nobel Laureates – tried to create such environments. As Max Perutz writes in (Larsson, 2002): “Experience had taught me that laboratories often fail because their scientists never talk to each other. To stimulate the exchange of ideas, we built a canteen where people can chat at morning coffee, lunch and tea...it was a place where people would make friends. Scientific instruments were to be shared, rather than jealously guarded as people’s private property; this saved money and also forced people to talk to each other.” According to Perutz, “...hierarchical organization, inflexible bureaucratic rules, and mountains of futile paperwork” can kill creativity.” According to (Larsson, 2002), “Eagerness for discovery and joy of work thrive at Cambridge.” While there is extreme competition, there is also the lure of interacting and working with many creative people. Kapitsa writes (Larsson, 2002): “When I worked in England, I found the most interesting conversations on the throbbing problems of science were held at college dinners. We used to discuss there problems that embraced many areas of science at one and the same time, and this was the best way of broadening our horizon and of comprehending the current significance of this or that scientific thought.” The variety of discussions one can have across disciplines is staggering, as one poet in Cambridge comments (Larsson, 2002): “At dinner I discuss the latest discoveries of astronomy with one of England’s leading physicists, next morning I arrange a poetry reading session with a well-known Kenyan author. Each new meeting inspires my creativity...”

Santiniketan – meaning ‘Abode of Peace’ in Sanskrit – is a place in West Bengal, India, where great Indian poet Rabindranath Tagore, the first Nobel Laureate from Asia, founded in 1921 a university

called Visva-Bharati. Abhorring his distasteful experience with schooling that taught regimentation rather than openness, Tagore wanted to “tie into the tradition of the Ashram – a spiritual and cultural center where students were educated outdoors” (Larsson, 2002). The university embraced music, dance, and art, as well as language instructions and modern science, as part of its holistic curriculum. The university was intended to become a cultural centre for the whole of Asia, and reinforce common ties among all nations. Santiniketan became well-known to researchers and artists from around the world, the informal and open relationship between students and teachers making it attractive. Nobel Laureate economist Amartya Sen attended the school in Santiniketan as a boy. The messages of Santiniketan are its openness of communication, and learning outdoors with nature.

“Copenhagen Spirit” – *Der Kopenhagener Geist* – coined by Heisenberg – became a research approach and an expression of the atmosphere that prevailed in the circle around Neils Bohr. He had the unusual ability to encourage ideas in others, and spot and nurture young talents with promise. Scientists visited Bohr to discuss with him and experience the milieu in which he worked, and were “infected with the feeling that they had participated in something great...” Bohr loved to converse with other physicists, engaging in prolonged discussions. The atmosphere in his institute was intimate and “unusually informal for the time – nothing else mattered except the ability to think clearly” (Larsson, 2002).

This provides a brief exploration of but three institutions that aimed at nurturing scientific and artistic creativity. There are many others; we need to identify and analyse them, look for the messages they live to pass on, and distil what can be learnt from these. Even though these were established at different era and matured over different durations, the message is remarkably similar – bring the best, varied minds, and provide an atmosphere that allows them to interact in the most open, unobtrusive manner. I wonder what messages are waiting to be discovered from the varied cultures of design creativity as we explore their souls.

3.3 Creative Individuals

We looked into five very different individuals. Each has proved his creativity in some area (all are Nobel Laureates), and came from a variety of disciplines.

Arne Tiselius, a Nobel laureate in chemistry in 1948, created new and hitherto unknown combinations from several known phenomena (Larsson, 2002). This involved transferring ideas from many disciplines. From his mentor Theodore Svedberg, Tiselius grew an interest in the study of large compound molecules

using physical methods, e.g. how various materials move through a solution under the influence of an electric current. Since different proteins move through electric fields at different speeds, such methods could be used to differentiate between these, enabling analysis of compositions of different biological samples – a process known as electrophoresis. Tiselius also developed instruments – a tradition influenced by his mentor Svedberg who made many discoveries using new instruments he developed. Tiselius believed that bringing researchers from various disciplines and encouraging them to “brainstorm” together, would enable cross-pollination of ideas.

Our second individual is Erwin Schroedinger – a Nobel laureate in Physics in 1933. A number of physicists including Schroedinger were dissatisfied by Bohr’s atomic model which in their view was incomplete. While originally searching for a more comprehensive theory to explain quantum effects, Schroedinger did not persevere long after becoming a professor at Zuerich, with teaching and administration taking most of his time, until he came across the PhD work of Louis de Broglie in 1925 who proposed that quantum phenomena might be traceable to wave motion associated with the electron paths in an atom. Schroedinger sprang into action, and during the 1925 Christmas vacation, could formulate an initial version of his theory of wave mechanics (Larsson, 2002).

Rabindranath Tagore used a simple slate as a tool for releasing his creative powers. He spoke of the great relief he felt as he began to write on a slate instead of in a manuscript book. “While the manuscript book demanded him to fill it with something valuable, the slate freed him from these demands, as everything could be erased in one stroke” (Larsson, 2002). He felt that the poetic style forced upon him limited his creativity. He had to spend time alone to get out of his rut. In one morning after such silence, for instance, inspiration gushed out, as in a religious experience, giving birth to his poem – Nirjharer Swapnabhanga (The Fountain’s Awakening) (Larsson, 2002).

Playful curiosity characterised Richard Feynman’s work. When he returned to academia after World War II, in spite of hard work, he could make little progress in his research. As he analysed successes of his past, he realised that his playful attitude towards work was the driving force of his research. Once he went back to this, his research began to show successes, finally leading to a Nobel Prize in physics (Larsson, 2002).

The last individual we look into is Yusunari Kawabata – Nobel laureate in literature in 1968. As described in (Larsson, 2002), Kawabata favoured an “austere esthetic”. The major themes of his work are love, death, loneliness and beauty. As a youth, Kawabata wanted to be a painter, but also had an intense interest in literature awakened early on, as

evidenced from a journal he kept. The contents of the journal capture his feelings of sorrow and loneliness that marked his childhood – from his loss of parents when he was a few days old and his growing up in an isolated farm with his maternal grandparents. As put in by Larsson (2002): a “melancholy mood came to characterize his future production.”

What can we learn about creative motivation from these experiences? One is the influence of *teachers* in motivating and developing particular skills, as with Tiselius. Another is the *belief* of the researcher: that bringing researchers from multiple disciplines and brainstorming is good for creativity. Yet another is the role that being in contact with others’ work plays, and the importance of a *prepared mind* to act upon it – as it was for Schroedinger. Yet another is the role played by the *medium* of work – as slate was to Tagore. Yet another is the importance of *being with oneself* – “relief from demands” – that gives time for incubation. *Playful curiosity* – as Feynman puts it, is another motivation for creativity. We also see the influence of *childhood* – as in the case of Kawabata – how the growing up influenced the mood of his creative work.

4 Conclusions as Beginnings

Taking ability, effort and opportunity as three major drivers of creative success, and taking knowledge (of domain and process, described in our earlier work as knowledge and flexibility respectively) and motivation (for developing and actualising knowledge), we propose here that research into design creativity should investigate the nature of knowledge, motivation and their synergistic interactions. We also argue that knowledge and motivation are capable of influencing primarily ability and effort; opportunity remains largely beyond its scope. We then propose motivation and its influences on creativity as a major direction for design creativity research, and suggest three research approaches: exploring creative lineages, milieus and individuals. Using scientific creativity as an example, we explored one creative lineage, three milieus, and four individuals, with the aim of demonstrating that interesting insights could be obtained from taking on these approaches. These are but a few instances, but still provide interesting insights, and indicate that exploration of a larger group of cases – especially in design creativity, could produce a larger and stable set of insights into motivations for design creativity.

References

- Amabile TM, (1983) *The Social Psychology of Creativity*. Springer-Verlag: New York
- Chakrabarti A, (2006) Defining and supporting design creativity. Keynote In International Design Conference (Design 2006), Dubrovnik, Croatia, 479–486
- Csikszentmihalyi M, (1997) *Creativity: flow and the psychology of discovery and invention*. Harper Perennial
- Davis GA, (1999) *Creativity is Forever*. 4th Ed., Kendall Hunt: Dubuque Iowa
- Gladwell M, (2008) *Outliers: the story of success*. Allen Lane: London
- Larsson U, (Ed.) (2002) *Culture of creativity: The centennial exhibition of the Nobel prize*. Science History Publications/USA and the Nobel Museum, Revised Ed.
- Lewis D, (1981) *You Can Teach Your Child Intelligence*. Souvenir Press Limited: London
- Maslow A, (1954) *Motivation and personality*. Harper and Row New York: New York
- Osborn AF, (1963) *Applied imagination: Principles and procedures of creative problem solving (Third Revised Edition)*. Charles Scribner's Son: New York
- Prince G, (1970) *The Practice of creativity*. Harper & Row
- Sarkar P, (2007) *Development of a Support for Effective Concept Exploration to Enhance Creativity of Engineering Designers*. Ph.D. thesis, Indian Institute of Science, Bangalore, India
- Sarkar P, Chakrabarti A, (2007) *Development of a Method for Assessing Design Creativity*. International Conference on Engineering Design (ICED07), Paris, France
- Saunders R, Gero JS, (2001) *Artificial creativity: A synthetic approach to the study of creative behaviour*. In *Computational and Cognitive Models of Creative Design*, Gero JS, Maher ML, (Eds.), Vol. V:113–139, Sydney, Australia: University of Sydney, Key Centre of Design Computing and Cognition
- Surely You're Joking, Mr. Feynman!: *Adventures of a Curious Character*. (1985) W. W. Norton & Co
- Terninko J, Zusman A, Zlotin B, (1998) *Systematic Innovation: An Introduction to TRIZ*. CRC Press
- Watson JD, (1968) *The Double Helix: A Personal Account of the Discovery of the Structure of DNA*. Atheneum: New York
- WS1: http://en.wikipedia.org/wiki/George_de_Mestral
- WS10: http://nobelprize.org/nobel_prizes/physics/laureates/1977/mott-bio.html
- WS11: <http://en.academic.ru/dic.nsf/enwiki/377817>
- WS12: http://en.wikipedia.org/wiki/Ralph_H._Fowler
- WS13: <http://www-groups.dcs.st-and.ac.uk/~history/Biographies/Fowler.html>
- WS14: http://en.wikipedia.org/wiki/Ernest_Rutherford
- WS15: http://nobelprize.org/nobel_prizes/chemistry/laureates/1908/rutherford-bio.html
- WS16: http://en.wikipedia.org/wiki/J._J._Thomson
- WS17: <http://www.britannica.com/EBchecked/topic/265773/A-V-Hill>
- WS18: <http://www.genealogy.ams.org/id.php?id=50701>
- WS19: http://en.wikipedia.org/wiki/John_Strutt,_3rd_Baron_Rayleigh
- WS2: <http://en.wikipedia.org/wiki/Velcro>
- WS20: <http://www.genealogy.ams.org/id.php?id=101929>
- WS21: http://en.wikipedia.org/wiki/George_Stokes,_1st_Baronet
- WS22: http://en.wikipedia.org/wiki/Edward_Routh
- WS23: <http://www.genealogy.ams.org/id.php?id=42016>
- WS24: http://en.wikipedia.org/wiki/William_Hopkins
- WS25: <http://www.genealogy.ams.org/id.php?id=42016>
- WS26: http://en.wikipedia.org/wiki/Adam_Sedgwick
- WS27: [http://en.wikipedia.org/wiki/Thomas_Jones_\(mathematician\)](http://en.wikipedia.org/wiki/Thomas_Jones_(mathematician))
- WS28: [http://en.wikipedia.org/wiki/John_Dawson_\(surgeon\)](http://en.wikipedia.org/wiki/John_Dawson_(surgeon))
- WS29: <http://www.genealogy.ams.org/id.php?id=102036>
- WS3: http://en.wikipedia.org/wiki/Paul_Gauguin
- WS30: http://en.wikipedia.org/wiki/Thomas_Postlethwaite
- WS31: http://en.wikipedia.org/wiki/John_Cranke
- WS32: <http://www.genealogy.ams.org/id.php?id=133301>
- WS33: <http://www.genealogy.ams.org/id.php?id=103066>
- WS34: <http://www.genealogy.ams.org/id.php?id=133368>
- WS35: [http://en.wikipedia.org/wiki/Walter_Taylor_\(mathematician\)](http://en.wikipedia.org/wiki/Walter_Taylor_(mathematician))
- WS36: [http://en.wikipedia.org/wiki/Robert_Smith_\(mathematician\)](http://en.wikipedia.org/wiki/Robert_Smith_(mathematician))
- WS37: <http://www.genealogy.ams.org/id.php?id=103067>
- WS38: http://en.wikipedia.org/wiki/Roger_Cotes
- WS39: <http://www.genealogy.ams.org/id.php?id=74313>
- WS4: http://en.wikipedia.org/wiki/Piet_Mondrian
- WS40: http://en.wikipedia.org/wiki/Isaac_Newton
- WS41: <http://www.genealogy.ams.org/id.php?id=67643>
- WS42: http://en.wikipedia.org/wiki/Isaac_Barrow
- WS43: <http://www.genealogy.ams.org/id.php?id=67643>
- WS44: http://en.wikipedia.org/wiki/Vincenzo_Viviani
- WS45: <http://www.genealogy.ams.org/id.php?id=133302>
- WS46: http://en.wikipedia.org/wiki/Galileo_Galilei
- WS47: <http://www.genealogy.ams.org/id.php?id=136245>
- WS48: http://en.wikipedia.org/wiki/Ostilio_Ricci
- WS49: http://en.wikipedia.org/wiki/Niccol%C3%B2_Fontana_Tartaglia
- WS5: http://en.wikipedia.org/wiki/Paul_Klee
- WS50: <http://www.genealogy.ams.org/id.php?id=136514>
- WS6: <http://www.aronline.co.uk/index.htm?issiinterf.htm>
- WS7: http://www.brainyquote.com/quotes/authors/t/thomas_a_edison.html
- WS8: <http://babylon.acad.cai.cam.ac.uk/students/study/engineering/engineer02/cefarewell.htm>
- WS9: http://en.wikipedia.org/wiki/Frank_Nabarro

Design Research and Designing: The Synergy and The Team

Yong Se Kim

Creative Design Institute, Sungkyunkwan University, Korea

Abstract. Design research receives a lot of attention these days and advancements in design realized in artifacts either as products or as services enrich our lives in real world. The relations between design research and designing including the comparisons and the synergy between them need to be addressed to advance each of the two and the two combined. Thus this panel discussion position paper presents questions on how design research can support designing in real world and how designing can help design research. Note that real world designing projects would receive many benefits when they are conducted by design researchers who developed and mastered specific design methodologies. Also real world designing projects help in identifying the directions of design research. Based on the experiences at the Creative Design Institute of Sungkyunkwan University, the synergy of design research and designing will be discussed.

Keywords: Design Research, Designing, Design Method, Design Process, Visual Reasoning

1 Introduction

Design research receives a lot of attention these days and advancements in design realized in artifacts either as products or as services enrich our lives in real world. Design research work is mainly conducted at universities and designing is mainly done by practicing designers in design agencies and manufacturing or service industry. At universities, designing projects are often done by students in their learning activities. Design methodologies, processes and tools resulting from design research forms the base in designing once these become matured with series of validation and acceptance tests done in experimental and real world settings. Those design projects conducted to support design research are often called investigative design projects, and these are important parts of design research. The relations between design research and designing including the comparisons and the synergy between them need to be addressed to advance each of the two and the two combined. Thus this panel discussion position paper presents questions on how design research can support designing in real world and how designing can help design research.

Imre Horvath of the industrial design engineering faculty of Delft University of Technology addressed various contextual aspects of design research in his invited talk at the Design Research Symposium held in Seoul, Korea in 2006 and later published in (Horvath, 2007). Later, Pieter Jan Stappers, also from Delft, argued for the positive aspects of designerly ways of approaching problems in support of design research based on the experiences at his ID-Studio Lab (Stappers, 2007).

Based on the experiences at the Creative Design Institute (CDI) of Sungkyunkwan University (<http://cdi.skku.edu>), the synergy of design research and designing will be discussed in this position paper. Also as a way to look at the desirable team of designers and researchers, the CDI team will be briefly introduced. While the arguments of Stappers are echoed here with the CDI experiences, the other viewpoint that real world designing projects would receive many benefits when they are conducted by design researchers who developed and mastered specific design methodologies is presented. Also real world designing projects help in identifying the directions of design research. For example, the level of real industry design task scope and the nature and the amount of requirements demand design research for methods and tools in systematic management of design information.

2 Creative Design Institute

The Creative Design Institute (CDI) of Sungkyunkwan University, established in 2005, has design foundation, design social sciences and design informatics teams with 12 faculty members from diverse disciplines and about a dozen of full time research staff members with doctoral and master degree-level education and industry backgrounds as well as graduate and undergraduate students. Research at CDI in its early days addressed creative design learning issues with the intent to provide personalized learning support for design students. Starting in 2008, research project to develop methodologies and tools for product-service

systems (PSS) design has launched with significant level of support from the Korean Ministry of Knowledge Economy. With the central role of CDI, the PSS design project includes participation by design consultancies and information technology companies.

While the research scope has been extended and the research team has been expanded with increasing diversity, a more meaningful change occurring at CDI is that designing projects with serious level of efforts much beyond the investigative designing project situation have been increasing. The designing projects include industry-sponsored projects to produce design results after determining design directions and those to satisfy industry sponsor's high-level requirements with in-depth analyses of consumers' desires and wants. Also CDI teams collaborate with other design consulting companies to provide systematic information on users, activities and contexts while design solutions are to be generated by those consultancies. Another kind of design projects take the role in proving the concepts of design methodologies developed by the CDI team. Most of these designing projects last for durations longer than several months. The team members of these projects are conducting research tasks as well as designing tasks. That is, they are both designers and design researchers.

3 Types of Design Projects in relation to Research Projects

We now list different types of design projects related to research projects by using various design projects conducted at CDI:

A: Design projects as prototypes or showcases of research projects:

These are the projects conducted to demonstrate the research findings, particularly in design process research. The scope and the duration of such projects would vary from a sort of "toy" project conducted for several hours to serious practical projects for several months. The bigger ones are done for their own problem solving goals and contributions, with resulting patent applications.

The projects in this category can further be classified into the following considering the primary actors of the design activity:

1. Design projects conducted by the design research team themselves
2. Design projects conducted by the design consultancies partnering with the research team

3. Design projects conducted by students.

Of course, there can be the projects where collaborations among those are made in a central manner.

The examples of these categories are:

1. Used Clothes TakeIN project for PSS Design research project.
2. Skin Care PSS project done by design consultancy Design Mu for PSS Design research project
3. Various student design project conducted at the Interdisciplinary Design course

B: Design projects with industry clients:

These are real world design consulting projects with industry clients. The scope and the duration of such projects would be determined by sponsors with initial consultation of the project team. Apparently the expectations from clients include results somewhat different from typical design consultancies. For example, the clients expect rather longer term strategies to be included as well as design solutions.

They can further be classified into the following:

1. Design projects conducted by the design research team themselves
2. Design projects conducted by students.

Specific example projects are not listed due to the proprietary aspects of these projects.

C: Design projects with public sector clients:

These are real world design projects as well, but the scope can be somewhat determined by the project team as project management cultures would be different from industry situations. Some of social service design projects being conducted at CDI would include the objectives similar to research projects in that the findings and the processes of the projects would be used in guiding design consultancies as these projects take the role of pioneering design issues less known in typical commercial worlds.

The projects in this category can further be classified into the following considering the primary actors of the design activity:

1. Design projects conducted by the design research team themselves
2. Design projects conducted by the design consultancies partnering with the research team

3. Design projects conducted by students.

The examples are:

1. SNS-based Health Care Service Design for Teenagers.
2. Integrated Service and Brand Design for Small Medical Clinics in Seoul Metropolitan City.

In both of the example projects, tight collaborations between the CDI research team and medical care experts are being made.

D: Combined design and research projects with government sponsors:

Some research projects have inherent designing activities so that new findings are used in designing with certain goals. In this kind of projects, the project team can be composed of design consultancies and research institutions where designing tasks are mainly conducted by design agencies with strong collaboration with research institutions.

An example of this category is:

- LED Lighting Design based on User Emotional Experiences

4 The Synergy between Design Research and Designing

Investigative design projects employed to analyze design processes (Park and Kim, 2007) or to evaluate some aspects in designing activities (Kim et al, 2007) would rather serve for the sake of research. Here the critical aspect is that the experiment designing project would be as similar as possible in real designing to rule out the effect of experimental settings. Thus we do not consider these projects would get any benefit from the research side.

As a way to argue for synergy between design research and designing project, a few example cases are highlighted. To demonstrate the PSS design methodology and its constituents research outcomes, a significant design project has started with used clothes reuse issues (Kim et al, 2010-b). The resulting designing outcome is a PSS called Used Clothes TakeIN which *takes* used clothes back *in* usage where totally different user experience values are achieved compared with the usual used clothes bins. This designing project was conducted by the research team who developed the E3 value concept (Cho et al, 2010) and the PSS design methods including context-based activity modeling method. With the extensive nature

of the TakeIN project, the research outcome has become matured while this totally new methods would have been applied only by the research team themselves.

Once the PSS design method has been developed, various constituent methods have been utilized in industry sponsored design projects though the projects address products only, not PSS. For example, user requirements identified through the generative tools approach have been categorized using the context-based activity modelling method where the goal contexts play the key role in organizing a few hundreds of requirement in a systematic manner. Then these requirement themes are used in determining user experience appraisal criteria. As the design tasks involve diverse issues, rather researchers approach in step-by-step organizing and documenting pays off in comparison to traditional designerly ways of doing rather than examining. In a way, more and more designing tasks would require this kind of research-oriented designers with systematic information management. In other words, design creativity would require diverse characteristics as discussed in (Kim et al, 2010-a).

Another important synergetic support that real world designing projects provide for research would be the scaling-up effect. As applied in real world scale problems, methods from design research become scaled up and the contributions of tools are appreciated.

5 The Team of Designers and Researchers

The team of designing projects to get the synergetic effect with research needs various characteristics. There exists critical role in the overall direction of the project as such team would require proper balancing in designing and research association. The tendency to move toward generating design solutions need be adjusted when methodological issues and other situations where research-oriented considerations deserve may need attention. Also those team members who are confident about the methodologies and tools that are developed in research and used in designing must be included in the team. Step-by-step application of structured design processes often can be seen as ineffective, but strong adherence to those would be needed in validating research outcomes. Without confidence, such adherence would not be expected. On the other hand, implementers who will generate and test many possibilities, rather typical designerly thinkers, would also be needed to prevent the team from remaining as research team, not designing team.

In the case of recent CDI experiences, those team members of the third characteristics come from different sources. For some projects, the implementing designers are coming from CDI internally. For others, they are from design consultancies.

While three kinds of member characteristics above mentioned are needed in a typical designing project with some ties to research, design team members who reflect more on design methods and processes would be desirable as designing tasks are getting more complex as seen in recent projects. The following hypotheses may be made. A design reasoning model has been proposed where seeing-imagining-drawing iterations of (McKim, 1972) have been detailed with primitive processes of perception, analysis, interpretation, generation, transformation, maintenance, internal representation and external representation from visual reasoning processes (Park and Kim, 2007). Would a designer good at the visual reasoning model be a better visual reasoner? Would a designer who reflects often on the processes be a more confident designer? Would a confident designer be more creative? These questions would bring about some discussions at the panel session.

6 Discussions

This panel discussion position paper intends to promote discussion on the association of designing projects and design research. Here real world designing projects with industry and public sector clients are the primary ones whose relation with research are more meaningful. Research institutions

need to be able to conduct designing projects beyond students project either with their own team members or with collaborating design practitioners. The reverse question whether practicing designers can conduct design research tasks either by themselves or in collaboration with research institutions should receive interrogation and discussion as well.

References

- Cho CK, Kim YS, Lee WJ, (2010) Economical, Ecological and Experience Values for Product-Service Systems. Int'l. Conf. Design & Emotion, Chicago
- Horváth I, (2007) Comparison of Three Methodological Approaches of Design Research. Int'l. Conf. on Engineering Design (ICED), Paris
- Kim MH, Kim YS, Lee HS, Park JA, (2007) An Underlying Cognitive Aspect of Design Creativity: Limited Commitment Mode Control Strategy. *Design Studies* 28(6): 585–604
- Kim YS, Jin ST, Lee SW, (2010) Relations between Design Activities and Personal Creativity Modes. *Journal of Engineering Design*, in print
- Kim YS, Lee SW, Kim M, Lee WJ, Park JA, (2010) A Systematic Design Methodology for Product-Service Systems and a Design Case. to appear in Int'l. Service Innovation Design Conference, Hakodate
- McKim R, (1972) *Experiences in Visual Thinking*. Brooks/Cole Publishing Company, Los Angeles
- Park JA, Kim YS, (2007) Visual Reasoning and Design Processes. Int'l. Conf. on Engineering Design (ICED), Paris
- Stappers PJ, (2007) Doing Design as a Part of Doing Research. In: Michel R, (Ed) *Design Research Now*, Birkhäuser, Basel, Switzerland

Theories on Design Creativity

Not from Scratch: The DMS Model of Design Creativity

Gabriela Goldschmidt

Influence of Environmental Information on Expert-perceived Creativity of Ideas

Daniel Collado-Ruiz and Hesamedin Ostad-Ahmad-Ghorabi

Towards a New Theory for Design Activity Reasoning

Denis Choulier

Not from Scratch: The DMS Model of Design Creativity

Gabriela Goldschmidt

Technion – Israel Institute of Technology, Israel

Abstract. Visual stimuli have been shown to have a considerable impact on design creativity, but their crucial role is not reflected in most current design creativity models. Likewise, although there is ample knowledge today about memory activation while processing stimuli and the difference between processing during creative thinking and ordinary processing, this is not echoed in models of design creativity. In this paper a model of design creativity is proposed that links among three very different entities, namely Designer, Memory and Stimuli (DMS), to account for what is believed to illuminate design creativity.

Keywords: Designer, Design creativity, Memory, Stimulus

1 Introduction

The scientific research of creativity is relatively recent, although creativity as an extraordinary gift of the human mind has attracted the attention of thinkers for many centuries. From a view of an almost miraculous phenomenon that should not be probed into, lest it be hampered, psychologists started offering explanations and models in order to better understand instances of creativity. We are well familiar with "Aha!" paradigms, which describe creativity mainly as a sudden vision of a solution to a problem, typically after a long search (Roberts, 1989). Wallas (1926) proposed the still popular notion of 'incubation' as a must in the creative process. More recently the study of creativity has been divided into separate examinations of the creative person, the creative process and the creative product (e.g., Gardner, 1988), to which some have added the creative environment (Amabile et al., 1996). Tests for the measurements of creativity have been developed (e.g., Torrance, 1988), and in parallel methods for the enhancement of creativity have been proposed (e.g., Osborn, 1953). The latter are in good currency in today's global business world, in which innovation is such a prime competitive asset.

The design community has taken great interest in creativity research as design is by definition a field in which innovation and creativity are always a high

priority; today's Design Thinking method prizes itself for promoting creative thinking in the service of corporate success. In this paper we propose a new model of design creativity, one that capitalizes on the fact that designers, who are inherently visual thinkers, make extensive use of visual images in the process of designing (we focus here on design of physical two and three-dimensional entities). We claim that visual thinking concerns input as well as output: on the one hand it entails the 'consumption' of visual images of all sorts, and on the other it rests on the production of visual representations as thinking aids such as sketches (e.g., Do and Gross, 1995; Goldschmidt, 1994; Suwa and Tversky, 1997). In this paper we do not address the generation of visual representations but center on the role of visual displays, which we aggregate under the term stimuli, in creative design thinking. We suggest that designers use stimuli all the time; they never start a design exploration from scratch but build on what they already know and what they can infer from the various stimuli they utilize, consciously or unconsciously. The model also dwells on the architecture of memory and its activation when processing stimuli. Neuroscience teaches us enough about these processes to be able to integrate them into a proposed model of design creativity.

Our model brings together person and process (but it does not address product) and it does so by connecting Designer, Memory and Stimuli. Under Designer we list the main attributes we expect to find in the creative designer; under Memory we describe the memory activation patterns that have been found to distinguish creative thinking from ordinary thinking, and under Stimuli we discuss the potential affects of different types of stimuli on design creativity. In section 2 we briefly discuss the three components of the DMS model. In Section 3 we lay out dual relationships between each pair of the model's components. We then proceed to an integrated model of the three components in section 4. Finally, section 5 consists of a brief summary and concluding remarks.

2 The Components of the DMS Model

This section outlines the components of the DMS model: Designer, Memory, and Stimuli. Since they are not of a kind, each is self-contained.

2.1 Designer

Design creativity is not either present or not present, and designers are not creative or non-creative. Rather, creativity can be plotted as a continuum, and designers may be placed anywhere on this continuum. For the sake of the current discussion we shall refer to the 'creative designer', by which we mean a designer who is considered to be more creative than average, without going into detail or attempting to measure creativity. Figure 1 describes the designer's attributes which we take to be related to creativity. We disregard most generic 'personality' (and other) attributes and concentrate on the ones related to handling stimuli. The list of attributes is hybrid, pertaining to mental abilities as well as background in terms of experience and knowledge.

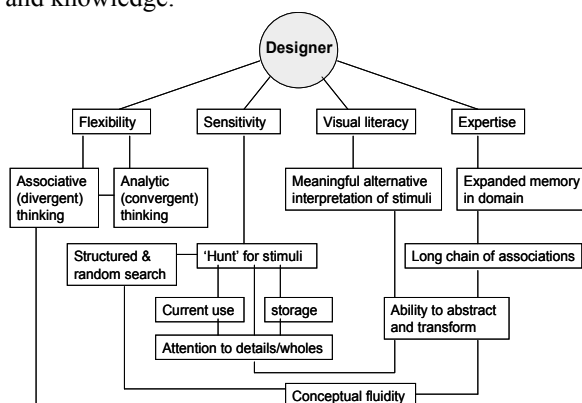

Fig. 1. Designer attributes of creativity

The first and possibly most important attribute of the creative designer is flexibility, which pertains to the ability to switch back and forth between associative, divergent thinking, and analytic, convergent thinking. Both, and shifts between them, are needed for creative outcomes. Theories of creativity tend to over-emphasize the role of divergent thinking in creativity, but as important as it is, it is not enough and the flexible shifts between the two modes of thinking are of the essential in creativity (Mednick, 1962; Mendelsohn, 1976).

The second important attribute of the creative designer is his or her sensitivity. We refer here to a special kind of sensitivity, related to the ability to infer useful information from a variety of sources including stimuli of all sorts (see section 2.3), which also

requires considerable openness to new experiences. The sensitive designer has his eyes wide open and is always ready to take in stimuli, whether in a planned manner or as a result of random encounters. Stimuli serve the designer as examples and sources of analogy, for a current target task or for storage in memory, where they remain until they are retrieved when an appropriate occasion presents itself. Many designers are in the habit of surrounding themselves with stimuli as potential sources of inspiration, and some have physical or, today, digital archives of various images and objects that await an opportunity to play a role in generating design ideas (Curtis, 1986; Keller et al., 2009; Lasdun, 1976).

Further, a creative designer must be in possession of visual literacy, which "is the ability to interpret, negotiate, and make meaning from information presented in the form of an image. Visual literacy is based on the idea that pictures can be "read" and that meaning can be communicated through a process of reading" (Wikipedia March 2010). People with good visual literacy are able to make meaningful interpretations of visual stimuli that mean little or nothing to those with low visual literacy. Combined with sensitive attention to stimuli, this allows a designer to engage in two very important cognitive acts: the act of abstraction and the act of transformation. Abstraction and transformation allow one to connect between a stimulus, which may be random, and a problem at hand, by focusing on relations among elements of the stimulus rather than on its properties alone, and by imagining transformations of those elements.

Finally, at least some expertise is required. An expert in any domain boasts an extended memory of cases and concepts in that domain, and is able to draw similarities between a current task and cases that he or she is knowledgeable about. Expertise allows us to make longer chains of associations than is otherwise possible (Chase and Simon, 1973), and this contributes to the ability to generalize and abstract. In divergent thinking, the possibility to abstract and transform, combined with the ability to pay attention to a large and sometimes random array of stimuli, all contribute to streams of thought and conceptual fluidity, which is the antithesis of fixation and an important ingredient of creativity.

2.2 Memory

Our description of memory activation patterns is perforce quite sketchy; it builds largely on Gabora (2010). The architecture of memory is a given; we hardly have any control over it, and there is nothing unique about memory activation in conjunction with

design activities, as compared to other activities. However, since we stress the role of stimuli in design creativity, we consider it essential to outline how stimuli are processed in memory (see Figure 2).

The first notable trait of memory is that it is distributed (Kanerva, 1988). This means that the storage of memory items is distributed across many memory locations (neurons), in a restricted region. The second important trait is the fact that memory is content addressable (Gabora, 2010). That is, the content of a memory item corresponds to the location (neuron/s) in which it is stored and from where it can be retrieved. As a result, items with related meaning are stored in overlapping or close locations.

Attention to a stimulus causes activation; the pattern of activation may be flat, or spiky, according to the type of attention we pay to the stimulus and the kind of thinking it evokes. A flat activation corresponds to a high level of activation, which results from de-focused attention to a stimulus or stimuli. In this case more overlapping memory locations are activated in the relevant region. De-focused attention is directed at the overall image and many of its details. In contrast, focused attention, wherein attention is paid to select details of a stimulus, results in a distribution of memory locations that are further from one another and therefore create a spiky pattern. The latter corresponds to analytic, convergent thought, whereas the former is more related to associative, divergent thought. Creativity requires variable focus, i.e. shifts between the two modes of attention. This is one aspect of memory activation that is controllable, and the ability to spontaneously widen and shrink the scope of attention and therefore the activation function, is indispensable in creative thinking (Gabora, 2010; Martindale, 1999).

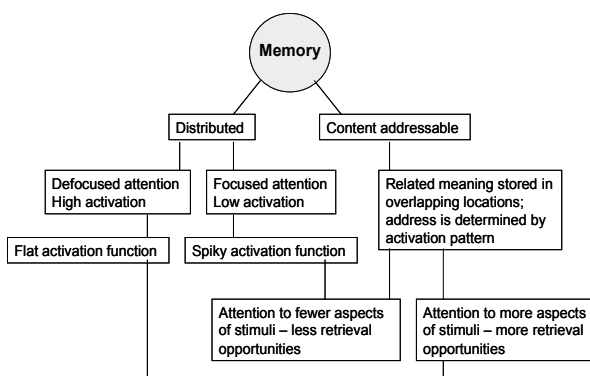

Fig. 2. Schematic memory activation architecture

2.3 Stimuli

Anything may be a stimulus. Visual stimuli can be purposefully and carefully selected as sources of inspiration, as is practiced routinely in e.g., the fashion design industry (Eckert and Stacey, 2000). But stimuli may also be random images the designer chances upon, and is sensitive enough to pay attention to, either because an association is perceived between the stimulus and a current problem the designer is preoccupied with, or because something in the stimulus is attractive or interesting enough for the designer to want to store it in memory for potential use later in time. Stimuli may be related to the domain in which the designer (or other problem-solver) works, in which case they are referred to as within-domain; they may even be actual examples of solutions to current problems. Alternatively, stimuli may be extraneous to that domain altogether, and are then called between-domains stimuli. A stimulus may be perceived in the real world, as an object or a pictorial image, or it may be an inner representation the designer evokes using mental imagery. Finally, although we address only visual stimuli in this work, non-visual stimuli may also have an affect on designers' thinking and their creativity (Goldschmidt and Litan, 2009.). There is anecdotal (Curtis, 1986) as well as experimental evidence (Casakin and Goldschmidt, 1999) that exposure to stimuli and their usage affects design creativity. Within domain images limit the scope of search in a design space, whereas between domain ones potentially widen the search, thereby allowing for opportunities to develop novel thoughts. Between-domain stimuli enhance abstraction and transformation more than do within domain stimuli. Examples of solutions have been shown to actually be detrimental to creativity, as designers find it very hard to divorce themselves from properties of such images shown to them at the outset of a design search (e.g., Cardoso and Badke-Schaub, 2009). Figure 3 is a schematic depiction of the different types of stimuli and what they afford.

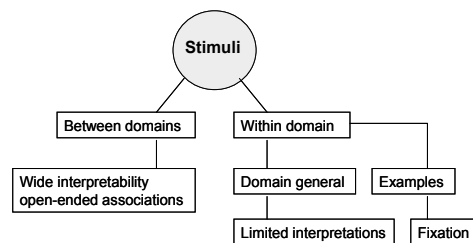

Fig. 3. Stimuli types and their effects on designing

3 Two-fold Relationships: DM, MS, and SD

In this section we outline the main relationships between each pair of the DMS design creativity model components.

3.1 Designer-Memory (DM)

The designer's flexibility to oscillate between associative and analytic thinking (roughly divergent and convergent, respectively) is responsible for shifts between flat and spiky activation functions in memory. Sensitivity and openness make it possible primarily to defocus attention (McCrae and Inghram, 1987), but also to focus attention when relevant details are picked up in a stimulus. High visual literacy is conducive to attention to more aspects of a stimulus, thereby causing more activation and more overlaps, and eventually a flat activation pattern, which allows for more retrieval opportunities. This in turn helps generate conceptual fluency in the designer's search for novel ideas. Figure 4 depicts these links between Designer and Memory.

3.2 Memory-Stimuli (MS)

Different stimuli evoke different memory activation patterns. Same task examples, and to a lesser degree other within-domain stimuli, tend to restrict attention only to certain features of a stimulus that are closely related to the problem the designer is in the course of solving. Such stimuli are therefore responsible mainly for focused attention and therefore for a spiky activation pattern. In contrast, between-domains stimuli typically generate defocused attention; more aspects of the stimulus are encoded and therefore a flat activation pattern results, and more retrieval opportunities from a wider range present themselves. These links are represented in Figure 5.

3.3 Stimuli-Designer (SD)

Finally, there are links between stimuli types and the way in which the designer acts on them, as shown in Figure 6. The more the designer is in the habit of constantly 'hunting' for stimuli as sources of inspiration, the greater the chance that random searches would lead to wide-ranging, even unexpected and possibly surprising associations between images that may emerge as sources of inspiration and aspects

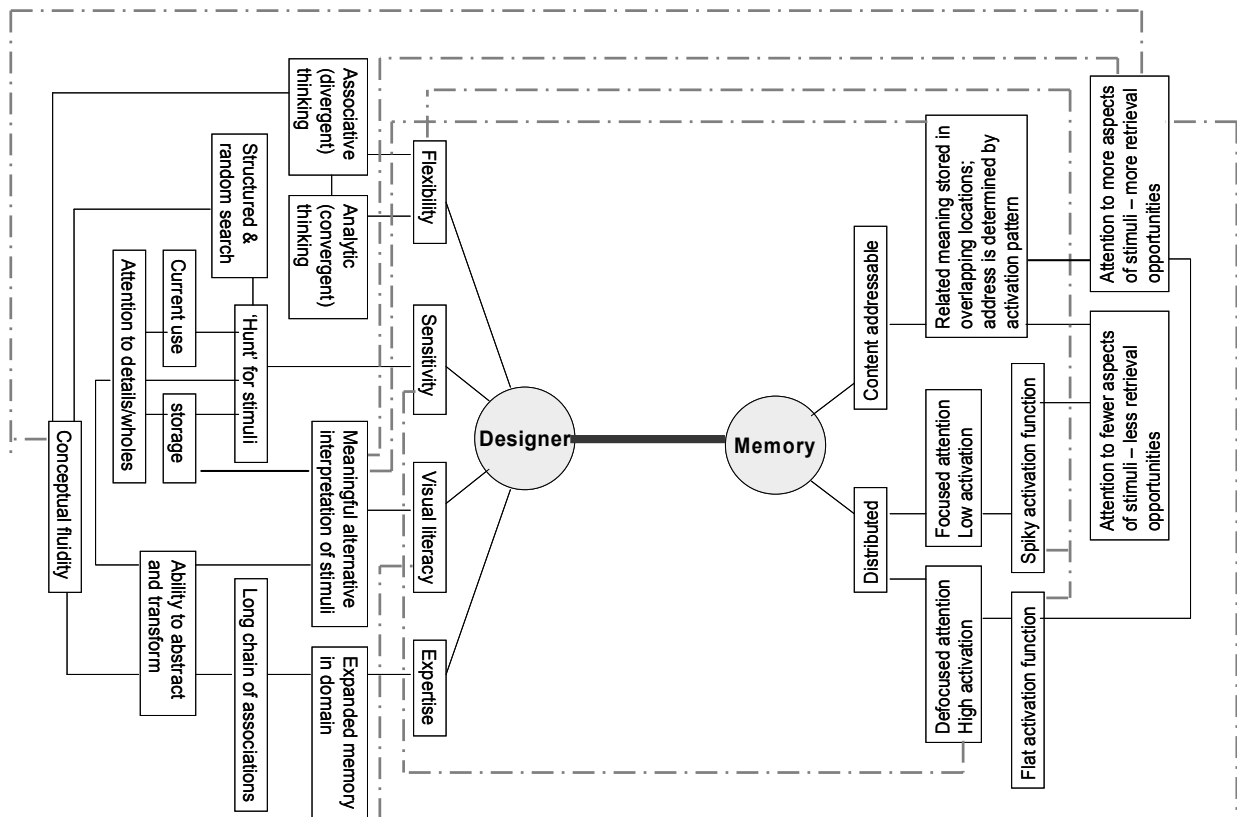

Fig. 4. Designer-memory (DM) links

of the current task. The ensuing wide interpretability of such stimuli enhances the power of abstracting and transforming them by the designer, and conceptual fluidity is thus well served.

3.3 Stimuli-Designer (SD)

Finally, there are links between stimuli types and the way in which the designer acts on them, as shown in Figure 6. The more the designer is in the habit of constantly 'hunting' for stimuli as sources of inspiration, the greater the chance that random searches would lead to wide-ranging, even unexpected and possibly surprising associations between images that may emerge as sources of inspiration and aspects of the current task. The ensuing wide interpretability of such stimuli enhances the power of abstracting and transforming them by the designer, and conceptual fluidity is thus well served.

4 Three-fold Interactions: DMS

We can now attempt to piece together the three-fold scheme of links among Designer, Memory and Stimuli, as shown in Figure 7 (last page). This remains

a sketchy and simplified portrayal of a very complex network of links, in which small variations may result in considerable differences in the overall picture. The components, sub-components and links proposed here are also devoid of any quantitative values indicative of their power: the strength of links among components may have significant effects on the overall system, but at present we are not in a position to attach weights to components or links. Clearly, many of the components of the model, and links among them, are not unique to design activities. However, the introduction of stimuli as a major component of creativity is not typical of generic creativity descriptions. It is the strong influence of this component in various physical design disciplines, and possibly in other fields such as the visual arts and possibly also certain scientific disciplines, that prompted its status as a core component of creativity in this model. We should bear in mind the hybrid nature of this network of links which, in our understanding, reflects the complexity of creative processes in which factors that are not of a kind impact each other.

Our point here is that practice appears to be way ahead of research already today. Creativity research, basic and applied, must be very much aware of this in planning research agendas.

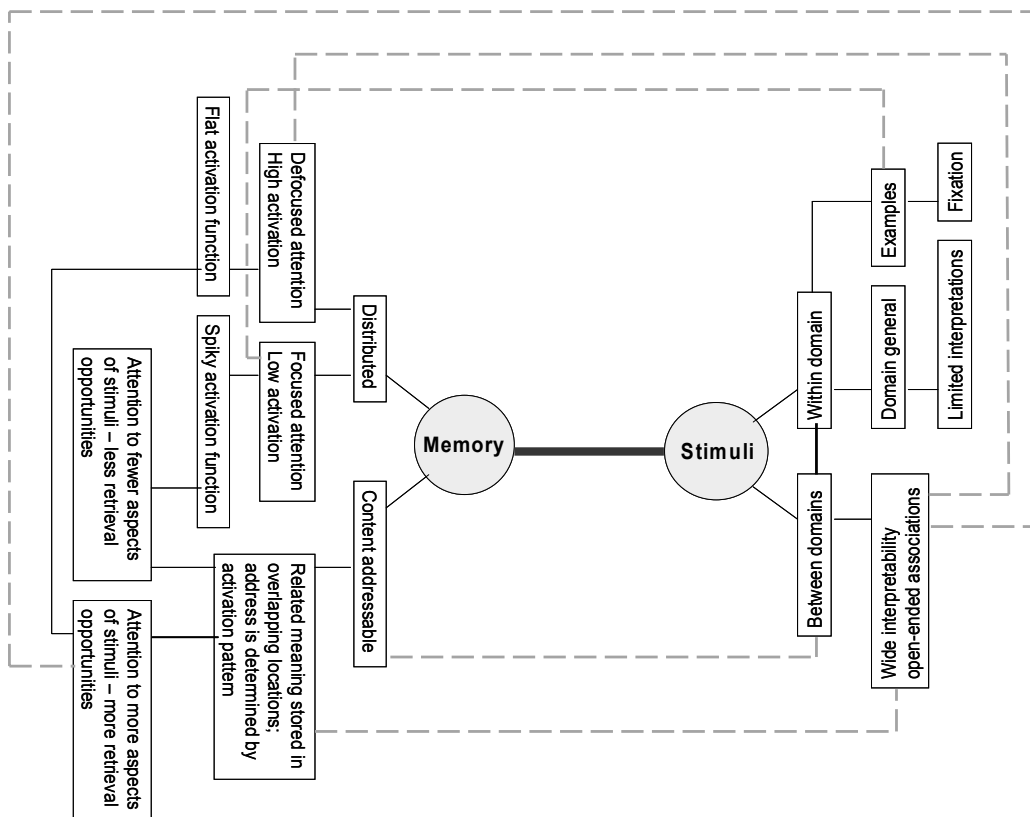

Fig. 5. Memory-stimuli (MS) links

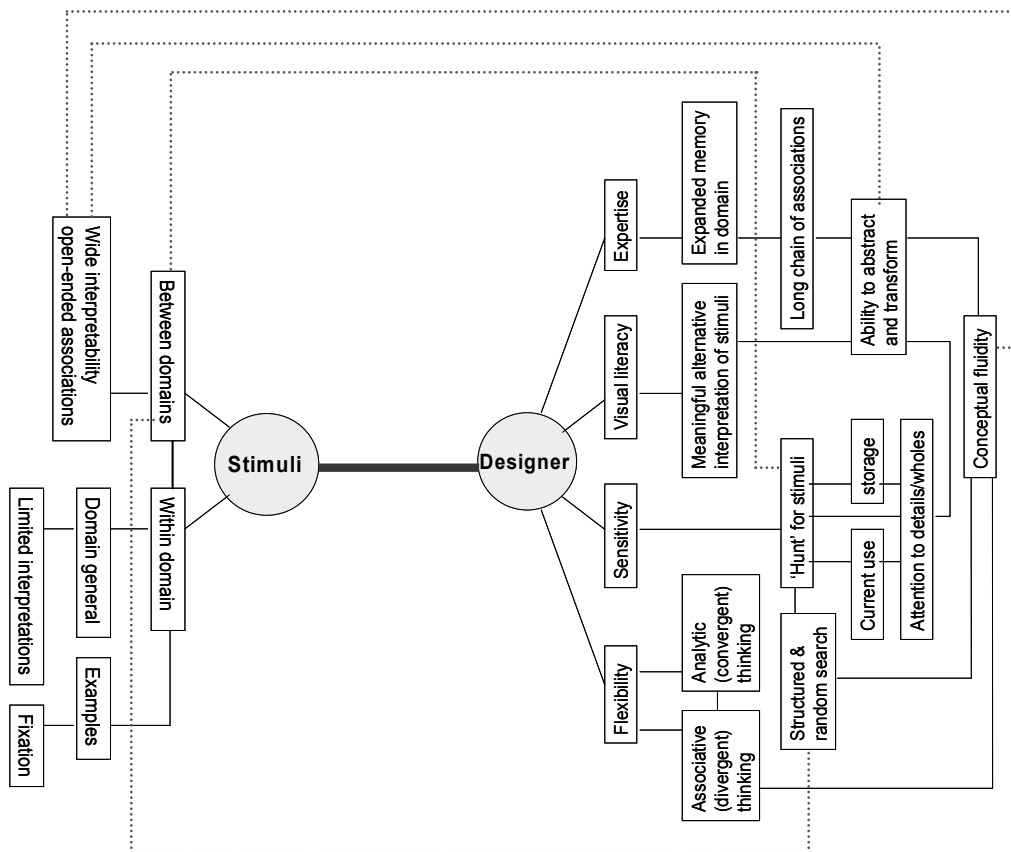

Fig. 6. Stimuli-designer (SD) links

5 In Conclusion

Creativity has been studied primarily by psychologists who are, for the most part, verbally and not visually inclined (Kaufmann, 1980). It is therefore not surprising that not enough attention has been paid to visual factors that impact creativity in certain fields, of which design is a prime example. In recent years, with a growing reverence for design creativity, considerable efforts have been made to study design creativity. That stimuli are recognized as potential influences on design creativity is evident from the growing body of research about the use of stimuli and other visual primers as a method to increase creativity (as judges by design experts). The purpose of this paper is to offer a preliminary conceptual framework that gives center-stage to stimuli as components of design creativity. This approach reflects a firm belief that designers never start from scratch. They rely on their

previous knowledge and experience, of course, but often this is not enough. If the resultant design is to be novel and creative, something has to trigger off a search in what often is uncharted territory. It is here that stimuli come into the picture: a suitable stimulus in the hands of a designer with a well prepared mind (which is a mixed bag, of course) activates memory such that new associations with items stored in memory may suggest the hoped-for solution. The proposed DMS model is rudimentary and it can and should be refined, revised and expanded. We hope to undertake this work in future research and invite others to join us in this endeavor.

Acknowledgements

The writing of the paper was partially supported by VPR grant #1007883 from the Fund for the Promotion of Research at the Technion, herewith gratefully acknowledged.

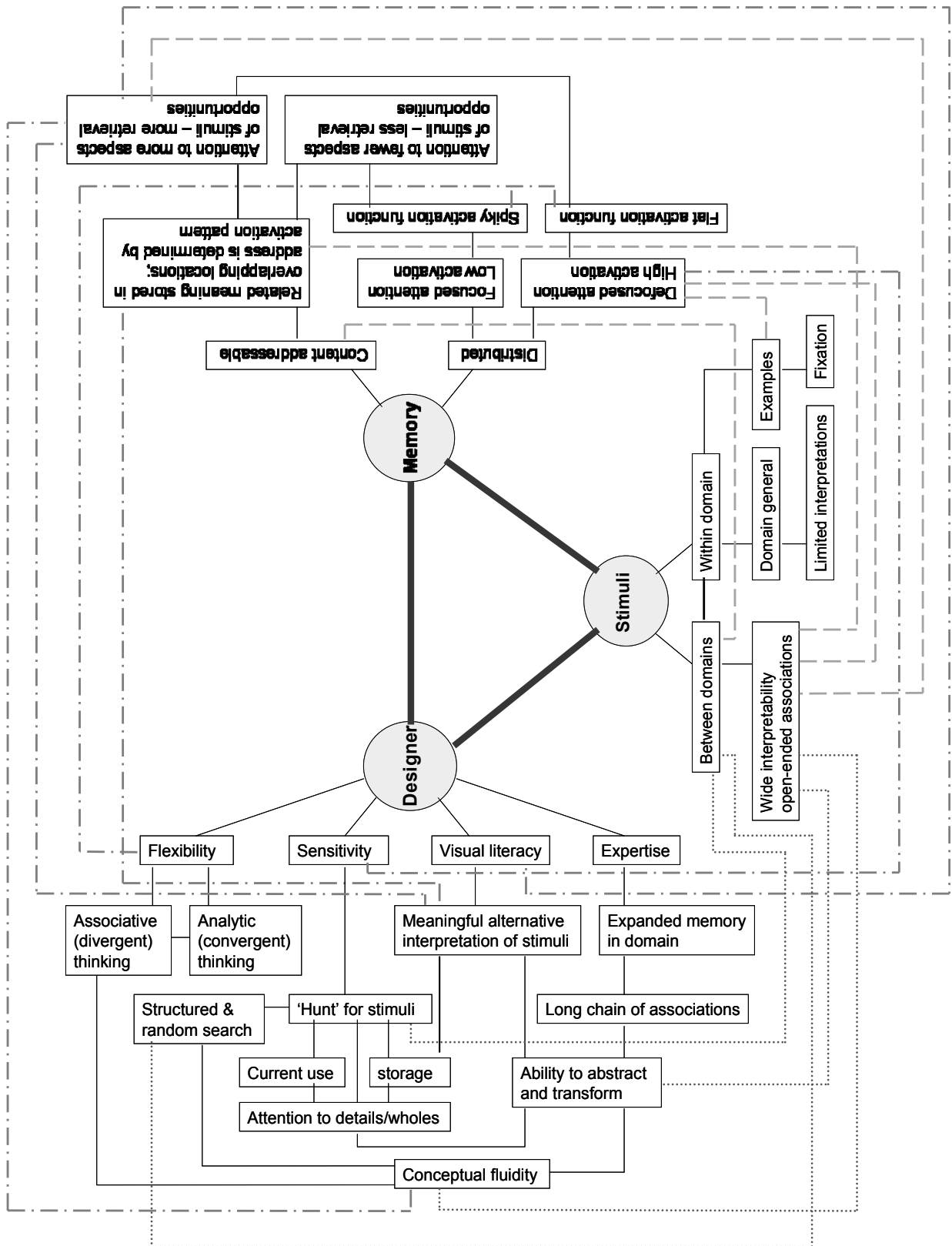

Fig. 7. Designer-Memory-Stimuli (DMS) links

References

- Amabile TM, Conti R, Coon H, Lazenby J, Herron M, (1996) Assessing the work environment for creativity. *The Academy of Management Journal* 39(5):1154–1184
- Cardoso C, Badke-Schaub P, (2009) Give design a break? The role of incubation periods during idea generation. In *Proceedings of ICED'09*, Stanford University: 2:383–394
- Casakin H, Goldschmidt G, (1999) Expertise and the use of analogy and visual displays: implications for design education. *Design Studies* 20(2):153–175
- Chase WG, Simon HA, (1973) The mind's eye in chess. In Chase WG (ed.) *Visual information processing*. New York: Academic Press Inc.
- Curtis WJR, (1986) *Le Corbusier: ideas and forms*. New York: Rizzoli
- Do EY-L, Gross MD, (1995) Drawing analogies: finding visual references by sketching. In *Proceedings of Association of Computer Aided Design in Architecture (ACADIA)*, Seattle WA:35–52
- Eckert CM, Stacey MK, (2000) Sources of inspiration: a language of design. *Design Studies* 21(5):523–538
- Gabora L, (2010) Revenge of the 'neurds': characterizing creative thought in terms of the structure and dynamics of memory. *Creativity Research Journal* 22(1):1–13
- Gardner H, (1988) Creativity: An interdisciplinary perspective. *Creativity Research Journal* 1(1):8–26
- Goldschmidt G, (1994) On visual design thinking: The vis kids of architecture. *Design Studies* 15(2):158–174
- Goldschmidt G, Litan A, (2009) From text to design solution: Inspiring design ideas with texts. In *Proceedings of ICED'09*, August 24-27, Stanford University, Palo Alto, CA: 9.15–9.26
- Kanerva P, (1988) *Sparse distributed memory*. Cambridge MA: MIT Press
- Kaufmann G, (1980) *Imagery, language and cognition*. Bergen: Universitetsforlaget
- Keller I, Visser FS, van der Lugt R, Jan P, (2009) Collecting with Cabinet, or how designers organise visual material, researched through an experimental prototype. *Design Studies* (1):69–86
- Lasdun D, (1976) *A language and a theme: the architecture of Denys Lasdun & Partners*. London: RIBA Publications Ltd
- Martindale C, (1999) Biological bases of creativity. In Sternberg R (ed.) *Handbook of creativity*. Cambridge UK: Cambridge University Press:137–152
- McCrae RR, Ingraham LJ, (1987) Creativity, divergent thinking, and openness to experience. *Journal of Personality and Social Psychology* 52(6):1258–1265
- Mednick SA, (1962) The associative basis of the creative process. *Psychological Review* 69(3):220–232
- Mendelsohn GA, (1976) Associative and attentional processes in creative performance. *Journal of Personality* 44(2):341–369
- Osborn A, (1953) *Applied imagination*. New York: Charles Scribner
- Roberts RM, (1989) *Serendipity, accidental discoveries in science*. New York: Wiley
- Suwa M, Tversky B, (1997) What do architects and students perceive in their design sketches? A protocol analysis. *Design Studies* 18(4):385–403
- Torrance EP, (1988) The nature of creativity as manifest in its testing. In Sternberg, RJ (ed.) *The nature of creativity*. Cambridge: Cambridge University Press
- Wallas G, (1926) *The art of thought*. New York: Harcourt Brace

Influence of Environmental Information on Expert-perceived Creativity of Ideas

Daniel Collado-Ruiz¹ and Hesamedin Ostad-Ahmad-Ghorabi²

¹ Universidad Politécnica de Valencia, Spain

² Vienna University of Technology, Austria

Abstract. Target setting in ecodesign generally requires of handling environmental information in the early design stages. Even if commonly encouraged in literature, recent research in the field of creativity show that exposure to models of the product can hinder creativity in the idea generation process. This paper discusses a case study where three experts in design are asked to rate the ideas previously generated by 56 students. These students had been originally delivered different types of environmental information, usually available in the early design stages. The perception of the experts regarding creativity, feasibility and originality of ideas were analyzed and conclusions are drawn for the sort of information that should be used in the early design stages.

Keywords: Creativity, Ecodesign, Life Cycle Assessment, Product development

1 Introduction

Sustainability is becoming a more and more influential aspect in design (Baumann et al., 2002; Poole and Simon, 1997) and researchers around the world have defined different approaches to deal with this challenge. The consideration of a product's environmental impact has been given profound attention in what has been called Ecodesign, Design for the Environment, Environmentally Conscious Design, Green Engineering, Sustainable Design, or Design for Sustainability amongst others (Waage, 2007; Karlsson and Luttrupp, 2006; McAloone, 2003; Coulter et al., 1995). Numerous tools are already available which can assist engineering designers in tracking the environmental contribution of their products throughout their life cycle (Lofthouse, 2006; Karlsson and Luttrupp, 2006; Finnveden and Moberg 2005; Ostad-Ahmad-Ghorabi and Wimmer, 2005; Ernzer and Birkhofer, 2002). In particular, most authors agree on the importance of assessing and improving the product's performance as soon as possible in the design process (Ostad-Ahmad-Ghorabi, 2010; Wimmer et al., 2008; Collado-Ruiz, 2007;

Karlsson and Luttrupp, 2006; Luttrupp and Lagerstedt, 2006; Lagerstedt et al., 2003; McAloone, 2003).

However, many Ecodesign strategies (Wimmer and Züst, 2003; Brezet and Van Hemel, 1997) are sometimes perceived as conservative incremental approaches, e.g. changing materials. Ecoefficiency approaches (Park and Tahara, 2008; Bastante-Ceca, 2006; Lehni, 2000) optimize current technologies, and they rarely conclude in radical innovation.

Most approaches and methods share a common trait of starting the process with some sort of environmental assessment, generally through some sort of Life Cycle Assessment (ISO, 2006; Ostad Ahmad Ghorabi et al., 2006; Goedkoop and Spriensma, 2001). For this assessment, a model of the product is necessary, even though the product has yet not been designed. Solutions to this are selecting a previous product, selecting some benchmark market product, or carrying out estimations of how the product will be.

This adds to some already known barriers to LCA implementation in the design process, such as complexity, time-consumption, uncertainty of the results or need for information, among others (Millet et al., 2007; Sousa and Wallace, 2006; Ernzer and Birkhofer, 2002). Additionally, Collado-Ruiz and Ostad-Ahmad-Ghorabi (2010) showed that the existence of a model (and most particularly a complex LCA model) can provoke the effect known as fixation (Liikanen and Perttula, 2008; Purcell and Gero, 1996). The exposure to a known product and to its assessment can provoke that new solutions proposed converge to the existing model. After all, to apply most Ecodesign strategies, some details of the product must have already been defined. If innovation is important during a particular moment, it seems that carrying out an LCA will hinder the person's creativity in coming up with innovative ideas.

The importance of thinking outside of the box or divergently exploring different solutions is often pointed out. Creativity is a key to strive towards innovative solutions. However, creativity of people has

been given much more attention than that of the process or their results (Liikanen and Perttula, 2008; Goldschmidt and Tatsa, 2005; Van der Lugt, 2003). Nevertheless, some authors have presented methods for assessing the creative qualities of a produced result, be it out of those uniform opinions of experts (Rietzschel et al., 2007; Baer et al., 2004; Dorst and Cross, 2001; Christiaans, 1992), numerical analyses (normally of fluency (Silvia et al., 2009; Preckel et al., 2006)), or self-judgment (Goldschmidt and Tatsa, 2005; Van der Lugt, 2003).

Collado-Ruiz and Ostad-Ahmad-Ghorabi (2010) measured the influence of environmental information on the creativity assessments of a group of ideas generated by 56 students for the redesign of office-chairs. Creativity of ideas was assessed by self-judgment, weighted for each subject by a subjective assessment.

However, one important question remained open: whether expert assessment of the same ideas generated in the experiment would deliver similar results? In the present paper, the authors want to explore how the generated ideas are perceived by a group of experts. Three experts in design were presented with the ideas and were asked to assess the creativity of each of them. This way, all ideas are compared according to the same standard, and the differences between standards of different experts are also considered. Conclusions will be drawn for the results gained from self-judgment and expert judgment.

2 Assessing Creativity

Creativity is a difficult term to define. It is widely used, but mostly vaguely (Kampylis et al., 2009). Most researchers agree that creativity must include the generation of ideas that are novel and appropriate at the same time. (Kampylis et al., 2009; Rietzschel et al., 2007; Goldschmidt and Tatsa, 2005; Nguyen and Shanks, 2009; Boden, 1994).

Creativity can be seen as the generation of something new and valuable for society and as the provision of new solutions to problems. For the latter case, a solution can be considered to be creative even if it has been generated somewhere else, as long as it is new and appropriate for the problem at hand. In this context, Boden (1994) refers to historical h-creativity for the first case (a unique, new idea) and psychological p-creativity for the second case (re-taking an idea from somewhere else and applying to a new problem).

Most studies focus on analyzing creativity as a trait that empowers individuals to fulfill certain tasks (Silvia et al., 2009; Preckel et al., 2006; Sternberg,

2005; Liu, 2000). For the design process it is relevant to assess the creativity of ideas rather than that of individuals. In the design field, creativity has sometimes been assimilated to “idea quality” (Goldschmidt and Tatsa, 2005; Van der Lugt, 2003). Idea quality is related to originality and appropriateness (Silvia et al., 2009; Rietzschel et al., 2007; Goldschmidt and Tatsa, 2005) or surprisingness (Nguyen and Shanks, 2009). To assess originality, experience and knowledge about existing solutions and products is necessary. To assess appropriateness in product development, feasibility or meeting market needs can be considered (Stevens et al., 1999). Surprisingness refers to the effect on the designer (or the assessor) when being presented with an idea that is both original and appropriate.

Subjective expert judgments are considered to be a common approach to measure creativity (Silvia et al., 2009; Baer et al., 2004). Subjective ratings generally provide with high inter-rater correlation coefficients, even when assessing the creativity of so-called artifacts (Preckel et al., 2006; Baer et al., 2004; Dorst and Cross, 2001; Christiaans, 1992). In this paper, the creativity of such artifacts, i.e. design ideas, were assessed by three experts.

Although the use of the term “creativity” is widespread, coming up to a specific definition pose difficulties to experts (Kampylis et al., 2009; Dorst and Cross, 2001; Liu, 2000). Sometimes “creativity” is believed to be similar or same to “novelty of ideas”. People who come up with a lot of ideas (fluidity of ideas) are recognized as being creative. The two mentioned cases would then measure “novelty” and “amount of ideas” and relate “creativity” only to these two aspects. But there are some other scales coexisting to assess creativity. Averaging scales for specific traits of ideas (Silvia et al., 2009) is one of them; assessing originality and feasibility another one (Rietzschel et al., 2007).

Another approach to assess creativity would be that of self-judgment. This approach was taken in the original experiment of the authors with the students. Since particular ideas could be perceived as very creative (disregard the fact that it might be an idea that is often repeated upon participants), assessment results could be biased. Self-assessment should not be expected to allow as strong conclusions as expert judgment (Van der Lugt, 2003).

For the assessment throughout this paper, each of the three experts was asked to assess all generated ideas. The aspects rated were originality, feasibility and creativity. To evaluate the agreement between the ratings of the experts, inter-rater reliability is determined in order to judge how much consensus there is in the ratings given by them.

3 Methodological Approach

The purpose of the paper is to define by expert assessment whether environmental information effects the creativity of the ideas generated by an individual. Furthermore, understanding of the experts of the concept of creativity will be studied, to gain insight into expert assessments techniques and their application to creativity assessment.

The original experiment done by Collado-Ruiz and Ostad-Ahmad-Ghorabi (2010) was conducted with 56 students of the Vienna University of Technology taking the subject Creativity engineering. The sample included 8.9% Ph.D. candidates, 37.5% master students and 39.3% under-graduate students, and 14.3% unknown. Their backgrounds were comprised of mechanical engineering, architecture, civil engineering, computer science, physics, chemistry, mathematics, industrial engineering, industrial design, electrical engineering and environmental science. The original task was to come up with design ideas for an office chair that would reduce its environmental impact. Five groups of students were created, each with different information. Four of the groups received environmental information, including low level of detail and low specificity (newspaper article), high level of detail and low specificity (LCA data of a competing product), low level of detail and high specificity (email from an environmental expert) and high level of detail and high specificity (LCA of the product being redesigned). The fifth group did not have any information. Table 1 gives more detail about the information packages provided.

Table 1. Information packages delivered

Type of Information	Level detail	Specificity	Length	Format
LCA own product	High	High	2 A4 pages	EPD
LCA competitor's product	High	High	2 A4 pages	EPD
Email	Low	High	1 page	Email
Newsitem	Low	Low	1 page	Article
No info	-	-	-	-

All documents were prepared so that they would take the same time to read. The LCA studies included text, figure and graphs on a two page document. Email and newspaper article consisted of pure text of one page length. All subjects were briefed together in the first 15 minutes, provided with information about the

product specification and the product's requirement. In the upcoming 45 minutes, the participants had to come up with as much ideas as possible. Participants were given additional 15 minutes to finalize and document their ideas on predefined forms, were they could title and describe the ideas and draw a sketch.

The time constraints given were considered as being adequate for all different groups. Most studies that analyze the relation of time constraints, amount of ideas produced and saturation effects study durations of 20-60 minutes, where a decline of produced ideas in the first 40 minutes can be observed (Liikkanen et al., 2009). Due to this phenomenon, similar studies stop before this time (Liikkanen et al., 2009; Tseng et al., 2008; Snyder et al., 2004). A total of 262 ideas were generated through the workshop.

For the purpose of this paper, the ideas documented on the forms were distributed to three experts in design from the Vienna University of Technology. The experts comprised researchers from the field of engineering design. Two of the experts were also in charge of designing parts and components for various industry branches.

Each expert was briefed individually. The previous experiment with the students was described. To avoid the effect of pre-judgments, not all the details of the students' workshop were given. In particular, no information was given about the source and type of information each idea was based on, as well as about the results of the self-judgment. All idea forms were distributed to each expert, who was then asked to rate each idea as to its feasibility, originality and creativity. A scale ranging from 1-5 was used for each of the parameters, with 1 for a low value (e.g. low feasibility) and 5 for a high value (e.g. high feasibility). The experts were also briefed about the parameters to be rated: for feasibility, they manifested a clear idea. The parameter "originality" was described as the idea being innovative or new. "Creativity" was left to their own perception of what creativity is. No time constraints were given to the rating of ideas.

To evaluate the agreement between the ratings of the experts, inter-rater reliability was determined. Statistical analysis was conducted using the statistical software SPSS. To assess inter-rater reliability, the Intraclass Correlation Coefficient (ICC) was calculated for each of the parameters rated by the experts, i.e. creativity, feasibility and originality. Due to the nature of the experiment (all experts rate all ideas and experts not randomly chosen), two way mixed ICC for average measure was used. Spearman's rho (ρ) was used to gain further insight into specific correlations between parameters.

Once the sample measures are clear, the effect of different information types (no information, newspaper

item, LCA of competing product and LCA of own product) is tracked for the three aforementioned parameters. Measures are grouped based on the information types, and the average rating for each parameter and idea is calculated. To check if the difference is significant, Kruskal-Wallis test is applied to study whether the samples in each group can be considered to be taken from different distributions. This test does not require normal distribution. Its null hypothesis states no difference between groups, so a significant variance proves that the groups are independent.

In case of a positive answer, Mann-Whitney U-test can be applied. It can then be checked whether each of the parameters (creativity, feasibility and originality) follow different distributions in the groups.

4 Results

A total of 262 ideas were individually rated by each expert, for the three forementioned parameters: creativity, feasibility and originality. One first step is to determine whether this information is suitable to be combined for an assesment, since conclusion will strongly depend on the degree of agreement between the experts.

ICC was calculated for each one of the parameters, to define their level of consensus. For creativity, ICC reached a value of 0.518. This constitutes some level of agreement, i.e. there is some consensus among the raters. The value, however, is not particularly high: some measures strongly diverge. Furthermore, in a five-point scale it was found difficult for the values to be the same. Feasibility was assessed with ICC=0.294, showing that a much weaker agreement existed, if any. Finally originality received an ICC of 0.551. This is higher than for creativity, and much closer to this one than to feasibility. It can be presumed that originality is perceived relatively clearly, but for feasibility, different backgrounds play a more important role.

Creativity can be understood as a combination of originality and feasibility. Nevertheless, results seem to be more aligned with the first than with the latter. For each parameter, averages were calculated.

To gain more insight in the different parameters, correlation was studied through Spearman's ρ . All relationships proved to be relevant. Table 2 shows the particular directions of the correlations. It would be expected that creativity, according to the definition seen in section 2, were positively correlated with both feasibility and originality. Nevertheless, such a strong correlation only happens for originality, with a ρ value of 0.768. Feasibility, in average, appears to be inversely correlated, which would mean that the more

feasible ideas are also considered the least creative. This inverse correlation has a lower ρ , of -0.273, which could be explained by the more well-known phenomenon (Rietzschel et al., 2007) of originality and feasibility being (sometimes) inversely correlated ($\rho=-0.379$ for the case presented in Table 2).

Table 2. Correlation between averages (Sig=0.000 for all)

Spearman's ρ	Average values for creativity	Average values for feasibility	Average values for originality
Average values for creativity	1	-0.273	0.768
Average values for feasibility	-0.273	1	-0.379
Average values for originality	-0.273	-0.379	1

To understand this effect, the opinions of different experts were analyzed individually. For expert 1, feasibility was negatively correlated ($\rho=-0.338$, Sig=0.000) to creativity, as happens with the general sample. For expert 2, correlation also existed, but of the positive sort ($\rho=0.286$, Sig=0.000). For expert 3, no correlation could be proven significant. Feasibility measures from experts 1 and 3 are also significantly correlated, but expert 2 understands feasibility differently: feasibility and originality are directly correlated ($\rho=0.136$, Sig=0.028).

The first assessment of the differences between sorts of environmental information is to perform a Kruskal-Wallis test. Whilst feasibility proved non-significant (Sig=0.651>0.05), both creativity and originality were (Sig=0.007<0.05 and Sig=0.003<0.05 respectively). This encourages a further examination of the sources of these differences. The assessment is included in Tables 3 and 4.

Table 3 shows the results of the Mann-Whitney U-test for all different groups. The group with no environmental information is seen to be extracted from a different distribution than any of the other groups. This points out that any sort of information, be it of soft or hard nature, has an effect on creativity. To assess the impact, the mean rank distances were studied. The strongest differences appear between absence of information and having a complete LCA (over 20 ranking positions, with the rest being under 15). This group is thus mostly affected by this fixation.

Table 3. Independence of distributions, for creativity

Spearman's ρ	No information	Newsitem	LCA of own product	LCA of another product	E-mail
No information		0.022	0.000	0.014	0.050
Newsitem	0.022		0.089	0.466	0.740
LCA of own product	0.000	0.089		0.350	0.068
LCA of another product	0.014	0.466	0.350		0.339
E-mail	0.050	0.740	0.068	0.339	

Table 4. Independence of distributions, for originality

Spearman's ρ	No information	Newsitem	LCA of own product	LCA of another product	E-mail
No information		0.018	0.000	0.011	0.045
Newsitem	0.018		0.025	0.156	0.975
LCA of own product	0.000	0.025		0.528	0.063
LCA of another product	0.011	0.156	0.528		0.413
E-mail	0.045	0.975	0.063	0.413	

Table 4 presents the same assessment for originality. Results are almost analogous, yet an additional relationship becomes significant: that between having general sector information from a newspaper and having a complete LCA of the product. Even though the newspaper already constitutes a first potential originality block, it still holds enough difference to the full complex model that constitutes an LCA. This newspaper group, whilst having some environmental information about product type, does not seem to be affected by such a rigid model as the detailed description of a prior model of the product.

It is of interest to compare these results with those from the paper from Collado-Ruiz and Ostad-Ahmad-Ghorabi (2010) with an analogous experiment. This

paper presents an external subjective assessment of the results instead of the original self-assessment combined by a partial expert judgment. The differences between self-perceived creativity and externally-assessed creativity (such as those commented by Dorst and Cross (2002) and Christiaans (1992)) can be seen here. In the present paper, conclusions about fixation become weaker. No significance was previously found between absence of information and what was defined as soft information. In this paper such a difference has been pointed out. Furthermore, no strong difference can be proven – when it comes to creativity – between soft or hard information. For originality, only the newsitem seemed to constitute an intermediate level.

It is important to reiterate that the results shown here spawn from an assessment that lacks strong consensus in the ratings. Conclusions are thus based on some partial common understanding. This will be considered when drawing conclusions in the next section.

5 Conclusions and Outlook

This paper has shown indices that availability of environmental information of any sort can have an effect on the creativity of the ideas generated, as perceived by experts. Existence of information about the environmental impacts –most specially in the life-cycle stages – reduces to some extent the originality of ideas, and seems to have a considerable effect on the creativity of those ideas.

Further comparison with previous results in this area (Collado-Ruiz and Ostad-Ahmad-Ghorabi, 2010) points out some strong differences between self-perceived creativity (weighted by expert assessment of a selection of ideas) and expert-assessed creativity. It appears that the self-assessed judgments of subjects having soft information are perceived as creatively as that of those having no information at all. In this paper, to the contrary, they are presented as biased in disadvantage. When it comes to LCA information, those having it seemed in the reference to be in a weaker position than those with soft information, which cannot be proven through the data in this paper.

A reading of this is that the most creative ideas generated with the newsitem or the e-mail are perceived as less creative that they are, or that the contrary happens for those generated out of an LCA. Dorst and Cross (2001) argue that difference in perception of creativity can be given by the fact that the idea (even if original) could be generated from the information available. Since the LCA information included more data, and a more detailed description, it

would be expectable that those people with an LCA would consider the modification of a part or a mechanism as a very creative idea, whilst those with a greater overview would see it as a partial improvement.

Another interpretation comes from the assessment used by Collado-Ruiz and Ostad-Ahmad-Ghorabi (2010). In that case, a weighting of the participant out of their most creative idea was used. Therefore, less creative ideas of a more creative person might be biased positively. This could point out at a higher uniformity in the creativity level of the subjects with soft information, therefore rendering them higher values.

Another source of divergence is the different background of the assessors in each case. Different understandings of creativity, different formational backgrounds, and different interpretations of the ideas could derive in very different assessments. In this paper, the assessment was carried out by experts in design, with experience in diverse fields. Those different experiences exposed them to different products and technologies, making them perceive the same ideas as more or less creative.

This is seen in their non homogeneous understanding of creativity. Although literature points out the common belief that creativity is agreed upon, or at the very least agreed on its product (Silvia et al. 2007; Baer et al, 2004; Dorst and Cross, 2001; Boden, 1994; Christiaans, 1992), in this paper the result is far from proving that. ICC values were low for all cases, showing a clear level of disagreement between the experts. Some very strong disagreements (up to 4 points in the 5-point scale) appeared. Some authors speak of an almost mystically perceived creativity, in which agreement is understood even if a common definition may be lacking. Such a phenomenon seems to occur with originality, and this factor seems to have a strong effect on the perceived creativity. However, less uniformity was seen in the later than in the first in this paper. This could be a result of the uneasy perception of the differences between both parameters (i.e. feasibility). This was indicated by the fact that all experts, when briefed, asked about the difference between the two concepts. To avoid biases, the answer given in these cases was for them to use their own interpretation of the concepts, since we were interested in knowing their opinion as well.

A particularly interesting phenomenon occurs with feasibility. Agreement proved very poor for this parameter, albeit the conviction of all experts that they had a common understanding of it. All experts had a technical background, which most probably lead them to believe in objectiveness of feasibility. However, perception of whether the idea was feasible or not was completely different between experts. Correlation

between this variable and each expert's assessment of creativity did also not show a pattern, but more likely three very different ones. For one expert, feasibility – as expected from the definition – was correlated with creativity. For another, it was inversely correlated with creativity, being more affected by the inverse correlation sometimes found between originality and feasibility. The third expert did not present any relationship between the variables.

This controversy points out the importance of the definition of feasibility. Even if the Merriam Webster's dictionary definition is "capability of being done, executed, or effected", there are different elements of this definition that can be considered with more strength, e.g. market feasibility or technical feasibility. Additionally, some experts might interpret feasibility as the possibility of something being done as a challenge, whilst others could focus on the easiness by which it will be accomplished. As such, both interpretations would be almost opposites.

Furthermore, feasibility can represent the expert's own rigidity to given ideas. In this sense, experts open to more creative ideas would be more open to considering a "wild idea" as feasible as long as they do not find a problem with it. Other more rigid experts could consider that ideas that are too different from the status quo are too wild, and therefore too unfeasible.

It is important to clarify what is understood by creativity. If experts do not agree, it is difficult to expect perceived creativity to be at the basis of an expert assessment. Self-judgments, as was seen, can also be effected by perceptual phenomena. Individual judgments will most probably be biased by the knowledge that one person has about the market of the product in particular. But trying to make the measure objective is no easy task: what is the purpose of creativity? In products, market success could be considered, but it does not seem to meet the fundamental meaning. Conclusions from Sarkar and Chakrabarti (2007) have carried out research in this direction, pointing mainly at the relevance of ideas at societal level, i.e., focusing apparently more on h-creativity than on p-creativity.

Another question that is left open is the potential effect of having a greater number of experts. Some of the effects shown here could spawn from the high variability between experts. It becomes relevant to study the effect of adding (and possibly removing) experts, paying particular attention to their domains of knowledge and their understanding of creativity.

Finally, the most relevant outlook relates to the influence in the design process: what sort of environmental information can be given to the design team – or to specific designers – so that they are informed, but not fixated? When considering originality, the newsitem – or similar levels of

information – can be seen as an acceptable compromise solution. Nevertheless, further study is needed as to the parameters of information that are more or less suitable for the design process. It is especially relevant in the early stages, most sensitive to innovation. The information needs must be defined for this point, and how this could be provided while eliminating references to models or technical solutions. Information from previous products can be of use in this endeavor.

This paper has studied the effect of fixation at individual level. Nevertheless, the design process tends to happen in teams, and team dynamics can strengthen or reduce psychological phenomena such as this one. For that reason, it is relevant to assess the correct team configurations and information distributions to maximize efficiency of the overall process.

It is important to remark that this study assess creativity and not its effects. The purpose was to develop environmentally friendlier products, but the level of “environmental friendliness” (or more technically the environmental impact) cannot be assessed at concept level. It is matter of further longitudinal studies to analyze other effects of information on this result.

All in all, this paper clarifies the risks that are inherent to the initial information stages in Ecodesign. Environmental information is important at this point, but it is just as important to keep the innovation potential open.

References

- Baer J, Kaufman J, Gentile C, (2004) Extension of the consensual assessment technique to nonparallel creative products. *Creativity Research Journal* 16(1):113–117
- Bastante-Ceca M, (2006) Propuesta metodológica para la cuantificación de la ecoeficiencia de los productos industriales a partir de la evaluación del valor funcional y de los impactos económico y ambiental. Ph.D. thesis, Universidad Politécnica de Valencia (UPV), Valencia, Spain
- Baumann H, Boons F, Bragd A, (2002) Mapping the green product development field: engineering, policy and business perspectives. *Journal of Cleaner Production* 10(5):409–425
- Boden M, (1994) Dimensions of creativity. Ch. What is Creativity, Ed. by M.A. Boden, MIT Press:Cambridge, MA, US
- Brezet H, Van Hemel C, (1997) Ecodesign: a promising approach to sustainable production and consumption. United Nations Environment Programme, UNEP
- Christiaans H, (1992) Creativity in design - The role of domain knowledge in designing. Ph.D. thesis, T.U. Delft, Lemma B.V
- Collado-Ruiz D, (2007) Propuesta prescriptiva para la impulsar la integración del ecodiseño y el diseño para el desmontaje en el proceso de desarrollo de productos. Ph.D thesis, Universidad Politécnica de Valencia
- Collado-Ruiz D, Ostad-Ahmad-Ghorabi H, (2010) Influence of environmental information on creativity. *Design Studies* 31(5):479–498
- Coulter S, Bras B, Foley CA, (1995) Lexicon of green engineering terms. In: Proceedings of the 10th international conference on engineering design
- Dorst K, Cross N, (2001) Creativity in the design process: co-evolution of problem-solution. *Design Studies* 22(5):425–437
- Ernzer M, Birkhofer H, (2002) Selecting methods for life cycle design based on the needs of a company. In: D. Marjanovic (editor). Proceedings of the Design 2002-7th International Design Conference. Dubrovnik (Croatia), 1305–1310
- Finnveden G, Moberg A, (2005) Environmental systems analysis tools and an overview. *Journal of Cleaner Production* 13:1165–73
- Goedkoop M, Spriensma R, (2001) The Eco-indicator 99: A damage oriented method for life cycle impact assessment. Methodology Report. PRe Consultants B.V.
- Goldschmidt G, Tassa D, (2005) How good are good ideas? correlates of design creativity. *Design Studies* 26(6):593–611
- ISO I, (2006) ISO 14040. Environmental management - Life cycle assessment - Principles and framework (ISO 14040:2006). CEN (European Committee for Standardisation), Brussels
- Kampylis P, Berki E, Saariluoma P, (2009) In-service and prospective teachers' conceptions of creativity. *Thinking Skills and Creativity* 4(1):15–29
- Karlsson R, Luttrupp C, (2006) EcoDesign: what's happening? An overview of the subject area of EcoDesign and of the papers in this special issue. *Journal of Cleaner Production* 14:1291–8
- Lagerstedt J, Luttrupp C, Lindfors L, (2003) Functional priorities in LCA and Design for Environment. *The International Journal of Life Cycle Assessment* 8(3):160–166
- Lehni M, (2000) Eco-efficiency: creating more value with less impact. WBCSD (World Business for Sustainable Development)
- Liikanen L, Perttula M, (2008) Inspiring design idea generation: insights from a memory-search perspective. *Journal of Engineering Design*, In press, 1–16
- Liikkanen L, Björklund T, Hämäläinen M, Koskinen M, (2009) Time constraints in design idea generation. In: Proceedings of the International Conference on Engineering Design. Stanford University, USA, 981–990
- Liu Y, (2000) Creativity or novelty? Cognitive-computational versus social-cultural. *Design Studies* 21(3):261–276
- Lofthouse V, (2006) Ecodesign tools for designers: defining the requirements. *Journal of Cleaner Production* 14(15–16):1386–95
- Luttrupp K, Lagerstedt J, (2006) Ecodesign and the ten golden rules: generic advice for merging environmental aspects into product development. *Journal of Cleaner Production* 2006(14):1396–1308

- McAloone T, (2003) Demands for sustainable development. In: Proceedings of The 14th International Conference on Engineering Design (ICED'03). Linköping, Sweden, 19–21
- Millet D, Bistagnino L, Lanzavecchia C, Camous R, Poldma, T, (2007) Does the potential of the use of LCA match the design team needs? *Journal of Cleaner Production* 15(4):335–346
- Nguyen L, Shanks G, (2009) A framework for understanding creativity in requirements engineering. *Information and Software Technology* 51(3):655–662
- Ostad-Ahmad-Ghorabi H, Wimmer W, Bey N, (2006) Ecodesign decision boxes - a systematic tool for integrating environmental considerations into product development. In: Marjanovic, D. (Ed.), Proceedings of the 9th International Design Conference - DESIGN Dubrovnik, Croatia, 1399–1404
- Ostad-Ahmad-Ghorabi H, (2010) Parametric Ecodesign: Development of a framework for the integration of Life Cycle Assessment into Computer Aided Design. Ph.D. thesis, Vienna University of Technology
- Ostad-Ahmad-Ghorabi H, Wimmer W, (2005) Tools and approaches for innovation through ecodesign - sustainable product development. *Journal of Mechanical Engineering Design* 8(2):6–13
- Park P, Tahara K, (2008) Quantifying producer and consumer-based ecoefficiencies for the identification of key ecodesign issues. *Journal of Cleaner Production* 16 (1):95–104
- Poole S, Simon M, (1997) Technological trends, product design and the environment. *Design Studies* 18(3):237–248
- Preckel F, Holling H, Wiese M, (2006) Relationship of intelligence and creativity in gifted and non-gifted students: An investigation of threshold theory. *Personality and Individual Differences* 40(1):159–170
- Purcell A, Gero J, (1996) Design and other types of fixation. *Design Studies* 17(4):363–383
- Rietzschel E, Nijstad B, Stroebe W, (2007) Relative accessibility of domain knowledge and creativity: The effects of knowledge activation on the quantity and originality of generated ideas. *Journal of Experimental Social Psychology* 43(6):933–946
- Sarkar P, Chakrabarti A, (2007) Development of a method for assessing design creativity. Proceedings of the International Conference on Engineering Design, ICED'07
- Silvia P, Martin C, Nusbaum E, (2009) A snapshot of creativity: Evaluating a quick and simple method for assessing divergent thinking. *Thinking Skills and Creativity* 4(2):79–85
- Snyder A, Mitchell J, Ellwood S, Yates A, Pallier G, (2004) Nonconscious idea generation. *Psychological Reports* 94:1325–1330
- Sousa I, Wallace D, (2006) Product classification to support approximate life-cycle assessment of design concepts. *Technological Forecasting & Social Change* 73(3):228–249
- Sternberg R, (2005) Creativity or creativities? *International Journal of Human-Computer Studies* 63(4-5):370–382
- Stevens G, Burley J, Divine R, (1999) Creativity business discipline = higher profits faster from new product development. *Journal of Product Innovation Management* 16(5):455–468
- Tseng I, Moss J, Cagan J, Kotovsky K, (2008) The role of timing and analogical similarity in the stimulation of idea generation in design. *Design Studies* 29:203–221
- Van der Lugt R, (2003) Relating the quality of the idea generation process to the quality of the resulting design ideas. In: Proceedings of the International Conference on Engineering Design (ICED'03), Stockholm
- Waage SA, (2007) Re-considering product design: a practical “road-map” for integration of sustainability issues. *Journal of Cleaner Production* 15:638–49
- Wimmer W, Ostad-Ahmad-Ghorabi H, Pamminger R, Huber M, (2008) Product innovation through ecodesign. *International Journal of Sustainable Design* 1(1):75–92
- Wimmer W, Züst R, (2003) Ecodesign Pilot: Product- Investigation-, Learning-and Optimization-Tool for Sustainable Product Development. Kluwer Academic Publishers

Towards a New Theory for Design Activity Reasoning

Denis Choulier

University of Technology Belfort Montbeliard, France

Abstract. After a short presentation of a model for design activity, the paper presents the first definitions, axioms and theorems of an explicative theory of design reasoning. The first axiom states that design uses some classical deductive reasoning, but restricts it to the determination of real parameters resulting from design parameters and also from design rules. The second axiom proposes to consider design as an activity carried out by both a "designer" and three other actors roles: a legislator, an evaluator, and a prescriber. Each of these roles has a partial vision of the artefact knowledge, can modify some (but not all) parameters, can be requested to act or react, can freely make propositions, and warrants part of the proposition. The concept of emergence is dealt with in theorems. This proposition of a new theory seems compatible with current knowledge of engineering design and its possible utility is discussed.

Keywords: Conceptual design, theory, design activity, design cognition, emergence

1 Introduction

The objective of any work in the field of design comprehension is to give account for the activity, reasoning, and design process. This can be done by reports of observations, proposals of descriptive concepts, models, or (at best) by the statement of a theory.

Giving an account for design activity first appears difficult, due to its extreme complexity (Morin, 2002). The main indicator is the absence of a unified or single theory which is able to explain design synthesis (Tomiya, 2007) or design reasoning in general. Current research in the field shows fundamentally different approaches with different languages and concepts.

As other works, this one must state its assumptions; a vision of design activity that chooses to discuss only part of it, but without neglecting other visions. Therefore, some aspects of design will be temporarily put aside. For instance, situativity (Gero, 2002), the role of the context (Eckert, 2001), and the constructivist framework (Valkenburg, 1998) will not be directly considered, neither will visual reasoning

(Goldschmidt, 2006), nor designing as a representation transformation process (Visser, 2006), even though representations, systematically present (Harrison, 1996) have a fundamental role in design, beyond their role of "external memory" (Simon, 1996). Neither will collective aspects of design be considered, even if cognition is often distributed – with difficulties due to cognitive synchronization (D'Astous, 2004) – and if socio technical aspects (Bucciarelli, 1994), (Vinck, 2003) contributes to the comprehension of design.

Design will be seen as a mapping process. This feature is common to many works in engineering design, such as Systematic Design (Pahl, 1984), Axiomatic Design (Suh, 2001), General Design Theory (Tomiya, 1987), and Quality Functional Deployment. But, as they are focused on the design process, these models and theories often confuse phases and activities, actors and product models. In a given stage aiming to produce a deliverable of defined contents, identified actors undertake activities (which are specified) on the construction of particular aspects or points of view of the product (first analyze the need, then state the functions, then criteria, then search for solutions, then ...). These assumptions are undoubtedly restrictive, and they are usually relaxed in practice.

The vision of Simon (Simon, 1996) appears very compatible with process models. But it deals more with the activity of small groups of designers (even one designer alone) involved in short cognitive processes. Simon and the authors who followed him see design as the solving of ill-defined problems.

More recently, and based on observations of real activity, design research introduced the concept of co-evolution (Dorst, 2001). Co-evolutionary approaches appear very relevant to describe the core of the activity. In particular, they present design activity as "bridging" (Cross, 2006): to design is to build and connect (elements of the different points of views on the product). The typical example is the FBS model (Function Behavior Structure) (Gero, 2002), (Vermaas, 2007). Nevertheless, ambiguities surrounding the terms can appear: coevolution problem solutions, or function structure (+ behavior + ...).

The concept of "unexpected discoveries" (Suwa 2000), has strong relations with the coevolution. They are emergent product characteristics; some are opportunities, and others generate new problems. These unexpected discoveries can be regarded as the principal reason for co-evolution. Indeed, if it is natural that the process generates and changes the product definition (Structure) in order to satisfy the functions or need, these are unexpected discoveries that explain addition, adjustment, or deletion of elements of the need and functions.

Nevertheless, coevolutive models commonly do not detail the beginning and the end of the activity. For the beginning, the concept of "framing" is used (Schon, 1983): A designer begins by building a frame, and reexamines it periodically (re-framing). A more explicit characterization considers the construction of a "prototype" (Gero, 1990). The latter includes a certain number of elements, not limited to the need. Prototypes are built by interpretation of the requirements, and refer to cases or precedents known by the designer. A prototype is a means to frame.

For the end of the activity, Simon introduced the concept of "stopping rules": the process stops depending on the objective, the current product definition, the process constraints, and limitations of the cognitive capacities. The solution to an ill-defined problem is a "satisfying solution". This term qualifies an acceptable solution, taking into account the current requirements and process constraints of the designer.

The nature of design problems, their beginning and end, the evolution of the reasoning, and that of all the points of view (coevolution) explain the fact that design is a nonprogrammable activity. Design requires "piloting" rather than management. Schon sees design as a "reflective conversation with the materials of the situation" (Schon, 1983), which can be extended to dimensions other than representations, such as time management, resources, methodological tools, other designers, ... (Choulier, 2007).

To resume, the current comprehension of design activity seems to contain various ambiguities and tensions. For instance, reflective approaches are often opposed to the resolution of ill-defined problems (Schon versus Simon), even though such a strict opposition can be purely artificial (Meng, 2009). There is a difficulty to reconcile the co-evolution with process models. Visual reasoning can sometimes be seen as an alternative to conceptual reasoning. Lastly, the practices of the various professions can differ, questioning the unity of a science of design. Moreover, there are certainly relations of dependence between the concepts used in different approaches (unexpected discoveries, co-evolution, non predictable character of design, path dependency, reflection, strategies...).

Overcoming these ambiguities could be a real achievement. This work is fundamentally built on the use of logic.

2 A Model for Design Activity

A model for design activity has first been built in (Choulier, 2008). Due to the limitations of this article, it is not possible to present it in detail, but some of its main characteristics related to the product features must be exposed, since it was a step in the theory construction.

2.1 Product Model

The first part of the model deals with the product and the elementary operations on product features. It is largely inspired by the FBS model (Gero, 2002) and by a willingness to describe logical operations (Tomiya, 1987), i.e. deduction of logical propositions whose status is defined for the current definition of the product, and abduction from target values.

All the propositions are organized in a hierarchic way (figure 1). For each "box", multiple propositions of product features can be stated. For the structural level S, propositions simply take the form "the product has the structural characteristic X". For the other levels, the propositions must include elements exterior to the product. The behavior B is defined as a response to a solicitation. Functions F are effective when a flow (of energy, information, or matter) goes from an external element to another through the product. And the "need" N is defined with reference to a user.

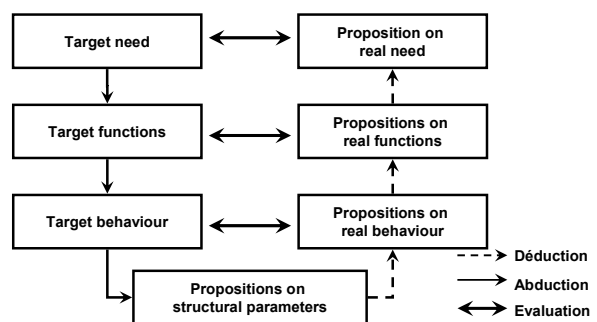

Fig. 1. Product model

The product model describes which operations can be made by a designer on product features (S, B, F, and N). They are limited to deduction, "abduction", and evaluation. Deduction is the application of design rules on propositions of features of one level to obtain

propositions on its upper level. "Abduction" covers a wide range of possible operations from classical abduction when design rules have already been stated to "wild" proposals. Stating design rules can be done before abduction, or later.

2.2 Satisfying Solution and Problem(s)

From the product model, one can state the product characteristics a satisfying solution should have. All the product characteristics should be defined. All the propositions on structure, real behavior, real functions, and real need are formulated. No target performance, function or need is left behind. All the rules have been applied. All the evaluations are positive. And, when some structural feature is not linked to any performance proposition, the designer considers that no rule must be applied to it.

A design problem will then be seen as a situation with no satisfying solution. This definition, though simple, could lead to a typology of design problems and introduce the notion of sub-problem.

2.3 Activity Model

The activity model was inspired from Schon's model. Design begins by framing / prototype building and continues with successively dealing with sub-problems, which are identified and managed by reflective observation. This activity model is not detailed here. The main characteristic is that product and process models are represented in two separate but linked models and figures; and with concepts which are different. The link is made by the definition of the term "problem". Due to this separation, co-evolution can be seen both as a co-evolution of structure and functions in the product model, and as a co-evolution of problems and solutions in the process model.

3 A Theory : First Axioms and Theorems

First, I made simplifications on the product model, considering only 2 levels (ald 4). This simplification is also a generalization, which enables the theory to be applied to any two contiguous levels in product design as well as to the design of other artifacts (immaterial products, organizations, procedures...) where the concepts of function, structure, behavior... could be interpreted. The theory is made of definitions, axioms, theorems and their demonstrations, as well as comments. Figure 2 gives a synthetic sight of the links between definitions, axioms and theorems.

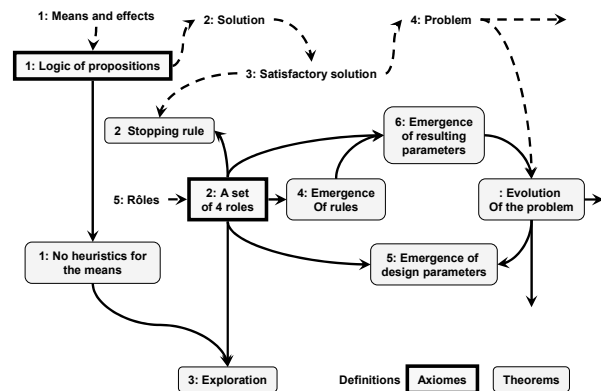

Fig. 2. Links between definitions, axioms, and theorems

3.1 A Product

Definition 1: Means and effects. An artifact is a product, system, or organization. It is described by means and effects. A means is a real disposition of an object. It qualifies what **is**. The means are described by a set of design parameters. These parameters are considered independent. An effect qualifies what the artifact **does** or should do when it acts or interacts with its environment. Differences have to be made between real effects (of an "existing" artifact) and target effects (objectives). The effects are described by a set of independent resulting parameters (This qualifier will be justified by axiom N°1). Each parameter (design or resulting) is described by:

- A definition or description.
- A value
- For the resulting parameters, specify the solicitation, and whether it is target or real.

For each design and real resulting parameter, elementary propositions are automatically built. The classical form is "The artifact has the design parameter X", or "Under the solicitation S the artifact shows the real resulting parameter Y". The status of propositions is set (true or false in binary logic). Propositions on target resulting parameters are not built.

Remarks:

Means and effects are defined as two disjointed sets of parameters: a same parameter cannot belong to the two classes. The assumptions of independence appeared necessary. In practice, there can be constraints.

Axiom 1: Logic of propositions. Relations between means and real effects are described by logic of propositions whose cases are built from the means, and the results are real effects. The rules take the following form: "IF case (= compound proposition built from elementary propositions on design parameters with the

use of classical logical operators –or, and ...), THEN result (single proposition on a real effect)".

Remarks:

There is at least one means, one effect, and one rule.

There is a strong relation between the rules and the effects. The application of one rule automatically defines the effect and its proposition (and status).

When two rules define a same resulting parameter, there is a conflict, which must be resolved by reformulating a rule.

The nature of the rules is of no importance. It will be necessary that each real resulting parameter can be given a value, but it does not matter whether the rules are formal or not, statistics, fuzzy... One could even accept an argument of authority ("I like").

In practice, there are intermediate parameters, due for example to constraints or trade-off. They can be taken into account by reformulations of rules.

The network of parameters can be either very simple (each real resulting parameter is obtained by the application of a rule on only one design parameter), or very intricate (all the resulting parameters depend on all the design parameters). Such considerations are important - See axiomatic design (Suh, 2001) - but not dealt with.

I do not consider incomplete propositions, i.e. without value. This is certainly a restrictive assumption, since one can also reason on incomplete propositions (such as "the mass depends on the length")

As for C-K theory (Hatchuel, 2009), design is seen as a construction of logical propositions. But the formalism is quite different. Especially, C-K does not state any difference between means and effects (Choulier, 2010).

Theorem 1: No heuristic for the means. The means cannot be determined from the knowledge of the target effects.

Demonstration: No assumption was stated on the system of rules, which, in fact can be incomplete, and always remains open ("apparition" of a new rule, or rule modifications).

Remark. Once defined, the means are sufficient, but non necessary conditions to obtain the effects. Nothing can suggest that, for given objectives, the means is unique, that it exists, or that there is an optimum.

Definition 2: Solution. A solution is a set of propositions on means and effects, and rules. It has the following characteristics:

- Means are described: the design parameters are defined and given a value. The proposals are built (de facto).
- The rules are known, and applied.

- (Then) Effects are described: the real resulting parameters are defined and their values are known. The propositions are built.
- No target parameter is defined without a corresponding real parameter (same definition, the value can differ) and a rule. The application from means to real effects is a surjection.
- When a design parameter has no role in any rule, this parameter is judged "neutral".

Remark. A solution is a proposal, but not evaluated.

Definition 3: Satisfactory solution. A Satisfactory solution is a solution for which the set of effective resulting parameters is considered satisfactory.

Remarks:

The adjective could be discussed. I use "satisfactory" here in order to distinguish from the notion of "satisfying solution" of Simon.

Definition 4: Problem: A problem is any description of an artifact which is not a satisfactory solution.

Corollaries. Since a satisfactory solution must meet several conditions, there are different types of problems. A problem can be either a situation where a set of real resulting parameters is considered unsatisfactory, where one (or several) target resulting parameter is defined, but without a corresponding real resulting parameter, with or without design parameters, with or without rules, where a rule is not applied, or where a design parameter has no role but is not considered as neutral.

Remarks:

A solution, a problem... are defined as states. One could obviously question the reasons for problems.

3.2 A product that the designer transforms... but he is not alone

Until now, nothing was specified for the actors who name and define the parameters, state the rules, and determine satisfaction. This will be the object of axiom N°2. Gradually, I came to define agents other than the "designer". These agents are of two types. The first type is made of automatic agents or more precisely agents that cannot decide to change the different parameters. Their functions are limited to building the propositions on design parameters, building the propositions on the real resulting parameters, and applying design rules.

In the second type, agents can not only change parameters or rules, but they also have the possibility of some initiative. Each of them is required to intervene in specific situations, but he can also modify some design attributes whenever he wants. For these

reasons, I prefer the notion of roles (Hermann, 2004). Additional roles limit the activity of the "designer" to proposition of novelty. Each of them also contributes to "warrant" some aspect of the artefact (independently of the designer). But contrary to the designer, none of them sees all artefact knowledge. Figure 3 shows the different roles with the information they have access to and they possibilities to modify parameters or rules.

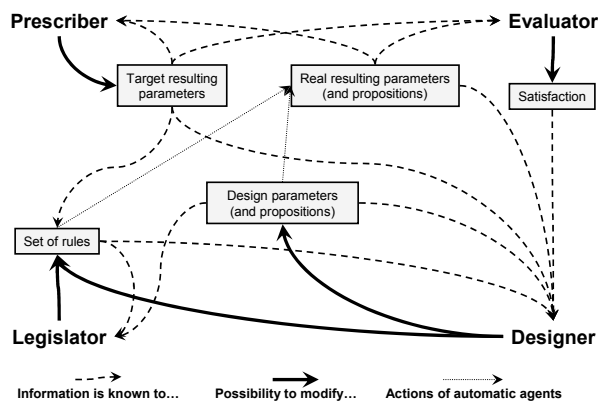

Fig. 3. Four roles for design reasoning

Definition 5: Roles:

5a: Designer. The designer's objective is to propose solutions. He knows all the information about the product (parameters of all types, rules, satisfaction). He acts as soon as a problem exists. He always can propose and modify design parameters and rules.

5b: Prescriber. His action is limited to defining (modifying, updating ...) target parameters, whenever he wants. He is informed of the target and real resulting parameters. His action is required when real resulting parameters have no corresponding target parameters, but he can then decide not to define such target parameters. He guarantees the set of target parameters (the "need").

5c: Evaluator: This role has the same information as the prescriber. He freely builds his own evaluation reference frame (and can modify it whenever he wants) and applies it to define satisfaction. He must act when couples of target and real resulting parameters are defined. He guarantees the conformity of the product with the target.

5d: Legislator: This role is informed of the rules, the design parameters and target resulting parameters. He can at any moment state or modify a rule. He must act in case of a rule conflict. He guarantees the rules.

Axiom 2. The set of roles is complete: The four roles (Designer, Legislator, Prescriber, and Evaluator) are necessary and sufficient to initiate, lead, and close design activity.

Remarks:

The rule-definition is shared between the designer and the legislator, but the designer does not guarantee them. In the case when two propositions of rules differ, the legislator will impose his definitions.

An image can help here. If design is seen as the construction of a bridge between means and effect by using rules, the role of the designer is to propose bridges. But the three other roles have the capability to create conditions for disequilibrium.

Of course, the question of collaborative design between the various roles is put forward. It will not be addressed here.

Theorem 2: Stopping rule. Once a satisfactory solution is obtained and without any action of any role, design activity stops.

Demonstration: If a satisfactory solution is obtained, the conditions for a requested action of the designer are not reached (definition 5a).

Remark: Definition 3 (Satisfactory solution) could be reformulated. A satisfactory solution is a solution (proposed by the designer) for which:

- The legislator guarantees the rules.
- The prescriber the need.
- The evaluator the product conformity.
- The four roles decide not to act.

Theorem 3: Exploration. The actions of the designer cannot be determined heuristically. He freely adapts his means to explore sets of design parameters.

Demonstration: Theorem 1 states that there is no search heuristic and the designer is the only role who can propose design parameters.

Remarks:

The means range from abduction when rules are formulated to wild propositions. Some of these wild propositions could even be made with the only objective to force other roles to (re)act.

The proposition of a rule is also a means.

This is not exactly the concept of Search (Simon), who also accounts for the strategy of resolution.

3.3 Emergence

Theorem 4: Forced emergence of rules. There are situations where rules are forced to emerge.

Demonstration: One rule for each resulting parameter. A situation where a target resulting parameter is defined without a rule cannot allow for the definition of a corresponding real parameter. The designer is forced to propose a rule (the legislator can too).

Theorem 5: Forced emergence of design parameters. Unless in the case where a new rule proposes links between existing design parameters and

a resulting one, the designer is forced to propose new design parameters, or to modify some.

Demonstration: No other possibility is allowed.

Remarks: The creation of new real definitions for an object (new design parameters) is a means to obtain a solution. But the restrictive condition (Unless...) indicates that it is a means among others. The fundamental objective of design is not to create a new artefact, but to get a solution. Alternative uses of existing objects or recycling without destroying is also design.

Theorem 6: Contingent emergence of real resulting parameters. New resulting parameters can appear from the action of the designer.

Demonstration: These discoveries are more precisely the definition (emergent) of new resulting parameters, obtained by application of new rule(s) set by the legislator.

Remark: There is a difference between the predictable consequences of a proposition (existing rule: the designer knows that a resulting parameter will be defined or changed when he proposes a change in design parameters), and consequences that depend on the decision of another role to act: The term "unexpected discovery" can be restricted to the latter.

Theorem 7: Evolution of the problem and solution.

Any action of one of the four roles can contribute to modifying the nature of the problem.

Demonstration: The designer can propose new design parameters or rules, the legislator new rules, the evaluator can modify his evaluation frame, and the prescriber add or modify target resulting parameters. But the modification of the problem can involve one or more roles – be "direct", or "indirect". Direct: The evaluator alone can change his evaluation frame and change the satisfaction; or the prescriber alone can create a problem when proposing a new target. Indirect emergence of problems can be due to the prescriber when he proposes to modify the value of an existing target, or due to the legislator when he proposes or changes the rules, or due to the designer.

Remark on the concept of "emergence" (and unexpected discoveries): From theorems 4 to 7, it is possible to propose a typology according to two descriptors.

Free actions of the roles or forced emergences. For the former, each role can freely make propositions. This emergence cannot really be "deduced", except by an interpretation of the definitions of roles. For the latter, the role is forced to make new propositions.

Predictable or contingent emergence. There are predictable consequences of some propositions. In this case, the role that makes a proposition knows that there will be a consequence: direct creation /

modification of problems, or actions of automatic agents. But there are also propositions the consequences of which depend on the decision of another actor to react – or not. Even in the case where there is an intention to provoke another actor, his reaction is not known.

3.4 Next Axioms and Theorems

From the axioms and theorems already defined, all the information (and more) on the original product model is given. But nearly nothing is said on the information relative to the process model. Key concepts such as framing, decomposition into sub problems, successive treatments of problems (strategy, focalisation), observations, movements...etc, are not dealt with. These concepts relate to the seminal works of Simon and Schon who both highlight the search process for solutions. The cognitive limits a designer must account for will be the very first element to introduce as a new axiom. The notion of cognitive economy is slightly different since it introduces a part of thinking necessary for the management of problems on a same product. And the observations 1 and 2 of Schon can possibly be interpreted as means for a designer to manage the costs of his actions.

4 Discussion

A theory states a set of proposals, accepted as true, and intended to explain or interpret certain aspects of reality. It gives an idealized representation of it.

A theory must be:

Relevant. It must define its own domain of application. Here, explain the way a designer (individual or collective) reasons in order to propose a product. But the utility of the theory is also questioned.

Internally coherent. No logical fault should appear.

Coherent with external concerns. The propositions must be compatible with existing knowledge.

Refutable. This is the classical criterion introduced by K Popper.

The last criterion is a **principle of economy**, the Occam's razor ("Entities must not be multiplied beyond necessity"). This principle recommends introducing the fewest possible assumptions and postulates. In fact, one must try to derive already known principles from a small number of first principles: the axioms. This line of action was fundamental in this work.

4.1 Refutability

The criterion of refutability must be dealt as soon as a theory is proposed, even if it is aboveall descriptive.

A first type of tests could be to observe in real situations several previsions made when stating the theory, for instance by protocol analysis (Ericson 1993). But such observations have already been made and reported in design literature, and the theory has already been built knowing such concepts.

To my opinion, the real refutability should be based on the hypothesis made. Axiom N°1 is not refutable, unless by questioning the importance of other reasoning modes in designing, such as analogy. But such reasoning modes are not put aside: they are integrated in theorem N°3. Axiom N°2 (roles), and the other theorems, is the hypothesis that can be tested: by rebuilding the design reasoning of each role from the knowledge of a product, or analysing the recording of a design session in the light of role definitions (a specific new coding scheme). But the most evident and productive test could be to build design situations with predefined roles and a protocol which prevents design agents (human) from having an action which is not allowed for their role. The possibility for such simulations is a good indicator for refutability.

4.2 External Coherence

This proposition has been largely influenced by previous design approaches, and especially mapping models and theories. The objective of designing is "to create a matching pair" (Cross, 2006). As such, it shares common features with most previous works in engineering design. The fundamental difference lies in the definitions of the terms "problem" and "solution".

Nevertheless, questions appear on the true nature of unexpected discoveries and emergences. The "unexpected" character of discoveries cannot be stated without discussing the role that makes the discovery: his objective, ability to act, knowledge... and the vision he has of the current product definition. In the proposed theory, unexpected discoveries necessarily involve several roles. But their unexpected character refers to the sole designer. The fact is that an omniscient designer who could know all the rules and parameters cannot make unexpected discoveries.... But designers are not omniscient.

4.3 Relevance and Utility

One must now discuss the scope of the theory. There are limitations due to the hypotheses. But the real question is that of its utility.

As an explicative theory, its first function is evidently to contribute to better understand and to make design more explicit. But, for designers, this objective, though limited, is very important due to the reflective nature of design. One cannot engage a reflection in action without reference models and knowledge. I believe that explicit and different (even sometimes questioning) models have the ability to question the representation that each designer builds on his own activity. Of course, the training of novices could benefit from such explicit representations.

Another function refers to the "forgotten" aspects of design, those the theory does not deal with. Even if a theory limited to the "core" of design reasoning does not "explain" these aspects, it could generate productive questions. The role notion and definitions could highlight the collective nature of design: which role a given person takes according to his involvement as a client, supervisor, actor, advisor, his hierarchic position ...? Concerning the representation too: what type of representation, what information content, and what objective...

5 Conclusions

Design is a complex activity; difficult to describe, and design research already seems to be made of multiple diverse approaches, and with some lack of compatibility between them. Setting and discussing theories is a way to question and deepen our understanding of the field.

A first model has been built with two different and linked views: a product view and a process one. The link between the them is the definition of the concepts of problem and solutions. A problem is NOT defined in functional terms (and a solution not in structural ones), but as a SITUATION, where the link between "functions" (need, functions, and behaviour) and structure is not established or not satisfying.

The first axioms and theorems of a theory are set. It appears quite refutable. Axiom N°2 is certainly the hypothesis that can be most questioned. It indicates that four roles/agents are necessary and sufficient to initiate, lead, and end a design activity. In this "role play", the designer tries to get a solution, whereas the three other roles can both create (directly or not) problems (the designer can too!), and validate some conditions of the solution. The "evaluator" qualifies the satisfaction. The "legislator" can introduce and modify rules; the "prescriber" sets targets.

The concepts of emergence and unexpected discoveries are particularly discussed and detailed since emergence is certainly the core question in design understanding: explain how novelty appears.

The utility of such a theory can be to better understand design, manage this reflective activity, teach, and, last, to question other design aspects such as the representations and collective aspects of designing.

The next development of the theory will try to integrate the concepts of Simon and Schon, who both tried to understand the design process: Cognitive limitation and cognitive economy, design strategy, decomposition (sub problems), as well as concepts such as framing, reflection, and observation (1 and 2) shall be addressed.

Acknowledgments

Thanks to the referees and to three UTBM colleagues for constructive discussions we had on first versions of this article: Egon Ostrosi (Engineering design), Mathieu Triclot (Epistemology), and Pierre Alain Weite (Engineering design).

References

- Bucciarelli LL, (1994) *Designing engineers*. The MIT press: Cambridge, Massachusetts
- Choulier D, Picard F, Weite PA, (2007) Reflective practice in a pluri-disciplinary innovative design course. *European Journal of Engineering Education* 32(2):115–124
- Choulier D, (2008) *Comprendre l'activité de conception*. Editions UTBM, ISBN: 978-2-914279-41-3
- Choulier D, Forest J, Coatanéa E, (2010) The engineering design CK theory: contributions and limits. 22nd International Conference on Design Theory and Methodology ASME/DTM, August 15-18, Montréal, Quebec, Canada
- Cross N, (2006) *Designerly Ways of Knowing*. Springer
- D'Astous P, Detienne F, Visser W, Robillard PN, (2004) Changing our view on design evaluation meetings methodology: a study of software technical review meetings. *Design Studies* 25(6):625–655
- Dorst K, Cross N, (2001) Creativity in the design process: co evolution of problem solution. *Design Studies* 22(5):425–438
- Eckert C, Stacey M, (2001) Designing in the context of fashion: designing the fashion context. In *Designing in context*. Lloyd P, Christiaans H (editors), Proceedings of design thinking research symposium 5, Delft university press
- Ericson KA, Simon HA, (1993) *Protocol Analysis: Verbal reports as data*. A Bradford Book, The MIT Press: Cambridge, Massachusetts, London, England 1984, 1993
- Gero JS, (1990) Design Prototypes: A Knowledge Representation Schema for Design. *AI Magazine* 11(4):26–36
- Gero JS, Kannengiesser U, (2002) The situated Function Behaviour framework. *Design Studies* 25(4):373–392
- Goldschmidt G, Smolkov M, (2006) Variances in the impact of visual stimuli on design problems solving performance. *Design Studies* 27(5):549–570
- Harrison S, Minneman S, (1996) A bike on hand: a study of 3D objects in design. In *Analysing design activity*, Edited by Cross N, Christiaans H, Dorst K: J. Wiley and sons.
- Hatchuel A, Weil B, (2009) CK design theory: an advanced formulation. *Research in Engineering Design* 19:181–192
- Hermann T, Jahnke I, Loser KU, (2004) The role concept as a basis for designing community systems. *Cooperative systems design*, M Zacklad & Al (Eds): IOS Press
- Meng JCS, (2009) Donald Schön, Herbert Simon and The Sciences of the Artificial. *Design Studies* 30(1):60–68
- Morin E, (2002) Le paradoxe de l'observateur-concepteur. Conference The Sciences of design - The Scientific Challenge for the 21st Century, In Honour of Herbert Simon, Lyon (France) 15-16 March
- Pahl G, Beitz W, (1984) *Engineering design: a systematic approach*. London: Springer
- Schon DA, (1983) *The reflective practitioner*. Arena, Ashgate publishing limited: GB
- Simon HA, (1996) *The sciences of artificial*. MIT press Cambridge: Massachusetts, London, England, Third edition, ISBN 0 262 19374 4 (1st edition 1969)
- Suh NP, (2001) *Axiomatic design - Advances and applications*. MIT, Oxford University press
- Suwa M, Gero JS, Purcell T, (2000) Unexpected discoveries and S- invention of design requirements: important vehicles for a design process. *Design Studies* 21(5):539–568
- Tomiyaama T, Yoshikawa H, (1987) Extended General Design Theory. In H. Yoshikawa and E.A. Warman (eds.), *Design Theory for CAD*, North-Holland: Amsterdam, 95–130
- Tomiyaama T, Schotborgh WO, (2007) Yet another model of design synthesis. 16th International Conference on Engineering Design - Design for society, Knowledge, innovation, and sustainability, 28-30 August, Paris, abstract, 83-84
- Valkenburg R, Dorst K, (1998) The reflective practice of design teams. *Design Studies* 19(3):249–272
- Vermaas PE, Dorst K, (2007) On the conceptual framework of John Gero's model and the prescriptive aims of design methodology. *Design Studies* 28(2):133–157
- Vinck D, (2003) Socio technical complexity: redesigning a shielding wall. In *Everyday engineering - An ethnography of design and innovation*, Vinck (ed) The MIT press: Cambridge, Massachusetts, London
- Visser W, (2006) *The cognitive artifacts of designing*. Lawrence Erlbaum associates, publishers: London

Design Process and Cognition 1

An Approach to Measuring Metaphoricity of Creative Design

Hung-Hsiang Wang and Jung-Hsuan Chan

Interrelations between Motivation, Creativity and Emotions in Design Thinking Processes –
An Empirical Study Based on Regulatory Focus Theory

Madeleine Kröper, Doris Fay, Tilmann Lindberg and Christoph Meinel

Conceptual Design and Cognitive Elements of Creativity: Toward Personalized Learning Supports for
Design Creativity

Yong Se Kim, JongHo Shin and Yun Kyoung Shin

An Approach to Measuring Metaphoricity of Creative Design

Hung-Hsiang Wang and Jung-Hsuan Chan
National Taipei University of Technology, Taiwan

Abstract. Metaphor is central to design creativity as it involves processes of discovering two different objects which are similar in some perspectives and combining them together into a new and meaningful one. This study argues the degree to which a design contains metaphor is a good indicator of the creativity of the design. In this paper the strength of metaphoricity is a function of feature similarity between its target and source entities, as well as the domain dissimilarity between the two entities. The situation of metaphoricity is the salience imbalance of the similar features between of its target and source entities. To test the argument, five award winners of various well-known creativity-oriented design competitions are accordingly presented to twenty-six design students to assess the metaphoricity strength and saturation, and the creativity on a subjective base. Results reveal the creativity has significantly positive relation between the object similarity and metaphoricity saturation.

Keywords: design creativity, metaphor, similarity, industrial design

1 Introduction

Metaphor is not only a style in speech and writing but a resourceful method of human's thinking in daily life (Lakoff and Johnson, 1999). It has been thought the kernel ability of creativity that helps us to creatively put two things from two different domains together into a new one (Seitz, 1997; Ricoeur, 1981). Metaphors have long been recognized to play an important role in industrial design (Hey and Agogino, 2007). Metaphor is often used at earlier stages of conceptual design to solve problems or interpret meaning in a creative way. The conceptual design starting with an initial design goal, through ideation, evaluation, and finalization can be seen as a process of defining a target, searching sources to construct pairs of the target and sources as alternatives, and selecting a satisfactory one from these alternatives.

Although there are some metaphor theories based on similarity measures, few of them have been applied to the area of design creativity. Moreover, empirical evidence supporting the positive relation between

design metaphor and design creativity has rarely been reported. Therefore, this study aims to provide empirical evidence regarding design metaphor measures and its implications to design creativity. Quantitative results of questionnaires for assessing design metaphor and creativity are presented following a short literature review.

2 Metaphoricity in Design

2.1 Metaphorical Design

Metaphors are represented by the form "A is B", where B is called the source of the metaphor, and A is the target. Metaphor can be used for understanding of an unknown situation A in terms of one familiar thing B (Gentner 1983; Gentner and Markman, 1997; Novick, 1988; Vosniadou, 1989; Ortony, 1993). Interpretation of a metaphor is a process of discovering which features of the source may be valid and useful to understanding the target. To construct such a metaphor, one needs to find out the source B that is similar to the target A in some perspectives but dissimilar to each other in terms of membership of certain categories. The similarity maintains a reasonable mapping from the source B to the target A, while the dissimilarity promises an unusual mapping. The search for sources is thus described as a mapping of the target and sources based on their common features. As long as the mapping is reasonable but unusual to a certain degree, the conceptual design is said to be creative in terms of the processes or the products. A creative design is identical to a both new and meaningful design.

Take Alessi's Anna G corkscrew, designed by Alessandro Mendini for example. The main goal of this project is to design a new object that belongs to the target domain of wing corkscrew. As it has the salient feature of two wing-like levers, it also called an angel corkscrew or butterfly corkscrew. Thus, dancers are selected as the source domain, and a female

dancer's body elements that are similar to the parts of a wing corkscrew are identified. On one hand, that the similarity between the wing corkscrew and an dancing woman make a reasonable mapping. The pairs of their similar features include (1) the handle of the corkscrew and the head of the angle, (2) the two levers and the two arms, (3) the rack and pinion connecting the levers to the body and the puff shoulder lace dress, (4) the motion in which the levers are raised as the worm is twisted into the cork, and the action of the angle's raising arms while dancing, as well as (5) the smooth motion of pushing down the levers to draw the cork from the bottle and the elegant putting down arms. On the other hand, the similarity between human dancers to tools in household use is so low that the mapping is unusual. As a result, we can say Anna G corkscrew is a creative product because of good metaphor.



Fig. 1. Anna G corkscrew (left) and the woman in puff shoulder lace dress (right). (adapted from <http://www.alesi.com> and <http://www.costumediscounters.com/womens-costumes>, respectively)

2.2 Metaphor and Design Creativity

Metaphor is a very useful tool in creativity, not only in designing creative interface for effective and efficient use, but also in dreaming up both new and valuable ideas. Creativity enables designers to transcend conventional knowledge domain so as to investigate new ideas and concepts which may lead to creative solutions. As a metaphorical design is typically based on a reasonable and unusable mapping from source domain to target domain to represent some distinctiveness and meaningfulness, it has importance in design creativity. Statistically assessing the metaphors used by students in design creativity, Casakin (2006, 2007) determines synthesis of design solutions is the stronger factor of the use of metaphors, whereas metaphors play an important role in design creativity.

Use of metaphors can contribute to designers' (1) productivity of, meaningful, interpretable and relevant ideas, (2) rarity of the ideas, and (3) comprehensiveness of the ideas. These aspects are respectively associated to the three dimensions: fluency, originality, and elaboration used to assess

divergent thinking and other problem-solving skills in Torrance Tests of Creative Thinking, developed by Torrance (1974). Furthermore, retrieving concepts from metaphors demands creative thinking. Effective and efficient indexing and retrieving the source objects that are similar to the target object, but belong to the domains that are dissimilar to the target domain are obviously related to fluency, flexibility, and originality in design creativity. Successful combination and adaptation of the features of the target and source objects are apparently associated with originality and elaboration.

3 Measuring Metaphoricity

In this paper, the metaphoricity of a design is measured by the similarity between the target object and the source object, the dissimilarity between the target domain and the source domain, and the salience imbalance of the common features of the target object and the source object. The followings describe these three factors.

3.1 Object Similarity

Similarity plays an important role in human perception (Goldstone, 1999; Kovecses, 2002; Tversky, 1977). Similarity measure used to quantify the degree of resemblance between a pair of cases (Liao, Zhang and Mount, 1998). There are many models of similarity measurement. The most common method in geometric (or spatial) models is an inverse measure of Euclidean distance. This method is suitable for continuous variables, though limited for discrete ones.

However, similarity measures are commonly used for discrete features (Everitt et al., 2001). For real data sets, it is more common to see both continuous and discrete features at the same time. In other word, a database often contains such types of variables as binary, nominal, ordinal, interval, and ratio. A more powerful method is to use a weighted formula to combine their effects. A method for measuring mixed variables is proposed by Gower (1971) and extended by Kaufman and Rousseeuw (1990). The similarity measure for objects x and y with d features with mixed data (also called d -dimensional mixed data) is defined as

$$S(x, y) = \left(\sum_{i=1}^d \delta_i S_i \right) / \sum_{i=1}^d \delta_i \quad (1)$$

where S_i indicates the similarity for the i -th feature (also called variable) between the two objects, and δ_i is Gower's General Similarity Coefficient.

The coefficient δ_i is usually 1 or 0 depending upon whether or not the comparison is valid for the i -th feature. If differential variable weights are specified, it is the weight of the i -th feature, or it is 0 if the comparison is not valid. That is, if the weight of any feature is zero, then the feature is effectively ignored for the calculation of proximities. Note that the effect of the denominator

$$\sum_{i=1}^d \delta_i$$

is to divide the sum of the similarity scores by the number of variables; or if variable weights have been specified, by the sum of their weights.

Calculation of the component similarity S_i is various with discrete and continuous variables. For the discrete variables (including binary), S_i is assigned to either 1 if $x_i = y_i$, or 0 if $x_i \neq y_i$. For the continuous variables, S_i is obtained by using the normalized city-block distance as

$$S_i = 1 - |x_i - y_i| / R_i \tag{2}$$

where R_i is the range of the i -th feature over the two objects

Again, take Anna G for example. In the two-dimensional mixed data as shown in Table 1, the target is Anna G corkscrew, denoted by x , and the source is the female dancer, denoted by y .

Table 1. Mixed variables for the target and source objects of Anna G

	Feature					
		Discrete (structural)			Continuous (behavioral)	
i-th		1	2	3	4	5
Target object	x	yes	yes	yes	0.9	1.0
Source object	y	yes	yes	yes	0.8	0.7
Coefficient	δ_i	1	1	1	2	2
Similarity	S_i	1	1	1	0.9	0.7

Note: Each i -th feature denotes as the followings.

- 1: a head-like part attached to the top of body,
- 2: two arms-like parts attached to shoulder,
- 3: puff-shoulder-like shape on each shoulder,
- 4: rotating the head-like part while raising two arms,
- 5: smooth pushing down two arms-like parts two arms.

For simplicity, let's assume that behavioral features such as rotating are twice as important as structural features such as having arms. Thus, the weights of the former are given by 2, while that of the latter 1. Furthermore, the behavioral and structural features are treated as continuous and discrete features, respectively. The range of each continuous feature is given by 1. Thus, the similarity measurement is obtained as

$$S(x, y) = (1 \times 1 + 1 \times 1 + 1 \times 1 + 2 \times 0.9 + 2 \times 0.7) / (1 + 1 + 1 + 2 + 2) = 0.89$$

3.2 Domain Dissimilarity

In addition to the similarity between the target and source objects, the dissimilarity between the target and source domains also plays an important role in metaphorical design. Winner (1985) suggests a good metaphor have a sufficiently long distance (i.e., higher dissimilarity) between the domains to which the target and source objects correspondingly belong. Casakin (2005) points out that the degree of difficulty to establish a metaphor is mainly determined by how remote the source is from the target. Michalko (2001) also determines a positive relationship between the probability of inspiring new concepts by metaphors and the domain dissimilarity.

This study measures the distance between the two classes or categories of which the target and source objects are members, respectively, to obtain the domain dissimilarity. For the target, Industrial and Business Taxonomy, developed by Ministry of Economic Affairs of Taiwan, is a practical domain classification. For example, the classes can be home accessories, 3C-electronics, transportation, fashion, and sport and entertainment. In contrast, the source domains are much more diverse. They may range from nature to artificial, from creature to non-creature, or from tangible to intangible classes.

The domain taxonomy seems to be arranged in a hierarchical structure, which is typically organized by supertype-subtype relationships. In such an inheritance relationship, the subtype by definition has the same features as the supertype plus one or more additional features. For example, corkscrew is a subtype of wine accessory, but not every wine accessory is a corkscrew. Hence, a type must satisfy more features to be a subtype than to be a supertype. Theoretically the domain dissimilarity can be computed not only by the inverted similarity, but also by the depth and width of the supertype-subtype relationships.

Sometimes it is hardly to consider such relationships because of the difficulty of specifying the consistent supertype of the target and source objects. For instance, the supertype of wing corkscrew could

be corkscrew, wine accessory, tool, or to the extreme, thing. Likewise, the female dancer could be the subtype of female, human being, mammal, animal, or to the extreme, thing, too. At this moment, it is more or less uncertain to decide which hierarchical level of supertypes. However, given that the supertypes of target and source objects have not recognized yet, we can judge the domain dissimilarity by simply estimating the distance between the undecided supertypes without naming them or specifying their detailed features. For example, we can assess this domain dissimilarity by giving a value, 0.9, for the dissimilarity between the category of wing corkscrew and the category of female dancer.

3.3 Saliency Imbalance

Besides similarity of objects and dissimilarity of domains in metaphors, the saliency (i.e., significance) of the common features between the target and source objects plays an important role. On the basis of Tversky’s (1977) notion, Ortony (1979) thinks the imbalance, denoted by $I(x, y)$, in saliency levels of matching features of the two objects is a principal source of metaphoricity. Given that the feature sets of the target object x and the source object y are A and B , respectively. The saliency imbalance of x and y , denoted by $I(x, y)$, is expressed as a linear function of the measures of their common features, and is given by

$$I(x, y) = g(f^A(A \cap B) - f^B(A \cap B)) \quad (3)$$

where $(A \cap B)$ represents the of common features of x and y , f^A and f^B represent measures of saliency based on the values in A and B respectively, and g is some, probably additive, function.

Ortony (1979) suggests that a convenient way of conceptualizing this imbalance is to visualize the features of x and y as a list with the most salient features at the top. Then saliency imbalance can be thought of as the degree of slope from features in B to features in A , and can be characterized, to a first approximation, by considering the combined effect of the difference in saliency between the matching features for x and for y together with the (independent) degree of saliency in each, as in Equation (3).

Using the concept of saliency imbalance, Ortony et al. (1985) classify four types of similarity into literal similarity, metaphorical similarity (including simile), anomalous similarity, and reversed metaphorical similarity. If the common feature saliency is both high in the target and source objects, the similarity is literal. For example, the two objects may be almost identical, or one of the objects is obviously the explanation of the other. On the contrary, if it is both low in the target

and source objects, similarity is anomalous because such a resemblance is too trivial. If the saliency is high in the source object, but low in the target object, the similarity is metaphorical. In contrast, if the saliency is low in the source object, but high in the target object, it is called reversed metaphorical similarity.

This classification can be represented in diagonal arrow lines from the saliency ranking of source features to that of target features as shown in Table 2, developed by Wang and Liao (2009). This diagram of saliency imbalance analysis allow us to (1) list as many features of the target object and the source object in salient order, respectively, (2) link the pair of two similar features by drawing an arrow line from the source feature to the similar target feature, and (3) assign the degree of similarity between the two objects on the linking lines. As the slope of these linking lines describes the degree of metaphorical similarity, this diagram is a useful tool of questionnaires for the subjects to depict their responses about metaphoricity.

Table 2. Diagram for saliency imbalance (adapted from Wang and Liao, 2009)

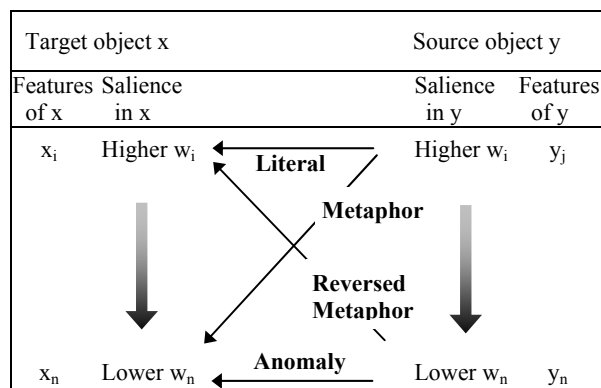

For representing the difference between the target and source objects, an exaggerative but reasonable way to deal with the saliency ranking is required. This study considers the law of diminishing marginal utility to convert the saliency ranking into a non-linear decreasing sequence as saliency weighting. There are many popular decreasing sequences, such as $1/n$, $1/2^{n-1}$, and n^2 ($n=1, 2, 3, \dots$), used for ranking transform. Wang and Chou (2010) compare the exaggerative effects of the three sequences and conclude that the decreasing sequence, $1/n$, is superior to the others. For the object x with d features, the i -th feature’s normalized saliency is given as

$$w_{xi} = (1/i) / \sum_{i=1}^d (1/i) \quad (4)$$

For example, the sequence of ranking salience, 1, 1/2, 1/3, 1/4, 1/5, is normalized into the sequence of rating salience 0.438, 0.219, 0.146, 0.109, 0.088. Furthermore, Wang and Chou (2010) propose a practical way to determine the feature salience imbalance of the target object x and the source object y as

$$I(x, y) = \frac{\sum_{i=1}^d (w_{y_i} - w_{x_i})S_i}{\sum_{i=1}^d (w_{y_i} - w_{x_i})} \quad (5)$$

where S_i is the similarity of the i -th feature of the target object x and the source object y . S_i can be obtained, as the equation (2), but not limited to this method.

By adding two features to the data in Table 1, let create Table 3 for demonstrating how to calculate $I(x, y)$. Given that we consider only features of the target and source objects, in which only five features are similar ($S_i > 0$), and the rest are absolutely dissimilar ($S_i = 0$). The normalized salience values converted from salience rankings are shown in Table 3. Thus, the salience imbalance of the objects x and y is computed as

$$I(x, y) = \frac{(0.257 \times 1 + 0.097 \times 1 + 0.052 \times 1 + 0.032 \times 0.9 + 0.022 \times 0.7)}{0.46} = 0.450 / 0.46 = 0.978 > 0$$

Table 3. Mixed variables for the target and source objects of Anna G

i-th	Feature						
	1	2	3	4	5	6	7
Similarity S_i	1	1	1	0.9	0.7	0	0
Rank.							
Salience in x	3	4	5	6	7	1	2
y	1	2	3	4	5	6	7
Norm.							
Salience: w_x	.129	.096	.077	.064	.055	.386	.193
w_y	.386	.193	.129	.096	.077	.064	.055
$w_y - w_x$.257	.097	.052	.032	.022		
$\Sigma(w_y - w_x)$.46						

3.4 Metaphoricity

As previously described, the salience imbalance, $I(x, y)$, is practical for identifying whether or not an object is a member of metaphorical design. For a typical metaphorical design, its salience imbalance value is supposed to be as greater than 0 as possible. Also, the metaphoricity strength, $T(x, y)$, of a design can be thought as a function of the feature similarity and

domain dissimilarity between the target and the source. This study defines it as

$$T(x, y) = (\alpha \times S(x, y) + \beta \times D(x, y)) / (\alpha + \beta) \quad (6)$$





where α, β are the weights for the feature similarity and domain dissimilarity, respectively ($\alpha + \beta \neq 0$)

By the definition, the design example shown in Tables 1 and 3 is a significantly typical metaphor. This study calls this characteristic “saturation”. The metaphoricity is extremely saturated, because the salience imbalance, $I(x, y)$, is 0.978. Moreover, this well-saturated metaphorical design is significantly of strength, for $T(x, y)$, is 0.895 ($= (0.89 + 0.9) / 2$), given $\alpha = \beta = 1$.

4 Example and Testing

To determine the relation between the metaphoricity and creativity of designs, this study chooses five metaphorical products as the stimuli for testing, in a fashion of purposive sampling. The stimuli are chosen from five international competitions: International Forum (iF) concept award; red dot Design Award-concept; Good Design Award (G-Mark); International Design Excellence Award (IDEA) and Taiwan International Design Competition- students (TID), as displayed in Table 4. Participants of this test are twenty-six industrial design students of National Taipei University of Technology.

Table 4. Five stimuli for testing

Title	Image	Target	Source	Award
Aroma Humidifier		humidifier	potted plant	G-Mark
Jellyclick		laptop mouse	jelly	IDEA
Orangin		juicer	pencil sharpener	red dot
Pebble Eraser		eraser	pebble	TID
Zipper Speaker		speaker	zipper	iF

First, the materials shown in Table 4 are presented to each participant. He or she is requested to complete the following stages for each design:

1. List the top-seven salient features of target and source respectively.
2. Specify the salience rankings for the seven target features and the seven source features respectively.
3. Link up the pairs of similar features by drawing an arrow line from the source feature to the similar target feature.
4. Put the degree of the similarity on each line (ranging from 0 to 1).
5. Determine the degree of the dissimilarity between the target domain and source domain (ranging from 0 to 1).
6. Determine the degree of overall creativity of this stimuli (ranging from 0 to 1).

The metaphoricity of all the five stimuli is measured by using the raw data acquired in the above stages. For convenient reason, the strength constants α and β , and the coefficient δ_i for each feature are set as 1. As the space is limited, let's merely take one of the participant's responses on Zipper Speaker for example.

Table 5 shows how the diagram of salience imbalance analysis is applied. This participant identifies the top-seven features of the speaker, but has some difficulty on the sixth and seventh features of the zipper. Although only top-five features of the zipper are listed, the normalized salience used is still based on seven features without any difficulty, for it is impossible to have a pair including the sixth or the seventh features. The participant then draws arrow lines to connect the common features, and put the similarity value of each pair of common feature on the corresponding line. The similarity between a speaker and a zipper is thus obtained as

$$S(\text{speaker, zipper}) = (0.4 + 0.8 + 0.5 + 0.7) / 4 = 0.6$$

Since the participant gives the degree of the dissimilarity between the target domain and source domain, $D(\text{speaker, zipper})$, as 0.8. Consequently, the metaphoricity strength is obtained as

$$T(\text{speaker, zipper}) = (S(\text{speaker, zipper}) + D(\text{speaker, zipper})) / 2 = (0.6 + 0.8) / 2 = 0.7$$

The summation of salience imbalance differences is computed as

$$\Sigma(w_y - w_x) = (0.386 - 0.129) + (0.193 - 0.096) + (0.096 - 0.055) + (0.077 - 0.193) = 0.279$$

The feature salience imbalance of the Zipper Speaker is then calculated as

$$I(\text{speaker, zipper}) = ((0.386 - 0.129) \times 0.4 + (0.193 - 0.096) \times 0.8 + (0.096 - 0.055) \times 0.7 + (0.077 - 0.193) \times 0.5) / 0.279 = 0.54 > 0$$

Table 6 presents results of measuring object similarity, domain dissimilarity, metaphoricity strength, salience imbalance (metaphoricity saturation), and creativity for each stimulus. In general, the relation between the metaphoricity strength and the creativity is intermediately positive ($r=0.65$). Nevertheless, the correlation coefficient of the domain dissimilarity and the creativity is rather low ($r=0.08$), whereas the correlation coefficient of the object similarity and the creativity is significantly high ($r=0.90$).

The implications are two-fold. First, this relation between is by no means a perfect linear correlation, if the measurement of domain dissimilarity is applicable. The metaphoricity strength becomes much more undecided than this study predicts. Having got this point firmly recognized, in our short study the weight of the feature similarity, α , and the weight of the domain dissimilarity β should not be set to 1. Alternatively, we can turn to only consider the object

Table 5. Diagram of salience imbalance analysis for Zipper Speaker

Target: Speaker		Source: Zipper	
Features	(Normalized) Salience	(Normalized) Salience	Features
Broadcast music	(0.386) 1	1	Control opening/closure
Rotating-button	(0.193) 2	2	Moving up and down
Control volume	(0.129) 3	3	Jagged parts
On/off	(0.096) 4	4	Two in one
Square box	(0.077) 5	5	Pull ring
Connect. comp.	(0.064) 6	6	-
Couple	(0.055) 7	7	-

Second, it might be too abstract for the participants to learn what the target domain and source domain of an object are. Perhaps, determining the supertype of a subtype, or the class of an object, is not as straightforward as determining the features of the subtype, or the features of an object. In the test, a few participants ask for clear definition or exemplars, when they are requested to describe these two domains for each stimulus. The above two points remain to be proved in further investigations.

Table 6. Results of metaphoricity and creativity measurements

Title	Object Similarity	Domain Dissimilar	Metapho-ricity Strength	Metapho-ricity Saturation	Creativity
Aroma Humidifier	0.78	0.46	0.48	0.45	0.75
Jellyclick	0.75	0.32	0.55	0.78	0.79
Orangin	0.62	0.32	0.41	0.22	0.61
Pebble Eraser	0.54	0.36	0.46	0.26	0.55
Zipper Speaker	0.71	0.46	0.45	0.31	0.62

In contrast, the metaphoricity saturation (i.e., salience imbalance) and the creativity have considerable positive relation ($r=0.88$). The correlation coefficient is as high as that of the object similarity and the creativity ($r=0.90$). This represents that the two factors can be used as an alternative indicator of creativity of designs.

5 Conclusion

This research has proposed a feature-based approach to measuring metaphoricity of designs, including measures of the object similarity, domain dissimilarity, and salience imbalance. The strength of metaphoricity is defined as a function of feature similarity between its target and source entities, as well as the domain dissimilarity between the two entities. The saturation of metaphoricity is the salience imbalance of the similar features between of its target and source entities. To test the argument, five award winners of various well-known creativity-oriented design competitions are accordingly presented to twenty-six design students to assess the metaphoricity strength and saturation, and the creativity on a subjective base.

Results reveal the creativity has significantly positive relation between the object similarity and metaphoricity saturation. In this sense, creative designers are those who learn how to maximize the similarity between the target and source objects, the dissimilarity between the target and source domains, and the salience imbalance, in order to create both new and meaningful solutions. Nonetheless, relation between the creativity and the domain dissimilarity might not be a perfect linear correlation, which is much more uncertain than predicted. The strength of metaphoricity remains to be determined in further studies. The limitation of this method is that features of target and source may hard to indicate by general participants with non-design background, and participants with different culture would evaluate metaphorical design differently. To sum up, metaphoricity measures have potential to develop alternative tool for assessing the creativity of designs.

Acknowledgements

We wish to thank National Science Council, Taiwan, ROC, for their generous financial assistance under Grant NSC 99-2221-E027 -084.

References

- Casakin HP, (2005) Design aided by visual displays: a cognitive approach. *Journal of Architectural and Planning Research* 22(3):250–265
- Casakin HP, (2006) Assessing the use of metaphors in the design process. *Environment and Planning B: Planning and Design* 33(2):253–268
- Casakin HP, (2007) Metaphors in design problem solving: implications for creativity. *International Journal of Design* 1(2):21–33
- Everitt B, Landau S, Leese M, (2001) *Cluster analysis*. 4th edition. London: Arnold
- Gentner D, Markman AB, (1997) Structure mapping in analogy and similarity. *American Psychologist* 52(1):45–56
- Gentner D, (1983) Structure-mapping: a theoretical framework for analogy. *Cognitive Science* 7:155–170
- Goldstone RL, (1999) Similarity. In Wilson RA, Keil FC, (Eds.), *The MIT encyclopedia of the cognitive sciences*, 757–759, Cambridge, MA: MIT Press
- Gower J, (1971) A general coefficient of similarity and some of its properties. *Biometrics* 27:857–872
- Hey HGJ, Agogino MA, (2007) Metaphors in conceptual design. 2007 International Design Engineering Technical Conferences & Computers and Information in Engineering Conference
- Kaufman L, Rousseeuw P, (1990) *Finding group in data: an introduction to cluster analysis*. New York, NY: John Wiley & Sons

- Kovecses Z, (2002) *Metaphor: a practical introduction*. NY: Oxford
- Lakoff G, Johnson M, (1999) *Philosophy in the flesh: the embodied mind and its challenge to western thought*. New York: Basic Books
- Liao TW, Zhang Z, Mount C, (1998) Similarity measures for retrieval in case-based reasoning systems. *Applied Artificial Intelligence* 12(4):267–288
- Michalko M, (2001) *Cracking creativity: the secrets of creative genius*. California: Ten Speed Press
- Novick LR, (1988) Analogical transfer, problem similarity, and expertise. *Journal of Experimental Psychology: Learning, Memory, and Cognition* 14(3):510–520
- Ortony A, (1979) Beyond literal similarity. *Psychological Review* 86(3):161–180
- Ortony A, (1993) *Metaphor and thought: the role similarity in similes and metaphors*. Cambridge University Press, New York, 342–356
- Ortony A, Vondruska JR, Foss AM, Jones EL, (1985) Salience, similes, and the asymmetry of similarity. *Journal of Memory and Language* 24:569–594
- Ricoeur P, (1981) *Metaphor and the central problem of hermeneutics*. In Thompson JB, (Ed. and Trans.), *Hermeneutics and the human sciences*, 165–181, Cambridge, England: Cambridge University Press
- Seitz JA, (1997) The development of metaphoric understanding: implications for a theory of creativity. *Creativity Research Journal* 10(4):347–353
- Torrance EP, (1974) *Torrance tests of creative thinking: directions manual and scoring guide (figural test, form A) (revision)*. Princeton, N J: Personnel Press
- Tversky A, (1977) Features of similarity. *Psychological Review* 84(4):327–352
- Vosniadou S, (1989) Analogical reasoning as a mechanism in knowledge acquisition: a developmental perspective. In Vosniadou S, Ortony A, (eds) *Similarity and analogical reasoning*, 413–437, Cambridge University Press, Cambridge
- Winner E, (1985) *Invented worlds: the psychology of the arts*. Baker & Taylor Books (Chinese translated by Tao DF, 1997), Taipei: Gardencity
- Wang HH, Liao WJ, (2009) Applications of metaphor theory to product design. In *Proceedings of International Association of Societies of Design Research 2009 (CD-ROM)*, Seoul, Korea
- Wang HH, Chou CP, (2010) Wind, water, and stone: a cultural product design of applying design metaphor. In *Proceedings of 2010 International Conference of Innovation and Design*, Taipei, Taiwan, 64–69

Interrelations between Motivation, Creativity and Emotions in Design Thinking Processes – An Empirical Study Based on Regulatory Focus Theory

Madeleine Kröper^{1,2}, Doris Fay², Tilmann Lindberg¹ and Christoph Meinel¹

¹ Hasso Plattner Institute at University of Potsdam, Germany

² University of Potsdam, Germany

Abstract. Design thinking, here defined as a team-based innovation method, helps to deal with complex design problems by sustaining in-depth learning processes on problem perception and diverse solution paths. To carry out design thinking processes successfully, motivation is a central psychological aspect to ensure creativity of the project outcome. In this paper, we ask how motivation is affected by the design thinking process and how it is related to team member's emotions throughout the process. We adopted regulatory focus theory to conceptualize motivational variables. Experience Sampling Method within a field study with two samples was used, investigating people's motivation of setting and approaching goals throughout real-life design projects that used design thinking. Results of this study show that the different phases carried out in design thinking processes significantly impact motivation and emotions of the members of a design team.

Keywords: Design Thinking, Design Thinking Processes, Motivation, Creativity, Emotions, Teams, Regulatory Focus Theory

1 Introduction

In the broadest sense, design thinking refers to the “study of cognitive processes that are manifested in design action” (Cross, Dorst and Roozenburg, 1992). Practitioners as well as scholars in various disciplines have long been interested in understanding the cognitive processes that underlie design activities. Early research trying to unravel the thought processes in design activities studied how outstanding designers approach problems and develop creative solution concepts (e.g. Lawson, 2006; Cross, 2007). This research has initiated an extensive scientific discourse on the exploration and analysis of cognitive strategies that carry the generation, synthesis and creative transformation of divergent knowledge within design processes (e.g. Nagai and Noguchi, 2003; Owen, 2007). Identified design strategies have been

reinterpreted as normative guidelines for design projects and creative problem solving in general (Lindberg, Noweski and Meinel, 2010). In this context, design thinking has been translated into a holistic framework moving beyond designers' professional domains and it has since been gradually applied to various disciplines and fields of innovation in both academia and business (Beckman and Barry, 2007; Brown, 2008; Dunne and Martin, 2006).

The fundamental principle underlying design thinking is that design problems and solutions are explored in parallel in consideration of different stakeholder perspectives (Cross, 2007; Lawson, 2006). Design problems are regarded as made up of exogenous stakeholder perspectives (the user's, the client's, the engineer's, the manufacturer's, the law-maker's, etc.) that finally decide about the solution's viability (Dorst, 2006). Dealing with a design problem's complexity is therefore a matter of negotiation between different and probably conflicting perspectives, so that design processes are regarded as a “reflective conversation with the situation” (Schön, 1983). Design thinking thus supports all activities relevant for accessing the diverse knowledge and multiple perspectives that reside in the different stakeholders in order to use them for inspiration; and it facilitates the creative transformation of the knowledge base into new concepts.

The specific problem solving patterns in design thinking are rather determined by heuristic and situational reasoning than by analytical and rationalist thinking. Furthermore, instead of external standards for evaluating the quality of design outcomes, design thinking asks for developing those standards within the process. Therefore, design thinking assigns strong responsibility for deciding and evaluating how to proceed in a design process to the design team itself (that is what knowledge should be grasped and what concepts and designs should be elaborated). As a result, design thinking process models cannot be more

than a framework of suggestions that help design teams to go through their own learning and creativity processes.

Against that background, we assume that team motivation plays a decisive role in putting those suggestions into practice. We therefore seek to find out how motivation is affected by the different phases of the design thinking processes; this will enable us to better understand team creativity. We also explore whether motivation and emotions in design thinking processes are interrelated, as both concepts show strong interdependencies (Ryan, 2007). To deal with these questions, we draw upon a conceptualization of motivation offered by regulatory focus theory (Higgins, 1997; 1998). We conducted a study using the Experience Sampling Method with design teams. Design teams adopted design thinking methodology; they worked in two German IT companies. In the following, we present the conceptual and theoretical foundations and develop this study's hypotheses.

1.1 Design Thinking Process Model

This study draws on a comprehensive design thinking process model that has been formalized at the Hasso-Plattner-School of Design at Stanford (US) and the HPI School of Design Thinking in Potsdam (Germany). It distinguishes six phases (Plattner, Meinel and Weinberg, 2009): *understand*, in which a design team is asked to build up general expertise about a design problem, to identify stakeholders and contexts of usage for further examination; *observe*, in which the design team goes into the field and gathers widespread insights and develops empathy for the stakeholders of the design problem; *synthesis/point of view*, in which the collected insights are summarized, shared in the team, and compiled in a framework of viewpoints on the design problem; *ideate*, in which – based on the lessons learned so far – ideas and concepts are created (for instance by brainstorming techniques) and roughly sketched out; *prototyping*, in which ideas and concepts are turned in tangible representations allowing to generate genuine feedback from users and other stakeholders; and *test*, in which this feedback is collected and processed for further refinements and revisions. As Figure 1 shows, these phases are not placed in a linear sequence, but are highly iterative. Therefore, the responsibility for the decision on when to move into which phase and how to get through an entire design process lies with the design team. The model is complemented by a set of rules that communicates a certain mind-set towards creative design. Rules emphasize 1) the readiness to explore seemingly odd paths as well (instead of going rashly for the obvious things) and 2) acting generally

quickly, experimentally, and iteratively. Those rules are in particular: “fail often and early”; “defer judgement” and “encourage wild ideas” (cf. Osborn, 1953).

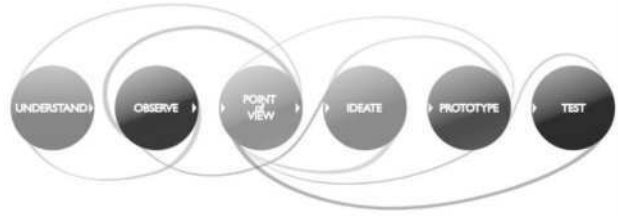

Fig. 1. Iterative design thinking process (Plattner, Meinel and Weinberg, 2009)

1.2 Regulatory Focus Theory and Creative Performance

We draw on regulatory focus theory to explore motivation in design thinking (Higgins, 1997; 1998). This theory presupposes that human motivation serves to satisfy the two basic needs of approaching pleasure and avoiding pain (hedonic principle). The theory suggests that these desired hedonic end-states are reached through self-regulatory processes, which refer to the processes by which people seek to align themselves with appropriate goals or standards (Crowe and Higgins, 1997). Two distinct types of regulatory systems, called promotion and prevention focus, drive this process of self-regulation. The promotion focus has a *desired* end-state as reference value, focusing individuals on goals they long for and is induced by nurturance needs, ideals and rewards (gain/no-gain situations). The prevention focus, conversely, has an *undesired* end-state as reference value, motivating individuals to avoid damages or unpleasant situations. This focus is induced by security needs, duties and the fear of punishment (non-loss/ loss situations). It is assumed that the promotion focus represents the “ideal self”, that is a person’s wishes, hopes, and aspirations, while the prevention focus represents the “ought self”, which includes a person’s obligations, duties, and responsibilities (Higgins, 1997). Both foci influence people’s perception, behavior, performance, and emotions (Förster and Higgins, 2005). The theory distinguishes furthermore between chronic and momentary foci. Individuals differ in their chronic tendency to be promotion and prevention oriented; furthermore, signals and stimuli of any type of situation also activate the promotion and/or prevention focus (Higgins, 1998; Crowe and Higgins, 1997). Thus, process feedback, task instructions or goal framing has a significant impact on the two dimensions of regulatory focus (Idson, Liberman, and Higgins, 2004; Higgins, Shah, and Friedman, 1997).

Experimental research has shown that regulatory focus affects creativity. Creativity can be defined as the ability “to produce work that is both novel (i.e., original, unexpected) and appropriate (i.e., useful, adaptive concerning task constraints)” (Sternberg and Lubart, 1999, p. 3). Creativity is not only a personality trait; it is also affected by situational factors, such as task characteristics, or expected gratifications or motivational variables (Förster, Friedman, and Liberman, 2004). Crowe and Higgins (1997) asked their study participants to complete different tasks, which tested among other things the capability to generate creative insights. Participants in the promotion focus condition found significantly more solutions compared to those in the prevention focus condition. These findings were supported by Friedman and Förster (2001). Furthermore, Crowe and Higgins’ (1997) studies also demonstrated that the promotion focus is conducive to a risky explorative processing style that facilitates insight-related processes; they also found interdependence between the promotion focus and cognitive flexibility. The prevention focus however was stronger related to analytical problem solving and attentive behavior. This research shows that to further our understanding of creative work, regulatory focus is a motivational variable worthwhile studying. Since regulatory focus seems to predict creative performance, we now want to understand what situational factors can enhance the one or the other focus.

1.3 Hypotheses

1.3.1. Motivation and Creativity in the Design Thinking Process

In our first set of hypotheses we ask how motivation, focusing on regulatory focus, is affected by the different phases of the design thinking process. We propose that the diverse phases of a design thinking process influence the momentary regulatory focus differently, which would therefore explain situational changes in motivation. We assume that some phases consist of creative or novel tasks to a larger degree than other phases that consist of analytical tasks to a larger degree. We suggest that the phases ‘understand’, ‘observe’, and ‘ideate’ require a creative problem-solving style with regard to novel tasks and promotion goals. The phases ‘synthesis’, ‘prototype’, and ‘test’, in contrast, require an analytical problem-solving style to reduce information and thus problem complexity with regard to prevention goals.

On the basis of the previous discussion, it is hypothesized that the phases ‘understand’, ‘observe’ and ‘ideate’, in which creative tasks dominate, are

more likely to increase strength of the promotion focus in comparison to other phases of the design thinking process (*hypothesis 1a*).

The phases ‘synthesis’, ‘prototype’, and ‘test’, in which analytical tasks dominate, are more likely to increase the strength of the prevention focus compared to other phases of the design thinking process (*hypothesis 1b*).

Administrative tasks that accompany the design thinking process are more likely to increase strength of the prevention focus in comparison to other phases of the process. Furthermore, administrative tasks are more likely to reduce strength of the promotion focus in comparison to other tasks (*hypothesis 1c*).

As Florack and Hartman (2007) provided evidence for the fact that time pressure reinforces the momentary regulatory focus, it is assumed that time pressure moderates the relation between different phases of the design thinking process and the promotion or the prevention focus emerging in these phases (*hypothesis 1d*).

1.3.2. Motivation and Emotions in the Design Thinking Process

In our second set of hypotheses we explore the relationship of the momentary regulatory focus with emotions experienced and how this is affected by goal attainment; and we furthermore ask how the design thinking process affects emotions. It has been shown that the regulatory focus has an impact on problem-solving styles, but it bears also on emotions. Frijda (1988, p. 349) states that goals, for example in terms of promotion or prevention end-states, and emotions are strongly related to each other: “Events that satisfy the individual’s goals, or promise to do so, yield positive emotions; events that harm or threaten the individual’s concerns lead to negative emotions.” Thus, evaluating the personal degree of goal attainment gives rise to specific emotions (Brockner and Higgins, 2001; Higgins, Shah and Friedman, 1997; Higgins, 1998; Higgins, Bond, Klein, and Strauman, 1986). As Higgins, Shah and Friedman (1997) point out, emotions are differentially related to the two dimensions of the regulatory focus. While the degree to which the promotion focus is satisfied is associated with emotions of *cheerfulness* (in case of attaining a promotion goal) and *dejection* (when failing a promotion goal), prevention focus is associated with emotions of *quiescence* (when achieving a prevention goal) and *agitation* (when failing a prevention goal).

We hypothesize that goal attainment, conceptualized in terms of satisfaction with the performance, moderates the relation between the two

regulatory foci and particular emotions. Specifically, the following four interactions are predicted:

There is an interaction between regulatory focus and satisfaction with the performance, such that a) the relationship between promotion focus and cheerfulness emotions increases with high performance satisfaction (*hypothesis 2a*), and such that b) the relationship between promotion focus and dejection-related emotions increases with low performance satisfaction (*hypothesis 2b*), c) the relationship between prevention focus and quiescence-related emotions increases with high performance satisfaction (*hypothesis 2c*), and d) the relationship between prevention focus and agitation-related emotions increases with low performance satisfaction (*hypothesis 2d*).

Cheerfulness-, dejection-, quiescence-, and agitation-related emotions are influenced by the different phases and tasks of the design thinking process (*hypothesis 2e*).

2 Method

Participants. A total of 10 participants (3 men, 7 women) of two different teams adopting the design thinking method volunteered for the study. Their ages ranged from 24 to 58 years, with a mean of $M = 37.6$ ($SD = 7.15$).

Method, procedure, and measures. Experience Sampling Method (ESM) was used to test the hypotheses ($N = 229$ measurements). ESM is a means of collecting information about the context and the content of people's daily life by capturing their immediate conscious experiences. Participants deliver self-reports each time they receive randomly sent electronic signals throughout several days (see Hektner, Schmidt and Csikszentmihalyi 2007; Feldman-Barrett and Barrett, 2001). In this study participants received signals for the whole observation period (6/8 weeks) three times a day, two days a week via handheld computers (10 Palm Pilots, system: PalmOS 2.0). The study took place between September and November 2009. Data was collected in German language, using a paper-and-pencil questionnaire and electronic data assessment via palm pilots.

A researcher introduced participants to the objectives of the study. Each participant was handed out one palm and completed the paper-and-pencil-questionnaire. It assessed a number of control variables (age, gender, nature of team), chronic affect and chronic regulatory focus. Chronic affect was assessed with the positive and negative affectivity measure (Watson, Clark and Telegen, 1988; German version by Krohne, Egloff, Kohlmann and Tausch,

1996). ("How do you feel in general?"; response was a scale from 1 (*not at all*) to 5 (*completely*)). The measure of chronic regulatory focus (Fay, Urbach and Möbus, 2010) obtained participants' enduring motivational orientation ("My thoughts and behavior are mainly directed to...") on a scale anchored at 1 (*does not apply to me at all*) and 7 (*applies to me completely*). Nine items recorded the promotion focus and nine items the prevention focus.

The electronic data collection, which took place several times a day, assessed the momentary regulatory focus (Fay, Urbach and Möbus, 2010). It was measured with the same items as used for the chronic focus; however, the instruction to respond to the items referred to "this very moment" ($\alpha = .94$, prevention focus scale; $\alpha = .87$, promotion focus scale). Furthermore, we measured eight momentary emotions related to the regulatory focus (Falomir-Pichastor, Mugny, Quiamzade and Gabarrot, 2008) on a scale anchored at 1 (*not at all*) and 5 (*utterly*). Effectiveness of and satisfaction with the performance represented further internal coordinates assessed in the first part (1 = *very unsatisfied/ineffective*, 10 = *very satisfied/effective*). Finally, participants were asked to describe the tasks or activities currently pursued, by indicating in which of a list of altogether nine activities they were currently involved. Nine activities comprised the six phases of the design thinking process and three other activities, specifically: administration, recreation, other. They also indicated for how long they had been involved in these activities, if they worked under time pressure (1 = *not at all*, 5 = *a lot*), their location (office, client, at home, other), and their social context (number of persons: no one, 1-2 persons, more than 3 persons; characters: with no one, workmates, disciplinarian, client, family/friends, other). Answering these questions took approximately two minutes.

3 Results

Before conducting t-tests and regression analyses to test the hypotheses, measures of each participant were centred and subsequently merged together. Analyses presented here are based on situations, not people.

3.1 Motivation and Creativity in the Design Thinking Process

T-test for independent samples revealed a significant higher promotion focus in situations in which participants executed novel tasks (phases understand, observe, and ideate) ($M = .22$, $SD = .84$) compared to situations of involvement in analytical tasks ($M = -.27$,

$SD = 1.09$), $t(152) = -3.3$, $p = .001$. This result is fully in line with the expectation according to the first hypothesis that the promotion focus, which refers to the need for growth, achievement of ideals, gains or maximal goals, is more strongly elicited by novel tasks compared to analytical tasks.

In order to run a more rigorous test of hypothesis 1a, a regression analysis on the promotion focus was conducted, with control variables (1. age, gender, team; 2. chronic regulatory focus, chronic affect) and tasks (0 = other, 1 = novel) as predictors. Consistent with the previous finding, this analysis revealed a significant main effect for tasks ($\beta = .301$, $p = .000$). This finding supports hypothesis 1a that novel tasks (phases: understand, observe, and ideate), relative to analytical or other tasks, trigger a processing style that enhances the promotion focus to a larger degree.

To test hypothesis 1b, stating that the prevention focus is significantly higher when executing analytical tasks (i.e., 'synthesis', 'prototype', and 'test'), compared to the prevention focus during administrative tasks or other phases of the design thinking process, another t -test for independent samples was conducted. Against the prediction, there was no significant difference in the prevention focus during execution of analytical tasks ($M = .02$, $SD = 1.01$), compared to the prevention focus when performing novel tasks ($M = -.05$, $SD = .88$), $t(170) = .497$, $p = .619$). Thus hypothesis 1b cannot be confirmed.

For hypothesis 1c it was tested whether prevention focus was higher and a promotion focus lower in situations of accomplishing administrative tasks in comparison to completing other tasks. The t -test for independent samples showed no significant difference in the prevention focus when performing administrative tasks ($M = .06$, $SD = 1.1$) compared to performing other tasks ($M = -.02$, $SD = .95$), $t(227) = -.51$, $p = .611$). The second t -test, however, revealed that the promotion focus was significantly lower in situations of administrative tasks ($M = -2.8$, $SD = 1.2$), to performing other tasks ($M = .09$, $SD = .90$), $t(73.055) = 2.118$, $p = .038$). To confirm this result, a regression analysis on the promotion focus was conducted with control variables (age, gender, team, chronic regulatory focus, and chronic affect) and tasks (0 = other, 1 = administrative). Task proved to be a significant predictor ($\beta = -.184$, $p = .010$; $\Delta R^2 = .029$, $p = .010$). Thus, hypothesis 1c is partly confirmed.

To test hypotheses 1d, which presumed that time pressure moderates the relationship between the promotion focus and novel tasks and between the prevention focus and analytical tasks, two moderated regression analyses on the prevention and the promotion focus were performed (with control

variables, time pressure, novel, respectively analytical tasks and the interaction term of time pressure and novel tasks or time pressure and analytical tasks). The first analysis revealed a significant main effect of time pressure on the prevention focus, suggesting that the prevention focus increases with increasing time pressure ($\beta = .247$, $p = .001$, $\Delta R^2 = .063$, $p = .000$). There was no main effect for analytical tasks ($\beta = .050$, $p = .554$). The interaction term of analytical tasks and time pressure was marginally significant ($\beta = .216$, $p = .095$). This demonstrates that the prevention focus depends on time pressure and fractionally on the interaction between time pressure and analytical tasks. Thus, only strong time pressure affects mainly people's prevention focus when they execute analytical tasks. In the second regression analysis, the assumption was tested that time pressure moderates the relationship between novel tasks and the promotion focus. There was a main effect for novel tasks ($\beta = .301$, $p = .001$, $\Delta R^2 = .075$, $p = .000$), which confirms the findings of hypothesis 1a. But against the presumption, there was neither a main effect for time pressure ($\beta = .002$, $p = .983$) nor a significant interaction between time pressure and novel tasks ($\beta = -.066$, $p = .498$).

These results can only partly support hypothesis 1d. Evidence could be shown for a direct effect of time pressure on the prevention focus and for a moderation of time pressure of the relation between analytical tasks and the prevention focus. Time pressure however neither affected the promotion focus nor did it moderate the relation between novel tasks and the promotion focus.

3.2 Motivation and Emotions in the Design Thinking Process

For hypothesis 2a, it was tested whether satisfaction with the performance moderates the relationship between the promotion focus and cheerfulness-related emotions or not. Regression analysis did not reveal that satisfaction with the performance moderates this relationship ($\beta = -.077$, $p = .179$) but showed a main effect of the promotion focus ($\beta = .325$, $p = .000$, $\Delta R^2 = .378$, $p = .000$) and of satisfaction with the performance on cheerfulness related emotions ($\beta = .476$, $p = .000$). While focusing on ideals, hopes or aspirations, people experience cheerfulness-related emotions, independently of the degree of their performance appraisal. Thus, hypothesis 2a can at least partly be confirmed.

The analogous regression analysis with dejection-related emotions yielded a significant main effect for satisfaction with the performance ($\beta = -.354$, $p = .000$, $\Delta R^2 = .122$, $p = .000$). Neither the promotion focus

($\beta = .047, p = .468$) nor the interaction of the promotion focus and satisfaction with the performance were significant ($\beta = .049, p = .474$). Hypothesis 2b cannot be confirmed.

For hypotheses 2c and 2d, we tested in two separate analyses whether satisfaction with the performance moderates the relationships between the prevention focus and agitation-related emotions and the prevention focus and quiescence-related emotions or not. Regression analysis on quiescence-related emotions showed a main effect for satisfaction with the performance ($\beta = .370, p = .000, \Delta R^2 = .173, p = .000$) but not for the prevention focus ($\beta = .023, p = .714$). The interaction term of satisfaction with the performance and the prevention focus was not significant ($\beta = .042, p = .520$). This implies that quiescence-related emotions depend on satisfaction with the performance, but neither on the prevention focus nor on the interaction between both variables.

Finally, the assumption was tested that satisfaction with the performance moderates the relationship between the prevention focus and agitation-related emotions. The prevention focus ($\beta = .355, p = .000$) and satisfaction with performance ($\beta = -.228, p = .000$) significantly influences these emotions ($\Delta R^2 = .183, p = .000$). The interaction of satisfaction with the performance and the prevention focus was not significant ($\beta = -.040, p = .525$). These results confirm hypothesis 2d partly: Agitation-related emotions depend on the prevention focus, and on satisfaction with the performance, but not on the interaction between both variables.

Hypothesis 2e predicted that emotions are not only influenced by the regulatory focus and satisfaction with the performance, but also by the different tasks currently performed. In each regression analysis we regressed emotion on control variables, momentary prevention focus, momentary promotion focus, and task. First, it was analyzed whether cheerfulness-related emotions are influenced by the nature of the task. Regression analysis on cheerfulness-related emotions with all predictors including tasks (0 = novel, 1 = analytical) showed a significant main effect of the promotion focus ($\beta = .376, p = .000$) and of tasks ($\beta = -.162, p = .050, \Delta R^2 = .020, p = .05$), suggesting that the promotion focus and novel tasks relate positively to cheerfulness.

Furthermore, a regression analysis on dejection-related emotions revealed two significant main effects of the prevention focus ($\beta = .278, p = .001$) and of tasks ($\beta = -.186, p = .034$), ($\Delta R^2 = .026, p = .034$). Although dejection is theoretically speaking related to the promotion focus, here, dejection-related emotions were influenced by the prevention focus. Likewise, they are positively affected by novel tasks. A regression analysis on quiescence-related emotions

with momentary regulatory focus and tasks as predictors revealed no significant effect of tasks ($\beta = -.063, p = .480$) but a significant effect of the promotion focus ($\beta = .171, p = .044$), albeit quiescence should be positively related to the prevention focus. A last regression analysis on agitation-related emotions revealed one significant main effect of the prevention focus ($\beta = .346, p = .000, \Delta R^2 = .134, p = .000$). Tasks did not affect these emotions ($\beta = -.084, p = .324$).

These results suggest that only cheerfulness- and dejection-related emotions are partly influenced by the tasks participants conduct in the design thinking processes. Both emotions are positively influenced by novel tasks. For these two emotions, which are described as promotion-emotions, hypothesis 2e can be confirmed. Hypothesis 2e has to be rejected for the prevention-related emotions quiescence and agitation.

4 Discussion

Previous research has revealed many effects of the regulatory focus on problem solving, creativity and emotions. Using Experience Sampling Method, this study sets out to explore the reverse effect by testing whether promotion and the prevention focus *are affected* by the nature of the task pursued. Results suggest that regulatory focus changes depending on the specific phase of the design thinking process. We furthermore investigated emotions in the context of design thinking. Both regulatory focus and the nature of the tasks pursued influenced emotional experience.

The results of this study support the assumption that the promotion focus is significantly higher while executing novel tasks (which are assumed to predominate in the phases ‘understand’, ‘observe’, and ‘ideate’) in comparison to the other tasks performed in the design thinking process; and lower when performing administrative tasks. This is interesting from two perspectives. First, the dominant approach in studying motivation in the context of design and innovation research treats motivation as a critical antecedent to successful design and innovation; and from the perspective of regulatory focus, this research has demonstrated that higher levels of promotion focus facilitate high levels of creative performance (e.g., Crowe and Higgins, 1997). Second, if a high level of the promotion focus is beneficial for creative performance, this raises the question as to what momentary or situational factors can increase the momentary promotion focus. Our study suggests that motivation itself is affected by pursuing tasks that require learning, exploration, and creative problem solving. This breaks ground for a new field of research in which creativity-relevant motivation is

conceptualized as a key aspect of a cyclical process. In this process, the nature of the task – in terms of design thinking, for example engagement in “observe” or “prototype” – influences motivation such as the regulatory focus; and the regulatory focus in turn affects the level of creative performance. Creative performance may then operate as a stimulus to increase the promotion focus even further.

However, no statistical support could be found for a higher level of the prevention focus when performing the phases ‘synthesis’, ‘prototype’, and ‘test’ as well as when conducting administrative tasks (in which analytical tasks are supposed to predominate). The fact that there are no differences in prevention focus between the different phases suggests that none of the design thinking process phases focuses in particular on constraints, obligations or duties. Furthermore, the rules that should guide the design processes (e.g. “encourage wild ideas”, “fail often and early”) had been well internalized by the teams observed; it may have been that those implicitly operating rules constantly hinder the activation of prevention goals. We take from this that the design thinking process supports creative behavior primarily through its strong promotional orientation; the nature of the design process as well as the above named rules shield motivational processes that may restrict creativity.

Also the investigation of the interplay between the design thinking process, regulatory focus and emotions resulted in interesting insights. First, it could be shown that novel tasks performed in the design thinking process influence the same emotions positively that the promotion focus influences according to regulatory focus theory (cheerfulness and dejection), whereas analytical and administrative tasks have no effect on emotions, so that the emotions quiescence and agitation (in theory prevention focus emotions) are not affected directly by any tasks. However, when we change our view and look at how the regulatory focus influences directly emotions in design thinking processes, we could observe a paradoxical situation. In contrast to what regulatory focus theory suggests, in this study quiescence does not relate to the prevention but to the promotion focus. Likewise, dejection – being in theory related to the promotion focus – does not correspond to the promotion but to the prevention focus. These findings indicate that participants experience emotions either related positively to the promotion focus (cheerfulness and quiescence) or negatively to the prevention focus (dejection and agitation). Thus, in opposition to hitherto existing research, both foci are associated with only “one-sided” emotions, favoring the promotion focus while disregarding the prevention focus. Therefore in design thinking processes, emotions appear to be in a certain imbalance, which may be a key component of

provoking teams to go beyond certain states of knowledge and concepts, and thus to increase their creativity.

Since our context of research is design and creativity, we emphasized the importance of the promotion focus for design thinking. However, an elevated level of the prevention focus might be as important for specific phases of design thinking as the promotion focus. Previous research demonstrated that people tend to initiate goal pursuit faster in situations of elevated levels of prevention focus (Freitas, Liberman, Salovey, and Higgins, 2002). Thus, to understand what makes or breaks successful performance in, for example, “prototyping”, we need to identify momentary triggers of the prevention focus. This study already identified one variable: time pressure seemed to increase the prevention focus. Even though time pressure is typically regarded as harmful in design processes, in specific phases it may help to remain focused on project progress and to consider organizational constraints. Therefore, we regard ‘time pressure’ as a fundamental element in design thinking processes to stabilize creative workflows.

To summarize, the results of this study show that the regulatory focus, in particular the promotion focus, plays an important role in the design thinking process. However, optimal motivational structures in the design process are likely to include both foci, and in particular a successful change between them depending on the nature of the task at hand.

5 Outlook

In order to corroborate the results of this study, future research should investigate the relation between motivational variables and design thinking processes considering the hierarchical and nested structure of this research (Raudenbush and Bryk, 2002) in larger samples, possibly complementing it with other theoretical frameworks. Within the frame of regulatory focus theory, further studies on design thinking should investigate the precise role of the prevention focus throughout the process, in particular at which moments an elevated level of prevention focus is decisive for the quality of the process outcome.

References

- Beckmann SL, Barry M, (2007) Innovation as a Learning Process – Embedded Design Thinking. *California Management Review* 50(1):25–56
- Brockner J, Higgins ET, (2001) Regulatory focus theory: Implications for the study of emotions at work.

- Organizational Behavior and Human Decision Processes 86(1):35–66
- Brown T, (2008) Design Thinking. Harvard Business Review 84–92
- Cross N, (2007) Designing Ways of Knowing. Basel etc: Birkhäuser
- Cross N, Dorst K, Roozenburg N, (1992) Preface to Research in Design Thinking. In: Cross N, Dorst K, Roozenburg N. (eds.): Research in Design Thinking, Delft
- Crowe E, Higgins ET, (1997) Regulatory focus and strategic inclinations: Promotion and prevention in decision-making. Organizational behavior and human decision processes 69(2):117–132
- Dorst K, (2006) Design Problems and Design Paradoxes. Design Issues 22(3) Summer:4–17
- Dunne D, Martin R, (2006) Design Thinking and How It Will Change Management Education: An Interview and Discussion. Academy of Management Learning & Education 5(4):512–523
- Falomir-Pichastor JM, Mugny G, Quiamzade A, Gabarrot F, (2008) Motivations underlying attitudes: Regulatory focus and majority versus minority support. European Journal of Social Psychology 38:587–600
- Fay D, Urbach T, Möbus J, (2010) What motivates you right now? Development of a state-regulatory focus measure. Unpublished manuscript, University of Potsdam
- Feldman-Barrett L, Barrett DJ, (2001) An introduction to computerized experience sampling in psychology. Social Science Computer Review 19(2):175–185
- Florack A, Hartmann J, (2007) Regulatory focus and investment decisions in small groups. Journal of Experimental Social Psychology 43:626–632
- Förster J, Friedman RS, Liberman N, (2004) Temporal construal effects on abstract and concrete thinking: Consequences for insight and creative cognition. Journal of Personality and Social Psychology 7(2):177–189
- Förster J, Higgins ET, (2005) How global versus local perception fits regulatory focus. Psychological Science 16(8):631–636
- Freitas AL, Liberman N, Salovey P, Higgins ET, (2002) When to begin? Regulatory focus and initiating goal pursuit. Personality & Social Psychology Bulletin 28(1):121–130
- Friedman RS, Förster J, (2001) The effects of promotion and prevention cues on creativity. Journal of Personality and Social Psychology 81:1001–1013
- Frijda NH, (1988) The laws of emotion. American Psychologist 43(5):349–358
- Hekter JM, Schmidt JA, Csikszentmihalyi M, (2007) Experience sampling method: measuring the quality of everyday life. Thousand Oaks: Sage Publications, Inc.
- Higgins ET, (1997) Beyond pleasure and pain. American Psychologist 52:1280–1300
- Higgins ET, (1998) Promotion and Prevention: Regulatory focus as a motivational principle. In M. P. Zanna (Ed.), Advances in Experimental Psychology 30:1–46
- Higgins ET, Bond RN, Klein R, Strauman T, (1986) Self-discrepancies and emotional vulnerability: How magnitude, accessibility, and type of discrepancy influence affect. Journal of Personality and Social Psychology 51(1):5–15
- Higgins ET, Shah J, Friedman R, (1997) Emotional responses to goal attainment: Strength of regulatory focus as moderator. Journal of Personality and Social Psychology 72(3): 515–525
- Idson LC, Liberman N, Higgins ET, (2004) Imagining how you'd feel: The role of motivational experiences from regulatory fit. Personality and Social Psychology Bulletin 30(7):926–937
- Krohne HW, Egloff B, Kohlemann C-W, Tausch A, (1996) Untersuchungen mit einer deutschen Version der „Positive and Negative Affect Schedule“ (PANAS). Diagnostica 42(2):139–156
- Lawson B, (2006) How Designers Think. Oxford: Architectural Press
- Lindberg T, Noweski C, Meinel C, (2010) Evolving Discourses on design thinking: how design cognition inspires meta-disciplinary creative collaboration. Technoetic Arts: A Journal of Speculative Research 8(1):31–37
- Nagai Y, Noguchi I, (2003) An experimental study on the design thinking process started from difficult keywords: modelling the thinking process of creative design. Journal of Engineering Design 14(4):429–437
- Owen C, (2006) Design Thinking - Notes On Its Nature And Use. Design Research Quarterly 1:2 December 16–27
- Plattner H, Meinel C, Weinberg U, (2009) Design Thinking. Munich: mi-Verlag
- Raudenbush SW, Bryk AS, (2002) Hierarchical linear models: applications and data analysis methods. Thousand Oaks: Sage
- Roney CJR, Higgins ET, Shah J, (1995) Goals and framing: How outcome focus influences motivation and emotion. Personality and Social Psychology Bulletin 21:1151–1160
- Ryan MR, (2007) Motivation and Emotion: A New Look and Approach for Two Reemerging Fields. Motivation and Emotion 31:1–3
- Schön DA, (1983) The Reflective Practitioner – How Professionals Think in Action. New York: Perseus Books
- Sternberg RJ, Lubart TI, (1999) The concept of creativity: Prospects and paradigms. In Sternberg RJ, (Ed.), Handbook of creativity 3–15
- Watson D, Clark LA, Tellegen A, (1988) Development and validation of brief measures of positive and negative affect: The PANAS scales. Journal of Personality and Social Psychology 54:1063–1070

Conceptual Design and Cognitive Elements of Creativity: Toward Personalized Learning Supports for Design Creativity

Yong Se Kim, Jong Ho Shin and Yun Kyoung Shin
Sungkyunkwan University, Korea

Abstract. As an effort to provide students the opportunity in enhancing design creativity in a personalized adaptive manner, an exercise program that addresses cognitive elements of creativity has been devised. The cognitive elements of creativity include fluency, flexibility, originality, elaboration and problem sensitivity. We conducted an experiment where the exercise program with self-reporting of affective states was assigned between two simple conceptual design tasks. Design experts evaluated the conceptual design tasks of each student in terms of the cognitive elements. The experiment result supports that the exercise program helps in enhancing design creativity. We are using data mining approaches in understanding the relations among various characteristics of students and their learning experiences in this creativity enhancement exercise. Findings in the experiments as well as data mining results will contribute in design creativity education.

Keywords: Design Education, Cognitive Elements of Creativity, Conceptual Design Tasks, Educational Data Mining

1 Introduction

Creativity involves many aspects. Creator's personal characteristics could be an aspect, which can then be further decomposed into cognitive and affective parts. Also processes of creation activity could be another aspect. While creativity is a comprehensive notion in general, creative design processes could be discussed and studied with a little more specific viewpoints.

As in general creative activities, design process involves both divergent and convergent thinking processes. Promotion and maximization of the generation of ideas were pursued for enhancing the design creativity (de Bono, 1992; Isaksen, 1998). While both vertical and lateral thinking approaches have been identified as used by designers (Goel, 1995), a recent research showed the importance of the limited commitment mode control strategy in creative designing capabilities (Kim et al, 2007).

Design creativity cannot simply be defined by only the capability to produce novel and useful ideas. Therefore, it is important to establish concrete components of design creativity and to find distinct cognitive processes for design problem solving so that education of design creativity could be attempted based on these. It is meaningful to further decompose the design creativity into its cognitive elements which are highly related to design thinking ability. Furthermore, it would be desirable if there exists a systematic exercise program to foster design creativity addressing those cognitive elements.

In addition, personal adaptation is important in terms of user learning. A learning user model includes assessment information as well as understanding on learners both static and dynamic characteristics. Figure 1 depicts a user model constructed for general purpose in which both static and dynamic, also assessment attributes are presented.

We have conducted research work toward design creativity education so that various underlying cognitive elements and processes of design creativity are identified and then these design creativity elements and processes can be enhanced through training methods reflecting individual learner's cognitive personal characteristics. Visual reasoning capability has been identified as a critical element of design creativity (Kim et al, 2005), and a design reasoning model obtained from visual reasoning process were devised to investigate the cognitive interaction among elementary steps of visual reasoning (Park and Kim, 2007). In our previous work, we investigated the characteristic patterns of designers based on their personal characteristics called the personal creativity modes (Kim et al, 2010).

This paper is focused on design creativity education addressing cognitive elements, and is organized as follows: The cognitive elements of creativity are presented in Section 2. The exercise program and experiment for enhancing cognitive creativity elements are described in Section 3. The conceptual designs pre-test and post-test before and

after the exercise program are introduced in Section 4. The experiment results are explained in Section 5, and conclusion is in Section 6.

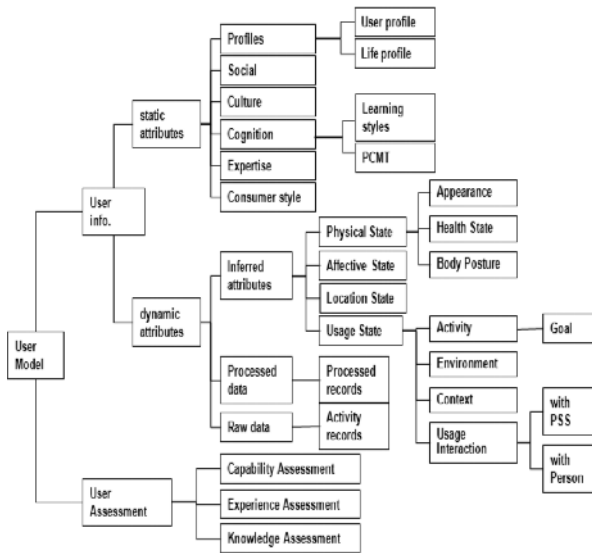

Fig.1. A user model representing static and dynamic user characteristics as well as user assessment

problem sensitivity, and identified five cognitive elements of design creativity such as fluency, flexibility, originality, elaboration and problem sensitivity. The definitions of the cognitive element of creativity are the following:

- **Fluency** is an ability to make multiple answers to the same given information in a limited time (Guilford and Hoepfner, 1971) and quantity of meaningful solutions (Urban, 1995).
- **Flexibility** is an adaptability to change instructions, freedom from inertia of thought and spontaneous shift of set (Guilford and Hoepfner, 1971). That is the mode changing categories (Urban, 1995).
- **Originality** is rarity in the population to which the individual belongs; its probability of occurrence is very low (Guilford and Hoepfner, 1971; Urban, 1995).
- **Elaboration** is the realization or transformation of an idea, which may become very general or simple or in contrary very fantastic or enriched into details (Urban, 1995).
- **Problem Sensitivity** is an ability to find problems (Urban, 1995) and to aware needs for change or for new devices or methods (Guilford and Hoepfner, 1971).

2 Cognitive Elements of Creativity

In the study, the fundamental cognitive elements of creativity were devised and were used throughout the designed exercise program, and pre-/post-test experiment. The cognitive elements of design creativity have been defined based on Treffinger’s creative learning model (Treffinger, 1980). The Treffinger’s creative learning model encompassed the cognitive and affective aspects. The cognitive aspects in Treffinger’s creative learning model are fluency, flexibility, originality, elaboration, and cognition and memory. We replaced cognition and memory with

3 Creativity Exercise Program

We devised a creativity exercise program which fosters the enhancement of cognitive aspects of the design creativity, grounded on the definition of cognitive elements of creativity in Section 2. The creativity exercise program consists of 5 tasks, as shown in Figure 2, that differ in the level (high, medium, and low) of addressed cognitive elements, as presented in Table 1. We hypothesized that the enhancement of underlying cognitive aspects of design creativity can be achieved by the creativity exercise program which consists of 5 tasks with the addressed

Table 1. Relation map between creativity elements and creativity exercise program

	Fluency	Flexibility	Originality	Elaboration	Problem Sensitivity
Making Stories		High	Low	Medium	
Negation		High	Medium		Low
Filling Black Box	High		Low	Low	
Sensitization		Medium			High
Diverse Classification		High			Medium

cognitive elements. The details of the 5 tasks of the creativity exercise program are as follows:

(1) Making Stories: The ‘making stories’ exercise asks the students to produce different stories using three different pictures by changing the order of them. Therefore, this activity aims to improve the flexibility cognitive element. The elaboration element can also be developed through this activity by implying cause and effect of given pictures and specifying them. In addition, the originality can be enhanced through the activity to make unique and novel stories.

(2) Negation: In the ‘negation’ exercise, the students are asked to compulsively and purposely negate the

given objects. In this activity, the students are supposed to negate a chair and a shopping basket and make new ideas about them. As a result, the fixed views or ideas on the objects can be broken, and the students can find the different and potential aspects of the objects. In this way, this activity can help to make new objects and transform original objects. This program aims to develop flexibility and originality.

(3) Filling Black Box: The objective of ‘filling black box’ is to mainly develop fluency by logically addressing the connections between the given input and output concepts as many times as possible within a limited time. This activity can also develop elaboration by explaining the logical relations of input and output

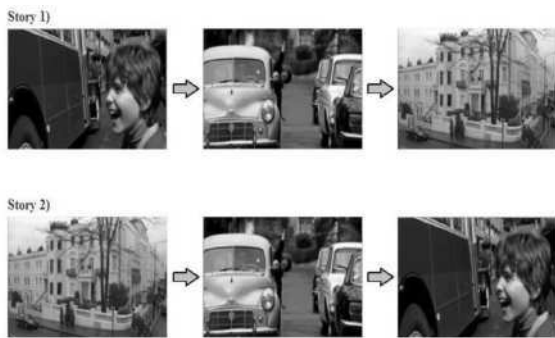

a. Making stories

- This is not a chair.
- This is _____.
- This has a character of _____.
- So I want to make a _____ of _____.



- This is not a basket.
- This is _____.
- This has a character of _____.
- So I want to make a _____ of _____.



c. Negation

Chair

- Shape and color of a chair?
- Sound of a chair?
- Feeling of a chair?
- Taste of a chair?
- Smell of a chair?

Time

- Shape and color of time?
- Sound of time?
- Feeling of time?
- Taste of time?
- Smell of time?

b. Sensitization

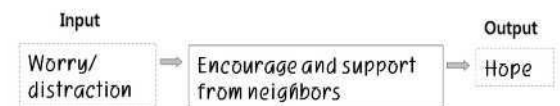
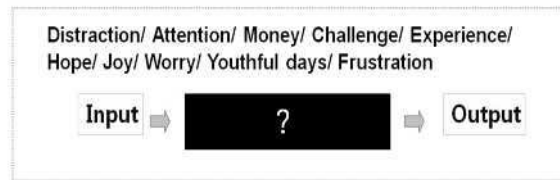

d. Filling black box



e. Diverse classification

Fig. 2. Five online tasks of the cognitive elements exercise program: making stories, sensitization, negation, filling black box, and diverse classification

concepts. The originality can additionally be enhanced by discovering distinctive connections between given input and output concepts.

(4) Sensitization: In the ‘sensitization’ exercise, the students are asked to express their feelings on the given physical objects and abstract concepts according to five different senses. In this activity, the problem sensitivity can mainly be developed to dig out potential characteristics of the given objects or concepts. In addition, this activity aims to develop the flexibility by describing concrete feelings on abstract concepts from the view of five senses.

(5) Diverse Classification: The final activity is the ‘diverse classification’ exercise. In this activity, the students are asked to classify the given objects in several different ways. Therefore, the flexibility can be mainly developed by considering diverse criteria to group the given objects in a different fashion. In addition, this activity aims to develop the problem sensitivity to understand the multiple characteristics of given objects.

4 Evaluation of Pre and Post Creativity

We conducted two assessments using conceptual design tasks to identify if there was enhancement of design creativity in the ability of the 5 cognitive elements. Pre-test and post-test were conducted in this regard, pre-test before the creative exercise program, post-test after the creative exercise program. The conceptual design results were evaluated based on the five cognitive elements of creativity by 4 domain experts with given evaluation guidelines. The calibration session was given to the 4 domain experts, and the inter-rater agreement of the Kappa value is presented in the result section, indicating “moderate agreement.”

4.1 Conceptual Design Task

The pre-test and post-test are conceptual design task to design the portable reading device. In the design task, during the first 10 minutes, the students had to produce as many ideas as possible for a portable reading device with given five clues: an accordion, a tape, a hinge, a toilet pump and a steel wire hanger. And, they should choose one of the ideas which they generated, and elaborate it with sketching and making detailed descriptions during next 20 minutes.

Table 2. Evaluation guidelines for the five design creativity elements, evaluating pre-test and post-test

Creativity Elements	Evaluation Guidelines
Fluency	Count the number of ideas generated. The more the ideas, the higher the fluency scores.
Flexibility	Count the category of ideas generated. The more the categories, the higher the flexibility score. Categories can be counted by grouping several ideas based on their similarity.
Originality	Evaluate the novelty of ideas generated. The rarer the ideas, the higher the originality score.
Elaboration	Evaluate the detailedness and degree of development of ideas. Consider the detailedness and completeness of developed ideas with sketches and descriptions.
Problem Sensitivity	Evaluate the appropriateness and fidelity of ideas to given problem. Consider how well the students reflect the intention of given problem in their ideas.

Figure 3 presents the form of conceptual design task, and two sample data of pre-test and post-test, collected from a student who got the enhanced cognitive elements of design creativity.

4.2 Evaluation Guideline

The results of pre-test and post-test, conceptual design task were evaluated based on the evaluation guidelines as presented in Table 2. A score between 1 and 5 (inclusive) is assigned to each creativity element. Fluency was evaluated by counting the number of ideas with which the students came up. In the case of the measurement of flexibility, the categories of generated ideas were counted. The originality measure was done by considering the novelty of the ideas in comparison with all other generated ideas and their distinctiveness. In the case of the elaboration measurement, the detailedness of the developed conceptual design was evaluated. Besides, the detailedness of the usage of the conceptual design that was required to be addressed. The problem sensitivity could be evaluated by considering how well the students reflected the issues of users or situations in which the portable reading device was used. If they identified the critical issues of the given design problem, their problem sensitivity scores could be high.

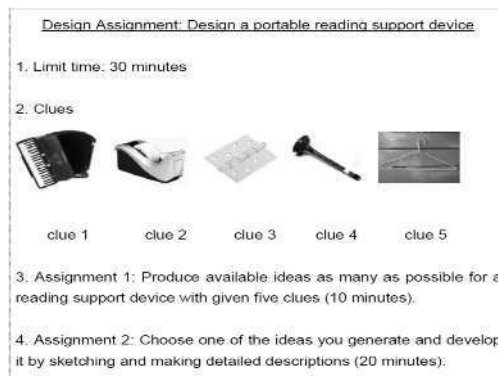

a. Conceptual design task

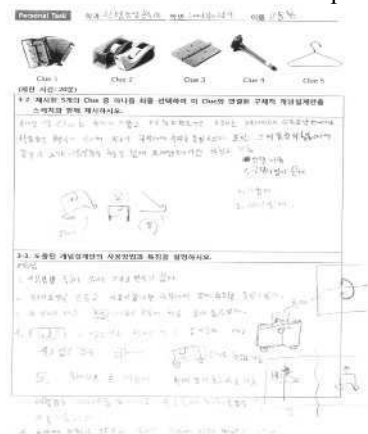

b. A sample of pre-test



c. A sample of post-test

Fig. 3. Conceptual design task, and two samples of pre-test and post-test acquired from a student. Conceptual design task is used for pre-test and post-test. Note that both samples of pre-test and post-test were evaluated by human experts

5 Results and Discussion

Forty four senior or first-year graduate students from the Interdisciplinary Design course at the Sungkyunkwan University participated in the experiment. Figure 3 shows examples of pre-test (b) and post-test (c) performed by a student. This example shows one sample case of the enhanced design creativity: The average score over the 5 cognitive elements of the post-test was increased by 1.05 from that of the pre-test. The assigned score range is between 1 and 5 (inclusive).

Four domain experts evaluated the conceptual design results. The Cohen’s Kappa value was computed from the assigned scores for inter-rater reliability. The overall Kappa value was 0.44 over the five cognitive elements and the significance of the acquired Kappa value is “moderate agreement.” The individual Kappa values were 0.35, 0.66, 0.34, 0.47, and 0.39, respectively for flexibility, fluency, originality, elaboration, and problem sensitivity

respectively. Fluency is considered as strongly reliable, compared to other cognitive elements.

Table 3. Paired t-test result with p-values between pre-test and post-test data

	t	p-value
Fluency	-4.103	0.000
Flexibility	-3.197	0.003
Originality	-5.367	0.000
Elaboration	-0.604	0.549
Problem Sensitivity	-0.623	0.537

5.1 Enhanced Design Creativity

As a result, 31 students out of 44 students showed the enhanced design creativity with regard to the 5 cognitive elements (70% increases), possibly indicating the effectiveness of the creativity exercise

program. The overall difference between pre-test and post-test are +0.86, +0.32, +0.65, +0.06 and +0.06, respectively for Fluency, Flexibility, Originality, Elaboration and Problem Sensitivity.

Further investigation with the t-test results provided us that there were 3 cognitive elements (Fluency, Flexibility and Originality) which are significantly different between pre-test and post-test, indicating the enhancements in the abilities of Fluency, Flexibility and Originality are statistically significant enough (Table 3). On the other hand, Elaboration ($t=0.604$, $p<0.549$) and Problem Sensitivity ($t=-0.623$, $p<0.537$) scores are not significantly different between pre-test and post-test.

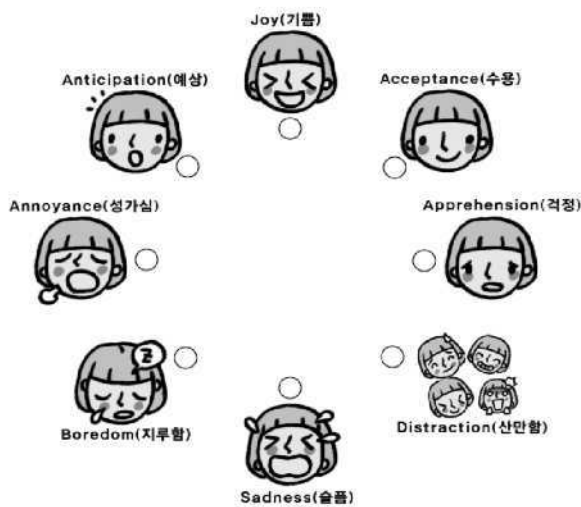

Fig. 4. Affective modeling with eight emotion elements

5.2 Affective Modeling and its Relation with Enhanced Design Creativity

In order to measure dynamic characteristics of students, and to investigate its relationships with the 5 cognitive elements, we incorporated affective modeling in the creative exercise program.

In the context of computer-assisted learning context of creative design capabilities, affective modeling of learners is being done using self-reporting format. Affective elements composed of joy, acceptance, apprehension, distraction, sadness, boredom, annoyance, and anticipation were identified based on the basic emotion categories proposed by Plutchik (Plutchik, 2010), which were used in the affective modeling of the study. The online form of dialog representing all the affective elements was devised and presented to students so that the participants can select one or more affective states during the experiment. Note that the affection capture diagram uses identical icons so that other influences than affective state selection could be isolated in the interaction of the diagram and the users as the diagram pops up and prompts affective state selection.

We conducted the online creativity exercise program with the affective model which is displayed to students for selections. The affective self-reporting was done after the learning objectives were given, after the specific problem statements were given and after the student problem sessions were done. While students conduct the exercise program, they are asked to self-report their affective states using an affective model diagram as shown in Figure 4.

The collected affective states were used for the investigation of relationships with the 5 cognitive elements of design creativity. A machine learning technique, Association Rules learning was used for this purpose. Table 4 shows the enhanced design creativity and its relationships with affective states. For example, if there is enhanced design creativity (post test > pre test) then students did not select the affective states of “Sadness” and “Apprehend” (Support: 0.66 with Confidence: 0.9). Generally speaking, the enhanced design creativity is reversely associated with negative affective states; students did not select negative affective states when there was enhancement in design creativity in the post-test. Rapidminer 5.0 was used in the study for running

Table 4. Association rules between cognitive elements and affective model elements

Premises	Conclusion	Support	Confidence
Distract = false, POST TEST > PRE TEST	Apprehend = false	0.62	0.92
Distract = false, POSE TEST > PRE TEST	Sadness = false, Apprehend = false	0.62	0.92
Sadness = false, Distract = false, POST TEST > PRE TEST	Apprehend = fasle	0.62	0.92
POST TEST > PRE TEST	Apprehend = false	0.66	0.90
POST TEST > PRE TEST	Sadness = false, Apprehend = false	0.66	0.90

machine learning techniques, such as Association Rules.

6 Conclusion

In the study, we identified the cognitive components of design creativity and proposed a creativity exercise program for cognitive elements of design creativity. This program could be used in helping students considering their individual needs and contexts, and enhance design creativity. Five cognitive components of design creativity were identified, and those are fluency, flexibility, originality, elaboration and problem sensitivity. The proposed exercise program for design creativity was composed of five different tasks such as making stories, negation, filling black box, sensitization and diverse classification.

In making stories, the students were required to produce several different stories by changing order of three different pictures. The aim of this task was to improve flexibility, originality and elaboration. The negation asked students to compulsively negate the given objects and contrive their alternate purpose or usage. Accordingly, the students' flexibility, originality and problem sensitivity could be enhanced. In filling black box, the students were supposed to logically connect given input and output concepts in as many possible ways within a limited time, and as a result, the fluency could be improved. The sensitization asked students to express their feelings on the given physical objects and abstract concepts according to five different senses. With this task, the problem sensitivity could be enhanced primarily and flexibility secondarily. In diverse classification, the students were asked to classify the given objects in several different ways. Therefore, flexibility was developed and problem sensitivity developed secondarily.

We conducted an experiment to investigate the effectiveness of the exercise program for design creativity cognitive elements. The results show that there was enhanced creativity, 31 students out of 44 students (70% increases) in terms of the cognitive elements, after students conducting the proposed creativity exercise program. Also, the machine learning results with affective model provided that there are relations between enhanced creativity in terms of cognitive elements and negative affective states, such as Sadness, Apprehend, Distract. For

example students did not select negative affective states when there was enhanced creativity.

More rigorous approach is desired to examine what cognitive elements could be effectively addressed in each task. This is challenging research because of uncertain factors and qualitative measurement of data. However, the research efforts would be helpful for design creativity education by considering individual's needs and contexts.

As a future work, thorough investigation of user data would be helpful in discovering meaningful results with regard to static and dynamic characteristics of user. Also, investigation of causal relationships between enhanced creativity, cognitive elements and affective states, using machine learning techniques such as Bayesian learning, will be important for the identification of factors causing the enhanced design creativity.

References

- de Bono E, (1992) *Serious Creativity*. Harper-Collins, London
- Goel V, (1995) *Sketches of thought*. Cambridge, MA: MIT Press
- Guilford JP, Hoepfner R, (1971) *The Analysis of Intelligence*. New York: McGraw-Hill
- Isaksen SG, Dorval KB, Treffinger DJ, (1998) *Toolbox for Creative Problem Solving*. Dubuque, IA: Kendall & Hunt
- Kim MH, Kim YS, Lee HS, Park JA, (2007) An underlying cognitive aspect of design creativity: Limited commitment mode control strategy. *Design Studies* 28(6):585–604
- Kim YS, Jin ST, Lee SW, (2010) Relations between design activities and personal creativity modes, *Journal of Engineering Design*, in print
- Kim YS, Kim MH, Jin ST, (2005) Cognitive characteristics and design creativity: An experimental study. In *Proceedings of the ASME International Conference on Design Theory and Methodology*, Long Beach
- Kraft U, (2005) Unleashing creativity. *Scientific American Mind* 16(1):17–23
- Park JA, Kim YS, (2007) Visual Reasoning and Design Processes. In *Proceedings of International Conference on Engineering Design (ICED)*, Paris
- Plutchik R, (2010) *The Nature of Emotions by Plutchik* [Online], <http://www.fractal.org/Bewustzijns-Besturings-Model/Nature-of-emotions.htm>
- Treffinger DJ, (1980) *Encouraging Creative Learning for the Gifted and Talented*. Ventura, CA: Ventura County Schools/LTI
- Urban KK, (1995) *Creativity-A component approach model*. A paper presented at the 11th World Conference on the Education for the Gifted and Talented, Hong Kong

Analogical Design Computing

DANE: Fostering Creativity in and through Biologically Inspired Design

Swaroop Vattam, Bryan Wiltgen, Michael Helms, Ashok K. Goel and Jeannette Yen

Development of a Catalogue of Physical Laws and Effects Using SAPPhIRE Model

Srinivasan V. and Amaresh Chakrabarti

Measuring Semantic and Emotional Responses to Bio-inspired Design

Jieun Kim, Carole Bouchard, Nadia Bianchi-Berthouze and Améziane Aoussat

Design of Emotional and Creative Motion by Focusing on Rhythmic Features

Kaori Yamada, Toshiharu Taura and Yukari Nagai

DANE: Fostering Creativity in and through Biologically Inspired Design

Swaroop Vattam¹, Bryan Wiltgen¹, Michael Helms^{1,2}, Ashok K. Goel^{1,2}, and Jeannette Yen²

¹ Design & Intelligence Laboratory at Georgia Institute of Technology, USA

² Center for Biologically Inspired Design at Georgia Institute of Technology, USA

Abstract. In this paper, we present an initial attempt at systemizing knowledge of biological systems from an engineering perspective. In particular, we describe an interactive knowledge-based design environment called DANE that uses the Structure-Behavior-Function (SBF) schema for capturing the functioning of biological systems. We present preliminary results from deploying DANE in an interdisciplinary class on biologically inspired design, indicating that designers found the SBF schema useful for conceptualizing complex systems.

Keywords: Design Creativity, Computational Design, Biologically Inspired Design, Biomimetic design

1 Introduction

Biologically inspired design uses analogies to biological systems to derive innovative solutions to difficult engineering problems (Benyus 1997; Vincent and Mann 2002). The paradigm attempts to leverage the billions of biological designs already existing in nature. Since biological designs often are robust, efficient, and multifunctional, the paradigm is rapidly gaining popularity with designers who need to produce innovative and/or environmentally sustainable designs. By now there is ample evidence that biologically inspired design has led to many innovative - novel, useful, sometimes even unexpected - designs (e.g., Bar-Cohen 2006; Bonser and Vincent 2007).

Despite its many successes, the practice of biologically inspired design is largely *ad hoc*, with little systematization of either biological knowledge from a design perspective or of the design processes of analogical retrieval of biological knowledge and transfer to engineering problems. Thus, a challenge in research on design creativity is how to transform the promising paradigm of biologically inspired design into a principled methodology. This is a major challenge because biology and engineering have very different perspectives, methods and languages.

We study biologically inspired design from the perspectives of artificial intelligence and cognitive science. From our perspective, analogy is a

fundamental process of creativity and models are the basis of many analogies. Biologically inspired design is an almost ideal task for exploring and exploiting theories of modeling and model-based analogies.

We have previously conducted and documented *in situ* studies of biologically inspired design (Helms, Vattam, and Goel 2009). We have also analyzed extended projects in biologically inspired design (Vattam, Helms, and Goel 2009). In this paper we describe the development and deployment of an interactive knowledge-based design environment called DANE, which was informed by our earlier cognitive studies and that is intended to support biologically inspired design. DANE (for Design by Analogy to Nature Engine) provides access to a design case library containing Structure-Behavior-Function (SBF) models of biological and engineering systems. It also allows the designer to author SBF models of new systems and enter them into the library. We present initial results from deploying DANE in a senior-level class on biologically inspired design in which teams of engineers and biologists worked on extended design projects (Yen et al 2010). The preliminary results indicate that although we had developed DANE largely as a design library, in its current state of development, designers found DANE more useful as a tool for conceptualizing biological systems.

2 Related Work

Biologically inspired design as a design paradigm has recently attracted significant attention in research on design creativity, including conceptual analysis of biologically inspired design (e.g., Arciszewski and Cornell 2006; Lenau 2009; Lindermann and Gramann 2004), cognitive studies of biologically inspired design (e.g., Linsey, Markman and Woods 2008; Mak and Shu 2008), interactive knowledge-based design tools for supporting biologically inspired design (e.g., Chakrabarti et al. 2005, Sarkar and Chakrabarti 2008; Chiu and Shu 2007; Nagle et al. 2008), and courses on biologically inspired design (e.g., Bruck et al. 2007).

Our work on DANE shares three basic features of similar interactive design tools such as IDEA-INSPIRE (Chakrabarti et al. 2005, Sarkar and Chakrabarti 2008). Firstly, both IDEA-INSPIRE and DANE provide access to qualitative models of biological and engineering systems. Secondly, both IDEA-INSPIRE and DANE index and access the models of biological and engineering systems by their functions. Thirdly, both IDEA-INSPIRE and DANE use multimedia to present a model to the user including structured schema, text, photographs, diagrams, graphs, etc.

However, our work on DANE differs from IDEA-INSPIRE and similar tools in three fundamental characteristics. Firstly, the design and development of DANE is based on our analysis of in situ cognitive studies of biologically inspired design (Helms, Vattam, and Goel 2009; Vattam, Helms and Goel 2009). Secondly, insofar as we know, IDEA-INSPIRE has been tested only with focus groups in laboratory settings. In contrast, we have introduced DANE into a biologically inspired design classroom. This is important because from Dunbar (2001) we know that the analogy-making behavior of humans in naturalistic and laboratory settings is quite different: in general, humans make more, and more interesting, analogies in their natural environments. Thirdly, while IDEA-INSPIRE uses SAPPiRE functional models of biological and engineering systems, DANE uses Structure-Behavior-Function (SBF) modeling (Goel, Rugaber and Vattam 2009). This is important because SBF models were developed in AI research on design to support automated analogical design (e.g., Bhatta and Goel 1996, Goel and Bhatta 2004). Thus, in the long term it should be possible to add automated inferences to DANE.

An SBF model of a complex system (1) specifies the structure, functions, and behaviors (i.e., the causal processes that result in the functions) of the system, (2) uses functions as indices to organize knowledge of behaviors and structures, (3) represents behavior as a series of states and state transitions that are annotated with causal explanations, (4) organizes the knowledge in $F \rightarrow B \rightarrow F \rightarrow B \rightarrow \dots \rightarrow F(S)$ hierarchy, and (5) provides an ontology for representing structures, functions and behaviors. Other researchers have developed similar functional models e.g., Kitamura et al. 2004 and Umeda et al. 1996.

3 The Design By Analogy to Nature Engine

In the long term, DANE is intended to semi-automate analogical retrieval and transfer in biologically inspired design. Presently, DANE interactively

facilitates biologically inspired design by (1) helping designers find biological systems that might be relevant to a given engineering design problem, (2) aiding designers in understanding the functioning of biological systems so that they can extract, abstract and transfer the appropriate biological design principles to engineering design problems, and (3) enabling designers to construct and refine SBF models of biological and engineering systems.

DANE employs a client-server architecture with a centralized design repository on the server-side. Each client is a thin client whereby all data is stored, updated, and recalled from the server. This architecture supports simultaneous access by multiple users and allows users to browse or edit the most current version of the repository.

DANE is a distributed Java application running on the Glassfish application server. Data is stored in a MySQL database, and we use EJB technology to handle persistence and connection pooling. Users access the application by going to a launch website that utilizes Java Web Start to both download and execute the application as well as apply any updates that have been made since the user last launched the application.

DANE's library of SBF models of biological and engineering systems is growing. In early fall of 2009, when we introduced the system into a biologically inspired design classroom, the library contained about forty (40) SBF models, including twenty two (22) "complete" models of biological systems and subsystems. The remaining were either SBF models of engineering systems or only partial models of biological systems. Biological systems in DANE were at several levels of scale from the sub-cellular to organ function to organism.

Systems are indexed by system-function pairs and retrieved by function name (e.g., "flamingo filter-feeds self"), by subject (e.g., "flamingo"), and/or by verb (e.g., "filter-feeds"). Function names often include additional specificity with regard to the objects upon which the function acts. In this case the flamingo is feeding itself. Upon selecting a system-function pair, users are presented with a multi-modal representation of the paired system-function (e.g. the "flamingo filter-feeds self" SBF model). For example, in DANE a system can be represented in text descriptions and images, as well as through visualizations of behavior and structure models. Example text and image modalities for the "flamingo filter-feeds self" model can be seen in Figure 1.

Briefly, this model describes how a flamingo uses its tongue to create negative pressure in its slightly open mouth to draw water in, closes its mouth, and then uses its tongue to force the water out through a filter-system composed of comb-like lamellae and

mesh. The lamellae trap the food, which is then drawn into the flamingo's esophagus in the next cycle.

Behavior and structure parts of the SBF models are themselves represented as directed graphs, which may be annotated with text descriptions and images. The nodes and edges represent either structural elements and connections (for structure models) or states and transitions (for behavior models), respectively. We provide an example of a partial behavior model, this time for the system "kidney filters blood," in Figure 2. Note that the annotations on the transitions in this figure are labeled with short-hand that denotes their type: [FN] X identifies that a transition occurs because of some sub-function X, and [STR_CON] X Y identifies that a transition occurs because of the connection between some structural component X and another structural component Y.

This "kidney filters blood" partial behavior model (a component of the larger SBF model) describes the movement of blood through the kidney through smaller and smaller vessels until the blood arrives at the nephron, where the filtration process takes place. Although in DANE the complete behavior model would be displayed, due to space constraints we only show in our figure a few states and transitions in this behavior. The sub-function "nephron purifies blood" serves as an index to yet another SBF model that describes this complex lower-level process in more detail. This provides an example of how SBF models are nested through function.

Additionally, each system is visually connected to other systems with which it shares a sub or super-function relationship. This functional hierarchy is represented as an interactive graph with nodes

representing systems and edges representing the sub/super relationships. Users may navigate between systems by double-clicking on a node. Figure 3 illustrates the functional hierarchy graph for the system "sliding filament model" and shows the browsing window with a few systems displayed, including the flamingo filter-feeding self function. The "sliding filament model" describes how muscle fibers contract, and thus the model is connected to a number of higher level animal functions (e.g. "flamingo filter-feeds self" and "basilisk lizard walks on water"), and is connected to a number of lower level molecular functions related to myosin and ATP. We can see in this one example how SBF models operate and connect functions at many scales.

By presenting complex systems in the SBF schema, which places an emphasis on the causal relationships within each system, and by making explicit the function/sub-function relationships between systems, we hypothesize that biologists and engineers will understand the systems in a way that (a) helps them identify systems that are relevant to their design problem and (b) is transferable to a design solution. For example, an engineer might scan models in DANE until he/she comes across a system that has a similar initial and objective state (a function) that matches his/her design problem. Then, by inspecting the structure and behavior of that system, the engineer might formulate a technological solution that implements a similar set of behaviors.

While SBF models can represent systems across multiple levels of scale and abstraction, and across the two domains of biology and engineering, the issue of knowledge engineering remains problematic. In

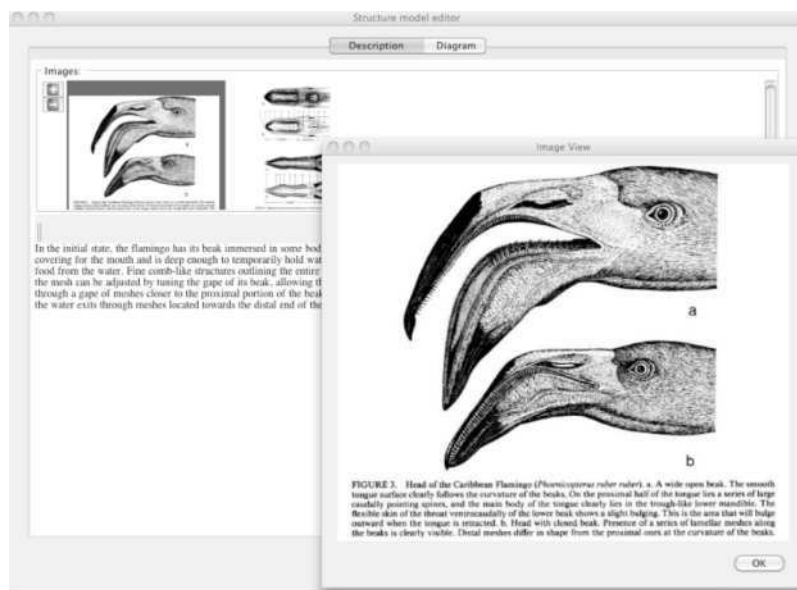

Fig. 1. Example of a multi-modal model of a flamingo's filter-feeding apparatus in DANE

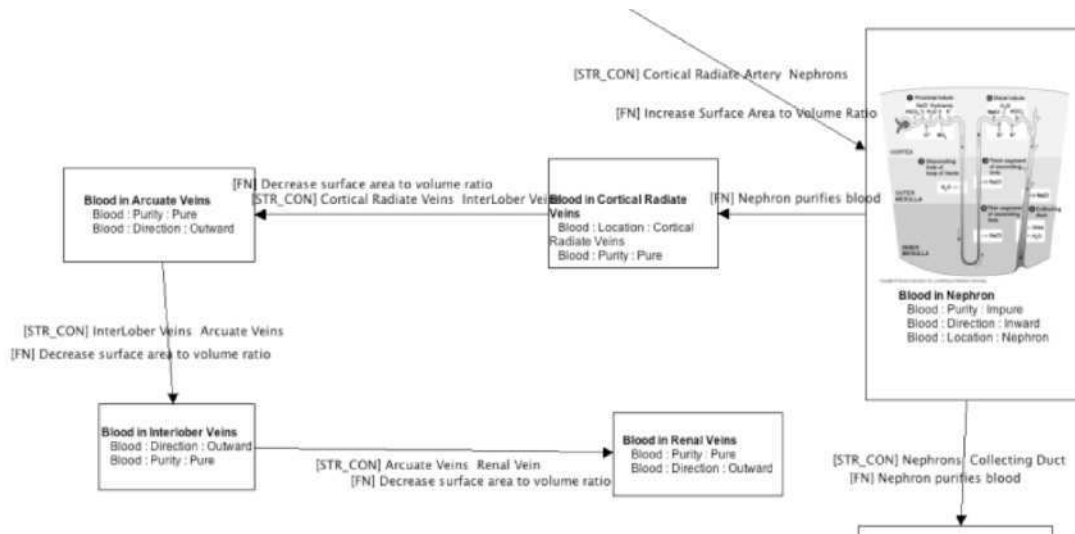

Fig. 2. Partial behavior model of “Kidney filters blood“ in DANE

particular, we found that constructing a “complete” SBF model of a complex biological system requires between forty (40) and one hundred (100) hours of work. The process of understanding the biological system (e.g. the kidney), modeling it in the SBF language, discovering faults in the model or in the modeler’s understanding, and iterating over this process consumed a large majority of the time. We estimate that just entering a complete model into DANE required somewhat less than 25% of the overall time cost.

4 Application Context

We deployed DANE in the Fall 2009 semester session of ME/ISyE/MSE/PTFe/BIOL 4803, a project-based, senior-level, undergraduate course taught by biology and engineering faculty affiliated with Georgia Tech’s Center for Biologically Inspired Design (Yen et al. 2010). The class composition too was interdisciplinary, comprising of 15 biology students, 11 mechanical engineering students, and 14 students from a variety of academic disciplines including biomedical engineering, chemical engineering, industrial engineering, material science, mathematics, and a few other engineering fields.

The course has three components: lectures, found object exercises, and a semester-long biologically inspired design team project. In the design project, teams of 4-6 students were formed so that each team would have at least one biology student and students from different schools of engineering. Each team was given a broad problem in the domain of dynamic, adaptable, sustainable housing such as heating or energy use. Teams are expected to refine the problem and then design a biologically inspired solution based on one or more biological sources to solve it. All teams presented their final designs during the end of the class and submitted a final design report.

The class is taught without any aids for design or research. Students are encouraged to perform their own research on biological systems through resources

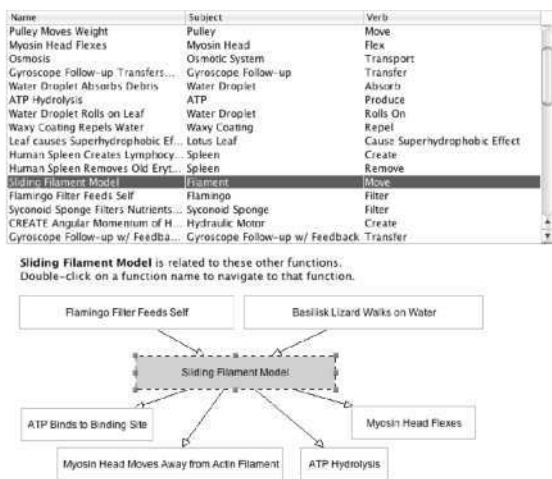

Fig. 3. List of functions and a functional hierarchy for “Sliding Filament Model” in DANE.

such as Google Scholar, Encyclopedia of Life, Web of Science, and Ask Nature. While these sources contain quality information, they typically return an overwhelming number of results, and results often are in a scientific language that is especially challenging for the non-biologists in the class to understand.

Further, students transmit information about their research to one another via PDF copies of scientific articles, meaning that all members of a team must read the raw sources. Explanations of these scientific articles within interdisciplinary teams highlight the knowledge gaps and cross-discipline communication challenges previously mentioned.

Our motivation for deploying DANE in this class was to measure its effectiveness in a classroom setting. Ideally, DANE would support biologically inspired design by exposing students to models of biological systems that would be represented in a way that is approachable by both biologists and engineers and useful to their class design projects. Although the classroom setting does not easily allow for formal controlled experiments and does not permit collection of certain types of data, it does enable observation of problem solving by real teams of people working in naturalistic settings as well as problem solving over an extended period of time. In our case, we felt that placing DANE *in situ* would provide a more accurate depiction of its usefulness, strengths, and weaknesses, as students might use it in ways that we did not anticipate and would only use it if they saw clear benefits to do so.

5 Training and Deployment

At the end of the third week of the class, our tool was introduced during class-time through an hour long tutorial session presented by the authors. Students were already comfortable with the idea of biologically inspired design, grouped in their semester design teams, and aware of their semester-long project.

The lesson began with a short discussion on the goal of DANE and an overview of SBF models. The point of this initial presentation was to motivate DANE, get students acquainted to the kind of representations that exist within the software, and provide some hands-on training with how to enter models into the system.

Once the tutorial session concluded, the students were told to direct any additional questions to an online web forum, accessible through the class portal that all students were familiar with using. We did not provide any more instructions to the students except to encourage them to use the application when they felt appropriate throughout the semester.

6 Results

The following five kinds of data were obtained during the deployment of DANE. (1) An online traffic counter recorded how many people used our application-launching web site, which gave us rough information on how often DANE was used, for students would visit the site to launch the application. (2) We kept a record of the models that were built in DANE by the students. (3) A log of the online troubleshooting forum was kept. (4) After the class, we interviewed a student from the class about her opinions and experiences with DANE. (5) The course instructors made available to us the final project reflections. In these reflections, students discussed the process by which they researched and designed their projects.

The traffic counter data (Figure 4) showed peak usages during the initial tutorial session and the days following when students received their individual credentials to use DANE and received moderate interest during the last half of the class, with slightly higher usage rates during the days around each of the three student project presentations.

We observed that 9 new models were entered into the system. All models were related to some biological system (e.g., “Baleen ram filter feeding apparatus”) or design idea (e.g., “Recycle Graywater”). Recall that a full system model in DANE contains a functional specification, a behavior model, a structure model, and textual descriptions and images for function, structure, and behavior. Of the models entered by students, all had functions, three had behavior models, two had structure models, and two had textual descriptions for their functions. None had textual descriptions for their behaviors or structures, and none had images. Qualitatively speaking, all the models entered by students were incomplete by our standards. However, as we will see in our interview, this did not necessarily

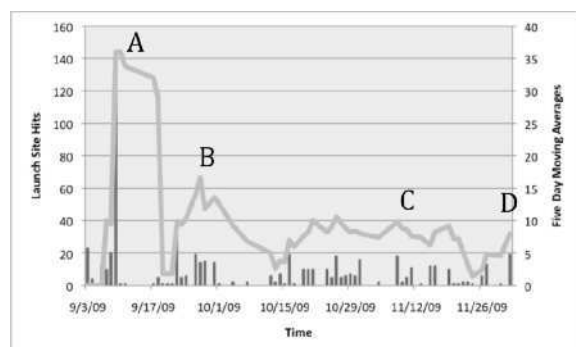

Fig. 4. Launch site traffic history. A marks the initial deployment. B, C, and D mark the project presentations.

mean the students found their own models unhelpful.

Our online troubleshooting forums contained four sub-sections: “Usability and Interface Issues” received 1 question; “Suggestions” also received 1 question; “How to Build Content” received 3 questions; and “DANE Bugs” received 2 questions. All the questions in the forum were technical in nature. No questions were about our representation schemata. The same student posted all the questions.

A 14-question interview about DANE was conducted after the semester was over with the student that posted the questions in our online forum. Although we recognize that a single student is not a sufficient sample for how the entire class felt about our tool, we felt this student in particular (due to her apparent engagement with DANE) could provide valuable feedback about the tool. The interview was taped and then transcribed with permission of the interviewee. Questions were both subjective (e.g., “Did DANE improve your understanding of biological systems?”) and objective (e.g., “Approximately how many hours, if any, did you use DANE?”).

When asked how she would rate the DANE training session from 1 to 10 with 10 being completely effective and why, the student said she would rate it a 9 because “it was reasonable that, like, everybody in the class would understand how to use DANE in that training session.”

Regarding her use of the tool, the student reported that she used it for approximately 20 hours and mainly before midterm and final class presentations because the professor gave extra credit if the team built a model on one of their 25 “inspired objects,” which were objects in nature from which they drew analogies. This answer correlates with the usage patterns. Students were encouraged before presentation dates to use DANE for extra credit, so they did, causing usage to peak during those times.

When asked how she would rate the importance of DANE to her semester-long project on a scale from 1 to 10 with 10 being of vital importance, the student gave a rating of 5, stating “it wasn't extremely, crucially vital, but it wasn't something that was not necessary” and “in the end we could've probably done without it, but I think it helped us to conceptualize.” Later in the interview when probed about what she meant by “conceptualize,” the student responded, “I mean, like, conceptualize, like, I think in boxes. Only because I'm in industrial engineering so I think in a lot of – I mean they look like flow charts. So that's what I like about DANE so I could, like...build a flow chart, essentially. From, like, the beginning stage to the end stage of a process.”

Not all responses were positive. When asked if DANE improved her understanding of biological systems, the student said no because, according to her,

“I wasn't looking up information. I was trying to input information into the database.”

Finally, when asked if she would recommend that other students use DANE, she answered yes, stating it's a “good resource” for “trying to build the analogies. And for like visualizing the connections, like the different properties. Like when my team first looked at it our overall function was regulate, and from regulate we had like regulate water, regulate energy, regulate heat, and you could just like break that up and you could go into DANE and see which- like we all independently like came up with objects in nature that had these properties and see if they were tied to each other.” In addition to analogy-making, she said that DANE would save herself and other students work if it contained a small set of systems that were relevant to the topic of the class, as this would be an easier database to browse than Google or Web of Science.

Students in the class were asked to write a final paper that reflected upon their experiences in the class. 36 such reflection papers were submitted. In six of those, DANE was mentioned by name. In two papers, both written by engineering students, the comments were explicitly positive (e.g., “I thought that DANE was a very useful tool to help decompose our system into its parts” and “A resource database (DANE!) would be VERY helpful in this class.”). In another paper, also written by an engineering student, the comments were explicitly negative (e.g., “DANE did not really help in our communication” and “it had good intentions, but I did not feel that it had great potential as an aide.”). The remaining three papers, all containing neutral statements, were written by one biologist and two engineers. More engineers than biologists mentioned DANE and only engineers had positive or negative opinions about it. Three of the six reflections mentioned DANE as a research repository, two described it as a modeling tool, and one described it in terms of aiding communication.

7 Challenges

Based on the observed results of our deployment, we have drawn several lessons. The first is overcoming the cost/benefit hurdle of systems requiring intensive knowledge engineering. Students were not willing to invest the time and effort to build models because they saw no personal benefit. Likewise, without a sufficient number of models, students found the system of little use as a reference resource. However, at 40 – 100 hours per model, building a library of sufficient breadth for general usability is a significant challenge.

The primary value to students of DANE was the use of SBF schema to (a) organize their understanding of systems, and (b) test their own ability to represent a design case. In our student interview, the student mentions that DANE was a useful tool for conceptualizing systems and in making analogies. Additionally, she said that the repository would improve her research process if enhanced with models that were relevant to the topic of the class. We had developed DANE mostly as a library of SBF models of biological systems, and the potential use of SBF schema as a conceptualization tool was mostly implicit in our thinking. We incorrectly assumed students would build and share models, which would incrementally enhance the value of the tool.

Although DANE only explicitly appeared in one-sixth of the final reflections, the perspectives provided are illuminating. We can clearly see that some students view it as a repository, some as a modeling/design environment, and at least one as a communication medium. These reflections act as evidence that, four months after the application's deployment, some students were still aware of DANE and thinking about it in terms that align with how we hoped they would think about it.

However, our other observations suggest that students were unconvinced of DANE's usefulness in whatever role they perceived it filling. Over half of the days the application was deployed received less than 10 hits; we had only one user engaged in our support forums; and our traffic peaks nearly always occurred during times when those peaks could be explained either by novelty (the peak right after the initial deployment/credential handout) or by an offer of extra credit (the peaks near the presentation times).

Another lesson comes from the quality of the student-built SBF models in DANE. The student models are incomplete, often specifying the functional parts but lacking the important associated behavior and structure models. Although the student we interviewed described our training session as effective, the model sparseness might suggest that students did not understand the training session. Alternatively, the models could be the result of students being uninterested in DANE and doing only the minimal amount of work required to get their extra credit, which returns us to the issue of motivation. The models could also be a symptom of students' not knowing their biological systems well enough to articulate them in a model.

8 Conclusions

In this paper, we described an interactive knowledge-based design environment - DANE - that provides access to a small library of SBF models of biological and engineering systems. We also described the deployment of DANE to help interdisciplinary design teams performing biologically inspired design in an extended design project in a classroom setting.

While our goal was to test our initial hypothesis that DANE would serve as an aid to assist biologists and engineers in (a) identifying useful solutions, and (b) in transferring solutions to a design solution, student engagement with the technology was too low in the classroom context to provide sufficient test data. Although we struggled with properly motivating DANE's usage and with gathering enough data to determine exactly how and why students were using it, we succeeded in the sense that the students were able to use DANE when they wanted and both the student we interviewed and two of the final project reflection journals said that DANE was a useful addition to their workflow.

Note that the results of our experiments with DANE are nowhere as neat or clean as those described by Sarkar and Chakrabarti (2008) in their work on IDEA-INSPIRE. We believe this difference is primarily because Sarkar and Chakrabarti report on controlled experiments with individual designers working on selected problems for short durations in laboratory settings. In contrast, we deployed DANE in a large design class, the designers worked in teams, the teams selected their own problems, the problem solving unfolded over a semester, and we had access to only a small portion of the design teams' work. It is for this same reason that we could not measure the efficacy of DANE for design ideation using quantitative measures such as frequency, novelty, variety, and quality (e.g., Shah, Smith and Vargas-Hernandez 2003).

On the other hand, the *in situ* deployment of DANE in a naturalistic setting led us to the result about DANE's utility as a conceptualization tool. Although we had developed DANE largely as a library of SBF models of biological systems that designers may access to address their engineering problems, we found that at this stage of its development, designers found DANE more useful as a tool for conceptualizing a complex system, with the SBF scheme enabling the designers to organize their knowledge of complex systems. We conjecture the utility of DANE as a design library may grow with the size of the library.

The lessons we learned emphasize the need for application deployment to be an iterative process and for early *in situ* deployment with target users. Had we developed DANE in isolation and only tested it in controlled situations, the problem of motivation and the insight into the importance of DANE as a conceptualization tool (as opposed to primarily as a repository) would have been difficult, if not impossible, to realize. More broadly, DANE suggests one way in which knowledge-based theories of functional modeling of complex systems may be used to support design creativity in and through biologically inspired design.

Acknowledgements

We thank Professors David Hu, Craig Tovey and Marc Weissburg who helped Jeanette Yen teach the ME/ISyE/MSE/PTFe/BIOL 4803 class in Fall 2009. We also thank the students in the class, including Jing Li. We are grateful to the US National Science Foundation for its support of this research through an NSF CreativeIT Grant (#0855916) entitled MAJOR: Computational Tools for Enhancing Creativity in Biologically Inspired Engineering Design.

References

- Arciszewski T, Cornell J, (2006) Bioinspiration: Learning Creative Design Principia. In Intelligent Computing in Engineering and Architecture, Lecture Notes in Computer Science 4200:32–53
- Bar-Cohen Y, (Editor, 2006) Biomimetics: Biologically Inspired Technologies. Taylor & Francis
- Benyus J, (1997) Biomimicry: Innovation Inspired by Nature. New York: William Morrow
- Bhatta S, Goel A, (1996) Model-Based Indexing and Index Learning in Engineering Design. International Journal of Engineering Applications of Artificial Intelligence, Special issue on Machine Learning in Engineering 9(6):601–610
- Bonser R, Vincent J, (2007) Technology trajectories, innovation, and the growth of biomimetics. Proceedings of the Institution of Mechanical Engineers, Part C: Journal of Mechanical Engineering Science 1177–1180
- Bruck H, Gershon A, Golden I, Gupta S, Gyger L, Magrab E, Spranklin B, (2007) Training mechanical engineering students to utilize biological inspiration during product development. Bionispiration and Biomemetics 2: S198–S209
- Chakrabarti A, Sarkar P, Leelavathamma B, Nataraju B (2005) A functional representation for aiding biomimetic and artificial inspiration of new ideas. Artificial Intelligence for Engineering Design, Analysis and Manufacturing 19:113–132
- Chiu I, Shu L, (2007) Biomimetic design through natural language analysis to facilitate cross-domain analysis. Artificial Intelligence for Engineering Design, Analysis and Manufacturing 21:45–59
- Dunbar K, (2001) The Analogical Paradox. In Gentner D, Holyoak KJ, Kokinov BN, (Eds.) The Analogical Mind: Perspectives from Cognitive Science, MIT Press
- Goel A, Bhatta S, (2004) Design Patterns: An Unit of Analogical Transfer in Creative Design. Advanced Engineering Informatics 18(2):85–94
- Goel A, Rugaber S, Vattam S, (2009) Structure, Behavior & Function of Complex Systems: The Structure-Behavior-Function Modeling Language. AI for Engineering Design, Analysis and Manufacturing 23:23–35
- Helms M, Vattam S, Goel A, (2009) Biologically Inspired Design: Products and Processes. Design Studies 30(5):606–622
- Kitamura Y, Kashiwase M, Fuse M, Mizoguchi R, (2004). Deployment of an Ontological Framework for Functional Design Knowledge. Advanced Engineering Informatics 18(2):115–127
- Lenau T, (2009) Biomimetics as a design methodology - possibilities and challenges. International Conference on Engineering Design, ICED'09 24 - 27 august, Stanford University, Stanford, CA, USA
- Lindemann U, Gramann J, (2004) Engineering Design using Biological Principles. In Procs. 8th International Design Conference - DESIGN 2004, Zagreb, 355–360
- Linsey JS, Wood KL, Markman AB, (2008) Modality and representation in analogy. AIEDAM: Artificial Intelligence for Engineering, Design, and Manufacturing 22:85–100
- Mak T, Shu L, (2008) Using descriptions of biological phenomena for idea generation. Research in Engineering Design 19(1):21–28
- Nagel R, Midha P, Tinsley A, Stone R, McAdams D, Shu L, (2008) Exploring the use of functional models in biomimetic concept design. ASME Journal of Mechanical Design 130(12)
- Sarkar P, Chakrabarti A, (2008) The effect of representation of triggers on design outcomes. Artificial Intelligence for Design, Analysis and Manufacturing 22(02):101–116
- Shah J, Smith S, Vargas-Hernandez N, (2003) Metrics for measuring ideation effectiveness. Design Studies 24(2):111–134
- Umeda Y, Ishii M, Yoshioka M, Shimomura Y, Tomiyama T, (1996) Supporting conceptual design based on the function-behavior-state modeler. AI EDAM 10:44: 275–288
- Vattam S, Helms M, Goel A, (2009) Nature of Creative Analogies in Biologically Inspired Innovative Design. In Proc. Seventh ACM Conference on Creativity & Cognition, Berkeley, California, October 27-30
- Vincent J, Mann D, (2002) Systematic Transfer from Biology to Engineering. Philosophical Transactions of the Royal Society of London 360:159–173
- Yen J, Helms M, Vattam S, Goel A, (2010) Evaluating biological systems for their potential in engineering design. In Proc. 3rd International Conference on Bionics Engineering, Zhuhai, China, September 2010, available as Advances in Natural Science 3(2):1–14

Development of a Catalogue of Physical Laws and Effects Using SAPPPhIRE Model

Srinivasan V. and Amaresh Chakrabarti
Indian Institute of Science, Bangalore, India

Abstract. This paper explains the development of a catalogue of physical laws and effects using SAPPPhIRE model. SAPPPhIRE (State change, Action, Parts, Phenomenon, Input, oRgans, Effect) model was found to describe outcomes in designing. In this paper we report on the relationships between SAPPPhIRE constructs, identified during the catalogue development. Issues and challenges faced while developing the catalogue and plans for further development of the catalogue are shown.

Keywords: catalogue, physical laws and effects, SAPPPhIRE model, novelty, creativity, product knowledge

1 Introduction

Several researchers pointed the importance of physical laws and effects in designing, particularly its positive influence on novelty of designs. Novelty is considered as one of the measures of design creativity. SAPPPhIRE (State change, Action, Parts, Phenomenon, Input, oRgans, Effect) model makes explicit use of physical laws and effects, and the model was found to describe and explain outcomes in designing. This paper briefs the development of a catalogue of physical laws and effects using SAPPPhIRE model and is intended to be used for assisting designing. We believe that the catalogue will help provide product-knowledge for designing, to support development of novel products.

2 Literature Survey

Novel means new and original, not like anything seen before, and novelty is the quality of being new and unusual and something that has not been experienced before, and so is interesting (Cambridge, 2009). Novelty resembles: something not formerly known (Sternberg and Lubart, 1999) and unusualness or unexpectedness (Shah et al., 2003). Infrequency (Shah et al., 2003; Lopez-Mesa and Vidal, 2006) and non-obviousness in patents (Franzosi, 2006) were used as measures of novelty. Novelty was considered as one of

the measures of creativity of engineering products (Shah et al., 2003; Lopez-Mesa and Vidal, 2006; Sarkar and Chakrabarti, 2008). Various researchers pointed the importance of novelty for its positive influence on the success of an enterprise, product, product quality, etc. (Westwood and Sekine, 1988; Ottosson, 1995; Molina et al., 1995).

Physical laws are defined as descriptions about the relationship between: physical quantities of entities and field (Tomiyama et al., 1989) and, an object's properties and its environment (Reich, 1995). Physical laws represent the functional connection between variables, geometrical parameters, material constants and basic constants (Zavbi and Duhovnik, 2000). Physical laws and effects are principles of nature that govern change (Chakrabarti et al., 2005). Zavbi and Duhovnik (2000) argued that if operation of existing technical systems can be explained using physical laws then, these can also be used to design similar kinds of systems. Physical laws are considered as a basic and rich source for designing; basic because no technical system operates contrary to laws, all systems are valid within the limits of physical laws (Tomiyama et al., 1989; Reich, 1995); rich source because each physical law can be materialized in several topologies, each topology in several forms and each form in several materials, thus a physical law, offers an opportunity to design a multitude of technical systems that differ in form, topology and material (Zavbi and Duhovnik, 2000). Designing using laws and effects prevents a designer's fixation on adaptations of the existing solutions or composition of solutions from the existing components (Zavbi and Duhovnik, 2001), thereby stimulating creative thinking by avoiding focusing on any particular solution (Burgess et al., 1995) and enhancing innovation especially at the conceptual level (Zavbi and Duhovnik, 2001). Savransky (2000) stressed that quite often knowledge of various effects is necessary for solving a technical problem, and each effect may be a key to solving a large group of problems. Studies of numerous patents indicated that strong inventive solutions are frequently obtained by

using effects that have rarely or never been used previously in a specific area of technology (Savransky, 2000). Hix and Alley (1958) pointed that a good knowledge of laws and effects helps in foresight of possible trouble areas in the early development stages of a project. In the absence of this knowledge, the existence of significantly, unexpected effects are often discovered late in the testing stage of product development. For the above reasons, Hix and Alley suggested that any development minded engineer should build a compilation of laws and effects through constant awareness. Koyama et al. (1996) supported the need for a database of natural laws (comprising physical laws and effects) because they provide important information for behaviour in the invention and development of products by supporting creative engineering. In their database, laws are represented by events separated into descriptions of the constraints on the way of viewing and behaviour of things. The way of viewing things comprises of physical quantities, constraints on the quantities and structure of things. The constraints on structure are represented using substances, fields and positional relationships among them. The constraints on a substance comprise its material, shape and spatial distribution. The behaviour of things is represented: qualitatively, in the form of processes, and quantitatively, in the form of equations involving physical quantities. Koller (1998) used the term 'working principles' to mean physical laws and effects, and considered them as an important source for innovation. He created a catalogue of working principles, structured using basic operations and required input-output combinations. Physical laws and effects in designing have been used in various ways in (Brown and de Kleer, 1983; Williams, 1991; Bratko, 1993; Chakrabarti et al. 1997, 2005; Zavbi and Duhovnik, 2000). Notwithstanding the pros of using physical laws and effects, issues still exist while using them especially in designing. Murakoshi and Taura (1998) pointed that synthesizing products directly from laws and effects is hard, since these have been discovered by scientists primarily for the explanation of phenomena rather than for synthesizing products that embody these phenomena. Savransky (2000) indicated that an ordinary engineer usually knows about hundred effects and phenomena, while there are many described in the scientific literature. Savransky (2000) and Cavallucci (2002) argued that since engineering students are not usually taught to apply these effects to practical situations, engineers and designers frequently face problems while using the effects. Chakrabarti and Taura (2006) demonstrated using existing systems the difficulties of using laws and effects in analysis and synthesis of systems. Therefore, in their current form physical laws and effects are inadequate in aiding designing.

Chakrabarti et al. (2005) developed SAPPhIRE (State change, Action, Parts, Phenomenon, Input, oRgans, Effect) (see Figure 1 and Table 1), a descriptive model of outcomes, to explain the causality of natural and engineered systems. Effect in SAPPhIRE comprises both physical laws and effects. Action, state change and input (three representations of function) together provide a rich description of function; phenomenon and effect together provide a rich description of behaviour; organs and parts together provide a rich description of structure (Chakrabarti et al., 2005). The relationships between the constructs are as follows: parts create organs; organs and inputs activate physical effects; physical effects create phenomena, which in turn create changes of state; changes of state are interpreted as actions or inputs, and create or activate parts. The model was found to describe analysis and synthesis of engineered systems (Srinivasan and Chakrabarti, 2009a), and outcomes in designing (Srinivasan and Chakrabarti, 2010a). Observational studies of design sessions revealed that designers (experienced and novice) naturally use all the SAPPhIRE constructs in designing but do not adequately explore phenomena, effects and organs (Sarkar and Chakrabarti, 2007; Srinivasan and Chakrabarti, 2010a). This may be because these designers lacked knowledge of these constructs and did not know how to use them in designing. Srinivasan and Chakrabarti (2010b) showed empirically that variety and novelty of created concept space depends on the number of solution outcomes that are explored at different abstraction levels of SAPPhIRE; higher number of outcomes explored at higher levels of abstraction resulted in higher values of variety and novelty of the concept space.

The literature survey can be summarised as:

- Novelty of designs is a measure of design creativity, and must be considered in designing.
- Physical laws and effects in designing have a positive influence on novelty but issues exist with using them directly in designing.
- SAPPhIRE model makes explicit use of laws and effects, and can be used to model outcomes in designing.
- Novelty of concept space depends on the number of SAPPhIRE solution outcomes explored during the creation of a concept space, but designers naturally do not explore adequate phenomena, effects and organs.
- Thus, it is important to support designers with the knowledge of phenomena, effects and organs to improve novelty of the created concepts.

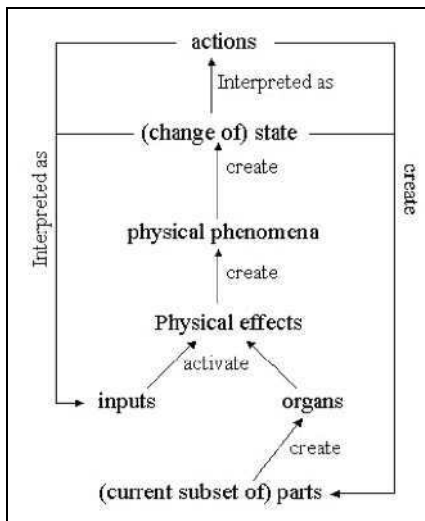

Fig. 1. SAPPPhIRE model (Chakrabarti et al., 2005)

Table 1. Definition of SAPPPhIRE constructs (Srinivasan and Chakrabarti, 2009a)

Construct	Definition
Ph	An interaction between a system and its environment.
S	A change in property of the system (and the environment) that is involved in the interaction.
E	A principle which governs the interaction.
A	An abstract description or high-level interpretation of the interaction.
I	A physical quantity in the form of material, energy or information, that comes from outside the system boundary, and is essential for the interaction.
R	Properties and conditions of the system and the environment required for the interaction.
P	Physical elements and interfaces that constitute the system and the environment.

3 Objective and Research Approach

The objective of this paper is to develop a catalogue of physical laws and effects using SAPPPhIRE model as the underlying structure, for providing product-knowledge during designing, to support design for novelty. The research approach is as follows:

(a) From sources of physical laws and effects (Hix and Alley, 1958; Young and Freedman, 1998), each law or effect is identified.

(b) From the available information about a law or effect we determine:

- (b.1) possible inputs and (sets of) organs required for activating the law or effect;
- (b.2) parts that can create the sets of organs;
- (b.3) phenomena created by the law or effect;

(b.4) state changes created by each phenomenon;

(b.5) actions interpreted from each state change.

(c) Steps (a) and (b) are repeated for each law and effect.

4 Observations

This section explains the observations made while carrying out Steps b1-b5.

4.1 Relationships between effect, input and organs

A relevant input and a set of organs are required for an effect to be activated. The same effect can have multiple incarnations, each different from the others in terms of input and organs. A few examples are:

(a) Newton's second law of motion ($F = m \times a$; F: force; m: mass; a: acceleration) (effect) has several incarnations. In one incarnation, the input is acceleration and the organs are constant mass, conditions of Newtonian mechanics, etc., resulting in a force in the direction of acceleration i.e., $F = m \times a$. In an another incarnation, the input is force and the organs are constant mass, conditions of Newtonian mechanics, etc., resulting in an acceleration in the direction of the force, i.e., $a = F/m$. In an another incarnation, the input is mass and the organs are constant force, conditions of Newtonian mechanics, etc., resulting in an acceleration in the direction of the force, i.e., $a = F/m$. In an another incarnation, the input is mass and the organs are constant acceleration, conditions of Newtonian mechanics, etc., resulting in a force in the direction of the acceleration, i.e., $F = m \times a$. Other incarnations of the law with force or acceleration as input, resulting in (addition or removal of) mass are also possible.

(b) Ohm's law ($R = V/I$; R: resistance; V: potential difference; I: current) (effect) has various incarnations. In one incarnation, the potential difference is the input and the organs are constant resistance, constant temperature, closed circuit, resistor made of Ohmic material, etc., resulting in a current flow, i.e., $I = V/R$. In an another incarnation, the current is the input and the organs are constant resistance, constant temperature, closed circuit, resistor made of Ohmic material, etc., resulting in a potential difference, i.e., $V = I \times R$. In a different incarnation, the resistance is the input and the organs are constant potential difference, constant temperature, closed circuit, resistor made of Ohmic material, etc., resulting in a current flow, i.e., $I = V/R$. In an another incarnation, the resistance is the input and the organs are constant

current, constant temperature, closed circuit, resistor made of Ohmic material, etc., resulting in a potential difference, i.e., $V = I \times R$.

A physical quantity is chosen as input if it can be categorised under material, energy or information; organs are those properties that remain constant while the effect is active. The above examples show that only a unique combination of an input and organs can activate a particular incarnation of an effect.

4.2 Relationships between organs and parts

Parts have elements and interfaces. Each set of organs of an incarnation of an effect can be embodied by multiple part-alternatives, shown by examples below.

(a) Force-deflection effect ($x = F/k$; F: force; k: stiffness constant; x: deflection) requires as organs: constant stiffness, fixture at one end and freedom at the other, if a force is input to get deflection. The set of organs can be embodied by a: tension spring fixed at one end and a force applied at the free end; compression spring fixed at one end and a force applied at the free end; cantilever beam with a force applied at any point other than the fixed end; etc. More variations can be obtained by changing the orientation of the spring or beam depending on the direction of the force and the required direction of the deflection.

(b) Charge-voltage effect ($V = Q/C$; V: voltage; Q: charge; C: capacitance) requires as organs: constant capacitance and constant temperature, if a charge is given as the input. The organs can be embodied by several part alternatives: parallel plate capacitors separated by a dielectric medium (plates can be horizontal, vertical or in any other direction), spherical capacitors, cylindrical capacitors, etc.

Elements and interfaces that comprise parts can create many sets of organs. Incarnations of relevant effects will only be activated if the right inputs for the relevant sets of organs are present. Note that the above examples give a description of the system (spring, beam) only with little or no description of its environment (for instance, temperature, pressure, friction of the medium surrounding the spring or beam). However, the definition of parts comprises the elements and interfaces of both the system and its environment. The potential organs for a given system and the environment consist of properties and conditions of the system, the environment and the system-environment interface. At times only a subset of this potential set of organs with the presence of relevant input will activate an incarnation of an effect. However, if an undesired input from within the system or environment also acts on the parts of the system and the environment, this input with the relevant subset of potential organs will activate another incarnation of

effects, which may be undesired. These undesired effects may disrupt the desired functioning of the system, and may be the cause of potential failures in the system.

4.3 Relationships between effect and phenomenon

An incarnation of an effect can create a phenomenon as shown by examples below.

(a) In force-stress effect ($\sigma = F/A$; σ : stress; F: force; A: cross-sectional area), when a force is input to a non-rigid object with no degrees of freedom in the direction of the force and with a uniform cross-sectional area normal to the force (organs), a stress is developed in the object in the direction opposing the force, creating 'stressing' as the phenomenon.

(b) In stress-strain effect ($\varepsilon = \sigma/E$; ε : strain; σ : stress; E: Young's modulus of elasticity), when a stress is input to a non-rigid object that has no degrees of freedom in the direction of the stress, at constant temperature, has constant Young's modulus of elasticity and Poisson's ratio throughout the material of object (organs), the object is strained in a direction depending on the nature of the stress, creating 'straining' as the phenomenon.

The same phenomenon can be created by many alternative incarnations of effects. For example, the phenomenon of expansion can be created by:

(a) Thermal expansion effect ($\Delta l = l \times \alpha \times \Delta T$; Δl : change in length; l: original length; α : co-efficient of thermal expansion; ΔT : change in temperature), when temperature difference is input to an object with constant length, uniform area of cross-section and constant co-efficient of thermal expansion throughout the material and given temperature range, the object expands according to the effect.

(b) Stress-strain effect ($\Delta l = (\sigma \times l)/E$; Δl : change in length; l: original length; σ : stress; E: Young's modulus of elasticity), when tensile stress is input to an object of uniform length, constant temperature, constant elastic properties, one end fixed and a degree of freedom exists in direction of stress, the object expands.

(c) Electrostriction effect, when electric field is input to a certain class of insulators or dielectric materials, the material expands.

(d) Charles's law $V = k \times T$; V: volume; T: absolute temperature; k: constant), when (high) temperature is input to an ideal gas of constant mass and at constant pressure, the gas expands.

4.4 Relationships between phenomenon and state change

A phenomenon can create multiple state changes simultaneously, as shown by examples below.

(a) The phenomenon of ‘expansion’ in solids can create changes in an object’s linear dimension (length, breadth and height) and volume. The phenomenon of ‘expansion’ in gases at constant temperature can change a gas’ volume and kinetic energy.

(b) The phenomenon of ‘cooling’ a body can change the body’s temperature, colour, electrical resistivity, etc.

A state change can be created by different alternative phenomena, as shown by examples below.

(a) A change in the temperature of a body can be created by one or more of the following phenomena: conduction, convection and radiation.

(b) A change in an object’s position can be created by one or more of the following phenomena: translation, and rotation.

4.5 Relationship between action and state change

The same state change can be interpreted as various alternative actions, each requiring additional premises for the specific interpretation. For example, a change in an object’s linear position (state change) can be interpreted as a ‘movement of the object’ (action), but only when taken with the premise that its position changes within a fixed reference frame. Alternatively, the same state change can also be interpreted as part of the action of ‘cleaning of space’, assuming that the object has dust-like properties and is moved out of the space that has to be cleaned. Another alternative action might be ‘dumping of the object’, with a premise that the object has lost contact with the surface with which it was formerly in contact. A change in the voltage in a circuit can be interpreted as, for instance, the following alternative actions: ‘generating electric voltage’ (assuming that the voltage increases from zero to some finite value in the circuit); or ‘measuring electric charge’ (when an unknown quantity of electric charge is taken as input to a known configuration of a capacitor to produce a change in the potential difference across the capacitor).

The same action can be satisfied by various alternative single or composite state changes. For example, the action ‘cooling of a body’ can be achieved by: ‘reducing temperature’ of the body with the premise that temperature is a measure of hotness or coldness of a body; ‘reducing the amount of heat stored’ in the body with the premise that cooling is defined as such; ‘changing the colour’ of the body because colour is an indication of the wavelength of

the radiation emitted from the body which indicates the amount of heat energy in the body. Similarly, the action ‘move body’ can be achieved, alternatively, by changing the following alternative states of the object: linear position, angular position or both.

4.6 Relationships among SAPPPhIRE constructs

Figure 2 shows the relationships between the abstraction levels of SAPPPhIRE for Ampere’s law. The law states that when a conductor carrying an electric current is placed in a magnetic field, it experiences a force. The magnitude of this force is proportional to the magnetic flux density, electric current, length of the conductor and the angle between the conductor and the magnetic flux density. The direction of this force is perpendicular to the length of the conductor and the direction of the magnetic field; $F = B \times I \times l \times \sin \theta$; F: force on the conductor; B: magnetic flux density; I: current through the conductor; l: length of the conductor; θ : angle between the conductor and the direction of the magnetic flux density. The arrows in the figure indicate the sequence in which the SAPPPhIRE constructs are determined. The figure shows four incarnations of Ampere’s law, each differing from others in terms of input and sets of organs. The organs required in each incarnation are different and hence, will need different parts for their embodiment (not shown in the figure). Each incarnation of the law creates a phenomenon; the first three incarnations create the same phenomenon while the fourth creates a different one. Both these phenomena create the same state change. Each state change is interpreted as different alternative actions. Even though the state change is same in both the incarnations, the context in which the state change happens is different, leading to differences in the premises and hence, difference in some actions.

4.7 Catalogue

Each entry in the catalogue (see Fig. 2) consists of an incarnation of a law or effect (consisting of the name of the incarnation, its textual statement (not shown in Fig. 2) and mathematical representation where available); an input and a set of organs required for activating the incarnation; the phenomenon created by the incarnation; possible state changes created by the phenomenon, and possible actions that can be interpreted from each state change. Information about parts is yet to be included in the catalogue.

5 Discussion

Catalogues of physical laws and effects already exist (e.g. Hix and Alley (1958); Koyama et al., (1996); Koller, (1998)). The catalogue shown in this paper involves structuring the knowledge of physical laws and effects using SAPPPhIRE model, something not attempted earlier. As mentioned earlier, the model provides a rich description of function, behaviour and structure. Thus, this catalogue can potentially provide a rich description of function, behaviour and structure.

SAPPPhIRE model was originally developed to explain the working of natural and engineered systems (Chakrabarti et al., 2005). The model used 'effects' as one of the abstraction levels through which the working of these systems could be explained. A database of natural and engineered systems was developed using SAPPPhIRE model by Chakrabarti et al., to support designers during ideation. But, earlier work was limited to study of laws and effects specifically from the point of view of existing natural and engineered systems. However, a much bigger set of laws and effects exists, not all of them are used in the existing systems. Thus, the catalogue shown in this paper allows a wider exploration of laws and effects, and its relationships with design.

It can be seen from the example (Figure 2) that the same law or effect, through its multiple incarnations, can satisfy multiple actions i.e., solve a variety of different problems. Each entry in the database of Koyama et al. (1996) has a description of laws; physical quantities and its constraints; description of structure comprising the constraints on objects, fields and relations between them. These parameters are broadly similar to effects, inputs, organs and parts in SAPPPhIRE model. Each entry in the catalogue of Köller (1998) is structured using the mathematical relationship of the effect, a principle sketch and an application of the effect; the effect and the principle sketch are similar to the effect and parts of SAPPPhIRE model. A description of a law or effect in (Hix and Alley 1958; Koyama et al., 1996; Koller, 1998) may not provide as much richness as demonstrated using SAPPPhIRE model.

Some relationships among SAPPPhIRE constructs as observed in this paper were pointed out earlier by Chakrabarti and Taura (2006), where these relationships were observed as various systems were analysed and synthesised using SAPPPhIRE model.

Empirical studies in (Srinivasan and Chakrabarti, 2010b) showed that inadequate exploration of phenomena and effects can hinder variety and novelty of designs. A framework for designing – GEMS of SAPPPhIRE as req-sol – which integrates activities (**Generate, Evaluate, Modify, Select**), outcomes

(SAPPPhIRE), **requirements** and **solutions**, was proposed as a support for design for novelty (Srinivasan and Chakrabarti, 2009b). The framework provides process-knowledge and prescribes that all activities should be performed at all the abstraction levels of SAPPPhIRE for both requirements and solutions. The relationships among SAPPPhIRE constructs shown in this paper are such that if one starts from an action and goes through state change, phenomenon, effect, input, organs and parts, one should end up with many part alternatives, thus contributing to variety and thereby increasing the chances of developing novel concepts. The catalogue is intended to be used as an aid for designers by supporting search at multiple levels of abstraction of SAPPPhIRE, thus providing product knowledge. For example given an action, designers can search the catalogue for possible state changes; for each state change they can search for possible phenomena and so on. We believe that the combined use of the framework and the catalogue will provide both process and product knowledge to further improve novelty of designs created.

Two or more entries from the catalogue can be combined to create interesting (novel) solutions. For instance, in the example (Figure 2), length is measured in terms of 'change in force' using an incarnation of 'Ampere's law'; this change in force can be measured in terms of 'change in voltage', using an incarnation of 'Piezoelectric effect'. So, length can now be measured in terms of change in voltage. Thus, several interesting solutions can be developed using the catalogue.

Some issues and challenges that arose during the development of the catalogue in this paper are as follows. The literature sources from which information about laws and effects were collected do not contain all the information necessary for constructing an entry in the catalogue. In some cases, the organs necessary for activating an incarnation of an effect requires knowledge of the domain to which the law or effect belongs. For example, all Newton's laws of motion are applicable only to rigid bodies (i.e., those that do not deform under the application of force) and their velocities are much less than the speed of light. Not all possible phenomena for an effect are available; sometimes no information is available on possible phenomena. Identification of all possible state changes also requires an overall understanding of the sciences involved; not all possible state changes can be identified unless all possible phenomena are identified first. Creating possible actions from a given state change involves interpretations with premises. This relationship between action and state change can be subjective and context-dependent.

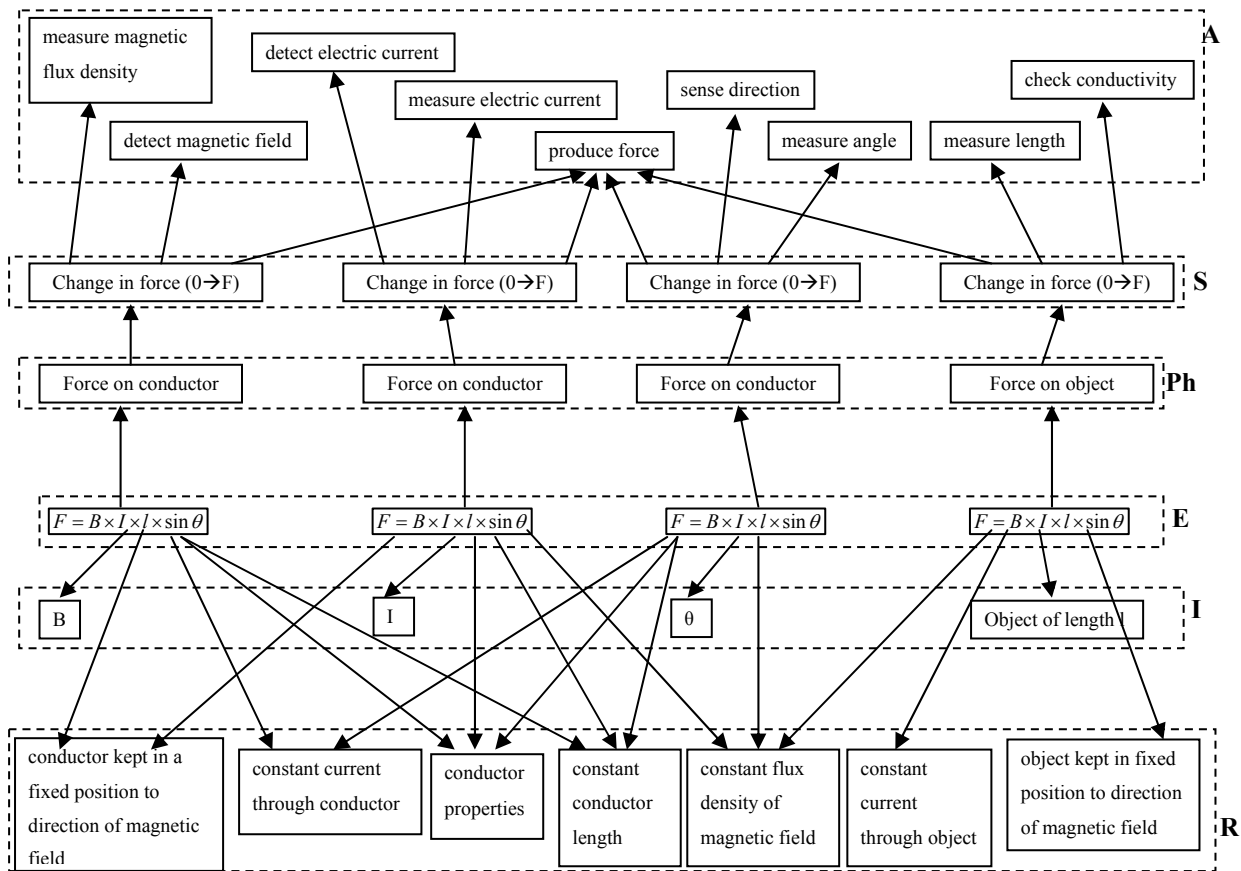

Fig. 2. Relationships between SAPPPhIRE constructs for Ampere's law

The current version of the catalogue is limited to single-input-single-output systems. As a result, some laws and effects could not be currently structured, e.g., Kirchoff's current law - the law states that the sum of incoming currents to a node equals the sum of outgoing currents from the node, conservation laws of mass, momentum and energy, all of which may involve multiple inputs and multiple outputs. However, possibilities exist for extension of the catalogue to accommodate single-input-multiple-output, multiple-input-single-output and multiple-input-multiple-output systems.

In the literature, effects and phenomena seem to be confused for one another. Most of the processes seem to have a phenomenon-like description and the governing laws or effects are sometimes missing. In our model, phenomena refer to the interactions between a system and its environment, while effects are the principles governing these interactions.

6 Summary and Future Work

A catalogue of physical laws and effects has been developed using SAPPPhIRE model. Relationships between SAPPPhIRE constructs have been identified during this catalogue development. Issues and challenges have also been highlighted.

In order to ascertain the influence of the catalogue on design novelty, an evaluation is planned using comparative observational studies of designers solving problems without and with the catalogue. The catalogue is currently supported in Microsoft Word™ and is inadequate for effective searches. The catalogue is planned to be implemented using a database and appropriate GUI to facilitate better usage and search. The catalogue currently only contains qualitative information; we plan to update it with quantitative information to facilitate both qualitative and quantitative search.

Acknowledgments

We would like to thank BSC Ranjan, Graduate student and Sai Prasad Ojha, Research assistant, of our laboratory for their contributions in building the catalogue.

References

- Bratko I, (1993) Innovative design as learning from examples. Proc. of International Conference Design to Manufacture in Modern Industries: 355–362
- Brown JS, de Kleer J, (1983) The Origin, Form, and Logic of Qualitative Physical Laws. *IJCAI-83*: 1158-1169
- Burgess S, Moore D, Edwards K, Shibaike N, Klaubert H, Chiang H, (1995) Design application: The design of a novel micro-accelerometer, Workshop on knowledge sharing environment for creative design of higher quality and knowledge intensiveness, validation and development of methods in the field of micromechanisms technology, Japan
- Cambridge online dictionary, (2009) <http://www.dictionary.cambridge.org/>, Cambridge University Press
- Cavallucci D, (2002) TRIZ, the Altshullerian approach to solving innovation problems. Engineering design synthesis - understanding, approaches and tools (Ed.: Chakrabarti A), Springer-Verlag: 131-149
- Chakrabarti A, Johnson A, Kiriyama T, (1997) An approach to automated synthesis of solution principles for microsensor designs. Proc. of ICED97, Finland: 125–128
- Chakrabarti A, Sarkar P, Leelavathamma B, Nataraju BS, (2005) A functional representation for aiding biomimetic and artificial inspiration of new ideas. *AI EDAM* 19(2):113-132
- Chakrabarti A, Taura T, (2006) Computational support of synthesis and analysis of behaviour of artefacts using physical effects: Some challenges. Proc. DESIGN 2006, Croatia. (CD proceedings)
- Franzosi M, (2006) Novelty and non-obviousness – the relevant prior art, URL: www.law.washington.edu/casrip/Symposium/Number7/
- Hix CF, Alley RP, (1958) Physical laws and effects. John Wiley and Sons, New York
- Köller R, 1998, *Konstruktionslehre für den Maschinenbau* (4th ed.). Springer-Verlag
- Koyama T, Taura T, Kawaguchi T, (1996) Research on natural law database. Proc. Joint Conf. Knowledge Based Software Engineering, Bulgaria: 242–245
- Lopez-Mesa B, Vidal R, (2006) Novelty metrics in engineering design experiments. DESIGN 2006, Croatia. (CD-proceedings)
- Molina A, Al-Ashaab AH, Ellis TIA, Young RIM, Bell R, (1995) A review of computer-aided simultaneous engineering systems. *Research in Engineering Design* 7(1):38–63
- Murakoshi S, Taura T, (1998) Research on the systematization of natural laws for design support. Proc. 3rd IFIP Workshop on Knowledge Intensive CAD: 141–160
- Ottosson S, (1995) Boosting creativity in technical development. Proc. of the Workshop on Engineering Design and Creativity, Czech Republic: 35–39
- Reich Y, (1995) A critical review of general design theory. *Research in Engineering Design* 7(1):1-18
- Sarkar P, Chakrabarti A, (2007) Understanding search in design. Proc. of ICED07, France (CD-Proceedings)
- Sarkar P, Chakrabarti A, (2008) Studying engineering design creativity – developing a common definition and associated measures. *Studying Design Creativity* (Ed. John Gero), Springer Verlag
- Savransky SD, (2000) Engineering of creativity – Introduction to TRIZ methodology of inventive problem solving. CRC Press
- Shah JJ, Smith SM, Vargas-Hernandez N, (2003) Metrics for measuring ideation effectiveness. *Design Studies* 24(2):111-134
- Srinivasan V, Chakrabarti A, (2009a) SAPPHIRE: An approach to analysis and synthesis. Proc. of ICED09, USA. (CD-Proceedings)
- Srinivasan V, Chakrabarti A, (2009b) Designing novel artifacts: A novel systematic framework. Proc. ICORD09, Bangalore, India: 67-75
- Srinivasan V, Chakrabarti A, (2010a) An integrated model of designing. *JCISE*, Special issue on Knowledge-based design, 10, Sept. (In press)
- Srinivasan V, Chakrabarti A, (2010b) Investigating novelty–outcome relationships in engineering design. *AI EDAM* 24(2):161-178
- Sternberg RJ, Lubart T, (1999) The concept of creativity: prospects and paradigms. *Handbook of creativity*, (Ed.: RJ Sternberg), Cambridge University Press
- Tomiyama T, Kiriyama T, Takeda H, Xue D, (1989) *Metamodel: A Key to Intelligent CAD Systems*. Research in engineering design 1(1):19-34
- Westwood ARC, Sekine Y, (1988) Fostering creativity and innovation in an industrial R&D laboratory. *Research-Technology Management* 31(4):16-20
- Williams BC, (1991) Invention from first principles: An overview. *AI at MIT expanding frontiers*, MIT Press, USA: 430 – 463
- Young HD, Freedman RA, (1998) *University Physics*. 9th edn., Addison-Wesley Publishing Company Inc.
- Zavbi R, Duhovnik J, (2000) Conceptual design of technical systems using physical laws. *AI EDAM* 14(1):69–83
- Zavbi R, Duhovnik J, (2001) Analysis of conceptual design chains for the unknown input/known output pattern. Proc. ICED01, UK: 53–60

Measuring Semantic and Emotional Responses to Bio-inspired Design

Jieun Kim¹, Carole Bouchard¹, Nadia Bianchi-Berthouze² and Améziane Aoussat¹

¹ Arts et Métiers ParisTech, France

² University College London, UK

Abstract. This research explores the relation between specific inspirations such as animals postures and the expressiveness of the design solutions provided by the designers. The prediction of semantic and emotional responses underlying animals' postures and attitudes might help designers to define design specifications and imagine design solutions with a high expressivity. To address this issue, an experiment was conducted with designers in watching six sets of animal posture images and corresponding product images. This experiment derived quantitative and qualitative results from the combination of cognitive/physiological methods: a questionnaire, Galvanic Skin Reponse (GSR), and eye tracking system.

Keywords: Biomorphism, Animal body posture, PCA analysis, GSR

1 Introduction

In the early stage of design, designers employ a large variety of types of inspirational sources from different areas: comparable designs, other types of design, images of art, beings, objects, and phenomena from nature and everyday life (Bouchard et al., 2008). These sources of inspiration are an essential base in design thinking such as definition of context, and triggers for idea generation (Eckert and Stacey, 2000). Indeed this kind of analogy helps them to provide a high expressivity, a high level of creativity, and a high emotional impact into the design solutions (Wang, 1995; Djajadiningrat, Matthews, and Stienstra, 2007).

Remarkably, among the various sectors of influence used by the designers, biologically inspired design proved to be a very efficient and creative way of analogical thinking (Helms, Vattam, and Goel, 2008). Some authors already demonstrated the positive effect of biological examples in idea generation (Wilson and Rosen, 2009). Especially, the use of animal analogies has proved to be very efficient for designers (see Figure 1). In some specific fields of design such as vehicle design animal analogies are prominent in the cognitive processes.

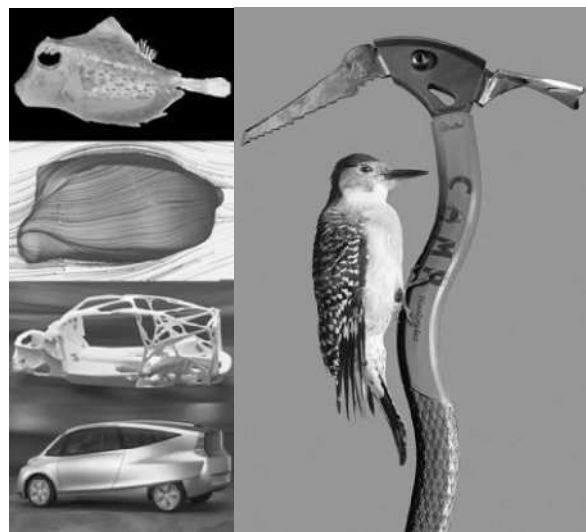

Fig. 1 Boxfish Mercedes Benz bionic car (left), CAMP woodpecker ax (right)

Up to date, however, there has been no study at the best of our knowledge that investigate the relationship between the semantic and emotion expressed by the inspirational source (e.g., an animal posture) and the emotions that the inspired design elicits in consumers. This is what our explorative study aims at.

This aim necessarily raised a question about assessment methods of semantic and emotional responses. In many cases, the cognitive measurement based on semantic differential approach has been extensively applied in emotional design and Kansei engineering. This cognitive approach has also been employed to assess the emotional responses. In particular, Self Assessment Manikin of Lang (1997) is a pictorial questionnaire in terms of arousal, valence, and dominance. In addition, a lexical emotional feeling, including a list of 50 emotional reaction proposed by the Psychology department of the Geneva University (1988) in Mantelet (2006) enables to evaluate emotional responses in a questionnaire.

Even though the cognitive approach is relatively simple, cheap and quick measurement, questions have

been raised about some disadvantages to apply. First, cognitive measurement is not able to assess in real time; and it is hard to catch objectively a subtle emotional state. In addition, the use of emotional scales which often contains a long list of emotion adjectives might cause respondent fatigue. Moreover some of respondents have difficulties in to expressing their feeling because they are not always aware of them and/or certain pressure from social bias (Poels and Dewitte, 2006).

In order to account for the limitation of cognitive measurement of emotional responses, recent studies in Kansei engineering start to triangulate these measures with physiological responses such as Electromyography (EMG), Galvanic Skin Resistance (GSR), heart rate and electroencephalography (EEG) etc. Undoubtedly, unnatural, obstructive and heavy instrument might interfere with respondent's natural way of design and influence on the results; however, applying physiological measurement under careful consideration could deepen our understanding of some respondent's unconscious emotional process (Tran et al., 2003; Gaglbauer et al., 2009).

Hence, for the purpose of measuring semantic and emotional responses in front of bio-inspired design, we intended to apply both cognitive and physiological measurement in our experiment. The use of specific instruments and protocol are described in Part 2. Both qualitative and quantitative results are presented in Parts 3 and 4. Finally, the paper concluded by suggesting future work and by including some considerations regarding the need for deepening on this study.

Original research advances will be provided in the following areas: cognitive/physiological evaluation and prediction of emotions from postural information.

2 Design of Protocol Study

2.1 Cognitive Measurement: Questionnaire

From the work done by Mantelet (2001), we have developed a questionnaire by following five steps: *Definition of the Image stimulus, Definition of the lexical corpus (emotions, semantic adjectives), Definition of the questionnaires (Java algorithms), Data gathering, Data analysis, and interpretation of the results.*

2.1.1 Definition of the Image stimulus

As the first step, we gathered six sets of bio-inspired design examples (see Figure 2). The criteria of selecting image stimulus was the name of vehicle such as Beetle from Volkswagen (A2-P2), Audi Shark (A4-P4) and Dodge Viper from Chrysler (A6-P6), and also the similarity of animal body posture selected by designers.

All images stimuli were presented to participants in grey scale with a resolution of 1024x768. Under highly controlled conditions, participants could concentrate on the given images so that we could minimize other possible interruptions, including chromatic effect and experimental environment etc.

2.1.2 Definition of the lexical corpus (emotions, semantic adjectives)

The four designers were asked to provide a list of semantic descriptions by manually annotating the set of images. In order to explore the link between the inspirational source and the product, designers were divided in two groups. One group was asked to annotate the six inspirational source images (A1~A6), the other group was asked to provide a set of semantic descriptions to describe the product images (P1~P6). Finally, the semantic descriptions retained are as follows:

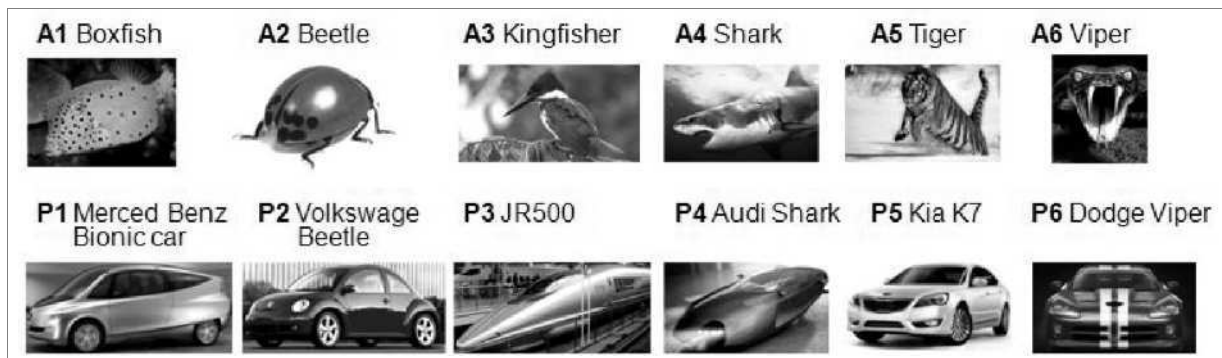

Fig. 2. Bio-inspired design examples

- **Semantic descriptions for inspirational source (A1~A6):** *Elegant, Appealing, Soft, Powerful, (Lively), Rapid (Speed), Sharp, Aggressive, Fluid, Light*

Semantic descriptions for product (P1~P6):
Angular, Aggressive, Retro, Appealing, Light, Organic, Sportive, Futuristic, Aerodynamic, Natural

Following a similar protocol, the designers were also asked to provide the emotional terms elicited in the same set of images. Since emotional terms which reflect secondary emotion are relatively hard to express in lexical way, a lists of 20 emotional terms extracted by Geneva university (1988) was made available to the designers during the annotation process. The designers were however free to use any emotional terms even if not in the provided in the list.

The retained emotional terms were: *amused, calm, pleasure, inspired, stimulated, anguished, indifferent, doubtful, astonished, and tender*. In addition, the designers were asked to evaluate the images in terms of valence and arousal by using the Self-Assessment Manikin (SAM) scales of Lang (1997).

2.1.3 Definition of the questionnaire

The questionnaire consists of three types of slide: *Preparation slide, Stimuli slide and Rating slide*.

- *The Preparation slide* is a blank page in order for the participants to rest and stabilize their emotional state before watching the next stimuli slide.
- *The Stimuli slide* holds each image stimulus chosen in Figure 2.
- *The Rating slide* consists of three types of questionnaire.
 - The Self-Assessment Manikin (SAM) scales of Lang (1997) in terms of valence and arousal with its pictorial image.
 - The list of 10 emotional terms to be rated on 5-point rating scales (from 1= 'Not at all' to 5 = 'Very much') each.
 - The list of 10 semantic descriptions (either for product or for inspirational source) to be rated on 5-point rating scales (from 1= 'Not at all' to 5 = 'Very much') each.

Following Lang's method (1997), each test began with a preparation slide that lasted for 5 seconds. Then, a stimuli slide was presented for 6 seconds. Finally, the participants were asked to fill in the questionnaire in the rating slide. During the rating

slide, a small thumbnail image was displayed for helping the designer's evaluation process. The 11s loops (Preparation slide → Stimuli slide) were the same for each image stimulus. Once rating slide was over, the computerized preparation slide was then activated until all images stimuli to be rated.

Instead of using paper based questionnaire, the questionnaire was integrated in SMI eye tracking system (Figure 3b). This method enables to collect participant's simultaneous responses during task through recording eye movement and facial expression. Most of all, it enables to record automated input time in questionnaire, so that physiological data could synchronize with questionnaire.

2.2 Physiological Measurement: Galvanic skin Response (GSR)

For our exploratory study, a selection of physiological measurements was essential to detect emotional responses of bio-inspired images and identify a correlation between cognitive measurement and physiological measurement. Our criteria to determine the biosensors were non-obstructiveness, easy interpretation of signals and high reliability.

Hence, we intended to apply galvanic skin response (GSR) which could indicate effective correlation to arousal. Significant advantage of GSR is that GSR could provide continuous information and detect very sensitive amount of arousal (Tran et al., 2007; Gaglbauer et al., 2009).

In addition, even though, the results from eye tracking system will not be described in this paper, we expect that a physiological phenomenon gathered by eye tracking system such as fixation number/duration, pupil size, and blink rate/duration could provide supportable results.

In order to employ GSR, the two GSR electrodes were places on two fingers of the left hand. Changes in the skin conductance were collected at 200Hz per second. Using the BIOPAC acquisition unit and the software BSLPro 3.7, we could amplify the collected signal and visualize it (Figure 3).

2.3 Data Gathering

Six master degree product designers in laboratory CPI have been involved in our experiment. They were all French students (Five females and one male). Participant were divided in two groups: one group was to rate inspirational source (A1~A6), the other was to rate product image (P1~A6).

Generally, the experiment took in average 17,14 minutes (standard deviation was 2,1 minutes).

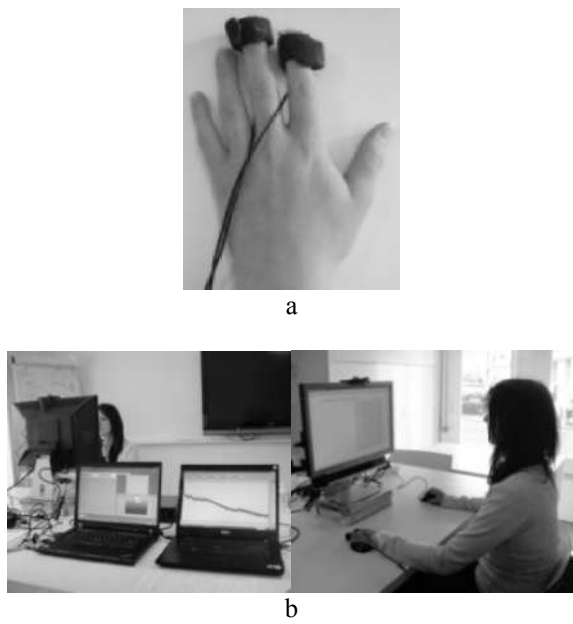

Fig. 3. System setup: a. GSR; b. SMI eye-tracking & BIOPAC system

2.4 Data Analysis

The data from the questionnaires were analyzed by Principal Component Analysis (PCA). PCA was employed separately to the data from the rating of the inspirational sources and the data from the rating of the product images. The aim was to explore the way semantic and emotional terms used to rate the correlations between semantic and emotional responses (Mantelet, 2003; Bouchard et al., 2008; Nagamachi et al., 2009).

In order to analyze GSR responses, first, the segment of 11 seconds corresponding to the preparation and stimuli slides were extracted. Next, as large inter-individual differences were expected, we normalized the GSR values [0,1] each using the following formula: $Normalized_GSR = (original_GSR - max_GSR) / max_GSR$. Finally, the normalized GSR values of six participants were averaged in time.

3 Results

3.1 Correlation of Semantic Descriptions

Figure 4 shows the position of the ten semantic descriptions (diamond) and the images (dot) each in the extracted principal component sphere. Given that cumulative contribution of PCA shows the

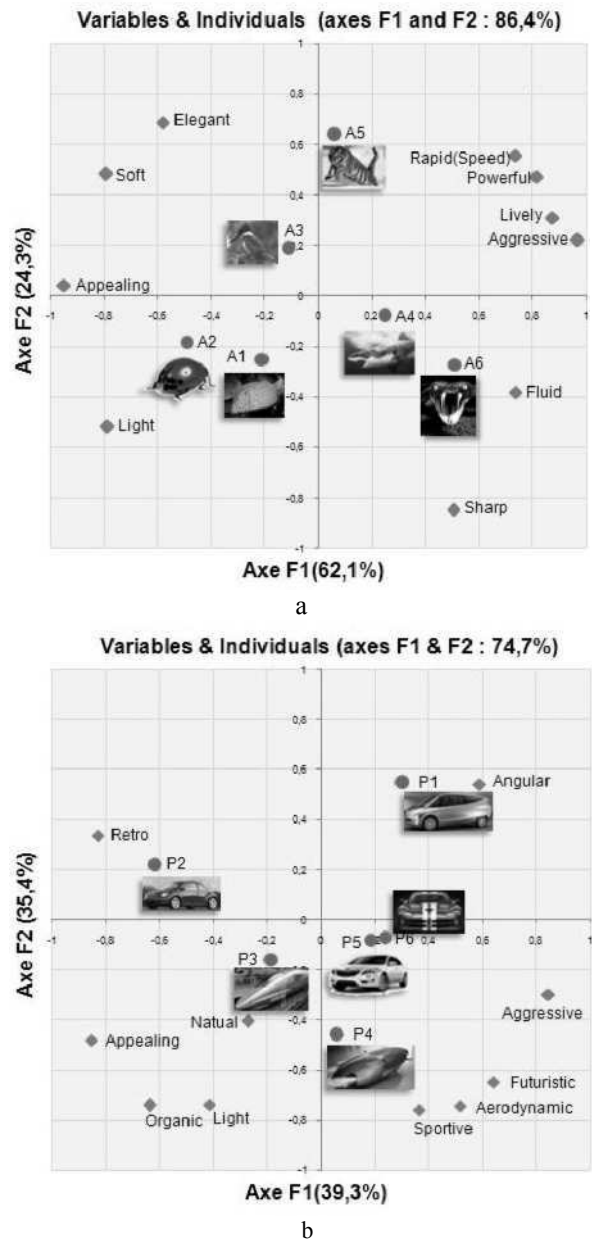

Fig. 4. a. PCA of semantic descriptions on animal image; b. PCA of semantic description on product image

correlations between semantic descriptions, two factors (F1&F2) can explain 86,4% of the data concerning the animal images (Figure 4a). In case of the product image (Figure 4b), the contributions are focused on 74.1% for two factors (F1&F2). Both cases have a common axis which represents 'aggressive – appealing'.

With regard to the interpretation of axis, we found that there are some differences about inspirational sources (animal) and product image. For example, in case of animal sources (Figure 4a), semantic

description *aggressive* was very close to *rapid (speed)*, *powerful* and *lively*. On the other hand, the notion of *aggressive* about product image was closer to *sportive*, *futuristic*, and it was far from *retro*.

In case of product images (Figure 4b), semantic description *appealing* was close to *soft* and *elegant* and far from *sharp*. In case of product image, *appealing* was more linked to *natural*, *organic* and *light* and far from *angular*.

Between the relation of inspirational source and product, we could observe the strong similarities in terms of semantic descriptions between A2-P2, A4-P4 and A6-P6.

3.2 Correlation Related to Emotional Terms

In order to identify the correlation related emotional terms, we also applied PCA analysis of emotional terms on the inspirational source image and product image. As shown in Figure 5a, the contributions were focused on F1 (20.4%) and F2 (47.8%), totally 68.2% for two factors. The principal axes were confirmed *positive-negative* and *high-low arousal*.

The results show that positive valence reflects some complementary emotions including: *pleasure*, *amused*, *inspired*, and *tender*. High arousal related to *angushed* and *astonished*. High arousal ratings were assigned to A4-P4 and P5. Relatively, A3, A5, P2, and P6 received lower ratings.

Figure 4(b) shows the normalized average GSR value for 11 seconds i.e., 5 seconds for the preparation slide and 6 seconds for the stimuli slide as indicated respectively by the white and grey region of the image. This graph employed the same color code for the paired images. A dotted line represents animal images (A1~A6) and a continuous line represents the product images (P1~P6).

As GSR sensors measure skin conductivity which usually associated with arousal, we are interested in the peak and troughs of GSR data (Figure 5b). Specifically, we analyze a similar amplitude augmentation tendency between paired-images (animal – product) in watching stimulus slide.

As shown in Figure 5b, the baseline for the animal images (resting state) was always higher than the ones for the product images except for the Volkswagen Beetle (P2). The normalized average GSR of product images started at low level; however GSR data suddenly increased and show a peak in stimuli slide. Most interesting finding is that the GSR data of all the image stimuli arrive at similar peak value (around 1), even though the rising time of GSR data was different.

Given the correlation of animal images and corresponding product images, A2-P2, A4-P4, and A6-P6 images have significantly similar tendency of GSR data in time. However, it was hard to explain the correlation of GSR data between A1-P1, A3-P3, and A5-P5.

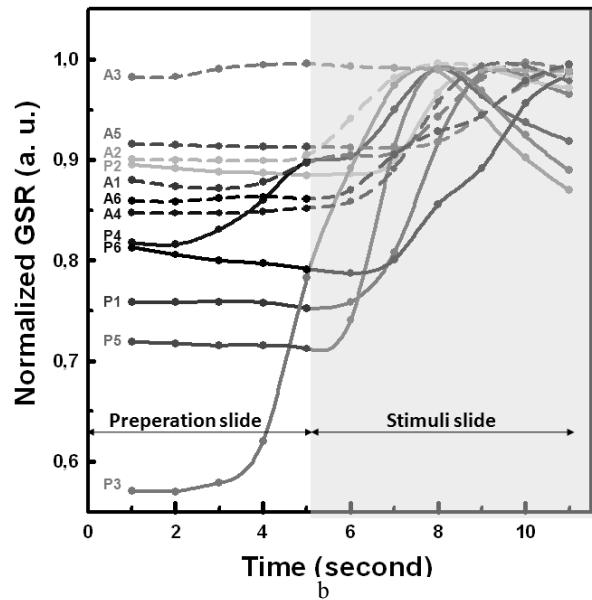
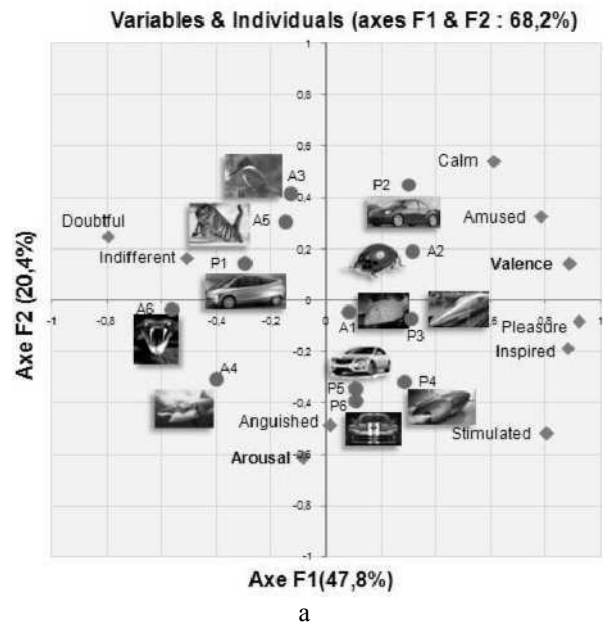

Fig. 5. a. PCA of emotional terms for animal images and corresponding product images; b. Change of the normalized average GSR for 11 seconds

4 Discussion

4.1 Various Aspects for Measuring Emotional Impact on Bio-inspired Design

In our specific experiment, we attempted to explore the relation between body posture of animals image and product image, in conjunction with emotional and semantic responses. A cognitive and physiological method was employed to answer those issues. Hence, interpretation of results through balancing the data from cognitive approach and physiological approach was a crucial factor.

As mentioned above, some paired images (A2-P2, A4-P4, and A6-P6) have showed a common emotional state in both PCA results and similar amplitude augmentation tendency (Figure 4 and 5). However, the other pairs cannot give any remarkable results. This may be partly explained by the following two points.

First, we assumed that a level of recognition of image might influence on both cognitive and physiological evaluation. In our experiment, as Volkswagen Beetles (P2) and beetles images is very famous biological inspired car through their original name and the advertisement, the experiment also confirmed with high correlation between two images in terms of semantic and emotional responses. In comparison, the pairs of A3-P3 and A5-P5 have little correlation in both PCA results and GSR data. An explanation for this, since the participants were all French student, they were not relatively aware of P3 (JR500-Japan) and P5 (Kia K7-Korea).

Second, the finding raised some issues about methodological condition. Given that the presenting image size was all unified in screen size (1024*768 resolution), this led the lack of consideration on a real size of animal and product. Those images can not sufficiently express their own semantic and emotional attribute. We found that tiger image (A5) and viper image (A6) cannot sufficiently convey their attitude and impression from a posture.

5 Towards Modeling the Attitude and Posture of Animals

Previous behavioral studies have been discovered human body posture and movement as an important affective communication channel. Berthouze et al. (2003) recently reviewed the state of the art on this topic. According to Mehrabian and Friar (1969), changes in a person's affective state in the work done by are reflected not only by changes in facial

expressions but also by changes in body posture. They found that bodily configuration and orientation are significantly affected by the communicator's attitude toward her/his interaction partner. Ekman and Friesen (1967) have hypothesized that postural changes due to affective state aid a person's ability to cope with the experienced affective state.

Despite those studies, there has not some studies focused on the attitude and posture of animal and its emotion. Only few studies have been pioneered to explore 'pleasant' and 'threatening (fear)' animals, plant, fruits, or flowers (Hamm, Esteves, and Öhman, 1999; Tripples et al., 2002; Field and Schorah, 2007).

Meanwhile, this interest led to create models that maps body expression features into emotional states. According to Rudolph Laban (1988), various types of approaches have been taken to measure postures and movement and statistically study this relationship. Wallbot (1998) showed the existence of emotion-specific body-expression patterns that could be partially explained by the emotion dimension of activation. Using motion-capture techniques and an information-theory approach, Berthouze et al. (2003) identified a set of body configuration features that could be used to discriminate between basic emotion categories.

As our next step, we are planning to follow the approach proposed by Berthouze (2003), to perform a more thorough analysis of the shape of the product and of the animal posture to identify particularly expressive postures and attitudes features (e.g. angle between body segments, muscle tension) and body parts that are responsible for these responses.

Finally, those studies would enable to develop computer aided design (CAD) tools. These CAD tools will help designers to generate expressive and user-friendly design solutions for the consumers. We hope new designs will appear on the market in the future, which is oriented towards more pleasurable products in the sense of D. Norman (2002).

6 Conclusion

This study aimed to explore the relation which establishes a formal connection between bio-inspired sources and the design solutions produced by the designers in specific fields such as car design. Further study must be needed toward creating computational models to predict emotional/semantic responses to body posture of animals, in order to provide design rules based on analogical reasoning through biomorphism. In short term, we will investigate to refine the results from physiological signal not only through GSR signal, but also eye tracking including

fixation number and duration, eye-blinking frequency, pupil dilation, etc. during stiluli slide.

In terms of research impact, the results of our approach will benefit several disciplines such as emotional design, marketing, innovation science, psychology and robotics.

In the field of design, as a growing trend is emerging toward the emotional design and pleasurable products, this promises friendlier world of products and services, with more attention paid to the human beings. In addition, this interest is also a manner of increasing the degree of creativity and innovation into the design and engineering design processes.

Moreover the comparison between different ways of measuring emotions about specific stimuli will also be of great interest for the discipline of psychology. Finally, the field of robotics which already integrates some advances in the field of biomimicry (applied to robots behaviors) could benefit of these new results in order to improve the look and user-friendliness of the robots.

Acknowledgments

The authors wish to thank the designers from LCPI, Arts et Metiers ParisTech who participated in our experiment. Special thanks to Dr. Florent Levillain, Laboratory of Cognition Humaine & ARTificielle (CHArt), University Paris8 for sharing his expertise in analyzing the physiological data.

References

- Bouchard C, Mantelet F, Aoussat A, Solves C, Gonzalez JC, Pearce K, Coleman S, (2009) A European Emotional Investigation In The Field Of Shoes Design. *International Journal Of Product Development, Special Issue On Kansei Engineering And Emotional Design* 7(1-2):3–27
- Bianchi-Berthouze N, Kleinsmith A, (2003) A categorical approach to affective gesture recognition. *Connection Science* 15:259–269
- Coulson M, (2004) Attributing emotion to static body postures: Recognition accuracy, confusions, and viewpoint dependence. *Journal of Nonverbal Behavior* 28:117–139
- Djajadiningrat T, Matthews B, Stienstra M, (2007) Easy doesn't do it: skill and expression in tangible aesthetics. *Personal and Ubiquitous Computing* 11:657–676
- Eckert C, Stacey M, (2000) Sources of inspiration: a language of design. *Design studies* 21(5):523–538
- Ekman P, Friesen W, (1967) Head and body cues in the judgment of emotion: A reformulation. *Perceptual and Motor Skills* 24:711–724
- Field AP, Schorah H, (2007) The verbal information pathway to fear and hear rate changes in children. *Journal of Child Physiology and Psychiatry* 48(11):1088–1093
- Ganglbauer E, Schrammel J, Deutsch S, Tscheligi M, (2009) Applying Psychophysiological Methods for Measuring User Experience: Possibilities, Challenges and Feasibility. *UXEM'09*
- Geneva Emotion Research Group, (1998) Appendix F. Labels describing affective states in five major languages. <http://www.unige.ch/fapse/emotion/resmaterial/resmaterial.html>
- Globich J, Hamm AO, Esteves F, and Öhman A, (1999) Fear appears fast: Temporal course of startle reflex potentiation in animal fearful subjects. *Psychophysiology* 36:66–75
- Helms ME, Vattam SS, Goel AK, (2008) Problem-Driven and Solution-Based Design: Twin Processes of Biologically Inspired Design. In *ACADIA08 Conference*
- Jenkins S, Brown R, Rutterford N, (2009) Comparing thermographic, EEG, and subjective measures of affective experience during simulated product interactions. *International Journal of Design* 3(2):53–65
- Laban R, (1988) *The mastery of movement*. Princeton
- Lang PJ, Bradley MM, Cuthberth BN, (1997) International affective picture system(IAPS):Technical Manual and Affective ratings. In *NIMH Center for the Study of Emotion and Attention*
- Mantelet F, (2006) *Prise en compte de la perception émotionnelle du consommateur dans le processus de conception de produits*. Ph.D Thesis, Arts et Metiers ParisTech, France
- Mehrabian A, Friar J, (1969) Encoding of attitude by a seated communicator via posture and position cues. *Journal of Consulting and Clinical Psychology* 33:330–336
- Mougenot C, Bouchard C, Aoussat A, (2008) Inspiration, Images And Design: A Field Investigation Of Information Retrieval Strategies By Designers. *Journal of Design Research* 7(4):331–351
- Nagamachi M, Tachikawa M, Imanishi N, Ishizawa T, Yano S, (2008) A successful statistical procedure on kansei engineering products. *Electronic Conference Proceedings*
- Picard RW, Vyzas E, Healey J, (2001) Toward machine emotional intelligence: Analysis of affective physiological state. *IEEE Transactions Pattern Analysis and Machine Intelligence* 23:1175–1191
- Poels K, Dewitte S, (2006) How to capture the heart? Reviewing 20 years of emotion measurement in advertising. In *Journal of Advertising Research*
- Tipples J, Young AW, Quinlan P, Broks P, Ellis AW, (2002) Searching for threat. *The quarterly journal of experimental psychology section A* 55(3):1007–1026
- Tran TQ, Boring, RL, Dudenhoefter DD, Hallbert BP, Keller MD, Anderson TM, (2007) Advantages and Disadvantages of Physiological Assessment For Next Generation Control Room Design. *Human Factors and Power Plants and HPRCT 13th Annual Meeting, IEEE 8th*, 259–263

Van den Broek EL, Westerink JHDM, (2009) Consideration for emotion aware consumer products. *Applied Ergonomics* 40:1055–1064

Wallbott HG, (1998) Bodily expression of emotion. *European Journal of Social Psychology* 28:879–896

Wang H, (1995) An approach to computer-aided styling. *Design Studies* 16(1):50–61

Wilson JO, Rosen D, (2010) The effects of biological examples in idea generation. *Design Studies* 31(2):169–186

Design of Emotional and Creative Motion by Focusing on Rhythmic Features

Kaori Yamada¹, Toshiharu Taura¹ and Yukari Nagai²

¹ Kobe University, Japan

² Japan Advanced Institute of Science and Technology, Japan

Abstract. In this study, we develop a method for designing an emotional and creative motion that resonates with deep feelings. This study is based on the hypothesis that motion that is beyond ordinary human imagination can produce emotional impressions that resonate with deep feelings. The proposed method involves an analogy with natural objects, the blending of motions, and an emphasis on rhythmic features. In order to design an emotional and creative motion, we attempt to construct a computer system that implements the proposed method. An experiment to verify the effectiveness of the proposed method and the validity of our hypothesis is performed. We compare the impressions produced by the motions that are created in three ways, with an emphasis on their rhythmic features.

Keywords: Motion Design, Rhythmic Features, Creativity

1 Introduction

The most significant ambition in design is to create objects that resonate with the deep feelings felt by humans (Norman, 2003). In this study, we attempt to design an emotional and creative motion that resonates with such deep feelings.

In recent years, design has mainly been directed toward forms and shapes; therefore, most designs have provided only the shapes and forms of objects. In today's information society, as many mediums of expression have become available, the fields of design have begun to address dynamic objects as well. In this study, we attempt to enhance the design of objects from the perspective of motion. Humans have generated a great variety of motion, such as the motion behaviors of vehicles or robots, animation, and dance. However, the conventional methods of generating these motions are based on visual images created by the designer. Indeed, the motions that a dancer executes while dancing constitute the dancer's movement of his/her body. However, this method

limits the imagination that imparts motion to an individual's body.

In another field, the playing of musical instruments facilitates the capacity of musicians in their creation of novel and innovative tunes. Perhaps, the musical instruments themselves effectively trigger the human feelings that people express via their music. We must note here that music is different from natural sound in that it is an artificial creation of humans, and we are at times deeply impressed by music that extends beyond ordinary human imagination. Indeed, it can be said that the deep impressions we receive are evoked by such artificial sounds.

Humans receive "emotional impressions" not only from natural objects but also from artifacts. We are deeply impressed by artifacts such as pictures or music in the same way as we are impressed by nature. Here, the term "emotional impressions" denotes more active notion feeling that moves human's deep feelings, whereas the term "impression" denotes the passive or static image.

In this study, we assume that creative motion beyond ordinary human imagination can produce such emotional impressions in us. In this study, we attempt to design such emotional and creative motion using a computer. By using a computer, it is expected that we can generate the creative motion that is beyond ordinary human imagination.

2 Purpose

In this study, we propose a method of designing an emotional and creative motion on the basis of the hypothesis that motion beyond ordinary human imagination can produce emotional impressions that resonate with deep feelings.

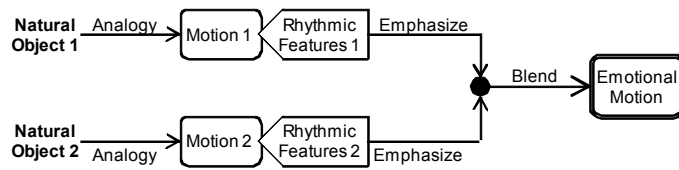

Fig. 1. Outline of proposed method

3 Method of Designing Emotional and Creative Motion

We have discussed a method of designing an emotional and creative motion (Tsujiimoto et al., 2008; Taura et al., in press). In this paper, according to these discussions, we develop a design method based on the following strategies.

3.1 Analogy with Natural Objects

Humans have evolved in the natural environment and are thought to have images of nature imprinted in their mind. Humans have created many artifacts that are based on or suggested by natural objects. Furthermore, the motions of natural objects are unique and charming (Chakrabarti et al., 2005). For example, the research on biologically inspired design involves some motions that were developed by using analogous biological phenomena (Swaroop et al., 2007). Therefore, we can use natural objects as a source for the design of an emotional and creative motion. This method of deriving an emotional and creative motion from natural objects can be viewed as a process of analogy.

3.2 Blending of Motions

A motion generated only by applying such an analogy to natural objects cannot extend beyond the human imagination. On the other hand, according to the studies of design creativity, concept blending is crucial to the creative generation of concepts (Nagai et al., 2009). Concept blending is based on the combination of two input concepts to yield a third concept. While a blended concept inherits part of its structures from the input concepts, it also includes emergent structures of its own. In this study, we apply the notion of concept blending to the design of an emotional and creative motion, and we develop a method of blending the motions generated by analogy with natural objects in order to generate a more creative motion.

3.3 Emphasis on Rhythmic Features

In this research, we focus on the rhythmic features of motion, that is, on changes in the quantity of the angles of joints and in the angular velocities. Rhythm in music involves the interrelationship between the accented (strong) beat and the unaccented (weak) beat (Cooper and Meyer, 1960). Incidentally, accents that are produced by stress (dynamics) imply the dynamic intensification of a beat, that is, an emphasis through use of a louder sound. For example, *p* (*piano*) means “soft,” while *f* (*forte*) means “loud.” Based on these considerations in the field of music, we attempt to emphasize the rhythmic features of the motion by increasing or reducing the frequency of motion. By using this method, it is expected that motions that extend beyond human imagination can be designed.

Based on the considerations stated above, we propose a method of designing emotional and creative motion. In this method, we basically follow the traditional design process—the design solution is determined from the abstract function (Pahl and Beitz, 1988); the design process in this study uniquely deals with some specific features (rhythmic features). An outline of the proposed method is shown in Fig. 1. First, by using the method of analogy with natural objects, we obtain motions of natural objects as a source for emotional and creative motion (base motion). The rhythmic features are extracted by conducting a frequency analysis of each obtained motion. Regarding the frequency analysis, we decided to use wavelet analysis because it can process both the phasing and frequential characteristics in the same operation (Daubechies, 1992). The wavelet coefficients obtained from wavelet analysis are used as the rhythmic features of motion. Let R_1 be the rhythmic features of the motion of natural object1, and let $\omega_{1,t}$ be the T th rhythmic feature (wavelet coefficient) of natural object1. Then, the emphasized rhythmic feature is defined by the following equation (1):

$$\omega_{1,t} = \begin{cases} m_1 \omega_{1,t} & (p_1 \leq \omega_{1,t}) \\ \omega_{1,t} & (q_1 < \omega_{1,t} < p_1) \\ n_1 \omega_{1,t} & (|\omega_{1,t}| \leq q_1) \end{cases} \quad (1)$$

Here, p_1 and q_1 are the threshold for the emphasis of a rhythmic feature, and $m_1 \geq 1$, $n_1 \leq 1$. This emphasis makes a large motion larger and a small motion smaller. The rhythmic feature of the motion of another natural object is emphasized in the same way. Both the rhythmic features are then blended together. The operation of blending rhythmic features is defined by equation (2). Here, C_1 and C_2 are the weights for each rhythmic feature of natural objects 1 and 2.

$$R_{blending}(\omega_t) = C_1 R_1(\omega_{1,t}) + C_2 R_2(\omega_{2,t}) \quad (2)$$

Inverse wavelet transform is performed on the blended rhythmic features so that a new motion is created.

4 Procedure to Design an Emotional and Creative Motion Purpose

Based on the method described above, a computer system for creating an emotional and creative motion is developed. This system comprises the following steps:

- Step1)** Obtain the angle $\theta(t)$ in the sequential order by recognizing each of the 4 joints of a natural object as a characteristic point
- Step2)** Calculate the angular velocity $\dot{\theta}(t)$ of each joint from the change in angles
- Step3)** Perform wavelet analysis for the angular velocity calculated in Step2. In this study, we use Daubechies8 wavelets as wavelet prototype functions, since these wavelets are widely used. The wavelet coefficients obtained in Step3 are used as rhythmic features

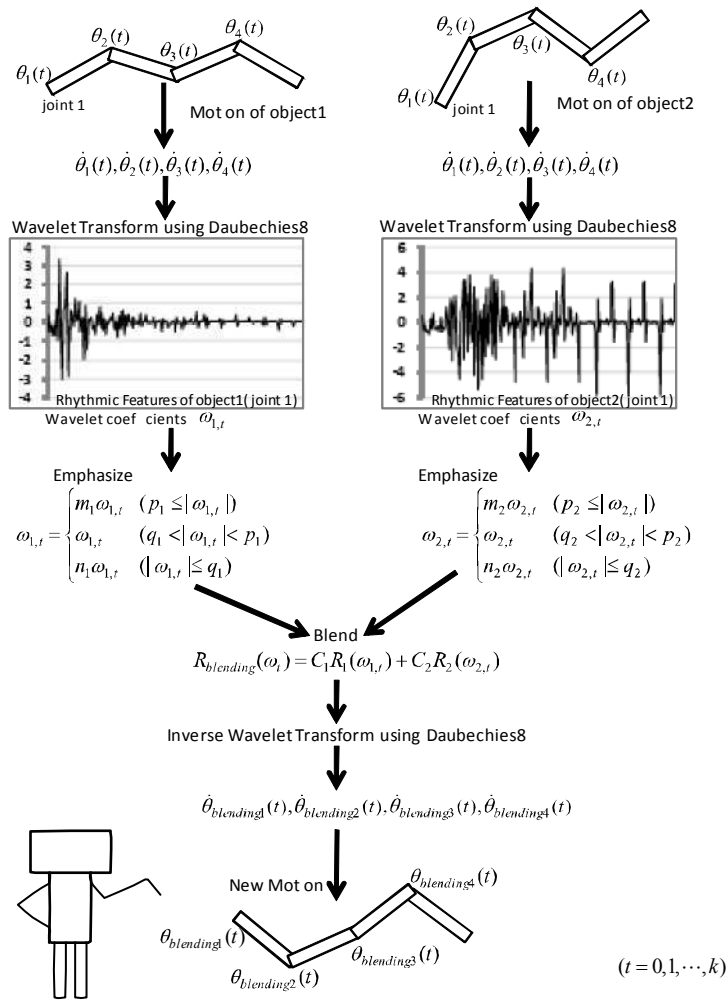

Fig. 2. Procedure for generating motion

Step4) The rhythmic features are emphasized by using equation (1) in 3.3. In the process of emphasis, designers can decide p , q , m , and n according to their individual criteria

Steps 1 to 4 are performed on each joint of a natural object.

Step5) The rhythmic features of two natural objects that were emphasized in Step4 are blended using equation (2). Here too, motion designers can decide the weights for each rhythmic feature according to their individual criteria

Step6) Inverse wavelet transform is performed on the blended rhythmic features of each joint $R_{blending}(\omega_t)$, and angular velocities $\dot{\theta}_{blending}(t)$ are obtained. The angle $\theta_{blending}(t)$ of each joint is calculated from the angular velocities

Step7) The motion is created by transforming the angle of each joint to that of the design target.

We have developed a computer system that can perform the steps described above. The procedure for creating motion is shown in Fig. 2.

5 Experiment

An experiment to confirm the feasibility of the proposed method and the validity of the hypothesis was performed. In this experiment, three types of motion that differed in the way they emphasized rhythmic features were created.

5.1 Designing an Emotional and Creative Motion Using the Proposed Method

Selected characteristic motions of frogs and snakes were used as the base objects for analogy, since they both have unique ways of moving that are well known. We chose a virtual robot's arms on CG as a design target. In order to design a motion that is beyond human imagination, we did not set any limitations on

Table 1. Types of motions

	Motion I	Motion II	Motion III
p	top25%	—	
m	4.0		
q	—	bottom25%	
n		0.25	



Fig. 3. Example of designed motion (Although Motion II and Motion III appear very similar in this picture, they look different in an actual animation.)

the condition of the robot’s arms, for example, to limit the joint angle or prevent a collision. The types of rhythmic features that were emphasized are listed in Table 1. Here, the determinations of p and q were calculated from the average of each rhythmic feature of each joint in Step3 beforehand. The weights for each rhythmic feature C1:C2 were decided as 1:1. Motion I was expected to enhance large motion by making it larger, while Motion II was expected to diminish small motion by making it smaller. Motion III emphasized no rhythmic features.

The computer system was implemented on Windows XP/Vista and it was developed in Microsoft Visual C++ using a numerical library GSL (the GNU Scientific Library) and GLUT (the OpenGL Utility Toolkit) to represent the motion in 3D graphics. The examples of designed motion that were obtained using the system are shown in Fig.3 (a) to (c). Fig.3 shows these motions in a sequential time order at 2-second intervals. The arms of both the bodies were targets of design.

5.2 Evaluation of the created Motions

The motions that were created were evaluated in order to verify the effectiveness of the proposed method and the validity of the hypothesis. Twelve subjects participated in the evaluation. After three motions were shown to the subjects, they were asked to evaluate them according to 10 terms on a seven-point scale. All the evaluation terms are presented in Fig. 4. Furthermore, the subjects were asked to offer words to describe what they imagined or associated with each motion. The subjects were college students and graduate students (aged 21–24). In order to eliminate order effects, six of the subjects evaluated Motion I first, Motion III second, and Motion II last. The others evaluated Motion II first, Motion III second, and Motion I last.

An SD profile obtained from the experiment is shown in Fig. 4. The points in the figure show the average of all subjects for each term for each motion. In the figure, we can see that the following five terms elicited a significant difference between Motion I (a large motion that is enhanced to become larger) and Motion III (no feature is emphasized): term 5, “Easy to mimic with the body – Difficult to mimic”; term 6, “Exciting – Unexciting”; term 7, “Vivid – Vapid”; term 8, “Complicated – Simple”; and term 9, “Dynamic – Static.” Furthermore, the following three terms elicited a significant difference between Motion I and Motion II (a small motion is diminished to become smaller): term 6, “Exciting – Unexciting”; term 7 “Vivid – Vapid”; and term 8, “Complicated – Simple.” On the other hand, the values of Motion I and

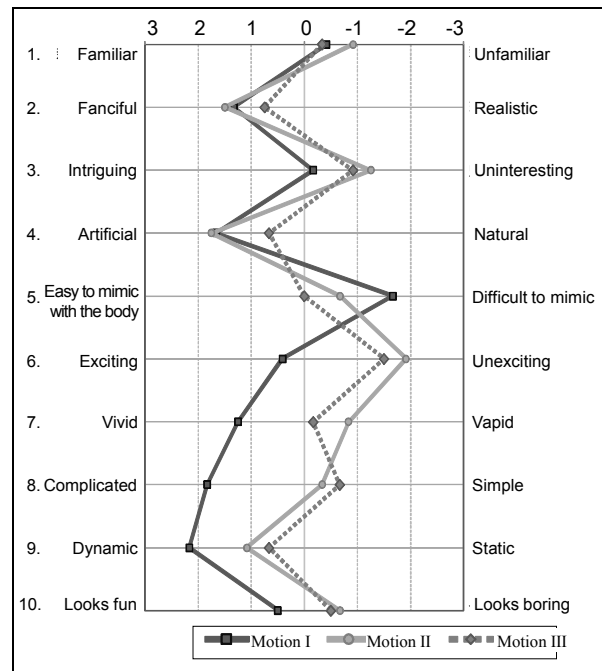

Fig. 4. SD profile

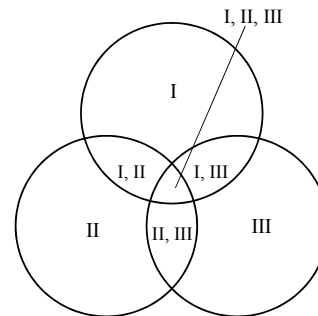

Fig. 5. Classification of words

Motion II were close to one another for the following two terms: term 2, “Fanciful – Realistic” and term 4, “Artificial – Natural,” while both these values were different from the value for Motion III.

The described words were classified as shown in Fig. 5. Group “I, II, III” includes the words that were described in Motion I, Motion II, and Motion III. Group “I, II” includes those that were described in Motion I and Motion II. Group “I” includes the words that were described only in Motion I. The number of words classified according to the group categories mentioned above are summarized in Fig. 6. All the descriptive words were pre-processed according to the following rules before they were classified:

- Exclude the words that were displayed on the screen while the motion was shown or in the instructions for the experiment;

- when the same word was used by the same subject to describe the same motion, count that word as a single word;
- consider words of similar meaning to be the same word; e.g., “woman – female,” “body building – body builder”;
- consider a compound word to be one word, even if it could be expressed as separate words; “vacant eye,” “a lot of joints.”

Fig.6 shows that there is no notable difference among the ratios of Group “I, II, III” to the sum of the number of words that were used to describe each motion: Motion I, Motion II, and Motion III. On the other hand, a difference is found among the ratios of words that were used only to describe each motion (Group “I” in Motion I, Group “II” in Motion II, and Group “III” in Motion III). As a result of a chi-square test, there was a significant difference between Motion I and Motion III ($\chi^2(3) = 15.465$ ($p < 0.01$)).

6 Discussion

First, let us discuss the effectiveness of emphasizing the rhythmic features. The significant difference between Motion I (a large motion was enhanced to become larger) and Motion III (no feature was emphasized) for term5, term6, term7, term8, and term9 indicates that the emphasis of rhythmic features (Motion I) is effective at creating a motion that extends beyond ordinary human imagination and is also attractive to the human mind. Furthermore, the significant difference between Motion I (a large motion was enhanced to become larger) and Motion II (a small motion was diminished to become smaller) for term6, term7, and term8 indicates that emphasizing

rhythmic features by enhancing a large motion is more effective at creating a dynamical motion than diminishing a small motion. On the other hand, no difference between Motion I and Motion II for term2 and term4 indicates that any emphasis of rhythmic features is effective at enhancing a number of characteristics of creativity and emotion. From the results and discussion presented above, we see that the emphasis of rhythmic features in the process of blending motions, especially when enhancing a large motion by making it larger, effectively creates a motion that extends beyond human imagination and produces an emotional and creative feeling.

Next, we discuss the results obtained from the number of words classified in Fig.6. The differences among the ratios of the number of words that were descriptively used only in each group category (Group “I” in Motion I shows a higher value than Group “II” in Motion II and Group “III” in Motion III) indicates that Motion I created impressions that were different from those created by the other two Motions. Furthermore, the differences among the ratios of the numbers of words that were used to describe the two group categories (Group “II, III” shows a higher value than Group “I, II” and Group “I, III”) indicates that Motion II and Motion III created similar impressions.

Next, we discuss the content of the descriptive words that were used, all of which are listed in Table 2. A group category refers to the classification of words that is shown above in Fig. 5. Words that cannot be translated into English are written in the English phonetics of Japanese pronunciation, e.g., “*KIMONO. Group “I, II, III” includes words that regard the appearance of the design targets, such as “couple,” “blue,” and “orange” (the design target was composed of two characters colored blue and orange). Group “I, II, III” also includes “dance” and “wriggle,” etc. Thus,

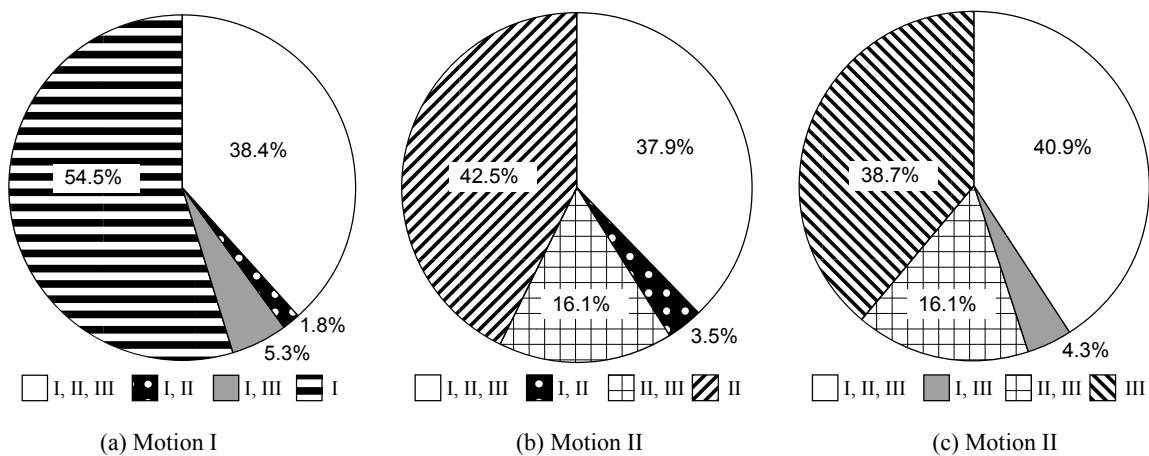

Fig. 6. Number of classified words

Table 2. List of all described words

	Group	word	number of descriptions		
			MotionI	MotionII	MotionIII
1	III,III	dance	5	2	4
2	III,III	wriggle	4	3	3
3	III,III	joint	4	2	3
4	III,III	couple	3	3	2
5	III,III	woman	2	1	5
6	III,III	robot	5	1	1
7	III,III	toilet	3	2	2
8	III,III	blue	2	2	2
9	III,III	man	2	1	3
10	III,III	symmetry	3	1	1
11	III,III	snake	2	2	1
12	III,III	physical exercise	1	3	1
13	III,III	orange	1	2	2
14	III,III	monotony	1	2	2
15	III,III	circle	1	2	1
16	III,III	hula	1	1	2
17	III,III	shoulder	1	1	1
18	III,III	yoga	1	1	1
19	III,III	*KAKU-KAKU	1	1	1
20	I,II	hand	1	2	
21	I,II	disgusting	1	1	
22	I,III	arm	3		1
23	I,III	wondering	1		1
24	I,III	synchro	1		1
25	I,III	elastic	1		1
26	II,III	smoothness		2	2
27	II,III	triangle		2	1
28	II,III	wave		1	2
29	II,III	balance		1	2
30	II,III	mesh		1	1
31	II,III	needle		1	1
32	II,III	winding		1	1
33	II,III	slowly		1	1
34	II,III	standing bolt upright		1	1
35	II,III	rink		1	1
36	II,III	languid		1	1
37	II,III	stickman		1	1
38	I	human	3		
39	I	chaos	2		
40	I	complicate	2		
41	I	rotation	2		
42	I	muscle	2		
43	I	body-building	2		
44	I	caterpillar	1		
45	I	difficult	1		
46	I	back	1		
47	I	wrist	1		
48	I	elbow	1		
49	I	red	1		
50	I	resort	1		
51	I	monkey	1		
52	I	eye gaze	1		
53	I	flag signaling	1		
54	I	motion	1		
55	I	S	1		
56	I	at-random	1		
57	I	stable	1		
58	I	heterogeneous	1		
59	I	active	1		
60	I	regularly	1		
61	I	strange	1		
62	I	health	1		
63	I	compact	1		
64	I	square	1		
65	I	traditional	1		
66	I	sameness	1		
67	I	non-human	1		
68	I	diagonally	1		
69	I	smiley	1		
70	I	instability	1		
71	I	unnatural	1		
72	I	limp	1		
73	I	peculiar	1		
74	I	straight	1		
75	I	rich	1		
76	I	refresh	1		
77	I	movement	1		
78	I	bias	1		
79	I	welcome	1		
80	I	*KANPU-MASATSU	1		
81	I	stretch	1		
82	I	satisfaction	1		
83	I	insistence		1	
84	I	type		1	
85	I	Hawaiian		1	
86	I	coquettish		1	
87	I	gallant		1	
88	I	head		1	
89	I	dancing		1	
90	I	grid		1	
91	I	ground		1	
92	II	doll			1
93	II	dead-man			1
94	II	plant			1
95	II	tired			1
96	II	symmetry			1
97	II	centipede			1
98	II	manipulate			1
99	II	artificial			1
100	II	ruggedness			1
101	II	non-productive			1
102	II	algorithm			1
103	II	curve			1
104	II	repetition			1
105	II	response and motion			1
106	II	sympathize			1
107	II	change			1
108	II	lambency			1
109	II	awkward			1
110	II	toy			1
111	II	zombie			1
112	II	isosceles triangle			1
113	II	seaweed			1
114	II	boring			1
115	II	ghost			1
116	II	same			1
117	II	different space			1
118	II	nonsensical			1
119	II	vacant eye			1
120	II	arthralgia			1
121	II	a lot of joints			1
122	II	front and side			1
123	II	vapid			1
124	II	hand exercise			1
125	II	*PACHIN-PACHIN			1
126	II	asymmetry			1
127	II	*BYO-N			1
128	II	dancing artificial flower			1
129	III	tasteful			1
130	III	gentle			1
131	III	slope			1
132	III	sleepy			1
133	III	octopus			1
134	III	CG			1
135	III	Japanese garden			1
136	III	accent			1
137	III	line			1
138	III	stream lined			1
139	III	prawn			1
140	III	few			1
141	III	solid			1
142	III	white			1
143	III	peace			1
144	III	common			1
145	III	squishy			1
146	III	quiet			1
147	III	natural			1
148	III	flat			1
149	III	overbearing			1
150	III	rhythmical			1
151	III	communication			1
152	III	transmission			1
153	III	distrust			1
154	III	diagonally upright			1
155	III	playful spirit			1
156	III	air			1
157	III	itchy			1
158	III	inverse proportion			1
159	III	slow			1
160	III	*KIMONO			1
161	III	back-and-forth movement			1
162	III	horizontal movement			1
163	III	bilateral symmetry			1
164	III	red and blue			1

it is assumed that all of these motions gave the impression of an image in which a couple is dancing. This Group includes “hula,” “yoga,” and “physical exercise” as well. On the other hand, the word “woman” is found twice in Motion I, once in Motion II, and five times in Motion III. The word “robot” was used descriptively once in Motion II and Motion III, while it was used five times in Motion I. Thus, it is

assumed that Motion I gave a machine-like impression. Furthermore, the word “human” was used three times only in Motion I. Therefore, it is assumed that Motion I gave a contradictory impression of both human and artificial qualities at the same time. The need to use multiple contradictory words suggests that Motion I was difficult for the subjects to imagine. Group “II, III” includes the words “smoothness,” “wave,”

“slowly,” etc. Thus, it is assumed that both Motion II and Motion III looked like a dance with slow wave-like motions. The words specified in Motion II were “artificial,” “doll,” “ghost,” etc. Thus, it is assumed that the motion in Motion II gave an impression of artificiality, resembling a machine that mimics human movement. The representative words used to describe Motion III were “gentle,” “quiet,” “natural,” etc. Considering that “woman” was described more often here than for the other Motions, it is assumed that the motion of Motion III appeared feminine and dainty.

As a result, it is assumed that Motion I gave an impression that was both machine-like and human, while its motion suggested a dance that was difficult for a human to imagine. Thus, this motion is thought to be active and vivid. Regarding Motion II, the motion is assumed to give the impression of a dance that mimics human dance in an artificial and fanciful manner. This impression, however, is not considered to be able to extend beyond ordinary human imagination. The reason for this is that its motion was slow and wave-like but also expressed awkwardness. Regarding Motion III, it is assumed that the subjects felt most friendly toward and familiar with this motion, and its motion was considered imaginable for a human. The motion of Motion III was gentle and smooth and it gave an impression of femininity.

7 Conclusion

This study is based on the hypothesis that motion beyond ordinary human imagination can produce emotional impressions that resonate with deep feelings. We have developed a method of designing such an emotional and creative motion. The method involves the following three strategies: an analogy with natural objects, the blending of motions, and an emphasis on rhythmic features. We have also developed a computer system that can implement the proposed method. In addition, we conducted an experiment to verify the effectiveness of our proposed method and hypothesis. The results show that the emphasis of rhythmic features in the process of blending base motions was effective at creating a motion that extends beyond ordinary human imagination and is also attractive to the human mind. From the discussion presented above, we confirmed the validity of our hypothesis and the effectiveness of the proposed method.

Not just any motion that extends beyond ordinary human imagination, however, is able to create emotional impressions that resonate in deep feelings. We need to find and select appropriate natural objects

as the source of our design of emotional and creative motions. In this study, we chose a virtual robot’s arms as the design target for a new motion, which was created by blending the characteristic motions of frogs and snakes. In the future, we will design a motion by blending the motions of other animals to be applied to other design targets. In this experiment, though our intention was to design a motion that is difficult for the human mind to imagine, we cannot claim that the resulting motion is truly unimaginable by the human mind. Future works, therefore, would be directed toward the design of a motion that extends further beyond the scope of human imagination.

In this experiment, the subjects received impressions suggesting that the newly produced motion resembled a dance. Dance, of course, is generally accompanied by music or the playing of musical instruments. Therefore we intend to add emotional elements such as music or other effects to future motions in our quest to design a more emotional and creative motion.

References

- Chakrabarti A, Sarkar P, Leelavathamma B, Nataraju BS, (2005) A functional representation for aiding biomimetic and artificial inspiration of new ideas. *Artificial Intelligence for Engineering Design, Analysis and Manufacturing* 19(2):113–132
- Cooper GW, Meyer LB, (1960) *The Rhythmic Structure of Music*. The University of Chicago Press
- Daubechies I (1992) *Ten Lectures on Wavelets*. Society for Industrial Mathematics
- Nagai Y, Taura T, Mukai F, (2009) Concept blending and dissimilarity; factors for creative concept generation process. *Design Studies* 30(6):648–675
- Norman DA (2003) *Emotional Design; Why We Love (or Hate) Everyday Things*. Basic Books
- Pahl G, Beitz W, (1988) *Engineering Design: A Systematic Approach*. The Design Council
- Swaroop V, Michael H, Ashok G, (2007) *Biologically-Inspired Innovation in Engineering Design; A Cognitive Study*. Technical Report. Graphics, Visualization and Usability Center, Georgia Institute of Technology, GIT-GVU-07-07
- Taura T, Nagai Y, (in press) *Designing of Emotional and Creative Motion*. in *Emotional Engineering; Service Development*, edited by Fukuda S, Springer-Verlag
- Tsujimoto K, Miura S, Tsumaya A, Nagai Y, Chakrabarti A, Taura T, (2008) *A Method for Creative Behavioral Design Based on Analogy and Blending from Natural Things*. Proceedings of ASME 2008 International Design Engineering Technical Conference and Computers and Information in Engineering Conference (on CD-ROM)

Design Synthesis

Create Adaptive Systems through “DNA” Guided Cellular Formation

George Zouein, Chang Chen and Yan Jin

Developing a Coding Scheme to Analyse Creativity in Highly-constrained Design Activities

Elies A. Dekoninck, Huang Yue, Thomas J. Howard and Christopher A. McMahon

Effectiveness of Brainwriting Techniques: Comparing Nominal Groups to Real Teams

Julie S. Linsey and Blake Becker

Create Adaptive Systems through “DNA” Guided Cellular Formation

George Zouein¹, Chang Chen² and Yan Jin²

¹ Honda R&D Americas, Inc., USA

² University of Southern California, USA

Abstract. How to design functional systems that can adapt itself to the changing operation environment is a challenge for the design community. We take a “naturalistic design” approach by exploiting the natural “design” process and mimicking its DNA based way of capturing, representing and applying “design” information pertaining to needed functions and changing operational situations. Utilizing “*design DNA*” and a “*priority distribution mapping*” technique, mechanical cells form a functional system through self-organizing.

Keywords: Design synthesis, bio-inspired design, self-organizing, cellular formation

1 Introduction

Research on design creativity has mostly been concerned with understanding how human designers create their design ideas and with developing better ways to help designers be more creative. Another drastically different way to pursue the same research is to investigate how Mother Nature created and keeps creating new creatures and novel phenomena. Bio-mimetic design is an evolving area where researchers attempt to find ways to take advantage of the “design ideas” that the nature has already created (Sarikaya, 1994, Vincent and Mann, 2002, Chu and Shu, 2004). Furthermore, using genetic algorithms and genetic programming techniques, which somehow mimic the “idea generation” process of the nature; researchers were able to use computers to help generate novel solutions to some engineering problems.

Putting aside the philosophical discussion, we may observe that human design and natural design are very much distinct from each other: human design is more purpose or function driven and takes a top-down approach, while natural design is arguably much less purposeful and follows a bottom-up approach. These two forms of design are dictated by the difference in the ways the designs are realized. Humans can make things the way they want so that the realization can be actively pursued. The nature, however, does not

“make” things happen. It “lets” things happen: the things “self-organize” themselves under given situations by following natural laws. It can be argued that the creativity in the nature exists among the “self-organizing” based option generation and “survival driven” choice making.

Our research on self-organizing based design creativity was motivated by an investigation of developing complex adaptive systems such as environment-adaptable robots. We are interested in combining the advantages of human and natural design methods and design systems that can design and build themselves by following a self-organizing strategy that on the one hand recognize the functional needs and on the other hand explore creative opportunities through self-organizing. In the following sections, we first briefly review the related work (Section 2) and then introduce the representation framework of our “design DNA”, or dDNA for short, based cellular formation approach (Section 3). Case examples are discussed in Section 4 and concluding remarks drawn in Section 5.

2 Related Work

The idea of developing a naturally inspired cellular system capable of reconfiguration is not new as many research groups have been actively investigating this topic over the past 20 years. This area of research has come about because of the need for autonomous artificial systems to be capable of dynamically adapting and reacting to a changing environment while still performing their predefined tasks. The basic idea behind such systems is that given a set of simple homogenous cells that are incapable of accomplishing complex tasks alone become capable of doing so when joined together in various configurations or *gaits*. Two such examples are PolyBot (Yim et al., 2000) and SuperBot (Shen et al., 2006). The authors of SuperBot take the biological idea a step further through a hormone-inspired control algorithm (Shen et al., 2002). In (Zykov et al., 2005), Hod Lipson’s group investigated and demonstrated autonomous self-

replication in the context of homogeneously composed systems comprised of cube modules. With regards to increasing a system’s adaptability, the idea is that such systems have the capability if damaged to construct a detached functional copy of its non-functioning self.

In (Unsal et al., 2001) the authors of *I-Cubes* investigate a simple heterogeneous system’s adaptive capability through reconfiguration. The authors developed a simplistic system composed of elements made up of passive cubes and active links capable of attaching and detaching around them. Similar to this idea the authors of (Yu et al., 2008) developed a modular heterogeneous system composed of active and passive links, surface membrane components, and interfacing cubes to achieve a Tensegrity model of cellular structure. Utilizing such a model the system is capable of contracting and expanding allowing itself to configure to various shapes capable of performing various functions. In (Rus and Vona, 2001) the authors discuss their *Crystalline Robots* by approaching reconfiguration through a different means where rather than moving individual units across the surface of a structure, transformations take place internally through contractions and expansions of the entire body similar to an amoeba. In (Bongard et al., 2006), Lipson’s group further investigated adaptability through means other than reconfiguration through a technique called continuous self-modeling. The group demonstrated a system with damaged extremities capability of self-discovering alternative gaits with its remaining working appendages allowing itself to continue to function. Amongst this work and the previously discussed, Lipson’s group has produced many other notable innovations in this field and as such much of our work and the work of others have been significantly inspired by their visionary efforts.

3 cFORE: Cellular System Formation and Representation

Answering the questions posed in section 1 requires a comprehensive representation framework that maps biological system concepts into mechanical systems. Figure 1 illustrates our cellular system formation & representation (cFORE) scheme that is being developed to facilitate synthetic DNA-based adaptive system development.

As shown in Figure 1, cFORE is developed through synthesizing system formation concepts from both the fields of biology and mechanical engineering. After an extensive review of biological literature, we have identified 16 key biological concepts and processes that are integrated into the cFORE framework together with key design concepts found in

mechanical engineering. In the following, we first present the definitions of a selected set of concepts and then discuss more about them in the Simulation Study and Discussion section. Corresponding biology concepts are sometimes associated in parentheses when appropriate.

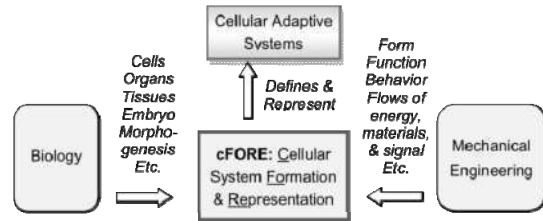

Fig 1. cFORE model and its relations with biology and mechanical engineering

Definition1-Mechanical Cell: A mechanical cell, mCell, see Figure 2, is defined as: $mCell = \{Cu, (f), (\Phi), dDNA, Es, Ec, Mc\}$, where;

Cu: control unit (nucleus), *dDNA*: design information, (Φ) : centroidal location, (f): 6 sides, Es& Ec: energy storage & converter (mitochondria), Mc: material converter (lysosomes).

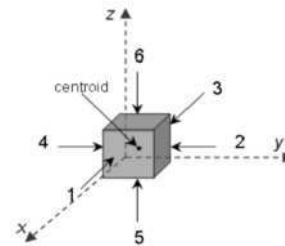

Fig 2. A simple mechanical cell model. Each cell has a centroid location and 6 sides which may perform certain functions

Definition2-dDNA: *dDNA* is a matrix representation containing a system’s genome:

$$dDNA = \begin{bmatrix} (\phi, f_c, F_p)_{1,1} & L & (\phi, f_c, F_p)_{1,n-1} & (\phi, f_c, F_p)_{1,n} \\ (\phi, f_c, F_p)_{2,1} & L & (\phi, f_c, F_p)_{2,n-1} & (\phi, f_c, F_p)_{2,n} \\ M & L & M & M \\ (\phi, f_c, F_p)_{m,1} & L & (\phi, f_c, F_p)_{m,n-1} & (\phi, f_c, F_p)_{m,n} \end{bmatrix}, <MIS>$$

Each item in the above matrix is a mCell Gene with a Priority ID m. A realized *dDNA* matrix is a complete description of a specific system or product, which we call system genome or sGenome. Note that the mCell Genes with the same m ID’s have different locations, i.e., (x, y, z)’s. Therefore, the number of rows of each column in a *dDNA* may not be the same and depends on a product’s genotype-phenotype mappings. An sGenome contains information regarding, from global to local: functional priority layers, cellular locations

(Φ), cellular functions (f), and self-growth mCell instruction set (MIS) (transcribed protein sets).

Definition3-mCell Gene: mCell Gene, G_c , is defined as:

$$G_c = \langle \phi \quad F_c \quad F_p \rangle$$

The information inscribed per Gene is Φ cellular location, F_c cellular level functions, and F_p system level priority functions. More precisely, an mCell Gene is defined as,

$$G_c = \langle x, y, z, (f_1 \dots f_{n1})_1, (f_1 \dots f_{n2})_2, (f_1 \dots f_{n3})_3, (f_1 \dots f_{n4})_4, (f_1 \dots f_{n5})_5, (f_1 \dots f_{n6})_6, P \rangle$$

where (x, y, z) is the geometric location of the cell with respect to a reference *central point*; (f1..., fn) are the cellular functions per face of the cell (we assume to have 6 faces as we are dealing with a cubic mCELL as defined in figure 2), and P is the priority of that particular cell to the overall system’s form and subsequent system level function. The concept of system level priority functions or simply *priority* is necessary in the context of determining a system’s adaptive capability. During operation, when identifying a system’s gaits or reconfiguration states, system *priority* determines the location that reconfiguring cells desire to occupy. Namely, in a system’s *Priority Distribution Map*, which will be discussed in greater detail in the following section, a designer has the control to determine where certain cells may reconfigure to in order to either maintain current system level functions (such as walking, climbing etc.) or dynamically create new ones. In essence, the higher is a particular position’s priority with respect to the overall system, the more desirable it will be for the cells searching for a place to reconfigure to. For our current systems we define 4 possible levels of priority: Highest, High, Middle, and Low with values of 1, 0.7, 0.5, and 0.3, respectively. Depending on the method used to implement *dDNA* and sGenome and consequently the process of design evolution may take different forms. Figure 3 illustrates the Gene of an arbitrary mCell.

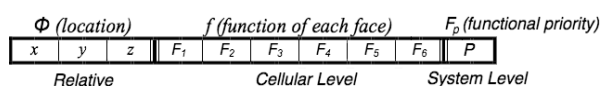

Fig 3. An example of mCELL gene that encodes location, cell level and system level functions

Definition4-mCell Instruction Set, MIS (transcribed protein set): MIS is defined as one of 2 types of instruction sets (proteins):

$$\langle \text{mCellInstructionSet} \rangle ::= \langle \text{enzymes} \rangle | \langle \text{structuralInstructions} \rangle | \langle \text{communicationInstructions} \rangle$$

$$\begin{aligned} \langle \text{enzymes} \rangle & ::= \\ & \langle \text{cellularFunctionExpressionInstructions} \rangle \langle \text{formationInstructions} \rangle \\ \langle \text{cellularFunctionExpressionInstructions} \rangle & ::= \\ & \langle \text{expressionActions} \rangle \langle \text{generalActions} \rangle \\ \langle \text{formationInstructions} \rangle & ::= \\ & \langle \text{formationActions} \rangle \langle \text{generalActions} \rangle \\ \langle \text{structuralInstructions} \rangle & ::= \\ & \langle \text{structuralActions} \rangle \langle \text{generalActions} \rangle \\ \langle \text{communicationInstructions} \rangle & ::= \\ & \langle \text{commActions} \rangle \langle \text{generalActions} \rangle. \end{aligned}$$

In biology, amino acids are the basic structural building units of proteins. Similarly we define a group of cellular actions and group them into 4 sets.

Definition5-Cellular Actions (amino acids): a set of cellular actions is defined as:

$$\begin{aligned} \langle \text{cellularActions} \rangle & ::= \langle \text{generalActions} \rangle | \\ & \langle \text{expressionActions} \rangle | \\ & \langle \text{formationActions} \rangle | \langle \text{structuralActions} \rangle | \langle \text{commActions} \rangle \\ \langle \text{generalActions} \rangle & ::= \langle (x,y,z), F1, F2, F3, F4, F5, F6, \&, P \rangle: \\ & \text{General actions that stores centroid location (x, y, z),} \\ & \text{mCell face information F1 through F6, the “\&”} \\ & \text{operation, and P priority.} \\ \langle \text{expressionActions} \rangle & ::= \langle f1 f2 \dots fn \rangle: \text{Expression amino} \\ & \text{acid that stores cellular functional expression} \\ & \text{instructions.} \\ \langle \text{formationActions} \rangle & ::= \langle u d l r f b A D \# \rangle \text{ formation} \\ & \text{actions that store the formation actions. u, d, l, r, f, b, A,} \\ & \text{D, \# stand for up, down, left, right, forward, backward,} \\ & \text{attach, detach and an integer value respectively.} \\ \langle \text{structuralActions} \rangle & ::= \langle cs1, cs2, \dots \rangle: \text{Structural actions} \\ & \text{that stores construction actions.} \\ \langle \text{commActions} \rangle & ::= \langle cm1, cm2, \dots \rangle \text{Communication actions.} \end{aligned}$$

An example of an instruction (protein) composition of cellular actions is:

$$\langle \text{formationInstructions} \rangle = (2,1,6)DF3d1AF3(1,1,5)AF1,$$

which states that the cell at centroid location (2,1,6) should detach face 3, move down 1 and attach at its face 3 the cell at centroid location (1,1,5) at its face 1.

Given an sGenome encoded in *dDNA* and its transcribing methods defined above, mCells will need mechanisms to apply this design information including instructions to grow into the desired system and reconfigure into new ones. One key process governing the self-growth from an embryo to a mature system in biology is morphogenesis, which determines the shapes, sizes, and layouts of organs, tissues and overall body anatomy (Audesirk et al., 2007). Essentially, morphogenesis is guided by a set of rules or principles followed by an embryo in its transformation into a complete system. Drawing insight from this concept we introduce a similar process for our CAS. A set of Self-formation Governing Principles, or SGP was developed to guide the self-organization of mCells in forming a bio-inspired system. It has been recognized that all biological systems follow a “minimization of energy principle” when they undergo growth,

development or preservation of life (Vincent et al., (2006)). In cFORE, the SGP is defined as follows.

Definition6- Self-formation Governing Principle, SGP (morphogenesis):

$\langle SGP \rangle ::= \langle layoutPrinciples \rangle | \langle developmentPrinciples \rangle$
 $\langle layoutPrinciples \rangle ::= [System\ layout\ is\ determined\ by\ dDNA\ genes\ and\ priority\ at\ mCell\ levels]$
 $\langle developmentPrinciples \rangle ::=$
 $\langle PriorityFormationOrder \rangle | \langle cellularActionPrinciple \rangle | \langle systemFormationPrinciple \rangle$
 $\langle PriorityFormationOrder \rangle ::= [Form\ highest\ priority\ first,\ if\ no\ priority\ exists\ then\ form\ middle\ priority,\ if\ no\ such\ priority\ exists\ then\ form\ lowest\ priority,\ if\ no\ such\ priority\ exists\ then\ begin\ bonding\ formed\ priority\ layers\ together]$
 $\langle cellularActionPrinciple \rangle ::= [Minimize\ energy\ needed\ to\ carry\ out\ cellular\ actions]$
 $\langle systemFormationPrinciple \rangle ::= [Minimize\ total\ energy\ needed\ to\ carry\ out\ actions\ of\ all\ mCells]$

4 Case Example and Discussion

Given the cFORE framework, two questions must be addressed in order to realize our synthetic DNA based approach to developing adaptive systems. First, *dDNA* should support system design so that a specific *sGenome* can be composed either by designers or through computing. Our previous research on evolutionary design has shown preliminary viability of such a *dDNA* based approach (Jin et al., 2005). Further research is being carried out to deal with this issue. Second, adaptive systems must be able to build themselves from *mCells* based on a given *sGenome* and be capable of reconfiguration based upon the system's appropriate *functional priority*. To address the second question, we conducted a computer simulation study using the cFORE model. The goals of the study are (1) to verify the effectiveness of *dDNA* and *sGenome* representation and (2) to test the effectiveness of the SGP based self-growth of adaptive systems based on given synthetic DNA information and reconfiguration based on the system's functional priority inscribed within it. As such the questions that we wish to address in our simulation study are: (1) can a set of individually interacting cells seeded with a particular *dDNA* self-grow into the desired system? (2) Once formed into the desired system, can it be given a task and instructed to operate in a changing environment such that the only viable means afforded to it to continue functioning and reaching its goal is through reconfiguration? Figure 4 illustrates our objective.

In figure 4, the simulation's beginning (step 1) is meant to mirror the second step after the origination of a biological system (conception) known as the Blastula Stage. Once conception has occurred, the newly

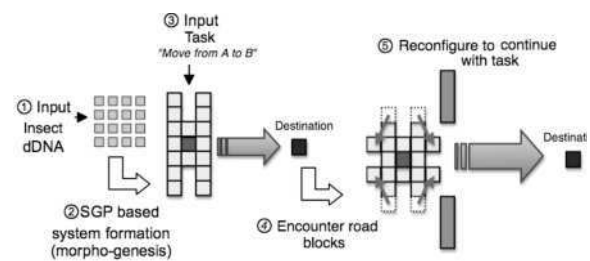

Fig 4. An adaptive reconfigurable system that reconfigure through self-organizing when encounter obstacles

formed cell containing the genetic information from both parents undergoes rapid cell division to form a collection of undifferentiated (non-specialized) cells. Since cellular division is not a viable possibility utilizing currently available technology, we have chosen to begin the simulation at Blastula with a given finite number of *mCELLS*. From this point forward the process of morphogenesis (*SGP*) takes over and utilizing cellular communication techniques, cells begin collaborating with one another in order to coordinate the process of forming the overall system. Through cellular communication and guidance by morphogenesis (*SGP*) the cells are able to self-organize to form the required shape of an insect-like system with a functioning torso (protecting the *central point*) and legs (used for motion). Color differentiation in the simulation is analogous to cellular functional differentiation in biology. Great care and attention has been taken to develop a system which as closely as possible mimics biology not just in form, but more importantly in function as well. Once the system has been formed (step 2), given a task (step 3), and placed in an environment with various obstacles (step 4), it is then up to the system to utilize its *Priority Distribution Map (PDM)* in order to navigate through to its goal (step 5).

Functionality in this problem is seen in two facets through both system level as well as cellular level functionality. Cellular level functionality is seen through color change (cellular differentiation) while system level functionality is seen through the formation of the overall system which not only looks like an insect, but also functions like one as well. This is so because contrary to engineering design, it can be argued that in biology *form* begets *function* rather than the converse. This is one of the keys differentiating biology from engineering and is often a concept that is overlooked. If a system looks like *something*, more often than not it will function like that *something*; in biology *form* dictates *function*.

As one can note from the figure, the particular problem shown is a 2 dimensional problem. Development of the morphogenesis-based control

algorithm and the communication protocols are critical aspects of this problem. Our simulation system is built using a Java-based multi-agent simulation package, MASON. In the simulation, each mCell is treated as an agent. All mCells can move in 2-dimensional space (x, y) and for simplicity are assumed to only express a single cellular function, *attachment*. The color change of the cells in the above from grey to yellow signifies cellular differentiation.

Cellular differentiation implies a cells readiness to begin functioning as part of the complete system by expressing cellular level functions (attachment) in achieving system level functions. System level functions for this particular example are discussed in greater detail below. The mCells can communicate with each other through a shared message board. A binary method, similar to that shown in Figure 3, was used to implement the system’s *dDNA*. The Φ coordinate as previously mentioned is a relative coordinate system based on the location of the *central point*, denoted in red in the above figure. The initial *dDNA* definition for the entire system and subsequent updates to its coordinates as the system moves are all with respect to the *central point*. The key in building in adaptability into the system is through the development of its *PDM* and its injection into the *dDNA* matrix through the *functional priority* element of the each of the system’s mCELL Genes. The *PDM* of the above system can be seen in figure 5.

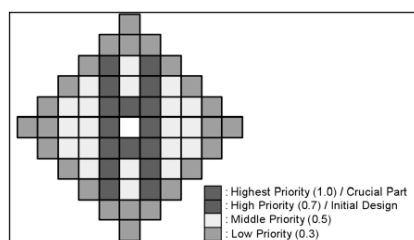

Fig 5. Abstraction of the physical states that a system, defined by *dDNA*, can hold

In the above *PDM* figure, the critical part of the system, i.e. the area designated in red with the highest priority is the part of the system in which the cells are responsible for maintaining the system level function of *protecting the central point*. This portion is critical because if this part of the system were to be damaged it would result in damage to the central point causing the system to *die*. The initial design of the system also includes the area designated by the magenta color that includes those cells responsible for expressing the system level function of *movement*. The areas in yellow and green represent possible reconfigurable states (of the magenta cells) the system can achieve if the need arises. Dependent upon the environment

encountered, the cells of the system dynamically recognize the obstruction and reconfigure based upon the priority of the open spaces defined in the system’s *PDM*. Control of the coordination of the system is achieved in a two-step process. Initial formation of the system (steps 1 and 2 from figure 4) is achieved through SGP (self-formation governing principles) and is implemented by following a CPM algorithm utilizing a dual control strategy incorporating both centralized and decentralized control in mimicking the biological morphogenesis process. Centralized control will come by way of DNA guidance while decentralized control will be utilized for the self-organization of the cells. The centralized control aspect of the algorithm is somewhat simpler to address than the decentralized aspect as the inclusion of the predefined *dDNA* matrix forces the emergent behavior of the self-organization of the cells to precisely that required form (function). The decentralized aspect of the control algorithm is a bit more complicated as it requires communication, collaboration, and negotiation between the cells trying to self-organize. Therefore a definition of the local rules that govern the interaction between the individual cells is a critical component of this aspect of the algorithm.

Through our investigation into biology and attempting to understand the process of morphogenesis it was clear that the foundation of the algorithm should be rooted in energy minimization. Since cellular movement with regards to system formation accounts for the prime source of energy dissipation, minimization of the total number of cellular steps would be desired for the algorithm. Therefore the primary goal of this demonstration besides obviously the formation of the system defined by the system *dDNA*, is its formation through the least number of steps possible, i.e. minimum energy.

The name of the algorithm *CPM* comes from Calculate, Plan, and Move. Just as in biology, communication is vitally important in morphogenesis and is achieved through the use of growth factor proteins. In the programming domain, the messages sent back and forth between the cells in effect mimic this biological protein. Communication is important, as the cells are required to know where they are going relative to one another while organizing. If no communication exists, a collective goal between all the cells can never be achieved. Planning and coordination is the result of communication. Every element in the *dDNA* matrix defines a unique cellular location and priority relative to the entire system, hence not every cell can move to the same location. Furthermore, cells need to determine *on their own* which position they should move to based on the energy minimization principle. Once the cells have an idea of where their final locations should be, they

should begin to move to that location. The beauty of this algorithm is that this process can be done in real-time so that the cells at each time step can recalculate their relative distance to those defined in *dDNA* and re-determine whether or not they are heading to the position with the highest priority and minimum energy; if so they continue, and if not they re-adjust. A schematic of the CPM algorithm used in system formation can be seen in the figure 6.

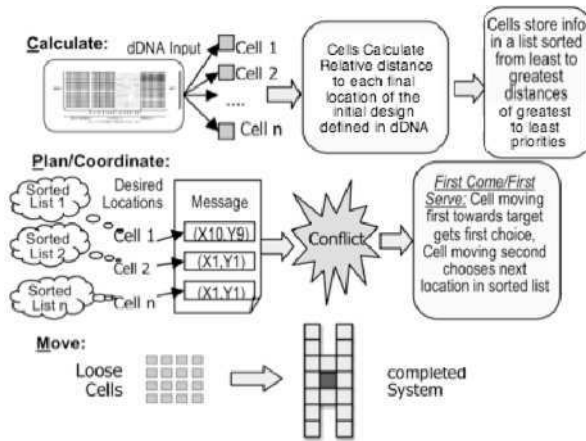

Fig 6. An illustration of the CPM (Calculate, Plan, Move) control algorithm.

The above figure shows that the first step in the process is that the desired system DNA (*dDNA*) must be seeded into each of the available cells (with cell IDs from 1 to n). In biology this step is not necessary as each dividing cell simply gets a copy of the system's DNA. The cells then use this information to calculate their relative distances to each of the final locations defined by the system DNA. The cells store this information in a list sorted from the least distance to the greatest based on priority. Planning and coordination occurs through communication whereby the cells following `<layoutPrinciples>`, `<PriorityFormationOrder>` and `<cellularActionPrinciple>` send messages about their first choice of final DNA destination to a communal message board accessible by all other cells. In the case two cells calculate the same minimum DNA final location a conflict arises and the cells must coordinate and negotiate to see who gets that final position. Looking to utilize a simple solution to this problem, we create what we call a "First Come First Serve" `<systemFormationPrinciple>` used for resolving conflicts whereby the cell (defined by its ID tag) moving first towards the desired target location gets the first choice and the cell moving second must settle for its second choice. But this may lead to a further conflict as this second choice may be a first choice for another cell. In that case "First Come First Serve" gets applied again to resolve the matter

and so on until all conflicts have been settled and each cell has a unique final DNA position. Once all cells have a tentative final location the simulation is taken through a single time step and the CPM process is repeated for each successive time step in order to optimize the minimization of the overall system energy.

Control of the reconfigure aspect of the system (steps 4 and 5) follows 4 basic rules of the System State Rule Set or *SSRS*: (1) Cells can only connect to one another at their respective cellular faces. (2) Cells must always avoid collisions with environmental obstructions. (3) Cells continuously communicate with one another about movement preferences (priority) and decisions using a communal message board. (4) System must always properly configure (dictated by environment) to a state with the highest overall system priority.

Figure 7 shows the result of one simulation run in which initial undifferentiated mCells receive insect *dDNA* and a task to move the red *central point* to the blue destination point. Upon receipt of the *dDNA* information, the undifferentiated cells form about the *central point* and proceed to move through the environmental terrain to the destination point. Once the system encounters the first roadblock, it reconfigures based on the *PDM* inscribed in the system's *dDNA*. We assume of course that the system cannot simply travel above or below the roadblocks. Upon fulfilling rule 4 of *SSRS*, the system continues towards its target where it encounters another roadblock, repeats the process until reaching its final destination point. Figure 7 is summarized below:

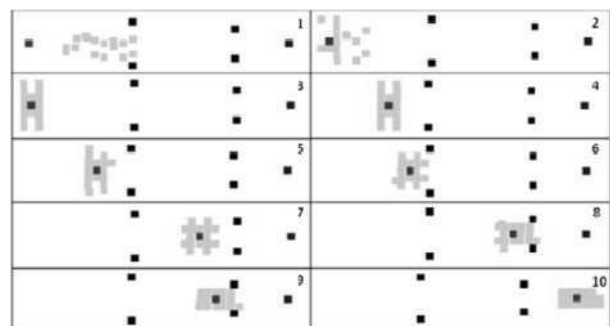

Fig 7. Simulation results, progression of time from left to right and from top to bottom

Step1: After DNA seeding has occurred, the cells move towards the red *central point* guided by *SGP*.

Step2: After reaching the desired location defined by *dDNA*, mCELLS begin forming the desired system.

Step3: mCELLS successfully form the desired system.

Step4: The system moves towards blue target point.

Step5: Encountering the first environmental roadblock the system first senses the obstruction and then begins formulating a solution by self-organizing.

Step6: The system continues trying to find the adequate reconfiguration state.

Step7: The newly modified system, which is no longer an insect-like system continues moving.

Step8: Again the system attempts to reconfigure per defined system *PDM*.

Step9: Reconfiguration continues until is it able to go through the narrower blocks.

Step10: The system reaches its final blue destination point.

Summarizing the results of the multiple simulation runs, we found that (1) system growth can be realized through a *dDNA* controlled and decentralized cellular self-organizing formation strategy; (2) as in biology, cellular self-organizing for self-growth of mechanical systems can be achieved through the use of *dDNA* and SGP (morphogenesis) principles, and cellular actions including `<commActions>`; and (3) Mechanical system reconfiguration as a means of modifying or attaining new functionality is primarily a result of the priority inscribed in a system’s *dDNA*. Moreover, the simulation design and results also have pointed us to some important and otherwise unidentified issues.

Conflict Resolution: Since each *mCell* applies `<cellularActionPrinciple>` that demands minimization of cellular energy usage (i.e., travel distance in this simulation), it is likely that multiple *mCells* may desire to fulfill the same cellular location. Hence the “First Come First Serve” conflict resolution technique was needed to overcome the arising conflicts between the *mCells*. Essentially the cells may be regarded as selfish entities with very little consideration for their neighbors or the global system in which they are a part of. The world in which they are operating in is strictly numerical as the primary algorithm that guides their behavior is based strictly on mathematics. As such, removing “First Come First Serve” altogether from the algorithm produced systems in almost all of the simulation runs with “holes” in their morphology. The undeveloped system occurs because more than one cell has chosen to occupy the same final DNA position because the cells have no means of resolving the conflict of selecting the same final DNA location with one another. Therefore if they cannot resolve the conflict, they simply ignore it and move to the same location.

Cellular Communication: Cellular communication is another important factor that affects the outcome of *dDNA* based self-growth and subsequent reconfiguration process. Again, the chief issue is conflict between or among *mCells*. Cell division

(mitosis) based bio-cell creation eliminates tremendous needs for cellular communications. But in the mechanical world where cellular coordination replaces cellular division, the case often arises where two or more cells select the same final DNA location. Therefore without proper communication between the cells, no negotiation and coordination can occur between them, i.e. “First Come First Serve” never gets enacted because such a technique is heavily based upon communication. Hence the outcome of eliminating cellular communication entirely is again an undeveloped system with “holes” because cells simply move to the location of minimum energy and highest priority without any regard for who has already moved there first.

The choice for the use of a communal message board with access to all cells was made as it was the easiest means of keeping track of all the required cellular information. But in the case of increasing the amount of cells from 17 to 100, 500, 1000 or more, the information becomes extremely difficult to handle. We envision that successful cellular communication is a key for effective *dDNA* and *mCell* based system formation and reconfiguration.

Information of *dDNA*: A third important parameter is DNA and the information it stores. As in biology, the need for the inclusion of *dDNA* into each *mechaniCELL* is required to give each cell knowledge of the greater picture of which it comprises only a small portion. Contrary to biology though, which seeds each cell with DNA through cellular division, the computer model required individually seeding each cell with the appropriate *dDNA*. As in biology, without DNA, the cells comprising the system would simply function as independent cells never expressing system level genes. Hence system level forms and functions can never be expressed and the resulting system is simply a collection of cells with cell divisions occurring out of necessity rather than requirement. Furthermore, if the cells are seeded only with information regarding the initial formation of the system (i.e. the insect) with no information relating to the system’s *PDM*, the resulting system would not be capable of reconfiguring and hence navigating through the various environmental terrains (Steps 4 and 5).

Adaptability through Priority: With regards to the adaptability, more specifically reconfiguration, the priority information inscribed in *dDNA* reflecting the *priority distribution map* is crucial. Testing the importance of priority to the adaptability of the system in the mechanical world, we observe that without this information, the resulting system simply stops upon encountering the first roadblock. It is only through the system’s *PDM* that the system can navigate through the varying environmental terrain. The limitation of the *PDM* technique is rooted in the fact that

irrespective of the size of the *PDM*, if the roadblock encountered impedes upon the system's critical area (i.e. red zone in figure 5), the system will fail.

5 Concluding Remarks

Bio-inspired design is not a new area. But unlike other bio-mimetic engineering research that mimic mechanical mechanisms of specific animals or plants (Shu et al., 2003, Dickinson, 1999), our approach uniquely attempts to mimic the *biological process* of creating, storing, and applying *design* information. Again, self reconfiguration is not a new idea, but our work differs from previous ones at a fundamental level with the incorporation of DNA and morphogenesis. Through the incorporation of *dDNA*, our work is unique in that it simply defines what the final system should be through *dDNA* and allows the cells to independently self-organize through communication protocols and local interaction rules (morphogenesis rule set) to achieve it. There is a great deal of robustness in this process and algorithm in that any desired system can be formed as long as it can be defined by *dDNA*. Furthermore, reconfiguration or alteration of the system is easily achieved through the incorporation of *priority*. In order to build a true *mechanical lifelike cellular adaptive system* for the purposes of increasing a system's adaptability and robustness, fundamentally the artificial system must not just be formed using a concept of "cells", but to be represented by *dDNA* and grown using a morphogenesis-based process whereby both the forms and functions of the system are emerged.

From a design creativity perspective, we attempted to take a nature's way of creating designs by exploring how a system should be formed, meaning how design information should be represented, stored and applied so that natural "creativity" can be realized. Although at this stage we have not stepped into the realm of letting systems evolve by themselves, the representation scheme we proposed has demonstrated its robustness to achieve adaptability. Next step is to make it evolve.

From a system design point of view, our work thus far is limited in several ways. First it is only tested in a 2D setting. Moving to 3D and going beyond moving-boxes will yield more challenges. Secondly, our work is limited by the method of computer simulation. Physical or mechanical issues such as communication, docking between cells, and physical movement of cells have not been addressed. Lastly, there has not been any exploration of "best dDNAs" and "best rule sets" that may lead to "better functionality and adaptability." Despite these limitations, our simulation-based case studies demonstrated the effectiveness of our cFORE

framework and led us to a better understanding of the key issues related to *dDNA* based adaptive system development. Our future work will address the above mentioned issues.

References

- Audesirk G, Audesirk T, Byers BE, (2007) *Biology: Life on Earth with Physiology* (8th Ed.). San Francisco: Benjamin Cummings
- Bongard J, Zykov V, Lipson H, (2006) Resilient Machines through Continuous Self-Modeling. *Science* 314(5802):1118-1121
- Chiu I, Shu LH, (2004) Natural language analysis for biomimetic design. In Proceedings of DETC '04 ASME Design Engineering Technical Conferences and Computers and Information in Engineering Conferences
- Dickinson MH, (1999) Bionics: Biological Insight into Mechanical Design. Proc. of the National Academy of Sciences 96(25):14208-14209
- Jin Y, Li W, Lu C-YS, (2005) A Hierarchical Co-Evolutionary Approach to Conceptual Design. *Annals of the CIRP* 54(1):155-158
- Rus D, Vona M, (2001) Crystalline robots: self-reconfiguration with compressible unit modules. *Autonomous Robots* 10:107-124
- Sarikaya M, (1994) An Introduction to Biomimetics: A Structural Viewpoint. *Microscopy Research and Technique* 27(5):360-375
- Shen WM, Krivokon M, Chiu H, Everist J, Rubenstein M, Venkatesh J, (2006) Multimode locomotion for reconfigurable robots. *Autonomous Robots* 20(2):165-177
- Shen WM, Salemi B, Will P, (2002) Hormone inspired adaptive communication and distributed control for CONRO self-reconfigurable robots. *IEEE Trans. on Robotics and Automation* 18(5):700-713
- Shu LH, Lenau TA, Hansen HN, Alting L, (2003) Biomimetics Applied to Centering in Micro-assembly. *CIRP Annals* 52(1):101-104
- Unsal C, Kilic H, Khosla P, (2001) A modular self-reconfigurable bipartite robotic system: implementation and motion planning. *Autonomous Robots* 10:23-40
- Vincent JFV, Bogatyreva O, Bogatyrev N, (2006) Biology Doesn't Waste Energy: That's Really Smart. *Proceedings of the SPIE* 6168:1-9
- Vincent JFV, Mann DL, (2002) Systematic technology transfer from biology to engineering. *Phil Trans R Soc A* 360:159-174
- Yim M, Duff DG, Roufas KD, (2000) PolyBot: a modular reconfigurable robot. In Proc. of ICRA IEEE Int'l Conf. on Robotics and Automation, 514-520
- Yu C-H, Haller K, Ingber D, Nagpal R, (2008) Morpho: A self deformable modular robot inspired by cellular structure. In Proc. of Intl. Conf on Intelligent Robots and Systems (IROS 08)
- Zykov V, Mytilinaios E, Adams B, Lipson H, (2005) Self Reproducing Machines. *Nature* 435:163-164

Developing a Coding Scheme to Analyse Creativity in Highly-constrained Design Activities

Elies A. Dekoninck, Huang Yue, Thomas J. Howard and Christopher A. McMahon
University of Bath, UK

Abstract. This work is part of a larger project which aims to investigate the nature of creativity and the effectiveness of creativity tools in highly-constrained design tasks. This paper presents the research where a coding scheme was developed and tested with a designer-researcher who conducted two rounds of design and analysis on a highly-constrained design task. This paper shows how design changes can be coded using a scheme based on creative ‘modes of change’. The coding scheme can show the way a designer moves around the design space, and particularly the strategies that are used by a creative designer to skip from one ‘train of solutions’ to new avenues. The coding scheme can be made more robust by: ensuring design change is always coded relative to a reference design; tightening up definitions of ‘system’, ‘element’ and ‘function’; and using a matrix to develop a more complete set of codes. A much larger study with more designers working on different types of highly-constrained design task is needed, in order to draw conclusions on the modes of change and their relationship to creativity.

Keywords: creativity, highly-constrained, coding scheme, empirical study, modes of change, design rationale, design space

1 Introduction

This work is part of a larger project which aims to investigate the nature of creativity and the effectiveness of creativity tools in highly-constrained design tasks. Much work has been done on the development and use of creativity tools for conceptual design and the early stages of design. At later stages, and at sub-systems levels, design activities are subject to more, and more tightly specified, constraints. However, this research is based on the premise that benefits will be experienced by introducing appropriate creativity tools through the entire design process, including stages that include highly-constrained design tasks. The potential for benefits from this kind of research has recently also been highlighted in computational creativity research (Brown, 2010). At low systems levels and in the later

stages of the design process, which are more highly-constrained, creative idea generation activity may be quickly passed over, particularly when a parametric or selection design will suffice.

This paper is based on an empirical study of creativity in highly-constrained design tasks. In order to interpret the observations, it was deemed necessary to develop a coding scheme to analyse the outputs from this design activity in more detail. This paper reports on the development of this coding scheme.

1.1 Modes of Change in Design

Based on our informal observations of designers who are particularly creative in highly-constrained design situations, the researchers hypothesized that their design solutions and approaches can be coded using an adapted version of McMahon’s Modes of Change (McMahon, 1994). McMahon was looking specifically at design activities that have been labelled as ‘normal’ design (Vincenti, 1990) or ‘variant/adaptive’ design (Pahl and Beitz, 1984), where predominantly incremental changes take place. Although not the same, highly-constrained design tasks – the subject of the work reported here - do share some of the characteristics of normal/adaptive/variant design tasks. McMahon suggested that there are five ways in which a product or process can be changed in order to make an improvement. These are called modes of incremental change in design and comprise: design parameter space exploration; improvement in understanding of design attribute relationships; change in product design specification; modification of the feasible design space; and adoption of a new design principle.

For the work reported here, it was necessary to adapt McMahon’s Modes of Change in order to be able to code particularly creative responses in highly-constrained design situations. Table 1 below shows how the adaptations were made. So for example, ‘Change in the Feasible design space’ was adapted to become ‘Technology pull’ in the coding scheme. In

this case it was hypothesized that particularly creative changes in the feasible design space would manifest themselves as solutions that pull in/deploy a new/different technology to great benefit. ‘Change of specified performance parameter(s)’ and ‘Change of utility function’ are considered as ‘not related’ to ‘highly-constrained design tasks’ (the focus of this research) as those changes involve changing those constraints.

In the adapted version (referred to in this paper as the 1st coding scheme) four ‘Creative Modes of Change’ were identified: New Auxiliaries, Functional Integration, Technology Pull and New Design. The modes shown in bold make up the codes used in the 1st coding scheme.

Table 1. Adaptations to McMahon’s Modes of Change

Modes of Change (McMahon, 1994)	Relation to highly-constrained design tasks	Creative Modes of Change
1. Parameter change (PC)	Related	Routine
2. Improved understanding of design-performance parameter relationships (IU)	Related	Routine / analytical
3. Change in product design specification		
i. Change of specified performance parameter(s)	Not related	N/A
ii. Change of utility function	Not related	N/A
iii. Change of set of functional requirements	Related	(1) – New Auxiliaries (NA) (2) – Functional integration of other modules (FI)
4. Feasible design space	Related	(3) – Technology pull (TP)
5. Change of principle	Related	(4) – New designs (ND)

This paper presents the research where the coding scheme was tested with a designer-researcher who conducted two rounds of design and analysis on a highly-constrained design task. Following the first design round, the outputs were coded using the proposed ‘Creative Modes of Change’ coding scheme.

Following the first coding process, adjustments were made to the 1st coding scheme, resulting in what is referred to as the 2nd coding scheme.

In the second round of design, various creativity tools were suggested to stimulate particular types of outcomes. The 2nd version of the coding scheme looked in particular at three aspects of the design modification: the driving factor (the designer’s thinking/motivation), the design modification itself (what is evident in the design solution) and the outcome of the modification (the resultant benefit to the system being designed).

The link between each creativity tool and the type of design modification is reported in a separate paper (in preparation for ICED11). That aspect of the project aimed to develop more sophisticated selection and application of the creativity tools through the design process, in particular focusing on selecting the most effective tools for highly-constrained design tasks.

In the context of a highly-constrained incremental design task, this paper answers the question whether design improvements/changes can be categorised into different creative modes of change. The data can show whether patterns of modes of change occur throughout a creative design process and whether particular patterns might lead to more successful outcomes in terms of solution quality? This paper cannot say much about the relative ‘creativity’ of the outcomes per se, as measures of creativity were not taken.

2 Methodology

The majority of tasks in the project were carried out by a single researcher (HY) who played both the role of the designer and the researcher. This type of participatory action research (Bjork and Ottosson, 2007) approach is common in design research. The seminal engineering design research by Hales (1986) is a good example of this design and self reflection research approach. It is important to note that the designer-researcher must be able to clearly differentiate when he or she is in each mode and must be particularly careful not to allow the researcher’s mindset to affect the ‘natural design behaviour’. This does of course happen to some degree, but can be reduced by adding some form of triangulation to the method. In the research reported in this paper, additional researchers coded the first round of design and analysis. It is worth noting that the designer-researcher (HY) also had excellent ‘switching’ discipline and the results are robust as a consequence. In order to further reduce research bias, the methodology was also constructed such that analysis

and coding could not begin until the design activity had finished.

Table 2. Sequence of activities for the experiment

	Activity description	Researcher ID	role played (designer-researcher)
1 st round of design and analysis	Development of the 1st coding scheme: Creative Modes of Change	TJH	researcher
	Briefing on the highly-constrained design task	HY	designer
	Development of design ideas	HY	designer
	Review and iteration of the design ideas	HY TJH	designer
	Coding the design ideas using 1 st coding scheme	HY	researcher
	Assessing the quality of design ideas using company's Criteria Decision (MCDA) table	HY TJH	designer
	Inter-observer coding of the design ideas using 1 st coding scheme	TJH EAD	researcher
2 nd Round of design and analysis	Development of the 2nd coding scheme	HY	researcher
	Development of design ideas – With creativity tools	HY	designer
	Coding the design ideas using 2 nd coding scheme	HY	researcher
	Assessing the Quality of design ideas using the company's MCDA table	HY TJH	designers
	Analysis of results	all	researcher

A Logitech digital pen and paper note book was used to convert and store a digital copy of the design sketches and written notes that the designer created though the process. The digital notebook also contained a column that was used by the researcher to code the design outputs. Almost all of the design outputs were also modeled using computer-aided design (CAD), and it is these representations, which were then presented in sequence with significant descriptive notes, that were formally coded.

The design task itself is not described in this paper, as it is a real task previously performed in industry and the researchers are planning to compare the outputs from the experiment with those from industry

Table 2 above describes the sequence of activities that took place in the experiment and highlight the particular roles that the various researchers (referred to as HY, TJH and EAD) played.

Figure 1 below shows an example of how the design ideas were presented in sequence and how they were formally coded. The first two columns show the numbering system used for the design ideas. B1 represents an initial, unique design idea. B2, B3 and B4 show the iterations of this design idea. The last five columns show how each of the design ideas were coded using both the 1st and 2nd coding schemes developed in this research.

3 Results

Looking at the whole data set in the first round showed that, for 18 out of the 30 design ideas coded the researchers agreed, whilst in 12 cases the coders were not in agreement. It was this disagreement and the following discussion that lead the development of the 2nd coding scheme.

Table 3 below shows a sample of the discussion from the 12 cases where the coders were not in agreement.

Table 3. Sample of the coding disagreement discussion

Design	Coding		Possible explanations
	HY	EAD/TJH	
E2	FL, ND	TP	HY suggests the integration of the hinge (was a part of the super-system) into the flap (another part of the super-system) should be coded as FL. HY also suggests the change did not happen because of the use of thin and flexible material but because of the need to integrated hinge to reduce cost and complexity, therefore coded as ND.
E3	ND	PC	Similar to Concept A1 and A6, HY suggests the new design to control flow rate should be coded as ND. In addition, a new set of design parameters and relationships (dimension of cut and the ease of controlling flow rate) are established, which makes the change beyond the scope of PC.

Some observations and recommendations were drawn from the disagreements above:

- A reference design that the new design idea is compared to should be specified before coding. This seems obvious in retrospect, as it is impossible to code the initial set of ideas without a reference design: a change needs to be coded relative to something. Once the initial

ideas are coded, subsequent design iterations can be coded relative to each one preceding it.

- Although all coders were given definitions for each code, coders should be trained in advance using an example to elicit queries and tease out any problems with the coding scheme.
- One of the requirements of New Auxiliaries (NA) is to bring in new functions that are not listed in the original functional requirement. This caused some disagreements when new elements were added to the system, and highlighted the need for clear definitions of 'system', 'element' and 'function' (see section 3.1.2) The coding scheme could be improved by defining New Auxiliaries as an additional element/module instead of additional function. For differentiating whether a new function is added, the outcome of the modification can also be coded as Additional Function or Reduced Function;
- Quite often Technology Pull (TP) or Improved Understanding (IU) cannot be identified without knowing the rationale from the designer who made the modification. For

example in design idea E2, researcher HY coded the concept as New Design (ND) since being the designer, he knew that the reason for the modification was the need to integrate a hinge to a flap. However, the other researchers (TJH and EAD) considered the change as the result of new material (thin and flexible plastic) therefore coded that change as Technology Pull (TP). In idea F2 a very similar situation arose, but the other way round. It is therefore clearer to separate Improved Understanding (IU) and Technology Pull (TP) from rest of the modes of change and code them as the factors that drive the design modification (or design rationale).

- Researcher TJH suggested Modularization as a new mode of change when coding design idea A2, in order to provide a mode of change that is opposite to Functional Integration (FI).
- A similar approach was applied to New Auxiliaries (NA) where; Trimming could be introduced as a new MOC that describes the modification that discards unnecessary element to improve performance.

Design Concept	Figure	Description	Coding scheme				
			TJH's		HY's		
			EAD/TJH	HY	Driving factor	Modification	Outcome
B 1	<p>The figure shows a hand-drawn technical diagram of a bottle closure mechanism. It includes several views: a side view of the bottle with a plastic insert and flaps, a top view of the plastic insert, and detailed views of the flaps and their interaction with the bottle neck. Labels include 'Closure', 'Ring', 'Flaps', 'Plastic Insert', 'Content', 'Bottle', 'Residual dripping', and 'Upper flap may also deflect out, but doesn't affect the overall function'. Handwritten notes describe the design's purpose: 'This design consists of a normal metal closure and an additional plastic insert (shaded). Two flaps of the insert are made of thin hence flexible plastic. When pouring, the flap at the lower flap would deflect out. When finish pouring, residual dripping would be kept within the insert. When the bottle is put back to upright, the flap deflect inwards so that residual dripping flows back into the bottle. Top view of the plastic insert, only flaps are shaded in this figure for better differentiation.' The diagram is annotated with letters A through E corresponding to these descriptions.</p>	A plastic insert with two flexible semicircle flaps are used. When content is poured, the flow pushes the flaps outwards and forms a ramp, any dripping is therefore left on the flap and goes back to the bottle when the flap bends inwards due to the weight of the dripping when bottle is placed upright.	ND	ND	NR	NA	MF

Fig 1. Sample of design idea formal coding sheet

3.1 Introducing the 2nd coding scheme

The modified scheme comprises three ‘levels’ of design change to be coded: the factor that drives the modification, the design modification itself, and the final resulting effect on the system from the modification. Figure 2 shows the three levels used in this 2nd coding scheme.

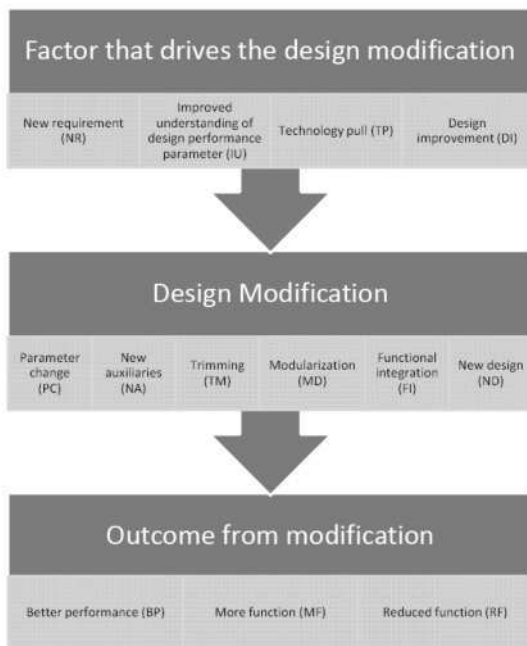

Fig. 2. Three levels of the 2nd coding scheme.

3.1.1 Factor that drives the design change

The coding in this section describes the various types of rationale which can drive the specific design modifications. Design rationale includes ‘not only the reasons behind a design decision but also the justification for it, the alternatives considered, the trade-offs evaluated and the argumentation that led to the decision’ (Lee, 1997). These are not obvious by simply looking at the design modifications themselves. Even for the same design modification, the underlying rationale may be different and therefore usually best described by the designer who made the modification.

- New requirement (NR) - One or more new requirements raised by market/organization/designer, or any other party, that requires new design ideas to achieve.
- Improved understanding of design performance parameter (IU) - Through modelling and empiricism engineers benefit from the discovery - or better understanding -

of relationships between the design parameters and the performance. This understanding can then go on to drive various design modifications.

- Technology Pull (TP) - The adoption of a novel and appropriate technology or material to expand the design space, which can then in turn drive various design modifications. This may simply have a direct relationship to performance, such as changing material to reduce weight. However, it could lead to more complex relationships. One example observed in recent research, was where a new material coating was adopted, which enabled a different spray coating process, and eradicated post process machining, thereby producing substantial benefits.
- Design Improvement (DI) - Without adding any new requirement, the rationale of the modification is only to further improve the performance of the system. During the iterations of design ideas, the designer sometimes sees opportunities to set higher targets for the system. This raises the standard for the design ideas without adding any new requirements.

3.1.2 Design Modification

These define the ways in which each design idea presented differs with respect to the reference design. In this study, the initial unique design idea presented (e.g. B1) was compared to a common solution already on the market. The subsequent design iterations (e.g. B2, B3, etc.) were coded relative to each one preceding it. The codes presented below are based on the assumption that in highly-constrained design tasks, the designer is usually designing ‘elements’ (parts) of a sub-system, which perform particular ‘functions’ for the ‘system’ (or super-system). The different types of changes that are seen as the design ideas evolve are defined as:

- Parameter Change (PC) - In this change the parameter of an existing design element is modified. However the ‘performance - attribute’ relationships governing the design are not changed as a parameter is adjusted. Thus changing the ‘number of wheels on a car’ is not a parameter change, as new ‘performance - attribute’ relationships are inevitably formed when changing the number of wheels.
- New Auxiliaries (NA) - In this change a new function which was not a part of the system,

and is distinct from any other function within the system, is added into the system.

- Modularisation (MD) - In this change the functional requirements of a system are fulfilled by an increased number of sub-systems, parts or features. This may for example, be beneficial to the design in terms of: increasing reliability, adaptability, or performance. Suh (1990) for example, advocates decoupling functions such that each function has a single associated part or feature.
- Functional integration (FI) - In this change any two or more elements within the system are combined into a single element that performs the same function.
- New Design (ND) - In this change an existing function is performed by a completely new element.
- Trimming (TM) - This change occurs when any element is discarded.

3.1.3 Modification outcome

Codes in this section describe the different types of outcome observed for the overall system. These describe changes in the overall function or performance or the final resultant benefits to the system from the creative design modifications.

- Better performance (BP) - The existing system performs better.
- Additional function (AF) - Extra function is added to the system. The function may or may not have been part of the original functional requirements. A creative design modification occurring during the process may add additional beneficial functions to the system.

Reduced function (RF) - Function is discarded from current design, a direct opposition to Additional Function, in order to improve the overall performance of the system.

3.2 Reviewing the coded concepts on a timeline

Figure 3 on next page presents all the design ideas on the project day-by-day timeline. For example, A3 (PC) means the third iteration of the initial idea A1, where Parameter Change is the Mode of Change evident in the design. Only the agreed coding from round 1 is included in brackets behind the concept numbers. In order to use the 1st and 2nd round of design and analysis as a single data set, only the Design Modification codes of the 2nd Coding scheme are presented in this diagram as they are coded at the same ‘level’.

There were 6 days between the two rounds were no new concepts were generated. It is possible to detect some patterns of modes of change that occur throughout a creative design process, these are discussed in section 4.2. Each of the final concepts (e.g. A9, B5, C3, etc) was given a Quality score from the company’s Multi Criteria Decision Analysis (MCDA) table. The company’s MCDA table consists of eight criteria against which each concept is scored, these are added up to generate the Quality score. The MCDA includes functional criteria such as ‘hold low vacuum’ and ‘hygienic’ as well as business criteria such as ‘product cost’ and ‘development time required’. The Quality score is shown below in bold and is out of maximum of 72. Whether particular patterns lead to more successful outcomes in terms of solution quality is discussed in section 4.2.

4 Discussion

This section discusses the design modification codes (middle ‘level’) from the 2nd coding scheme as these were analysed in more depth than the results from the other two levels. It also makes general observations about the modes of change observed.

4.1 Discussion of the 2nd coding scheme

In practice in the study, the codes were created through the action research cycle, using a type of content analysis, where definitions of codes were adjusted, and new codes were created, in order to be able to code the entire data set. In retrospect, it is possible to view the codes created in this research as describing two fundamental aspects that change: the functions that are performed by the design and the actual designed elements that perform those functions. They change by creating, discarding or integrating. Figure 4 below shows how the definitions of the codes presented in section 3.1.2 can be placed in the matrix.

		Element			
		existing	new	integrate	discard
Function	existing	PC	ND MD	FI	
	new		NA	(b)	
	integrate		(a)		
	discard				TR

Fig. 4. Matrix of Design modification codes relating to changes in elements and functions.

This helps to highlight the difference between New Design (existing function is performed by a new element) and New Auxiliaries (new function is added into the system). The matrix also highlights an anomaly in one of the codes. Functional integration (FI) is actually defined as the integration of elements, and should perhaps be relabeled as Element Integration (EI). The table also points towards the opportunity to define other Design Modifications that did not arise in this experiment but could be useful both for coding future experiments, for example: the integration of existing functions through the design of a new element (a); or creation of a new function by integrating existing elements (b).

Although the single case presented here does not allow detailed analysis of the three 'levels' coded in the 2nd coding scheme they do provide some insights into the nature of creativity in highly-constrained design tasks. At the top level, it may be possible to develop/specify tools that stimulate designers to think of strategies that then drive successful design modifications. These types of tools would have to work through stimulating/guiding design rationale. Looking at the middle level where the design ideas themselves are coded, it may be possible to specify particular creativity tools to stimulate particular design modifications. This experiment was able to initiate this work which is reported in (in preparation for ICED11). It is worth noting that before this can be done, a much

larger study is needed to understand the design modifications - or patterns of them - that deliver the most creative results in highly-constrained design tasks. At the third (outcome) level it may be possible to develop/specify tools that stimulate designers to think of strategies for the system that then drive successful design modifications at the sub-systems level.

4.2 Patterns in Modes of Change

Studying the data in Figure 3, it is possible to detect some patterns of modes of change that occur throughout a creative design process. These findings are tentative observations due to the limited number of coded instances. In most cases it is clear that the initial idea (e.g. B1, C1, D1, etc) starts with a New Design (ND) (round 1) or a New Auxiliary (NA) (round 2) followed by iterations of the ideas in the form of Parameter Change (PC). In some cases this works the other way round where successive iterations of Parameter Change (PC) lead to New Designs (ND) in the final instance (e.g. A8 and F6). This may happen where the designer feels they have pushed the idea to its limits and thus comes up with a totally new direction to explore. The difference between the number of New Design (ND) and a New Auxiliary (NA) codes between the two rounds is likely to be mainly due to changes in the coding scheme.

1st round of design											
day	1	2	3	4	5	6	7	8	9	10	11
		A1, B1(ND)	A2,C1 (ND)	D1 (ND), E1 (ND)	F1			C2 (FI), C3 (PC) 32 , D2 (PC) 38 , E2, E3 34			
1st round of design											
day	12	13	14	15	16	17	18	19	20		
			A3 (PC), A4 (PC)			B2 (PC), B3 (PC)	F2, F3	A5(PC), A6, A7(PC), A8(ND), A9 42 , B4(PC), F4, F5(PC), F6(ND), F7 24	B5 40		
2nd Round of design											
day	1	2	3	4	5	6	7	8	9	10	11
	G1 (ND) 46 , H1 (NA)	I1 (NA) 27 , J1(NA)	K1(NA), K2 (ND) 38			L1 (NA), M1 (NA) 35 , N1(NA)		H2 (PC) 44 , L2 (NA), L3 (PC) 21 , O1 (NA) 31			J2 (PC) 26 , N2 (PC) 35

Fig. 3. Overview of all design ideas, coded on the project timeline day-by-day.

Each of the final concepts (e.g. A9, B5, C3, etc) was given a Quality score from the company's MCDA table. The score is shown in Figure 3 in bold and is out of maximum of 72. From this data there is no clear quality difference between the design output from round 1 without creativity tools (average score: 35) and round 2 with creativity tools (average score: 34). However the pattern in which solutions were generated was significantly different, where in round 1 most initial ideas (6 in total) were iterated several times (usually through Parameter Change), round 2 yielded many more initial ideas (9 in total). There was however no pattern in the quality scores linked to the time spent (number of days) or any benefit of 'carrying the ideas' through (number of iterations).

Coding design output in this way may contribute one way of mapping the way designers move around the design space, and particularly the strategies that are used by creative designers to skip from one 'train of solutions' to new avenues.

5 Conclusions

This paper shows that it is possible to categorise design changes into different creative modes of change using the coding scheme developed. The coding scheme can be made more robust by: ensuring design change is always coded relative to a reference design; tightening up definitions of 'system', 'element' and 'function'; and using a matrix, such as the one presented in Figure 4, to develop a more complete set of codes.

A much larger study with more designers working on different types of highly-constrained design task is needed, in order to draw conclusions on the modes of change and their relationship to creativity. Design research would benefit even more if such a study was conducted in industry. The single case presented here does show that there can be creative steps in each type of mode of change. One promising area identified for further research is to look at the patterns of modes of change that occur throughout a creative design process. Some common patterns were identified in this paper, but there were no links between patterns and

final outcomes in terms of solution quality. The methodology could be made more robust if the designers and researcher coded separately and data was triangulated with direct observations, 'thinking aloud' protocol or reflective interviews.

Although in this case we did not measure creativity as part of the study, the coding tool developed will help to map the way designers move around the design space, and particularly the strategies that are used by creative designers to skip from one 'train of solutions' to new avenues.

The coding scheme can ultimately perform two functions for design research: firstly by understanding existing practice in greater detail (e.g. conducting a study of particularly talented/creative designers working on highly-constrained design tasks); or using even early outcomes iteratively to specify/develop tools to stimulate creativity in highly-constrained design tasks (e.g. cycles of action research that develop and test tools stimulating/guiding particularly creative design rationale).

References

- Bjork E, Ottosson S, (2007) Aspects of consideration in product development research. *Journal of Engineering Design* 18(3):195–207
- Brown DC, (2010) The Curse of Creativity. In proceedings of DCC10: The 4th International Conference on Design Computing and Cognition, Stuttgart, Germany, 12–14 July
- Hales C, (1986) Analysis of the engineering design process in an industrial context. *Mechanical Engineering: Cambridge, University of Cambridge*
- Lee J, (1997) Design rationale systems: understanding the issues. *IEEE Expert* 12(3):78–85
- McMahon CA, (1994) Observations on modes of incremental change in design. *Journal of Engineering Design* 5(3):195–209
- Pahl G, Beitz W, (1984) *Engineering Design*. Design Council/ Springer: London
- Suh N, (1990) *The Principles of Design*. Oxford University Press: USA
- Vincenti W, (1990) *What Engineers Know and How they Know It*. John Hopkins University Press: Baltimore, MD

Effectiveness of Brainwriting Techniques: Comparing Nominal Groups to Real Teams

Julie S. Linsey and Blake Becker
Texas A&M University, USA

Abstract. Engineering designers need effective and efficient methods for idea generation. This study compares the effectiveness of group idea generation techniques to the combined efforts of individuals working alone with redundant ideas removed, so called “nominal groups”. Nominal groups compared to real interacting groups is a standard approach for determine if a group idea generation method can produce better solutions then individuals working alone. This study compares nominal group data to existing data on a series of group idea generation techniques. Results show that groups using rotational viewing and representing their ideas with words & sketches, a hybrid 6-3-5 method, outperform nominal groups in number ideas and have an equal level of quality. This result is in contrast to comparing Brainstorming groups to nominal groups where nominal groups outperform Brainstorming groups. These results indicate that a team can be more effective than individuals working separately.

Keywords: creativity, idea generation, brainwriting

1 Introduction and Background

Over one hundred formal idea generation techniques have been developed in areas such as psychology, business, and engineering (Adams, 1986; VanGundy, 1988; Higgins, 1994). Some methods like Osborn’s Brainstorming have received significant evaluation whereas for many graphical methods there is little data available.

One of the first studies using Osborn’s Brainstorming method in engineering design included engineering professionals working on a realistic engineering problem and showed that groups using brainstorming produced fewer ideas than the combined efforts of an equivalent number of individuals working alone (Lewis, et al., 1975). This result, called productivity loss, is consistent with the vast majority of studies on variations of Osborn’s Brainstorming (Mullen, et al., 1991).

While the data on Brainstorming techniques is extensive, there is far less data available on brainwriting techniques where communication is

through written words or sketches. For brainwriting techniques, some data suggests that groups can be more effective than the combined individual efforts (Gryskiewicz, 1988; Paulus and Yang, 2000). Recent studies have focused on the development and evaluation of more effective idea generation methods in engineering and design related fields, including industrial design and architecture (Shah, 1998; Shah, et al., 2000; Van der Lugt, 2002; Shah, et al., 2003; Vidal, et al., 2004). These studies have used a mixture of sketches, verbal descriptions of ideas, and physical models in the idea generation process. Prior work on graphical brainwriting techniques (e.g., Brainsketching, C-Sketch, Gallery), has not compared nominal groups (non-interacting individuals whose non-redundant results are combined) with real interacting groups.

Our study compares nominal groups with group ideas generation methods: Brainsketching, C-Sketch, 6-3-5, and the first phase of the Gallery method. These methods are gaining popularity and exposure in the engineering research community, in addition to industrial application. They also form a diverse set of group idea generation techniques that vary in how ideas are exchanged and in the types of representations used (written words, sketches, etc.). To understand the theoretical basis of these method, we dissect them into two key factors (1) how a group’s ideas are displayed to other members (“rotational view” or all are posted in “gallery view”) and (2) the form of communication between group members (no communication, written words only, sketches only or a combination of words and sketches.) All other method parameters are kept constant for all experimental conditions.

1.1 Osborn’s Brainstorming

The term “brainstorming” is frequently applied to idea generation techniques in general and not just to the technique developed and named by Osborn. Osborn’s Brainstorming begins with a facilitator explaining the problem. A group then verbally exchanges ideas

following four basic rules: (1) criticism is not allowed, (2) “wild ideas” are welcomed, (3) building off each others’ ideas is encouraged, and (4) a large quantity of ideas is sought. Despite the face validity of these rules, much research demonstrates productivity loss in brainstorming compared to an equal number of individuals working alone (nominal groups) (Mullen, et al., 1991).

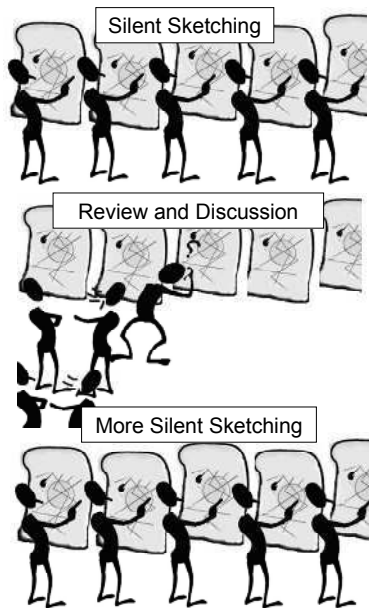

Fig. 1. Illustration of Gallery method

1.2 Brainsketching

In Brainsketching, individuals begin by silently sketching their ideas on large sheets of paper including brief annotations. Group members exchange drawings and silent sketching continues for another period of time (VanGundy, 1988). This technique allows for a visual means of expression, and so it is well suited for product design. Van der Lugt used teams of advanced product design students to compare Brainstorming to a variant of Brainsketching (that included the explanation of ideas between exchanges) (Van der Lugt, 2002). The Brainsketching variant led to more cases in which group members built on previously generated ideas than did Brainstorming.

1.3 Gallery

In the Gallery method, individuals begin by sketching their ideas silently on large sheets of paper. After a set amount of time, participants discuss their ideas and move about the room studying others’ ideas. This review phase is followed by a second stage of silent

sketching (VanGundy, 1988; Pahl and Beitz, 1996; Shah, et al., 2001). The review phase allows team members to clarify their ideas, and it provides social interaction.

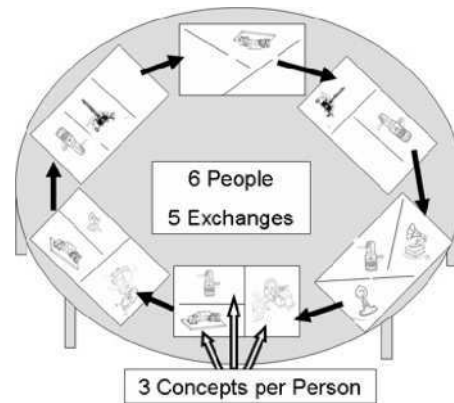

Fig. 2. Illustration of 6-3-5 and C-Sketch. Six people silently describe three ideas on a sheet of paper and then exchange papers

1.4 C-Sketch / 6-3-5

For 6-3-5 (Shah, 1998; Otto and Wood, 2001; Shah, et al., 2001) and C-Sketch (Shah, 1998), six (“6”) participants are seated around a table, and each silently describes three (“3”) ideas on a large sheet of paper. The ideas are then passed to another participant. This exchange goes on for five (“5”) rounds. For the original 6-3-5 method, ideas are described using only words. In contrast, the C-Sketch, method permits only sketches. One advantage of C-Sketch over 6-3-5 is that sketches are typically ambiguous, and so one person may misinterpret aspects of someone else’s sketch, which may lead to new ideas (Shah, et al., 2001). Other variations of 6-3-5 have also been proposed (VanGundy, 1988; Otto and Wood, 2001). One variation permits annotated sketches (Otto and Wood, 2001). In experimental comparisons with different conditions than those reported in this paper, C-Sketch and Gallery outperformed 6-3-5 (words only) for variety, quality and novelty of ideas (Shah, et al., 2001). Novelty is how unique a particular idea is and variety is how much of the design space is captured by a set of ideas. This previous study used groups of mechanical engineering undergraduates, mechanical engineering graduate students and professional designers. Each group was evaluated on all three techniques and a different design problem was solved for each of the techniques. This design eliminated individual differences as a noise variable but caused the technique results to be confounded with the design problem.

2 Experimental Approach and Research Questions

Engineers seek a robust idea generation method for predictably producing a large quantity of high quality, novel product solutions. Using a factorial design of experiments, our study explores the influence of the representation used to communicate ideas and how ideas are displayed to individuals. We seek to answer the following research questions:

- Research Question: How do the nominal groups compare to real groups in terms of quantity and quality of ideas?

This research questions is addressed systematically in the following sections. We discuss our experimental method, metrics for evaluation, data analysis approach and the results.

3 Experimental Method

We conducted a factorial experiment in order to explore the effects of two key factors on the outcome of group idea generation. The first factor controls how participants view the ideas, either all ideas are posted via gallery (on the wall), sets of ideas are rotated between participants, or they are not exchanged (individual idea generation-nominal groups). The second factor controls how participants represent their ideas. Participants either use written words only, sketches only, or a combination of written words and sketches to communicate ideas to their teammates. A 2 (Display of ideas: “gallery” or “rotational view”) X 3 (Representation: words only, sketches only, or words combined with sketches) factorial experimental design is used (Table 2). No oral discussions are allowed during the session; all communication is written. This approach produces methods similar to 6-3-5 (Pahl and Beitz, 1996), C-Sketch (Shah, 1998), Brainsketching (VanGundy, 1988), or Gallery Method (Pahl and

Beitz, 1996), as shown in Table 3. All participants solved the peanut sheller problem (Linsey, et al., accepted).

3.1 Factor 1: Display of Ideas

One key factor in this study is whether ideas are displayed all at once or whether participants see only a subset at any given moment. In the “gallery view” condition, all ideas generated by the team are posted on the wall, so all participants can see all of the ideas at the same time. This approach results in a method similar to Gallery Method or Brainsketching (VanGundy, 1988; Pahl and Beitz, 1996). In the “rotational view” condition, ideas are passed around the table, so that each participant sees only a subset of the ideas at any given moment. This condition is similar to 6-3-5 or C-Sketch (Pahl and Beitz, 1996; Shah, 1998; Otto and Wood, 2001).

3.1.1 Gallery View Condition- Similar to Brainsketching or Gallery Method

For the first 10 minute period, each student is given a number of paper sheets and told to write down at least two ideas on separate sheets of paper. Sheets are collected as participants finish, but are not displayed until the end of the period. The time period length is based on the available time and recommendations from the literature, which vary from five to 15 minutes (VanGundy, 1988; Baxter, 1995; Shah, et al., 2000). The ideal time period for the methods under evaluation is not explicitly known and is not one of the experimental parameters. At the end of the first period, all sheets are numbered and posted gallery style on the wall. In the four subsequent 7.5 minute periods, ideas are posted as they occur and participants are told to execute one of the following options:

2. Add new ideas to one of the posted drawings. Participants can request a drawing by writing down its number on a small sheet of paper.
7. Make a separate drawing that is related to the

Table 1. Experimental conditions

	Factor 2: Representation		
	Words Only	Sketches Only	Words and Sketches
Factor 1: View Condition			
Gallery View	1	3	5
Rotational View	2	4	6
Individual	7		8

ideas that are already posted, and write the number of the linked idea on the new sheet.

8. Start a completely new sheet after reviewing the posted ideas.

For the first 10 minute period, each participant is given a number of paper sheets and told to write down at least two ideas on separate sheets of paper similar to the “gallery view” condition. At the end of the period, the experimenter collects all sheets and systematically redistributes them such that each participant views each set of papers once. Participants cannot identify which one of their teammates had the sheets previously. In the four subsequent periods, lasting 7.5 minutes each, participants have the same options as in the “gallery view” condition: to add ideas to an existing sheet, to create a new product solution linked to another sheet or to start a completely new product solution. The exception here is that participants focus on the specific set of papers given to them at a particular instance in time.

Table 2. Experimental conditions and similar formal method

Experimental Condition	Similar Formal Idea Generation Method
1	Electronic Gallery (Aiken, et al., 1996)
2	6-3-5
3	
4	C-Sketch
5	Gallery
6	Brainsketching

3.1.2 Rotational View Condition- Similar to 6-3-5 or C-Sketch

For the first 10 minute period, each participant is given a number of paper sheets and told to write down at least two ideas on separate sheets of paper similar to the “gallery view” condition. At the end of the period, the experimenter collects all sheets and systematically redistributes them such that each participant views each set of papers once. Participants cannot identify which one of their teammates had the sheets previously. In the four subsequent periods, lasting 7.5 minutes each, participants have the same options as in the “gallery view” condition: to add ideas to an existing sheet, to create a new product solution linked to another sheet or to start a completely new product solution. The exception here is that participants focus on the specific set of papers given to them at a particular instance in time.

3.1.3 Nominal Groups

For the nominal groups, individual were assigned to work alone and were given the same amount of time.

The nominal group data was taken two semesters after the group data was collected. The same professor taught the class and the same experimenter collected the data. During the semester the nominal group data was collected and prior to data collection, the participants in the nominal groups were accidentally shown example peanut shelling machines (Fig. 3). These ideas were only shown briefly in class and the participants’ data does not appear to be influenced.

The nominal groups were formed by randomly assigning the results from five individuals to a group and removing redundant results. Data is from twenty-four individuals whose results were used to create forty nominal groups.

3.2 Factor 2: Representation

The second experimental factor prescribes how the participants communicate their ideas to other participants (words only, sketches only with no words, or a combination of words and sketches). At the end of the sessions and after completion of the surveys, participants in either of the group sketches-only conditions labeled their sketches with brief descriptions to facilitate evaluation. American mechanical engineers are typically not taught to draw free-hand and therefore their sketches are usually difficult to interpret without annotations. The prior study (Linsey, et al., accepted) shows that the sketches only data shows a different pattern of results likely due to the poor sketch quality and effort required by teammates to interpret the drawings. For this reason, individual data was not taken and therefore no nominal groups.

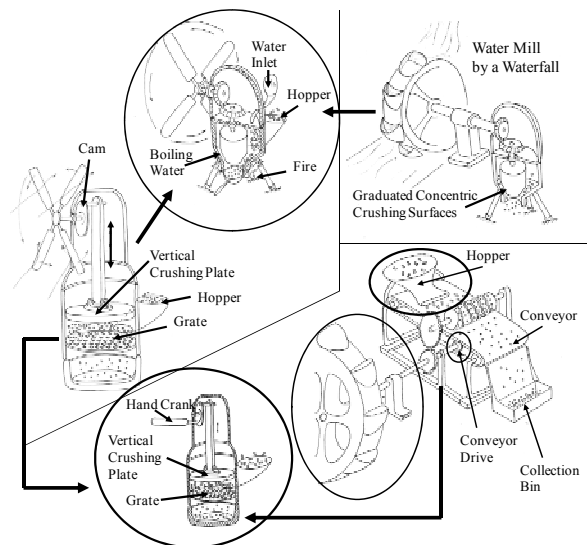

Fig. 3. Set of examples which were briefly and accidentally shown in class to the nominal group participants

4 Metrics

For the nominal group data, only quantity and quality were measured since only these two metrics showed few differences between the idea generation methods. The same process as before was used (Linsey, et al., accepted). A new evaluator scored the quantity and quality data for the nominal groups. Prior to scoring the nominal groups, the evaluator was trained on two teams' results and then two additional teams' were scored by the evaluator to determine inter-rater agreement. Inter-rater agreement for quantity was 92% with a Pearson's correlation of 0.91. This indicates there is strong agreement between the two evaluators.

5 Results and Discussion

Interacting groups with appropriate idea generation methods can be more effective than nominal groups. The results show that real teams in rotational conditions develop a larger number of ideas than equivalent nominal groups (Figure 4). This result is consistent with the theory that one of the reasons for the observed productivity losses in real interacting groups as compared to nominal groups is due to production blocking (Mullen, et al., 1991; Nijstad and Stroebe, 1999). Production blocking occurs is when one team member is talking (producing ideas) and other team members are listening. This causes them not to produce ideas. This result is also consistent with other hypothesized reasons for the productivity loss including performance matching (individuals see how much their teammates are producing and adjust their productivity to match), and evaluation apprehension (Mullen, et al., 1991; Nijstad and Stroebe, 1999).

A clear interaction effect is observed in Figure 5 through the non-parallel lines. An ANOVA shows that there is a statistical interaction between the viewing condition and the representation meaning that both are statistically important and the effect of the viewing condition depends on what representation is used [Viewing Condition: $F(1,48)=2.2$, $p=0.15$, Representation: $F(2,48)=26.3$, $p<0.001$, Interaction: $F(2,48)=9.0$ $p<0.01$ and $MS_{Error}=30.7$]. The representation implemented does not affect the nominal groups (individual idea generation), but has a substantial impact for the real groups. In real groups, the representation effects the communication between group members, whereas with individuals, the representation mainly serves to externalize internal ideas.

The statistical analysis in this paper does not include data from any of the sketches only conditions

because the prior study (Linsey, et al., accepted) indicates that the results from sketches only conditions are likely significantly affected by the fact that US mechanical engineers are typically not taught to free-hand draw. So only the data from Words Only and Word & Sketches is analyzed and compared.

To maximize the number of ideas a team generates, a team should use annotated sketches to communicate their ideas. A hybrid 6-3-5/C-Sketch method that includes rotational viewing should be implemented. For an individual working alone, it does not matter what representations is used.

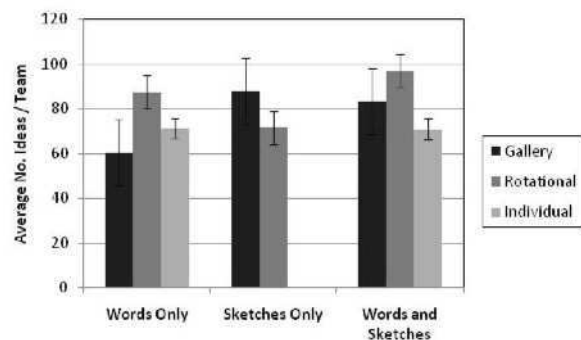

Fig. 4. Average number of ideas per team. Error bars are +/- one standard error

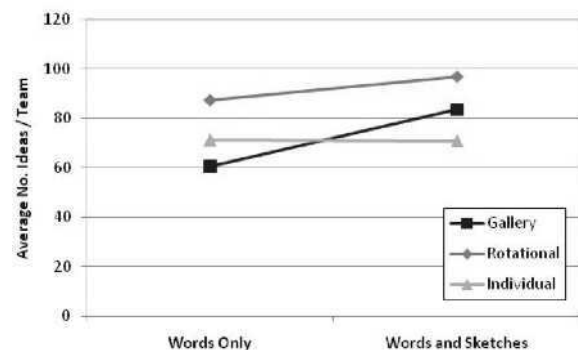

Fig. 5. Interaction effects between words only and words & sketches representations and the viewing condition

5.1 Quality

The representation has no effect on quality (Figure 6) or the distribution of quality (Figure 7) for the individual idea generation (nominal groups). This is not particularly surprising since the individuals are not communicating their ideas to anyone else and the quality scale is rather coarse. If the quality scale were finer, it might indicate differences between the representations.

The various conditions do have some effect on the quality of the ideas generated and the quality distribution (Figure 6 - 8). The prior study (Linsey, et al., accepted) did indicate that sketches only conditions tended to produce both higher quality ideas on average and fewer low quality ideas (Figure 6 and Figure 7), but this was likely due to the fact that many low quality ideas like “chemically removing the peanut shell” or “genetically engineering a peanut without a shell” are difficult to draw and therefore would have not been included by the participants.

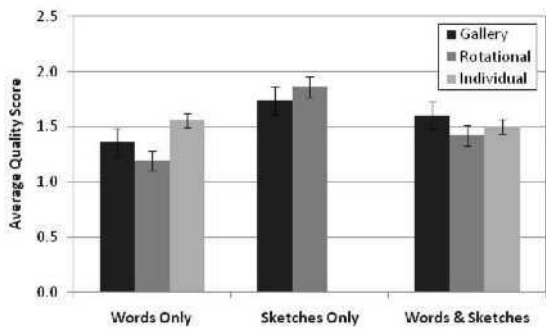

Fig. 6. Quality results. Each error bar is +/- one standard error

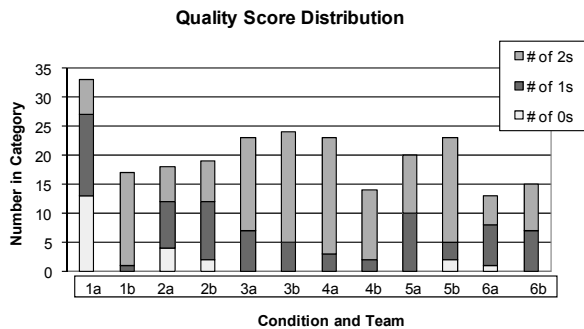

Fig. 7. Distribution of team quality scores (Quality Scores 1=technically feasible, 2=feasible for the context)

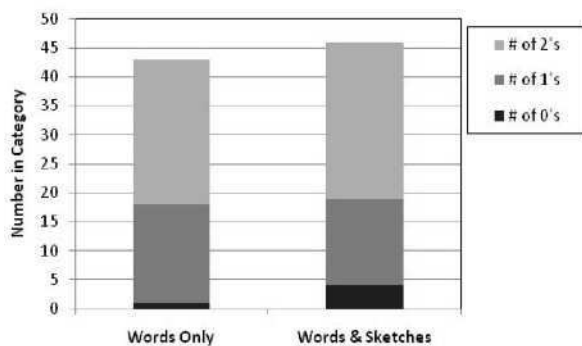

Fig. 8. Quality score distribution for individual idea generation (combined to form nominal groups)

The quality results indicate that words only should not be used for a large number of quality ideas in a team setting. The viewing condition (gallery verse rotational) had little effect on the average quality or the distribution.

These results indicate that when teams implement an effective method for idea generation, they can outperform the combined results of individuals (nominal groups). This result is in contrasted to results from Osborn’s Brainstorming method where nominal groups generally outperform real teams (Mullen, et al., 1991).

6 Conclusions

Brainwriting techniques that include a combination of sketches with annotations, such C-Sketch or Gallery, can assist a team in creating more ideas than the combined efforts of the same number of individuals working alone with redundant ideas removed, referred to as “nominal groups”. In contrast to this, prior experimental results from other studies on Osborn’s Brainstorming show that interacting groups are less effective than nominal groups. These results indicate that designers should carefully select their group idea generation approach in order to obtain a successful process.

To maximize the impact of a group idea generation, teams should sketch their ideas and add annotations to enhance interpretation. Methods where individuals can all simultaneously work as opposed to methods where one person speaks at a time (e.g. Osborn’s Brainstorming), will produce a greater number of ideas. A hybrid 6-2-5/C-Sketch method, where teams sketch adding annotations and then rotate ideas, is best for group idea generation.

This study compared nominal groups to real groups using techniques very similar to 6-3-5, C-Sketch and Gallery. Nominal groups were compared to real groups in a 3X3 factorial experiment. The first factor was how the teams represented their ideas (words only, sketches only or words & sketches) and the second factor controlled how ideas were exchanged (rotational viewing, gallery style, or no exchange-nominal groups). This factorial design leads to teams generating ideas in conditions very similar to 6-3-5, C-Sketch and Gallery. It was found that real teams using rotational viewing (e.g., 6-3-5, C-Sketch) created a greater number of ideas as compared to nominal groups. In contrast to this, real teams using gallery viewing produced significantly fewer ideas than the nominal groups.

References

- Adams JL, (1986) *Conceptual Blockbusting*. Cambridge, MA: Perseus Books
- Aiken M, Vanjani M, Paolillo J, (1996) A comparison of two electronic idea generation techniques. *Information & Management* 30: 91–99
- Baxter M, (1995), *Product Design: A practical guide to systematic methods of new product development*. London: Chapman & Hall
- Gryskiewicz SS, (1988) Trial by Fire in an Industrial Setting: A Practical Evaluation of Three Creative Problem-Solving Techniques. In *Innovation: A Cross-Disciplinary Perspective*, (Gronhaug K, Kaufmann G, Eds.), 205–232. Oslo: Norwegian University Press
- Higgins JM, (1994) *101 Creative Problem Solving Techniques*. Winter Park, FL: The New Management Publishing Company
- Lewis AC, Sadosky TL, Connolly T, (1975) Effectiveness of Group Brainstorming in Engineering Problem Solving. *IEEE Transactions on Engineering Management* EM-22:119–124
- Linsey JS, Clauss EF, Kurtoglu T, Murphy JT, Wood KL, Markman AB, (accepted) An experimental study of group idea generation techniques: Understanding the roles of idea representation and viewing methods. *ASME Journal of Mechanical Design*
- Mullen B, Johnson C, Salas E, (1991) Productivity Loss in Brainstorming Groups: A Meta-Analytic Integration. *Basic and Applied Social Psychology* 12:3–23
- Nijstad BA, Stroebe W, (1999) Persistence of brainstorming groups: How do people know when to stop? *Journal of Experimental Social Psychology* 35(2):165–185
- Otto K, Wood K, (2001) *Product Design: Techniques in Reverse Engineering and New Product Development*. Upper Saddle River, NJ: Prentice Hall
- Pahl G, Beitz W, (1996) *Engineering Design – A Systematic Approach*. New York: Springer
- Paulus PB, Yang HC, (2000) Idea Generation in Groups: A Basis for Creativity in Organizations. *Organizational Behavior and Human Decision Processes* 82:76–87
- Shah JJ, (1998) Experimental Investigation of Progressive Idea Generation Techniques in Engineering Design. DETC'98, 1998 ASME Design Engineering Technical Conferences, Atlanta, GA
- Shah JJ, Kulkarni SV, Vargas-Hernández N, (2000) Evaluation of Idea Generation Methods for Conceptual Design: Effectiveness Metrics and Design of Experiments. *Transactions of the ASME Journal of Mechanical Design* 122:377–384
- Shah JJ, Smith SM, Vargas-Hernandez N, (2003) Metrics for measuring ideation effectiveness. *Design Studies* 24:111–134
- Shah JJ, Vargas-Hernández N, Summers JS, Kulkarni S, (2001) Collaborative Sketching (C-Sketch) – An Idea Generation Technique for Engineering Design. *Journal of Creative Behavior* 35:168–198
- Van der Lugt R., (2002) Brainsketching and how it differs from brainstorming. *Creativity and Innovation Management* 11:43–54
- VanGundy AB, (1988) *Techniques of Structured Problem Solving*. New York: Van Nostrand Reinhold Company
- Vidal R, Mulet E, Gómez-Senent E, (2004) Effectiveness of the Means of Expression in Creative Problem-Solving in Design Groups. *Journal of Engineering Design* 15:285–298

Methods and Tools for Design Creativity

Front End Industrial Design (FE-ID) - Developing New Tools and Models for Industrial Designers to Operate at the Front End of New Product Development

Paul W. Wormald

Virtuality – Offering Opportunities for Creativity?

Anthony Williams, Ning Gu and Hedda Haugen Askland

Thinking Inside the Box: Model, Tool, Team and Setting for Building Design

Wim Zeiler

Signs of Collaborative Ideation and the Hybrid Ideation Space

Tomás Dorta, Annemarie Lesage, Edgar Pérez and J.M. Christian Bastien

Front End Industrial Design (FE-ID) - Developing New Tools and Models for Industrial Designers to Operate at the Front End of New Product Development

Paul W. Wormald
National University of Singapore, Singapore

Abstract. The front end of new product development is often a focus for discussion about innovation. This paper presents a new model for how the role and place of industrial design can be re-positioned so that it has influence and impact at this front end. The aim of this is to develop the capability for industrial designers to generate creative ideas, or opportunities, that have resonance and relevance within the context of new product development, but that are made explicit before a design brief exists. A front end industrial design process model, developed for undergraduate designers and evaluated by industry, is described in detail.

Keywords: industrial design, ideas, new product development, front end innovation, undergraduate design education

1 Introduction

Design creativity should be about ideas as well as beautiful artefacts. Ideas, as well as designed outcomes, need to be 'beautiful'. So a debate surrounding design creativity can include some discussion about ideas. Beautiful ideas which are successfully resolved into products are often judged as attractive product innovation. Creative product innovation is a highly prized goal for most commercial enterprises. Von Stamm (2003 p2) states ... *"One of the big concerns for many companies is ... how to generate more and better ideas - how to become more creative."*

This paper describes an approach which aims to develop and enhance creative ideas by moving the influence and impact industrial design has on new product development (NPD) to *before*, as well as after, a design brief is written. This, and the desire to have those ideas rooted in evidence and sound process, requires new knowledge and abilities, and new modes of working, including new tools and designerly outputs.

What has emerged, mainly from industrial design education curriculum development, is a overall process

model which could be adopted in a re-think of how industrial design can better contribute to successful NPD (in commercial and other enterprise arenas). This process model has been refined over half a decade of university-level design education. It has been reviewed by large international companies, design consultancies and design research companies.

The aims of this paper are:

- To reveal and illustrate a process through which industrial designers can successfully impact on the front end of NPD, partly by generating creative and targeted ideas.
- To contribute and stimulate some debate and discussion concerning the future role of industrial design in NPD.

2 The Front End of NPD

Figure 1 shows a basic diagram of commercial NPD.

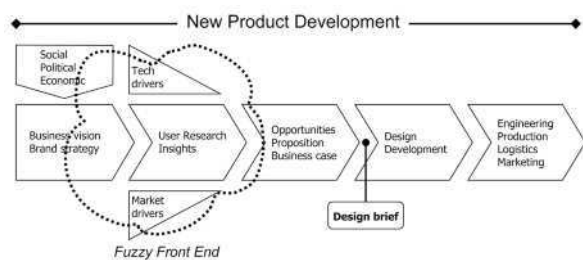

Fig. 1. NPD diagram

The diagram identifies various stages and activities. Obviously, this diagram is not to scale in the sense of time. It shows that design (industrial, engineering etc.) typically starts after a brief is formulated. Its major feature is the (pre-brief) area before a formal design brief emerges.

It is well known that companies will attempt to utilise methods and approaches to enable successful innovation in the development of new products. The

methods and approaches used very early on in the new product development process are often referred to a 'front-end' processes (Koen 2002 and Cagan and Vogel 2001). They can include such activities as user/customer research, brand management, trend surveys, and market analysis. Additionally, these methods and approaches are often seen as being less strict, rigorous or even less well understood than some of the 'downstream' processes such as product design, manufacturing engineering, and product certification. Hence, this front end of NPD is sometimes referred to as the 'fuzzy front end' (FFE).

With regard to industrial design activity in the early NPD processes then Veryzer (2005) and Jurotovac (2005) demonstrate how industrial designers make successful contributions to the overall process. There has been limited pedagogic research into the issue of how industrial design education can exploit these new areas of opportunity. Design students pursuing user research activities early in project work is discussed by Siu (2003, 2007), Lopes (2008) and Lofthouse (2008). They all point to the potential benefits of enhanced innovation and designer empathy with users.

Some of the background issues concerning FFE thinking are covered by Wormald (2009). He provides a full background to this paper, particularly the drivers for change which provided the impetus for industrial design educational curriculum development.

3 A Process Model for Front End Industrial Design (FE-ID)

Figure 2 shows a process model for the front end of NPD activities undertaken by industrial designers, hence the term front end industrial design (FE-ID).

It is important to note that this model has been formulated following six annual cycles of pedagogic action research. This action research was instigated to investigate and support changes to the author's curriculum development in the subject of industrial design at a UK university.

The diagram is a more detailed view of how the role of industrial design can be modelled during that, notoriously 'fuzzy' period. The diagram has been formulated to clarify and visualise the various stages and outputs of the front end investigation and synthesis processes.

The following sections describe each of the major processes, with associated tools and output models. Examples of work completed by industrial design undergraduates are presented. Each stage or step in the process can be broken down into sub-areas for subsequent analysis and possible synthesis. The generated outcomes can lead to further stages and further subsequent analysis.

The process begins with a review, or revealing, of various contextual issues. Within the broad, fuzzy, arena of very early new product thinking there will be

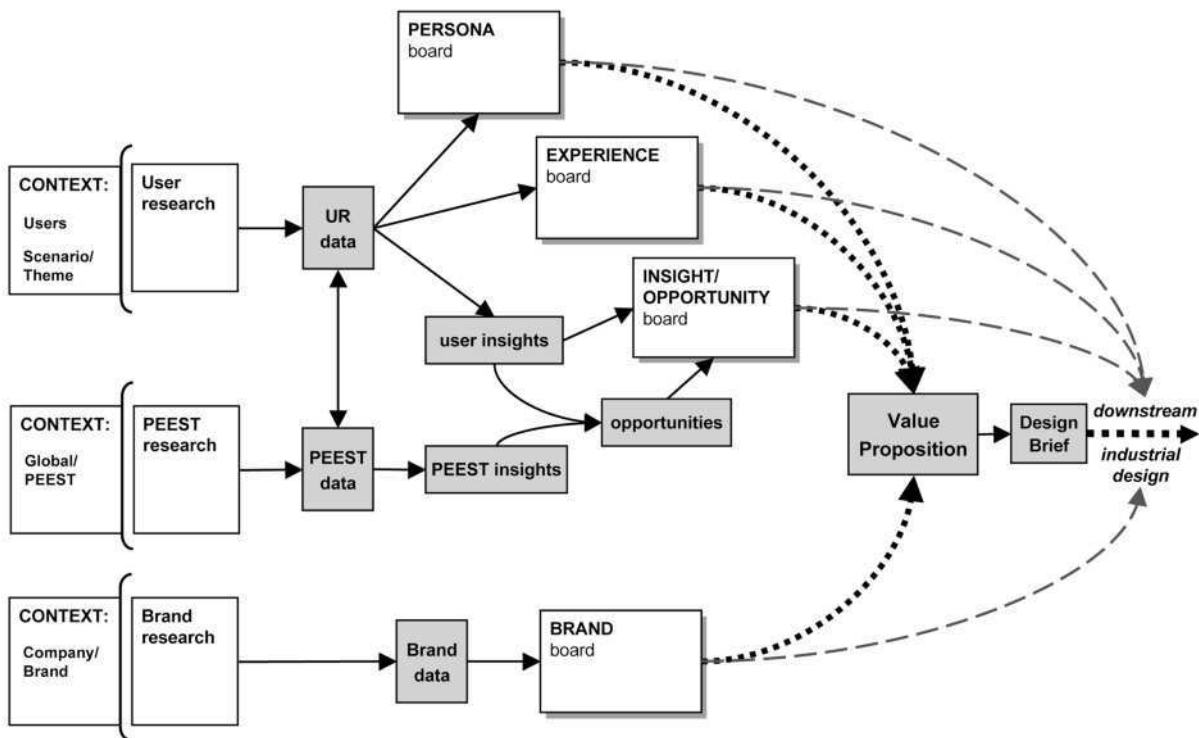

Fig. 2. FE-ID process diagram

a multitude of influences and pressures. These are indicated in the NPD diagram (fig 1).

There is, of course, no sense of what the nature of a new product will be. There is no 'big idea', there is no design brief, there is only a sense, or urge, that a new product is necessary. The contextual issues are stated as clearly as possible, but with enough flexibility to allow for exploration and wide-ranging relevant research.

Four context areas are identified:

- User/consumer
- Scenario/theme
- Global/PEEST
- Company/brand

For 'user/consumer' a target user group is outlined. This usually entails identifying simple demographic information such as age range, gender, and occupation. For 'scenario/theme' some broad user activity or behaviour is outlined. This would have relevance to the target user group and the company/brand. Examples could be 'cooking', 'keeping fit', or 'local travel'. PEEST stands for Political, Economic, Environmental, Social, Technology. There will be a 'global/PEEST' context to be investigated, especially relating to the overall theme being explored. Each of the Political, Economic .. etc. areas can be reviewed for possible insights. Finally, the company and its relevant brand is a necessary component of any sound NPD thinking.

Following the above basic clarification, the context areas can be researched. This research can be conducted independently, in parallel, by a team of design researchers. Investigation can be overlapping and related, but it is best to be able to have a view of the separate areas initially. The different contexts will be researched using different methods and strategies. Different types and forms of data will be gathered.

Possible research methods used and types of data gathered for each context area are identified below.

Context - user/consumer

- Data gathering activities:
 - Ethnographic observation
 - Interviews, questioning
 - Conversation, chatting
 - Photography, video
- Types of data gathered:
 - User stories
 - Detailed demographic information
 - Photos of people and environments
 - User attitudes and emotions
 - User quotes
 - Observational texts

Context - scenario/theme

- Data gathering activities:
 - Observation
 - User interviews
 - Photography, video
 - Internet searching
- Types of data collected:
 - Photo essays of behaviour
 - User stories of scenario experiences
 - Observational texts
 - Comment and opinion on theme

Context - global/PEEST

- Data gathering activities:
 - Internet searches
 - Newspaper, trade magazine reading
 - Media analysis
- Types of data collected:
 - News snippets/articles
 - Technical briefing notes
 - Cultural references (photos, notes)

Context - company/brand

- Data gathering activities:
 - Analysis of company publications and websites
 - Discussion with company management
 - Identification and analysis of competitor products/brands
 - Consumer interviewing
- Types of data collected:
 - Product (company and competition) imagery
 - Company financial and market information
 - Brand values
 - Forms of brand manifestations

As data gathering progresses the process of attempting to make sense of it all begins. As meaning and sense develops for the design researchers, increased understanding of the context areas will drive new avenues of investigation in an iterative way. The design researchers will aim to synthesise specific areas of 'meaning' from the various data sources. Arising from the context areas these areas of meaning include:

- User goals;
- User lifestyle;
- Insights into user behaviour;
- The experience of the user relating to the scenario/theme;
- Relevant PEEST insights;
- Company market position - and subsequent insights;

- Brand territory;
- Illustration of brand values - characteristics.

In this work, an insight can be the answer to the question ... "What do we now understand from the evidence, that we did not know before?" Insights are highly valued and valuable 'nuggets' of information that relate strongly to the overall contextual issues.

For the industrial designer an important part of the process of making sense of the data takes the form of communicating its meaning in particular and specialised forms, namely 2D boards (printed or digital) containing rich visual and textual information. The industrial designer uses standard graphical techniques to present meaning and understanding in easily accessible and engaging forms. In the FE-ID process (fig 2), these are identified as BRAND, PERSONA, and EXPERIENCE. These are separate boards, and a more detailed explanation of each, with examples, follows.

BRAND

The aim of this board is to 'bring the brand to life'. It should reveal the brand territory (the metaphorical ground the company's brand occupies in the market). It should illuminate the underlying meaning of the brand values. It should successfully explain and illustrate any of the brand messages (such as taglines and jargon used in advertising and marketing). The content of the BRAND board would typically include:

- Company name;
- Brand name;
- Brand visuals (such as logotype, product visual language);
- Iconic products of the brand
- Analogous, comparative products / brands / competitors;
- Explanatory texts.



Fig. 3. Example of BRAND board

PERSONA

The aim of this board is to 'bring the user to life'. A persona is a standard, accepted way of defining and visualising the target user group. It is often used in marketing activities, and software design (Cooper 1999), and product design (Pruitt and Adlin 2006). There may be several personas for each project. The content of each the PERSONA board would typically include:

- Photograph of a person (with 'character');
- Name;
- Categorisation (a form of 'micro' description);
- Basic demographic facts (such as age, occupation, location);
- Lifestyle information (pictures and text), to paint a picture of the character;
- Goals, needs or expectations which are specific to the scenario/theme;
- A short narrative, telling a story relevant to the user and theme.

It is important to note that the details above are highly credible, but are actually fictional. This is partly for ethical reasons.

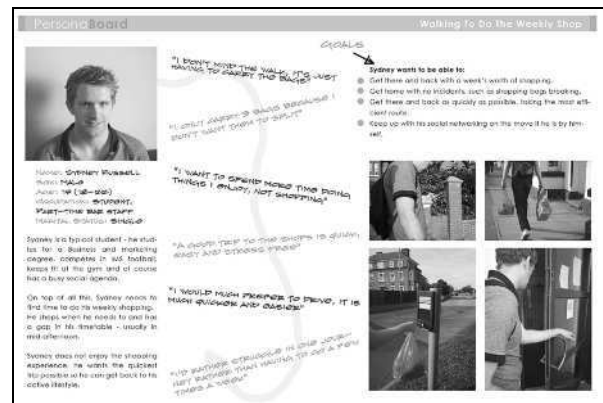

Fig. 4. Example of PERSONA board

EXPERIENCE

The aim of this board it to 'bring the user experience (of a specific scenario/theme) to life'. The emphasis on this board is to reveal the actual behaviour of users, not simply to report what the users say that they do. Stappers and Sleeswijk (2007) describe an approach they call "Context Mapping" which aims to reveal similar issues surrounding user experience. The content of the EXPERIENCE board would typically include:

- Photos of users in relevant environments and situations;
- Photos of users actually doing tasks, jobs, activities;

- Researcher statements commenting on observed behaviour;
- Snippets of user stories or quotes, to illustrate attitude or emotion;
- Statements of insights into user behaviour or attitude;
- Provocative, unexpected points - not the obvious!

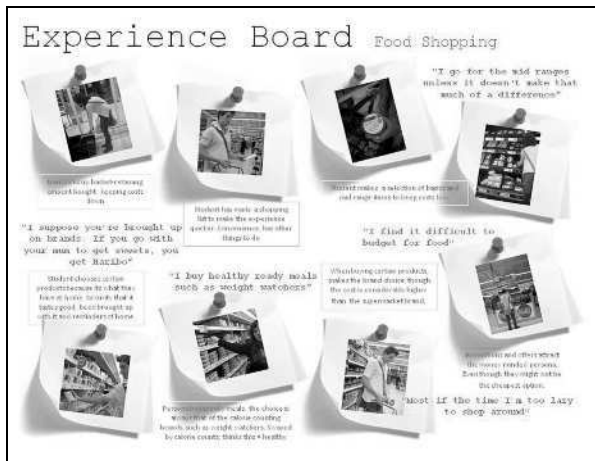

Fig. 5. Example of EXPERIENCE board

In the FE-ID process, making sense of the data/evidence, as revealed in the above boards, continues by exploring ways that this understanding of meaning can be exploited to benefit the user/consumer and company/brand. This is all about generating relevant opportunities, or creative ideas. The route from insights to opportunities is structured with detailed analysis and probing of the research evidence. This is an expansive process, where as many ideas as possible, rooted in evidence from users, the brand, PEEST insights, the scenario and the company are aired. Multiple opportunities or ideas are refined, tested and cross-referenced against different sources of data. The aim is to retain high levels of creativity and innovation in the 'idea' whilst being able to support it with a defensible body of evidence. It is useful to note that the opportunities that are identified are rarely anything that has been explicitly requested by users. Of course a user might recognise the value of an idea, but would not have been able to generate or articulate it themselves. The insights and opportunities are communicated in an additional board of images and text - the INSIGHT/OPPORTUNITY board.

INSIGHT/OPPORTUNITY

The aim of this board is to communicate the value, or worth, of the research. It must enlighten, persuade and inspire. This is where the research pays off in terms of creative ideas. The content of the

INSIGHT/OPPORTUNITY board would typically include:

- Multiple insights (mostly from the user/experience, but also global/PEEST);
- Snippets of relevant research evidence (pictures, quotes) which support each insight;
- Opportunities (typically idea statements), arising from each, or groups, of insights.

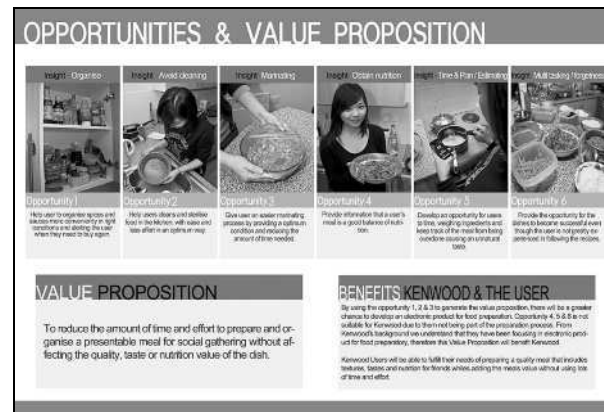

Fig. 6. Example of INSIGHT/OPPORTUNITY board

A next step in the process is the formulation of a value proposition statement. In essence this is about identifying the 'best' idea from all the generated ideas. The value proposition arises from consideration of how the benefits on offer from the opportunities connects with the user's goals (in the context of the theme), and also how the opportunity has resonance with the company and brand. One test for the value proposition is that it encapsulates a range of benefits which must be highly attractive to both the target market (as represented by the PERSONA) and to the company and brand (as seen in the BRAND board). The previously created outputs of the BRAND, PERSONA and EXPERIENCE boards play a critical part in arriving at a high quality value proposition. Their easily accessible format of presentation of evidence should enable relevant and rapid judgements, and evaluation of potential opportunities.

In some manifestations of the FE-ID process the INSIGHT/OPPORTUNITY board would also contain the final value proposition statement.

The value proposition should lead directly onto a design brief statement. Often it is a matter of re-phrasing a value proposition statement so that it can stand as an outline design brief. This is why the diagram in figure 2 shows the design brief directly after, and connected to, the value proposition.

4 Evaluation of the FE-ID Process

How is it known that the methods and tools in FE-ID can be effective to drive creative ideas and innovation in the area of NPD? Evaluation research has been conducted to attempt to address this question.

A significant proportion of the project work which has been behind the development of the FE-ID process has been conducted in collaboration with companies. The project work typically begins with a NPD 'challenge' set by each company. With most of the companies these 'challenges' have all been live, real-world issues, requiring in-depth research and creative outcomes. Design and marketing managers in the companies were involved in setting up each challenge. During, and following, each project these managers reviewed the FE-ID activities and the outcomes. The company managers were interviewed or invited to offer comments. The following presents some of those comments from each company.

KENWOOD (UK-based food preparation products company), in 2010: *"The sort of work seen is just what we would expect from designers during these stages of NPD."*

OSIM (Singapore-based international health/fitness products company), in 2009: *"We are happy with your process during research phase, understanding OSIM's vision, business focus, products and competitors; and carrying out interviews, identifying personas and drafting the design brief."*

ORANGE (European mobile communications company), in 2008: *"... are interested in the outcomes of the research before seeing any of the designed products ..."*

MARS UK (international food and confectionary products company), in 2007: *"The proposition opens up a new market for chocolate and an engaging experience." "A good example of disruptive thinking used to create a new market opportunity."*

DIAGEO (UK-based beverage company with leading drinks brands), in 2006: *"The process of generating insight-propositions is exactly the sort of process we go through and want to see. ... We would pay agencies a lot of money for the work you have been doing and they would struggle to get into the depth that you have."*

McCAIN (global food products company), in 2005: *"... we would like the work to remain confidential ... the concepts are still working progress here at McCain and ... NPD is a very sensitive area."*

The discussions with these companies provided support and reassurance that the FE-ID processes and activities are appropriate and would fit in well with how they operate in their individual companies.

5 Discussion

There are various points of discussion arising from the revealing of the FE-ID process.

It is realised that, once presented with a design brief, industrial designers have for many years utilised research and investigation strategies such as user research, and brand understanding to improve the qualities of their 'problem-solving' activities. However, how can you go about solving problems when you don't know that the problem being tackled is worthy of being solved? For a designer the equivalent question is 'why design something that doesn't need to be designed?' The FE-ID process has an important role in finding a 'good' problem, appropriate to the contextual situations. To put it another way, its role can be said to be about *'finding the right product to be designed, before designing that product right.'*

A question may be posed that asks *"why should industrial designers have any place or usefulness before a design brief?"* Part of the answer is that industrial designers seem to have a mind-set which is very well suited to the ill-defined, fuzzy front end of NPD. They are well suited to asking questions and proposing possible futures. They are also very good at communicating their design and research thinking in novel models which are engaging and easily understandable. It is also well known that the earlier in the NPD process that sound design decisions are made then the better the longer term outcomes for the ultimate product are. The FE-ID process enables those early decisions to be made, and hopefully with increased confidence of soundness. It also ensures a better transition from pre-brief to post-brief - as the same industrial design team can be employed. Additionally, more consistent and more engaging modes of communication of research work can also help to smooth this transition.

The FE-ID processes do not guarantee successful creativity or innovation. However, they do seem to give it a chance to flourish and develop. The complexity and fuzziness of this arena has been given some clarity by providing a structure, and stages which are more achievable. These stages can be built together to reach for an ideal of the highly creative, but focussed, idea (for products). The outputs aid discussion and debate, they inspire and enthuse, they are deliberately accessible and engaging, and they provide evidence to base decisions upon. One of the underlying strengths of the FE-ID process is that creative ideas emerge out of evidence, in a structured, controlled and repeatable manner. It is not an approach that relies on some mysterious 'black art'. It does need hard work and open, enquiring minds - but at least it can reward that effort and ability.

There are small procedural tools for taking the steps between data and insights, between insights and opportunities, between a range of opportunities and a value proposition, and also between a value proposition and a design brief statement. The arrows in the FE-ID diagram (fig 2) represent some of these steps. The overall success of the FE-ID process relies on how these procedures are engaged with and applied.

As well as being the stimulus for targeted creative ideas, the outputs of BRAND, PERSONA, and EXPERIENCE material have an intrinsic value in their own right. The evaluation research conducted with companies and consultancies indicate that they have monetary value, i.e. companies would happily pay the design researchers for these outcomes. Additionally, the boards of material can play an important part in the stimulus of design work, downstream of a design brief. It is well known that personas are used in certain areas of product design. The brand and experience material can further guide and inspire traditional industrial design activities. This added value for the outputs of the FE-ID process are indicated in the diagram in figure 2. The research thinking and in-depth understanding of issues such as company, brand, user goals and emotions are also very powerful when early product concepts begin to crystallise and be further developed.

There are modes of working which appear to be successful when operating at the 'fuzzy' front end of NPD. Insights are always being sought. This is about trying to make sense, to understand, the observational data from activities such as ethnographic work with users. There is constant questioning, seeking answers but even better is to be able to ask even more in-depth further questions. Once some understanding has been attained it has to be exploited in a manner which may offer opportunity. This is a process of synthesis. Along the journey through this research, deconstruction, questioning, synthesis etc. there are stages which need reflection and explanation. There is knowledge and understanding that must be formulated into digestible, separated forms. This is the reason for modelling this knowledge into forms such as 'persona', 'experience', 'insights & opportunities' and 'brand'.

It has been realised that there are useful associations between the modes of working and the types of output during the FE-ID processes when compared with the latter downstream industrial design processes. Downstream of the brief there is further questioning, expansion of information, re-formation and synthesis of data, generation of product form and function. There are also associated outcomes or models which are familiar to industrial designers, such as product presentation boards, sketch work, mood boards etc. This gives some sense of confirmation that

the industrial designer has the potential to be well suited to the FE-ID ways of working.

The FE-ID process is supportive of both expansive idea generation, and evaluative idea sorting and judgement. This is a significant strength, as ideas which emerge have the potential to be both innovative and credible to the target users and the company/brand.

This paper has referred to the commercial world of industrial companies and their products as the background to the work. It should be recognised that the processes of identifying a successful value proposition can have significant value to all organisations, not just the archetypal industrial manufacturing company. Charities, retail, financial services, local government, overseas aid organisations, and health services are examples of other forms of enterprises that could benefit from the FE-ID processes.

6 Conclusions

A number of conclusions are arrived at from the work described in this paper:

- There is a potentially exciting and valuable new arena for industrial design to exert influence and have impact, at the front end of new product development - before the design brief.
- A new process model of front end industrial design (FE-ID) has been developed which presents new tools and models of activity and output.
- The FE-ID process can be used to generate highly targeted creative ideas that can lead to innovative product solutions.
- The FE-ID process has worked successfully in the context of a premier undergraduate industrial design education programme, and its processes and outcomes have been strongly supported by commercial companies whose business is concerned with applied innovation.

The FE-ID model has been presented to stimulate discussion and debate about the issue of industrial design's potential influence in the area of front end innovation. The author believes that industrial designers have much to offer, and educating new generations of designers in these new opportunities can be an effective way of developing change in the commercial world.

It is acknowledged that it is speculative to generalise the FE-ID model too widely. It needs more research to establish its worth in a wider industrial

design world of work and education. The author welcomes correspondence and potential collaborators to further this aim.

7 Acknowledgements

The author would like to acknowledge the contribution made to the work described in this paper by Mr Michael Rodber.

References

- Cagan J, Vogel CM, (2001) *Creating Breakthrough Products: Innovation from Product Planning to Program Approval*. Upper Saddle River, New Jersey: Prentice Hall
- Cooper A, (1999) *The Inmates Are Running the Asylum*. Indianapolis: Sams
- Juratovac J, (2005) *Building a Bridge to the End User: How Industrial Designers Contribute to New Product Development*. In Khan KB (Ed.) *The PDMA Handbook of New Product Development* (2nd Edition), 389–405, New York: Wiley
- Koen PA, Ajamian G, Boyce S, Clamen A, Fisher E, Fountoulakis S, Johnson A, Puri P, Seibert R, (2002) *Fuzzy-Front End: Effective Methods, Tools and Techniques*. In Belliveau P, Griffen A, Sorermeyer S (Eds.) *The PDMA Toolbook for New Product Development*, 2–35, New York: John Wiley & Sons
- Lofthouse V, (2008) *Discrete Observation as a Method of Identifying Real Design Needs*. In *New Perspectives in Design Education 10th International Conference on Engineering & Product Design Education*, Barcelona, September 2008, 180–185, Institution of Engineering Designers and The Design Society
- Lopes AM, (2008) *Designed Inquiry: The Significance of Research Education for Industrial Designers*. In *New Perspectives in Design Education 10th International Conference on Engineering & Product Design Education*, Barcelona, September 2008, 132–137, Institution of Engineering Designers and The Design Society
- Pruitt J, Adlin T, (2006) *The Persona Lifecycle: Keeping People in Mind Throughout Product Design*. London: Morgan Kaufmann
- Siu KWM, (2003) *Nurturing All-Round Engineering and Product Designers*. *International Journal of Technology and Design Education* 13:243–254
- Siu KWM, (2007) *Guerrilla Wars in Everyday Public Spaces: Reflections and Inspirations for Designers*. *International Journal of Design* 1(1):37–56
- Stappers PJ, and Sleeswijk F, (2007) *Bringing Participatory Techniques to Industrial Design Engineers*. In *Shaping the Future? 9th International Conference on Engineering & Product Design Education*, Newcastle Upon Tyne, September 2007, 117–122, Institution of Engineering Designers and The Design Society
- von Stamm B, (2003) *Managing Innovation, Design and Creativity*. p2. London: John Wiley & Sons
- Wormald PW, (2009) *The pedagogy of pre-brief activities for industrial design undergraduates operating at the 'fuzzy front end' of new product development*. In *Proceedings of ICED'09, Design Education and Lifelong Learning*, 10:81–86, The Design Society

Virtuality – Offering Opportunities for Creativity?

Anthony Williams, Ning Gu and Hedda Haugen Askland
The University of Newcastle, Australia

Abstract. This paper considers how 3D virtual worlds (3DVW) represent constructivist learning environments and how this technology may be used to support creativity in design education. It presents an example of how 3DVW can be used in formal design education as a mean for teaching spatial design and considers how 3DVW may foster and promote creative potential and give design students first-hand experiences of engaging in creative design processes.

Keywords: 3D virtual worlds, design education, creativity, constructivist learning

1 Introduction

Over the past 30 years there has been a rapid expansion of virtual reality technologies. The term ‘virtual worlds’ refers to a genre of online communities, often computer-based simulated environments, within which individuals can interact with others, create objects and engage in a range of activities, such as shopping, entertainment and education. 3D Virtual Worlds (3DVW) represent the latest development of such technologies. It is distinguished from other networked technologies by having place characteristics; it is not simply a communication tool but an actual (though virtual) location within which individuals can act through their alter egos (avatars) (Kalay and Marks, 2001).

Virtual worlds have become an important extension to our environment. For designers they represent an alternative milieu in which design can be generated, explored and assessed; virtual worlds represent opportunities for remote collaboration, interaction and engagement, and, as such, possess an alternative approach to design to that of the real world.

The possibilities embedded in virtual worlds have been recognised by architecture and design schools around the globe and it has been acknowledged that these technologies entail new challenges and opportunities for design education. This paper considers how 3DVW, when employed as a constructivist learning environment, may influence the teaching and learning of creativity and foster students’

creative abilities. The paper is divided into two main parts. The first section outlines the phenomenon of 3DVW and discusses 3DVW in relation to constructivist theories of learning. It provides an example of how it may be used in the context of formal design education by presenting the case of the undergraduate design course, “NU Genesis”, which focused on designing spaces in 3DVW. Drawing on the authors’ experiences of teaching this course and reflecting on the particular skills and processes that are involved when designing and learning in 3DVW, the second section of the paper explores how 3DVW may be supportive of creative thinking and foster design students’ creative abilities.

2 3DVW as a Pedagogical Tool

Computer technologies have created new ways of designing that require particular digital skills and that represent alternative approaches to the design process. The increased role of digital technology in design means that higher education design curricula should include pedagogical approaches that employ these media, that develop the necessary skills (craft) to successfully use and work within these technologies, and that give students the experience of working with such technologies and applying design thinking (art) within these media (Kvan et al. 2004). Traditional design disciplines, such as architectural design, have developed a range of educational approaches that integrate digital design into the teaching practices. This includes approaches that employ parametric design, interaction design, experiential design and collaborative design. However, though these approaches integrate new technologies in the curriculum and give students first hand experiences of engaging with digital technology, the pedagogical potential of digital technology as a constructivist learning environment remains relatively unexplored.

2.1 Constructivism, design education and 3DVW

The notion of ‘constructivist learning environments’ can be traced back to the French psychologist Jean Piaget’s theory about children’s cognitive development. In short, Piaget (1977) argues that cognitive structures are developed through children’s active engagement and interaction within particular historical contexts, and future practice and acts of intelligence correspond with the individual’s adaptation to their socio-cultural environment. Children’s cognitive structures move from motoric actions, intuition and manipulation of concrete objects to more abstract reasoning. When they move into the last developmental stage, what Piaget (1977: 461) labels “formal operations”, children’s aptitude in abstract deduction evolves, additionally enabling the growth of a reflexive self-image (Piaget, 1977; Rapport and Overing, 2000: 30). According to the constructivist perspective, knowledge is obtained and understanding is expanded through the active (re)construction of mental frameworks (Abbott and Ryan, 1999). This argument positions learning as an active process, which involves deliberate progressive construction and deepening of meaning and emphasises the “competent, creative, mindful, collaborative and constructive dimensions” (Spady, 2001, cited in Gül, Gu and Williams, 2008: 580) of learning. Within the constructivist paradigm, knowledge is perceived as a process rather than a product. Thus, as cognitive psychologist Jerome Bruner (1966: 72) contends, students should be taught “to consider matters as an historian does, to take part in the process of knowledge-getting” and the focus should be on a strategy for teaching and learning that emphasises problem-based, or project-based, learning.¹

The very essence of architectural and design education is problem-based or project-based learning. Rather than seeking a single correct answer, the design disciplines encourage students to make speculative and exploratory propositions that reflect their competence and knowledge of a particular field (Williams, Ostwald and Askland, 2010). In 1985, Donald Woods of McMaster University proposed a pedagogical model that introduced the concept of problem-based learning to engineering design education. Woods’ approach was a form of experiential learning that focused on the integration of diverse knowledge and skills through a

problem-solving praxis aimed to meet the expectations of future employers. He emphasised the role of reflection as the mean to bring together skills, knowledge and practical experiences (Woods, 1985). In relation to virtual environments in design, the ideas of constructivism are represented in what has become known as “virtual design studios” (Kubicki et al., 2004). Virtual design studios emerged during the 1990s. They have been developed and deployed by architecture and design schools, primarily due to their advantage of collaboration beyond geographical and spatial restrictions. Virtual campuses have been established by using commercial 3DVW platforms such as Second Life (<http://www.secondlife.com>) and Active Worlds (<http://www.activeworlds.com>).

The use of virtual environments for teaching has been identified as having a positive influence on both teaching and learning. Kvan (2001), for example, argues that virtual design studios enhance students’ understanding of the design processes.² This argument is based upon the assumption that virtual design studios contain two main characteristics: deliberation and collaboration. Deliberation refers to the process whereby students are encouraged to reflect on their design and learning processes. It places the emphasis on the design process rather than the final design product. Collaboration, on the other hand, refers to 3DVW’s extension of the teaching context, which encourages participation of both the learners and teacher(s). This broadening of the learning/teaching space gives the students first hand experiences of designing with experienced designers, as well as with their peers.

When designing in a virtual environment, the processes of conceptualisation, representation and documentation are largely integrated. Unlike designing in a traditional environment where the conceptual development, representation and the final documentation are clearly separated, 3DVW enable designers to immerse within the virtual design, which is the only representation that progress throughout the different phases of the design process. This integrated process is enabled by the very nature of virtual environments being freed from traditional design

¹ The word “problem” is used in this context to refer to wide range of situations, some of which may be framed as opportunities, open-investigations, or as “wicked” or “ill-defined” settings.

² It should be noted that tracing the design process is problematic in some 3DVW. This is because many current platforms do not allow the recording and tracing of past design and collaborative activities. For the assessment of students’ designs and processes in 3DVW it is therefore important to ensure that alternative means for documenting the design process is taken. The question of assessing (virtual) creativity is beyond the scope of this paper and will not be explored further here.

boundaries and physical constraints. It underpins another positive influence of 3DVW on teaching and learning; namely the possibilities embedded in 3DVW for experimentation and “experimental learning” (Dede, 1995). Experimentation and experimental learning are learning strategies that have a long established position in design and that are supported by the constructivist paradigm. Further positive aspects of 3DVW related to teaching and learning design include their provision of spaces for “situated” learning (Dickey, 2005), their encouragement of collaboration and constructivism (Clark and Maher, 2005), and their potential to support social awareness (Prasolova-Førland, 2004) and to advance cross-cultural interactive skills and understandings (Wyeld et al., 2006).

The act of designing 3DVW represents in itself a pedagogical tool that crosses the fields of design and computing. Underpinned by the idea of 3DVW representing constructivist learning environments and the belief that 3DVW present significant potential for design teaching and learning beyond being another CAD tool for simulation and collaboration. The main aspects of the latest course are briefly outlined below.

2.2 Designing 3D Virtual Worlds³

This section describes the collaborative virtual design studio “NU Genesis”, which was conducted at the University of Newcastle in August 2008. The studio was a result of an on-going international collaboration between the University of Newcastle and Rangsit University, Bangkok. It used Second Life as its platform and established a virtual island as the site for designing and implementing students’ collaborative project.

NU Genesis was set up with two main objectives in mind; namely, exploring the possibility of virtual space design and creating a virtual studio in which students located at two geographically distinct campuses could design collaboratively. Rather than adopting a singular focus on the technical aspects of 3DVW and simply simulating physical spaces, the course explored the design potential of 3DVW by emphasising 3DVW as a design discipline in its own right. The course had three main aims for learning: firstly, it aimed at developing the students’ understanding of 3DVW as an emerging environment for spatial design; secondly, it aimed at enhancing

knowledge and giving students first-hand experiences in design and implementation of 3DVW; and, thirdly, it aimed to provide students with opportunities for exploring the use of 3DVW as constructivist learning platforms for design education.

In conjunction with the students’ exploration of the virtual world, they had to engage in a collaborative design project and attend weekly virtual design studios, which included a one-hour lecture/instruction session and a two-hour design/tutorial/discussion session. The collaborative design project, entitled “Virtual Home”, was a continuation of an exercise that the students had previously conducted in a traditional studio. The design brief asked the students to design and implement a place in Second Life, which demonstrated their concept of a virtual home and challenged the boundaries of the physical home developed in the traditional studio. This project was the main assessment item of the course. It provided opportunities for the students to: (1) develop and apply design principles of 3DVW; (2) master the knowledge and techniques for virtual world implementation; and (3) exercise individual design and group collaboration skills.

The collaborative design project required skills for designing 3DVW, including architecture-related skills (space design), digital design skills (modelling, imaging, video and audio production, scripting and programming), communication and collaboration skills, and generic problem-solving skills. The course was, ultimately, established as a shared environment for collaborative design disregarding the geographical differences of the students, and the particular approach taken facilitated dimensions such as metaphorical/virtual design, interactive design and experiential design, all of which are excluded in conventional use of 3DVW as a technical tool for architecture and design. As a design subject, the course was set to prepare future generations of designers for adoption of 3DVW as an alternative design environment. It provided opportunities for design exploration and manipulation, for interaction and dialogue between students and other 3DVW users, including the instructors and the virtual communities, and for active and interactive building of skills and knowledge in relation to their interests. As such, the course applied constructivist learning principles through which the students acquired design related knowledge and skills, including those related to spatial design, digital modelling and representation,

³ This course has been described in greater detail in [reference].

collaboration and communication, as well as generic problem solving.⁴

The designs that emerged from the studio demonstrated the potential of 3DVW as alternative means for exploring spatial design. Perceived design boundaries were challenged and transcended. For example, some students relinquished the largely passive nature of physical spaces by creating an active, indeed even proactive, virtual gallery that interacted with the visitors (Figure 1). The gallery would self-modify its design and arrange displays according to the presence of the visitors.

Physical constraints are important factors for design consideration in the built environments, though they often limit designers' imagination and prevent "risk taking" strategies, which are important for achievement of innovative design. The lack of physical constraints in 3DVW can act as a trigger for alternative solutions and challenge conventional design approaches and design thinking. Figure 2 is an illustration of the student project "zero gravity", in which the students designed a virtual home without attending to rules of gravity but still supporting various activities in 3DVW. The design uses non-gravity as the design trigger and has spaces hanging upside down within a sphere.

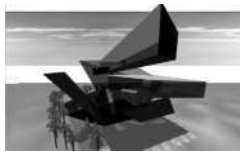

Fig. 1. An interactive virtual gallery

Designers often seek inspiration by making analogy to phenomenon and design examples outside the subject areas. The vast range of design examples and different technical features in 3DVW support students' design development in this regard. For example, in the student project "Archi-Bio", the students successfully demonstrated how they strategically used different features in 3DVW to develop the initial concept. It is evident that the studio encouraged students in exploring new and different approaches to spatial design. However, how did the studio foster the core design skill of creativity? In what follows we will attempt to answer this question through consideration of key issues emphasised in the literature of creativity?

⁴ An evaluation of the design features in 3DVW as they relate to virtual design studios is provided in Gül, Gu and Williams (2008).

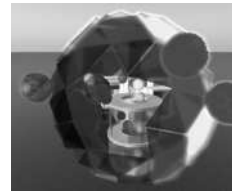

Fig. 2. A virtual home for "zero gravity"

From a scanned image of the bio-mechanism that first inspired their design (Figure 3, left) they developed abstract 3D spatial volumes that further assisted their conceptual development (Figure 3, middle). These spatial volumes were used for the development of the final detailed implementation of their virtual home (Figure 3, right).



Fig. 3. The "Archi-Bio" design project

3 Creativity and 3DVW

Creativity is at the essence of design, and a focus of design education is the development of students' creative skills; that is, their ability to initiate and engage in creative processes, to identify and evaluate creativity as a design requirement, and to employ lateral thinking in the drive towards creative design outputs.⁵ Advancing creative ability through education requires an approach "in which all aspects of teaching and learning adhere to basic principles for fostering creativity. These involve [...] not only intellectual, but also personal, motivational, emotional, and social aspects of creativity [...] children need contact with complexity, ambiguity, puzzling experiences, uncertainty, and imperfection" (Cropley, 1997: 107).

⁵ "Creativity" is a complex concept which encapsulates factors related to the individual, process, product and environment. In the design literature "creativity" is most commonly defined as the development of ideas or products that have the quality of being both useful and original. When using the term "creativity" in this paper, we refer to this generic definition. It is, however, acknowledged that creativity is a much more multifaceted concept and phenomenon than this, though a discussion of the complexity and ambiguity surrounding the concept as it relates to the design disciplines is beyond the scope of this paper. This issue is dealt with in, for example, Williams, Ostwald and Askland (2010) and Askland, Ostwald and Williams (2010).

This requires a pedagogical approach that places the students at the centre of learning; it necessitates an approach that makes the students responsible for their own learning through an emphasis on problem-based learning and enquiry-based curricula. As stated above, such a learning and teaching approach is an essential part of design education and of high relevance to teaching strategies using 3DVW.

The relevance of 3DVW in relation to creativity does, however, extend its compliance towards project-based and problem-based learning. 3DVW offer alternative means for developing creative design in their provision of unusual design contexts, such as underwater sites and sites in the sky as was used in one of the studios described above, and the subsequent expansion of the physical boundaries restricting conventional design. Moreover, the observation and interaction with the design and other collaborators through avatars and their ability to teleport or fly, as well as the lack of restrictions set to movement and interaction (for example, the ability to navigate under water and interact and communicate without being physically present) allow designers (through their avatars) to explore design and its representation in ways that are beyond the possibilities of real life. Spatial design in 3DVW is therefore not restricted by the conventions of the built environment. This quality suggests an expansion of opportunities for creative design, at least in terms of originality. Freed from the laws of physics and other requirements, as well as the conventional socio-cultural and geo-political expectations, challenging, innovative, non-realistic and abstract design solutions may arise. As such, 3DVW, as a new design discipline in its own right, can lead to more interesting outcomes and encourage designers/students to explore different design possibilities to those they engage with in conventional architectural design studios.

This does, however, not imply that there are no boundaries within 3DVW; indeed, 3DVW embody alternative boundaries that result from the use of various physical metaphors that make direct references to the built environment or that are imposed by the computer hardware/software and network that power the 3DVW. As a result, designing in 3DVW may advance students' abilities to identify and address new design constraints, a skill that is also developed and exercised within conventional design environments. Though, in contrast to the conventional responses required when designing in traditional design environments, the loosely defined characteristics of 3DVW and the alternative boundaries are expected to encourage unconventional design solutions.

Contrary to common myths about creativity, having boundaries and a sense of context are prerequisites for creative design. Something that is

original, novel and challenging is not necessarily creative; in fact, originality can become an adverse quality if it is nothing but original. For a design to be creative it should not only challenge conventions, it also has to be appropriate and suitable—it has to serve a purpose. As in the real world, design in 3DVW serves a purpose; it may, for example, serve individual needs, enhance interaction and activity, or support activities such as e-business, education and entertainment. Thus, the fact that 3DVW can be totally free from physical limitations does not mean that boundaries and rules in 3DVW are non-existent to designers. The importance of a design purpose and of understanding the appropriateness of a design for its user group is as important in 3DVW as it is in the real world. Once designers understand the importance of the design purpose and the suitability for its user groups, the design issue becomes much more complex, and, as in real world design, it is important to challenge the conventions to achieve novelty yet without alienating the users with design solution that are beyond their ability in comprehending and inhabiting the space. Knowing and understanding why the design is developed (the purpose), who the design is for (the users) and where the design is located (the context) are essential. This can be seen in relation to the theoretical framework of the highly influential psychologist Mihaly Csikszentmihalyi (1988; 1999) suggests that if “creativity is to retain a useful meaning, it must refer to a process that results in an idea or product that is recognized and adopted by others. Originality, freshness of perception, divergent-thinking ability are all well and good in their own right, as desirable personal traits. But without some form of public recognition they do not constitute creativity” (Csikszentmihalyi, 1999: 314). According to Csikszentmihalyi, creativity is a phenomenon constructed through the interaction between producer and audience; that is, creativity is the product of social systems that make judgements about individuals' products (Csikszentmihalyi, 1999: 314). For creativity to occur, he argues⁶, “a set of rules and practices must be transmitted from the domain to the individual. The individual must then produce a novel variation in the content of the domain. The variation then must be selected by the field for inclusion in the domain” (Csikszentmihalyi, 1999: 315). However, if the

⁶ The concepts of “field” and “domain” are central to Csikszentmihalyi's theory. These refer to two salient aspects of the environment in which individuals operate; namely the social aspect (the field) and the cultural, or symbolic, aspect (the domain).

boundaries, rules and practices of 3DVW are not set, how can creativity be ensured in 3DVW? How does the designer know the field and domain in 3DVW?

Despite the high level of abstraction, creativity in 3DVW does not distinguish itself from that of the real world in this regard and, as in physical settings, creative outputs rely on the designer being immersed in the particular setting, on his or her engagement with significant others, and on the ability to identify the purpose of the design. For design to have creative value, knowing the virtual field and the domain—the social and symbolic setting of the virtual reality—is as important in 3DVW as it is in built environments. Accordingly, it may be argued that the role of social and cultural aspects in the real world of design are to a certain extent reflected in 3DVW, however the values, codes, rules and boundaries underpinning their roles may be different. It is within this difference that 3DVW may encourage more challenging and unconventional design than the real world. As mentioned in the above description of the “zero-gravity” student project, the lack of real world repercussions allows people to take risks with regards to form, enhancing possibilities for original and ground-breaking solutions. In contrast to the real world in which function ultimately drives design, 3DVW allow the designer to isolate different design aspects without any correlation, subsequently focusing on particular aspects of the design.

This brings us to another point: the question of so-called “press-factors” on creative design. The term “press” was introduced by Rhodes in 1961 in his attempt to categorise the wide range of studies of creativity. It represents one of four categories (the three others being creative product, creative process and creative person), and refers to factors that influence (put pressure on) creative processes or the creator. More specifically, it refers to “the relationship of human beings and their environment” (Rhodes, 1987 [1961]: 220). Of particular relevance to this discussion is the educational literature on environmental factors that are conducive of creativity. According to Dineen and Collins (2005: 45-50) creativity will thrive “in an environment where the individual feels psychologically and physically comfortable, in an atmosphere of trust, security and openness. In particular, creativity is encouraged in a climate where, within an ordered but non-hierarchical structure, speculation and fantasy are encouraged and ambiguity and uncertainty are tolerated.” The idea of an environment that is open for speculation and fantasy is at the centre of virtual environments and virtual communities. As shown in our studios, the very nature of 3DVW challenges conventional ways of designing and thinking, and if, within this environment, students receive adequate support and

encouragement, this characteristic could be conducive to further abstract and lateral thinking, which leads to challenging design solutions and approaches.

The abstract and loosely defined nature of virtual environments will not in itself lead to creativity; to take full advantage of the possibilities embodied in 3DVW the designer has to be able to release him or herself from their conventional ways of thinking. This can be illustrated through the concepts of metaphorical and virtual approaches to designing. Both metaphorical and virtual approaches can be adopted when designing in 3DVW. However, whereas the metaphorical approach remains embedded in the logic of the physical world, the virtual approach adopts the discourse of the virtual world. The metaphorical approach will mimic physical forms and/or physical experiences and, as such, remain bound by the constraints and boundaries that are posed therein. The creative process will therefore follow a similar path to conventional design and, though creative results may be achieved, the full potential of virtual worlds is not embraced. A virtual approach, on the other hand, focuses on the unique qualities of virtual worlds and may lead to design that explore interactions and experiences that are not readily available in the physical world.

Encouraging students to adopt a virtual approach when designing in 3DVW could give them valuable experiences that may further foster their creative potential. Whereas a virtual approach may represent a risk within conventional design environments as it gives students the freedom to act without consideration of the necessary values, codes, rules and boundaries that conceptualise their design, the physical risks associated with such behaviour are eliminated when adopting this approach in 3DVW. There is, however, a conceptual risk associated with this approach, also when adopted in 3DVW. As in any hypothetical studio exercise, virtual studios have to nurture a distinct professional culture and students have to develop an appreciation of the social and cultural values and practices of the disciplines. By turning 3DVW into a valuable exercise, as discussed above, by guiding the students to actively identify, develop and address constraints by considering the purpose and user group of the design, the conceptual risks can be minimised. Accordingly, the students would be encouraged and mentored in sensible risk-taking and through reflection of their actions and experiment of different design variations in 3DVW their understanding of the relationship between creativity and risk-taking could be enhanced. In fact, encouraging students in sensible risk-taking is identified by Sternberg (2003) as one of the main strategies for persuading students to “decide for creativity” (Sternberg, 2003: 118).

According to Cross (2000: 4), “[t]he most essential design activity [...] is the production of a final description of the artefact.” This, he explains, “has to be in a form that is understandable to those who will make the artefact”. The most widely used form for communicating the creative idea is drawing or sketching. Drawing not only informs the communication of design, it also enables evaluation of design ideas; it allows for the designer and others to check and evaluate the design proposal before deciding on the final version. Drawings represent the creative idea and enable feedback; they support the conceptual development of creative ideas. According to Cowdroy and de Graaff (2005), conceptualisation is the very essence of creativity, with conceptualisation the highest level of creative ability, followed by schematisation and execution, all represent cognitive processes underpinning creative work. When Cross (2000) speaks of the importance of drawing as enabling conceptualisation, this should be seen as referring to drawing as a practical tool that supports the cognitive process of conceptualisation. Drawing is a crafting skill, which together with particular types of memory and thinking skills represent an important aspect of creative ability (Cowdroy and Williams, 2006). 3DVW represents an alternative crafting skill that may support equivalent creative processes as drawing does in conventional design environments. This assumption is supported by Maher, Gu and Kim (2009) who collected cognitive evidence by comparing the designers who designed and collaborated in conventional sketching environments and in 3DVW. They argue that the role of 3D modelling activities in 3DVW go beyond traditional design representation and documentation purposes and contribute to conceptual design development. However, in contrast to conventional design, which display a clear distinction between the stages of conceptualisation, schematisation and actualisation, these stages are intertwined when designing in virtual environments.

In 3DVW it is difficult to distinguish the process of conceptualisation and the process of creating representations of a creative idea in the form of 3D models from one another. The NU Genesis course suggests that students tend to adopt one of two approaches to the process. The first approach is form-based by which the conceptualisation and representation develops from exploration of interesting forms towards a concept that is to be developed. This approach will allow a designer or a group of designers to reach a design solution relatively quickly and to move on to detailed design and documentation as it indeed starts with form making and detailed modelling. The second approach, on the other hand, is concept-based. Those who adopt this approach will first explore, develop and agree on an in-depth concept

which will later be realised through 3D modelling. This approach is often slower than the form-based approach, especially in the early stage of the design process. The design outcomes will often display a higher level of creativity and be more interesting and sophisticated. This can be understood on the basis of the argument that any project has to allow time for creative thinking; creativity requires time for incubation and any task, assignment or project must allow for a thorough understanding of the problem (Sternberg, 2003; Wallas, 1926).

The adoption of the different approaches amongst students can also be due to the different preferences on design methods and media. The simultaneous process of conceptualisation and representation/modelling when designing in 3DVW could therefore have varied impact on the creative process, which requires further evidence for validation.

4 Conclusion

This paper has considered the pedagogical potential of 3DVW in design education, in particular as it relates to creativity. The study suggests that there is indeed a place for 3DVW in formal design education beyond it being used as an alternative modelling tool for simulation and collaboration. 3DVW should be considered as design environments in their own rights and they embody alternative avenues for teaching and learning. The underpinning logic of 3DVW forces students to approach projects and tasks from different and perhaps unusual angles. Through this process they may become aware of aspects of design, the design process and their role as designers that are convoluted in conventional design environments. Despite this pedagogical potential, 3DVW should not replace traditional teaching and design environments. Rather, 3DVW should be integral to the domain. As such, students may learn how to think using different parameters and engage in complex and diverse contexts. Moreover, it may teach future designers how to actively identify, define and develop boundaries, rules and parameters for design. It may foster curiosity and give students confidence to question externally posed boundaries and, if appropriate, subsequently challenge and break them, consequently enhancing the creative potential of design. To advance the field, further research is required in order to better understand the relationship between creativity and 3DVW in consideration of design and design education, and there is a need for further technological development to provide tools that can explicitly support the creative process in 3DVW, in particular the process of conceptualisation.

References

- Abbott J, Ryan T, (1999) Constructing knowledge, reconstruction schooling. Retrieved May 7, 2007 from www.21learn.org/publ/edleadership1999.html
- Askland HH, Ostwald M, Williams A, (2010) Changing conceptualisations of creativity in design. Proceedings of DESIRE'10, Aarhus, Denmark
- Boud D, Keogh R, Walker D, (1985) Reflection. Turning experience into learning. London: Kogan Page
- Bruner J, (1966) The process of education: towards a theory of instruction. Cambridge, Mass: Harvard University press
- Clark S, Maher ML, (2005) Learning and designing in a virtual place: investigating the role of place in a virtual design studio. Proceedings of eCAADe 2005, Technical University of Lisbon: 303–310
- Cowdroy R, de Graaff E, (2005) Assessing highly-creative ability1. Assessment and Evaluation in Higher Education 30: 507–18
- Cowdroy R, Williams A, (2006) Assessing creativity in the creative arts. Art, Design and Communication in Higher Education 5: 97–117
- Cropley AJ, (1997) Fostering creativity in the classroom: general principles. In Runco MA, (Ed) The creativity research handbook: volume one. Cresskill: Hampton Press, inc: 83–114
- Cross N, (2000) Engineering design methods: strategies for product design. Chishester, New York: Wiley
- Csikszentmihalyi M, (1988) Society, culture and person: A systems view of creativity. In Sternberg R, (Ed) The Nature of Creativity: Contemporary Psychological Perspectives. Cambridge: Cambridge University Press: 325–339
- Csikszentmihalyi M, (1999) Implications of a systems perspective for the study of creativity. In Sternberg R, (Ed) Handbook of creativity. Cambridge, New York: Cambridge University Press: 313–335
- Dede C, (1995) The evolution of community support for constructionist learning: immersion in distributed virtual worlds. Educational Technology 35: 46–52
- Dickey MD, (2005) Three-dimensional virtual worlds and distance learning: two case studies of active worlds as a medium for distance education. British Journal of Educational Technology, 36: 439–451
- Dineen R, Collins E, (2005) Killing the goose: conflicts between pedagogy and politics in the delivery of a creative education. International Journal of Art and Design Education 24: 43–53
- Gu N, Williams A, Gul L, Nakapan W, (2009) Evaluating the Use of 3D Virtual Worlds in Collaborative Design Learning. Proceedings of CAAD Futures 2009, Montreal, Canada: 51–64
- Gu N, Gül LF, Maher ML (2007) Designing and Learning within the Design: a Case Study of Principles for Designing and Teaching 3D Virtual Worlds. Proceedings of CAADRIA 2007, Nanjing, China: 127–132
- Gül L, Gu N, Williams A, (2008) Virtual Worlds as a Constructivist Learning Platform: Evaluations of 3D Virtual Worlds on Design Teaching and Learning. Journal of Information Technology in Construction 13:578–593
- Kalay YE, Marx J, (2001) Architecture and the Internet: Designing Places in Cyberspace, Reinventing the Discourse. Proceedings of the 21 Annual Conference of the ACAADA, Buffalo, New York: 230–241
- Kubicki S, Halin G, Bignon JC, Nakapan W, (2004) Collaborative Sesign: A French/Thai experiment of co-design. Proceedings of SIGraDi '04, Porte Alegre, Brasil
- Kvan T, (2001) The problem in studio teaching – revising the pedagogy of studio teaching. Proceedings of the 1st ACAE Conference on Architecture Education, National University of Singapore: 157–166
- Kvan T, Mark E, Oxman R, Martens B, (2004) Ditching the dinosaur: redefining the role of digital media in education. International Journal of Design Computing: 7
- Maher ML, Gu N, Kim M, (2009) Virtual Worlds and Tangible Interfaces: Collaborative Technologies That Change The Way Designers Think. Proceedings of CONVR 2009, Sydney, Australia: 9–18
- Prasolova-Förland E, (2004) A Repository of Virtual Places as Community Memory: an Experience of Use. Proceedings VRCAI, Singapore: ACM Press: 225–228.
- Piaget J, (1977) The Essential Piaget, ed. Gruber HE, Vonèche JJ. London: Routledge and Kegan Paul
- Rapport N, Overing J, (2000) Social and Cultural Anthropology - The Key Concepts. London and New York: Routledge
- Rhodes M, (1987 [1961]) An analysis of creativity. In Isaksen SG, (Ed) Frontiers of Creativity Research: Beyond the Basics. Buffalo, NY: Bearly: 216–222
- Spady WG, (2001) Beyond counterfeit reforms: forging an authentic future for all our learners. Lanham, Maryland: The Scarecrow Press
- Sternberg R, (2003) The development of creativity as a decision-making process. In Sawyer RK, John-Steiner V, Moran S, Sternberg R, Feldman DH, et al. (Eds) Creativity and Development. New York: Oxford University Press: 91–138
- Wallas G, (1926) The art of thought. London: Jonathan Cape
- Wyeld TG, Prasolova-Forland E, Teng-Wen C, (2006) Virtually collaborating across cultures: a case study of an online theatrical performance in a 3dve spanning three continents. Sixth International Conference on Advanced Learning Technologies: 1076–1078
- Williams A, Ostwald M, Askland HH, (2010) Assessing creativity in the context of architectural design education. Proceedings of DRS 2010, Montreal, Canada
- Woods D, (1985) Problem-based learning and problem-solving. In Bound D, (Ed) Problem-based learning in education for the professions. Higher Education Research and Development Society of Australasia, Sydney: 19–42

Thinking Inside the Box: Model, Tool, Team and Setting for Building Design

Wim Zeiler

Technische Universiteit Eindhoven, Netherlands

Abstract. This article provides an overview of research into the use of a design method and its tool to explain and to illustrate the mental model of a design team. Purpose: to show a way to partly describe collaborative conceptual building design processes. Methodology: Our approach uses a design method to structure and to describe the conceptual building design team process. This enables us to use it to illustrate the mental model of the design team. Findings: Our approach is useful to let the designers reflect on the process as well as on the results. There is a stimulating effect of the method on the amount of solutions as well as on the communication within the design team. Value: The paper presents the application of tools of a design method to construct a mental model of a design team. This approach can be used to further investigate the creative processes within design teams.

Keywords: mental team model, integral design, morphological chart, morphological overview

1 Introduction

The design process in the built environment starts with a principal/ client who want to have a new building. The principal approaches different architects and after the selection by the client the chosen architect starts to work with the client to find out what is needed. Ever since Vitruvius' first treatise on architecture, *de Architectura* of around 25 BC, resulting in the three main principles *venustas*, *firmitas* and *utilitas*, we accepted that an architect must know a little bit about everything because design work requires varied knowledge and an outstanding capability for mental integration and synthesis (Goldschmidt, 1995). Traditionally the architect has played the role of creator, making designs for the engineer to analyze, test, optimize and make buildable (Speaks, 2008).

Preservation of energy resources, occupant comfort and environmental impact limitation are the key issues of modern and sustainable architecture. Sustainability is the key issue for the future: without sustainability there will be no future. Buildings use more than 40% of all our energy and generate emissions that pollute

the air and increases the effect of Global Warming (Alley R et al., 2007). Due to the growing complexity and scale of design processes in architecture and in building services engineering as well as the growing demands on sustainability, efficiency, throughput time and quality, traditional approaches to organize and plan these processes may no longer suffice (van Aken, 2005).

Buildings can no longer be designed by an architect alone: a whole design team is needed to cope with the complexity of the design problem and come up with the right creative design solution. The ancient Greeks thought that there were divine sources that inspired creative work (Liikkanen and Perttula, 2008). Creativity in the design is still often characterised by the occurrence of the so called 'creative leap'. However descriptive empirical studies of the creative event have shed more light on this mysterious and often mystified aspect of design (Dorst and Cross, 2001).

Creativity focusing on solution generation of individuals and groups has been a research field of psychology with first investigations more than 100 years ago by Galton in 1869 (Badke-Schaub, 2007). The big push of interest in the subject of creativity began in 1950 (Rhodes, 1961) when J.P. Guilford in his 1950 presidential address to the American Psychological Association pointed out the importance of studying creativity and reviewed the index of Psychological Abstracts for the proceedings 23 years (Puccio, 1999). According to Guilford (1950), creativity requires the ability to overcome known routes of thinking, to think divergently, contrary to convergent thinking (Badke-Schaub, 2007). The term divergent can be used synonymously with 'creative' design (Liikkanen, 2010).

There are many techniques, tools and methods developed to foster creativity. The most popular method for generating creative ideas, brainstorming was initiated by Osborn in 1939 as 'brainstorm' and subsequently led to his book *Applied Imagination* (1953). Osborn began hosting group-think sessions and noticed that the quantity of ideas was much greater

than those produced by individual persons. Brainstorming has found to enhance idea generation compared to non-brainstorming methods. However, group brainstorming does not seem to be more effective than individual brainstorming (Nystad et al., 2003) and therefore the focus stayed on the individual. According to the investment theory by Sternberg (2006) creativity requires a confluence of six distinct but interrelated resources; intellectual abilities, knowledge, styles of thinking, personality, motivation and environment. However the past years the focus has moved to the group as a source of creativity and innovation (Badke-Schaub, 2007). However even though there is a broad agreement on the important role of creativity in design scientific research does not provide much information about the processes which are related to creativity in designing (Badke-Schaub, 2007).

Using a in principle prescriptive design method in a kind of reverse engineering approach to describe the design process we want to make the design process more transparent: illustrate what is happening inside the black boxes of the designer's minds. This paper describes the effort to combine mental models of design teams with the descriptive application of the integral design method's tools, see section 2. Originally this research set out to develop a method to create a more transdisciplinary design process that would create the opportunity to introduce a greater variety and amount of design knowledge from the outset of the conceptual design phase. Using workshops, see section 3, in which experienced professionals participated, the design tools of the design method were used to illustrate the design process and form part of the mental model. In section 4 some results are given followed by discussion, section 5 and conclusion in section 6. Some limitations and future directions are mentioned in section 7.

2 Methodology: Team Mental Models and Integral Design Tools

2.1 Mental Models in Design Teams

Researchers in several disciplines have applied the construct of mental models to understand how people perform tasks based on their knowledge, experience and expectation (Badke-Schaub et al., 2007). Most research on team mental models focused on operating complex technical systems (Mohammed et al., 2010) which activities mostly follow standard operations and procedures rather than design which involves inventive problem-solving. Therefore there is a major difference: for more creative tasks, i.e. design, the procedures to follow are not previously known. The requirements for mental models to be shared in teams

might consequently be rather different. Shared mental models are dependent on the task demands and they should be carefully considered for every domain because of the difference in tasks and teams (Neuman et al., 2006). Therefore different types of models are needed to describe teamwork processes. Starting from the four models that are commonly used by Cannon-Bowers (the task model, the equipment model, the team model and the team interaction model) Badke-Schaub proposed a modified framework for design activities (Neuman et al., 2006), see Table 1.

Table 1. Types of mental models in design (Neuman et al 2006)

Types	Knowledge content about
Task	the task, including task procedures, product knowledge and tools
Process	Problem solving strategies, idea generation and evaluation
Team	team-mates understanding, roles, interactions and communication channels
Competence	confidence and beliefs in one's own and the other members' strengths and capabilities

Team Mental Models are not meant to only refer to multiple levels or sets of shared knowledge but also to a synergetic functional aggregation of the teams mental functioning representing similarity, overlap and complementarity (Langan-Fox et al., 2004). Therefore using mental model research to investigate design processes might help to understand how the solution finding creativity part evolves and how it is communicated in a team (Badke-Schaub et al., 2007). Designing typically takes part in an organizational context, with relations to clients and users and specific market situation. Thus, an analysis of mental models in design teams needs to include context knowledge that reflects the given situation, see Fig. 1. (Badke-Schaub et al., 2007).

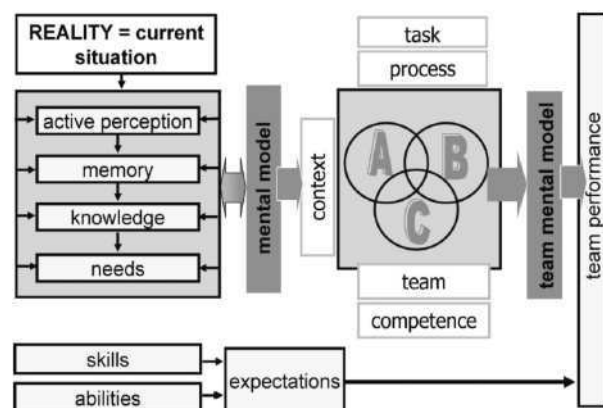

Fig. 1. Mental models (Badke-Schaub et al., 2007)

Mental models are hypothetical constructs that cannot be directly measured (Neuman et al., 2006) we choose to focuss on one intervention and to use the tool of intervention also as a tool to measure and to represent a mental model of the team. By applying a design method to describe the design process in such a way that it could be used to make a mental model of the design team.

2.2 Integral Design method

The origins of design methods lay in the 1960s and were based on the application of ‘scientific’ methods derived from operational research methods and management decision-making techniques in the 1950s (Cross, 2007). Since then there was development right up to day. Still there is no clear picture (Horváth, 2004, Bayazit 2004) and many models of designing exist (Wynn and Clarkson, 2005, Pahl et al., 2006, Howard et al 2008, Tomiyama et al., 2009). We choose Methodical Design as developed by van den Kroonenberg as a starting point, as it is based Systems theory and on a synthesis of the German and Anglo-American design models of the mid seventies (Zeiler and Savanovic, 2009a) and as such has exceptional characteristics (Blessing, 1994). Methodical Design divides the design process into stages and steps to decompose the design task and to structure the process around more manageable tasks. The transition between steps provides decision points, enabling review and evaluation of the results generated step by each step. Starting from the prescriptive model of Methodical design, Integral Design was developed to articulate the relationship between the role of a designer as descriptor or observer within the design team and to reflect on the process (Savanovic, 2009, Zeiler and Savanovic, 2009b). The Integral design method has an extended design cycle (define/analyze, generate/synthesize, evaluate/select, implement/shape) which forms the sequence of design activities that take place, see Fig. 2.

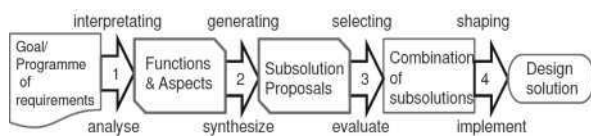

Fig. 2. Four-step pattern of Integral Design

A distinguishing feature of Integral Design is the intensive use of morphological charts to support design activities in the design process. Morphological charts were first used by Zwicky (1948). The morphological chart is formed by decomposing the main goal of the design task into functions and aspects, which are listed on the first vertical column of the chart, with related subsolutions listed on

corresponding rows, see Fig. 3. The functions and aspects are derived from the program of demands.

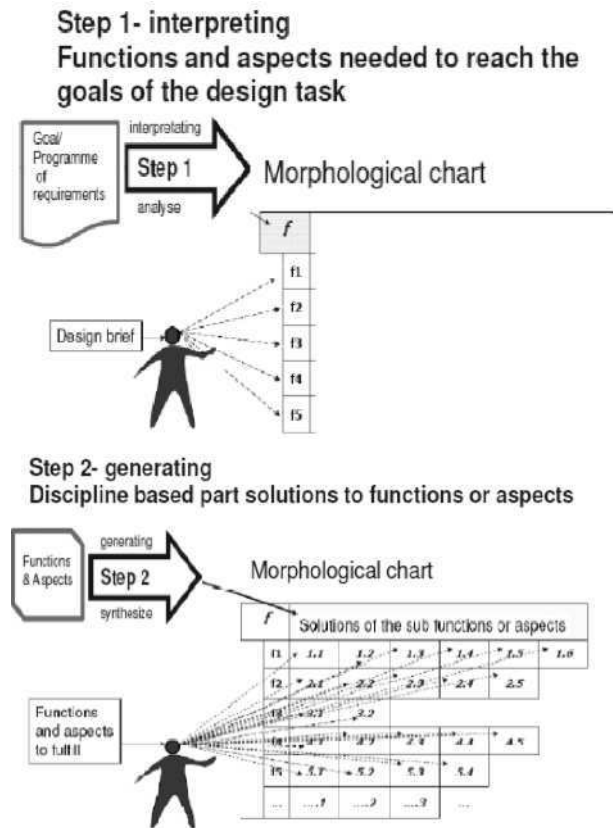

Fig. 3. Morphological charts as part of the Integral Design method

The morphological charts made by each individual designer can be combined into a (team) morphological overview, after discussion on and the selection of functions and aspects considered important for the specific design.

Based on the applied Integral Design method to structure the design process and using its design tools, the morphological chart and morphological overview we can show in analogy with the model of Badke-Schaub (Badke-Schaub et al., 2007), how the mental models in teams develop. Based on the current situation, each design team member architect, structural engineer, building physics consultant and building services engineer perceives reality due to his/her active perception, memory, prior knowledge and needs, see Fig. 4 and compare it with Fig. 1. It shows that the morphological charts and morphological overview of the Integral Design method can make transparent some parts of the Team Mental Model.

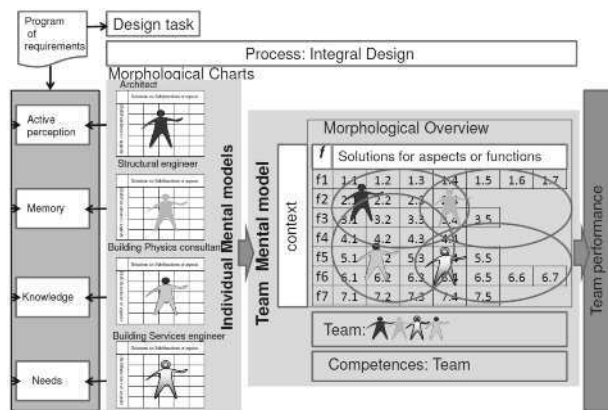

Fig. 4. Design team mental model in analogy with the model by Badke-Schaub et al. (2007)

3. Workshops

The Integrila design approach with its tools was tested in workshops. The participants of these workshops were members of the professional organizations of architects (BNA) and engineers (NLIngenieurs) in the Netherlands and had on average 12 years experience. In each workshops up to 7 teams, existing of an architect, structural engineer, building physics engineer and building service engineer, participated (Savanovic, 2009). A total of 108 designers participated in the five workshop series.

In total 5 series of workshops were organized based on earlier experiments (Zeiler et al., 2005). After each workshop the set-up and the results were evaluated and adjustments made. The experiences of the first three workshops ‘learning by doing’ series led to a final setup used the final workshops series 4 and 5.

Essential element of the workshop were besides some introduction lectures the design cases on which the teams of designers had to work and which they had to present at the end of each session to the whole group. In the current configuration (Fig. 5) stepwise changes to the traditional building design process type, in which the architect starts the process and the other designers join in later in the process, are introduced in the set up of the design sessions. The first two design sessions on day 1, provide reference values for the effectiveness of the involved of all designers from different disciplines right from the start. On the 2nd day the morphological overviews introduced. The application of morphological overviews during the set up of the third design session enabled transparent structuring of design functions/aspects and the generated (sub) solution proposals. Additionally, the third setting provided the possibility of one full learning cycle regarding the use of morphological overviews. After the feedback about their use of

morphological charts and the morphological overview all teams had the basic knowledge to apply them correctly.

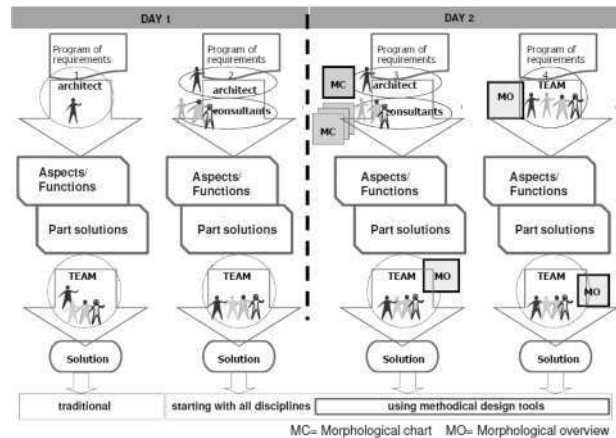

Fig. 5. Workshops series 4 & 5, four different design set ups of participants and their use of morphological charts (MC) and/or morphologic overviews (MO) during the four design settings within two days (Savanovic, 2009)

1st design setting, ‘sustainable parasite pavilion’

In order to demonstrate what occurred in design setting 1, the work and analysis of one team is presented below, while the work of the other four teams can be found in Savanovic (2009).

After the initial design session I, in which the architect worked alone, all team members met in design session II, to discuss the design. Here, the architect led the discussion. The analysis of each team’s work started with the translation of the architect’s explanation of the initial proposal at the beginning of second design session is into a table of aspects and sub solutions, see table 1.

This resulting sequential list is then structured in the architect’s morphological chart. Then, on the basis of a review of the videotaped session, a table of aspects and sub solutions considered by the design team is structured in the design team’s morphological overview.

The analytically derived morphological overview of team 1 from the explanation of the architect to the rest of the team, is presented in Fig. 6. The aspects/functions and sub solutions originally brought to the table by the architect can be found as {A} in Fig. 7. After the discussion with the designer of other disciplines the team decided to work on those aspects and functions were they all agreed on leading to the morphological overview of Fig. 7, which represents the final result of the first design session. Through the discussion and selection of aspects and functions as well as the related sub-solutions, the team members manage the consistency of the solutions. Inconsistent

sub-solutions are either improved to become consistent or left out.

Table 1. Transcript of functions/aspects and subsolutions mentioned by the architect

Time (design session II)	Who	Aspect or sub solution	Description
00h04min	A	Aspect (1)	Form
00h04min	A	Aspect (2)	Materialisation
00h04min	A	Sub solution (1-1, 2-1)	Contrasting to the existing building
00h04min	A	Sub solution (2-2, 3-1)	Wood
00h05min	A	Sub solution (2-3)	Open structure
00h05min	A	Aspect (3)	Sustainability
00h05min	A	Sub solution (4-1)	On (the existing building)
00h05min	A	Sub solution (4-2)	Against (the existing building)
00h05min	A	Sub solution (4-3)	Loose (from to the existing building)
00h06min	A	Sub solution (4-4)	In the middle (of existing building)
00h06min	A	Solution!	'Roof' on the existing roof...
00h09min	A	Solution!	Loose, vertical spiral addition...

Design aspects/ functions:	Sub solutions:				
(1) Form {A}	(1-1) Contrasting {A}				
(2) Materialisation {A}	(2-1) Contrasting {A}	(2-2) Wood {A}	(2-3) Open structure {A}		
(3) Sustainability {A}	(3-1) Wood {A}				
(4) [positioning]	(4-1) On {A}	(4-2) Against {A}	(4-3) Loose {A}	(4-4) In the middle {A}	

Fig. 6. Architect’s morphological chart, design setting 1 session 1

Design aspects/ functions:	Sub solutions:				
(3) Sustainability {A}	(3-1) Wood {A}	(3-2) Heat pump {BP}	(3-3) Natural ventilation {BP}		
(4-1) [positioning]	(4-1-1) 90 over the ex. building, on own legs {BP}	(4-1-2) 35-meter beams {SE}	(4-1-3) in line and partly over the ex. Building {BP}	(4-1-4) V-shaped columns {A/SE}	
(5) Demountable {SE}	(5-1) flexible, prefab system {SE}	(5-2) plug'n'play building services {Team}			
(6) [Entrance]	(6-1) Independent {A}	(6-2) Extend existing entrance {A}			
(7) Flexibility {BS}	(7-1) Theatre at the end {A}	(7-2) entrance on west side {BP}			
(8) Orientation, sun {BP}	(8-1) roof wider than floor {A}				

Fig. 7. Design team’s morphological overview, design setting 1 session 2

2nd design setting, ‘zero energy office’

The analysis of the second design sessions of the second workshop design setting is based on videotaped design team activities. The resulting table of aspects and sub solutions considered by design teams during session II is structured into the design team’s morphological overview.

3th design setting, ‘sustainable roof renovation’

Design setting 3 represented a learning-by-doing opportunity to work with the specific design tools for the individual disciplines and the design teams. The

ideal outcome would be that each team could clearly demonstrate successful use of the design tools during the design process. However, as a key part of learning is feedback, after the teams completed tasks set in setting 3, time was given to compare and appraise the teams’ work and to answer any questions that arose.

4th design setting, ‘zero energy design school’

Design setting 4 represents the very last stage in the cycle. All of the individual interventions that were used in the earlier research stages are combined so that in setting 4 the ID-method could be tested. To be explicit, the elements that have been combined are: design team, design model, design tool and design setting. In this setting, all of the design teams’ proposed sub solutions were recorded directly on morphological overviews, see as an example the morphological overview of team 1, Fig. 8.

Design aspects/ functions:	Sub solutions:					
(1) Sustainability {Team}	(1-1) ‘green’ facade {A}	(1-2) PV/T shadings {BS}	(1-3) ‘buffering’ for humidity {A}	(1-4) roof garden {BS/A}		
(2) child-friendly, healthy {Team}	(2-1) Scale, identity {A}	(2-2) natural materials {BS/A}	(2-3) structure, protection {A}	(2-4) open facade, windows {A}		
(3) Natural ventilation {Team}	(3-1) HOLCOM ventilation {BS}	(3-2) higher classrooms {BS}	(3-3) walls for ventilation {BS}	(3-4) building orientation {BS}		
(4) Energy sustainability {Team}	(4-1) photo-voltaic thermal	(4-2) adiabatic cooling {Brief}	(4-3) air-inlet via underground {BS}	(4-4) CHP for winter {BS}	(4-5) floor heating {A/BS}	(4-6) sprinkler comb. cooling {A}
(5) Flexibility {Team}	(5-1) Columns {SE}	(5-2) Walls {SE}	(5-3) C/W Combination {Team}	(5-4) System platform {A}	(5-5) ‘Clear’ platform {A}	(5-6) HOLCOM floor {A}

Fig. 8. Design team 1 morphological overview, design setting 4

4 Results integral design workshops

Here only a brief selection of all the results is given. More results and information is presented by Savanovic (2009). From the analysis of the workshops it could be concluded that the number of functions and aspects considered as well as the number of subsolutions offered, was significantly increased by applying the Integral design method with its Morphological Overview. A good example of this increase can be seen from the results from session 1 (without morphological charts and morphological overview) compared with the results of session 4 (with use of morphological charts and morphological overview), see Fig. 9. The comparison of design setting 1 and 2 presents the effect of introducing all the different designers from the start without using support. This led to a decrease of the number of aspects and subsolutions, indicating a less effective design process. This is inline with literature about

brainstorm experiments, were they also found out that by just bringing together more designers the productivity doesnot increase compared with the results from individual sessions. The team has to have a kind of guidance, in our case the Integral desin method.

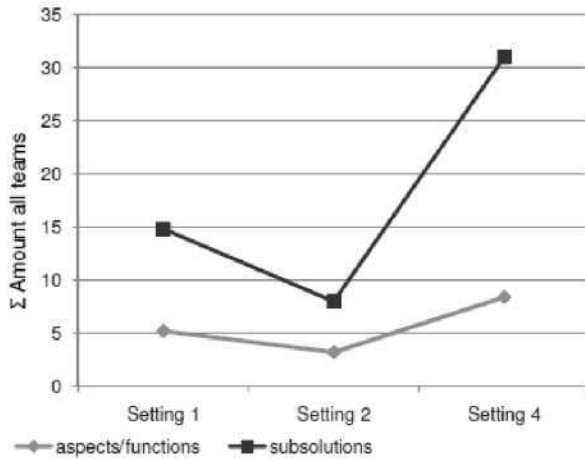

Fig. 9. Comparison of the number of aspects/functions and the number of partial solutions being generated by the design teams in design settings 1, 2 & 4

After each workshop series the participants were asked to fill in a questionnaire, see the result in table 3.

Table 3. Results questionnaires workshops series 1 till 5

	series 1	series 2	Series 3	series 4	series 5
Duration workshop in days	3	3	3	2	2
Number participants	20	20	22	27	18
Percentage returned questionnaires	88%	96%	98%	96%	97%
MO increases relevant alternatives	62	73	57	78	79
MO improves insight in other disciplines	74	74	56	77	85
MO relevant for own discipline	74	76	64	78	80
MO helpfull for communication	68	76	62	79	81
MO positive effect design process	70	74	47	77	77
MO positive effect final design	66	62	45	72	75
Stimulating the use of MO usefull	67	72	64	79	82
expects to use MO in daily practice	66	61	53	69	77

The results of the questionnaires showed that most of the participants thought that the method applied in the workshop improved their insight in the other disciplines within the deisgn team, see Fig. 10.

The participants also think that the application of the Morphological Overview is helpfull for the communication during the design process., see Fig. 11.

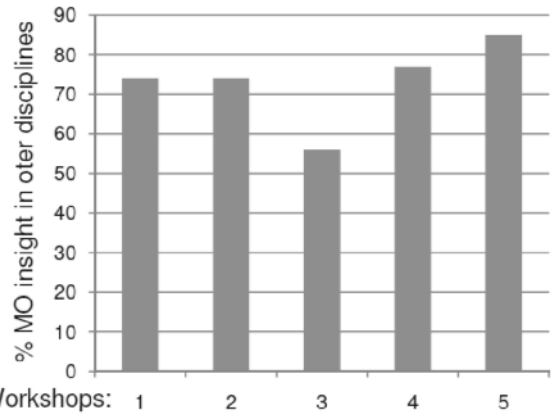

Fig. 10. Result questionnaires about the effect of the use of morphological overviews (MO) on the understanding of other disciplines

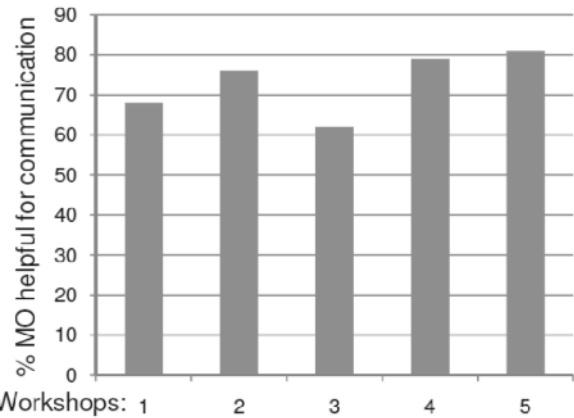

Fig. 11. Result questionnaires about the effect of the use of morphological overviews (MO) on the communication within the design team

5 Discussion

Morphological analysis is a term that recurs frequently for more than forty years in literature about techniques for stimulating creativity. Par example in the seventies Geschka in Germany already found that after brainstorming, morphological analysis was the best known, and most frequently used idea-generation from a sample of industrial respndence (Rickards 1980). In most cases the morphological approach is used in a kind of Brain writing way, without much supportive process structure. Recently a systematic method utilizing morphological analysis in ‘cross-functional teams’ was developed within a running product development project of a Swedish car manufacturer (Almefelt, 2005a; Almefelt, 2005b). Reflecting the specific industrial and theoretical background, the main idea of the method was to

support ‘early balancing of properties’ when synthesising a product concept: ‘a method highlighting synergies’. The aim of that project was to demonstrate, explore, and evaluate method’s practical effects in use; its application also meant that the acceptance of the method was tested through ‘verification by acceptance’. The method was applied in the early concept phase involving the use of ‘vague information and engineering assessment’, and needed to be ‘easy to learn and apply, to support co-operation, and to facilitate learning in the development team’.

The activation of design team member’s knowledge through a priming manipulation such as the use of morphological charts of morphological overviews leads to the generation of possibly generation of more (original) solutions. However there is a uncertain relation between quantity and quality. The most parsimonious interpretation of the quantity-quality relation is chance (Rietzschel et al., 2007): each generated idea has an equal probability of being a good idea. Therefore, according to the laws of chance, the number of good ideas produced should increase in dependency of the total number of ideas produced (Rietzschel et al., 2007). Still there is no simple linear relation between total productivity and the number of good ideas.

We think it is necessary to develop more support to designers for the morphological analysis. Therefore morphological chart and morphological overviews are parts of a the Integral design method which acts as supportive framework. Also it is necessary to know more about the black boxes of the individual team members’ brains, for that Team Mental Models, once more completely developed, could prove supportive.

6 Conclusion

The ID (Integral Design)-model can explicate individual disciplines’ design-knowledge and as such can it illustrate a parts of the Team Mental Model. It plays a part in the active perception, memory, explicitation of knowledge and interpretation of the design needs by the individual design team members. For the team members this has a positive effect as these element of their Team Mental Model becomes visible, as the results of the questionnaires showed.

7 Limitations and future directions

To have experimental control over the onset, frequency, and length of design sessions, we simulated conceptual design sessions in a workshop setting. Although this setting is as close as we can get to a

normal working situation there are ofcourse some fundamental differences. The workshops has a kind of study course atmosphere with instructional presentations and exercises for the participants. However the participants grow very fast in their role-play and seem to play it for real. However the design tasks though based on real projects are of course no real projects, so money aspects or legal aspects of contracts are no issue as opposed to real practice.

To get even more close to real practice we intend to observe design contest meetings, in which design teams prepare a conceptual design for a design competition. We were already able to observe and video tape such a session. The session took two hours, so the same as in our workshop setting, and had the same design disciplines participating as our workshop sessions: architect, structural engineer, building physics consultant and building services engineer. However much of the time the team spent on money aspects, discussion about the budget, and some legal aspects of the contract. So these aspects definitely have to be included in further research.

Acknowledgements

The project is financial supported by the foundation ‘Stichting Promotie Installatietechniek (PIT)’

References

- van Aken JE, (2005) Valid knowledge for professional design of large and complex design processes, *Design Studies* 26(4):379–404
- Alley R. et al., (2007), *Climate Change 2007: The Physical Science Basis Summery for Policymakers*, Intergovernmental Panel on Climate Change. Paris, France
- Almfelt L, (2005a) Balancing Properties while Synthesising a Product Concept – A Method Highlighting Synergies. *Proceedings of ICED’05*, Melbourne, Australia, Paper Number 300.46
- Almfelt L, (2005b) Requirements Driven Product Innovation, Methods and Tools Reflecting Industrial Needs. PhD thesis, Chalmers University of Technology, Göteborg
- Badke-Schaub P, (2007) Creativity and Innovation in industrial design: wishful thinking? *Journal of Design Research* 5(3):353–367
- Badke-Schaub P, Goldschmidt G, Meijer M, (2010) How does cognitive conflict in design teams support the development of creative ideas? *Creativity and Innovation Management* 19(2):119–133
- Badke-Schaub P, Neumann A, Lauche K, Mohammed S, (2007) Mental models in design teams: a valid approach to performance in design collaboration? *CoDesign* 3(1):5–20

- Bayazit N, (2004) Investigating Design: A review of Forty Years of design research, *Design Issues* 20(1)
- Blessing LTM, (1994) A process-based approach to computer supported engineering design. PhD thesis Universiteit Twente
- Cross N, (2007) Editorial Forty years of design research. *Design Studies* 28(1)
- Dorst K, Cross N, (2001) Creativity in the design process: co-evolution of problem-solution. *Design Studies* 22:425–437
- Goldschmidt G, (1995) The designer as a team of one. *Design Studies* 16:189–209
- Guilford JP, (1950) Creativity. *American Psychologist* 5:444–454
- Horváth I, (2004) A treatise on order in engineering design research. *Research in Engineering Design* 15:155–181
- Howard TJ, Culley SJ, Dekonick E, (2008) Describing the creative design process by the integration of engineering design and cognitive psychology literature. *Design Studies* 29(2):160–180
- Jansson DG, Smith SM, (1991) Design fixation. *Design Studies* 12(1):3–11
- Jehn KA, (1995) A multimethod examination of the benefits on intragroup conflicts. *Administrative Science Quarterly* 40:256–282
- Jehn KA, Nortcraft G, Neale M, (1999) Why differences make a difference: a field study of diversity, conflict and performance in workgroups. *Administrative Science Quarterly* 44:741–763
- Krick EV, (1969) An introduction to engineering and engineering design. London: Wiley
- Langan-Fox J, Anglim J, Eilson JR, (2004) Mental Models, Team Mental Models, and Performance: Process, Development and Future Directions. *Human Factors and Ergonomics in Manufacturing* 14(4):331–352
- Le Masson P, Hatchuel A, Weil B, (2007) Creativity and design reasoning: How C-K theory can enhance creative design, *Proceedings ICED07*, Paris
- Liikkanen LA, Perttula M, (2008) Inspiring design idea generation: insights from a memory-search perspective. *Journal of Engineering Design*, First published on: 27 September 2008
- Liikkanen LA, (2010) Design cognition for conceptual design. Doctoral Dissertation, Aalto University, Finland
- Mohammed S, Ferzandi L, Hamilton K, (2010) Metaphor No More: A 15-Year review of the Team Mental Model Construct. *Journal of Management* 36(4):876–910
- Neumann A, Badke-Schaub P, Lauche K, (2006) Measuring the development of shared mental models in product design teams. *Proceeding 16th World congress of ergonomics*, Maastricht
- Nijstad BA, Stroebe W, Lodewijckx HFM, (2003) Production blocking and idea generation: Doel blocking interfere with cognitive processes? *Journal of Experimental Social Psychology* 39:531–548
- Osborn AF, (1953) *Applied Imagination; Principle and Procedure of Creative Thinking*. New York: Scriber
- Pahl G, Beitz W, Feldhusen J, Grote KH, (2006) *Engineering Design, A Systematic Approach*. Third edition, Wallace K, Blessing L, translators and editors, Springer
- Puccio GJ, (1999) Two dimensions of creativity: level and style. *The International center for studies in creativity*, <http://www.buffalostate.edu/orgs/cbir/Readingroom/html/Puccio-99a.html>
- Rhodes M, (1961) An analysis of creativity. *Phi Delta Kappan* 42(7):305–310
- Rickards T, (1980) Designing for creativity: a state of the art review. *Design Studies* 1(5):262–272
- Rietzschel EF, Nijstad BA, Stoebe W, (2007) Relative accessibility of domain knowledge and creativity: The effects of knowledge activation on the quantity and originality of generated ideas. *Journal of Experimental Social Psychology* 43:933–946
- Savanović P, (2009) Integral design method in the context of sustainable building design. PhD thesis, Technische Universiteit Eindhoven
- Speaks M, (2008) Design thinking with Adams Kara Taylor. In *Design Engineering AKT*, edited by Kara H, and Taylor AK, Actor D, Barcelona
- Sternberg RJ, (2006) The nature of creativity. *Creativity Research Journal* 18(1):87–98
- Tomiyaama T, Gu P, Jin Y, Lutters D, Kind C, Kimura F, (2009) Design methodologies: Industrial and educational applications. *CIRP Annals – Manufacturing Technology* 58:543–565
- Wynn D, Clarkson J, (2005) Models of designing. Chapter 1 in *Designing process improvement*, Edited by Clarkson J, Eckert C, Springer
- Zeiler W, Quanjel EMCJ, Savanović P, Borsboom W, Trum H, (2005) Integral Design Methodology for the Built Environment. *Proceedings Design Research in the Netherlands*, Eindhoven
- Zeiler W, Savanović P, (2009a) General Systems Theory based Integral Design Method. *Proceedings ICED'09*, 24-27 August, Stanford, USA
- Zeiler W, Savanović P, (2009b) Reflection in building design action: Morphology. *Proceedings ICED'09*, 24-27 August, Stanford, USA
- Zwicky F, (1948) Morphological Astronomy. *The observatory* 68(845), August 1948

Signs of Collaborative Ideation and the Hybrid Ideation Space

Tomás Dorta¹, Annemarie Lesage¹, Edgar Pérez¹ and J.M. Christian Bastien²

¹ Université de Montréal, Canada

² Université Paul Verlaine – Metz, France

Abstract. We describe the signs of Collaborative Ideation (CI) that have been observed in face-to-face design settings using two methodological tools, the CI Loop and the Design Flow pattern. The CI Loop, which includes body gestures, was first observed in this study and captures the participants' design conversation while collaborating. The Design Flow assesses the designer's experience while designing. The main goal is to better understand collaborative ideation, from the user's experience point of view, in order to better assess collaborative design tools. We present two protocols (short with students; long with professionals) done in the Hybrid Ideation Space (HIS), a face-to-face CI tool. The HIS has previously been evaluated and compared to traditional and digital tools, and appears to enhance the collaborative ideation process. This study also proposes an eventual relationship between CI Loop and Design Flow pattern at micro (during a minute) and macro levels (during a longer period).

Keywords: Collaborative ideation, Design Flow, CI Loop, Hybrid Ideation Space

1 Introduction

Vital signs in medicine traditionally refer to body temperature, blood pressure, pulse and respiratory rate. They show the more basic body functions that are used to detect medical problems. In design research, there is a lack of recognized vital signs to assess the essential aspects of the design activity. This can become an important problem because improperly assessed collaborative design tools affect designers' basic functions to the point of choking design creativity.

In this article, we present two methodological tools to better observe the activity of collaborative "ideation" (or conceptual design) and capture the information it provides. They could give a new, richer picture of what collaborative ideation (CI) is. One new tool, the CI Loop, is combined here with a former one, the Design Flow pattern. We propose that the role of collaborative ideation's vital signs could help keep tabs on what is going on while the designer is engaged in the CI process. These vital signs could help analyze one of the more important moments of the design

creativity process, like the ideation (when basic ideas emerge), while collaborating, in order to propose more effective collaborative design interfaces.

Having had to evaluate design tools and go deeper on the mechanisms of ideation and collaborative ideation, we have developed two assessment methods: the Design Flow (Dorta, Pérez and Lesage, 2008) and the CI Analysis Grid (Dorta, Lesage and Pérez, 2009). Both of these tools eschew assessing results or efficiency of the task, focusing on what is experienced by the designers during the collaborative ideation process. With Design Flow, we follow the psychological states of the designer throughout the creative process, while the CI Analysis Grid highlights the different elements of the design conversation thus capturing the heart of the collaborative ideation. These methods have exposed recurring patterns over time that can be seen as characteristics of the ideation process (Design Flow pattern) and of the collaborative ideation process (CI Loop).

We ran an experience of collaborative ideation with design students using the Hybrid Ideation Space (HIS) as playground for this study. This tool was developed to allow the designers to be inside their representations generating immersive freehand sketches and physical models in real-time and at life scale (Dorta, 2007). The effectiveness of this tool for ideation (Dorta, Pérez and Lesage, 2008) and collaborative ideation (Dorta, Lesage and Pérez, 2009) was evaluated in several contexts and by different users. The overall results show that the HIS seems to improve the collaborative ideation.

The aim of this study is to see how the designer's experience evolves not only through the design creativity process but this time through collaboration. This was achieved by looking at how the CI Loop and the Design Flow pattern were related. With the design student protocol, their 20-minute sessions did not yield enough fine-grained information to attempt to make this link. So we revisited the video recordings of a prior experience we did with two professional designers while designing a real-life project over two 3-hour sessions. The results point toward an eventual

relationship between the CI Loops and the Design Flow at micro (during a minute) and macro levels (during a longer period of ideation).

2 Collaborative Ideation

In order to exteriorize verbally and visually an idea (Goldschmidt, 1990), designers need qualitative and ambiguous mental images and external visualizations in a continuous interaction (Visser, 2006). Typically, designers see more in their sketches and physical models than what they put in when they made them (Schön, 1983). They often work with incomplete information, assuming and taking provisional decisions that need to be revisited. Inaccuracy (flexibility), ambiguity (alternative meanings), and abstraction (simplification) are the main characteristics of this kind of reflective representations (Goel, 1995).

Furthermore, designing is considered a social process (Buccarelli, 1988). Teams discuss and negotiate between participants whose representations of the design are not aligned, and they do so by respecting the ambiguity while fostering a design conversation between the parties.

Verbal communication is considered to be the first design tool and the principal way of explaining ideas, even before visual representations (Jonson, 2005). In a collaborative work setting, the designers communicate their ideas to others using verbal communication, gestures and physical and graphical representations. Verbalization on its own or in combination with other design tools drives ideation and is the most common means of externalizing design intentions (Jonson, 2005). The strength of verbalization relies on words, in face-to-face settings or in computer-mediated environments (Lawson and Loke, 1997). Words are more than just medium for communication: they are part of the thinking process. Creativity and information exchange are mediated by the social nature of design. And in turn, the collaborative and social aspects of design are supported by verbalization (Cross and Cross, 1995).

2.1 Assessing Collaborative Ideation

Cognitive science and design theory have studied ideation, with controlled lab experiments mostly concerned with task execution, and through experiments using idea generation methods. There are two approaches in order to evaluate the effectiveness of ideation: process-based that measures the process of ideation, and outcome-based relating to the results (Shah and Vargas-Hernandez, 2003). For the first

approach, data collection comes from protocol analysis. However, this approach is often unfortunately based on simple problems or tasks as opposed to real design issues (Shah and Vargas-Hernandez, 2003). On the other hand, the outcome-based approach is questionable because it is based on the designer's performance. Evaluating the results of ideation is hard because it depends on the designers practice and capabilities, which rely on subjectivity.

2.1.1 Design Flow pattern

Design Flow (Dorta, Pérez and Lesage, 2008) is a new process-based approach evaluating ideation from the user's experience with the design tool. This method can provide insights on how designers experience ideation while designing. Design Flow is based on Csikszentmihalyi's concept of Flow (Csikszentmihalyi and Csikszentmihalyi, 1988) that allows us to observe the varying psychological states of the user throughout the ideation process. Flow is a complex psychological state that describes a perceived optimal experience characterized by engagement in an activity with high involvement, concentration, enjoyment and intrinsic motivation. According to Csikszentmihalyi and Larson (1987; Csikszentmihalyi and Csikszentmihalyi, 1988), the flow state is determined by the balance between challenges and skills. The relation between perceived skills and challenges gives eight possible dimensions (Massimini and Carli, 1986): apathy, worry, anxiety, arousal, flow, control, boredom, and relaxation (see Figure 1). We use the user's psychological states as barometer, reflecting on the perceived success of the ideation from the point of view of the designer, thus avoiding the subjective pitfall of evaluating the quality of the results.

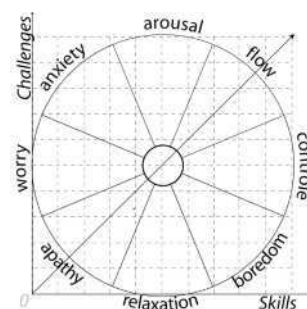

Fig. 1. The flow wheel showing the eight dimensions resulting from the balance between the perceived *challenges* and *skills* (eg. high challenge and high skills = flow).

We have observed (Dorta, Pérez and Lesage, 2008) that during the ideation process, the designer proceeds through a predictable pattern of psychological states. At the onset of ideation, designers experience stressful states (worry, anxiety and arousal). We attribute this to

the process of giving form to unknown ideas. Once the process is engaged and the concepts are starting to form, the designer's experience alternates from arousal to flow, entering flow with every satisfying result.

Once a concept is identified, her/his experience will alternate between flow and control. If being in the flow can be a sign of good performance, on its own it doesn't account for the whole process. This progression from more stressful to less stressful states transiting through flow is what we consider as the Design Flow pattern.

2.1.2 CI Loop

To observe collaborative ideation, we had to pay attention to the design conversation, which led us to develop the CI Analysis Grid (Dorta, Lesage and Pérez, 2009). This methodological instrument is a composite grounded in Bucciarelli's design as social process (Bucciarelli, 1988), Schön's reflective conversation (Schön, 1983) and Goldschmidt's graphical representation of concepts and actions (Goldschmidt, 1990). We developed this analysis grid based on five elements common in the analysis of the design conversation and design process among those three authors: *naming*, *constraining*, *negotiating*, *decision making* and *moving*.

Designers will be *naming* things, outlining a common concern, *constraining* the project through requirements or boundaries (time, budget, constraints), *negotiating* or articulating verbal meanings associated to visual images. They will be *making decisions*, and *moving* (making a design move), such as adding to the representation and making pointing and sketching gestures towards the representation. The first four actions are usually in the form of verbal exchange, while the moving is characterized by an act, an operation, which transforms the design situation (Goldschmidt, 1990; Valkenburg and Dorst, 1998). Gestures (pointing with hand or laser pointer, or through body movement) complement the verbal exchanges, but like design moves they also push the design forward (by drawing a new shape in the air, for example) (Visser, 2010). We have used the CI Analysis Grid to identify these five elements, to see how they appeared in what configuration and their relationship with gestures.

The CI Loop was observed for the first time in this study. Once we had coded every action in the CI Analysis Grid, we noticed a recurring pattern much like the notes in a musical scale going from high to low pitch, with a few different variations. We have identified this pattern as a loop of design conversation; therefore we refer to it as the CI Loop.

The parameters of this loop are as follow: it has to involve both participants to be collaborative, it starts

with either a naming or a constraining action and it is resolved by either a decision making or a moving action. CI Loops were observed in three lengths, short (0-30 seconds), medium (30-60 seconds) and long (longer than 60 seconds). The short CI Loops are typically a quick exchange with fast agreement, while the medium and long loops involve longer negotiating and constraining exchanges (see Figure 2).

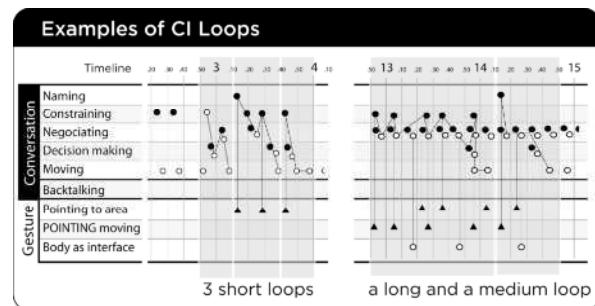

Fig. 2. The CI loop

Even though other studies related to designer's behavior try to understand the cycle of actions in collaborative design (Peeters, et al. 2007), there is no detailed approach focusing on the *collaborative ideation*.

3 The Hybrid Ideation Space (HIS)

We have used in this study the HIS, which was developed to support ideation (Dorta, 2007). The HIS allows the designers to sketch and make models all around them in real-time and in life-size scale providing a sense of immersion and presence (see Figure 3).



Fig. 3. The Hybrid Ideation Space (above and inside views)

It is possible to make *Immersive Sketching* with a tablet laptop displaying the sketch through an immersive projection device. In this device, a spherical distorted perspective is projected through a ceiling-mounted spherical mirror that reflects it over a semi-spherical screen as the designer sketches. This allows him/her to perceive a normal perspective because of

the *trompe l'oeil* effect. The HIS software resolves this deformation allowing the designers to sketch on a normal perspective on the tablet laptop. *Immersive Model Making* captures a real-time video of scaled physical objects (easily manipulated and serving as symbolic models) using the same strategies for the deformation and displays it life-size through the immersive device. The two techniques are often used in combination, designers drawing over the representation of the physical model.

As previously stated, the effectiveness of the HIS for ideation (Dorta, Pérez and Lesage, 2008) and collaborative ideation (Dorta, Lesage and Pérez, 2009) has been evaluated and compared to other design tools in several contexts (industrial and interior design), time settings (short and long periods) and by different users (design students and practitioners). Even considering some problems regarding quality and distortion of the images at the early stages of the HIS development, the results have shown that the HIS appears to improve collaborative ideation during short and long periods in face-to-face settings.

4 The Experiment

4.1 Sampling

For this study, we used two different experiments with two different samplings: one was done with 38 industrial design students, and the other with two professional interior designers. Students were in their 2nd year of industrial design. They worked in teams of two, most of them for the first time together. In this study the student's project was geared towards a design competition. They had to design *the body of a rally winter car*. Their major constraints came from the car's chassis, which was already designed for the competition.

The professionals had been working together for at least two years. One was a junior, the other a senior designer; the junior designer was in charge of the project; the senior was participating as a mentor, which created a balance in their way of working. Their project was to design *a lounge in a hotel lobby*. As they worked, they kept in mind the constraints of the project like budget, clients and timeframe as well as the consequences of a possible failure.

The choice of these two different samples was made because the student protocol was limited to 20 minutes per team for group size and facilities constraints (the HIS allows up to four people). The 20-minute observations did not provide enough detail to observe the evolution of the experience over time. Thus, we *revisited* the videos of a previous protocol

with professionals, which captured a longer period of time. The goal was not to compare both protocols but to see the professional one as a case study to better observe what was suggested in the students' short protocol.

The results of 5 unevenly match students teams were not considered in the context of this study because, being uneven, they did not collaborate and their results were equivalent to a half of an even team.

4.2 Experimental Setting

The study was done in a face-to-face setting (synchronic and co-located). Students and professionals had access to the HIS in order to develop a concept. The students' setting consisted only in two 20-minute sessions, in view of the above protocole limitations. We videotaped each session. During the first session, they learned how to use the HIS (5 minutes) and they furthered their concept. The students entered the HIS with a freehand mock-up of the car body made of Styrofoam and in the second session, with a Rapid Prototype model. This was part of the class requirements. In both cases, the scaled models were worked upon using the *Immersive Model Making* technique. This allowed them to switch from the mock-up to the life-size projection, allowing them to correct proportion mistakes.

The setting for the professionals consisted in two sessions of 3 hours each, which was fitting for their professional responsibilities. This was not possible for the students because of the amount of subjects (38) and the class schedule. With the professionals, the greater amount of time enabled us to do post-experiment interviews and administer questionnaires at the pause and at the end of each sessions. Of the 3 hours allocated for the experiment 2h20 were spent working in the HIS (a first half of 75 minutes, a pause and a second half of 65 minutes). All work sessions were videotaped. While in the HIS, they sometimes worked from a rough symbolic mock-up made of Foam-core and sometimes drew over a 3D digital model used as a template.

Both projects (students and professionals) were in the ideation phase. While inside the HIS, both team members were engaged in the design process, one drawing with the digital pen while the other used a conventional laser pointer. The digital pen left permanent traces whereas the gestures with the laser pointer left ephemeral ones. The participants worked standing, moving and gesturing freely. The freedom of movement combined with the life-size representation supported verbal communication between teammates as well as gestures.

4.3 Data Collection Techniques

Different techniques were used in this study. Design Flow called for two techniques to capture the Flow and its neighbouring states: a simple questionnaire collecting the experienced states after each continuous work session, and the Experience Sampling Method (ESM) (Csikszentmihalyi and Larson, 1987) used during the professionals’ longer work sessions.

In the student protocol, once the 20-minute work session was over, the students had to individually identify their psychological states at the beginning, middle and end of this period. After every half-session, the professionals also identified retrospectively the dimensions of their experience.

Flow is a fleeting state. Since the professionals had longer work sessions in the HIS, we were able to collect data with the ESM. Every 10 min or so, while in session, participants were asked to call out their state. This allowed for in-the-moment experience sampling. We asked the participants to tell what their state was at a given moment because they were aware of how they were feeling. The participants were explained before hand what is the Flow and its seven related psychological state. All they had to do is identify with one of eight words how they felt. We are conscious that this interrupts the design process but reviewing the videos with the participants to get their states afterwards was not possible with these professional participants.

The CI Analysis Grid was used to code the data collected on the video recordings of the students’ and professionals’ work sessions. This Grid yielded two different sets of data: a CI Loop counts as well as a breakdown of the collaborative ideation actions that occurred during the CI Loops.

5 Results

5.1 Design Flow Pattern

5.1.1 Student protocol

Data was analyzed from the means of frequencies of the groups. Figure 4 shows how the students have rated three moments of their experience: the beginning, middle and end of the first session. As can be seen from this figure, the distribution of the frequencies tends to move from left to right. In other words, participants tend to move from a state of anxiety to a state of Flow during this first session. Specifically, at the beginning of the session, anxiety prevailed while Flow dominated in the middle and end of this session. To test whether the distribution of the

choices made by the participants statistically changed from the beginning to the end of the session, a Friedman test, which is adapted to repeated measures, was computed. This non-parametric test uses the ranks of the data rather than their raw values to calculate the statistic. When applying this test, we made the assumption that the experience dimensions represented an ordinal scale in the design process. The results of the Friedman test indicated that the distributions across the three repeated measures (beginning, middle, end) are different ($\chi^2(2, N = 37) = 20.936, p < .05$). The mean ranks were 1.57, 2.07 and 2.42 for the beginning, middle and the end respectively. Wilcoxon comparisons indicated that distribution of the choices across the three moments were different from one another as indicated in Table 1.

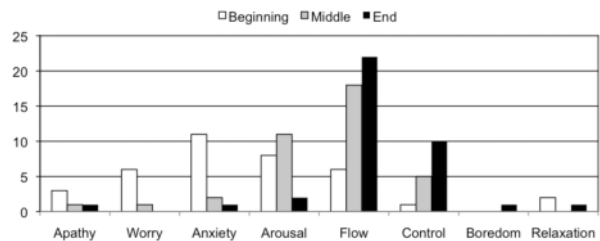

Fig. 4. Distribution of frequencies along the dimensions of experience during session 1

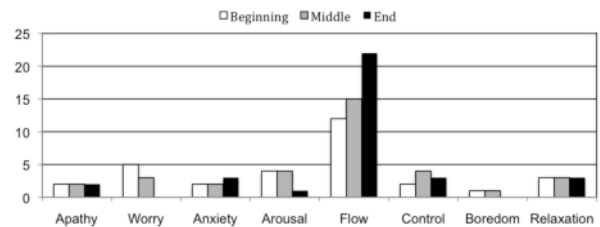

Fig. 5. Distribution of frequencies along the dimensions of experience during session 2

Table 1. Results of the Wilcoxon test

	Middle - Beginning	End - Beginning	End - Middle
Z	-3.238 ^a	-3.895 ^a	-2.543 ^a
Asymptotic significance (bi-lateral)	.001	.000	.011

a. Based on negative ranks

However, during the second session (Figure 5), even though there is a visual discrepancy in the graphic, there was no statistical difference in the distribution of the choice of the dimension of experience from the beginning to the end of the session ($\chi^2(2, N = 31) = 2.225, p > .05$). In Session 2, the participants globally

stay in the Flow state probably because their design concept had been previously identified.

5.1.2 Professional protocol

Figure 6 shows a combination of *in-the-moment* calling of their state (above) and the *retrospective* identification of the various states (below). With these two data we create a picture of the whole session. This dual picture shows an evolution from stressful states (anxiety, arousal, worry) to a combination of arousal and flow, and, at the end, to the less stressful association of flow and control. This can be seen within both sessions. Here, no statistical analysis were conducted due to the very small number of participants. However, this data confirms what was observed in a previous study (Dorta, Pérez and Lesage, 2008), and we attribute it to the fact that the designers went from no specific idea to an identified concept. The purpose here is to observe the punctual states taken over time and the retrospective assessment of the same period. Caught in the moment, they called one or two states, whereas in retrospective, they identified a rich array of states. Either in the time between requests, or at different levels of consciousness, they apparently experienced other states. This raises the question of how do these two readings link. The CI Loop is perhaps part of the answer.

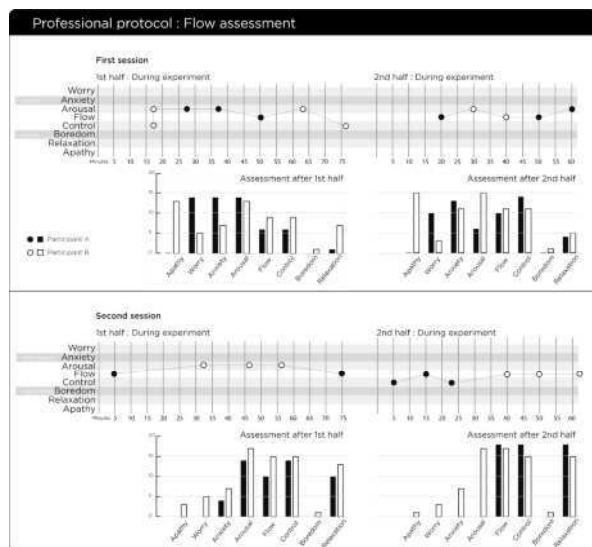

Fig. 6. In-the-moment and retrospective flow assessment (professionals)

5.2 The CI Loop

5.2.1 Student protocol

When we look at the breakdown of the elements within the CI Loops in the student protocol we first

find that globally, the average number of actions does not increase statistically from the first ($M = 129.54$; $SD = 46.22$) to the second session ($M = 132.31$; $SD = 34.184$) ($t(12) = -.18, p = .864$). From the first to the second session only two action dimensions change statistically: Naming ($t(12) = 2.33, p = .038$) and Constraining ($t(12) = -.18, p = .864$). The number of actions in the naming category decreases on the average from 8.21 ($SD = 12.57$) to 4.08 ($SD = 6.37$). In the constraining category however, the number of actions increases from 18.57 ($SD = 11.39$) to 29.85 ($SD = 17.03$) on the average. In the first session, paired t tests indicate that the number of actions in the Negotiating ($M = 43.43$; $SD = 25.22$) and Moving ($M = 45.79$; $SD = 14.1$) dimensions does not differ statistically ($t(13) = -.35, p = .734$). However, the number of actions in the Negotiating dimensions is higher than the number of actions in Decision Making ($t(13) = 5.20, p = .000$), and Moving ($t(13) = -9.95, p = .000$). In the second session, things are a little bit different. The Moving dimension, which has the greatest number of actions ($M = 42.92$; $SD = 12.37$) does not differ from the number of actions in the Negotiating dimension ($M = 39.69$; $SD = 19.29$). However, the number of actions in the Moving dimension is greater than all the other dimensions according to the t tests. (Figure 7).

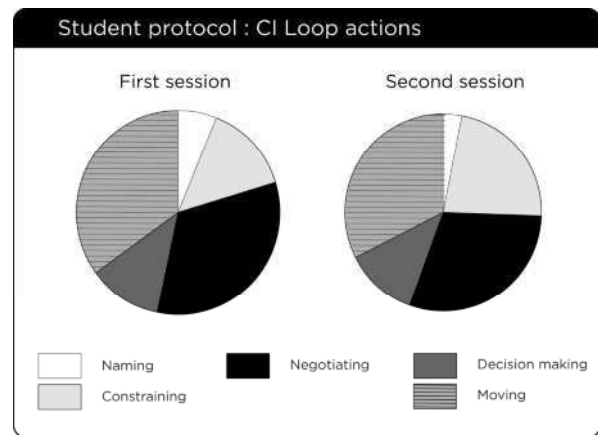

Fig. 7. The CI loops actions (students)

One notable fact is that the Negotiation and Decision Making pattern do not change from one visit to the next.

5.2.2 Professional protocol

On the other hand, with the professional, we found the opposite situation where there was more Moving actions at the last session, than in the first session (Figure 8). Furthermore, there was more Constraining and Naming (together) at the beginning. Apparently, these actions were used to define the project at first.

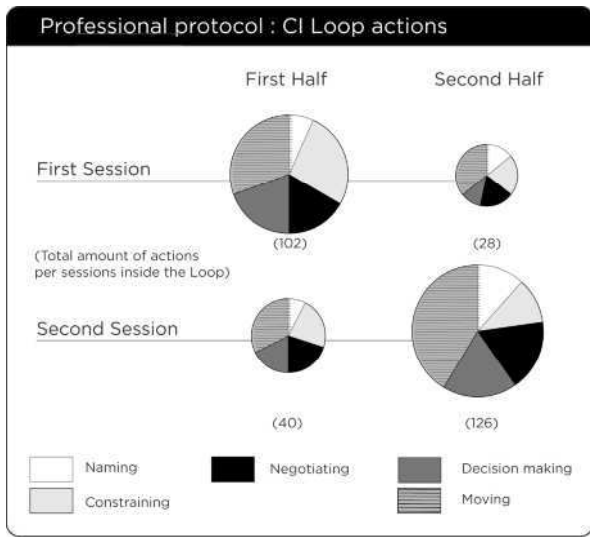

Fig. 8. The CI loops actions (professionals)

5.2.3 CI Loop types

The first session saw a greater amount of short loops (0-30 sec) and the end sessions, longer ones (30-60 seconds). This is true for both students and professionals (see Figure 9 and 10). This can be interpreted as the participants getting used to the HIS and the timeframe, getting more confident about the experiment, and into a good collaborative rhythm where both students and professionals were comfortable voicing their opinions in the face of design problems.

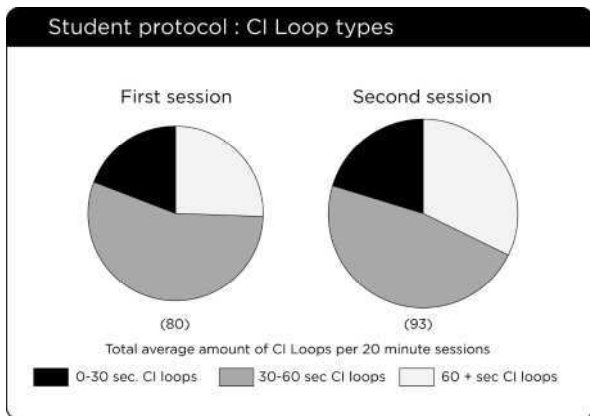

Fig. 9. The CI loops types (students)

Professionals had a greater number of collaborative ideations at the beginning, followed stretches of individual ideations (which is why there are fewer CI Loops) with a burst of CI Loops at the end of the experience, as if they were in a final sprint (see Figure 10).

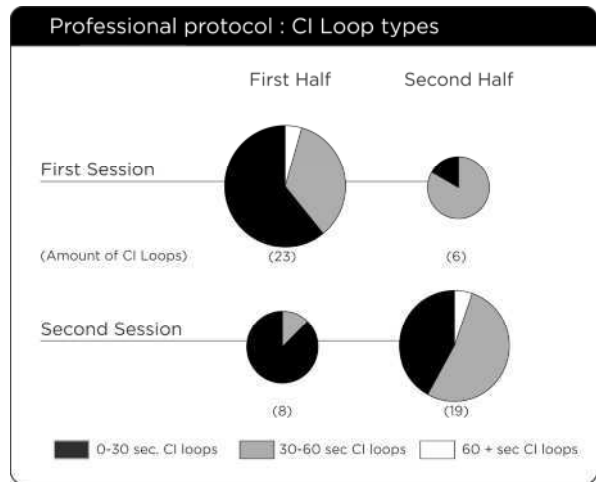

Fig. 10. The CI loops types (professionals)

6 Conclusions

Considering the methodological limits of this study, we can interpret these results as follows: once a design decision has been reached (after a cycle of naming, constraining and negotiation) the designers launch into a sequence of moving. Frequently between CI Loops there are long stretches of moving, where design representations are being produced. We have so far observed that within one continuous stretch of moving, the designer will be in the same psychological state, be it flow or control. This stretch of moving will push the design further until a new aspect of the concept needs to be addressed or frustration arise, which will call for a new iteration of the CI Loop (see Figure 11).

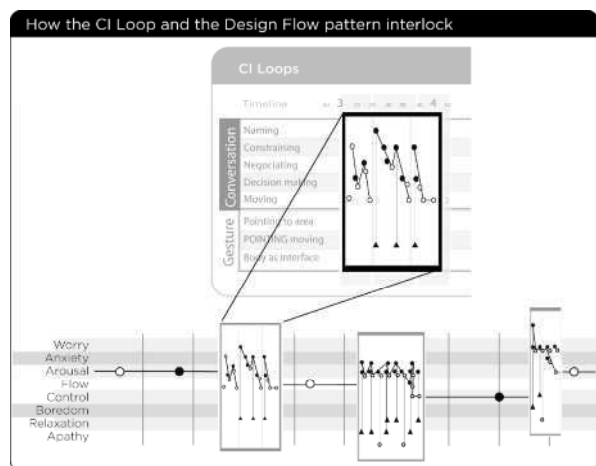

Fig. 11. The CI loops and design flow sequence

Like the electrocardiogram of a cardiac cycle, in Figure 11, the CI Loop can be seen in the close-up

view inside the Design Flow pattern while collaborating, thus showing how the designer's experience changes over time.

However, the findings of this study have to be considered as a new working hypothesis that needs to be confirmed. To do that, methodological limits must also be overcome to obtain a finer-grained measure of the psychological states without affecting the experience or the task itself, truly associating the information found in the CI Loops and the Design Flow pattern.

Besides, the fact that in the retrospective identification of psychological states, professionals revealed a rich range of states, raises other questions regarding the Design Flow pattern: Are designers feeling more than one psychological state in a given moment of the process or are these states changing quickly? Do we need to let the designers select several states in a given time, as observed once in the professional protocol? Are they really maintaining the same state for long periods? What exactly are the psychological states that relate to the CI Loop?

As for this last question, the results of this study hint at a possible connection between the Design Flow pattern, witnessed here at the macro level, and the pattern of psychological states accompanying the CI Loop at the micro level. For instance, Figure 7 (student protocol) shows that negotiations were a large proportion of the actions in the first session. Figure 4 shows a significant number of stressful states, centring on anxiety, for the same moment. This would associate the early actions such as naming, constraining and negotiating to worry and anxiety. The relationship of decision making and moving to flow and control was present through the professionals' protocol: Figure 8 shows the decision making and moving actions to be dominant at the second half of the second session, at which time, Figure 6 clearly shows flow to be the dominant experience for these participants. This would be in accordance to the Design Flow pattern that goes from more stressful states at the beginning of the CI Loop and finishing with less stressful states when a decision over a concept is made or while moving and representing it. If this link proves to be true, this insight regarding the collaborative ideation experience could help the development of new, more efficient collaborative design interfaces and stronger methodological approaches dealing with the *black box* archetype of design creativity.

The CI Loop can be seen as a new methodological tool to observe modularity, iteration and performance in collaborative design. Based on former research in design theory (Buccarelli's design as a social process, Schön's reflective conversation and Goldschmidt's graphical representation of concepts), and being linked to the designer's experience (Design Flow), it is a

combined approach that could better analyze the signs of collaborative ideation.

The exact influence of the HIS on the design creativity process is still unclear, although it seems to act as an amplifier, augmenting design conversation and ideation. It may also influence differently students and professionals.

References

- Buccarelli L, (1988) An Ethnographic Perspective on Engineering Design. *Design Studies* 9(3):159–68
- Cross N, Cross A, (1995) Observations of Teamwork and Social Processes in Design. *Design Studies* 16(2):143–70
- Csikszentmihalyi M, Csikszentmihalyi I, (1988) *Optimal Experience: Psychological Studies of Flow in Consciousness*. New York: Cambridge University Press
- Csikszentmihalyi M, Larson R, (1987) Validity and Reliability of the Experience Sampling Method. *Journal of Nervous and Mental Disease* 175(9):526–36
- Dorta T, (2007) Implementing and Assessing the Hybrid Ideation Space: a Cognitive Artefact for Conceptual Design. *International Journal of Design Sciences and Technology* 14(2):119–33
- Dorta T, Lesage A, Pérez E, (2009) Design Tools and Collaborative Ideation. In *Proceedings CAADFutures 2009*, PUM:65–79
- Dorta T, Pérez E, Lesage A, (2008) The Ideation Gap: Hybrid Tools, Design Flow and Practice. *Design Studies* 29(2):121–41
- Goel V, (1995) *Sketches of Thought*. Cambridge, MA: MIT Press
- Goldschmidt G, (1990) Linkography: Assessing Design Productivity. In *Proceedings of Cybernetics and System '90*:291–98
- Jonson B, (2005) Design Ideation: The Conceptual Sketch in the Digital Age. *Design Studies* 26(6):613–24
- Lawson B, Loke S, (1997) Computers, Words and Pictures. *Design Studies* 18(2):171–83
- Massimini F, Carli M, (1986) *La Selezione Psicologica Umana tra Biologia e Cultura*. In *L'esperienza quotidiana*. Milan: Franco Angeli
- Peeters A, van Tuijl M, Reymen I, Rutte C, (2007) The development of a design behaviour questionnaire for multidisciplinary teams. *Design Studies* 28(6):623–643
- Schön D, (1983) *The Reflective Practitioner: How Professionals Think in Action*. New York: Basic Books
- Shah J, Vargas-Hernandez N, (2003) Metrics for Measuring Ideation Effectiveness. *Design Studies* 24(2):111–34
- Valkenburg A, Dorst K, (1998) The Reflective Practice of Design Teams. *Design Studies* 19(3):249–71
- Visser W, (2006) *The Cognitive Artifacts of Designing*. Mahwah, NJ: Lawrence Erlbaum Associates
- Visser W, (2010) L'utilisation du geste dans des réunions de conception architecturale. In *Proceedings of DRS2010*: Montréal, In press

Design Process and Cognition 2

Creativity: Depth and Breadth

Barbara Tversky and Juliet Y. Chou

Research Methodology for the Internal Observation of Design Thinking through the Creative Self-formation Process

Yukari Nagai, Toshiharu Taura and Koutaro Sano

Design as a Perception-in-Action Process

Katja Tschimmel

Verbal Stimuli in Design Creativity: A Case-study with Japanese Sound-symbolic Words

Céline Mougenot and Katsumi Watanabe

Creativity: Depth and Breadth

Barbara Tversky and Juliet Y. Chou
Columbia University, USA

Abstract. Creativity is an elusive concept. Indeed there are those who believe it cannot be studied as if the heat of the microscope would destroy the specimen. Nevertheless, it is accepted by many that at a minimum creativity entails the generation of ideas that are both original and appropriate. Creativity, then, entails both divergent and convergent thinking. Here we investigated divergent and convergent thinking in a task in which participants are asked to provide many interpretations of ambiguous suggestive sketches. Switching attention among the sketches encouraged divergent thinking whereas focused repeated attention to interpreting a single sketch encouraged convergent thinking.

Keywords: design, problem solving, convergent, divergent, fixation

1 Design as Problem Solving

1.1 Insight and Incremental Problems

Design thinking is a kind of problem solving (e. g., Simon, 1969), but unlike the sorts of problems studied in the laboratory. Typically, in the laboratory, two kinds of problems are studied: insight and incremental (e. g., Metcalfe and Wiebe, 1987). Insight problems are like those that faced Kohler's chimpanzee, Sultan. He was not tall enough to reach the banana. After much pacing, he suddenly picked up a crate in his cage, moved it under the banana, stood on the crate, and reached the banana. In solving such problems, people--and chimp--often try many different unrelated directions, until a sudden flash of insight brings together the elements needed to solve the problem. The flash that solves the problem comes without any prior intuition that a solution is imminent (Metcalfe and Wiebe, 1987). Similar to magic tricks, the solutions to insight problems are typically in no way related to the other directions pursued. Like the insight problems studied in the laboratory, design problem solving often requires insight, and in fact, requires insight often, but rarely will a single flash bring together all the elements of the problem in a single solution. Successful design also requires the incremental thinking involved in systematically

satisfying the design constraints, in molding an overall idea to specifics.

In contrast, solutions to incremental problems usually resemble an interlinked set of steps, one following from another, as in solving algebra or chemistry problems. Typically, the various directions explored, some more successful than others, are related, and build on each other. Design problems are complex, and ordinarily involve both insight and incremental problem solving, that is, both divergent and convergent thinking (e. g., Guilford, 1967). Like the incremental problems studied in the laboratory, design problems require chains of incremental steps, one leading to another, but rarely will a single interlinked chain be sufficient for solution. Design problems do not have a single goal and consequently they do not have a single solution. Rather, design problems have a set of constraints, some more important than others, some that conflict and some that are consonant. Typically many different configurations can suit the constraints of the design problem, so that, typically, design problems have a large set of possible solutions, sometimes called a solution space in problems solving (Simon, 1969).

There are many possible ways to design a chair or a library or a network of streets or an information system. A chair needs to be of a height and strength to support sitters comfortably. Beyond that, it may or may not need to be stackable, it may or may not need to be in a specific price range or a particular style, it may or may not need to be manufactured in a particular place, it may or may not need to be made of particular materials. Chairs are designed differently for offices than for homes, for indoors than for outdoors, for children and for adults. The kind of office or home or indoors or outdoors will also affect the design. Yet, a multitude of chairs could fit these kinds of constraints, leaving many creative options open to designers.

Designs, even of abstract entities like information systems, are often described using terms like *elegant*. An elegant design seems to be one that is simple and transparent on the one hand and on the other, fits many disparate desiderata of the design problem.

Breuer's chairs are elegant because a single piece of sensuously curved metal serves as the legs of the chair as well as the framework for its seat, and back. Jacobsen's chairs achieve elegance by using a smooth and light piece of bent wood as seat and back and by supporting the seat and back with metal legs that beautifully balance the curve of the shell and also allow easy stacking. Starck's Louis Ghost chair for Kartell is of molded plastic, cheap and light. It adds a bit of whimsy in its post-modern decorative features, as if to say: I could be Louis XV but I prefer not to be.

1.2 Divergent and Convergent Thinking

One of the truisms, discovered and rediscovered, about creativity in design is that it requires both divergent and convergent thinking (Guilford, 1967). Divergent thinking is needed to produce a wide range of different fundamental ideas. The belief is that if enough ideas are generated, some will be innovative as well as meet the constraints of the problem. Divergent thinking is thought to yield the remote associations that, for insight problems, may provide a key. A common way to generate many ideas is to lower the criteria, to relax the constraints, to take only one or two or two of them on a flight of fancy. For Kohler's ape to think of a crate as something to stand on to reach higher meant relaxing the constraint that the crate was for storage and to see it as a height-enhancer. Another way to encourage divergent thinking is to begin the flight of fancy not with a design constraint at all, but with an idea that seems unrelated, the skeleton of a bird for a bridge, the shell of snail for a school. These flights of fancy may lead to original ideas but there is no guarantee that the ideas can be molded to the constraints of the design problem.

Convergent thinking is thought to do that fitting, to mold vague ideas to the constraints of the problem. Convergent thinking involves the same kind of step-by-step interlinked moves that are needed to solve incremental problems. However, for solving routine problems in chemistry or in algebra, for assembling a piece of furniture or for operating a piece of equipment, the steps and links are often given. The problem solving may involve properly abstracting the given problem and then selecting the appropriate solution, often anything but straight-forward. Not so in design. Design problems are typically far less structured. The designer needs to determine the steps and parts and to determine how they are configured or linked. Nevertheless, even an ill-defined problem like design will have stages of design where parts of the solution will be integrated and interlinked.

By this analysis, divergent thinking demands relaxing design constraints whereas convergent thinking entails conforming to them. Divergent and

convergent thinking, then, are quite different, and a good designer, and, for that matter, a good problem solver, needs both. Divergent thinking can expand the range of ideas under consideration; convergent thinking can provide coherence and viability to them. In classroom exercises, students are often encouraged to first diverge, that is, to generate as many different ideas as possible, and then to converge, that is, to consider individual ideas one at a time in detail. However, in real cases, designers diverge and converge iteratively. Both kinds of thinking, both kinds of creativity are needed for design.

1.3 Fixation: Convergent Thinking?

Another truism about design in particular and problem solving in general is that designers and problem solvers tend to get fixated; that is, they get stuck on ideas that seem not to be promising, usually in hindsight, but nevertheless, continue to attempt to fit them to the problem rather than exploring other possible solutions that may be more promising. Fluidity in producing many ideas is one desideratum for design. Fixation seems to be the opposite. But could we take a different perspective on fixation? Might convergent thinking lie at the core of fixation? That is, designers or problem solvers may persist in directions that after the fact seem to be dead ends because they are trying to mold the idea to the problem constraints, trying to formulate and configure parts to a coherent and successful whole? This is exactly the kind of thinking that convergent phases of design require. One can further imagine that this persistence might, in the hands of a gifted designer, succeed. We all know legends of lone problem solvers who persisted in directions others ridiculed and were rewarded.

In common with other thinkers, designers often use cognitive tools, notably, sketches. Cognitive tools serve thought in numerous ways, among them: they off-load limited working memory, facilitate information processing, extract the essence of complex problems, allow spatial thinking to substitute for abstract thinking, enable easy revision of ideas, and support a multitude of inferences (e.g., Norman, 1993; Tversky, 2001; in press). Importantly, designers often report getting new ideas from reexamining their own sketches (e.g., Goldschmidt, 1995; Schon, 1983; Suwa, Gero, and Purcell, 2000; Suwa and Tversky, 2003; Suwa, Tversky, Gero, and Purcell, 2001). One task that has been used to study fluidity and fixation is to ask people to generate as many ideas as they can for interpreting ambiguous sketches (Howard-Jones, 1998; Suwa and Tversky, 2003). We turn now to a study using that task.

2 Study: Generating Ideas

2.1 Thinking With Sketches

As noted, creative thinking is aided by cognitive tools. Such tools expand the mind by abstracting and externalizing ideas and by providing a platform for the manipulations, mental or external, that are necessary for comprehending, thinking, and problem solving (e. g., Norman, 1993; Tversky, 2001, in press).

For designers, sketches are the time-honored cognitive tool, though now computer screens frequently replace pencil and paper. Designers report having a kind of conversation with their sketches, drawing them, inspecting them, finding new things in them, and redrawing, a productive cycle that enhances design (e. g., Goldschmidt, 1994; Schon, 1983; Suwa, Tversky, Gero, and Purcell, 2001). The sketches designers prefer, especially in the early stages of design, are ambiguous ones, sketchy ones, as they allow and indeed foster the kinds of mental or actual manipulations needed for generative and flexible thinking. When shapes and configurations are specified only vaguely, it is easier to mentally reconfigure them and to discover new meanings and interpretations and to thereby alter designs.

Because ambiguous sketches are the preferred cognitive tool for designers, we began with those in our exploration of convergent and divergent thinking. To that end, we borrowed and adapted a paradigm of Suwa and Tversky (2003), who in turn, borrowed and adapted a paradigm of Howard-Jones (1998). In the research of Suwa and Tversky, participants were shown the ambiguous sketches in Figure 1, one at a time, and asked to generate an interpretation. They were then shown the same figure and asked to generate another interpretation. The procedure was continued until participants could not generate another interpretation, presumably when they were fixated, at least for the moment.

The task was actually designed to examine divergent thinking and fixation. Some of the interesting findings were that people good at an embedded figures task, namely detecting simple figures in complex ones, as well as people good at finding remote conceptual associations were better at finding new interpretations and reducing fixation than those less talented at those skills. Designers were better than non-designers, producing more associations and at a more constant rate, that is, avoiding fixation. Designers reported that mentally reconfiguring the patterns in the sketches helped them to think of new interpretations, a strategy reported by expert designers in an actual design task (Suwa, Gero, and Purcell,

2000; Suwa, Tversky, Gero, and Purcell, 2001; Tversky and Suwa, 2009).

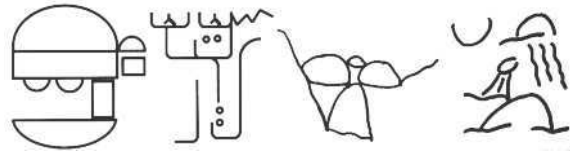

Fig. 1. Four figures used by Suwa and Tversky (2003) and in the present study.

In the previous experiments using these stimuli, participants were shown one ambiguous sketch repeatedly. On each trial, they were asked to provide a new interpretation of the sketch. They did this until they were unable to come up with a new interpretation. Traditionally, the failure to come up with a new interpretation is regarded as fixation. The assumption is that there are many other possible interpretations but that for whatever reasons, participants cannot produce other interpretations. One likely reason for fixation is that the ideas already produced interfere with thinking of new ones. The ideas produced are strong associations to the sketch.

If we regard interpretations as associations, and in many senses interpretations are exactly that, then these findings are similar to findings in the memory literature. In experiments in which people are supposed to learn a long list of unrelated words, it turns out that recalling a subset of them actually interferes with recalling the entire set, a phenomenon known as part-list cuing (Roediger, Stollon, and Tulving, 1977). It is as if the associations within the part of the list cue each other and don't cue the rest of the items in the list. Another analog is languages: the words within a language have strong associations to each other, but are typically not tightly associated to the words in another language, which are more tightly linked to each other.

The challenge, then, is to break the set of associations to an individual sketch in order to come up with others. A clue for doing that also comes from research on memory and associations, namely to vary the stimulus item, in this case, the sketch, rather than block them. The premise is that any particular stimulus, a word, a story, an event, or in this case, a sketch, will arouse a set of associations. The associations vary in strength or probability to the stimulus. For example, *chair* is a strong association to *table*, and *dancing* is a weaker one, though even tables can support some amount of dancing. Associations shift and often dissipate with time, allowing different associations to emerge. New associations can also be

facilitated not just by passage of time, but by other experiences, which will have different associations.

With these findings in mind, for one group of participants, we presented the sketches blocked, one sketch repeatedly followed by each of the other sketches in turn, as in the previous research. For another group of participants, however, we presented the four designs in random order. The expectation was that those in the random group would produce more different associations for two reasons. First, the time between appearances of the same sketch would be greater, allowing old associations to weaken and new ones to emerge. Second, the intervening sketches should evoke a different set of associations, and some of those might be appropriate or related to the other sketches, benefiting finding different interpretations for them. It was also possible that participants might fixate, that is, fail to come up with new interpretations; if so, fixation should be greater for the blocked presentation than for random presentation.

2.2 Method

2.2.1 Participants

Participants were solicited from a website designed for that purpose, Amazon's (ill-named) Mechanical Turk. The participants in Amazon's pool have been characterized extensively in several previous studies: the pool is 55% female with a mean age of 31 (Kittur, Chi, and Su, 2008; Ross, Irani, Silberman, Zaldivar, and Tomlinson, 2010). Participants receive a small amount of money that can depend on the time as well as their performance. In this case, participants were paid \$2 for approximately 15 minutes. Although 40 participants agreed to perform the task, some of them either were not cooperative or didn't understand the instructions; these participants gave the same interpretation multiple times. We decided to eliminate their data from the analyses. Doing so eliminated the same number of participants from each condition so it does not bias the data.

Participants were assigned at random to one of the two conditions, *Blocked* and *Random*. In total, the Blocked group had 14 women and 16 men and the Random group had 12 women and 18 men.

2.2.2 Design

There were 10 presentations of each of the design sketches. In the blocked condition, the 10 presentations of each sketch were blocked together, one after another. In the random condition, stimuli were chosen at random for presentation until each stimulus was presented 10 times.

2.2.3 Procedure

Participants first had 5 practice trials with a sketch not used in the experimental trials. They were told to think of a way that each design could be interpreted, only one or two words, and to type the interpretation into a text box. They were asked to produce a new interpretation every time they saw a design, even if it was the same design. The time between presentation of the design and the initiation of typing of the interpretation was recorded.

2.3 Results and Discussion

First, the participants whose data were analyzed produced new interpretations for each sketch on nearly every trial, so that there was no fixation according to the standard measures. Moreover, most of the interpretations produced were reasonable. Increasing the number of trials for each sketch thereby requiring more new interpretations would likely increase fixation, that is, would lead some participants to fail to produce new interpretations. However, the data on time to produce associations do show some signs of fixation.

2.3.1 Timing of Interpretations

The time taken to produce appears in Figure 2, separate for the random and blocked groups. The pattern for the blocked group shows an initial slow response, comparable to the speed of the random group, followed by relatively rapid responding for a few trials, followed by a third stage, a gradually slowing of responses again reaching the longer level of the random group.

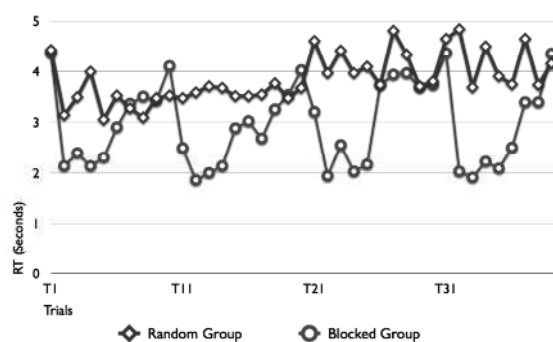

Fig. 2. Time taken to produce interpretations over trials for random and blocked conditions

This interesting repeated U-shaped pattern suggests that participants take some time to come up with an initial interpretation, or theme, but that subsequent interpretations are faster, and then slow down. This, in

turn, suggests that the initial interpretation cues another one, and another one, so the interpretations come faster, most likely because the theme itself suggests related interpretations. That cuing eventually slows down, and then participants search for another theme. This interpretation of the data is consistent with the more detailed analyses of the actual interpretations.

2.3.2. Content of Interpretations: Themes

Because participants produced responses on all of the trials, there was no difference between the random and blocked conditions in number of responses. We needed another way to compare the groups, and inspection of the responses suggested that each sketch elicited a similar set of themes. A theme is characterized by and defined as a related set of interpretations. For example, the sketch on the far left in Figure 1 suggested various kitchen appliances and kinds of robots; the second sketch suggested diagrams and circuit boards, the third suggested rocks, and the fourth, a beach scene or underwater scene.

We therefore coded the responses into themes. The two authors coded the responses blind to the actual conditions. There were a small number (3) of disagreements and those were resolved by discussion. Because each participant provided 10 responses to each sketch, there is by necessity a trade-off between number of themes and number of responses consonant with the theme, the more themes, the fewer number of interpretations per theme.

Each of the sets of interpretations, appliances, robots, diagrams, wiring, rocks, beaches, underwater, was a separate theme. There were a few additional themes. Interestingly, the themes were specific to the sketches, that is, the same themes were produced by many participants to the same sketch, but participants rarely if ever produced the same theme to more than one sketch.

The average number of themes for each sketch and each condition is shown in Figure 3. As is evident from Figure 3, the random group produced more themes than the blocked group for each sketch. This means, of course, that the blocked group produced more ideas for each theme than the random group. The implication is that blocking encourages depth of thought and randomization encourages breadth of thought. Depth of thought is characterized by many interrelated interpretations, exactly what is needed for convergent thinking. Breadth of thought is characterized by many unrelated interpretations, exactly what is needed for divergent thinking.

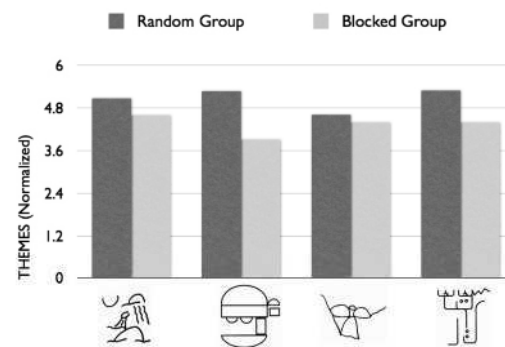

Fig. 3. Average number of themes per sketch for each condition

That the random group produced more themes and the blocked group more related interpretations is consistent with the earlier analysis of associations. Both time and what happens in time will increase the variability of associations to the sketches, so that participants in the random group should think of more different themes than participants in the blocked group. On the other hand, participants in the blocked group produced more ideas related to a particular theme than participants in the random group. Except for one or two cases, each idea related to a theme was different. For example, for the first stimulus in Figure 3, one participant produced: island, volcano, water, whale.

To sum, participants were asked to generate a new interpretation to a set of four ambiguous sketches. They saw each sketch 10 times, and in fact generated a different interpretation on every exposure. The blocked group interpreted the same sketch for 10 trials in a row; the random group was presented with the sketches in a random order. In contrast to previous studies, neither group showed fixation. However, the groups differed in both the temporal pattern of their interpretations and in the quality of their interpretations. For the initial presentation of a sketch, the blocked and random groups took the same time to produce an interpretation. With subsequent presentations of the same sketch, the blocked group got faster, till they had produced about 5 interpretations, and then they slowed down, approaching the speed of the random group by about the 10th presentation. The productions give further insight into that process. The blocked group tended to generate interpretations inspired by the same theme. The random group also generated ideas related to the same theme, but they tended to generate more themes and fewer items per theme.

3 Breadth and Depth: Divergent and Convergent Thinking

Successful designers and other problem solvers need to think both divergently and convergently and to succeed. Often, designers and problem solvers get stuck on one or another idea, and cannot think of others. One way to avoid fixation is to produce many different ideas. This simple experiment, in which participants were asked to generate ten new interpretations for each of four ambiguous sketches has provided surprising and intriguing findings. One intriguing finding is that these desiderata, convergence and divergence, are intertwined and can conflict. Presenting the sketches randomly intermixed enabled participants to produce more different themes than presenting the sketches in blocks. However, presenting the sketches in a block enabled participants to elaborate each theme more deeply, at the cost of fewer themes. Which condition, random or blocked, is better for design, which condition produces more creative ideas? This question is not easy to answer; the answer is probably, it depends.

Producing more unrelated themes is a kind of divergent thinking whereas producing interrelated elaborations of the same theme is convergent thinking. As noted, both are needed and used in actual design. A new theme has the potential to be a completely new design idea. But take note of the word *potential*. Until the idea is fully elaborated, it cannot be known whether it is feasible. Elaborations are a way of testing design ideas. Is it reasonable to interpret the right most sketch in the first figure as a beach scene? Or would some other theme be a better one? Whether an interpretation is good or not depends on the number of elements that fit the interpretation. The fit of an interpretation to a sketch can be discovered only by continuing to explore the idea. The same process, however, can be viewed as fixation, staying within the confines of one interpretation rather than venturing out into others. In the heat of a design session, it is not easy to know whether to persist or to shift, whether to think convergently or divergently. The present study demonstrated conditions that foster divergent and convergent thinking: shifting attention from sketch to sketch fosters divergent thought whereas focusing attention on a single sketch at a time fosters convergent thought. Experienced designers probably implicitly know this, and select the condition that seems to fit their current needs.

References

- Goldschmidt G, (1994) On visual design thinking: the vis kids of architecture. *Design Studies* 15:158–174
- Guilford JP, (1967) *The nature of human intelligence*. N. Y.: McGraw-Hill
- Howard-Jones PA, (1998) The variation of ideational productivity over short timescales and the influence of an instructional strategy to defocus attention, *Proceedings of Twentieth Annual Meeting of the Cognitive Science Society*, Hillsdale, NJ: Lawrence Erlbaum Associates, 496–501
- Kittur A, Chi EH, Suh B, (2008) Crowdsourcing user studies with Mechanical Turk. *Proc. CHI 2008*, ACM 453–456
- Metcalfe J, Wiebe D, (1987) Intuition in insight and non-insight problem solving. *Memory and Cognition* 5:238–246.
- Norman DA, (1993) *Things that make us smart*. Reading, MA: Addison-Wesley
- Roediger HL, Stelson C, Tulving E, (1977) Inhibition from part-list cues and rate of recall. *Journal of Experimental Psychology: Human Learning and Memory* 3:174–188
- Ross J, Irani L, Silberman MS, Zaldivar A, Tomlinson B, (2010) "Who are the Crowdworkers? Shifting Demographics in Mechanical Turk". In: *alt.CHI session of CHI 2010 Extended Abstracts on Human Factors in Computing Systems*
- Schon DA, (1983) *The reflective practitioner*. New York, NY: Basic Books
- Simon HA, (1969) *The sciences of the artificial*. Cambridge: MIT Press
- Suwa M, Gero J, Purcell T, (2000) Unexpected discoveries and S-invention of design requirements: important vehicles for a design process. *Design Studies* 21:539–567
- Suwa M, Tversky B, (2003) Constructive perception: A skill for coordinating perception and conception. In *Proceedings of the Cognitive Science Society Meetings*. Hillsdale, NJ: Lawrence Erlbaum Associates
- Suwa M, Tversky B, Gero J, Purcell T, (2001) Seeing into sketches: Regrouping parts encourages new interpretations. In J. S. Gero, B. Tversky, and T. Purcell (Editors). *Visual and spatial reasoning in design*. Sydney, Australia: Key Centre of Design Computing and Cognition, 207–219
- Tversky B, (2001) Spatial schemas in depictions. In M. Gattis (ed.), *Spatial schemas and abstract thought*. Cambridge: MIT Press, 79–111
- Tversky B, (In press) Visualizing thought. *TopiCS in Cognitive Science*
- Tversky B, Suwa M, (2009) Thinking with sketches. In A.B. Markman and K. L. Wood (Editors), *Tools for innovation*. Oxford: Oxford University Press

Research Methodology for the Internal Observation of Design Thinking through the Creative Self-formation Process

Yukari Nagai¹, Toshiharu Taura² and Koutaro Sano¹

¹ Japan Advanced Institute of Science and Technology, Japan

² Kobe University, Japan

Abstract. Since the external observation of creative design thinking fails to grasp the designer's inner 'self', this study aims to propose a method for internal observation which can be elicited during creative design thinking by extending 'reflections' and 'poietiques'. This method comprises three stages: (1) the creative design practice, (2) writing of reports on the designer's practice by the designer and a third person (art researcher), and (3) writing of another report by the designer after examining both the reports from the second stage. We applied this method to a space-designing project. The three reports were analysed, both quantitatively and qualitatively, and many observations that were not included in the previous two reports were identified in the third report. After these analyses, we confirmed that the sense of 'self' was formed in the third stage and that our method of internal observation was feasible.

Keywords: design creativity, self-formation, reflection, poietiques, internal observation

1 Introduction

Existing studies have shown that investigating one's inner self is particularly difficult. This difficulty emanates from the logical paradox: 'When he observed himself, he was changed' (Hass, 2008). Moreover, it is difficult to observe creative design thinking from an inner perspective when people are deeply engaged in their work. The reason behind this is that people who are engrossed in their work are assumed to have entered a mental state known as 'flow' (Csikszentmihalyi, 1990). Furthermore, the external observation of creative design thinking may fail to grasp the inner 'self' because it is stimulated by intrinsic motivation (Amabile, 1985; Loewenstein, 1994) and formed by inner dynamics (Varela, et al., 1997). It should also be noted that a designer's thought space is formulated from inside (Nagai and Taura, 2006). Thus, observing creative design thinking using either internal or external forms of observation may be considered as an impossible task.

To surmount this barrier, we have attempted to formulate a methodology based on the principle that the method of inner observation is feasible when the occurrence of the self-forming process (the process of forming the self) is confirmed during observation. Although the 'observed self' may be different from 'the self' (the self when it is not being observed), our aim is to facilitate an 'observed self'.

For this purpose, we will be examining techniques known as 'poietiques' and 'reflections', both of which can complement other currently used methods for inner observation.

The method of 'poietiques' was first proposed by Rene Passeron (1989). It is based on the concept of 'poietics', which introduced by the poet Paul Valery (1960). Valery claimed that it is more important to study the process of the creation of the poem than the final poem itself. He asserted that learning from the spirit of creation that inspires the poet (often recorded in a 'cahier' or 'notebook') is more important than the traditional methodology of a critical analysis of a poem. Passeron used Valery's methodology to create the theoretical challenge of 'poietiques' as an approach for studying the creative processes of art as experienced by artists themselves. However, Passeron's 'poietiques' focused only on examining and discovering artists' creative practices; it did not attempt to structure the details of their techniques. 'Reflections' is a popular technique for accessing self-consciousness, which was first proposed by Schön (1987). We have considered this technique here because we regard it as a relevant approach to re-investigate the self. Moreover, it has been confirmed as a useful method for examining our understanding of the design process. By using this method, we presume that differences in inner reflections depend on the differences in perspectives created by the variability of the objective self. Schön found that people who had achieved a high level of creativity often reflected objectively on their own creative processes. Several examples of the effectiveness of objective reflection have been reported in cognitive studies and education,

because objective reflections help people notice their mistakes or fixations from the meta-level viewpoints of their activities (Valkenburg and Dorst, 1998; Oxman, 2002). Thus, we can observe that using an objective reflection of the self when conducting creative activities can be beneficial. However, in order to enhance the process of self-formation, identifying the nature of creative self-formation is necessary. It is also anticipated that subjective reflections may play a role in this process.

Therefore, we propose a challenging method of observing creative self-formation which can be implemented after a careful consideration of its feasibility and limitations. The key factor that reveals the effectiveness of inner observation in creative self-formation is the occurrence of certain novel motifs (self) during design thinking.

The characteristics of this method are mentioned as follows. Firstly, this method is based on relevant reports. Secondly, it involves both an outer perspective and an inner perspective. Thirdly, the method identifies the occurrence of novel motifs (observed self) through the integration of both perspectives.

2 Aims

The aim of the study is to propose a methodology based on the idea that the method of inner observation is feasible when the occurrence of the self-forming process is confirmed during the observing process. For this purpose, we have structured our methodology by incorporating and extending the techniques of 'reflections' and 'poietiques'. The main issue for discussion in this study is how designers form a 'self' through the internal observation of their own design processes.

3 Framework of the Method of Internal Observation

Firstly, we must discuss the conditions necessary for using our method. The most important condition for the success of internal observation is that it should not 'break' the process of creative design thinking. By 'break', we mean creating a situation in which the 'self' has been changed by external factors. In order to avoid this, the processes of design practice and self-formation need to be separated. Therefore, we need to set up the self-formation process after the designer has completed the design practice. Most designers have a long-standing habit of maintaining a 'diary' in the form of daily sketches, notes, and photographs. Some designers even have a habit of maintaining portfolios

to trace the evolution of their creative work regularly. We have taken advantage of such habits in this study.

Secondly, we must consider the various methods of representing human thoughts. The 'think-aloud' method is a feasible way of collecting thoughts through verbalization (Taura et al., 2002). However, this method is not sufficient for self-formation, because it may disrupt the concentration of the designer who is deeply engaged in the creative practice. Moreover, we believe that the 'think-aloud' method can disturb the habitual work pattern of the designer. Therefore, it is preferable to use the descriptive method, which comprises writing reports on design thinking. This is usually done after the designer completes the work. Another advantage of report writing is that it is helpful for careful investigation when the report is read at a later date. Visual information such as sketches and photographs are useful sources for designers to remind themselves of what their thoughts were at a particular time.

Thirdly, we must consider how difficult it is to observe the inner self from an inner perspective when people are deeply engaged in their work, as described above. Therefore, a third person writes another report about the design practice. Designers found this more distanced perspective to be useful, probably because it made it easier for them to remind themselves of the elements of the design practice. It is certainly necessary to retain the quality of an outer perspective. For an external observer with an outer perspective, who is not familiar with the process of creative design thinking, it is impossible to focus on essential issues regarding how it works. Therefore, we must consider someone who is the most capable of accessing such a perspective. For example, we need to consider the role of art researchers. The art of most of the great artists has been mainly studied after their deaths (Clark, 1939). Art researchers are specialists who have been educated in the interpretation of recorded sketches and artworks. We focus on art researchers with special skills and consider that they have the ability of developing an outer perspective of a high level.

On the basis of the above three factors, we propose an original methodology for the internal observation of design thinking, wherein the creative self-formation process is distinguished from the design practice.

This method comprises three stages: (1) the creative design practice, (2) writing of reports on the design practice by the designer and a third person (art researcher), and (3) writing of another report by the designer after examining both the second-stage reports.

The first stage is the creative design practice. Designers concentrate on performing their own practice. Normally, in the case of a space design, the period of design practice is six months or longer. Records of the process are accumulated in the

designer’s habitual manner through sketches, notes, diaries, and portfolios.

The second stage involves initial report writing. After completing the design practice, the designer begins to write a report by observing the recorded sketches, notes, etc. The descriptive items of this report will have been decided in advance. This is because both reports will be analysed in the third stage. The nature of these reports derives from previous knowledge about art research, which indicates that motifs, expression, and techniques are the three main items for reporting art. These items are strongly related to the essential elements of creative thinking. Other elements such as materials and presentations are subsidiary items.

Additionally, an external observer writes a report by exploring the same sources (recorded sketches, notes, etc.) with the designer. The external observer should be a specialist, for example, an art researcher, who can appropriately interpret the records. In order to avoid overt and unnecessary influence on a report in the next stage (the third stage), the external observer does not meet with the designer. Although the self-formation of a designer may occur during the second stage, we expect the next stage to include a stronger self-formation process.

The third stage comprises the designer’s creative self-formation process. At this point, the designer reads the two reports written in the second stage. One report is written by the designer, and the other, by the external observer. The designer compares them in detail and carefully analyses every sentence of each report to identify the differences. The designer then examines the contents of the reports and re-writes sentences, adds new sentences, or deletes unnecessary sentences, in order to elucidate the second report such that it provides a clearer analysis of his or her own

design practice.

Figure 1 shows the outline of the methodology for the internal observation of the designer.

4 Detailed Procedure of Internal Observation

We developed a detailed procedure for the practical experiment on the basis of the above framework.

4.1 Organization of the Practical Experiment

We conducted a practical experiment on actual design work, using the three stages mentioned above. This was done to ensure that not only the practice but also the observation of the creative self-formation process is conducted. The practical experiment was performed as follows:

- Two experimenters planned how to conduct the practical experiment.
- A designer designed a work (space designing) and dwelled in the creative self-formation process.
- An external observer reported on the designer’s thinking process from an outer perspective.

To determine a suitable designer for this practical experiment, we listed certain conditions, which comprised the possibilities of long-time activity and independence, and rich intrinsic motivations. We selected a young freelance designer aiming to participate in a contest of space designing. Student designers could not be selected in this case because it

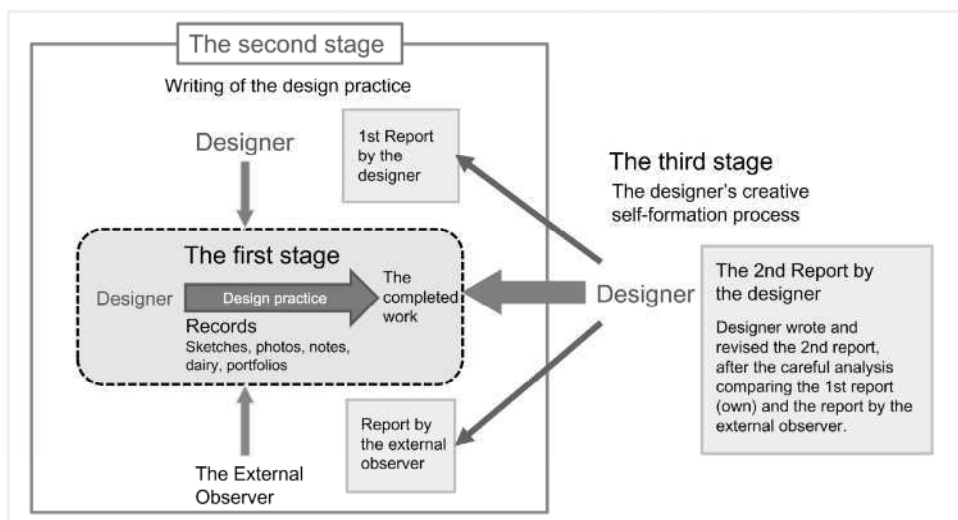

Fig. 1. The methodology for internal observation

was difficult to separate them from their educational programmes. As for professional designers, they cannot always concentrate on a single design for a long time, because they are usually occupied with parallel activities. We also found an art researcher with excellent skills in the investigation of records of design thinking, and invited this researcher to be the external observer of our practical experiment.

4.2 Procedure of the Practical Experiment

We conducted the practical experiment sequentially. As shown in Table 1, the contents of the report were determined. The names of the reports in this study were assigned as follows:

- Report S: the designer’s first report
- Report K: the external observer’s report
- Report F: the designer’s second report

Table 1. Contents of the reports

Items related to processes (Labelled P)		Items related to work (Labelled W)	
P-1	Content on the time sequence of the process	W-1	Content on the field of the work
P-2	Content on the technique of the process	W-2	Content on the technique of the work
P-3	Content on the motif (theme) of the process	W-3	Content on the materials of the work
P-4	Content on the expression of the process	W-4	Content on the expressed motif of the work
		W-5	Content on the expression of the work
		W-6	Content on the exhibition (display) of the work

The procedure for creating Report F in the third stage is described in detail below.

Step 1: After reading both reports, the designer divides Reports S and K into sentences and labels them. Each sentence of Report S is labelled ‘s’, and each sentence of Report K is labelled ‘k’.

Step 2: The designer re-reads each ‘s’- or ‘k’-labelled sentence and classifies them according to their

relevant categories (Table 1). After the classification of all sentences, the experimenters check them for consistency.

Step 3: The designer then compares each ‘s’- or ‘k’-labelled sentence in detail and analyses every sentence in each report carefully, in order to identify the similarities and differences. If an ‘s’-labelled sentence expresses the same meaning as two ‘k’-labelled sentences, the decision is based on the ‘s’-labelled sentence.

Step 4: After a detailed comparison of the sentences, the designer re-writes the sentences, adds new sentences, or deletes the unnecessary sentences, and arranges them in a time-based framework. On the basis of this process, the designer then writes the second report on his own design practice (Report F). Figure 3 shows the contents of Report F. The designer assigns the label ‘F’ on each sentence of Report F. Report F represents each sentence ID as referring to the original report. The sentences which are not used for Report F become ‘d’-labelled sentences, which were originally neither ‘s’- nor ‘k’-labelled, and are now deleted (D-1 and D-2 in Figure 3).

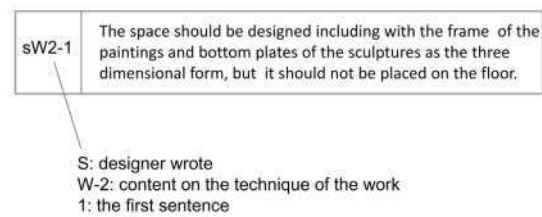

Fig. 2. Example of labelling of sentences

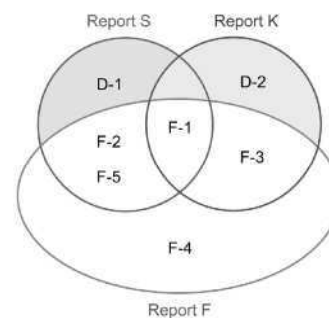

Fig. 3. Contents of Report F

Report F comprises F-1, F-2, F-3, F-4, and F-5, as explained below.

- F-1: sentences which were originally labelled as both ‘s’ and ‘k’.
- F-2: sentences which were originally only labelled as ‘s’.
- F-3: sentences which were originally only labelled as ‘k’.

- F-4: sentences which were neither labelled as ‘s’ nor ‘k’ but were newly written by the designer.
- F-5: sentences which originally had a meaning that differed from ‘s’- and ‘k’-labelled sentences and had been rewritten in order to be added to Report F by the designer.

It is important to mention that the structure of Report F was better than that of the previous report. An example of Report F is shown below.

- Report F: ‘A designer wanted to express the texture of clay and he thought the clay’s most important texture was not obvious, but he thought it was instability.’

5 Results of the Experiment

We applied this method to a practical experiment—a space-designing project. A male designer, who had eight years of experience and was entering a space-designing contest, participated in the practical experiment. For the role of the external observer, we recruited a female art researcher with an impressive career background.

The total duration of the experiment was 24 months: 17 months for the first stage (design practice), 3 months for the second stage (report writing), and 4 months for the third stage (analysis).

In the first stage, the designer provided many sketches and photographs (Figure 4). He noted rough ideas about the work and his conceptions as they developed. Fortunately, he had already the habit of recording the date on each sketch. Further, he regularly maintained a diary. Thus, all the relevant information was stored as a record of the entire design practice. The record was arranged along the timeline. He also maintained portfolios which provided detailed information about the work.

In the second stage, the designer and the external observer wrote each report separately, after looking at the record prepared in the first stage of the experiment.

Finally, in the third stage, the designer analysed the reports and wrote the second report.

Before we present the results of the quantitative and qualitative analyses, we need to explain the styles of each report. We compared the descriptive styles of Reports S and K. Report S, prepared by the designer, was fragmentary and more like a memorandum of his experiences. Report K, prepared by the external observer (the art researcher) was written in a more logical and well-composed style. Examples of sentences from the reports are given below.

- Report S: ‘Texture... we call the end of organization like that—texture, which all structure has.’
- Report K: ‘He tested the various kinds of textures, and he seemed to explore any images through the experience, without setting an obvious goal image.’

6 Analysis and Discussion

6.1 Quantitative Analysis

We now compare Reports S and K. Both were created in the second stage after looking at the same record.

The number of sentences in Report S was 115, while that in Report K was 146. Therefore, we can infer that the external observer wrote more sentences because she captured the process through a detailed interpretation (Table 2). On the other hand, the designer did not note his own design practice clearly. This is supported by the sentences which were written in only one report: 68 by the designer and 99 by the external observer.

Table 2. Comparison of Reports S and K

Category	Number of sentences in each report	
	Report S	Report K
Sentences which were included in S and K (F-1)	39	39
Sentences which were not included in S or K, but were added to F (F-5)	8	8
Sentences which were included only in S (F-2)	51	
Sentences which were included only in S, but not described in F (D-1)	17	
Sentences which were included only in K (F-3)		93
Sentences which were included only in K, but not described in F (D-2)		6
Total	115	146

We consider Report F to be a result of the creative self-formation process. Therefore, we analysed Report F to identify how the self-forming processes had occurred. For this purpose, we analysed Report F using

the reasons and original sentences in Report S or Report K. Table 3 shows the result of the relationships between Report F and Report S or Report K. In Report F, 51 sentences were originally written by the designer, and 93 sentences, by the external observer.

Table 3. Analysis of Report F (the second report by the designer) from the original sentences in Reports S and K

Category	Original sentences	Number of sentences in F
F-1	From S and K	39
F-2	From S only	51
F-3	From K only	93
F-4	New sentences that were not originally described in S or K	74
F-5	From S and K implicitly	8
Total		265

This implies that the designer did not recognize some of the important points that he had made during the design practice, but he was still being supported by the external observer's perspective. Moreover, Report F contained 74 new sentences that were not originally described.

We analysed these 74 sentences. Table 4 shows the result of the classification of the contents of the report. This shows that the frequency of the occurrence of motifs was clearly high.

The emergence of the 74 sentences, which were newly written in Report F, suggests that the cause is the integration of the inner perspective of the designer and the outer perspective of the external observer. This implies that the designer probably did not reflect on these aspects sufficiently when he subsequently wrote the first report based on his inner perspective. However, when he read the report, which had been written from the outer perspective of the external observer, he reflected more deeply. Furthermore, the result that many of the 74 sentences were related to the motif suggests that the designer had developed a new self-formulation when he recognized the difference between the perspectives: the inner and the outer.

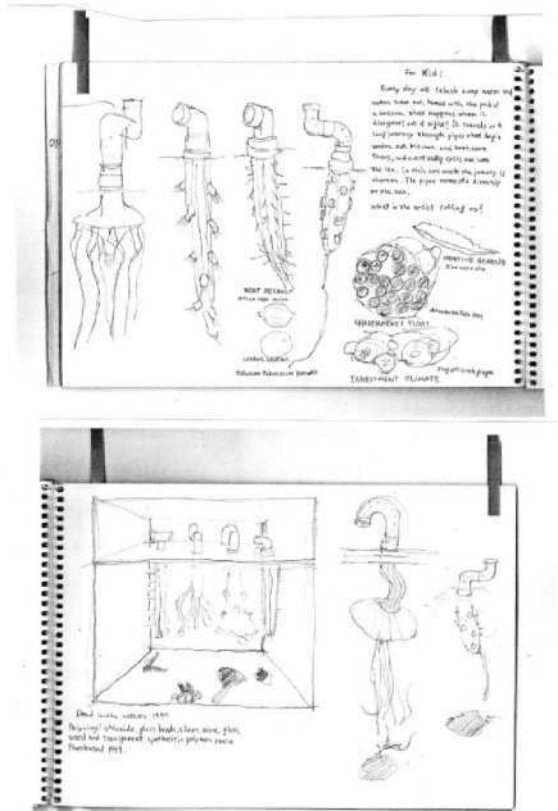

Fig. 4. Example of the sketches



Fig. 5. The work (space designing) of the designer

Table 4. Content of Report F

Item	F-1	F-2	F-3	F-4	F-5	Total
Process						
P-1 Content on the time sequence of the process	16	1	20	10	1	48
P-2 Content on the technique of the process	10	14	9	9	1	43
P-3 Content on the motif (theme) of the process	1	15	18	15	2	51
P-4 Content on the expression of the process	0	0	7	9	2	18
Work						
W-1 Content on the field of the work	3	1	5	3	1	13
W-2 Content on the technique of the work	1	1	9	1	0	12
W-3 Content on the materials of the work	5	7	10	12	0	34
W-4 Content on the expressed motif of the work	1	1	6	3	0	11
W-5 Content on the expression of the work	2	3	2	8	1	16
W-6 Content on the exhibition (display) of the work	0	8	7	4	0	19
Total	39	51	93	74	8	265

6.2 Qualitative Analysis

We assume that the designer’s self-formation occurs in the third stage. Moreover, we assume that the designer’s observed self is different from the self shown when he does not observe himself. However,

we consider that the observed self has potentially always existed within himself, as this self continuously exists later on.

To confirm this, we asked the same designer to read the 74 sentences again, two years after the experiment. He evaluated the contents of the sentences qualitatively. Finally, he selected the most important sentences on the basis of the development of his design work. These sentences are stated below.

(1) ‘The designer understood the relationship between natural things and artificial things in connection with the relationships between the gregarious plants and gregarious houses in the city.’

(2) ‘The designer, however, wanted to represent the feeling of what he got from the cool wind when he was resting his exhausted body, after his hard work of digging and cutting of roots.’

He provided the following reasons for selecting them.

(1) ‘I have recognized the relationship between natural things and artificial things from the words in the sentence of Report S. Those words were “nature” and “a map of the city”. After I had read the two reports, I found the missing parts of Report S. I reflected on myself again. Then, I awakened my perspective on the relationships between dualities: “nature and artificial” or “gregarious plants and gregarious houses”. This sentence represents the main motif of my work. It has been my theme and my vision of the world.

(2) ‘I found that the part of the sentence—“the feeling he got from the cool wind”—represents the point at which I understood the expression. I was sensitive to the sound of wind, smells, resonances, and so on. I was driven by my emotions. My emotion was stimulated by such senses. The trigger for my inspiration was my senses. I recognized the core part of my motivation from this sentence.’

We finally found that the motif of the newly written sentence in the second report of the designer was present in the third stage. In light of this, we recognized the effectiveness of adopting the outer perspective of the external observer and integrating it with the designer’s inner perspective for internal observation. Another finding of this study is related to the role of writing in the self-formation process. The roles of language in design and in other activities have been highlighted by a number of studies (Suwa, 2009; Eckert and Stacey, 2000; Dong, 2006). The proposed method is expected to develop the methodology further through discussions of the role of language and reflections on creative thinking not only in the field of design but also in other disciplines. However, it was necessary to accumulate trials and open discussions. The methods should be simplified in the accumulation of more trials. To formulate suitable procedures, we

conducted a long-term experiment with very detailed examinations. More rational procedures can be established by future studies on the basis of our findings.

7 Conclusion

We developed the methodology for the internal observation of design thinking through the creative self-formation process, wherein a designer's inner perspectives are integrated with an outer perspective on the basis of the idea that the method of inner observation is feasible when the occurrence of the self-forming process is confirmed during the observing process. We identified the occurrence of the motif which stimulates the designer's intrinsic motivation through a practical experiment. Therefore, we conclude that the 'self' has been observed in this experiment.

References

- Amabile TM, (1985) Motivation and creativity: effects of motivational orientation on creative writers. *Journal of Personality and Social Psychology* 48(2):393–399
- Clark K, (1939) *Leonardo da Vinci: An Account of his Development as an Artist*. Cambridge University Press
- Csikszentmihalyi M, (1990) *Flow: The Psychology of Optimal Experience*. New York: Harper & Row
- Hass L, (2008) *Merleau-Ponty's Philosophy*. Bloomington and Indianapolis: Indiana University Press
- Loewenstein G, (1994) The psychology of curiosity: a review and reinterpretation. *Psychological Bulletin* 116(1):75–98
- Maturana HR, Varela FJ, (1980) *Autopoiesis and cognition: the realization of the living*. Dordrecht: Kluwer Academic Publishers
- Nagai Y, Taura T, (2010) Formal description of conceptual synthesizing process for creative design. *Design Computing and Cognition—DCC '06*, edited by John Gero, 443–460, Dordrecht: Springer
- Oxman R, (2002) The thinking eye: visual re-cognition in design emergence. *Design Studies* 23(2):135–164
- Schön DA, (1987) *Educating the reflective practitioner*. San Francisco: Jossey-Bass Inc
- Suwa M, (2009) Meta-cognition as a tool for storytelling and questioning. 'What is "What's the Design"?' Special Issue of Japanese Society for the Science of Design 16-2(62):21–26
- Taura T, Yoshimi T, Ikai T, (2002) Study of gazing points in design situation—a proposal and practice of an analysis method based on the explanation of design activities. *Design Studies* 23(2):165–185
- Valkenburg R, Dorst K, (1998) The reflective practice of design teams. *Design Studies* 19(3):249–271
- Valery P, (1960) *The Collected Works of Paul Valéry*. London: Routledge & Kegan Paul Ltd.
- Varela FJ, Thompson E, Rosch E, (1997) *The Embodied Mind*. Cambridge: MIT Press
- Passeron R, (1989) Pour une philosophie de la création. In: *Recherches Poétiques*. Vol. I, Paris: Klincksieck
- Eckert C, Stacey M, (2000) Sources of inspiration: a language of design. *Design Studies* 21(5):523–538
- Dong A, (2009) *The Language of Design: Theory and Computation*. London: Springer-Verlag

Design as a Perception-in-Action Process

Katja Tschimmel

Escola Superior de Artes e Design (ESAD), Portugal

Abstract. Design thinking is thinking in variety and in new semantic and material combinations. To think about the possibilities, the designer needs to liberate himself from routines of perception. This liberation is the basis for all innovative design. Taking into account the dominant role of a deliberately orientated perception in the creative design process, we consider design as a Perception-in-Action Process. The name of our model is based on the methodological design paradigm proposed by Schön, the 'Reflective Practice' with its Reflection-in-Action Process. The Perception-in-Action Process is divided into five procedures which are not linear but intersecting each other: the perception of the task, the perception of a new perspective, the perception of new semantic combinations, the perception in prototyping and the perception of users' reaction. At the end of the paper we will identify some strategies to develop students' perception in design education.

Keywords: design cognition, perception in design, constructivism, creative process, methodological paradigms, design education.

1 Introduction

Since the 1980's, cognitive science and constructivist theory have challenged the existence of an objective reality and recognize the plurality of perceptions and perspectives of reality. This perspective has profound consequences for the interpretation and conceptualisation of the creative design process. As our thinking process is influenced by the fact that the brain is a self-referential system (Roth 1992), all innovative design visions emerge, grow and mature during the creative process in interaction with the situational system of a project.

In this paper we want to show how the understanding of design creativity is influenced by the dominant methodological paradigm of the moment, and its changes, and describe the important role which the designer's perceptive capacity has in his creative design processes and how it can be developed in design education.

2 Design Cognition

Over the last thirty years, scientific interest in the creative thinking process of designers has grown rapidly. The research in design cognition started with the increasing criticism of the rational design methodology. Against all expectations, the methodological design movement failed in its attempt to improve the quality of design projects through the application of rational methods. Instead of the development of universal methods, Design Cognition Research is interested in finding the essence of the mental processes of the designer when he is reflecting on a project, with the objective to better understand the attributes which characterize design creativity, both in the process, and in the solution.

Researchers such as Lawson (1986), Schön (1983; 1987), Cross, Dorst and Roozenburg (1992), Goldschmidt (1994; 2001; 2003), Eastman, Mc Cracken and Newstetter (2001), Oxman (1999; 2002) or Gero (2006), who studied the cognitive processes of designers, all pointed out that the design process is too complex to reduce design thinking to mere 'problem-solving' or 'information-processing'. The designer decides what to do and when, on the basis of the personally perceived and reconstructed design task. Thus, information about the design project and knowledge of the subject are not enough to develop an innovative design solution, but creative thinking and perception are even more essential.

2.1 Design Thinking in Constructivist Perspective

Radical Constructivism, an interdisciplinary theory about cognition (Schmidt 1992; 2000), shows us that perception and recognition are exclusively a re-organization of previous experiences and expectations. Constructivist authors challenge the existence of an objective ontological reality and promote the plurality of perceptions. Von Glasersfeld, Roth, Schmidt, and other researchers in cognition and perception, describe the brain as a 'self-referential' and 'self-explaining' system, which doesn't have direct access to the world, but which operates on the base of genetic

determination, educational and cultural patterns, earlier internal experiences and one's emotional state (see the different approaches in Schmidt 2000).

Researchers in design cognition, call this activity 'constructive memory' (Gero 1999). It operates both on the personal experience of the designer, and by the recall of design-relevant information from the memory (Eastman 2001). Besides referring to the register and recall of determinate moments, the concept of 'constructive memory' also includes a constant readjustment of meanings in the face of new experiences. This phenomenon explains the fact that designers not only interpret a given design problem in quite different ways from one another, but also at different moments. Thus, each designed object is the result of a personal choice from the designer/team at a certain moment and in a certain design-situation, based on his personal and professional life story. Gero (op. cit.) introduces the concept of situatedness, which includes both, the context of design decisions and the way the situation is interpreted by the designer. Also Eastman (op. cit.) sees a close relationship between the experiences of a designer and the recall of relevant information from the memory to respond to the contextual conditions of the project. What characterizes the expert designer is his capacity to connect in a flexible way his personal and professional experiences with the situational factors of the project. To do this, he utilizes creative thinking operations, such as associative thinking, thinking in analogies, visual reasoning and perception with all of the senses.

2.2 The Role of Perception

While our day to day thinking consists of automatic pattern recognition in accordance with the *Gestalt* laws (with the objective of quick orientation and recognition), design thinking is based on new pattern creation (with the objective of achieving different forms and impact). In this sense, Dorst describes visual thinking in design as "a way of looking, of being more actively involved in the world than most people" (2003: 159). This affirmation we can easily stretch to all of the perceptual senses.

As perception in constructivist perspective operates as a 'self-organizing-information-system', which restricts our thinking to already set up patterns, the designer has to liberate himself from a routine and mechanical kind of perception. In earlier works, we defined 'perceptive cognition' as a basic skill in the creation of new realities and artefacts, and considered the training of conscious and directed perception, the searching for new nuances to be, the core of design education (Tschimmel 2005; Pombo and Tschimmel 2005). We understand perceptive cognition as the

complex process of exploiting at one and the same time the stimulus input, and also the reasoning about its properties. Both operations are applied at several points of the creative design process.

3 The Creative Process in Design

Although originally it was psychologists who investigated the phenomenon of creativity, it was natural scientists who started to identify and describe the mechanisms and the structure of the creative process. The first references to a multiphase structure of the creative process go back to Poincaré (1924), who through his thoughts about his own creative thinking process in solving mathematical problems, gave the impulse to Wallas (1926) to divide the creative process into 4 phases: the preparation phase, the incubation, the illumination and the verification phase. This classification was the starting point of the research movements into creativity (also in design) which looked for new models to best describe the phases of a creative problem solving process. The objective of this research was, and still is, the discovery and development of methods, which can guide a person successfully through a creative process in a domain of innovation, such as design. It was the birth of the classic methodology of design.

3.1 The Change of Methodological Paradigms

The classification and respective visualization of the different phases of the design process, depends mainly on the methodological paradigm in which we analyse and describe the creative process in design. The dominant paradigm refers to the scientific and theoretic background of the domain and its applied practical habits. In doing this, it also forms the interpretation of the scope and characteristics of design methodology itself. The first design methodology movement in the early 1960's was mainly composed of engineer-designers and led to the development of a phase-model of the creative process oriented by rationality and systematic proceeding (Archer 1965; Cross 1989).

Since the 1980's and the growing influence of architects (Lawson 1986; Goldschmidt 1998) and educators (Schön 1983) in design methodology and design thinking research, we have seen a multiple change of methodological paradigm: 1. The change from the rational and analytical paradigm to the holistic paradigm of the emergence of design; and inside the first change is 2. the change from the Problem Solving paradigm to the interpretation of the design process, first as a Reflective Practice (described

in Dorst 1997), then as a Co-Evolution of the Problem-Solution Space (Dorst and Cross, 2001) and finally as a Systemic Process. This last model (for example described in Jonas 1994) will not be integrated in the following descriptions of the paradigms, because it is not essential for the development of the Perception-in-Action model, which is the subject of this paper.

3.1.1 Design as a Problem Solving Process

Traditionally, since the 1960's, design processes have been described as rational or creative problem solving processes (Archer 1965; Simon 1969; Rittel 1970), and in many cases they still are. This approach is on the one hand based on the phase model of Wallas and the Creative Problem Solving movement, and on the other hand by cybernetic science and the search for optimization of resources and processes for solution finding. Characteristically in this paradigm, designers are seen as problem solvers: the work on a design project starts with a problem, which is to identify, to understand, to explore, to redefine, and in the end to solve, by the creation of a new product, service or process. This perspective was so embedded in the understanding of the design process, that a lot of designers and design theorist have developed methods to better guide the design process. Numerous classical design methods are described in the important works of Archer (1965), Cross (1989) or Bürdek (2005).

At the end of the 1970's the belief in universal and objective methods, which in a rational way led to 'good' design solutions was challenged. The protagonist of the criticism of the classical methodology was Paul Feyerabend (1975), who fought against the idea that only one method – for example the Cartesian – should be universally accepted. Only a concept of methodology, which respects variety and diversity, can be compatible with a humanistic view of life and the constructivist perspective, where subjective perception and the construction of one's own reality is the core. A change of paradigm in design methodology was obviously needed.

3.1.2 Design as a Reflective Practice

Since the 1980's, numerous theorists and methodologists have challenged the linearity of the creative process and the positivists' design methods, in favour to a pluralist and emergent approach (Schön 1983, 1987; Dorst 1997; Bürdek 2005; Pombo and Tschimmel, 2005). In this constructivist perspective of cognitive processes, Schön describes the creative design process as a "reflective conversation with the situation" (op. cit.) and introduces the concept of Reflection-in-Action. While the designer works on a project, he is reflecting on his actions, which step by step guide the development of the project and the

emergence of a solution. Through the realisation of change/testing experiments, the designer actively constructs a view of the world, based on his experiences. Instead on a well or ill-defined problem, the designer now thinks and works on a task, which is essentially unique and includes the characteristics of the designer, the available time and the subject to work on. The basic elements of design activities in this paradigm are actions: *naming* the relevant factors in the project situation, *framing* the core of the project in a certain way, *making moves* toward a new formal-aesthetic expression, and *evaluating* those moves. An overview of the paradigm of reflective practice is given in Kees Dorst's PhD work *Describing Design. A comparison of paradigms* (1997).

3.1.3 Design as a Co-Evolution of Problem-Solution Space

Parallel to, and as an evolution of, the model of Reflective Practice, the design process is also conceptualized as a Co-Evolution of the Problem-Solution Space (Dorst and Cross 2001). Assuming that in the reflective design practice there is no way to determine *a priori* which approach will be more successful, design task and solution are always and inherently developed together. In a think-aloud study with nine expert designers, Dorst and Cross came to the conclusion that creative design is a matter of developing and refining both the formulation of a problem, and the ideas for a possible solution (op. cit.). In this non-linear process, cause and effect are no longer distinguishable because of the constant cross-fertilisation. According to Dorst and Cross, the decisive creative moment in a project is that in which the coupled 'problem-solution' gets a new frame. Thus, the originality of the solution depends on the framing and reframing process, which means the construction of a personal perspective of the problem-solution space.

4 The Perception-in-Action Model

Taking into account the dominant role of a deliberately orientated perception in the creative design process, and in a kind of homophonic and homographic analogy to the Reflection-in-Action process of the Reflective Practice, we consider design as a Perception-in-Action process (PiAp). Doing this, we are not denying the paradigm of reflection, but complementing the model, dislocating the focus from the reflection mode to the perception mode. Thus, we describe with the concept of Perception-in-Action the design process in which the designer consciously challenges stereotypical thinking, searching out the

new and different inside the problem-solution space. The objective is the posterior establishment of a connection between newly perceived impulses and elements of the design task. None of this is possible without reflection.

It is perceptual reflection that we consider to be the basic skill and procedure in the creation of new realities. What the designer perceives with all his senses while he is reflecting on a design task has profound impact on how a situation is interpreted, how analogies to other knowledge domains are made, and how design solutions are developed.

We could have called our model a Perception-and-Reflection-in-Action process, because perception and reflection are continuously interacting in any creative process. But as we want to put the focus on the important role of perception, we have concentrated on the Perception-in-Action model. Thus, in the use of the term ‘perception’, we include perception through our senses, and also perception as interpretation and meaning giving to a reality. The emphasis on the aspect of perception is based on its core importance for the originality of design solutions and surprising semantic versions.

4.1 The Process and its Phases

The Perception-in-Action process can be divided into five procedures which are not linear but intersecting each other (Fig. 1):

- the perception of the task,
- the perception of a new perspective,
- the perception of new semantic combinations,
- the perception of new solutions in prototyping and
- the perception of users’ reaction.

Each procedure is characterized by the perception of a

problem/task of the design project and of a possible solution space (S_x) in parallel, because problems can’t be defined, reformulated, developed and solved without thinking at the same time about possible solutions.

4.1.1 The perception of the problem/task

The first phase of the Perception-in-Action process is the perception of the problem/task (p/t). The designer/the team (D_x) analyses and interprets the design task, using previous professional and personal experiences, his world vision and a recalling of relevant memorised information for the project. In an interchange he searches out information relevant to the design, and possible points of tension, contradictions and ambiguities in the project. At the same time, the designer perceives various stimuli which help him to prioritise the project tasks to be considered; later the criteria for future evaluation will emerge. To an outside observer, the more unexpected the perceived elements are, the more original would be the response to the task and the identification of its elements. This first phase of the PiAp corresponds to the procedure which Schön called *naming* (1987).

4.1.2 The perception of a new perspective

In the second phase the designer reaches a point at which a new perspective, relative to the task, is formed (designated by Schön as *framing*) which will be developed in accordance with the respective redefinition. In this procedure the designer actively searches out new ideas and design criteria together with a new visual and semantic language. In this way he will select various stimuli which will be integrated in the design process and will help him to produce more or less original ideas. This phase can be seen as a reformulation of a problem.

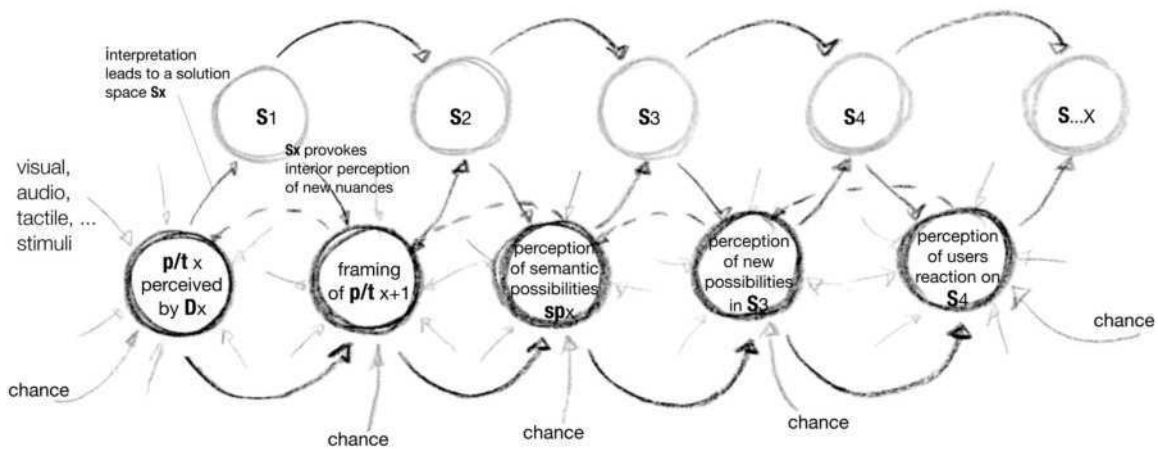

Fig. 1. A sketch of the five procedures of the Perception-in-Action process where at any moment, chance can influence the perception of the problem/task and of the actual design situation.

4.1.3 The perception of new semantic combinations

In the third phase of the PiAp various versions of the design are developed, since the perception process of the designer is directed by the search for semantic solutions in similar artefacts. In a comparison of different compositions and versions of the product, the designer is keenly aware of the stimuli which lead to distinct design solutions. Here is also found the perception of random or chance occurrences which have little or nothing to do with the project, but which could lead to surprising design solutions by way of analogical thought.

4.1.4 The perception of new solutions in model construction and prototyping

After choosing one or more versions of a design, there follows the period in which the product is developed. In this phase the concentration is centred on modifications and improvements of models and prototypes. The expectation which a designer has for a project directs his perception and evaluation of the design models, and can still provoke fundamental and surprising revisions. The construction of numerous different models at a very early stage of the process prevents the designer from getting prematurely attached to an idea, a semantic language, a material or a technological solution.

4.1.5 The perception of users' reaction

During any of the previous four phases or as the final phase of the PiAp, the new product/image/service/process can be tested by target users. The perception and reaction of these consumers contributes to any rethinking and possible modification of the new artefact. The designer has to understand and interpret the feedback from the users.

4.2 Perception *in* and *through* images

Since visual perception is the dominant among the senses, perception *in* and *through* images plays a special role in the Perception-in-Action process. This is emphasised by several design researchers (Goldschmidt 1994; Lawson 1996; Oxman 2002).

In her various publications on the central role of graphic representations in the formation and development of ideas in the design process, Gabriela Goldschmidt maintains that sketching is an extension of mental imagery (1991; 1994; 1998). By drawing, the designer expands the problem space of the projected task, to the extent of including and even discovering, new aspects, which he considers relevant, as much as through a subsequent interpretation of his graphic representations. Expressive representations can expand the over view of the project, but may also

limit it. The activity of sketching is, according to Goldschmidt, a kind of modulation of the problem space.

Graphic representations need a slow, intense and thorough observation, permitting the designer to appreciate the different relations between the objects, the individuals and their characteristics. Thus graphic representations are both output, being a result of a mental process, and are also a spur to further mental activity from the designer. While drawing, through the interaction of line, form, symbols and ideas, new characteristics, unconnected to the design task, can appear, despite not having been planned by the designer. Apart from this, the playful aspect of sketching gives pleasure to the designer, which in turn helps his concentration and perceptive sensitivity.

Essentially, a drawing made by hand is, for a designer, a tool in his thinking process. Goldschmidt (2003) asserts that in the process of creative perception of self generated sketches made in the quest for new approaches and perspectives, the designer spends much less energy than in the observation and active interpretation of other sources of imagery. Apart from this, because of their frequent graphic ambiguity, drawings made by hand allow many more interpretations than, for example, photographs mimicking reality.

For the designer to be able to benefit from his sketches in the creative perception process, he must be reasonably competent at drawing. A design specialist can be considered as one who can rapidly and recognisably, express ideas and shapes by drawing, and who can also change and adapt them at will. So in design education, the development of the expression of ideas by drawing must have a central role.

With respect to our Perception-in-Action model, we reach the conclusion that the designer, in a perceptive dialogue between his imagination and his graphic representations, identifies, alters, reinterprets and improves situations and elements of the task. In the search for originality through creative perception, thinking *in* and *through* imagery helps the designer to get a unique design solution. According to a constructivist perspective, in this Perception-in-Action process, the designers' models of reality and personal experience of all sorts, which he relates to the situational factors of the project, support him.

5 Design Education

Since Schön's work in educating the 'reflective practitioner' (1987), we can find results of cognitive studies being used as a foundation of design learning and education by several design researchers (amongst

others Eastman, McCracken and Newstetter 2001; Oxman 1999; 2001; Tschimmel 2004; 2005). And taking into account the constructivist didactics (applied by Oxman 1999; Tschimmel op. cit.; Saariluoma, Nevala and Karvinen, 2006), we can conclude that the main objectives of design education should be the development of process related skills, instead of giving too much attention to the designed products in project classes. Learning is a process of the self-development of the cognitive system, which occurs through the perception and construction of meanings. Thus, learning through construction seems to be the most appropriate way of building knowledge structures in the students' minds and for transforming the students into creative design thinkers. And in this process, the training of perception plays an important role.

5.1 Principles and strategies for training perception

Owing to the impossibility of teaching creative perception theoretically, design education can only create the conditions which lead to attentive and focused perception, and to the emergence of new ideas and perspectives.

One of the basic principles of creative perception is the conscious search for new perspectives and fields of knowledge, which can provide facts and information that can be transposed to the context of the problem in hand. It's a kind of perceptive observation. In order to complete or consciously modify his first spontaneous perception of a situation or task, the designer needs a mental flexibility, which lets him jump from one field of knowledge to another, carrying information. In design classes, it is possible to instruct the students to familiarise themselves with other areas of learning, such as biology, astronomy or cognitive sciences. In each new area they will find crossing points, or aspects which could be useful for the Project, and which could result in new perspectives. Concretely, this strategy could be applied in an exercise like the following: while the students work on a certain design task or detail, an invited specialist of an unrelated knowledge domain like astronomy or physics could give a speech about a certain subject, from which the students had to transfer something to their design task with the objective of getting a new perspective of the project. In the science of creativity, this procedure is called Forced Relationship. Strategically it also makes sense to search out, or to be open to, day-to-day influences, which can show objects in a new light or with a new significance by semantic confrontation. The creation of ambiguous situations or the provocation of internal tensions through contradictions can, especially at the outset of a project, sharpen the perceptive senses of the students.

Another important strategy for the refining of perception is to work on emotions and feelings. These filter and structure the perception of situations and information (Solovyova, 2003), and thus point our attention in a specific direction. With this, emotions are an expression of the way an individual assimilates, interprets and stores experiences. Positive feelings and personal interest in a theme or project increase intrinsic motivation, perceptive sensibility and the unconscious search for stimuli, which could relate to the project. Dealing with feelings and emotions in a conscious manner could also turn into a strategic means of developing perceptive ability.

An important strategy for learning how to deal with emotions in social situations and at the same time for developing perceptive abilities, is in an open exchange with others in dialogue. Open communicative exchange helps to free this limited and blinkered perception of a situation. For this the designer must develop the ability to listen carefully, encourage his partners to express their opinions and to continue, taking into account the point of view of the others. In the literature of psychology there are a lot of books about group dynamics with exercises to develop the students capacity of dialogue.

As well as the increase of verbal perspectives, one of the most frequently used strategies in the development of perception is, as we have seen, the teaching of drawing. Since lack of ability in drawing can limit visual and spatial imagination, it follows that drawing lessons take a central position. Just as a successful writer must have verbal skills, the designer needs visual expression skills to be creative at this level.

Unfortunately design students fall back all too often on visual or verbal thinking alone, overlooking the other perceptive senses, and thus limiting the design solution possibilities. But formal, material and chromatic nuances, unusual perspectives, strange sounds, new smells and flavours can be rich sources of new ideas, concepts and forms. Beside the activation of all the senses in the act of perception during exercises and projects, in design education some other complementary strategies, whose purpose is the development of a 'creative perception', as opposed to a routine kind of perception, could be applied, such as:

- Divergent exploration of the project information and the relevant knowledge to deal with the problem-solution space;
- Introduction of students into the world of design cognition, design interaction and of the learning process itself;
- Encouragement of travelling to other countries and cultures with predefined observation tasks.

5.2 Perception-in-Action in the Project Classes or Design Studios

Project classes or design studios are at the heart of design education in every design school, because the simulation of real design situations still seems to be the most effective frame for learning design thinking, as Dewey showed us a century ago (1910/1997). Students who are learning design by projects, side by side, and often in collaboration, with colleagues and with their teachers, experience an intense process of reciprocal inquiry in which each involved party frames and shapes the design task and every problematic situation and, at the same time, is shaped by it. In this process of transaction (Schön, 1992), students and teachers give form to the information they transmit to each other, and construct together points of view and meanings. There are frequently in this transaction process a lot of communication and interpretation problems, as for example identified by Schön (ibid.). Students and teachers therefore benefit from expressing their ideas usually in images such as hand drawings and digital drawings, but also in other kind of visual representations such as Mind Mappings, Mood Charts, Scenario sketches, etc. These kinds of complementary imagery tools are still not applied enough in project classes, which are not directly related with methodology. But as every design class should give an incentive and motive for the construction of new perspectives and knowledge, process methods should not only enter the design studio, but also other classes, including the theoretical ones.

For training a creative perception of a design task (1st procedure of PiAp), besides the application of methods such as Mind Mapping or Role Play, exercises, which lead to the uncommon observation and registering of curious situations in peoples' live could be used. Important in these exercises is the exploration of nuances, rareness and ambiguity.

In the second phase of PiAp, the perception of a new perspective, methods such as Inverted Brainstorming, Bodystorming, Extreme Characters or Scenarios can develop the capacity of reframing. The reframing and redefinition of situations can be taught in any kind of class, working with texts, images or other sensual stimuli. At the centre should be the conscious destruction of stereotypical views in respect of a thematic subject or a design situation.

For the perception training of new semantic combinations (3rd procedure of PiAp), methods such as Semantic Confrontations, Forced Relationships, Visual Thesaurus, etc. are very useful and applicable in any kind of class; methods where provoked chance has a important contribution.

The perception of new solutions in prototyping (4th procedure of PiAp), can be taught in studio classes by creating many different models, each one highlighting different aspects of the product or service (form, colour, material, details, etc.).

The fifth phase of PiAp, the perception of users' reaction, concentrates on methods, which allow a varied observation of peoples' interaction with the designed products.

6 Conclusions

Each time we, design researchers, observe, describe and visualize the creative design process with the objective of creating new methods and tools to support the process, we have to choose in which design paradigms we move. By choosing the Perception-in-Action model, the focus is on the development of techniques which help designers to challenge mental patterns, stereotypical ideas and well-known forms of perceptive expression. But we still lack more tools that can be applied in classes and the studio, to help the development of students' perceptive thinking abilities. In future projects we intend to develop some more of these tools and exercises, and at the same time test the existing methods of creative thinking through perception in respect of their usefulness.

Although our reflections on the Perception-in-Action model and our experience in design education have indicated that perception training is an valuable contribution to the learning process of future designers, we have to admit that there is a big limitation of our model: it seems to be extremely difficult to prove that perception training in design education improves the creative thinking capacity of future designers and the degree of originality and innovation of their designed products. To prove the core of perception in creative design, we still have to develop an empirical way of measuring the contribution of perception training: because of the 'sleeper-effect' of learning, positive results of perception development only are evident some years later.

References

- Archer B, (1965) Systematic Method for designers. London: The Design Council
- Bürdek BE, (2005) Design. Geschichte, Theorie und Praxis der Produktgestaltung. Basel, Boston, Berlin: Birkhäuser-Verlag für Architektur
- Cross N, (1989) Engineering Design Methods: Strategies for Product Design. Chichester: Wiley

- Cross N, Dorst K, Roozenburg N, (Eds.) (1992) *Research in Design Thinking*. Delft: Delft University Press
- Dewey J, (1997) *How we Think*. Mineola, New York: Dover Publications [orig. 1910]
- Dorst K, (1997) *Describing Design, A Comparison of Paradigms*. Delft: Delft University Press
- Dorst K, Cross N, (2001) Creativity in the design process: co-evolution of problem-solution. *Design Studies* 22(5):425–437
- Dorst K, (2003) *Understanding Design, 150 Reflections on Being a Designer*. Amsterdam: BIS Publisher
- Eastman C, (2001) New Directions in Design Cognition: Studies of Representation and Recall. In *Design Knowing and Learning: Cognition in Design Education*, Oxford: Elsevier Science Ltd. 147–198
- Eastman, McCracken, Newstetter, (Eds.) (2001) *Design Knowing and Learning: Cognition in Design Education*. Oxford: Elsevier Science Ltd.
- Feyerabend P, (1975) *Against Method. Outline of an Anarchistic Theory of Knowledge*. London: Humanities Press
- Gero JS, (Ed.) (1999) Constructive memory in design thinking. In *Design Thinking Research Symposium: Design Representation*, Cambridge, Massachusetts: MIT, 29–35
- Gero JS, (Ed.) (2006) *Design Computing and Cognition '06*. Dordrecht: Springer
- Goldschmidt G, (1991) The dialectics of sketching. *Creativity Research Journal* 4(2):123–143
- Goldschmidt G, (1994) On visual design thinking. *Design Studies* 16(2):189–209
- Goldschmidt G, (1998) Creative Architectural Design: Reference versus Precedence. *Journal of Architectural and Planning Research* 15(3):258–270, Chicago: Locke Science Publishing Company
- Goldschmidt G, (2003) The Backtalk of Self-Generated Sketches. *Design Issues* 19(1):72–88, Massachusetts Institute of Technology
- Jonas W, (1994) *Design – System – Theorie. Überlegungen zu einem systemtheoretischen Modell von Design-Theorie*. Essen: Ed. Die Blaue Eule
- Lawson B, (1986) *How designers think*. London: The Architectural Press
- Nelson H, Stolterman E, (2003) *The Design Way. Intentional Change in an Unpredictable World*. Englewood Cliffs, New Jersey: Educational Technology Publications
- Oxman R, (1999) Educating the designerly thinker. *Design Studies* 20(2):107–122, Elsevier Science Ltd
- Oxman, R, (2001) The Mind in Design: a Conceptual Framework for Cognition in Design Education. In Eastman, McCracken, Newstetter (Eds.). *Design Knowing and Learning: Cognition in Design Education*, Oxford: Elsevier Science Ltd. 269–295
- Oxman R, (2002) The thinking eye: visual re-cognition in design emergence. *Design Studies* 23(2):135–164, Elsevier Science Ltd
- Poincaré H, (1924) *The foundation of science*. New York: Science Press
- Pombo F, Tschimmel K, (2005) Sapiens and demens in Design Thinking – Perception as Core. In *Proceedings of the 6th International Conference of the European Academy of Design EAD'06*. Bremen: University of the Arts Bremen. Paper 062
- Rittel H, (1970) Der Planungsprozess als iterativer Vorgang von Varietätserzeugung und Varietätseinschränkung. In *Entwurfsmethoden in der Bauplanung*. Stuttgart/Berlin: Kramer Verlag
- Roth G, (1992) Das konstruktive Gehirn: Neuro-biologische Grundlagen von Wahrnehmung und Erkenntnis. In *Kognition und Gesellschaft, Der Diskurs des Radikalen Konstruktivismus 2*. Frankfurt am Main: Suhrkamp Taschenbuch Verlag, 277–336
- Saariluoma P, Nevala K, Karvinen M, (2006) Content-Based Analysis of Modes in Design Engineering. In Gero (Ed.) *Design Computing and Cognition '06*. Dordrecht: Springer, 325–344
- Schmidt SJ, (Ed.) (1992) *Kognition und Gesellschaft, Der Diskurs des Radikalen Konstruktivismus 2*. Frankfurt am Main: Suhrkamp Taschenbuch Verlag
- Schmidt SJ, (2000) Der Radikale Konstruktivismus: Ein neues Paradigma im interdisziplinären Diskurs. In *Der Diskurs des Radikalen Konstruktivismus*. 8th Ed. Frankfurt am Main: Suhrkamp Taschenbuch Verlag, 11–88
- Schön D, (1983) *The Reflective Practitioner*. New York: Basic Books
- Schön D, (1992) Teaching and Learning as a Design Transaction. In Cross, Dorst & Roozenburg (Eds.) *Research into Design Thinking*. Delft: University Press
- Schön D, (1987) *Educating the Reflective Practitioner: Toward a New Design for Teaching and Learning in the Professions*. San Francisco: Jossey-Bass
- Simon, Herbert A. (1996) *The Sciences of the Artificial*. 3rd Edition. Cambridge, Massachusetts: The MIT Press (1st Ed. 1969)
- Solovyova I, (2003) Conjecture and Emotion: An Investigation of the Relationship Between Design Thinking and Emotional Content. In *Expertise in Design – Design Thinking Research Symposium 6*. Sydney: Creativity and Cognition Studios Press
- Tschimmel K, (2004) A new discipline in Design Education: Cognitive Processes in Design. In *The Changing Face of Design Education. Proceedings of the 2nd International Engineering and Product Design Education Conference*. Delft: TU Delft, 175–184
- Tschimmel K, (2005) Training Perception – the Heart in Design Education. In *Proceedings of the International Conference on Design Education: Tradition and Modernity (DETM05)* Ahmedabad: National Institute of Design
- Wallas G, (1926) *The art of thought*. New York: Harcourt

Verbal Stimuli in Design Creativity: A Case-study with Japanese Sound-symbolic Words

Céline Mougenot¹ and Katsumi Watanabe^{1, 2, 3}

¹ The University of Tokyo, Japan

² Japan Science and Technology Agency, Japan

³ Japan National Institute of Advanced Industrial Science and Technology, Japan

Abstract. Design practitioners not only manipulate images but also words. In this paper, we propose to investigate the role of language in design and more specifically the potential for linguistic stimulation on creative thinking. Through an interdisciplinary approach in design science and linguistics, we propose to examine the role of Japanese sound-symbolic words in the context of creative design thinking. In fact, this paper reports a unique characteristic of a specific language, Japanese, and comments on its relevancy in the context of design practice: sound-symbolic words in Japanese (more precisely, psychomimes) help expressing and conveying a concept, as an emotion or a feeling, that is otherwise difficult to verbalize and thus they appear to be useful in designers' practice. An on-going experiment is presented here.

Keywords: Design process, Language, Kansei, Emotions, Japanese sound-symbolic words, Inspirational sources

1 Introduction

So far, most work on design creativity has focused visual creativity: design researchers mainly aimed at understanding the role of visual information, like images, in the design process. For a state-of-the-art of visual inspirational sources in design, the reader can refer to (Mougenot et al., 2008, 2009). Since verbal communication is also continuously used by designers, researchers recently became interested in the role of language in the design process. The objective of such investigations is twofold: on one hand, such studies create knowledge on human cognitive abilities and skills. On the other hand, such research brings necessary inputs for developing language-based computational tools to support design.

In this context, we introduce an on-going study aimed at examining the role of language in design context and more specifically how emotions are communicated by designers through language. As a case-study, our research explores the use of special type of words, called sound-symbolic words. These words, to be found in a few languages like Japanese,

are close to onomatopoeias in English language but they express a variety of concepts, like tactile or visual perception, emotions, feelings, atmospheres...which appear to be a very relevant property in the context of *kansei* design (or emotional design).

Our paper is structured in three sections. Past studies investigating the role of language in design are reviewed in the first section. Then we describe the specificities of Japanese sound-symbolic words and explain why we think they might have an interesting role in design. Finally we report an on-going experiment that compares the influence on design creativity of two types of verbal stimuli in Japanese language: sound-symbolic words and regular words.

2 Roles of Language in Design

As suggested by (Dong, 2006), language in design can play two roles. First, language is used for representing ideas and concepts through linguistic behaviors that represent the structure of thought during the design process. But language can also be seen as a tool to perform actions. This vision is described in more details in another paper (Dong, 2007): in this paper, the author raises the question how the language of design relates to the production of the designed work and design practice. As a reply, a theory on the performativity of the language of design is proposed. More specifically, one of the issues covered by the proposed theory is that the language of design enacts design through three performative operators:

1. aggregation : to blend ideas and concepts
2. accumulation : to scaffold ideas and concepts
3. appraisal : to evaluate and assess ideas and concepts.

In line with this author, we propose that language in design serves as an inspirational stimulus for

individual designer and a support of design communication between several parties (designers, users...). Although previous studies are broken down into these two types in the following paragraphs, we think both aspects are closely related and actually difficult to discriminate.

2.1 Language as an Inspirational Stimulus

Transforming keywords into visual images is a common operation processed by designers, which was studied by (Nagai and Noguchi, 2002). The focus was about the way designers think with drawings in order to generate visual images of an artifact. In doing so, designers have to link low-level information (drawings, artifact) with high-level information (abstract keywords) and thus, the creative thinking process needs an overall high abstract level when having to create a visual image from a verbal stimulus. The transformation of a verbal stimulus into visual imagery can be seen as a specificity of design practice in which language plays a major role.

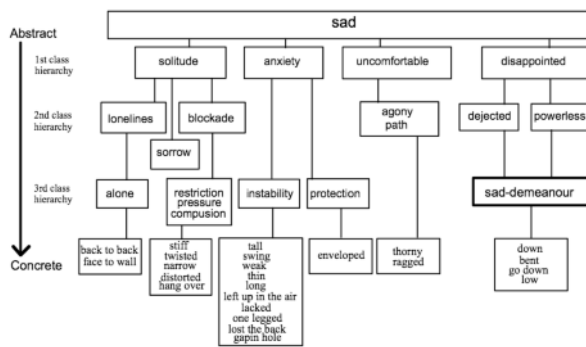

Fig. 1. From an abstract keyword to concrete design properties, as explained by (Nagai and Noguchi, 2002)

In a study on the role of verbal stimuli in design creativity (Goldschmidt and Litan Sever, 2009), 35 industrial design students had to solve design problems under three various conditions:

1. without any stimuli
2. with texts related to the given problem
3. with texts unrelated to the given problem.

External judges then evaluated the generated sketches. Grades were given for originality and practicality on a 1-5 scale. In the case of text stimulation, design outputs received significantly higher creativity grades, while practicality grades were not affected. The authors suggest that textual stimuli might be useful in the design process and also as an educational tool in design studio.

2.2 Language as a Support for Communication

Language also serves as a major support of design communication. Designers usually explain their ideas through a combination of drawings and verbal information. Especially when dealing with abstract concepts or emotional aspects (*kansei*) of a product, designers use words. A study in the field of textile design investigated how *kansei*-idea explanations are used to share feelings and emotions among designers (Ogawa et al., 2009). Based on this description, an ontological engineering approach was proposed to support *kansei*-ideas sharing in a design team.

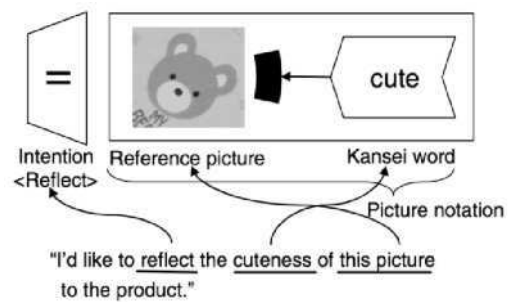

Fig. 2. Design communication based on a picture and a *kansei*-word, as explained by (Ogawa et al., 2009)

The figure above shows the process of communication among designers: to share a “*kansei*-idea”, designers usually associate visual information (images) and textual information (words, *kansei*-words).

3 Words Expressing Emotions: Japanese Sound-symbolic Words

3.1 Japanese Sound-symbolic Words can Describe States and Emotions

Some languages possess a category of words midway between onomatopoeias and usual words, called “sound-symbolic words”. Whereas onomatopoeia refers to the use of words to imitate actual sounds, sound-symbolic words embody soundless states or events, they are called **phenomimes**, words that describe external phenomena, and **psychomimes**, words that describe psychological states.

In the case of Japanese language, there are about 1700 sound-symbolic words, which is about four times more than in English. These words play such a major role in all types of verbal expression several major studies investigated them, e.g. (Akita, 2009).

Since Japanese sound-symbolic words are learned in early childhood, they are used very spontaneously and they are considerably more effective than usual words in conveying feelings and moods or in describing states, motions, and transformations. Interestingly, these words are not childish vocabulary like in French language (*atchoum, beurk, patatra*) or English (*beep-beep, vroom, burp*). In Japanese, their meaning is complex and thus very useful in daily conversation among adults and even in formal written language.

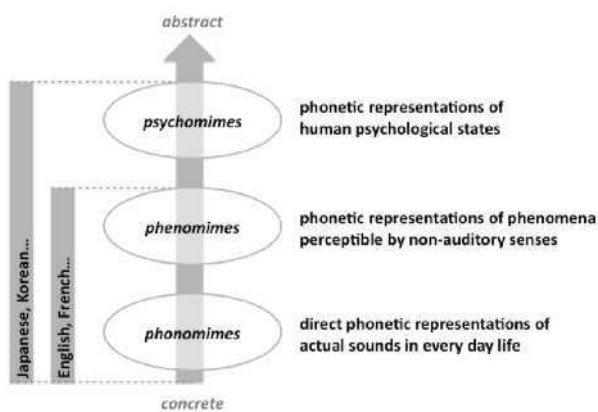

Fig. 3. Hierarchy of types of sound-symbolic words on an abstract-concrete scale

The grammatical function of sound-symbolic words is essentially limited to that of adverb, but a mimetic word could function as an adjective, verb etc... Some words could function both as onomatopoeia and mimetic words, though the meaning changes, normally leaving only a slight association between the two meanings. Some mimetic words can be used as verbs by attaching the generic verb “suru” (to do).

The two examples below put in light the variety of aspects expressed by sound-symbolic words:

- shikushiku (しくしく / シクシク)
emotions: whimper, sob
sensation : a gripping, nagging pain
onomatopoeia : sobbing, whimpering
- shittori (しっとり / シットリ)
sensation : soft, gentle feeling
onomatopoeia : calm, soothing
personal traits : calm, placid (elegantly)
physical state : lightly moist
smells : a pleasant, tasteful odor
surroundings : calm, delicate

One single word can express a sensation, trait of personality, a physical state, a smell, a surrounding atmosphere.

3.2 Studies on/with Japanese Sound-symbolic Words

A few studies have focused the use of Japanese onomatopoeias. Understandably, most studies were in the field of linguistics (Hasada, 2002; Akita, 2009), trying to build lexicon and to propose a grammatic approach to sound-symbolic words. Some studies have a cognitive or neuroscience perspective (Rohrer, 2001) (Hasada, 2002; Osaka and Osaka, 2005; Vigliocco and Kita, 2006; Imai et al., 2008), where for example the effect of sound-symbolic words on learning process are examined. Other studies investigate the link between acoustical dimension and perception of these onomatopoeias (Fujisawa et al., 2006).

To our knowledge, onomatopoeias have never been used in any design-related studies. The closest study to our field is reported by (Takahashi et al., 2010) who used onomatopoeias as a tool for describing inter-individual communication and its associated emotions. With the general objective of designing user-friendly communication interfaces, the researchers investigated the perception of scenes where people were interacting in a non-verbal mode. Participants to the tests had to evaluate the desirability of the scene; they also had to select from a list the onomatopoeias that best described the scene. The selection of an onomatopoeia was an easy and intuitive way for Japanese participants to describe the scene. A Principal Component Analysis showed that onomatopoeias describing a warm atmosphere, i.e. *hono-bono*¹ and *hoka-hoka*², were associated with the most desirable types of inter-individual communication scenes.

This study put in light the fact that onomatopoeias can help expressing or conveying a concept that is difficult to verbalize; this property is particularly relevant in the context of design communication where designers have to express emotions through language.

4 Experimentation

We carried out a research in two steps. First, a design experiment examined how onomatopoeias are a

¹ peaceful, harmonious

² warm and pleasant feeling, to glow with warmth

relevant tool in design communication. We report here our observations on annotated sketches. In a second stage, we further explored the possible effects of onomatopoeias in design, using onomatopoeias and regular words as design stimuli.

4.1 Study 1: Sound-symbolic Words in Design Communication

4.1.1 Protocol and Participants

The first experiment aimed at identifying whether sound-symbolic words are used in design. The participants were 25 students from the University of Tokyo and from Temple University (Japan Campus). They were from various nationalities: Japanese, Japanese-American, Chinese, French and Swiss. 18 participants were native Japanese-speakers.

The context of the experiment was a design project described in (Mougenot et al., 2010). The participants were invited to individually “design a novel type of chair”, after having received various types of inspirational stimuli, which are not necessary to be described here. The participants were said that they could annotate their sketches for giving detailed explanations about the design concept.

Then our analysis focused the nature of words the participants used for annotating their sketches, with a special attention to differences between the cultural backgrounds (Japanese vs. non-Japanese).

4.1.2 Observations

We collected the sketches annotations written by the participants. It was observed that one third of the Japanese participants (6) used sound-symbolic words while the participants speaking another language did not use sound-symbolic words at all. The sound-symbolic words used by the six participants are reported in the following table and figure.

With regard to the stimuli given to the participants, it is interesting to identify the relationship between ideas that come to designer’s mind and sound-symbolic words used to describe the sketched concept. For example, some participants had to design a chair concept that embodied the sound of a crying baby.

The figure 5 shows the mental steps from the stimulus used to support creativity (here the sound of a crying baby) to the concrete representation of an artifact and its related annotations.

Table 1. For each sketch displayed below, design stimulus and sound-symbolic words used as annotation

1 > Sound of crying baby fuka-fuka: soft	2 > Sound of waterfall yura-yura: wobbling
3 > Sound of crying baby puyo-puyo: springy	4 > Sound of hairdryer boro-boro: tattered
5 > Sound of crying baby fuwa-fuwa: fluffy	6 > Sound of fireworks hira-hira: frill fuka-fuka: soft

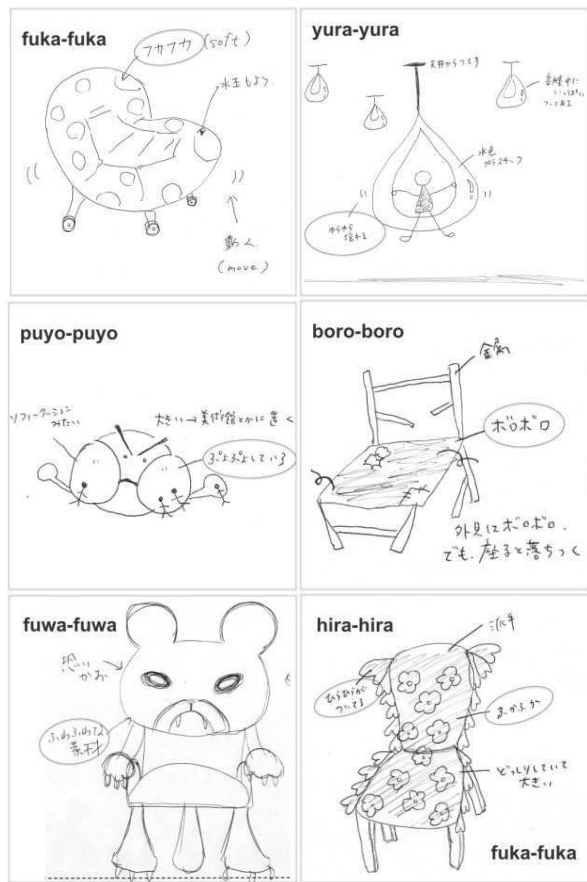

Fig. 4. Samples of annotations on design sketches



Fig. 5. From design concept to sound-symbolic words

We observed that onomatopoeias not only described physical properties of the artefact but also impressions to be perceived by the future user of the artefact. For example, the chair described as “fuka-fuka” is supposed to be soft, with a fluffy texture and to provide a pleasant tactile feeling.

4.1.3 Discussion

First, we observed that the proportion of sketches annotated with onomatopoeias was quite high, since actually only 18 people had Japanese as their mother language and could potentially use onomatopoeias. One third of Japanese-speaking participants used sound-symbolic words, while none of speakers of other languages used them.

The sound-symbolic words used to annotate the sketches reflected various aspects of the product they sketched, like tactile and visual qualities (Table 2).

Table 2. Sound-symbolic words used in the sketches

Onomatopoeias	Evoked design aspect
fuwa-fuwa (fluffy) fuka-fuka (soft) puyo-puyo (springy)	Tactile
hira-hira (frill) boro-boro (tattered) yura-yura (wobbling)	Visual

Sound-symbolic words are frequently and easily used and they can express various aspects of designed artifacts or its interaction with users, including states and emotions. These findings support the idea that onomatopoeias are very relevant in the context of design communication.

4.2 Study 2: Sound-symbolic Words as Inspirational Sources

In a second stage, we aimed at exploring the role of onomatopoeias in inspiration and creativity. We report here the preliminary results of the second stage of experimentation.

4.2.1 Research Objective and Hypothesis

As we saw earlier, onomatopoeias allow designers to evoke several aspects related to products, like physical properties, emotional properties and impressions. From a reverse point of view, what about the effect of onomatopoeias on the product creativity?

We formulate the following research hypothesis: Since onomatopoeias convey many useful aspects in the context of design, they might positively influence the level of design creativity compared to non-

onomatopoeias words. More precisely, we expect that stimulation based on sound-symbolic words will lead to the design of products with higher user-friendliness and affective value.

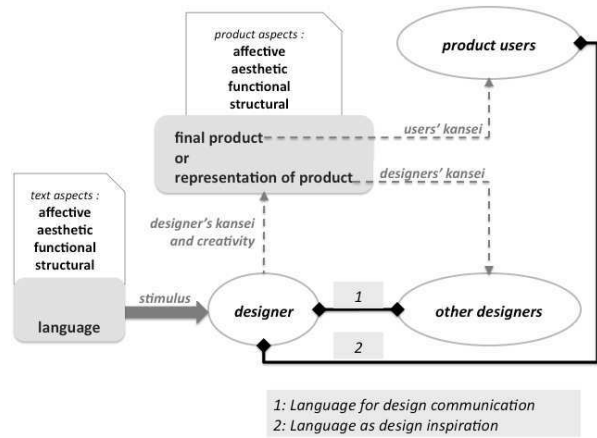

Fig. 6. Link between language and emotional design

4.2.2 Protocol and Participants

The study was conducted in Japan and the participants were 24 students from The University of Tokyo. Each participant has to sketch 2 different products (Pi) : P1: a chair, P2: a pair of glasses. This is to avoid fixation effect, when all novel ideas could be embodied in the first creative outputs, and the second one would be too similar to the first one.

One word, either a “regular” word or an sound-symbolic word with a close meaning, was provided in the design brief and participants were prompted to use this word as an ideation-stimulus.

Two adjectives were used: masculine and happy. For both words, a regular word and an sound-symbolic word were found, as described here:

- “Masculine” >“Regular” word:男性的
>Onomatopoeia:がっしりした
- “Happy” >“Regular” word:楽しい
>Onomatopoeia:うきうき

For example, one participant could receive the following instructions then he/she had to sketch one concept on one A4-sheet.

- Sheet #1: Design a “happy (sound-symbolic word)” + “glasses” concept
- Sheet #2: Design a “masculine (regular word)” + “chair” concept

The participants were divided into four groups. Each participant has to sketch 2 concepts of products, following the order that was indicated in the form in order to globally balance any order effect.

We collected a total of 48 sketches broken down as follows (Table 3):

Table 3. Experimental design

Verbal stimulus / meaning	Verbal stimulus / word type	Product to be designed	Number of sketches
happy	regular word	glasses	12
happy	sound-symbolic word	glasses	12
masculine	regular word	chair	12
masculine	sound-symbolic word	chair	12



Fig. 7. Example of (“happy” (sound-symbolic word) + “glasses”) concept

Below are samples of sketches by two different participants who had to design “happy” + “glasses”. The first example was based on the sound-symbolic word, the second example on the regular word.

Figure 7 shows a concept of glasses in which a music display system is integrated, thus the person wearing these glasses can listen to music.

Figure 8 shows a concept of glasses which reflect the mood of the wearer. If the wearer is in a happy state, then flower patterns will appear on the outside face of the lenses in order to communicate this mood toward surrounding people. If the wearer is in a sad mood, the flower pattern will appear on the inside face of the lenses in order to entertain the wearer and improve his mood.

4.2.3 Future work

The sketches will be assessed by external judges. The ratings will then be analyzed in relation with the properties of the sketched design concepts: various aspects of the design concepts will be examined. Thus we expect to identify relationship between sound-symbolic words and emotional value of the product.



Fig. 8. Example of (“happy” (keyword) + “glasses”) concept

5 Conclusion and Perspectives

Recently, there has been a growing interest in studying the role of language in the design process. Our research aims at contributing to the understanding of the way designers use language in their practice:

1. language as a design communication tool between designers, seen from a collaborative point of view
2. language as inspirational sources for stimulating creativity

Language is often used by designers in combination with visual representations, drawings for example. When dealing with highly abstract concepts, like emotions, atmospheres, feelings that has to be conveyed by the product they design, designers can use abstract words that convey emotions or feelings.

In this context, we proposed an original investigation based on the use of sound-symbolic words, found in high proportion in Japanese. In our experimentations, we observed that sound-symbolic words are frequently and spontaneously used for design communication purposes. We also suggest that they tend to support the design of products with a higher emotional value when used as inspirational stimuli; this will be investigated further in the next stage of the study.

In the wider context of design science, sound-symbolic words can be approached as an investigation support to understand the role of language in design. In fact, although this study is based on a unique characteristic of a specific language (Japanese), it may enable to understand the way verbal information stimulates creativity and the way designers mentally manipulate abstract concepts like emotions and feelings. This study may also suggest that design cognitive processes are strongly linked to cultural specificities as language.

Acknowledgements

This study is supported by a Grant-in-Aid for Scientific Research and a Post-doctoral Fellowship for Foreign Researchers from the Japanese Society for the Promotion of Science (JSPS).

The authors are grateful to Dr. Kimi Akita (University of California in Berkeley & University of Tokyo) for his valuable comments on Japanese sound-symbolic words.

References

- Akita K, (2009) A Grammar of Sound-Symbolic Words in Japanese: Theoretical Approaches to Iconic and Lexical Properties of Mimetics. Ph.D Thesis (Linguistics), Kobe University, March 2009
- Dong A, (2006) Concept formation as knowledge accumulation: A computational linguistics study. *Artificial Intelligence for Engineering Design, Analysis and Manufacturing* 20:35–53
- Dong A, (2007) The enactment of design through language. *Design Studies* 28(1):5–21
- Dong A, Kleinsmann M, Valkenburg R, (2009) Affect-in-cognition through the language of appraisals. *Design Studies* 30(2):138–153
- Fujisawa N, Obata F, Takada M, Iwamiya S, (2006) Estimation of the subjective impression of auditory imagery evoked by 2 mora Japanese onomatopoeias. *Proceedings of the 2006 Spring Meeting of Acoustical Society of Japan*, 419–420
- Goldschmidt G, Litan Sever A, (2009) From text to design solutions: Inspiring design ideas with text. *Proceedings of ICED'09, International Conference on Engineering Design*. Stanford, August 24-27, 2009
- Gomi T, (2004) An illustrated dictionary of Japanese onomatopoeic expressions. Ed. Kodansha
- Hasada R, (2002) Meanings of Japanese Sound-symbolic emotion words. in *Emotions in Crosslinguistic Perspective*. Harkins J, Wierzbicka A (Eds)
- Imai M, Kita S, Nagumo M, Okada H, (2008) Sound symbolism facilitates early verb learning. *Cognition* 109(1):54–65
- Mougenot C, Aucouturier JJ, Yamanaka T, Watanabe K, (2010) Comparing the effects of visual and auditory stimuli in design creativity. *Proceedings of the Third International Workshop on Kansei*, Fukuoka, Feb 22-23
- Mougenot C, Bouchard C, Aoussat A, Westerman SJ, (2008) Inspiration, Images and Design: An Investigation of Designers' Information Gathering Strategies. *Journal of Design Research* 7(4):331–351
- Nagai Y, Noguchi H, (2002) How Designers Transform Keywords into Visual Images. *Proceedings of C&C'02 Creativity and Cognition*, Loughborough, UK.
- Nagai Y, Taura T, Mukai F, (2009) Concept blending and dissimilarity: factors for creative concept generation process. *Design Studies* 30(6):648–675
- Ogawa T, Nagai Y, Ikeda M, (2009) An ontological approach to designers' idea explanation style: Towards supporting the sharing of kansei-ideas in textile design. *Advanced Engineering Informatics* 23(2):157–164
- Osaka N, Osaka M, (2005) Striatal reward areas activated by implicit laughter induced by mimic words in humans: a functional magnetic resonance imaging study. *Neuroreport* 16(15):1621–1624
- Rohrer T, (2001) Understanding through the body: fMRI and ERP investigations into the neurophysiology of cognitive semantics. Talk presented at the 2001 International Cognitive Linguistics Association, Santa Barbara: University of California
- Takahashi K, Mitsuhashi H, Norieda S, Sendoda M, Murata K, Watanabe K, (2010) Japanese Onomatopoeias and

Sound Symbolic Words in Describing Interpersonal Communication. Proceedings of KEER 2010, Int. Conf. on Kansei Engineering and Emotion Research. Paris, March 2-4

Vigliocco G, Kita S, (2006) Language-specific properties of the lexicon: Implications for learning and processing. *Language and Cognitive Processes* 21(7-8):790-816

Visual Representation in Design

Creative Collaborative Strategies of Remote Sketching on Design

Luz-Maria Jimenez-Narvaez and Arturo Segrera

Creation of New Fashion Illustration Painting Techniques by Use of India-ink Painting Techniques:
Research into Line Drawing Techniques of Expression in Fashion Illustrations

Sachiko Nagasawa, Shin'ya Nagasawa and Kazunari Morimoto

How Uncertainty Helps Sketch Interpretation in a Design Task

Winger S.W. Tseng and Linden J. Ball

The Complementary Role of Representations in Design Creativity: Sketches and Models

Alejandro Acuna and Ricardo Sosa

Creative Collaborative Strategies of Remote Sketching on Design

Luz-Maria Jimenez-Narvaez^{1,2} and Arturo Segre³

¹ National University of Colombia, Canada

² MATI-Montréal, Canada

³ Industrial Design School of Montreal University, Canada

Abstract. In this exploratory investigation we present the analysis of creative team strategies of remote sketching used during the meetings of three design teams while interacting with a client that had requested their services for the design of the graphic image of a research laboratory. During the experiment, the groupware softwares for synchronous work, Skype and Vyew, were used. The teams make the selection of the ideas, once these are drafted, in a verbal way. This process involves work cycles in which the nominal work requires verbal communication for the group idea selection; as for the simultaneous work, the audio conference needs to withstand the whole process of group idea formation. Without the synchronous verbal communication, the exchange or the selection of ideas, which will lead to the formation of group ideas, would not be possible.

Keywords: creative team strategies, remote sketching, team idea production, remote layout drawing, collaborative design work

1 Introduction

1.1 Analysis of the Generation of Ideas in a Team

The generation of ideas is “the ability of the individual to produce ideas expressed in language or other media is an important human characteristic” (Carroll, 1993, p. 394). The quantitative factors of this ability can be summed up in factors such as: “fluidity” and “creativity” (Idem). For Carroll, the term “idea” has a more broad meaning: “an idea can be expressed in a word, a phrase, a sentence, or indeed any verbal proposition, but it may be something expressed in a gesture, a figure, a drawing, or a particular action” (Idem). A creative idea differentiates itself from other expressions because it is neither a process of acknowledgement nor a descriptive process, but manifests itself as a solution to a problem.

According to Schneiderman (2000) the creative process of a team is completed when there exists the construction of novel knowledge based on the prior knowledge of the participants. The work of a team would involve communication as the principle medium towards social refinement and the dissemination of ideas. The creativity process of a group has not been described in depth (Paulus and Nijstad, 2003; Taggar, 2002) since the great majority of studies has focused on the individual creativity and the incentives of personal strategies: “your (personal) creative power” (Osborn 1948; and specially Osborn, 1974, p. 66).

In design, the Goldschmidt (1995) study evaluated through means of a protocol of parameters of productivity, the individual and group performance during the conception stage of a racing bike. This study demonstrated that the creative work of a group is not necessarily superior to the one of an individual in terms of creative productivity (Lamm and Trommsdorff, 1973). The main difference concerns the reduced time needed to execute complex tasks in which there is no competence between one of the participants. In any case, the group creativity can be described as the sum of individual processes or the result of the social interaction amongst the participants. In general, the teams meet and interact informally during the process of the ideas production and in this process there exists a kind of auto-organized synergy that allows the participants to design as a team.

1.2 Sketching in a Team

Arheim (1993) defines two types of visual representations: the mental images produced by memory and those that are generated by abstraction. In team design, the exchanges performed by graphic

representations will be done by means of comparison within the group of *layout drawings*¹, the abstract representations and through the images (photos, illustrations, realistic renderings or views of existing objects). These graphic representations turn into a visual language that allows a dynamic collaborative communication.

In this article, we will consider the layout draft as a graphic language for the exchange of ideas within the process of group idea conception. This language allows for the adequate tackling and resolution of any design problems. The proposal of sketching as a language of ideas production is analysed by Goldschmidt (1991) starting from verbal protocols carried out by means of observation during the execution of sketches. With this as a starting point, Goldschmidt deduced that the utilization of sketches is an operation of “interactive imagery” (p.131) that generates an internal and an external dialogue of production and evaluation of ideas. The drafts are not pre-established images, but they rather develop “within a context of explanation” (Idem). In addition, the sketch facilitates the explanation of the composition of the object and the interrelation between the parts and its context.

The sketching reflects a process of refinement of the ideas, in the sense that the first ideas of the group will be “tentative, generic, and vague”. Subsequently, the sketch becomes specific in a context like Arnheim said “rather it has the positive quality of a topological shape. As distinguished from geometrical shapes, a topological shape stands for a whole range of possibilities without being tangible committed to anyone of them. Being undefined in its specifics, it admits distortions and deviations. Its pregnancy designer requires in the search for a final shape” (p.71).

On this point, Pucell and Gero (1998) emphasize the multidisciplinary use of sketching in all of the phases of a product conception. These authors affirm the variation of the type of the layout draft produced, depending on how advanced the stage of the project is. This way, in the first phases of the definition of a product, the sketches will be vague and undefined. However, once the project is better defined, the

industrial drawings, the realistic rendering and the construction plans will be used. Pucell and Gero suggest that sketching has three concrete functions in the process of problem resolution. Sketches perform an interrelation process amongst: “1) short term memory, 2) imagery reinterpretation and 3) mental synthesis” (Ibid). Likewise, Van der Lugt (2005) shows that sketches allow to: 1) support a new cycle of interpretation of the thought, 2) to uphold the reinterpretation of the ideas in group work and 3) improve access to ideas on an earlier stage.

Inside the process of the ideation stage and the evolution of the design project (Eastman, 1999), the drawing is accompanied by a description paper with the technical characteristics of the product, whether structural or abstract, such as the mechanical structure, of the “cinematic representations, the systematic force analysis, the structural resistance or the means of assembly” (Shah al., 2001, p. 169) of the products.

Presently, there is an ongoing debate on the role of sketching in the process of the conception of ideas in design. Gero, Pucell and Bilda (2006, also see: Gero and Bilda, 2008) propose a new perspective onto the idea production in design, that designers can design without drawing; however, in our article our aim is to understand how teams that work from a distance, share their ideas through the use of remote sketching. Subsequently, we will discuss in more detail our considerations on remote collaborative working.

1.3 Sketching in a Team

There are many reasons to evaluate the importance of remote sketching, principally, those related to new working conditions: the delocalization of teams, the interaction with external experts, as well as the other players in the design process: users, providers, to name a few. The evolution of computer technology and communications –ICT allows for a more dynamic exchange of information between all agents involved in the execution of complex projects. Ozkaya and Akin (2005, p.5) explain that “collaborative design implies the collaboration of distinct individuals with different areas of expertise or knowledge to work towards the accomplishment of common goals, simultaneously or chronologically, and co-locationally or remotely”.

An extensive part of development in the area of remote creative collaboration, has been dedicated to technologies CAD and *technical collaboration* (Kalay, 2004), such as, the use of file sharing software. Although in the case of the remote sketching process, we would have to highlight what Kalay explained as, *creative collaboration* centred around a “process of shared creation, where the exchange de ideas among the participants helps to stimulate and enrich their own

¹ A layout drawing corresponds to: “The first step in transition from idea to item is design. Here the engineer (designer) takes the pencilled notes, the scribbles on backs of envelopes, the brainstorm ideas, the design sketches on cafeteria napkins, and weaves them into the first designs of the new device.... Design begins when the designer... makes the first lines that begin to skeletonise the device” (Bronikowski, 1986, p. 387 in Termiun Plus, 2010)

creativity” (Ibid, p. 405). One of the main considerations one should have in mind concerning working from a distance is the implementation of the layout drawing. The new groupware for online work: the Web conference online programs or “virtual collaborative space”, incorporate an interactive whiteboard that allows users to visualize and share every stroke that a participant performs. We are interested in analysing and verifying the potential of such kind of tools for sketching and communicating from a distance.

Team sketching from a distance can be the visual sharing of a digital copy of a pencil made sketch or of a sketch created using specialized design computer software. An outline of project involves a verbal discussion along with the synchronous execution of sketching traces. For the time being, several limitations exist for this type of layout drawings; primarily concerning the preference of designers for the use of hand and paper drafts instead of computer peripherals such as the graphic tablet. As for the use of the interactive whiteboard, teams are not accustomed to sharing simultaneously the visualization and the accompanying explanations of the sketches.

In the area of team sketching, individual participation depends on the internalization of personal ideas and the exchange with others, in this case, “the sketches are a useful tool for checking and conveying ideas, for self and others. They also serve as an external display to facilitate inference and discovery, to go from the intended to the unintended, to go from the seen to the unseen” (Tversky, 2002). Heiser al. (2004) also highlights that group sketches “serve as a platform for inference, reasoning and insight” (p.1) and “the virtues of a shared sketch in creating and maintaining common ground and in serving as a joint product should be effective in enhancing collaboration on abstract problems as well as concrete ones.”(p.9). It is important to note that in team sketching the process is focused on the “interaction between participants”, the existence of an evaluation process, and the benefits of collaboration (Ibid). So in other words, the role of sketching in team work is oriented mainly towards:

- Exploring and triggering the iterations of individual or group ideas in the dynamics of the design process;
- Encouraging communication between participants about the graphic externalization of the first ideas without a clear verbal explanation. (See the work of Nagai and Noguchi, about the transformation of key words into images 2003; 2008).

- Highlighting and evaluating graphic proposals developed by the group.

Although there are other creative techniques fundamental to collaborative design work, such as, *e-Sketch* by Shah al. (2001) or *Brainsketching* by Van der Lugt (2002), we consider this emerging field to be in great need of exploration, particularly through the evaluation of repercussions in academic and professional design development.

Through this study, our goal is to analyse the team work of designers in a synchronous space. The new technological developments of the synchronous work systems (web conference systems and the interactive whiteboard), allow us to enquire into the possibility of team sketching from a distance, especially on which strategies and interactions manifest themselves during the exchange of ideas through electronic and synchronous sketching.

2 Case Study

The main motivation behind this study is to explore creative strategies in the areas of computer science and remote team collaboration. For this reason, we present the following case study which focuses on the analysis of creative behaviour in teams at the initial stage of the design process.

In a laboratory, experimental studies on creativity emphasize the quantitative measurement of the production of an individual's ideas (Smith al. 2003). In our case, due to the explorative nature of the study and the conditions of the team activities, we couldn't determine beforehand the experimental variables; we only had access to the manipulation of the experimental task in our study proposal. Creative experiments generally focus on the analysis of creative output, in other words, the quantity or quality of the ideas produced. In our case, we wanted to analyze the creative group behaviour in collaborative activities. So we were only able to control the experimental task by introducing a problem within the professional scenario, that is to say, a problem which presents itself between a client and a designer (Cross, 2007). This simulation leads the participants to work collaboratively.

2.1 Method

The study involved seven subjects that were geographically dispersed². The seven participants consisted of the following: A director of a research laboratory of cognitive ergonomics that appeared as a client and 6 designers (4 female and 2 male) with more than 5 years of professional experience each. The designers were divided in three teams of two. T1, a pair consisting of an industrial designer and a graphic designer (two females), T2 two industrial designers (males). The members of T1 and T2 have more than 15 years of individual professional experience and personally know each other but had not worked together before. T3 consisted of 2 industrial designers (females) that offer their services as a team to small scale companies for the past 4 years.

Task

The task at hand was to design the graphic image of a research laboratory. The task was proposed and carried out having in mind that the participants assume different roles in the function of the team. On the client side, the participant was required to express his request within 15 minutes in a precise manner and to supply sufficient information on the research laboratory in order to create a credible experimental/work scenario for the others participants. From their part, the designers had to have sufficient design abilities in order to come up with several different design proposals within a time span of 30 minutes.

System and procedure

After a thorough evaluation of groupware programmes for synchronous work in conjunction with the investigation team (Blond, 2009; Jimenez, 2010), the web video conference system and the interactive whiteboard of Vyew (www.vyew.com) were chosen along with Skype (www.skype.com) for audio communication amongst the participants. Vyew has the advantage of offering a complete palette of design tools and the ability to open several worksheets that allow for simultaneous sketching amongst the participants. In figure 1 we present Vyew along with its several functions. Each participant was located in a

workplace, working on a notebook equipped with a web camera and a graphic tablet.

The interactions amongst each and every one participant through the system, were recorded using the software Morae®. This programme does not allow the creation of independent or free quotations during the observation of the activities of the participants. For this reason, the recordings were transferred into AVI (Audio Video Interleave) format audio video so that they can be subsequently analysed with the content analysis software Atlas TI® version 5.2. This software allowed us to analyse the graphic content of each worksheet that was produced by the teams as well as the verbal content of their interactions.

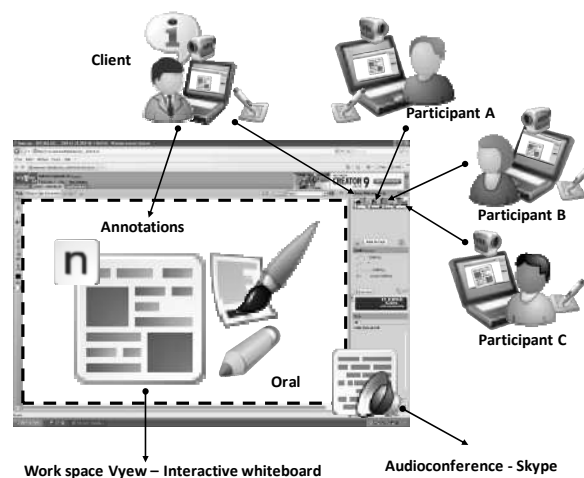

Fig. 1. Graphical depiction of the utilized systems (Vyew and Skype)

3 Analysis of Collaborative Sketching Production

Concerning the analysis of the collaborative sketching production, Carroll cites the *Kit of factor-referenced cognitive test* of Ekstrom and Harman (1976) which includes a measuring instrument for the figurative fluidity, such as one's ability to "the ability to draw quickly a number of examples, elaborations, or restructurings based on a given visual or descriptive stimulus" (in Carroll, 1993, p. 432). Each design sketch represents a unit which is measured without reference to its quality or legibility; what matters is the produced quantity.

In the collaborative design teamwork analysis of Visser (2009) on the graphic ideas production, it is suggested that each idea represented graphically should be analysed as a *unit*. Smith al. (2003) examine whether this process of accounting of the verbal

² This experiment was performed by Blond (2009) and Jimenez (2010) under the direction of profesor Jean-Marc Robert of Polytechnic School of Montreal and the Maison de technologies de information of Montréal (MATI-Montreal) at the Laboratory of usability. www.matimtl.ca

expression, whether graphical or gestural, by units, is presented in all the tests of experimental analysis of the ideas production. In our study we use this approach in order to identify the graphic units created within the dynamic of the teams.

3.1 Analysis of the Production of Work Ideas

The client has a meeting with each team, presenting to them his demands in verbal form in order to define the design in question, for 10 minutes. Afterwards, the teams verbally interact with the client for 11 (T1), 15 (T2) and 6 (T3) minutes. During this period, the teams formulate questions for the client in order to establish common points of reference and make the request as specific as possible.

The first part of the work of the team is realised in a verbal form, the sketches accompany the verbal discussion that was centred around the selection of the “work categories” (Vargas-Hernandez al., 2001), also referred as “the work ideas” by Lawson (in Cross, 2007).

These initial ideas are key-words directly originating from the client's request. The teams concentrate in making sketches that describe these words and explore the images within their figurative context as demonstrated in figure 2.



Fig. 2. Details of the worksheets of “work ideas” of T3 concerning client’s request

Once the teams have selected the work ideas and the keywords to take into account, we observe that there exist two types of work inside the group: a) *a nominal work*, in which each participant draws their layout sketch on the same page in a parallel way and b) *a simultaneous work*, in which one participant draws while the other watches, talks or adds details. This kind of work organisation directly relates to the time the members of each team have spent working together and is a behaviour that has been observed by Isaksen

(1994) and has been defined as the time of maturing of the group.

We assume that in the context of this experiment, these characteristics were found in the participating teams, in which the form of organization of work depends on the time of maturity in working together. The T1 and T2 teams, who were not accustomed to work together demonstrated *a nominal work*, while the T3 team remained a working *simultaneously*. Two of the T1 and T3 participants expressed a preference for working alone on a sheet of paper. However, one designer of T1 expressed the preference to working alone, so that after this designer has understood the customer demand and had sufficient sketches; this participant began the process of sharing ideas.

In table 1 we can see that the way of individual ideas production obtains two different dynamics in accordance to this work organisation.

Figure 3 summarizes the work performed by the teams in the ideas production as well as the interactions amongst the iterations of ideas between team’s members. This type of organisation of the ideas production, observed at table 1, has a direct impact on the transformation of the ideas of the group. The ideas generated by the group are the result of the sharing, integration and elimination of the individually produced ideas.

In order to recognize them, we used the identification criteria proposed by Badke-Schaub and Frankenberger (2002); that consist of the analysis of the critical moment in which the designers intervene with the purpose of guide the ideas and align them to the restrictions imposed by the client's request, when they generate concepts that resolve the problem at hand or when they take decisions concerning the proposed ideas of their co-workers.

Table 1. Ways of work organisation to share “work ideas”

Team organization	Type of team idea integration	
Nominal/ Parallel	Selective Team asserts one idea of one member 	Additive Team takes one idea of each member
	Integrative Team joints all ideas of all members 	Inclusive The team takes one main idea of one member and adds details.

During the collective idea production: *co-production*, in the *nominal/parallel work*, we note that the teams T1 has a selective compartment and T2 has a additive compartment, these teams seem to show more individual iterations on the same “work idea” and that the team units correspond to the selection of the sketches of the others. On the other hand, during *interactive/simultaneous/synergic work*, the team T3 shows an integrative and inclusive compartment, in this team T3, theirs group idea integrates the interpretations of the work ideas of the participants: it shows more ideas integrations and more of the group ideas iterations like are showing for the team T3 in figure 3.

In Figure 3, we find a summary of the analysis of production of the graphic units drawn, in order to express the teams' ideas. As we have already mentioned, a *unit* is an idea expressed by the use of a word, a drawing or a gesture (Carroll, 1993). In the teams' general work we observed that verbal communication occupied an important place in the expression of ideas, this behaviour has also been observed by Johnson (2005) especially in the process of ideation. Once the corresponding verbalizations toward *the work ideas* have been expressed, for example, "we can use the USB symbol" (participant in T2), the participant proceeds to draw the "*work idea*". In this way, we are able to present the sum of individual ideas within each group, see the first row of Figure 3.

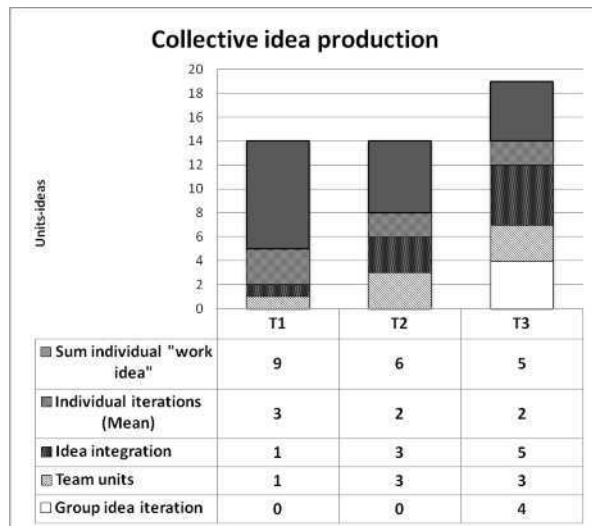

Fig. 3. Collaborative team ideas production in relation to the “work ideas” and individual interactions

Next, we can see in the second row, the average number of iterations each team directed at their own individual work ideas. We can see that the creative

behaviour in regards to the presentation of ideas of T1 is purely individual. Each participant works independently, without modifying nor intervening in the generating of their teammates ideas. Then in the third row, we see the integration of the individuals' proposed ideas, T2 and T3 are able to integrate their individual ideas and generate some *group units* observable in the fourth row. Finally, in the fifth row we see that only T3 succeeded at iterating in the ideas developed by the group.

Although, remote collaborative sketching was a new experience for all three groups, the participants expressed their satisfaction with the interaction, in the stage of ideation and in the use of synchronous tools (Blond, 2009). The teams relied mainly on verbal brainstorming and remote sketching as a tool for producing ideas in groups.

While the result of the quality variable (quality of the outputs: originality or rarity of the ideas) in regards to ideas was not studied, it was observed that in the strategies of creative collaboration two kinds of productivity could be seen: individual and group. Group productivity depends largely on the individual compartment or the individual ability to effectively integrate the ideas developed by all team members, which in turn depends on the environment and conditions of social interaction (Taggar, 2002; VanGundy, 1984), including those working in remote collaboration.

4 Discussion and Future Investigation

In synchronous remote work, the presentation of the client’s request and the work of selection of work ideas develop through verbal communication. On the stage of *co-production* the participants can organise themselves in order to exchange their ideas in a *nominal/parallel* way or in an organisation of ideas presented in an *interactive/simultaneous/synergic* way. This form of organisation seems to be in relation with the time of work maturity of the team (Isaksen, 1994). Only, T3 was showing this compoertement—they are the team with more time of previous work together.

Each way or organization will generate different patterns of communication and integration of the individual “ideas of work”. The teams make the selection of the ideas, once these are drafted, in a verbal way. This process involves work cycles in which the nominal work requires verbal communication for the group idea selection; as for the simultaneous work, the audio conference needs to withstand the whole process of group idea formation. Without the synchronous verbal communication, the

exchange or the selection of ideas, which will lead to the formation of group ideas, would not be possible.

In the beginning of this investigation, we were hoping that within a digital synchronous workspace, a sketching strategy would be the re-utilisation of the sketch traces created by the co-workers. However, the re-utilisation of the sketches or the copy/paste action was not observed in any of the teams. The designers prefer to re-utilise the work ideas that are expressed in a verbal manner and then initiate a new cycle of individual graphic interpretation of a “work idea” expressed verbally, than the copy of the drawings (which expressed initially those ideas of work) of their co-workers.

In future investigations, we would like to verify whether this characteristic manifests itself due to the lack of specific computer aptitudes from the participants, concerning these collaborative technologies or the use of electronic devices.

The choice of the Vyew system was made taking into account the several different sketching tools that are available in this software and the ease of use that the interactive worksheets of the whiteboard offer. However, the participants had difficulties using them for several reasons: Difficulties with digital sketching using a pencil and a graphic tablet, their preference for individual alone sketching on paper, as well as the discontentment the designers showed with the lag that there exists between the making of a sketch and the actual appearance of the image within the system. Also, two participants expressed a non agreement to have to sketching in a shared space; they would prefer the unaccompanied work in the sheet of paper –like an individual space (Blond, 2009).

The above mentioned difficulties justify our interest in continuing our investigation on the digital and synchronous sketching, as well as on the work forms that can optimize the dynamic of collective sketching and of course the development of new aptitudes that will allow participants to interact remotely, using these new technologies of synchronous work.

Acknowledgements

The authors would like to thank the Fonds québécois de la recherche sur la nature et les technologies (FQRNT) for the scholarship awarded to teacher Jimenez-Narvaez for her work in the project “Virtual spaces for the innovation”. Also, they extend their gratitude to Nikolaos Gryspolakis for the translation of the Spanish text into English and Debora McKinley for the last revision of the text.

The authors would appreciate receiving your comments at the e-mail: arturo.segrera@umontreal.ca

References

- Arnheim R, (1993) Sketching and the psychology of design. *Design Issues* 9(2):15–19
- Blond A, (2009) Étude de l'utilisation de logiciels de communication, de partage et de conception pour la réalisation de travail collaboratif à distance. M.Sc.A. dissertation, Ecole Polytechnique, Montreal, Canada
- Bronikowski R, (1986) Managing the engineering design function. New York, Van Nostrand Reinhold
- Carroll JB, (1993) Human cognitive abilities: A survey of factor-analytic studies. Cambridge, Cambridge University Press
- Cross N, (2007) Designerly ways of knowing. Basel: Birkhauser
- Eastman C, (1999) Representation of Design Processes, Conference on Design Thinking, MIT, April 23–25
- Gero JS, Purcell T, Bilda Z, (2006) To sketch or not to sketch? That is the question. *Design Studies* 27(5):587–613
- Gero JS, Bilda Z, (2008) Idea Development Can Occur Using Imagery Only. *Design Computing and Cognition '08*, Atlanta
- Goldschmidt G, (1991) The dialectics of sketching. *Creativity Research Journal* 4(2):123–143
- Goldschmidt G, (1995) The designer as a team of one. *Design Studies* 16(2):189–209
- Heiser J, Tversky B, Silverman, M (2004) Sketches for and from collaboration. In Gero JS, Tversky B, Knight T., (Eds.), *Visual and spatial reasoning in design III*:69–78, Sydney: Key Centre for Design Research
- Isaksen S, (1994) Facilitating creative problem solvent groups: An occasional paper of the creativity. [S.l.]: Buffalo State College
- Jimenez (2010) Étude expérimentale de la production collective d'idées en utilisant des technologies de collaboration synchrone à distance. M.Sc.A. dissertation, Ecole Polytechnique, Montreal, Canada
- Jonson B,(2005) Design ideation: the conceptual sketch in the digital age. *Design Studies* 26(6):613–624
- Koutamanis A, (2006) Digital sketching in a multi-actor environment. In *Design Computing and Cognition '06*: 103-121
- Lamm H, Trommsdorff G, (1973) Group versus individual performance on a task requiring ideational proficiency (brainstorming): A review, *European Journal of Social Psychology*:362–388
- Maher ML, Gero JS, Saad M, et al., (1993) Synchronous Support and Emergence in Collaborative CAAD. 5th International conference on computer-aided architectural design futures
- NagaiY, Noguchi H, (2003) An experimental study on the design thinking process started from difficult keywords: modeling the thinking process of creative design. *Journal of Engineering Design* 14(4):429–437

- Nagai Y, Noguchi H, (2008) How Designers Transform Keywords into Visual Images. In: Mougenot, C. Towards stimulating creativity in design: A model of informational activities in early phases of product design process. (Internet)
- Purcell AT, Gero JS, (1998) Drawings and the design process. *Design Studies* 19:389–430
- Osborn AF, (1948) *In Your creative power: how to use imagination*. New York, C. Scribner's Sons
- Osborn AF, (1974) *L'Imagination constructive: Créativité et brainstorming*. Paris, Dunod
- Ozkaya I, Akin O, (2005) Use of requirement traceability in collaborative design environments. *Codesign* 1(3):155–167
- Scrivener SAR, Clark S, Harris D, Smyth M, et al., (1992) *Designing at a Distance: Experiments in Remote-Synchronous Design*. Annual Conference Gold Coast, Australia
- Shah JJ, Vargas-Hernandez N, Summers JD, Kulkarni S, (2001) Collaborative Sketching (C-Sketch): An Idea Generation Technique for Engineering Design. *Journal of Creative Behavior* 35(3):168–98
- Shneiderman B, (2000) *Creating Creativity: User Interfaces for Supporting Innovation*. *ACM Transactions on Computer Human Interaction* 7:114–138
- Smith SM, Vargas-Hernandez N, Shah JJ, (2003) Metrics for measuring ideation effectiveness. *Design Studies* 24(2) 111–134
- Taggar S, (2002) Individual Creativity and Group Ability to Utilize Individual Creative Resources: A Multilevel Model. *Academy of Management Journal* 45(2):315–330
- Tversky B, (2002) What do Sketches say about Thinking? In: Barbara Tvesky Homepage <http://psychology.stanford.edu/~bt/index.html>
- Van der Lugt R, (2002) Brainsketching and how it differs from brainstorming. *Creativity and Innovation Management* 11(1):43–54
- Van der Lugt R, (2005) How sketching can affect the idea generation process in design group meetings. *Design Studies* 26(2):101–122
- VanGundy AB, (1984) *Managing group creativity: A modular approach to problem solving*. New York: American Management Associations
- Vargas-Hernandez N, Summers JD, Kulkarni S, Shah JJ, (2001) Collaborative Sketching (C-Sketch): An Idea Generation Technique for Engineering Design. *Journal of Creative Behavior* 35:168–198

Creation of New Fashion Illustration Painting Techniques by Use of India-ink Painting Techniques: Research into Line Drawing Techniques of Expression in Fashion Illustrations

Sachiko Nagasawa¹, Shin'ya Nagasawa² and Kazunari Morimoto³

¹ Bunka Women's University, Japan

² Waseda University, Japan

³ Kyoto Institute of Technology, Japan

Abstract. This study aims that painting techniques of India-ink painting is comprehensively incorporated into fashion illustration painting techniques and the results are systematized and considered for reconstruction. The results shows that painting techniques of India-ink painting were based on both Oriental and Japanese artistic traditions. It was then realized that these painting techniques, which offered a great many advantages, were suitable for incorporation into fashion illustration painting techniques.

Keywords: fashion illustration, India-ink painting techniques

1 Preface

We define the term “fashion illustration” as pictures which express fashion. The key point of any fashion illustration is to indicate “lightness or refinement.” Fashion illustration in this paper mainly aims the illustration to be appreciated, therefore the illustrator does not make a clothing, and can confidently deform his illustration.

A great many techniques are used in India-ink painting. Elements such as how the ink is dissolved, the way the brush is used and how water is used bear a direct relationship to expression. In other words, a great many crafts are involved. With this in mind, these crafts will be referred to as “techniques” in this paper, while the term “painting techniques” will be used to refer to the multiple techniques applied in India-ink paintings. These terms will also be used to refer to fashion illustration “techniques” and “painting techniques.”

We believe that there is great potential for the incorporation of India-ink painting techniques into fashion illustration painting techniques. This is because of the omnipresence of the appeal that gives India-ink paintings a feeling of deep spirituality.

Unconventionality is an important element of fashion illustrations. I felt that if this could be combined with a sense of deep spirituality, this would lead to some wonderful developments that go beyond the current scope of fashion illustrations.

To address this issue, this research attempts to create new fashion illustration painting techniques by incorporating and alluding to the entire range of painting techniques of India-ink painting and forming these painting techniques into a systematic approach.

2 Research Methodology

The research methodology is detailed below. Firstly, after a study of the history and appeal of India-ink painting through examination of relevant literature and some actual works, attempts will be made to identify techniques used, and then to create works using the techniques. The next step will be to produce fashion illustrations to effectively verify new painting techniques. The results of the preceding process will be formed into a systematic approach and proposed as a new fashion illustration painting technique.

3 Investigation into and Consideration of India-ink Painting Research Methodology

A study was conducted into the history and painting techniques of India-ink painting through examination of relevant literature and some actual works and this formed the basis for consideration of the essence and expressiveness of India-ink painting. The results of this process are detailed below.

3.1 The History and Appeal of India-ink Painting

India-ink painting is produced by a brush permeated with India ink and represents one of the traditional arts of the Orient. It has its long history over thousand year and established in the 8th century, introduced to Korea and Japan in 13th century. Since its introduction to Japan from China during the Kamakura period, India-ink painting developed into a uniquely Japanese art. Among the artists who created representative Japanese India-ink painting works, we find names such as Sesshu, Sesson, Tohaku Hasegawa, Masanobu Kano and Okyo Maruyama. Fig. 1 shows the “Pine Trees Screen” produced by Tohaku Hasegawa, said to be the greatest India-ink painting of modern times. (Watanabe, 1997)

Some of the points of appeal of India-ink painting are listed below.

- 1) The appeal of the beauty of the gradations from black to white created by India-ink, water and the base material (paper, textiles)
- 2) The appeal of the beauty of blurs produced by water
- 3) The appeal of the directness of expression through the brushwork that facilitates the link between the work and the artist’s state of mind. (Kawano, (ed.), 2002)



Fig. 1. Pine trees screen (16th century, national treasure) by Tohaku Hasegawa

3.2 The Pinpointing the Basic Techniques of India-ink Painting The History and Appeal of India-ink Painting

In the belief that many India-ink painting techniques could be incorporated into fashion illustration painting techniques, books on India-ink painting techniques were examined. The basic techniques thus identified are listed below (Shiozawa, 2010).

(1) Ink adjustment and 3-ink density technique

The 3-ink technique divides inks into three levels; dark, medium and light ink by adjusting the density of the ink using water.

The ink adjustment technique involves adjusting elements such as the amount of ink on the brush, light and shade to match the theme of the painting.

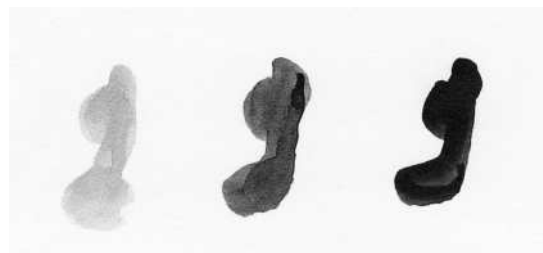

Fig. 2. 3-ink density technique

(2) Line drawing technique (Outline drawing technique, hook bracket technique) and Boneless Method (Single sweep technique)

The line drawing technique (Also referred to as (a) Outline drawing technique and (b) Hook bracket technique) is a painting technique that involves drawing shapes and outlines.

The boneless technique (Also known as the single sweep technique) is a painting technique that involves drawing shapes on the surface. The single stroke technique is unique technique used in Japanese paintings developed from the boneless technique imported from China by incorporating improvements added by Okyo Maruyama (1733 – 95).

The 3-ink technique divides inks into three levels; dark, medium and light ink by adjusting the density of the ink using water (Saito, 2001).

(3) Upright Brush and Angled Brush

Upright brush refers to a brush technique that involves constantly moving the brush tip through the center of the line to be drawn.

Angled brush refers to a brush movement technique that involves moving the brush tip through one side of the line to be drawn.



Fig. 3. Upright brush



Fig. 4. Angled brush

(4) Wet Brush and Dry Friction Brush

Wet brush refers to a technique that involves soaking the brush in a generous quantity of ink.

Dry friction brush refers to a technique that involves soaking the brush in a generous quantity of ink.



Fig. 5. Wet brush



Fig. 6. Dry friction brush

(5) Split Brush and Twisted Brush

Split brush refers to a technique that involves using the fingers to split the brush tip to splay the hairs.

Twisted brush refers to a technique that involves painting by twisting the brush tip on the paper.



Fig. 7. Split brush



Fig. 8. Twisted brush

(6) Normal Brush and Reverse Brush

Normal brush refers to a technique that involves tilting the axis of the brush in the direction of brush movement when painting. Reverse brush is a technique that involves tilting the brush axis in the opposite direction to the brush movement when painting.

(7) Streaking

Streaking refers to a technique that involves painting making use of the lines that appears in the boundaries of the first and second brush strokes.

(8) Blurring

Blurring refers to a technique that involves adding ink or water to parts that have been painted before they dry.



Fig. 9. Line painting



Fig. 10. Bleeding

3.3 Consideration of the Essence and Expressiveness of India-ink Painting

The essence and expressiveness of India-ink painting were considered through a study of history and painting techniques.

The essence of India-ink painting is the manifestation of spirituality. Spirituality is condensed in the painter and manifests itself through the tip of the brush to be transferred to its locus.

Expression has at its center abstractness. Western watercolor and India-ink painting share these painting techniques to a certain degree. However, a look at western watercolor works reveals an emphasis in the past on realism, or in other words, techniques such as

shading and perspective, leaving one with the unavoidable vague feeling of a form of expression rooted in the culture at the time when expressive techniques that produced works that could be mistaken for photographs were established. Compared with such works, looking at India-ink paintings produced in Japan and other countries, one is left with the vague impression that less emphasis is placed on crafts that pursue realism and that such works are rooted in a culture that focuses rather on abstractness. The same can be said of the works of the Maruyama School, where the emphasis is on portrayal. In other words, one is given an unequivocal sense of differences in cultural frameworks rather than matters relating to craft.

However, new expressions are developing across cultures according to today's globalization. For example, some of the Western works illustrate "nil" of India-ink painting rather than no painting.

4 Application to Fashion Illustration Painting Techniques

Many of the essence, expressiveness and basic techniques identified in Chapter 3 can be incorporated into fashion illustrations.

Among fashion illustrations of the past, one occasionally finds works that incorporate India-ink painting techniques. Representative example can be found in the works of Gruau, where "line drawing technique" is employed, the works of Mats, where the "boneless technique" is used and the works of Antonio Lopez, where "angled brush" is used, the works of Isao Yajima, where one can see application of the "blurring" and "angled brush" techniques. All of these pieces are not only wonderful works of art, but represent the heritage of the human race. However, this is not to say that all artists generally incorporate painting techniques of India-ink painting. Even the various techniques and painting techniques employed are not alluded to. Moreover, there are a great many existing books on fashion illustrations that include descriptions of line drawings and coloring by brush. That being said, almost all such descriptions are based on the perspective of painting techniques found in western watercolors such as the light and shade technique. There are still no fashion illustration painting techniques or books on the subject that demonstrate a comprehensively systematic approach rather than a partial approach to India-ink painting from the perspective of the India-ink paintings of countries such as Japan.

With this in mind, the following is a description of an attempt to reconstruct fashion illustration painting

techniques employing painting techniques of India-ink painting.

4.1 The Essence and Expressiveness of India-ink Paintings

In the reconstruction of fashion illustration painting techniques employing painting techniques of India-ink painting, I believed that it was preferable to use the essence and expressiveness of India-ink paintings considered in the foregoing chapter unchanged.

Therefore, the basic principle was to unflinchingly incorporate the spirituality and abstractness of India-ink painting. It should be noted that diverse applications should be developed after mastering the basics.

The following section talks about concrete painting techniques used on the reconstruction of fashion illustrations employing painting techniques of India-ink painting.

4.2 Expression of Shapes

(1) Line Drawing Technique

In the world of fashion illustrations, the expression of shapes by line drawing is a basic principle. Fashion illustration line drawing can be reconstructed using the “line drawing technique” from India-ink painting techniques.

Before using the brush for the line drawing technique, “India-ink adjustment” should be carried using ink water and the brush. Since watercolor utensils are generally used for fashion illustrations rather than India ink, it may be inappropriate to use the term “India ink” in this respect, but the term “India-ink adjustment” will nevertheless be retained throughout this paper.

Line drawing techniques are classified into the following two types.

1) Playful string drawing: Balanced thin lines are called “playful string lines.” Playful string drawing refers to both line drawings composed of playful string lines and to the drawing technique employed

2) Proportional drawing: Lines with variation are referred to as “proportional lines.” Proportional drawing refers both to works composed of proportional lines and to the drawing technique employed.

Both of the above are usually soft line drawing expressions produced using a brush. More stringent expression can be produced by emphasizing variation.

(2) Boneless Technique

Silhouettes represent an important element of expression in fashion illustrations. Silhouette expressions can be reconstructed using the “boneless

technique” from India-ink painting. Additionally, the boneless technique is one of the basics of watercolor techniques.

In the world of fashion illustrations, the expression of shapes by line drawing is a basic principle. Fashion illustration line drawing can be reconstructed using the “line drawing technique” from India-ink painting techniques.

4.3 Coloring Techniques

This section deals with watercolor techniques in fashion illustrations using watercolor paints.

(1) 3-ink Technique

The 3-ink technique from India-ink painting (Dark, medium and light) can be applied directly in the reconstruction of fashion illustration techniques to the process of adjusting the density of watercolor paints for coloring during dissolution.

(2) Ink Adjustment Technique

Like the line drawing technique, the ink-adjustment technique from India-ink painting can be used unchanged in the process of permeating the brush with paint.

(3) Basic Brush Movements

Brush movements (brush handling) from India-ink painting can be used directly in the reconstruction of fashion illustration techniques. Basic brush movement classifications are listed below.

A. Two classifications of brush tip usage

a) Upright brush: Applied to all undercoatings, all finishes and some boneless techniques.

b) Angled brush: Applied, for example, to cube (tube) expressions and light and shade emphasis expressions (e.g. leather, satin and organdy).

B. Two classifications depending on ink to brush proportions

a) Wet brush: Applied to all undercoatings and all thin cloth base materials. See Fig. 9 of examples created.

b) Dry brush: Applied to thick cloth base materials (e.g. wool) and abridged expressions.

C. Two classifications depending on the direction of brush movement

a) Normal brush: Applied to all undercoatings and all finishes.

b) Reverse brush: Applied to expressions on special materials with 3-dimensionality.

Line drawing comprises a combination of brush movement A, B and C.

(4) Brush Movement Applications

Representative brush movement applications used in the reconstruction of fashion illustration techniques using India-ink painting techniques are listed below.

a) Split brush: Applied to materials with pile (e.g. fur).

b) Twisted brush: Applied to expression of materials

with specific expression on the surface (e.g. fancy tweed).

c) Streaking: Applied to expression on special stacked materials.

(5) Blurring (i.e. Use of Water)

The Japanese term for India-ink painting incorporates the character for water and the use of water together with the use of the brush is the key to expressiveness. The technique of “blurring” used in the reconstruction of fashion illustration painting techniques plays an important role in the expression of elements of the human body such as skin and hair, the overall expression of the feeling of the base material and, additionally, the expression of the view of the world of the work over the entire surface.

5 Samples of Trial Creation of Fashion Illustrations

Trial works were produced using the painting techniques described in Chapter 4 to check validity of the techniques in question. The results are described below.

5.1 Line Drawing Expressiveness

A line drawing of a person was produced. See Fig. 11(a) of the examples created by using playful string drawing and Fig. 11(b) by using proportional drawing.

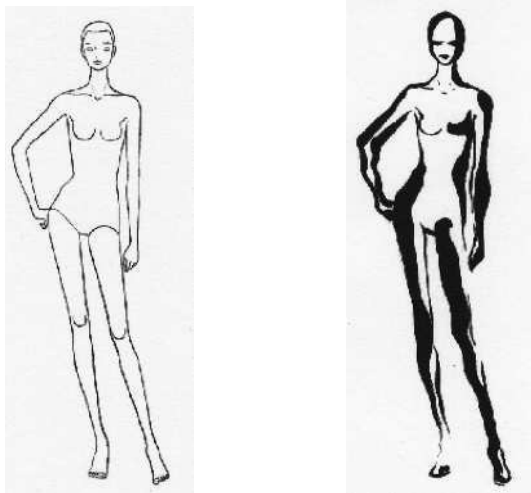

(a) Playful string drawing (b) Proportional drawing
Fig. 11. Examples of a line drawing of a person

The human forms used in fashion illustrations referred to in examples of works created in this paper were set as follows (Yajima, 2002; Nagasawa, 2002):

a) Human forms with a head-to-body proportion of 8 were used.

b) The light source was set at an upwardly inclined 45 degree angle.

c) Poses comprised poses with the focus on one leg and variations of the same.

d) The angle was set to 45 degrees to the front, left and right.

In the world of fashion illustrations, the expression of shapes by line drawing is a basic principle. Fashion illustration line drawing can be reconstructed using the “line drawing technique” from India-ink painting techniques.

5.2 Boneless Expression

A boneless expression was produced. See Fig. 12(a) of the examples created by using dark ink and Fig. 12(b) by using dark, medium and light ink adjusting the density of the ink using water.

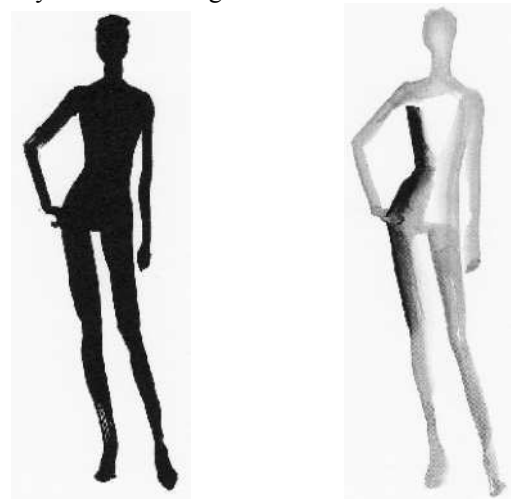

(a) Dark ink (b) Dark, medium and light ink
Fig. 12. Examples of a boneless expression

5.3 Upright Brush Expression

An upright brush expression was produced. See Fig. 13 of the examples created by using upright brush expression.

5.4 Angled Brush Expression

An angled brush expression was produced. See Fig. 14 of the examples created by using angled brush expression.

5.5 Wet Brush Expression

A wet brush expression was produced. See Fig. 15 of the examples created by using wet brush expression.



Fig. 13. Example of upright brush expression (left)
Fig. 14. Example of angled brush expression (center)
Fig. 15. Example of wet brush expression (right)

5.6 Dry Friction Brush, Nomal brush, Reverse Brush Expression

A dry friction brush, nomal brush, and, reverse brush expression were produced. See Fig. 16 of the example created by mixing dry friction brush, nomal brush, and, reverse brush expressions in the background.



Fig. 16. Example of mixing brush expressions.

5.7 Summary of validity of examples created

Some of the points of validity of examples created are listed below.

1) It was discovered that the “ink adjustment,” “angled brush” and “blurring” techniques made it possible to produce smooth hand-painted gradations. Moreover, these techniques were valid for expressions with a bias toward abstractness free from realistic light and shade techniques. It was verified that these painting techniques were valid for hand-painted expressions of the delicate sensitivities of the 2010’s.

2) It was learned that application of a condensed, powerful energy is important to support rough sketches using techniques such as “upright brush” and “dry friction brush” techniques and to express the delicate sensitivities of the 2010’s.

6 Comprehensive Fashion Illustration Expressions by Hand-painting

Comprehensive fashion illustrations wherein the artist expresses his/her world view using painting techniques of India-ink painting are shown in Fig. 17 and Fig.18.

Fig. 17 was produced using the “line drawing” and “blurring” techniques. Fig. 18 was produced on black leather coloring using the “angled brush” and “blurring” techniques free of light and shade technique. Shade technique was used for coloring of elements such as the figure’s skin.



Fig. 17. Comprehensive fashion illustration (1) (left)
Fig. 18. Comprehensive fashion illustration (2) (right)

7 Development using CG

Fig. 19 shows an example of a work created using CG for development of painting techniques of India-ink painting.



Fig. 19. Work expressed by CG after developing painting techniques of India-ink painting

The main points of the creative process are listed below.

1) Rough sketch (Pencil and paper)

A rough sketch of the fashion illustration was drawn using a pencil.

2) CG processing: photoshop

A line drawing was produced by CG.

3) Coloring: photoshop/gradation tools

CG gradation tools were used for coloring.

The main points of expression are set out below.

1) A line drawing was produced by CG (photoshop). This is a work reconstructed using the “line drawing/playful string drawing” techniques from India-ink painting.

2) CG (photoshop) gradation tools were used for coloring. This is a work that was reconstructed using “ink adjustment” and the “3-ink technique” from India-ink painting techniques.

3) CG (photoshop) gradation tools were used for coloring free of real light and shade technique. This is a work that was reconstructed using the India-ink painting techniques “angled brush,” “wet brush” and “normal brush” for the human form and the apparel and, mainly, “blurring” for the background.

The above process verified that reconstruction using painting techniques of India-ink painting is also valid for CG.

8 Observations and Summary

The following observations relate to the incorporation of painting techniques of India-ink painting into fashion illustration painting techniques.

1) These techniques made it possible to produce graceful, light and fresh fashion illustrations when using hand-painted watercolors.

2) These techniques make it possible to create soft, rich fashion illustrations when using CG.

3) Once one has grown used to coloring techniques involving pouring watercolors paints, for example, coloring can be completed in a relatively short period of time.

4) Works thus produced have the potential to produce chance effects through the interweave of watercolor paints, water and base materials.

5) Stylish warm gradations can be produced by hand painting.

6) Even greater expansion of expressiveness is possible through the creation of works and processing using CG.

7) This approach presents possibilities for direct linkage of the physical reactions of the painter with representative expressions.

Research revealed the following three main points from the results of reconstruction of fashion illustration painting techniques through the incorporation of painting techniques of India-ink painting.

(1) Essence: “Balance between abstractness and realism/Semi-embodiment/Liberal encryption”

The balance between abstractness and realism is important. Because fashion illustrations represent a type of public art, overemphasis of abstractness renders works too difficult to understand and the resulting lack of acceptance by the public could be thought of as “putting the cart before the horse.” It is important to maintain an appropriate balance with realism to retain ease of understanding.

This concept can also be expressed by the terms “semi-embodiment” or “liberal encryption.” The expressionism of India-ink paintings produced by drawing the subject on white paper with black ink without light and shade involves omitting many of the elements of the subject itself and encrypting the essence thus extracted. To express the shape, feeling and color of the motif requires the addition of gradations produced by ink and water and various touches, with the result that many India-ink paintings are expressions that incorporate realism. However, essence can be thought of as having a bias toward the abstractness. Therefore, it seems natural that fashion illustrations that incorporate painting techniques of India-ink painting be ranked in the category of works with a balance between the abstractness and realism featuring semi-embodiment or liberal encryption while retaining a degree of ease of understanding.

(2) The Essence of Expression: “Gradation”

The people (in developed countries) of the 2010’s are accustomed to high-vision and CG images as well as other high-tech images and have therefore developed a visual sensitivity that has never before been so sharp and discerning.

This main point of techniques that express this sensitivity is “gradation.” The use of painting techniques of India-ink painting is an effective means of expressing this through the sensitive-touch of the artist. Moreover, nowadays, the sensitive touch of the artist facilitates imbue his/her works with his own spirituality. In other words, the artist possesses a wide latent range. In addition, the creation of smooth gradations made possible by the application of painting techniques of India-ink painting can be further developed by transfer to high-tech applications, in other words, 2DCG.

(3) This research has shown that all painting techniques of India-ink painting can be incorporated into fashion illustration.

It has been verified that techniques such as “blurring,” “Angled brush” and the “boneless technique (with

light and shade)" can be applied to the creation of "gradation," the main point of India-ink painting expression. Application of these techniques to gradations in fashion illustration is wide ranging and still holds great hidden potential for further use.

Furthermore, close examination of India-ink paintings that at a glance seem to lack light and shade will reveal the presence of light and shade, in other words gradations, as long as such works have been hand painted. Works or parts of works encountered that have absolutely no light and shade can be thought of as having zero-gradation. India-ink paintings are not painted from the start with the aim of producing a uniform, flat surface. India-ink paintings are painted using ink, water and brushes. Therefore, it was realized that India-ink painting expression can be seen as an aggregation of gradations.

With this in mind, the new painting techniques developed through systematic reconstruction and incorporated of painting techniques of India-ink painting into fashion illustrations have been named "Super Gradations."

The people (in developed countries) of the 2010's are accustomed to high-vision and CG images as well as other high-tech images and have therefore developed a visual sensitivity that has never before been so sharp and discerning.

(4) New fashion illustration painting techniques contribute to the design creativity

Since fashion illustration exaggerates the atmosphere of the age, the advantages of fashion illustration, especially by use of India-Ink painting, are as follows: (1) Spiritualism, (2) Contemporaneity, (3) Preoccupation of future, (4) Recollections of past, (5) Different dimension or different space.

Through the expansion of expression by use of India-ink painting involving the above features illustrator can expand the width of presentation and exaggerate. Those who appreciate the illustration are to be inspired and will design cloths with inspired creativity.

9 Conclusion

During the current research, painting techniques of India-ink painting were comprehensively incorporated into fashion illustration painting techniques and the results were systematized and considered for reconstruction.

The results showed firstly that painting techniques of India-ink painting were based on both Oriental and Japanese artistic traditions. It was then realized that these painting techniques, which offered a great many advantages, were suitable for incorporation into

fashion illustration painting techniques. Next, in order to realize further application of these painting techniques to fashion illustrations, painting techniques of India-ink painting were studied, existing fashion illustration painting techniques were reconstructed and new painting techniques were created. These new painting techniques were named "Super Gradations for fashion illustrations." Finally, the author has produced works using these painting techniques in pursuit of expression that have been presented to society in an effort to spread the new painting techniques.

Acknowledgements

It should be noted that this research was subsidized by Grant-in-Aid for Scientific Research (C) No. 20520136.

References

- Blackman C, (2007) 100 Years of Fashion Illustration. Laurence King Publishing
- Drake N, (1987) Fashion Illustration Today. Thames and Hudson Ltd., London
- Furuta S, Yamana N, Kijima F, (eds.), (2003) Chinese Art. Shouwadou
- Kawano M, (ed.), (2002) Japanese Art and India-ink Painting. Bijutsu-nenkan-sha
- Maeda K, (ed.), (2000) History of Oriental art. Bijyutu Shuppansha
- Morimoto M, (2010) How to Paint Fashion Illustration. Seibundo Shinkosha Publishing
- Nagasawa S, (2002) Fashion Design Paintings and How to Paint Them. Special issue of Japanese Society for Science of Design "For Fashion Design Education," 9(4):63-67
- Packer W, (1983) Fashion Drawing in Vogue. The Conde Nast Publications Ltd.: London
- Saito N, (2001) All about the Single sweep technique. Kanariya
- Shiozawa G, (2010) India-ink Painting from First Steps. Japan Publications, Inc.
- Takashina S, (ed.), (2002) History of Western Art. Bijyutu Shuppansha
- Tuji K, (ed.), (2003) History of Japanese Art. Bijyutu Shuppansha
- Watanabe A, (1997) Basic knowledge of appreciation in India-ink Painting. Sibundo
- Yajima I, (1990) Figure Drawing For Fashion 1 & 2. Graphicsha
- Yajima I, (2002) Mode Drawing. Female Nude Revision, Atelier KO
- Yamada G, (1989) Introduction to the Basics of Refurbished Edition of India-ink Painting. Shusakusha Shuppan
- Yamashita Y, (ed.), (2003) Discovering India-ink Painting. Bessatsu Taiyou, No. 124, Heibonsha
- Quoted Illustrations:** Figs. 16-19) Sachiko Nagasawa (2007) Fashion Illustration Collection "Flowers." ARTBOX International Inc., p.40, p.19, p.21, p.3

How Uncertainty Helps Sketch Interpretation in a Design Task

Winger S.W. Tseng¹ and Linden J. Ball²

¹ National Yunlin University of Science and Technology, Taiwan

² Lancaster University, UK

Abstract. We examined the hypothesis that the ambiguity inherent within concept sketches can assist reasoning between different modes of representation, and engage translation from descriptions to depictions. Results showed that different levels of ambiguity within the cues significantly influenced the quantity of idea development of expert designers, but not novice designers, whose idea generation remained relatively low across all levels of ambiguity. For experts, as the level of ambiguity in the cue increased so did the number of design ideas that were generated. Most design interpretations created by both experts and novices were affected by geometric contours within the figures. In addition, when viewing cues of high ambiguity, experts produced more interpretative transformations than when viewing cues of moderate or low ambiguity. We claim that increased ambiguity within presented visual cues engenders uncertainty in designers that facilitates flexible transformations and interpretations that prevent premature commitment to uncreative solutions.

Keywords: uncertainty, interpretation, ambiguous figures, design ideation, expert versus novice differences, interpretation, idea sketching

1 Introduction

Freehand sketching is widely utilized by designers, not merely for presenting their ideas to others, but also as an external reference system, allowing them to make associations between functional and structural concepts (Suwa and Tversky, 1997). In other words, the visual cues appearing within sketches seem to inspire designers to search for associated knowledge within their memories, and may then interact with such knowledge to produce novel concepts until a final, satisfactory design solution has been produced (Fish and Scrivener, 1990; Fish, 1996). Thus, sketching offers a unique space where depictive and descriptive data can interact in order to facilitate the creation of unexpected objects and inventions. In this way the geometric appearance of the depicted object together with underlying concept knowledge can reflect and influence drawing production and behavior (Scrivener, Tseng and Ball, 2000). We contend that the structure

of sketching behavior may also be influenced by *cognitive uncertainty*, a psychological state that is associated with insufficient internal and external information (Kavakli, Scrivener and Ball, 1998).

In summary, our reported experimental research aims to examine the role of ambiguity within sketches as a driver for creative design ideation. Our central hypothesis is that the presence of increased levels of ambiguity in visual images presented to designers as concept sketches will trigger the enhanced production of creative ideas. We further investigate whether the relationship between visual ambiguity and reasoning processes during idea sketching is mediated by cognitive uncertainty, and whether such uncertainty differentially affects sketch interpretations made by expert versus novice designers.

2 The Uncertain Information Process

Before discussing the potential links between sketching and uncertainty, the concept of “uncertainty” itself needs to be examined. This concept captures the idea that the essence, state or importance of a thing, incident, phenomenon or result is undecided or cannot be determined. According to Mishel (1981), a state of uncertainty is triggered by the following properties:

1. Vagueness
2. Lack of clarity
3. Ambiguity
4. Unpredictability
5. Inconsistency
6. Probability
7. Multiple meaning
8. Lack of information

There typically appear to be two main consequences of uncertainty for human reasoners: (1) the inability to make a decision; and (2) the need to reappraise or modify the situation in order to progress beyond the uncertainty. In other words, when confronting uncertainty an internal conflict will be evoked, which

will tend to motivate the individual to obtain information that can lead to a resolution of that conflict (Berlyne, 1966; Berlyne, 1970). The sought-after information that can resolve the conflict is referred to as “collative information” by Attneave (1970), and functions to enable people to produce an appropriate response. Attneave further suggests an obvious demarcation between uncertainty and collative information; uncertainty implies an expectation to the unknown incident, but collative information implies the known incident and past experience.

Drawing together these ideas, it seems likely that uncertainty will arise in creative design situations as a result of two main factors: (1) when the designer lacks the relevant prior experience or knowledge to deal directly with the design task, and (2) when the presented stimulus or design cues are fuzzy, lacking in clarity, equivocal, or possessing multiple meanings. In both cases a demand will be created for new information to enable the designer either to build a novel mental model with that information that can reduce their uncertainty, or to utilize their uncertainty to ensure that all possible interpretations are considered. Thus the fascination for design theorists attempting to understand cognitive uncertainty lies in explicating the processes which alter an unknown event into a known event, thereby utilizing uncertainty and generating a reward for the designer in the form of a new invention or progress toward a final problem solution (cf. Ball and Christensen, 2009).

3 The Uncertain Properties of Sketches

Why should design researchers be so interested in the nature of sketches and sketching? Indeed, one might question whether this kind of image-making is an outmoded activity anyway, soon to be surpassed by computer-based imaging technology? Suwa (1998), however, suggests that sketches serve not only as an external memory repository in which to place ideas for later inspection, but also function to provide visual cues for associating functional issues. Sketches, most importantly, serve as a physical setting in which functional thoughts are constructed on paper in a situated way. The particular visual characteristics of external symbols within sketches are ones that support and facilitate the kind of visual reasoning engaged in the early stages of design, as does the actual activity of sketching itself (Goel 1994).

Goel (1994) argues that the properties of density and ambiguity within sketches are particularly important for enabling imaginative transformations during the preliminary phase of design problem solving. On the other hand, sketches that possess

unambiguous, tidy and determinate symbols have been shown to hamper severely designers’ creative thought processes. Additionally, Fish and Scrivener (1990) have identified three primary attributes of sketches of value for creative reasoning. First, they are composed of abbreviated two-dimensional sign systems used to represent three-dimensional visual experience. Second, they contain selective and fragmentary information. Third, they contain deliberate or accidental indeterminacies. Among the indeterminacies commonly found in sketches are incomplete contours, wobbly lines, accidental smudges, energetic cross-hatchings, blots and scratch marks.

Fish and Scrivener (1990) further argue that “...deliberate or accidental indeterminacies may trigger innate recognition search mechanisms that generate a stream of imagery useful to invention” by means of three mechanisms. First, the sketch provides a structure to aid and refresh spatially superimposed mental images, in a “percept-image hybrid”. Faint or indistinguishable marks may integrate into the mental image, and the image may modify the percept arising from the sketch. Second, the ambiguous and indeterminate symbols of the sketch rouse innate, unconscious recognition mechanisms to generate a stream of mental imagery. Biederman’s (1987) theory of “recognition-by-components” supports this hypothesis, and evidence suggests that fresh or problematic stimuli extract the most vivid imagery (Biederman 1987). Finally, sketches facilitate translation between different modes of visual representation. Sketches engage translation from categorical description (in memory) to one of many possible spatial depictions. Furthermore, sketches use sign systems and often written notes that access long-term memory and stimulate this mental translation of descriptive information to spatially depictive imagery.

The symbol systems of sketches are both descriptive and depictive in nature, abbreviated and incomplete, ambiguous and indeterminate, and only those sketches with these features can support and stimulate processes for the mental construction and manipulation of visual images. Scrivener and Clark (1993) argue that there is “...an intimate and fragile connection between the sketch and mental processes it supports...Intimate, because without the sketch, mental constructs would be more difficult to construct, manipulate and alter. They would be less vivid, less coherent and less memorable. Fragile, because too much completeness and realism of representation in the sketch may overpower these imagined mental structures”.

4 Sketch Interpretation and Uncertainty

We discussed above how the properties of deliberate or accidental indeterminate symbols within sketches can fuel creative imaginings. This process, aroused by faint or vague marks, involves translation from categorical descriptions in memory to one of many potential depictions, and is identified by Goldschmidt (1991) as a special kind of dialectic in design reasoning. Sketch interpretation is supported by this dialectic between depictive and descriptive data, associating interactive mental imagery and sketches, producing a series of visualizations with clues for the purpose of reasoning associated with something to be invented. Goldschmidt (1992) observes that visual reasoning often appears in a series of sketches produced within a very short time. She argues that excellent ideas never arise all at once; rather they are structured gradually, using each phase in their development as a source of feedback to inform the generation of subsequent phases. To investigate serial sketching Goldschmidt conducted four design case studies with experienced architects, and concluded that visual thinking is symbolized through systematic, serial sketching that transforms images of the designed entity. Each sketch offers feedback to inform the generation of subsequent representations of the pictorial properties of the concept. Scrivener and Clark (1993) conclude that this visual reasoning within sketches is a “conversation with the self”.

From the literature on sketching presented above it seems likely that designers will have a sense of uncertainty when viewing ambiguous symbols in sketches (Mackay, 1957; Wu, 1997). This uncertainty would arise from the designer trying to understand how to alter the unknown event into a known event, thereby generating the reward of a new invention or a final solution to a problem. It is also possible that uncertainty might stimulate an innate recognition-based search mechanism that generates a stream of imagery that is useful to invention (cf. Berlyne, 1970).

In summary, reasoning processes may be initiated by visually ambiguous stimuli that then modify these ambiguous stimuli until they become unambiguous, tidy yet innovative figures. In this way creative thought depends upon interpretative transformations between visual stimuli and descriptive information. Suwa and Tversky (1997) argued that designers see new relations and features that suggest ways to refine and revise their ideas. They claimed that seeing and reinterpreting different types of information in sketches is the driving force in revising design ideas. From this point of view, ambiguous visual stimuli within sketches may facilitate the mental translation

between descriptive and depictive modes of representation in visual thought (Fish, 1996).

As noted earlier, our research also aimed to examine the relationship between visual ambiguity, uncertainty and sketching expertise, focusing on whether ambiguity differentially affects sketch interpretations made by experts versus novices. Unlike novice sketchers, experts should be more able to capitalize on the creative affordances arising from visual ambiguity because of their greater experience at handling such ambiguity. In addition, we contend that experts may well have developed ways to preserve visual ambiguity for a period of time precisely so that they can think of the visual representation in alternative ways. Thus expert sketchers may be willing to tolerate a degree of uncertainty in a strategic manner while they harness visual ambiguity to explore alternative design ideas. Presumably, though, the requirement to produce a final design concept will necessitate the eventual resolution of uncertainty and a move away from ambiguity toward greater precision.

5 Methods

5.1 Participants

Three participants took part in a pre-experiment session and were graduate students with one year of professional design experience in the industrial design department at the college of design, National Yunling University of Science and Technology (NYUST). The remaining participants who took part in the main experiment were 21 undergraduate students, recruited from non-design departments at NYUST, who were considered to be novice sketchers, and 21 designers, with 3 years of professional design experience, who were regarded as trained sketchers and designers.

5.2 Pre-Experiment Session

For the purpose of investigating how ambiguous figures affect designers' interpretation during conceptual development we first needed to produce a set of ambiguous figures that could be used as visual cues in the main experiment. The ambiguous figures were derived from the pre-experiment session, which instructed three participants to perform a design combination task. Three paper cards, labelled “a coffee cup and a hair dryer”, “a telephone and a coat-hanger”, and “a light-bulb and pair of scissors”, were presented to the participants. They were required to draw at least one concept (Fig. 1) for each paper card presented to

them, and all of their drawing activities were recorded throughout their sketching process.



Fig. 1. Participant 2’s concepts created in the pre-sketching session

During the subsequent drawing analysis that focused on extracting ambiguous figures, the drawing process for each object combination was segmented at points when the participant had a long pause (lasting at least 5 seconds) that also entailed meaningful cognitive actions (e.g., thinking, looking or searching for something), with such actions being discernible in participants’ think-aloud protocols. Three different levels of ambiguous figures were extracted from these analyses for use in the table design task that formed the main experiment. These three levels of ambiguous figures reflected the “completeness” of the sketched object combinations that had been produced at various steps during the pre-sketching session (see Fig. 2). These three levels of ambiguous figures were classified as “high ambiguity” (Fig. 2, Step 1), “medium ambiguity” (Fig. 2, Step 4), and “low ambiguity” (Fig. 2, Step 9).

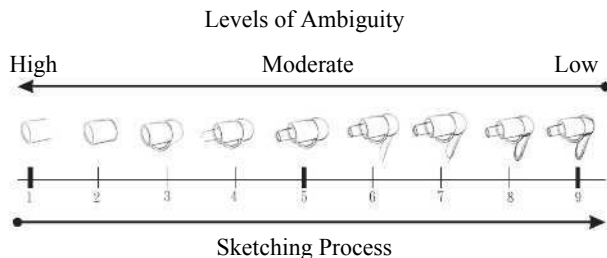

Fig. 2. Participant 1’s concepts drawn from a telephone and a hanger combination task in the pre-sketching session

5.3 Main Experiment

In the table design task, the participants (21 experts and 21 novices) were presented with three different levels of ambiguous figures selected from the pre-sketching session (Fig. 3). They were then required to produce at least one design concept per visual cue presented, and were subsequently required to report on their drawing actions and sketches while watching the video recording of these activities. The resulting retrospective protocols (Ericsson and Simon, 1993) were recorded for subsequent analyses that aimed to examine the nature of reasoning processes during

conceptual design development. Such sketch-based reasoning arose while participants inspected the visual cue and interacted with its underlying meaning, and was coded when participants discovered and interpreted a new meaning or function, or when they generated a new form from the presented pictures.

5.4 Procedure

The table design task required participants to view three different levels of ill-structured visual cue, based on the conceptual sketches produced in the pre-experiment task. The orders in which the ambiguous visual cues were presented to participants were systematically varied such that equal numbers of participants received one of the following sequences: A-1 B-2 C-3; A-2 B-3 C-1; and A-3 B-1 C-2 (see Fig. 3). In the review session that followed all sketching tasks, the participants were asked to watch the video recording of their sketching activities and to describe their drawing actions and sketches.

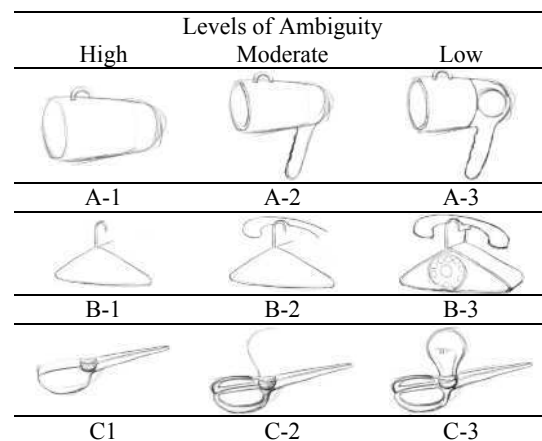

Fig. 3. Three different levels of ambiguous figures used in the table design task

Participants in the table design task needed to undertake three designs, one for each of the ill-structured visual cue that had been presented as a design prompt. Participants were required to produce at least one perspective view of the table design in each design task to represent their final concept. Nevertheless, they could produce as many sketches as necessary to assist them in finalizing the drawing. They were instructed to desist from reproducing shadowing or patterning or from using any colour effects in their sketches.

In the review session participants were requested to review their sketching behaviour and their drawings by watching the video recordings for all design tasks. While watching the video they were asked to explain their drawing acts and the nature of their sketches.

V → S: Participant C transformed the presented cup shape into the form of table legs.	
V → F: Novice A used the curve of the transmitter to develop the curve of the table bottom so that the table functioned like a tumbler.	
F → S: Expert D made the form of a table using the idea of a bent coat-hanger.	
F → F: Novice B used the scissors' opening and closing function to make the table top such that it could be opened and closed.	

Fig. 4. Four categories of sketching behaviour: row 1 shows a visual feature associating to a newly created shape concept ($V \rightarrow S$); row 2 shows a visual feature associating to a newly created functional concept ($V \rightarrow F$); row 3 shows a function or semantic feature associating to a newly created shape concept ($F \rightarrow S$); and row 4 shows a function or semantic feature associating to a newly created functional concept ($F \rightarrow F$).

Participants were instructed that the time available for each design task was 15 mins, with 10 mins extra for the review session. However, participants were not requested to stop and were allowed to complete drawing to their satisfaction. There was a 3 min interval between design tasks. The experiment lasted 90 min on average.

5.5 Measurement

The content of participants' sketches and their interpretative reasoning activities were coded using a scheme that embodied four distinct categories of behaviour. When participants created a new form that related to a visual feature within the presented stimulus, this was coded either as "a *visual* feature associating to a newly created *shape* concept" ($V \rightarrow S$), or "a *visual* feature associating to a newly created *functional* concept" ($V \rightarrow F$). When participants created a new form that related to a function or semantic feature within the presented stimulus, this was coded either as "a *function* or semantic feature associating to a newly created *shape* concept" ($F \rightarrow S$), or "a *function* or semantic feature associating to a newly created *functional* concept" ($F \rightarrow F$). Fig. 4 shows examples of all four categories of behaviour.

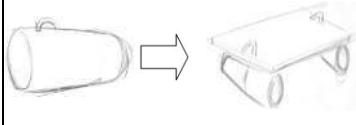
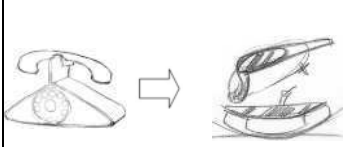
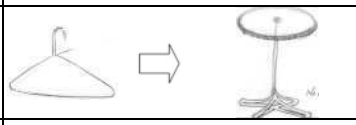
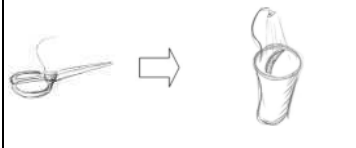
6 Results

From Table 1 it is evident that the experts demonstrated an increasing quantity of design ideas and interpretations across increasing levels of ambiguity. In contrast, the novices showed the opposite trend, with fewer design ideas and interpretations across increasing levels of ambiguity. In general, too, it is evident that $V \rightarrow S$ and $V \rightarrow F$ interpretations are far more prevalent than $F \rightarrow S$ and $F \rightarrow F$ interpretations across both experts and novices. Indeed, $F \rightarrow S$ interpretations are produced by experts on only 5% of occasions and by novices on 4% of occasions, while $F \rightarrow F$ interpretations are produced by experts on 11% of occasions and by novices on 7% of occasions. Because of the low levels of interpretation involving functional aspects of the original stimuli it was decided that subsequent statistical analyses should focus solely on idea production and on the quantitative aspects of $V \rightarrow S$ and $V \rightarrow F$ interpretations.

Table 2 shows the mean number of design ideas produced by novices and experts across levels of visual ambiguity, along with their total interpretations (which were not subsequently analyzed), and their $V \rightarrow F$ and $V \rightarrow S$ interpretations. A series of 2 x 3 mixed between-within participants ANOVAs were adopted in order to examine these dependent measures, where the between-participants factor was expertise (expert vs. novice) and the within-participants factor was visual ambiguity, with three levels (high, moderate and low). We report the results of these ANOVAs in the sub-sections below.

6.1 Total Number of Design Ideas Produced

The ANOVA that was conducted on the total number of design ideas produced revealed a significant main effect of expertise, $F(1, 40) = 16.48$, $MSE = 9.31$, $p < .001$, partial $\eta^2 = 0.29$, with experts generating more total design ideas than novices. The main effect of visual ambiguity was not significant, $F < 1$. However, the interaction between expertise and visual ambiguity was reliable, $F(2, 80) = 8.20$, $p = .001$, partial $\eta^2 = 0.17$, which indicates that the effect of visual ambiguity differs dependent on whether experts or novices are engaging in the design activity. The data in Table 2 suggest that the number of design ideas generated by novices decreases in a modest linear trajectory from low to high levels of visual ambiguity. The pattern is very different, however, for the experts, whose idea generation increases (rather than decreases) from low to high visual ambiguity, and does so in a fairly robust manner.

Table 1. The production of ideas and sketch-based reasoning by experts and novices at three levels of ambiguity

	High Ambiguity						Moderate Ambiguity						Low Ambiguity					
	Ideas	Sketching reasoning					Ideas	Sketching reasoning					Ideas	Sketching reasoning				
		V→S	V→F	F→S	F→F	Total		V→S	V→F	F→S	F→F	Total		V→S	V→F	F→S	F→F	Total
Expert	123	102	42	3	15	170	104	80	27	12	14	133	93	67	21	9	18	115
Novice	53	53	11	3	4	71	59	54	10	4	7	75	69	65	9	4	6	84

Table 2. Mean number of design ideas, interpretations, and V → F and V → S interpretations produced by novices and experts across levels of ambiguity in experiment 1 (standard deviations in parenthesis)

	N	Ideas		Interpretations		V → S		V → F		
		M	SD	M	SD	M	SD	M	SD	
High Ambiguity	Expert	21	5.9	0.8	8.1	2.2	4.9	1.7	2.0	1.3
	Novice	21	2.5	2.0	3.4	2.9	2.5	2.4	0.5	0.6
	Total	42	4.2	2.3	5.7	3.5	3.7	2.4	1.3	1.3
Moderate Ambiguity	Expert	21	5.0	0.7	6.3	2.3	3.8	2.7	1.3	1.2
	Novice	21	2.8	3.0	3.6	4.0	2.6	3.2	0.5	0.7
	Total	42	3.9	2.4	5.0	3.5	3.2	2.9	0.9	1.0
Low Ambiguity	Expert	21	4.4	1.0	5.5	2.4	3.2	2.1	1.0	0.9
	Novice	21	3.3	3.0	4.0	3.5	3.1	2.2	0.4	0.5
	Total	42	3.9	2.3	4.7	3.1	3.1	2.7	0.7	0.8

This interaction between expertise and visual ambiguity was explored using simple main effects analyses. The simple main effect of visual ambiguity for the expert group was significant, $F(2, 40) = 19.89, p < .001$, whereas this simple main effect failed to reach significance for the novice group, $F(2, 40) = 1.23, p = .30$. Post hoc analyses using Bonferroni tests to follow up the significant simple main effect for the expert group indicated that the production of ideas at the high level of ambiguity was significantly greater than that at the moderate and the low levels of ambiguity (both $ps < .001$). The production of ideas at moderate levels of ambiguity was, however, not reliably different to that at the lowest level of ambiguity ($p = .183$). Further simple main effects analyses comparing across expertise groups at each level of visual ambiguity revealed that the experts significantly outscored the novices in the production of ideas at both the highest level of ambiguity, $F(1, 67.17) = 28.26, p < .001$, and at moderate ambiguity $F(1, 67.17) = 11.69, p = .001$, but not at the lowest level of ambiguity, $F(1, 67.17) = 3.32, p = .07$.

Overall, these analyses support our previous, descriptive interpretation of the data depicted in Table 2, and indicate that experts and novices differ in the way that they deal with the ambiguity inherent in the presented design cues. The experts produce reliably increasing numbers of ideas in response to greater levels of ambiguity, whereas novices show a non-significant trend toward decreasing ideas across greater levels of visual ambiguity.

6.2 V → S transformations

The ANOVA conducted on the number of V → S transformations failed to indicate the existence of either main effects of expertise, $F(1, 40) = 2.94, MSE = 15.98, p = .094$, partial $\eta^2 = 0.07$, or visual ambiguity, $F(2, 80) = 1.80, MSE = 2.15, p = .17$, partial $\eta^2 = 0.04$. Crucially, however, the interaction between expertise and visual ambiguity was reliable, $F(2, 80) = 6.12, p = .003$, partial $\eta^2 = 0.13$, which - as in the case of idea production - indicates that the effect of visual ambiguity on V → S transformations differs according to designers' expertise. The data in Table 2 show that the number of V → S transformations undertaken by novices is stable across all levels of ambiguity. The situation is different for the experts, who again demonstrate a pattern of linearly increasing V → S transformations from low to high levels of ambiguity.

The expertise by visual ambiguity interaction was explored using simple main effects analyses. The simple main effect of visual ambiguity for the expert group was significant, $F(2, 40) = 8.74, p < .001$, but this simple main effect was not significant for the novice group, $F < 1$. Post hoc analyses using Bonferroni tests to follow up the significant simple main effect for the expert group indicated that the production of V → S transformations at the high level of ambiguity was significantly greater than at low level of ambiguity ($p < .001$), but not than at moderate levels of ambiguity ($p = .086$). The production of V → S transformations at the moderate level of ambiguity was also not reliably different to that at the low level of ambiguity ($p = .427$). Further simple main effects analyses comparing across expertise groups at each level of visual ambiguity revealed that the experts significantly out-performed the novices in the production of V → S transformations at the high level of ambiguity, $F(1, 62.17) = 8.46, p = .005$, but not at

the moderate or low levels of ambiguity, $F(1, 62.17) = 2.38, p = .128$, and $F(1, 62.17) = 2.53, p = .906$.

These analyses again indicate that experts and novices differ in how they deal with ambiguity in the design cues. The experts produce reliably increasing numbers of $V \rightarrow S$ transformations in response to greater levels of ambiguity, whereas novices show stable numbers of $V \rightarrow S$ transformations across greater levels of visual ambiguity.

6.3 $V \rightarrow F$ transformations

The ANOVA conducted on the number of $V \rightarrow F$ transformations indicated the presence of significant main effects of expertise, $F(1, 40) = 21.78, MSE = 1.30, p < .001$, partial $\eta^2 = 0.35$, and of visual ambiguity, $F(2, 80) = 5.15, MSE = 0.64, p = .008$, partial $\eta^2 = 0.11$. The interaction between expertise and visual ambiguity was also reliable, $F(2, 80) = 3.59, p = .003$, partial $\eta^2 = 0.08$, which reveals that the effect of visual ambiguity on $V \rightarrow F$ transformations differs according to the expertise status of the group of designers. The data in Table 2 indicate that the number of $V \rightarrow F$ transformations undertaken by novices is stable across all levels of visual ambiguity (as was the case for $V \rightarrow S$ transformations). The state of affairs is very different, however, for the expert participants, who demonstrate a pattern of linearly increasing $V \rightarrow F$ transformations from low to high levels of visual ambiguity.

The expertise by visual ambiguity interaction was explored using simple main effects analyses. The simple main effect of visual ambiguity for the expert group was significant, $F(2, 40) = 5.46, p < .008$, but this simple main effect was not significant for the novice group, $F < 1$. Post hoc analyses using Bonferroni tests to follow up the significant simple main effect for the expert group revealed that the production of $V \rightarrow F$ transformations at the high level of ambiguity was significantly greater than at the low levels of ambiguity ($p = .004$), but not at the moderate levels of ambiguity ($p = .144$). The production of $V \rightarrow F$ transformations at the moderate level of ambiguity was also not reliably different to that at the low level of ambiguity ($p = .99$). Further simple main effects analyses comparing across expertise groups at each level of visual ambiguity revealed that the experts produced significantly more $V \rightarrow F$ transformations than the novices at the high level of ambiguity, $F(1, 105.94) = 26.43, p < .001$, at the moderate level of ambiguity, $F(1, 105.94) = 7.95, p = .006$, and at the low level of ambiguity, $F(1, 105.94) = 3.43, p = .049$.

As with the previous analyses, these findings support the view that expert and novice designers differ in how they deal with ambiguity within

presented visual cues. Experts produce increasing numbers of $V \rightarrow F$ transformations in response to increasing levels of ambiguity, whereas novices show stable numbers of $V \rightarrow F$ transformations across increasing levels of visual ambiguity.

7 Conclusion and Discussion

The primary aim of this experiment was to investigate the prediction that a person's cognitive uncertainty while viewing and interpreting an ambiguous visual stimulus would affect their design ideation and interpretative processing in relation to the presented stimulus. A secondary aim of the experiment was to determine whether there are differences between experts and novices in designing with visual stimuli of varying ambiguity. The results demonstrate that expert designers produced more design ideas than novices. In addition, experts produced more $V \rightarrow F$ transformations than novices (linking an existing visual feature to a new shape concept), and more $V \rightarrow S$ transformations than novices (linking an existing visual feature to a new shape concept), although the latter effect failed to reach significance. These results indicate that expert designers are generally more adept at idea generation and interpretation than novices, which is no doubt a consequence of both their vastly superior knowledge of design concepts and possibilities (including analogies; see Ball and Christensen, 2009), as well as their more finely-tuned strategic skills for exploring the design space using ambiguous figures so as to maximize the effective development of viable design solutions.

Importantly, however, the expertise of the designers interacted with the ambiguity present within the visual design cues, and this interaction emerged in all aspects of the data that we examined statistically. Thus the expert designers produced more design ideas and more $V \rightarrow S$ and $V \rightarrow F$ interpretations as they dealt with increasingly more ambiguous visual cues. In contrast, the novices showed more stable levels of idea production and $V \rightarrow S$ and $V \rightarrow F$ transformations across the three levels of cue ambiguity.

Overall, our results provide good evidence for the role of professional design knowledge and experience in modulating the influence of design ambiguity on the production of design ideas and design interpretations. It appears that expert designers are adept at capitalizing upon the ambiguity present within the design situation such that they are able to harness their design uncertainty in a way that can drive forward creative idea production and interpretation. Indeed, the cognitive uncertainty brought about by ambiguous figures may actually inspire expert designers explore a

wide variety of design alternatives so as to reduce their state of uncertainty. In this way the greater the degree of ambiguity that is present in the visual cue then the greater the degree of diversity that will be evident in the expert designer's innovations during the process of concept development. Expert designers may demonstrate more so-called "horizontal" transformations and interpretations than "vertical" ones, with the former aimed at preventing premature commitment to design forms (Goel, 1994; Rogers, Green and McGown, 2000). In this sense it appears that expert designers may have a good degree of inhibitory control over the uncertainty-resolution process, maintaining a dynamic balance between indeterminacy and determinacy so as to enable a rich and creative exploration of the design space prior to eventual commitment to a chosen design form.

These results could help explain why the ambiguous and unstructured visual properties of sketches are habitually used by designers, especially during early phases of design development. Our findings imply that sketch attributes in the form of ambiguous, accidental and indeterminate symbols trigger an innate, recognition-oriented search mechanism to generate a stream of imagery useful for visual interpretation. Furthermore, these properties have the function of assisting the mind in translating descriptive propositional information into depictions.

When viewing the most ambiguous figures, the production of design concepts and interpretations was far more evident in experts than novices, presumably because novices find it difficult to recognize and interpret ambiguous cues in the first place. Novices performed better in producing design concepts and interpretations when viewing cues at the lowest levels of ambiguity, perhaps because they could simply re-visualize concrete aspects of the presented image on paper. Experts also appeared to be more persistent in their visualization activities and increase their engagement in visual reasoning particularly during early phases of design. Expert designers skillfully utilize visual reasoning when dealing with high ambiguity to interpret parts of sketches or complete sketches, translating them into descriptions that elicit formerly non-existent entities (Goldschmidt 1994).

We finally note that the majority of design concepts created by both groups of designers involved them transforming a given shape into a new shape or a new function. The results thereby emphasize the importance of "form" in driving design development. However, compared to novices, experts were evidently far more skilled at extracting underlying functions or meanings from given shapes, and transforming these into novel meanings, functions or shapes. We conclude by re-iterating that early conceptual sketches that possess ambiguity, indeterminacy and a lack of

structure can play a major role in facilitating expert designers' interpretative activities and effective concept design behaviours.

Acknowledgement

The authors gratefully acknowledge the support of the National Science Council (Grant No. 98-2410-H-224-021).

References

- Attneave F, (1970) Multistability in perception. *Scientific American* 225:63–71
- Ball LJ, Christensen BT, (2009) Analogical reasoning and mental simulation in design: Two strategies linked to uncertainty resolution. *Design Studies* 30:169–186
- Berlyne DE, (1966) Curiosity and exploration. *Science* 153:25–33
- Berlyne DE, (1970) Novelty, complexity, and hedonic value. *Perception and Psychophysics* 8:279–286
- Biederman I, (1987) Recognition-by-components: A theory of human image understanding. *Psychological Review* 94:115–147
- Ericsson KA, Simon HA, (1993) *Protocol Analysis: Verbal Reports as Data*. Cambridge, MA, MIT Press
- Fish J, (1996) *How Sketches Work*. Unpublished PhD Thesis, Loughborough University of Technology, UK
- Fish J, Scrivener SAR, (1990) Amplifying the mind's eye: Sketching and visual cognition. *Leonardo* 23: 117–126
- Goel V, (1994) *Sketches of Thought*. Cambridge, MA, MIT Press
- Goldschmidt G, (1991) The dialectics of sketching. *Creativity Research Journal* 4:123–143
- Goldschmidt G, (1992) Serial sketching: Visual problem solving in designing. *Cybernetic & Systems* 23:191–219
- Goldschmidt G, (1994) On visual design thinking: The vis kids of architecture. *Design Studies* 15:158–174
- Kavakli M, Scrivener SAR, Ball LJ, (1998) Structure in idea sketching behaviour. *Design Studies* 19:485–517
- Mackay DM, (1957) Complementary descriptions. *Mind* 66:390–394
- Mishel MH, (1981) The measurement of uncertainty in illness. *Nursing Research* 30:258–263
- Rogers PA, Green G, McGown A, (2000) Using concept sketches to track design progress. *Design Studies* 21:451–464
- Scrivener SAR, Clark SM, (1993) How interaction with sketches aids creative design. *Proceedings of the International State-of-the-art Conference, Interacting with Images*, National Gallery, London
- Scrivener SAR, Tseng SW, Ball LJ, (2000) Uncertainty and sketching behaviour. *Design Studies* 21:465–479
- Suwa M, Tversky B, (1997) What do architects and students perceive in their design sketches? A protocol analysis. *Design Studies* 18:385–403
- Wu CQ, (1997) Complementarity in vision and cognition. *Philosophical Psychology* 10:481–488

The Complementary Role of Representations in Design Creativity: Sketches and Models

Alejandro Acuna and Ricardo Sosa
Tecnologico de Monterrey, Mexico

Abstract. This paper presents results and insights from a recent study on the role that different types of representations commonly used in design may have in creativity. The impact of sketches and physical models in design creativity is analysed. Our study suggests that novelty (originality) and function (quality) are valid constituents of the definition of creativity. It also suggests an apparent trade-off in the design process, where complementary representation modes must be planned in the early stages of ideation.

Keywords: Sketching, Modeling, Originality, Functionality

1 Introduction

Designers sketch and build rapid physical models to support their creativity, however little evidence exists to explain the distinction between sketching and modelling in the early stages of ideation. This paper reports a preliminary study that contributes to fill this gap by exploring the strengths and weaknesses of sketching and rapid modelling in design creativity. Design creativity is defined in this paper as the ability to generate concept proposals that are judged by experts as original solutions that respond in novel ways to a clear set of requirements (Cromptley, 1999). This definition conflates a number of key elements in order to make it operable: first, it focuses on the generative side of creativity, leaving outside the aggregate, emergent social ascription of value (Sosa, 2005). Second, it is explicitly constrained to the conceptual stage of problem solving, leaving outside the preliminary phases of problem formulation (Corson, 2010), as well as the development and implementation phases that link creativity with design innovation (Verganti, 2009). Third, the focus is on the fuzzy process of idea evaluation that characterises the early stages of the design process (Buxton, 2007). These conditions facilitate a research approach that is manageable and suitable for the methods of inquiry used in our study.

Current design practice and education paradigms assume that hand-made sketching and manual model-making are essential skills for creative design (NASAD, 2009). It is widely accepted that idea generation is better supported by the construction of rather abstract and ambiguous representations and their rapid, flexible transformations (Buxton, 2007; Prats and Garner 2006; Yang and Cham, 2007) Both sketching and rapid model-making seem to support ambiguity and flexibility better than computational modeling or detailed drawings. Although evidence exists to support the adequacy of ambiguity in early concept formation in general (Visser, 2006), studies that compare sketching and physical modeling specifically in their support for creative design are incipient and demand closer inspection (Gebhardt, 2003).

This paper presents results and insights from a recent study aimed at clarifying and contrasting different types of representations that are widely used in the design process. The roles of sketches and physical models in design creativity are analysed. Their suitability as vehicles for creativity in design is discussed. A pilot study is presented here to explore the following hypotheses in relation to the role of hand-drawn sketching and quick models in creative design:

Hypothesis 1: sketching and rapid model-making equally support creative design activities. Where creativity is assessed by experts along two specific criteria: degree of novelty and level of utility or function. A design activity with potential for creative solutions consists of a short individual design task that demands a real-scale model of a solution proposal that responds to a brief list of requirements. Previous studies provide preliminary evidence regarding the role of sketching in ideation (Yang, 2009), and the role of model-making (Ramduny-Ellis, 2008), but studies that compare the advantages and disadvantages of both are lacking.

Hypothesis 2: designers value the role of sketching in their design process and perceive that the process is

incomplete or hindered without a exploratory sketching stage. Designers tend to assume that conceptual exploration is better supported by hand-drawn sketches and other externalisations. However, previous studies suggest that there is no significant difference between sketching and not sketching for expert architects in the early phases of conceptual designing (Bilda et al., 2006).

2 Pilot Study

In order to test these hypotheses, a short study is conducted in order to compare sketching and model-making in creative design, with the following characteristics:

Activity: The Industrial Design program at Tecnológico de Monterrey campus Queretaro has a Design Studio course in every semester. The second-year design studio is oriented to the design and manufacturing of exhibition and point-of-purchase stands. The pilot study presented in this paper is part of this second-year course. In this activity, students are required to design a counter top stand to display and dispense candy and chocolate snacks at convenience stores. The requirements of this task are: a) the stand must be easy to use both by the final user to grab the product and by the shop attendant to refill the product, b) the stand must contain and visually identify one specific target brand and product presentation, c) the stand must be built in one single material to choose between cardboard or laminated plastic (PVC, PS or PETG), and d) the stand must be innovative, yet simple to manufacture and assemble. The task is conducted individually, and subjects select the target brand and product among a range of options provided in physical form at initial time.

Subjects: Twenty-five second-year industrial design students participated in the study. They were 12 male and 13 female subjects, all between the ages of 19 and 20. Two groups are formed with a balance between grades in the previous design studio and gender. Each group is assigned a separate classroom for this exercise. In *control group S (sketching)*, subjects are asked to conduct the usual design process that they follow in the second-year design studio: an initial stage of concept sketching followed by the construction of rapid models and on the second session, the building of a detailed real-scale functional model. In *experimental group M (modeling)*, subjects are asked to skip the sketching stage, and they were instructed to start directly with the manual construction of rapid models ("3D sketching"), followed by the detailed execution of a final real-scale functional model in the second session. In all cases, subjects had satisfactorily

completed four first-year courses on drawing and model-making techniques.



Fig. 1. Subjects in sketching mode



Fig. 2. Subjects in modelling mode

Contextual conditions: Two sessions of 3 hours each are conducted in one week. During the first session, the researcher provides the task explanation and requirements; subjects select their target product and develop individually their design concepts, concluding with the submission of their final proposal. In the second three-hour session, subjects construct and submit their final real-scale functional models; small changes in details and adjustments are allowed during this session. Subjects present their final models containing a sample set of products, and photographic records are made registering four different views of the product. Note: students are required to work in the graphic labels and print materials in the two days between sessions.

Assessment: Two design teachers with 20-year professional experience in display and exhibition design, conduct an evaluation process based on the photographic records of the exercise. Solution proposals from both groups are presented interchangeably to avoid bias. This assessment of creativity considers two specific criteria: originality and functionality. Judges are provided the following definitions: “Originality is the degree of novelty in the layout and configuration of counter top stands”, and “Functionality is the likely feasibility and adequacy given the requirements and the overall quality of the solution”. The evaluation scale for both criteria is 0 to 100.



Fig. 3. Subject building a model

Upon completion of the design task, subjects are also asked to respond a short questionnaire to learn about their impressions about working with/without sketching. Of particular relevance to this study are the following two questions:

Q1: How would you rate your own performance in this activity? (1 to 5)

Q2: Was sketching important in your design process in this activity? (Y/N)

3 Results

Three main differences between group S and group M were registered in regards to the assessment of their proposals: first, the mean values for originality were marginally higher in group S than group M; second, the opposite effect was observed in regards to functionality with group M having marginally higher

scores than group S; third, evaluations of functionality showed higher consistency across groups, while evaluations of originality were more disperse as shown in Table 1.

Table 1. Mean and variance (stdev) assessment values for groups M and S

	originality scores	functionality scores
group M mean / stdev	45,7 / 2,24	46,5 / 1,74
group B mean / stdev	48,0 / 2,3	44,0 / 1,96

The interaction between these two components of creativity (originality plus functionality) is confirmed by two results: the close similarity between the aggregate evaluation of both groups: 46,1 for group M and 46,0 for group S, and the similar distribution of aggregate scores between the two criteria in both groups, which indicates that the task of evaluating originality (a highly subjective perception) yields more diverse judgements compared to functionality (a more objective evaluation).

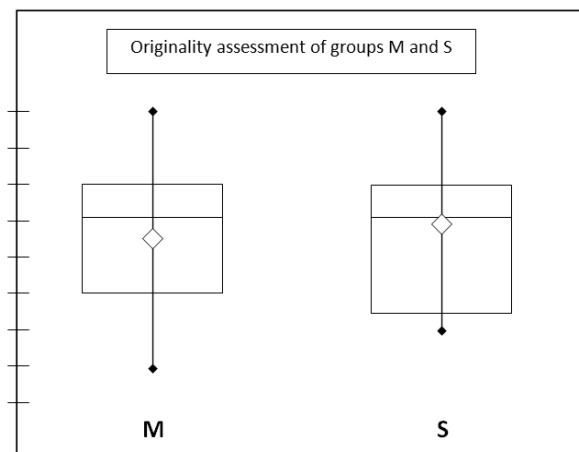

Fig. 4. Box plot comparing groups M and S evaluations on originality

These results neither support nor reject hypothesis 1 of this study: “sketching and rapid model-making equally support creative design activities”. Instead, they provide a richer picture of the role of these representation modes in creative design. These results suggest that sketching may be a better way to achieve originality, whilst modeling may be more appropriate for the development of functional solutions. If we consider that creativity is the sum of originality and functionality, then hypothesis 1 is verified at a general level -however, at a more detailed component-based level, hypothesis 1 is contradicted.

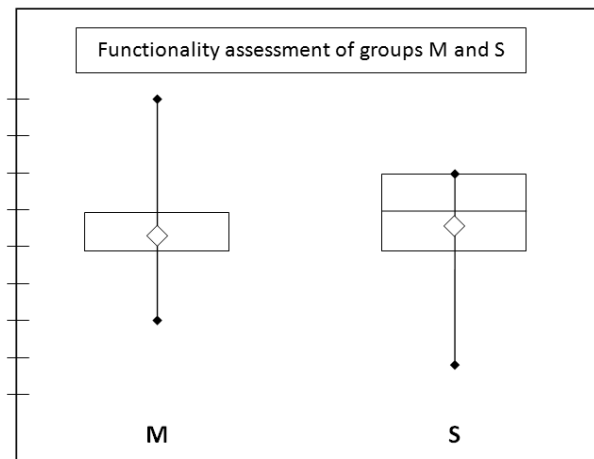

Fig. 5. Box plot comparing groups M and S evaluations on functionality

Responses to Q1 in the questionnaire indicate that group M students felt that their performance was better than group S's, as shown in Table 2. No answers were provided to categories 1: excellent and 5: poor.

Table 2. Responses of Q1

Q1: How would you rate your own performance in this activity? (1:excellent to 5:poor)	Group B	Group M
2. Very Good	27%	54%
3. Good	64%	38%
4. Regular		8%

Responses to Q2 indicate that most students in group M felt that sketching was not important in their design process, as shown in Table 3.

Table 3. Responses of Q2

Q2: Was sketching important in your design process in this activity? (Y/N)	Group B	Group M
Yes	100%	69%
No		31%

These responses in the questionnaire reject hypothesis 2: designers value the role of sketching in their design process and perceive that the process is incomplete or hindered without a exploratory sketching stage. In this case, our subjects provided significantly higher evaluations of their own performance in group M, where sketching was forbidden. Moreover, subjects

who weren't allowed to sketch, ascribed a lower than expected importance to sketching. These results suggest that sketching may be over-valued in design education and practice, although they are inconclusive and require further validation.



Fig. 6. Sample final model with high scores

4 Discussion

The results that emerged from our study suggest that the two basic elements of the definition of creativity that we adopted in this study are valid as confirmed by the evidence: there is a clear interaction between novelty (originality) and utility (quality) even in short and simplified design tasks. Despite the different results produced, the sum of these two factors were unexpectedly similar across all of our study groups, which suggests that the creativity construct of originality and functionality is consistent (Cropley, 1999). This validates the definition of creativity as novelty plus utility as a valid framework for future studies under these conditions.

The results presented here further suggest a correlation between sketching and originality: given a limited amount of time and under similar conditions, designers that exhibit a high investment on sketching time, also tend to generate more original solutions. Although this correlation cannot be used to infer causality, further studies should target the causal relationship between sketching and originality.

In contrast, our results show that the higher the time investment in model-making, the final ideas tend to be of higher quality, i.e., a correlation is observed between models and functional requirement satisfaction. These two outcomes could suggest an apparent trade-off in the design process, where these two early activities must be carefully balanced depending on the goals of the project. Future studies could explore the causal interactions between physical modeling and functionality measures of early idea generation.

Figure 7 illustrates the main insight found in this study; namely, that sketching is as a suitable representation aid for the originality component of creativity, whilst realistic models and prototypes are media more suitable for the functionality component of creativity. Two implications are worth studying in future efforts: would more concrete drawings such as blueprints be more suitable for functionality? and would low-fidelity "dirty" models be more appropriate for originality?

This preliminary study targeted design student activity judged by a small panel of design teachers. Future work will extend these limits to distinguish between novice and expert design practitioners, while the assessments could integrate industry evaluation practices to achieve higher validity. Future studies will target the following hypothesis: "sketching supports originality and physical modelling supports functionality in the creative design process".

The results of this study further suggest that the design curriculum should incorporate the key competency of choosing between abstract representations such as sketching and material representations such as model-making for ideation (Brereton, 2004). The implications for design practice include the insight that creativity seems to be more independent from any single representation mode than previously imagined. Role-assignment in design teams determined by disciplinary background or skill proficiency may be questioned. Instead, new design practices may be necessary to generate, transform and evaluate ideas across representations in order to explore the space of solutions.

In the long term, this research aims to develop evidence-based teaching approaches and professional-level toolkits for practitioners that specifically aid in the generation and communication of ideas in early design stages.

In addition, further research work is necessary to explore the role of other types of representations used in the early stages of design, such as language (Nagai, year). In concrete, the role of language articulation and its interplay with sketching and modeling could be studied in creative design. Just as a combination of sketching and modelling skills are beneficial for creativity, we may speculate that more articulate and polyglot designers may be in advantage for creativity over their more reserved and monolingual colleagues.

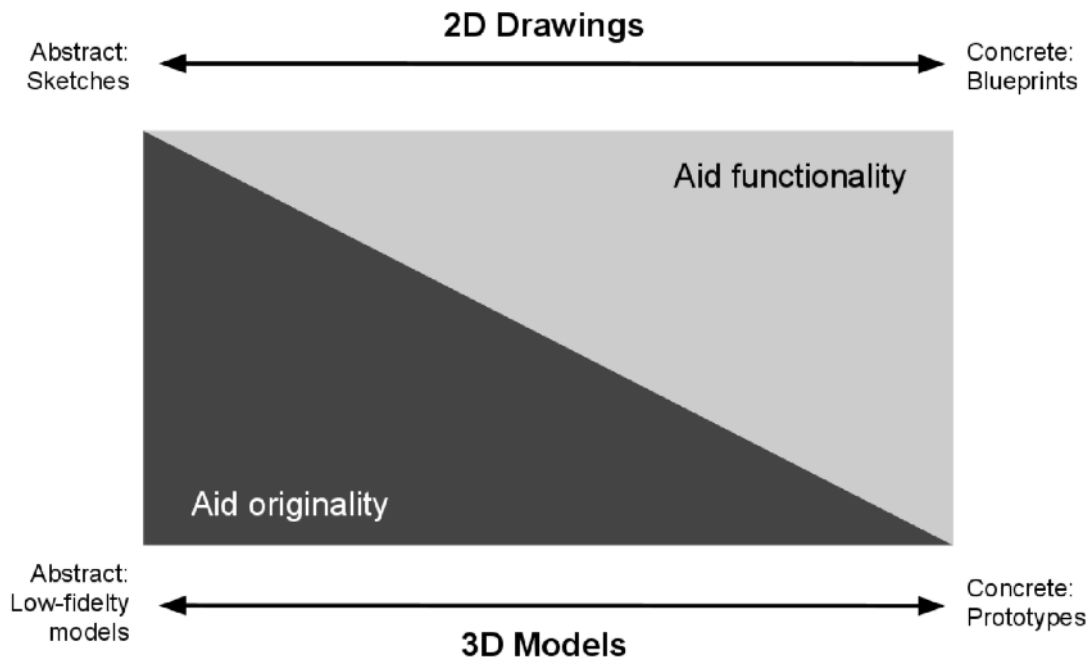

Fig. 7. Design creativity representations

References

- Bilda Z, Gero JS, Purcell T, (2006) To sketch or not to sketch? That is the question. *Design Studies* 27(5): 587–613
- Brereton MF, (2004) Distributed Cognition in Engineering Design: Negotiating between abstract and material representations. In Goldschmidt G, William L, Porter (Ed.), *Design Representation 1* ed.: 83-103, London: Springer
- Buxton B, (2007) *Sketching User Experiences: Getting the Design Right and the Right Design*. Morgan Kaufmann
- Corson B, (2010) Sustainable Design as a Sustained Upstream Effort. *International Journal of Engineering Education* 26(2): 260–264
- Cropley A, (1999) Definitions of Creativity. In SR Pritzker, MA Runco, (Eds), *Encyclopedia of Creativity*, Academic Press
- Gebhardt A, (2003) *Rapid Prototyping*. Hanser Publishers
- Goodman N, (1976) *Languages of Art* Hackett Publishing Company
- National Association of Schools of Art and Design Handbook 2009-10: October 2009 Edition: <http://nasad.arts-accredit.org>
- Prats M, Garner S, (2006) Observations on Ambiguity in Design Sketches. *Tracey the Online Journal of Contemporary Drawing Research*: 1–7
- Ramdney-Ellis D, Hare J, Dix A, Gill S, (2009) Exploring Physicality in the Design Process. In: *Undisciplined! Design Research Society Conference 2008*, Sheffield Hallam University, Sheffield, UK, 16-19 July
- Sosa R, (2005) *Computational Explorations of Creativity and Innovation in Design*. PhD Dissertation, The University of Sydney Australia. <http://hdl.handle.net/2123/614>
- Taura T, Nagai Y, Morita J, Takeuchi T, (2007) Study of design creativity using a linguistic interpretation process to characterize types of thinking. *ICED'07 16th International Conference of Engineering Design*, Paris, France
- Verganti R, (2009) *Design Driven Innovation: Changing the Rules of Competition by Radically Innovating What Things Mean*. Harvard Business Press
- Visser W, (2006) Designing as Construction of Representations. *Human-Computer Interaction, Special Issue "Foundations of Design in HCI"* 21(1):103–152
- Yang MC, Cham JG, (2007) An Analysis of Sketching Skill and its Role in Early Stage Engineering Design. *ASME Journal of Mechanical Design* 129(5): 476–482
- Yang MC, (2009) Observations on concept generation and sketching in design. *Research in Engineering Design* 20(1):1–11

Design Education

A Creativity Environment for Educational Engineering Projects when Developing an Innovative Product:
A Case Study

Karl Hain, Christoph Rappl and Markus Fraundorfer

The Metaphor of an Ensemble: Design Creativity as Skill Integration

Newton S. D'souza

Coaching the Cognitive Processes of Inventive Problem Solving with a Computer

Niccolò Becattini, Yuri Borgianni, Gaetano Cascini and Federico Rotini

Creative Engineering Design Aspects given in a Creativity Training Course

*Joaquim Lloveras, Miguel-Angel Saiz, Carlos García-Delgado, Jairo Chaur, Lluís Claudi,
Anna Barlocci and Laura Carnicero*

A Creativity Environment for Educational Engineering Projects when Developing an Innovative Product: A Case Study

Karl Hain¹, Christoph Rapp¹ and Markus Fraundorfer²

¹ University of Applied Sciences, Germany

² Inoutic / Deceuninck GmbH, Germany

Abstract. This article presents a unified approach in engineering design education in the faculty of Mechanical Engineering and Mechatronics at the University of Applied Sciences, Deggendorf, Germany. The described approach aims at providing undergraduate students a creativity stimulating environment by means of specific guidelines for conducting engineering design projects which are compulsory within their studies. The proposed structure is based on existing design methodologies having the possibility of embedding proper creativity techniques along the course of projects. Eventually, by taking advantage of the proposed guideline frame, a case study for the development of an innovative product is described.

Keywords: Creativity and Innovation, Engineering Design Education, Design Methodology

1 Design Methodology / TRIZ

The theory of a systematic respectively methodical design has been sufficiently worked out and outlined in literature and publications. According e.g. to (Pahl and Beitz, 2007) the design process utilizes several stages, beginning with the clarification of the task, followed by a conceptual design phase, an embodiment design phase and ending with detail design (Fig. 1) which finally results into a mechanical, electromechanical, hydraulic or pneumatic respectively combined structure of the product. A mechatronic system is characterized by the additional integration of sensors providing input parameters for an information processing unit, and actuators to implement necessary effects on the basic system (Hain et al., 2008). Within specific design stages several aids and methods are applicable and recommended to incorporate into the design process. Actually design methodology describes a linear process, however, having the possibility for design loops at every design stage. The process itself is described on a high level, therefore quite abstract in order to fit every possible design task independent of any discipline.

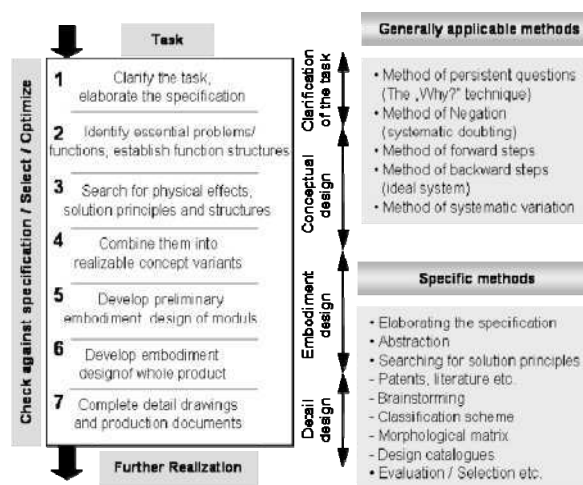

Fig. 1. Design methodology

The inventive problem solving method TRIZ (Fig. 2) was developed by analyzing thousands of patents thus developing knowledge of different kinds of contradictions and means of overcoming them. More abstract insight were also identified and confirmed through repetition in multiple cases, for instance, the strategy of separating contradictory properties in space or time or the principle of preparatory action. TRIZ can be viewed as producing three important outputs, First, and at the lowest conceptual level, the methodology includes a substantial set of physical effects and devices that inventors can be use to achieve particular purposes, i.e. a compendium of stock solutions or raw materials for innovations involving physical phenomena; second, at a middle level of abstraction, a wealth of heuristic has been identified that innovators can learn and apply. Some of these – change the state of the physical property; introduce a second substance, for instance – are tied to the kinds of physical inventions and patents which were studied. Others are more general. Do it inversely; do a little less; fragmentation / consolidation; ideal final result;

and model with miniature dwarfs; all can be applied with socio-technical systems and other problems that are solved at the chemistry and physics level (Shavinina and Larisa, 2003, Klein, 2002). Some of these heuristics have been identified in other fields, e.g. forcing an object to serve multiple functions, the value of incorporating multiple objects into one system, looking for analogies in other areas etc. are standard design strategies and have long been recognized.

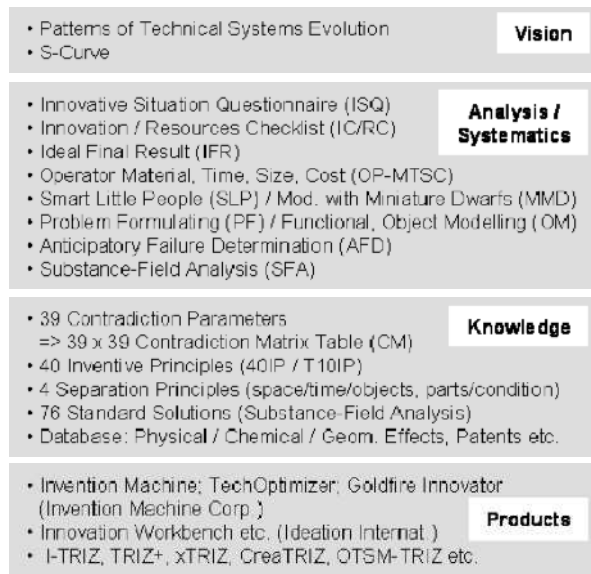

Fig. 2. TRIZ – inventive problem solving

2 Design Projects in Education

A commonly agreed goal and challenge in engineering education is to improve the efficiency of product development processes, to enhance students project experience, to make them familiar with appropriate creativity techniques and skills to master the complexity of products in terms of innovation, invention and problem solving. However, instructors face the question of how to provide a creativity stimulating environment, how to structure the process at all, how to deliver and request information in an appropriate manner. The following presents a model for students and lecturers as well how to manage design projects and how to proceed and interact (Fig. 3). Although every design project is different, certain types of projects may have comparable features. The approach aims at combining important aspects of existing design methodologies and creativity techniques with an appropriate organisational structure. It is supposed to represent a guideline for

undergraduate students conducting one or two semester long senior design projects in mechanical engineering and mechatronics. These student groups work very often together at projects which supports the interdisciplinary approaches to design challenges. Project ideas ideally emerge from intense cooperation with local enterprises thus getting university approaches validated by case studies from industry (Hain and Rapp, 2010).

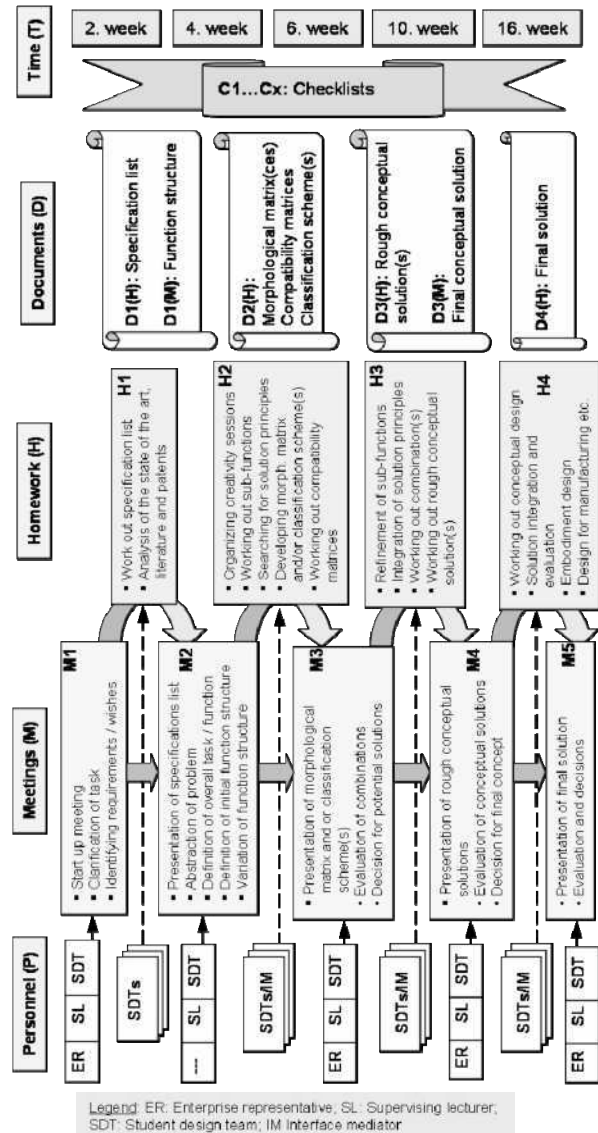

Fig. 3. Structuring engineering design projects

The guideline project structure was designed in consideration of the following: Engineering design education is mainly based on practical studies represented by engineering design projects. Students

have by nature less up to none project experience and lack in general the ability to define a problem at all. They don't have much experience in using creativity techniques and developing solutions. Furthermore they have weak work documentation habits, even so the importance of written communication skills has long been recognized. A comprehensive and tailored design methodology is commonly agreed to be the base for an innovative design, as creativity can result from a systematic approach by increasing the likelihood of obtaining a "best" solution and making engineering design fully learnable. For beginners however, a systematic approach is difficult because of the variety of design methodologies and creativity techniques. In general design processes are described on an abstract level, the cycles are often confusing and don't provide clarity, which precise path should be followed and which methods be applied. Furthermore no information is given about involved personnel, time consumption, necessary actions, evaluations or decisions to be taken, etc. The proposed structure is intended to overcome certain shortages recognized when conducting student design projects. The key features respectively activities are:

- Involved personnel (P)
- Project status: meetings (M1 to M5)
- Homework stages (H1 to H4)
- Produced documents (D1 to D4)
- Design checklists (C1 to Cx)
- Time schedule (T)

The following checklists are delivered to students and recommended for use along the course of a project:

- Brainstorming guideline
- Setting up a specification list
- Problem abstraction, black-box representation
- Setting up a function structure
- Morphological matrix / compatibility matrix
- Classification scheme parameters list
- TRIZ: Ideal Final Result (IFR)
- TRIZ: Operator Material, Time, Space, Cost (OP-MTSC)
- TRIZ: Smart Little People (SLP)
- TRIZ: Anticipatory Failure Determ (AFD)
- TRIZ: Conflict Matrix (CM)
- TRIZ: Top Ten Inventive Principles (T10IP)
- TRIZ: Forty Inventive Principles (40IP)
- TRIZ: Four Separation principles (4SP)
- Design catalogues overview on request
- Evaluation methods

In the case of original designs especially the TRIZ-methods IFR, OP-MTSC, SLP and 4SP are suggested to use initially, in the case of adaptive respectively

variant designs the methods T10IP, CM, 40IP, AFD are mostly applicable.

3 Case Study – An Innovative Product

3.1 The Overall Concept

The following describes some steps of the systematic design of an innovative window system, i.e. puts theory into practice. The innovative window is to allow the Opening / Closing / Aerating without having to open or tilt the window separately (Patent, 2006, Europäische Patentanmeldung, 2009). The window casement, which is mounted to a frame by hinges, is kept in place while several states are operated. The basic functionality is a controllable mechanism for automated locking and simultaneous sealing realized by moveable locking strips in the frame and a mating profile in the casement. The system is intended to take up 3 states (Fig. 4) while the operation time between the changing of states shall not exceed 5 seconds. The project comprises the realization of mechanical and electrical components and also a logic system control (Hain et al., 2008). In this research the development of a specific mechanical subsystem is pointed out.

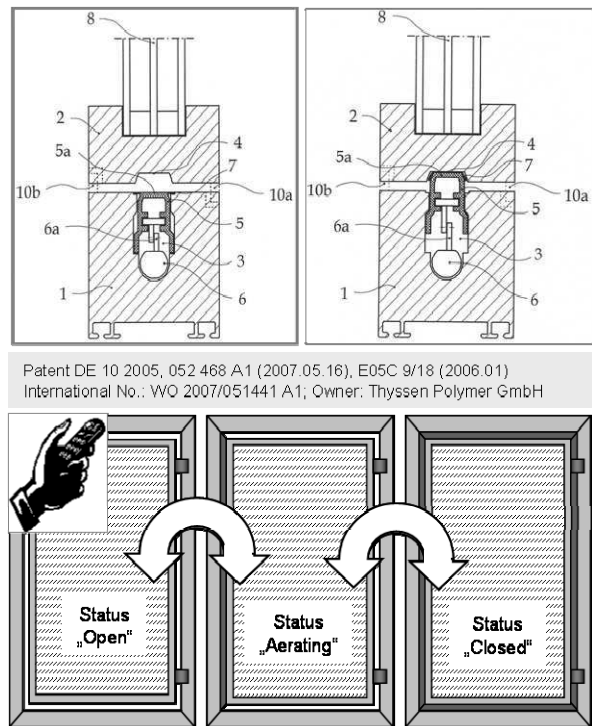

Fig. 4. Excerpts of patent and required functionality

Based on the initially elaborated specifications list the required functions and essential constraints were identified. Then an abstraction and overall problem formulation was aspired by omitting requirements that have no direct bearing on the function. Fig. 5 (upper) describes the generalized overall task with inputs and outputs which led to a definition of the objective on an abstract plane, without laying down any particular solution.

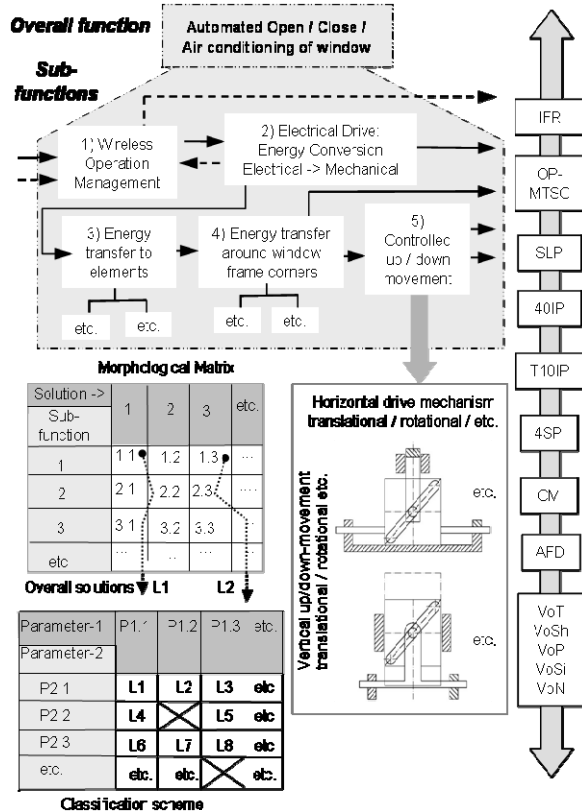

Fig. 5. Function structure, schemes and methods

Taking this definition for granted an initial so-called didactic brainstorming session was held so that not all constraints were strictly taken into account, e.g. energy supply, geometric limitations, space constraints, budget demands etc. In this phase TRIZ-methods Ideal Final Result (IFR), Operator MTSC, Smart Little People (SLP) and Top Ten Inventive Principles (Fig. 6) were integrated. The outcome was a lot of partly quite different solution concepts, e.g. the usage of single/multiple drives (electric / hydraulic / pneumatic) and flexible (e.g. ropes, cords etc.) respectively un-flexible (e.g. shafts, rods etc.) connectors, furthermore a lot of different types of mechanisms for lifting respectively pulling down the locking strips. It shall be annotated, that a clear definition of sub-functions depends to a high degree on the number of imaginable

overall conceptual designs. Therefore, after a first evaluation procedure the multiple drive solutions, i.e. separate drives for each locking strip, were discarded because of budget reasons, furthermore the usage of several solenoids because of frame space restrictions. An ideal system was considered to consist of only one electric drive which actuates the whole mechanism to take up 3 states.

- 01 **Parameter changes**: Change an object's physical state (IP35)
- 02 **Preliminary action**: Perform, before it is needed, the required change of an object (IP10)
- 03 **Segmentation**: Divide an object into independent parts (IP01)
- 04 **Mechanics substitution**: Replace a mech. means with a sensory (IP28)
- 05 **Taking out**: Separate an interfering part or property from an object, or single out the only necessary part (or property) of an object (IP02)
- 06 **Dynamics**: Allow (or design) the characteristics of an object, external environment, or process to change to be optimal or to find an optimal operating condition (IP15)
- 07 **Periodic action**: Instead of continuous action, use periodic or pulsating actions (P19)
- 08 **Mechanical vibration**: Cause an object to oscillate or vibrate (IP18)
- 09 **Color changes**: Change the colour of an object / ext. environment (P32)
- 10 **The other way round**: Invert the action used to solve the problem (IP13)

Fig. 6. TRIZ - top ten inventive principles (T10IP)

Based on these prerequisites the establishment of a function structure was aspired. It is supposed to represent a clear definition of existing sub-systems with decreasing complexity, so that they can be dealt with separately which facilitates the subsequent search for solutions. The main function was decomposed into 5 individual sub-functions and logically arranged by the use of block diagrams (Fig. 5, upper). The relevant input/output flows of energy, material and signals are also indicated. In this case electrical energy is provided and incoming and outgoing signals control the whole window operation process.

The next step was to set up one morphological matrix as a guiding scheme for the overall task. Such a scheme enumerates all solutions for known sub-functions (Zwicky, 1976), even if specific sub-functions required a more intense examination by the means of so-called classification schemes (Pahl and Beitz, 2007; Grabowski and Hain, 1997). Several of them were drawn up simultaneously to record conceived solutions and to allow the generation of further ones (Fig. 5, lower). The usually two-dimensional scheme consists of rows and columns of parameters used as classifying criteria which the designer has to determine. The final depictions represent comprehensive collections of solutions which later on can serve as design catalogues for repeated use. After analyzing all sub-functions with respect to their anticipated importance the sub-function

No.5 turned out to be the most essential one thus was strongly focused upon.

3.2 Working Out a Specific Subfunction

Controlled up/down movement: It represents a sub-system whose outputs cross the assumed overall boundary. It is good practice to start from these and then determine the inputs and outputs for the neighboring functions, i.e. work from the system boundary inwards. Its output is the effective energy for lifting up respectively pulling down the closure strips. The input energy must be provided by an electric drive via an appropriate connection. Therefore, the classifying criteria for the columns were determined to be “Basic horizontal drive mechanism” and “Vertical up/down movement” for the rows (Fig. 5, lower) which was extended by a further breakdown of characteristics. First basic ideas were integrated and new ideas produced subsequently by means of systematic variation, i.e. type, shape, position, size, number and several TRIZ-methods. Promising solution concepts were detailed in order to analyse them carefully with respect to meet the requirement of a forced change of positions and to take them up in a correct order. After an evaluation process one working principle was considered being worth for further detailing (Fig. 7).

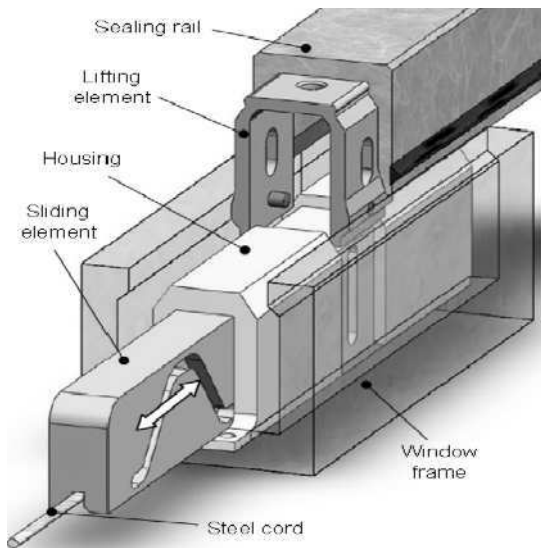

Fig. 7. Working principle for relevant subfunction

Based on this obviously feasible working principle the connection between the rope and the sliding elements turned out to be the most important and challenging task to be solved in order to guarantee eventually the realization of the whole concept. An essential mounting requirement for that sub-function had to be

obeyed, namely the precondition of having the drive and rope already installed circumferentially within the frame and setting the pre-assembled eight lifting units afterwards in position within the window frame (Fig. 8). This required the mounting of the lifting elements directly onto the bottom of the window frame along a vertical direction and connecting them to the steel cord preferably with standard tools (screwdriver, wrench, allen wrench, etc.). In order to broaden the solution spectrum several inventive design principles proposed by TRIZ were taken systematically into consideration.

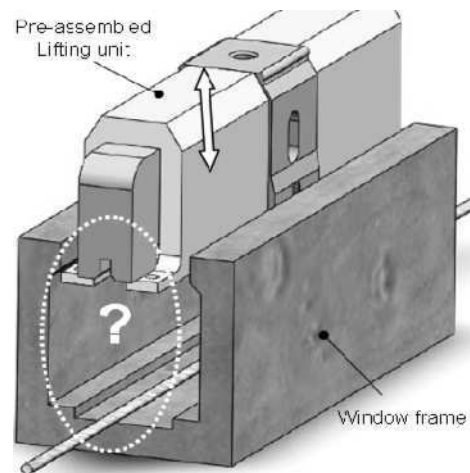

Fig. 8. Assembling requirements

Variants 01/02: To find solutions for that specific sub-task, that is, reliable force transfer (input / output) into the lifting elements, another so-called didactic brainstorming session was held whereby not all constraints were outlined at the beginning, e.g. specific mounting directions, space constraints. The outcome essentially was several solution concepts which are commonly known: Set the rope indirectly under pressure between two plates with a screw; use a screw with a cone end which puts pressure directly onto the rope, etc. (Fig. 9).

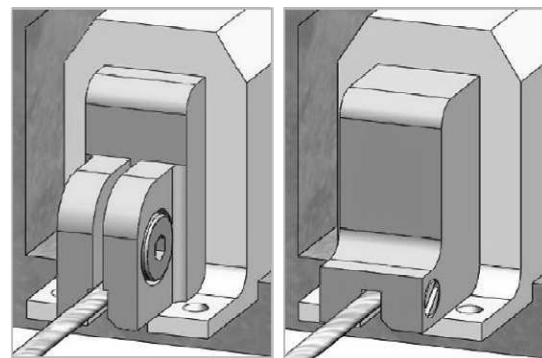

Fig. 9. Initial solution principles (No. 01 / No. 02)

These preliminary results were additionally inspired by TRIZ-IP-06 “Universality – Make a part or object perform multiple functions; eliminate the need for other parts”.

Variants 03/04: Further ideas had to be produced having the possibility to use a standard tool vertically to put the rope under pressure in order to connect it with the sliding element. The solution No.3 (Fig. 10, left) was directly derived from the initial variant No.01 by changing the mounting direction for the screw from horizontal to vertical. The tightening of the screw leads to a vertical tensile stress of portions of geometry thus to horizontal movements of deformable wings which then effect pressure on the rope. The elastic behaviour of the wings, which are part of the sliding element, is supported by slotting the area between the wings and the remaining block. Variant No.04 (Fig. 10, right) represents the outcome of applying TRIZ-IP-04, which recommends “Asymmetry - Change the shape of an object from symmetrical to asymmetrical; if an object is asymmetrical, increase its degree of asymmetry”. Therefore No.04 is similar to No.03 having only an asymmetrical layout. It features a screw which pulls a wing against its steady counterpart and therefore pressurizes the rope.

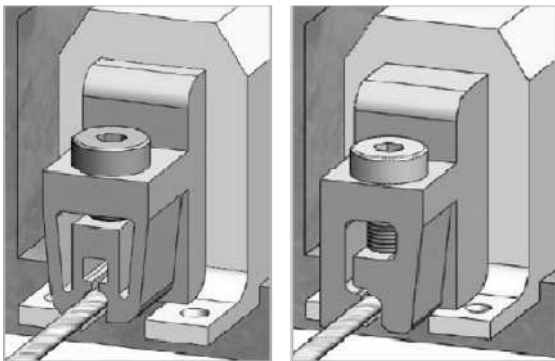

Fig. 10. Solution principles (No.03 / No.04)

Variants 05/06: These variants (Fig. 11) were stimulated by applying the TRIZ-IP-06 “Universality” (see No.01/02) and particularly TRIZ-IP-10 “Preliminary action - Perform, before it is needed, the required change of an object either fully or partially; principle of preparatory action; do it in advance”. Taking this as a guiding idea, the elastic wings are geometrically designed and dimensioned so that a pre-tension is generated. The screw then is actually no more required when the system is operated. The coned and headless set screw presses the wings apart before the sliding units are installed and can be completely removed afterwards. Other ideas based on this TRIZ-principle were produced like “pre-process the rope in order to get better connection qualities”, “pre-connect the sliding elements and rope before putting them into

the frame” etc. The solution principle No.06 was developed by taking advantage again of TRIZ-IP-04 “Asymmetry”, where just one wing is pressed aside by a set screw.

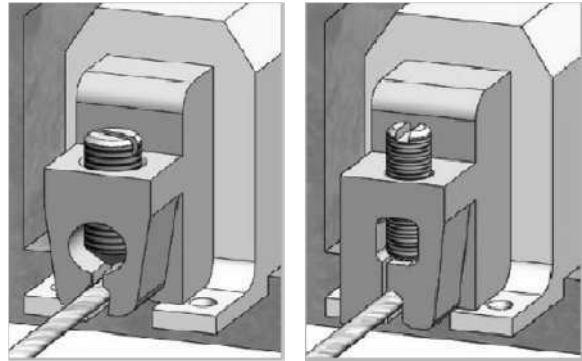

Fig. 11. Solution principles (No.05 / No.06)

Variants 07/08: TRIZ-IP-01 recommends the “Segmentation - Divide an object into independent parts; make an object easy to disassemble; increase the degree of fragmentation or segmentation”. In order to follow this design rule the required connection mechanism was divided into several parts, e.g. two levers and pins which serve as axles for the levers (Fig. 12, left). Force is applied by means of a set screw having effect on the levers at one side. The transferred force then causes pressure onto the rope. Depending on the dimensioning the pressure is possibly increased by the leverage effect. Actually the TRIZ-IP-24 was used simultaneously, which says “Intermediary - Use an intermediary carrier article or intermediary process”. In this case the intermediary carrier is represented by the levers, which transfer the applied mounting force to the required position near to the bottom of the window frame. The solution principle No.08 (Fig. 12, right) was worked out by taking again advantage of TRIZ-IP-04 “Asymmetry”, where just one lever is pressed against the rope via a set screw.

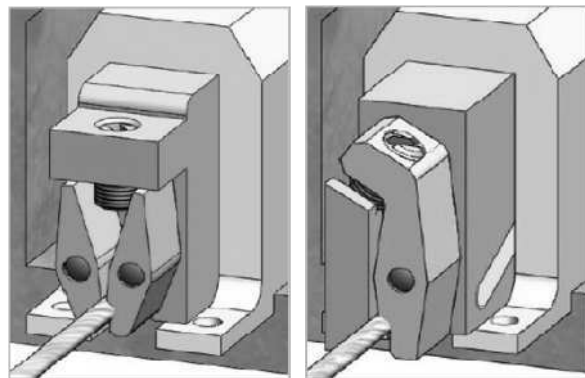

Fig. 12. Solution principles (No.07 / No.08)

Variants 09/10: These variants were developed by employing especially TRIZ-IP-01 “Segmentation” and TRIZ-IP-24 “Intermediary” (see explanations above). Fig. 13 (left) shows a connecting mechanism where a specific V-shaped part is pulled upwards through a rectangular hole in the sliding element. The V-part has a screw on top and is intended to deform when the nut is tightened. The version depicted in Fig. 13 (right) can be regarded as result of applying TRIZ-IP-13 “The other way round - Invert the action(s) used to solve the problem”, which in this case was quite inspiring and stimulating. Force is applied in an opposite direction: Instead of pulling up an element the set screw is pressing down a V-shaped part.

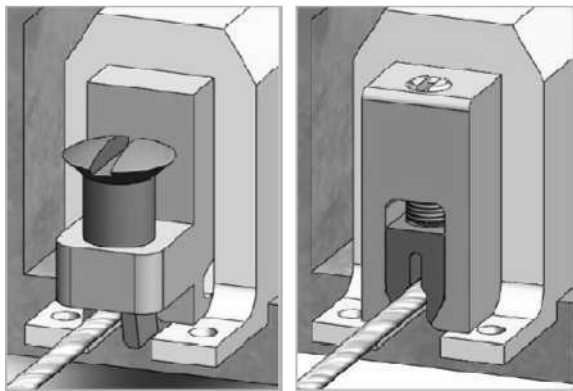

Fig. 13. Solution principles (No.09 / No.10)

Based on the described variants parts were prototyped and tested in order to prove the feasibility. Unfortunately none of the described concepts could guarantee a secure connection between the rope and the sliding element thus putting the overall mechanism in question. The ubiquitous occurring problem was the increasing deformation of the sliding element resulting from reaction forces when applying pressure onto the rope. The deformation itself led to a rough-running and uncontrollable operation mode of the sliding element when pushed or pulled through the housing. So a serious conflict was identified which according to TRIZ-methodology can be resolved by specific IPs if only the proper contradictory parameters can be defined. The contradiction was expressed like this: An increasing Force / Stress or Pressure (which improves the connection) leads to the worsening features: Strength, Reliability and Object-generated harmful factors. The TRIZ-contradiction matrix recommends several IPs whereas IP-03, IP-13 and IP-35 are most favourable (Fig. 14).

Worsening Feature →	14: Strength	27: Reliability	31: Object-generated harmful factors	No.	Inventive Principle	frequency
Improving Feature				03	Local quality	3
10: Force (Intensity)	35, 10, 14, 27	03, 35, 15, 21	13, 03, 36 24	13	The other way round	3
11: Stress or pressure	09, 18, 13, 40	10, 13, 19, 35	02, 33, 2/ 18	35	Parameter changes	3

Fig. 14. Conflict matrix and resulting IPs

Variants 11/12/13: In considering particularly TRIZ-IP-13 “The other way round” and TRIZ-IP-03 “Local quality - Change an object's structure from uniform to non-uniform; make each part of an object function in conditions most suitable for its operation; make each part of an object fulfill a different and useful function”, an optimization of the connecting concepts was aspired. Variant No.11 (Fig. 15, left) redirects the horizontal deformation to a minor vertical one by letting the screw pull the carrier element instead of pressurize it. Variant No.12 (Fig. 15, right) avoids the deformation of the sliding element in that a carrier element arranged around an axle absorbs induced forces almost completely.

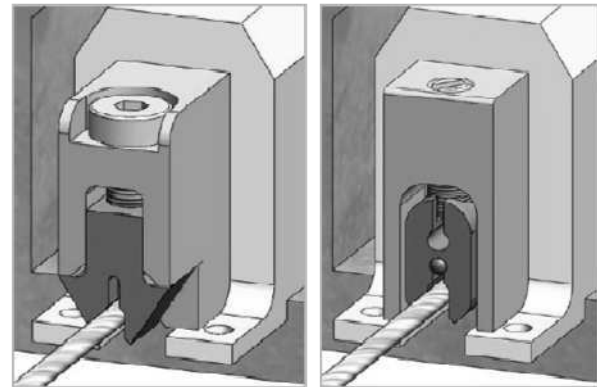

Fig. 15. Solution principles (No.11 / No.12)

Another solution, which actually turned out to be most promising and satisfying is depicted in Fig. 16 (left), where the reaction forces are eliminated nearly completely within the subsystem consisting of a modified headless set screw containing another coned stud screw in the centre setting the rope under pressure. Nearly all reaction forces and deformations are induced into this element and have little effect on the sliding element.

It shall be annotated that the Top Ten TRIZ-IP-15 “Dynamics - Allow (or design) the characteristics of an object, external environment, or process to change to be optimal or to find an optimal operating condition; absorb forces within a system or subsystem and

eliminate them”, was also an inspiring source for this design step.

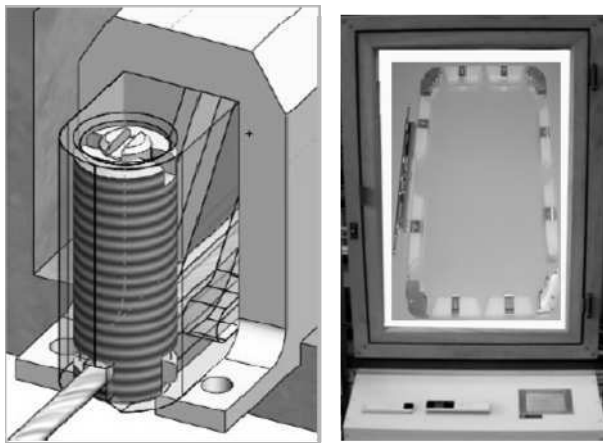

Fig. 16. Solution principle No.13 / Prototype system

After having sub-functions realized and compatibility checked among each other the whole system was manufactured and prototyped (Fig. 16, right) and is running under test conditions. So far the developed prototype has turned out quite satisfactory.

4 Conclusion

Several regular design project evaluations revealed, that a conceptual guideline or design project map is particularly appreciated when conducting practical work in an educational context. It is useful in visualizing the whole process and how activities of design and the use of creativity techniques are influenced by numerous factors like the problem definition, state of information, complexity of the task and the nature of the preliminary work. Case studies also made clear, that if given an appropriate guiding frame, students can act, communicate and cooperate properly and produce a better final project and consequently product quality while instructors interference is minimized. The outcome is quite

promising with respect to tackling the poor problem solving experience, improving the documentation habits and stimulating the development of thinking patterns at different levels of resolution which should be regarded as a kind of heuristics rather than being used as strict algorithms.

References

- Europäische Patentanmeldung: EP 2107192 A2; Anmelder: Inoutic / Deceuninck GmbH, Bogen (DE); Int. Cl. E05C 9/06 (2006.01), Anmeldetag: 24.3.2009
- Grabowski H, Hain K, et al., (1997) Supporting the Search for Design Solutions Based on Information Recognition and Automated Classification. ProKSI-Workshop, Sophia Antipolis, France
- Hain K, Rappl C, (2010) Engineering Design Projects in Education: A Reference Frame Based on Design Methodology. Proceedings of INTED-2010, ISBN-978-84-613-5538-9
- Hain K, Rappl C, Kaiser F, Fraundorfer M, (2008) A Case Study for Systematic Design of a Mechatronic Product for Buildings. 15th Int. Conf. on Mechatronics and Vision in Practice (M2VIP), Dec 2008, Auckl. New Zealand. ISBN: 978-0-473-13532-4
- Klein B, (2002) TRIZ/TIPS - Methodik des erfinderischen Problemlösens. Oldenbourg Verlag. ISBN: 3-486-25952-0
- Pahl G, Beitz W, (2007) Engineering Design: A Systematic Approach. Edited by Ken Wallace and Lucienne Blessing. Springer, ISBN: 978-1-84628-318-5 (Print: 3rd Edition), 978-1-84628-319-2 (Online)
- Patent Applied For; Title: Window; Owner: Inoutic / Thyssen Polymer GmbH / Germany, International No.: WO 2007/051441 A1; Int. Cl.: E05C9 / 18 (2006.01); Date of Publication: 23-06-2006
- Shavinina, Larisa V, (2003) The International Handbook on Innovation. Pergamon, Amsterdam. Hback, 1208 pp, ISBN 008044198X
- Zwicky F, (1976) Entdecken, Erfinden, Forschen im Morphologischen Weltbild. München-Zürich, Droemer-Knaur, 1976/1971

The Metaphor of an Ensemble: Design Creativity as Skill Integration

Newton S. D'souza
University of Missouri, USA

Abstract. The metaphor of an ensemble is used in this paper to understand and explain creativity in design. By analyzing skill integration at a domain and task level the paper proposes that from the viewpoint of creativity, design can then be considered as an ensemble of different skills, emergent from the specificity of the situation in which the designer operates. When design skills are considered as a composite, rather than as isolates, and are situated rather than absolute, they allow for flexibility in action and afford room for creativity, as different combinations of skills may lead to different creative design products.

Keywords: creativity, design skills, design process, skill integration, multiple skill model, architectural design

1 Creativity as an Ensemble of Design Skills

Current designers are immersed in a technology-intensive environment of social-networking, mobile communication, 3D-gaming and virtual reality worlds. While the effect of these tools has yet to be adequately evaluated in design, one issue that is increasingly becoming clear is that this new environment demands individuals to make meaningful connections between different tools. To make these connections however, one needs to pay attention to the underlying skills demanded by these different tools.

In this paper, the term 'skills' is used in reference to both cognitive constructions (mental representation and processes) and external depictions (physical action). For example, in the case of architectural designing, visualization is a skill consisting of mental representation while sketching on a paper or computer is an external depiction. In other words, the word 'skill' is used in a loose-fitting manner so as to render its meaning more inclusive to terms such as 'aptitude,' 'competency,' 'intelligence' or 'representation.' In a prior study it was recognized that architectural design as a discipline demands the use of multiple skills such as spatial visualization, logical thinking, kinesthetic skills, problem-solving skills, linguistic ability, reflective skills and interpersonal skills (D'souza, 2006; 2007). With this assumption, the challenge is to

find modes of translation between them in the hope that they lead to more creative products. The hypothesis of this paper is to consider design creativity as a meta-skill that involves the integration of multiple skills. An understanding of skill integration then will clarify the function of creativity in design. This paper attempts to understand skill integration at a domain level, as well as at a task level.

Furthering the debate of multiple skills in design, the assumption here is that designing requires a group of skills performing as an ensemble. The metaphor of an ensemble is useful in understanding creativity. Typically, a jazz ensemble consists of various components such as wind instruments (saxophones, trumpets, etc.), chordal instruments (electric guitar, piano, organ), bass instruments (electric bass guitar or double bass), and drums. Creative musicians find a way to integrate these various instruments in different models of improvisation. Most importantly, unlike other musical genres, a jazz ensemble is without a conductor, the improvisations occur through a spontaneous "call and varied response," a form of interaction between different musicians where one or a group of musicians take turns with the lead (Figure 1). In other words any instrument can have priority over the other and the music is situational rather than pre-determined. This alleviates any hierarchy within the instruments and allows for creative improvisation. Similarly, in architectural design, one can imply that creativity occurs when design skills can be modulated and integrated in spontaneous ways.



Fig. 1. Rendition of jazz ensemble by artist Scott Cumming

This metaphor of creativity demands that one cannot assign absolute value to skills in design, but that in different contexts, different skills may be more valuable than the other. When design skills are considered as a composite, rather than as isolates, and situated rather than absolute, they allow for flexibility in action and afford space for creativity, as different combinations of skills could lead to different design products. Design, from the viewpoint of creativity, can then be considered as an ensemble of different skills, emergent from the specificity of the situation in which the designer operates.

2 Integration as a Construct in Creativity Research

The dominant paradigm in traditional creativity research emerging from cognitive psychology attributes creativity as a divergent phenomenon rather than an integrative one. For example, the acclaimed Structure of Intellect model prescribed by Guilford proposes divergent production tests (Guilford, 1950). Torrance advanced Guilford's divergent model through the famous psychometric measure of creativity, the Torrance Test of Creative Thinking (TTCT), in which flexibility, originality and elaborated thoughts are emphasized rather than integrated (Torrance, 1974).

However, the fragmentary nature of design tools today, as well as the nature of design discipline, demands convergence or integration rather than divergence. Some views have alluded to this proposition. For example, Sternberg (1988) has observed that creativity will manifest itself in different forms, depending on the blend of characteristics one brings to creative performance attempts. In seeking to understand creativity, Sternberg observed that we need to understand the interactivity among its parts as well as their independent functioning.

Rothenberg (1979) has characterized homospatial thinking as the phenomenon where two or more discrete entities occupy the same space. In the same direction, Keep (1957) defines creativity as the intersection of two ideas for the first time, while Spearman (1931) has observed that creativity is present or occurs whenever the mind can see the relationship between two items in such a way as to generate a third item.

In their proposal of conceptual blending, Fauconnier and Turner (1998) observe that insights obtained from blends constitute the products of creative thinking. Individuals blend the function of a partial match between two sets of information and construct meaning out of it in a blended mental space.

The elements and vital relations from diverse scenarios are blended in a subconscious process, which is assumed to be ubiquitous to everyday thought.

3 Skill Integration as a Basis for Design Creativity

In architectural design, references to skill integration, are mostly confined to anecdotal references to architects' use of analogy and metaphors. As such, very few systematic studies can be cited. In a study conducted on creative architects, Mackinnon (1978) suggests that experts are more creative than the novices because a creative person, in his or her intellectual endeavors, is able to reconcile expert knowledge and childlike wonder. Similarly, in a study among architectural students and architects, Downing (1989) finds that unlike architectural students, architects are able to assimilate information more easily and hence are more creative.

Newland et al. (1987) found that the contemplative type of designer learns best by rising above apparent information into a unifying altruistic theory using metaphors to make sense of seemingly unrelated sets of information. For Bijl (1989), integration should be flexible because prior typing may become undone as new instances in the design process make unexpected demands. For example, a design idea cannot be fully determined at the beginning of the design process because the client may need something later or the context may pose difficult issues that force a change in strategy midway. For Jones (1970), the integration is a process of convergence, where the designer's aim becomes that of reducing secondary uncertainties progressively until one possible alternative is left.

In more recent attempts to model creativity, several design researchers have pointed out that blending, synthesizing and combining are key to creative thinking (Nagai and Taura, 2006; Gero and Maher, 1991; Goldschmidt, 2001; Finke et al, 1992). Yukari and Nagai have explored concept-synthesizing in terms of concept abstraction (similarity), concept-blending (similarity and dissimilarity) and concept integration (thematic relations). Among these, concept integration is shown to have highest effect on creativity. While in concept abstraction the similarity of two objects are critical for creativity to occur, in concept blending, it is not just about linking similarities of objects, but creating a new object that may be dissimilar to the original objects. In concept integration however, the creativity occurs at a thematic level, rather than at the literal level of objects.

4 The Multiple Skill Framework and Skill Integration in Design

As mentioned in section 1, architectural design is assumed to consist of multiple skills such as spatial visualization, logical thinking, kinesthetic skills, problem-solving skills, linguistic ability, reflective skills and interpersonal skills D'souza (2006, 2007). This multiple skill framework is borrowed from the educator and cognitive psychologist Howard Gardner (1983), who critiques the current educational system that focuses on logical and verbal skills only and failing to serve the academic and career needs of many students whose strengths lie outside these two skills. Note that Gardner uses the term 'intelligence' instead of the word 'skill' although they are semantically similar.

Gardner suggests that not only do individuals possess numerous mental representations and intellectual languages, but individuals also differ from one another in the forms of these representations, their relative strengths, the ways in which these representations can be changed. Gardner proposes at least eight discrete mental representations or skills concerning the ways in which individuals take in information, retain and manipulate that information, and demonstrate their understandings to themselves and others. The eight skills include verbal/linguistic, logical/mathematical, musical, spatial, bodily-kinesthetic, intrapersonal, interpersonal and naturalistic skills (Table 1).

Table 1. Multiple Skill Model of Gardner

Skill Type	Description
Linguistic/verbal	Use of words in creative ways
Musical/rhythmic	Appreciate/perform sounds
Logical/mathematical	Think in abstract relations
Spatial/visual	Manipulate/transform spatial information
Bodily-kinesthetic	Use of body to solve problems
Intrapersonal	Responsive to personal feelings
Interpersonal	Responsive to feelings of others
Naturalistic	Appreciate/manipulate nature

While Gardner suggests that each skill category is autonomous, i.e. consisting of its own attributes of memory and cognition, this paper assumes that in design, autonomy of skills is restrictive. This point has been made by a critique of Gardner's theory, Klein (1997), who demonstrated integration of skills among differing tasks. Taking an example of the task of parking a car, Klein suggests the use of logical skill is required to maneuver the car exactly in the parking lot. However, the task of car parking also requires a content area such as space to be worked. In the multiple intelligence model however, logical skills and spatial skills occupy different categories because of their autonomy, raising the question of how these two

skills could exchange information if they are so separated. This argument seems apt especially in architecture design which uses different intended acts such as logic, visualization, drawing, on one hand and intended objects such as form, space, graphics on the other. Hence while Gardner's multiple skill model is assumed here, it has been modified to accommodate multiple skills rather than considering the skills purely autonomous.

5 Analyzing Skill Integration in the Architectural Design Studio

The idea of studying skill integration came about as a by-product of a larger study of applying the multiple skill framework among architectural design students. These students were self-selected from an intermediate year design studio at a Midwestern school of architecture in the US. This paper will investigate the degree of integration in the use of different skills among designers. The study was conducted in two parts. The first part focused on skill integration at a domain level of design consisting of multiple skills among 37 architecture students. The second part focused on skill integration at a task level among a subset of nine students. The first part of the study is described in section 5.1 and the second part in the section 5.2.

5.1 Analyzing Skill Integration at a Domain Level in Design

To understand skill integration at a domain level first, skills in design were measured through a survey scale called Architecture Design Intelligence Assessment Scales (ADIAS), which is a personality-based self report administered through a paper-and-pencil questionnaire. The ADIAS uses a Likert-type measurement where participants are asked to indicate whether they agree or disagree with each item within a range of six options, and the scores for each scale are converted into percentage points. Scores within percentages of 100-60 are considered 'high,' 60-40 are considered 'moderate' and 40-0 are considered 'low'.

The ADIAS was constructed from the MIDAS scales, which were originally developed by Shearer (1996) to measure the multiple skill framework of Howard Gardner. The MIDAS (Multiple Intelligence Design Assessment Scales) is intended to give a reasonable estimate of the person's intellectual disposition in each of the eight main intelligence areas (linguistic, logical-mathematical, spatial, musical, kinesthetic, naturalist, interpersonal and intrapersonal). It has been subjected to several tests of validity and

reliability during the scale construction process. The ADIAS was constructed because it was felt that the MIDAS fell short in addressing domain specific skills that are particular to the uniqueness of architecture design. For example, in MIDAS items related to spatial skill include “Can you parallel park a car on the first try?” While this is a fair item to assess spatial skills for some domains, it may not entirely reflect the meaning of spatial skills in architecture where space can relate to sensory issues of light, texture, proportion and so on.

The transformation from MIDAS to ADIAS occurred through a four-phase scale construction process among 104 architecture design students. The ADIAS consists of 93 items for eight skill categories - 71 items from the original MIDAS scales and 22 new scales evolved during the scale-construction process. These new scales were formed by adding architecture-related content through design literature and qualitative interviews among design students. Validity was ensured by rejecting items with scores less than 50%, and reliability was ensured by deleting items with Cronbach alpha values greater than the alpha values for individual scales. It should be noted that in the ADIAS scale construction process, a new scale emerged called eye-mind-hand coordination scale. In the final version, the ADIAS mean scores for architecture students ranged from 74 for spatial to 59 for linguistics. All the skill scores were above or close to 60. Cronbach reliability for architecture students ranged from 0.9 for spatial skills to 0.77 for eye-mind-hand coordination scales (D'souza, 2006).

In order to understand the degree of skill integration, the Pearson's coefficient correlation between ADIAS scores were considered. This was to elicit the degree of skill integration. As shown in Figure 2, only correlations above + 0.5 are shown. For example, spatial, intrapersonal, interpersonal and logical skills had the highest integration while kinesthetic and musical skills were fairly autonomous. Darker shaded circles indicate greater degree of skill integration compared to the lighter shaded circles. Furthermore, the distance between the skills suggest the strength of skill integration. Skills such as intrapersonal, spatial and eye-hand-mind coordination skills bunched closer, compared to others. Spatial skill shows a strong correlation with eye-mind-hand coordination skill (R = 0.78) and intrapersonal skill (R = 0.74).

Another notable finding is the strong correlation between intrapersonal, interpersonal and verbal skills (intra to inter R= 0.69; intra to verbal R = 0.60; inter to verbal R=0.70), suggesting that sensory and communication skills are strongly integrated with each other in design. On the whole, the strong connections between these different skills suggests that these

faculties are very much dependent on each other, contrary to Gardner's hypothesis that the skills are relatively autonomous.

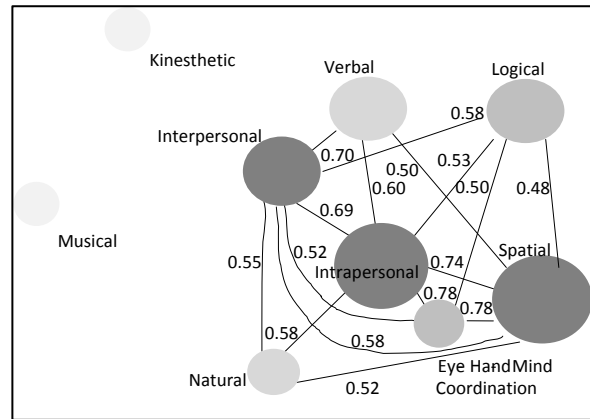

LOGICAL	0.48							
INTRAPERSONAL	0.74	0.53						
KINESTHETIC	0.16	0.35	0.04					
EYE-MIND-HAND COORDINATION	0.78	0.5	0.78	0.12				
NATURAL	0.52	0.19	0.58	0.11	0.42			
INTERPERSONAL	0.58	0.48	0.69	0.42	0.52	0.55		
MUSICAL	0.34	0.09	0.18	0.3	0.4	0.19	0.45	
VERBAL	0.5	0.39	0.6	0.37	0.44	0.35	0.7	0.39
	SPATIAL	LOGICAL	INTERPERSONAL	KINESTHETIC	EYE-MIND-HAND	NATURAL	INTRAPERSONAL	MUSICAL

Fig. 2. Degree of skill integration among multiple skills of architectural design students

As a further note, the size of the circles in the figure also shows the content validity of these skills to architectural design based on the scores attained in the ADIAS scales. As a subject of future analysis, this may help to understand the degree of skill integration in relation to the content validity of the scales.

5.2 Analyzing Skill Integration at a Task Level in Design

Understanding design skill at a domain level can only provide one part of the picture of creativity. To get a more complete picture, skill integration also needs to be investigated at the task level since, specific design problems demand specific combinations of skills. In the study, the design protocols of design tasks for nine students were examined in detail.

Currently, protocol studies are used only in experimental setups where a small number of participants are observed in a room and are expected to design a product in a short period of time (2- 4 hours). We found that this kind of protocol analysis may not be suitable to our study because the short duration not only diminishes the complexity and quality of

architectural design, but also fails to simulate the skills used in a naturalized setting of practice or an academic studio. The challenge was then to design protocols at a macroscopic level in the bargain of losing information at a microscopic level.

The nine students were distributed among six different sections of the architectural studio with different instructors and similar design problems. (Design task 1: row housing, design task 2: culture works museum and design task 3: branch library). Each protocol lasted for approximately one month, and data collection occurred at least twice a week in sessions lasting between 5-20 minutes. Verbal information was collected in the form of design intentions. To supplement the verbal information, design images were recorded using a digital camera wherever it seemed appropriate. These images were in different media and materials (e.g. tracing sheet, maplitho sheet, study models, etc.). The students were also asked to keep a log book so that informal sketches and information could be recorded throughout the design process.

Coding for all skills was done through a codebook which was devised by the researcher from referring to substantive data collected from the ADIAS as well as architectural design literature. Coding was done by three outside coders, who identified specific design intentions and matched them with appropriate skills. Table 2 shows an example of coding scheme for interpersonal skill. While the second column provides a brief descriptor for the main scale, the last two columns show the interpretation of the main scales into specific architectural design task scales.

The coding process is described in reference to Figure 3. The rows in the codebook show categories such as illustration, design intent and multiple skills. According to the coder, the intention '(5.1) 'Separate entry zones for private and public,' refers to the use of logical skill (because of an intention that is based on function and logical analysis). Hence, a tick mark is placed on the row corresponding to logical skills ('L'). The intention '(5.2) 'Separation of entries also created an open space at the center that could be used as a courtyard for the community,' refers to the use of spatial skill (because the designer is creating a spatial relation between open and closed elements), as well as interpersonal skill (because the intention shows a sensitivity to community). Hence two tick marks are placed, one for spatial skill (S) and another for interpersonal skill (I). These two tick marks are placed on the same column as the first intention but on the extreme right, because these two intentions are illustrated by the same drawing.

Table 2. Example of coding criteria for interpersonal skill

SKILL (Code)	General Description of Skill	Skill in relation to architecture design	
INTERPERSONAL (I)	To think about and understand another person. To have empathy and recognize distinctions among people and to appreciate their perspectives with sensitivity to their motives, moods and intentions. It involves interacting effectively with one or more people. Sensitivity to and understanding of other people's moods, feelings and point of view. Ability for influencing other people. Interest and skill for jobs involving working with people. Awareness of one's own ideas and abilities. Ability to achieve personal goals.	SENSITIVITY TO HUMAN BEHAVIOR	Intentions/drawings should convey the designer's ability to understand human behavior/ diverse values of design context. Ability to role-play and identify behavioral patterns.
		SENSITIVITY TO USER NEEDS	Designer should have social sensibility/empathy for variety of user groups/client scenarios, including underprivileged population. Intentions/drawings should show socio-cultural sensibility, and sensitivity to universal design issues.
		ABILITY TO BE SOCIALLY PERSUASIVE IN DESIGN	Designer should be socially persuasive in communication of intentions. Designer should be parsimonious/elegant in conveying ideas.



Illustrations			
Design Intents	1.1 Separate entry zones for private and public	1a Creating some rhythmic effect in the façade by staggering units on	1b
	1.2 Separation of entries also creates open spaces in the center which could be used as a courtyard		
Skills	Coding		
M			
L	✓	✓	
S		✓	
P			
I		✓	
V			
N		✓	

Fig. 3. Example of coding process

5.2.1 The Case of Laura and Jared

Two individual cases are elaborated here to further illustrate skill integration in design. Design student Laura likes to use different architectural strategies in her row-house scheme primarily through formal massing. Three strategies of formal massing are demonstrated here. As shown in Figure 4 (left) in the first case, Laura explores massing through a juxtaposition of different volumes. By using a set of wireframe diagrams, she explores architectural elements of proportion, hierarchy, geometry, etc. in the individual units of row-houses, as well as the row-house complex as a whole.

As she proceeds with the design process, she uses volumetric massing for an entirely different purpose, i.e., to explore and clarify functional zoning such as work space vs. residence conflicts, community vs.

privacy so on. As shown in Figure 4 (middle), Laura uses different colors (yellow and blue) to distinguish these conflicts. In the third case shown in Figure 4 (right), Laura uses volumetric massing for another purpose--purely an aesthetic basis to represent visual weight (heavy vs. light). Laura's design portrays primarily three design representations: spatial in the first case (spatial disposition of the volumes), logical in the second case (functional disposition of the volumes) and intrapersonal in the third case (sensory disposition of the volumes).

Illustrations									
									
Design Intents									
1. Trying to model spaces in 3D and schematics sections									
2. Functional zoning of different spaces showing alternatives in 3D massing									
3. Computer massing showing overlapping of light v/s dark spaces									
Design Intent	Skills								
	S	I	P	L	V	M	K	N	
1	✓			✓					
2	✓	✓		✓					
3	✓			✓					

Fig. 4. Skill integration through massing

Hence, in one design activity of volumetric massing, Laura uses different skills such as spatial skills, logical skills and intrapersonal skills. One should also note that these three ideas are not alternatives, but the continuation of the same idea. Laura's case indicates that thinking of design not only requires different skills, but also to making integration between one skill and the other.

Illustrations									
									
Design Intents									
1. Initial study of the courtyard space looking at orientation and geometry									
2. Radiating geometry of plan as layers									
Design Intent	Skills								
	S	I	P	L	V	M	K	N	
1	✓			✓					
2	✓			✓					

Fig. 5. Skill integration through multiple overlays

Similarly, design student Jared was able to think in multiple overlays (Figure 5) by using tracing sheets one below, allowing him to layer ideas and maneuver fluently through different elements of designing such as site, landscape, figure ground, built space, floor plan, etc. Jared used overlays to design parts of a scheme, without losing sight of the overall design. By doing so he was able to engage in analysis and integration simultaneously. As shown in Figure 5, of a

row housing scheme, Jared uses overlays of positive v/s negative spaces, landscape v/s built spaces and circulation v/s habitable spaces. Based on the GPA and instructor rating, this group of students was considered most successful and creative. Besides Laura and Jared, other creative students displayed some other traits as elaborated below. In all these examples, one can see an integration of skill at different levels.

5.2.1.1 Ability to use multiple skills

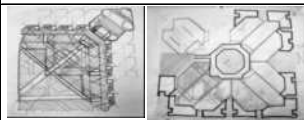
Illustrations									
									
Design Intents									
1. Gallery situated in direct access to main street									
2. Gallery located in corner not to disturb privacy of residents									
3. Community space situated in directed visual access to main street									
4. Massive exterior wall of row-house buffers the residents from the street and the light wells in the interiors help residents to open inwardly into the courtyards									
Design Intent	Skills								
	S	I	P	L	V	M	K	N	
1				✓					
2				✓					
3	✓			✓					
4	✓	✓	✓	✓			✓		

Fig. 6. Ability to use multiple skills

One of the aspects that distinguished this group of students from the rest is that they were able to utilize multiple skills - spatial, intrapersonal, interpersonal, logical, kinesthetic, verbal and naturalistic. In the example of a row house project (Figure 6), one can see the multiple skills for the intentions as coded in the table below in terms of spatial, intrapersonal, interpersonal, logical and kinesthetic skills.

5.2.1.2 Rigorous experimentation with alternatives

Illustrations									
									
Design Intents									
1. Exercise in 3D massing for creating and analyzing different alternatives									
Design Intent	Skills								
	S	I	P	L	V	M	K	N	
1		✓		✓					

Fig. 7. Identification and Application of diverse precedents

Another aspect that distinguished this group of students from others was their ability to produce multiple alternatives. As seen in the Figure 7 one can see an experimentation with different formal strategies for a row housing layout.

5.2.1.3 Verbal articulation of ideas and reflection

This group of designers was also more verbally articulate than others in their design ideas demonstrating good oral skills and or written skills.

Example in Figure 8 shows the designer interacting with the design problem of a row house design project by writing notes on how individual units negotiate the slope of the site, showing high level of verbal skills.

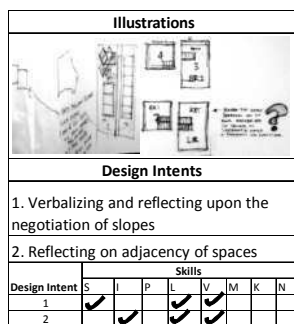

Fig. 8. Verbal articulation of ideas and reflection

5.2.1.4 Identification/application of diverse precedents

This group of designers also applied and identified diverse precedents in their design. In Figure 9 of a museum project, one can see use of different precedents for sectional organization.

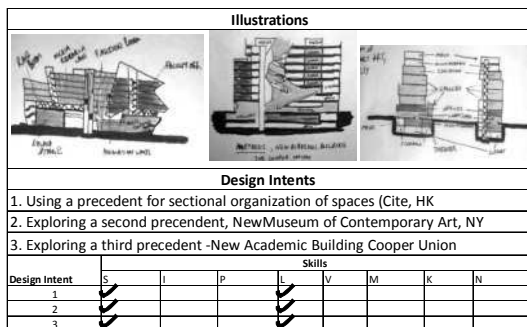

Fig. 9. Identification and application of diverse precedents

5.2.1.5 Changing strategies based on project needs

This group was cognizant of the changing nature of design problems across different projects and adapted their design strategies accordingly. The change in strategies for the three projects can be demonstrated in Figure 10. Reading from right to left, in the first

project of a row house, the designer uses a generative module and its formal logic for design (logical skill) in the second project of a museum she is influenced by her personal experience of a museum (intrapersonal/interpersonal skill) and in the third library project she uses an tree analogy as a form generator (naturalistic/intrapersonal skill) skill. This change in strategy demonstrates that the designer is cognizant of the changing nature of design problems across the three projects and adapts accordingly.

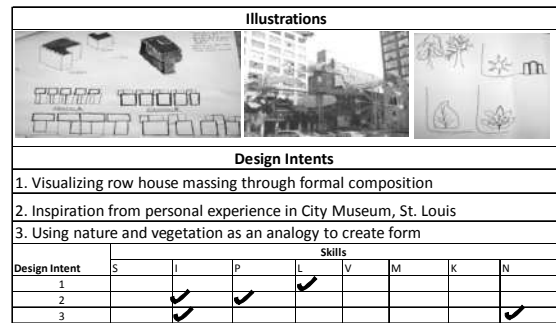

Fig. 10. Changing strategies according to project needs

5.2.1.6 Extensive use of analogies/metaphors

Most designers used high degree of analogies/metaphors. In Figure 11 the designer uses a 'sand-crab' and a 'flower' metaphor for the spatial organization of a row-house design project.

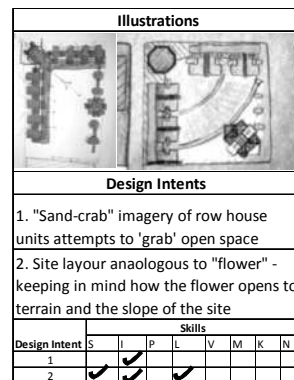

Fig. 11. Use of analogies/metaphors

6 Conclusions

In summary, the findings suggest that designers use multiple skills in their designs, and creative designers are able to perform skill integration much more effectively than others. The metaphor of the ensemble helps us to understand that it is not necessarily a specific skill or the number of skills the designer uses and integrates that makes a solution more creative.

Rather, how the skills are integrated in answer to a specific design problem is what forms a basis for creativity. The metaphor of the ensemble helps us view creativity can as a continuous 'creative performance' (Sternberg, 1988) rather than a onetime creative act.

The findings show that creative designers are cognizant of the changing nature of design contexts and are more deliberate in choosing specific skills and that creativity can occur at different levels in architectural design. As proposed by Klein (1997), the findings also show that integration can occur between within singular skills or multiple skills. In some ways it is the moment of insights when one can find, what Nagai and Taura (2006) characterize as 'thematic relations' between skills that can form the basis for creativity.

The findings imply that one cannot assign absolute value to skills in design, but that in different contexts, different skills may be more valuable than the others. When design skills are considered as a composite, rather than as isolates, and situated rather than absolute, they allow for flexibility in action and afford room for creativity, as different combinations of skills may lead to different design products. Design, from the viewpoint of creativity, can then be considered as an ensemble of different skills, emergent from the specificity of the situation in which the designer operates. This study has several limitations from the use of one single studio and an academic setting to the interpretive nature of the design process. However, it provides useful insights into the nature of skill integration as a basis for creativity at a domain and task level which may require further exploration.

References

- Alexander C, (1964) *Notes on the Synthesis of Form*. Cambridge: Harvard University Press
- Bijl A, (1989) *Computer Discipline and Design Practice: Shaping our Future*. Edinburgh: Edinburgh University Press, 67–69
- D'souza N, (2006) *Design Intelligences: A Case for Multiple Intelligence in Architectural Design*. Unpublished doctoral dissertation, University of Wisconsin-Milwaukee
- D'souza N, (2007) *Design Intelligences: A Case for Multiple Intelligence in Architectural Design*. *International Journal of Architectural Research, Archnet-IJAR* 1(2):15–34, MIT Press
- D'souza N, (2009) *Creativity as a Process of Skill Integration in Design*. Published in SIGCreativity Report, 17th International Conference on Engineering Design, ICED09, Stanford University
- D'souza N, (2009) *Revisiting a Vitruvian Preface: The Value of Multiple Skills in Contemporary Architectural Pedagogy*. *Architectural Research Quarterly*, Cambridge University Press 13: 173–182
- Downing F, (1989) *Image Banks: The Purpose, Function and Meaning of Environmental Imagery for Architectural Designers*. Unpublished doctoral dissertation, University of Wisconsin-Milwaukee
- Fauconnier G, Turner M, (1998) *Conceptual Integration Networks*. *Cognitive Science* 22(2):133–187
- Finke R, Ward T, Smith S, (1992) *Creative Cognition: Theory, Research and Applications*. Cambridge: The MIT Press, London: A Bradford Book
- Gardner H, (1983) *Frames of Mind: The Theory of Multiple Intelligences*. New York: Basic Books
- Gero JS, Maher ML, (1991) *Mutation and Analogy to Support Creativity in Computer-Aided Design*. In Schmitt GN, (Ed), *CAAD Futures*. Zurich: ETH, 241–249.
- Goldschmidt G, (2001) *Visual Analogy*. In Eastman C, McCaraken M, Newsletter W, (Eds), *Cognition in Design Education*. Elsevier, UK, 199–219
- Guilford JP, (1950) *Creativity*. *American Psychologist* 5:444–454
- Horn J, Cattell R, (1966) *Refinement and Test of the Theory of Fluid and Crystallized Intelligence*. *Journal of Educational Psychology* 57:35–78
- Jones JC, (1970) *Design Methods - Seeds of the Human Futures*. New York: Van Nostrand Reinhold
- Keep OA, (1957) *Discussant in The Arden House conference on motivating creative process*. Harriman: NY
- Klein P, (1997) *Multiplying the Problems of Intelligence by Eight: A Critique of Gardner's Theory*. *Canadian Journal of Education* 22:377–394
- Mackinnon D, (1978) *In Search of Human Effectiveness: Identifying and Developing Creativity*. New York: Creative Education Foundation
- Nagai Y, Taura T, (2006) *Formal Description of Conceptual Synthesizing Process for Creative Design*. *Proceedings of the Second International Conference on Design Computing and Cognition*, 443–460
- Newland PM, Powell JA, Creed C, (1987) *Understanding Architectural Designers' Selective Information Handling*. *Design Studies* 8(1):1–17
- Piaget J, (1955) *The Language and Thought of the Child*. Cleveland: Meridian Books
- Privateer PM, (1999) *Academic Technology and Future of Higher Education*. *The Journal of Higher Education* 70(1):60–79
- Rothenberg A, (1979) *The Emerging Goddess*. Chicago: University of Chiacago Press
- Shearer CB, (1996) *The MIDAS: A Professional Manual*. Kent, OH: MI Research and Consulting, Inc.
- Spearman C, (1931) *Creative Mind*. New York: Appleton.
- Sternberg RJ, (Ed.) (1988) *The Nature of Creativity*. Cambridge University Press
- Thomson G, (1951) *The Factorial Analysis of Human Ability*. Boston: Houghton Mifflin
- Torrance EP, (1974) *Torrance Tests of Creative Thinking: Norms Technical Manual*. Lexington, MA: Ginn
- Vernon P, (1979) *Intelligence: Heredity and Environment*. San Francisco: Freeman

Coaching the Cognitive Processes of Inventive Problem Solving with a Computer

Niccolò Becattini¹, Yuri Borgianni², Gaetano Cascini¹ and Federico Rotini²

¹ Politecnico di Milano, Italy

² University of Florence, Italy

Abstract. The paper presents a research aimed at developing a computer framework to support the analysis of inventive problems according to the logic of TRIZ (Theory of Inventive Problem Solving). The output of the dialogue-based procedure consists in a set of terms, viable to speed up a proper knowledge search within technical and scientific information sources. A dialogue-based architecture allows to support also users without any TRIZ background. The proposed system, although still at a prototype stage, has been tested with students at Politecnico di Milano and at the University of Florence. The paper outlines the structure of the algorithm and the results of the first validation activity.

Keywords: Problem Solving, Conceptual Design, OTSM-TRIZ, Computer-Aided Innovation, Dialogue-Based System

1 Introduction

“It is necessary to innovate to be competitive, it is necessary to enhance problem solving skills to develop valuable innovations”, is the common mantra both in the industrial world and in the product development research domain. According to the authors’ experience, among the methodologies supporting the solution of inventive problems, TRIZ (Theory of Inventive Problem Solving) has unique and precious characteristics to address these issues, despite its dissemination and development are too often based on practitioners’ initiatives, rather than collective and scientific discussions.

Several organizational and educational models have been proposed so far, as in Cascini et al. (2008), but several critical open issues still remain. “Simplified TRIZ”, too often intended as a fuzzy application of the contradiction matrix and the inventive principles, is closer to a brainstorming session with guided “stimuli” than to TRIZ problem solving process, and indeed its potential is limited. Thus, a conflict takes place between a proper assimilation of the TRIZ “way of thinking” and the time required to learn the theory and practice its tools. The conflict is even tougher for SMEs, since each

employee typically covers several roles, resulting in inadequate time and efforts dedicated to TRIZ learning. Several TRIZ-based software applications have been proposed in the market since the ‘90s, but these systems are not useful to speed up the learning process and they are marginally usable by people with no TRIZ background.

Within this context, the authors have started a research activity aimed at defining a new role for TRIZ-based computer applications, i.e. problem-solving “coaches” for non-trained users. According to the authors’ intention, a designer with no TRIZ background should be able to improve his problem solving capability, being guided by a computer application since the first usage of the software; at the same time the user should gradually acquire the ARIZ logic through a learn-by-doing process. The present paper starts with an analysis of the scientific literature relevant to the scopes of the present research (Section 2). The following section proposes the structure of an original dialogue-based system, founded on TRIZ logic and suitable for software implementation. Finally, the testing activity involving MS degree and PhD students is described and discussed to draw the conclusions about the achieved results (Sections 4-5).

2 Related Art

In literature there is a plenty of definitions of the term “invention”: among the others, for the scopes of the present paper, it is useful to mention the followings: (i) according to Patent Law a technical solution is inventive when it is useful, novel (no single prior art reference shows the identical development), and unobvious to a person “skilled in the art”; (ii) Cavallucci et al. (2009) associate the concept of invention to the transfer of knowledge between different fields of application. The first definition is here assumed as the reference to identify an invention, since it is more universally accepted, at least in the

industrial world; nevertheless, the second definition is relevant for a wide class of “inventive problems” and requires a specific solving approach.

As well, “difficult problems”, according to Funke and Fresch (2007), have at least one of four characteristics that make them hard to solve: intransparency, whereas some elements required to achieve the solution are not known due to the ill-definition of the problem itself; complexity, due to the great number of parameters of the technical system(s) and their mutual connections; dynamics, due to either time-dependent characteristics of relevant features, or to the need of achieving the solution under time pressure; politely, which means that the problem is characterized by multiple, non-compatible goals.

Technical problems can be also distinguished between inventive and non-inventive. Demands and cognitive processes make the differences in this distinction. According to the above mentioned definitions, non-inventive problems don’t require any inventive step, thus they are related to situations where the desired outcome can be achieved just by means of an optimal adjustment of system parameters. On the contrary, inventive problems are characterized by at least two conflicting requirements that cannot be satisfied by choosing the optimized values for system parameters.

The paper proposes a framework for Computer-Aided systems to face and consequently solve:

- difficult problems by both clarifying their definition and prioritizing the objectives;
- inventive problems by the search of conflicting requirements and the identification of features that the technical solution should have;
- non-typical problems by supplying the user with useful information from various domains.

2.1 Problem Solving Approaches

Technical systems are continuously expected to provide higher performances, reduced resources consumption and harmful side effects. These emerging demands typically bring to design conflicts. Whenever the optimization of the values of the conflicting design parameters allows to satisfy system demands within the established constraints, the solution does not require any inventive activity. Besides, when two or more requirements appear as non-mutually compatible just by adapting certain values of the design parameters, a paradigm shift is needed.

The creativity leaps underneath the inventive process have been deeply studied since the ‘70s both to understand human thinking and to provide an efficient way to improve the problem solving activity.

With a particular emphasis, Simon (1973) distinguishes between ill-structured and well-structured problems and observes that the problem solving approach should be the same, regardless of the problem structure. In a recent paper, Dorst (2006) calls into question the differences claimed by Simon between well-structured and ill-structured problems, highlighting that those differences mainly reside in the skills of the problem solver. Therefore, the designer’s subjectivity becomes relevant for the design process, since the greatest part of its creative contribute is spent in the redefinition of the problem in different terms. To this end, particular attention should be paid towards the designer’s interpretation of the problem, taking into account both his knowledge and his methodological approach. Moreover, it is worth to distinguish between cognitive and systematic features of the employed methods, in order to highlight their role within the design activity.

Cognitive approaches are focused on creative thinking features like analogy, abstraction and references to previous experiences by associations of ideas. Furthermore, they can be used regardless of the technical/industrial domain and the increase of their effectiveness must rely on multidisciplinary working teams composed by creative people. Some methods leverage tacit knowledge, stimulate “cross-fertilization” thinking processes and individual creative attitude upon appropriate conditioning techniques. Others rely on explicit knowledge such as information and data available in handbooks, patents and scientific papers. One of the greatest restrictions of these methods stands in their limited versatility, since they are hard to be generalized for different expertise domains. On the other hand, systematic approaches of problem solving are characterized by linear and “step-by-step” procedures that drive the design process, but usually cover a narrower solution space.

Despite many creative process models and techniques might be considered, as those reviewed by Howard et al. (2008), the discussion is here limited to the main differences and weak points of these two classes of methods.

Among the former, Brainstorming-like methods are characterized by a poorly efficient trial and error approach which requires a time consuming validation stage. Moreover, a brainstorming session intrinsically leverages only the knowledge of the individuals involved in the idea generation process. Besides, cognitive methods which rely on a computerized Knowledge Base, such as Case-Based Reasoning (CBR) have proved to be effective just on narrow domains. Among the methods based on systematic procedures for problem solving, Constraint Satisfaction Problem (CSP) techniques search suitable solutions for over-constrained problems when standard

optimization algorithms fail to identify any solution. Nevertheless, all the methods proposed so far, don't allow the introduction of new variables in the problem model, thus reducing the chance of inventive solutions. TRIZ is acknowledged as a methodology providing systematic means for problem solving. Its main tool is the so called ARIZ algorithm (Altshuller, 1999), a step-by-step procedure that brings from the analysis of two contradictory requirements to the synthesis of a new technical system, capable to overcome the underlying contradiction. Indeed, this method cannot be considered as completely systematic, since "ARIZ is a tool to aid thinking, but it cannot replace thought itself, if the human brain does not use the power of a lifetime's knowledge, a lot of potential associations and images would be neglected" (Khomenko et al. 2007). Both cognitive and systematic methods of problem solving have strong and weak points. Therefore it is important to combine the power of systematic approaches, in order to overcome through efficient processes the boundaries of personal creativity, with the capability of cognitive methods to leverage individual tacit knowledge.

2.2 Computer-Aided Systems for Problem Solving

The domain of Computer Aided Innovation (CAI) includes systems aimed at assisting Inventive Problem Solving by stimulating creativity and guiding towards suitable problem solving paths. In the last decade, Information Technology systems have substantially fostered a shared vision of creative patterns among different disciplines, resulting in a consistently growing interest in creativity concept. This led towards the birth of a novel and fertile field of research, namely the interplay between creativity stimulation and computer systems. Given the development of software systems that support human creativity, Lubart (2005) proposes a classification among the ways such aid is provided, ordered on the basis of the growing degree of machine involvement: *(i)* by facilitating the management of the working process, encouraging the perseverance of designer in the research of innovative solutions; *(ii)* by easing the communication between design team members, since circulation and integration of ideas play a relevant role in the creative process; *(iii)* by aiding the designer with a coaching activity, acting as an expert system that guides the user throughout cognitive processes; *(iv)* by cooperating in the creative process, thanks to the Artificial Intelligence systems that contribute to ideas generation.

It is beyond the objective of this manuscript to provide a state of the art of CAI tools; however, it is worth to notice that none of the existing software

systems implementing any of the above mentioned problem solving methodologies provides adequate means to overcome the abovementioned lacks and limitations. Among the others, TRIZ based tools fail to reproduce the richness of the theory and its abstraction capabilities and they consistently require an adequate TRIZ background to bring proper benefits.

3 Dialogue-based System to Support the Analysis of an Inventive Problem

The considerations reported in the previous section have been the basis for the selection of the theoretical pillars and models to build a Computer-Aided problem solving framework. This section briefly mentions these reference items and describes the structure of the original algorithm developed by the authors as the foundation for a problem solving application. Due to space limitations it is not possible to report the detailed algorithm constituted by more than 150 nodes related to possible interactions with the user. Nevertheless, the authors are available to share the prototype implementation with all the researchers interested in contributing to the development of the system.

3.1 System Requirements

As stated above, a specific goal of the present research is to allow even users without vocational experience to achieve viable conceptual solutions. Moreover, the recourse to time-consuming specialization courses has to be excluded, since this issue is extremely critical for the acceptance by SMEs. For the same reason, particular attention has to be paid towards the removal of TRIZ specific terminology. Thus the application has to embed TRIZ models, but the user interface has to be built through a common language, using terms and concepts introduced by the designer himself at the greatest extent.

Literature describes how much time the designer have to spend in order to gather useful information during the conceptual design stage. At the same time engineering designers, especially those with limited experience, are not always aware of the information they require and generally prefer to source knowledge and information through informal interactions with their colleagues. Besides, designers will rely more and more on information captured and stored independently of human memory. These reasons provide compelling evidence about the need to quickly and correctly formulate queries for the investigation of knowledge databases. With the aim of speeding up the search for valuable information, it is worth to focus the analysis of the encountered problem, so that the

main criticalities are individuated, as well as the most characterizing technical parameters, elements of the system, features. The tool therefore requires to guide the designer in an accurate and systematic examination of the problem to be faced, clarifying the scopes and the priorities in the solution search, especially in cases characterized by multiple tasks, complex situations and tangled interrelations among parameters, effects and physical phenomena.

3.2 OTSM-TRIZ Models as a Meta-cognition Framework for Inventive Problem Solving

As stated in section 2, it is necessary to reach a synthesis beyond the dichotomy between cognitive and systematic approaches to problem solving, in order to avoid trial and error, build efficient procedures, leverage the available knowledge resources of individuals and teams and highlight knowledge lacks to be covered with new information sources.

According to the authors’ experience, OTSM-TRIZ (Cavallucci and Khomenko, 2007) provides a comprehensive and organic suite of models describing the classical TRIZ problem solving process through the explicit integration of cognitive elements. These models, namely Hill model (abstraction-synthesis); Tongs model (from current situation to ideality, barriers identification); Funnel model (convergent process); System Operator (system thinking); should not be considered as alternative paths for transforming a problematic situation into a solution, but as complementary descriptions of the characteristics of an efficient problem solving process.

Within the methods supporting conceptual design with an intensive human involvement, which are currently deemed to be more reliable, a dialogue-based system is suitable to embody the selected reference models. Through a dialogue-based system undertaking the abstraction process, a systematic succession of questions is viable to support the investigation of the problem according to the TRIZ logic.

3.3 Description of the Algorithm

The original contribution of this paper is constituted by an algorithm, for problem analysis and solving, structured in the form of a dynamic dialogue, suitable for implementation in a software application. The underpinning logic of OTSM-TRIZ and several classical TRIZ tools are integrated in order to widely describe the topic of the investigation and to remark the most relevant issues to be considered for the problem solving activity and, if necessary, for the knowledge search. The dialogue based system helps at first the user in exploiting his know how by suggesting

problem solving paths that don’t require external expertise to be implemented. Thanks to the investigation of the parameters affecting the undesired issues arising in the system, the designer individuates factors to be modified in order to reformulate the problem as a typical case. Moreover, the algorithm provides indications for suitable problem solving alternatives, by means of different TRIZ tools, e.g. separating in time/space, trimming low-valued components, opportunities to turn the undesired effect into a useful output, re-thinking the ways to perform the main function or to deliver the same benefits.

In order to fulfil the requirements and to cover all the options for problem solving and knowledge search, the framework of the algorithm includes a set of complementary logical blocks: the network of links among the blocks and the single nodes of the algorithm determine an extensive bundle of paths and cycles to refine the problem formulation (Fig. 1). The following measures have been taken: (i) the nodes of the algorithm are either open questions, choices or messages intended to provide proper hints in performing the problem solving process; (ii) questions and suggestions resort to previously introduced terms and items; exemplary answers are supplied, in order to clarify the purpose of the open questions; (iii) the questioning procedure is rich of checks in order to verify the correctness of the user’s inputs and to provide him a feedback about the ongoing process.

With the objective of addressing the user towards the most proper problem description, the algorithm performs a preliminary distinction among tasks concerning the elimination of drawbacks, the implementation of new useful functions and the enhancement of systems with under-performances.

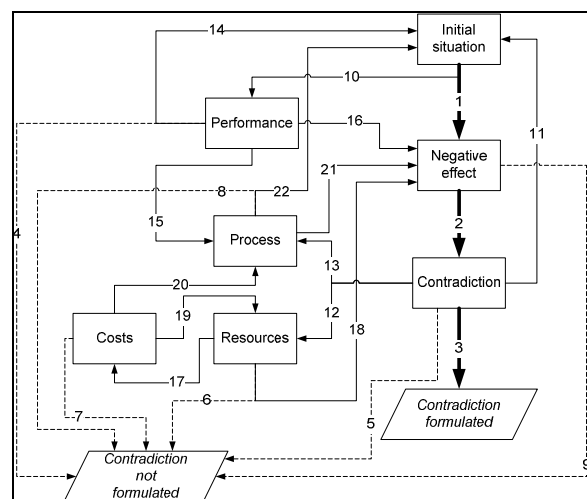

Fig. 1. Network of logical blocks and outputs of the questioning procedure

The individuation of an undesired effect leads to the investigation of the features and the phenomena that provoke it and, subsequently, to their abstraction (Hill model) through the formalization of a physical contradiction, grounded on a control parameter and the mismatching outputs depending on the value it assumes. The most straightforward path for formulating the contradiction, highlighted in Fig. 1 with thicker lines, involves the accomplishment of three logical blocks, intended to assess the initial situation (labelled as IS), to define the arising undesired effect (NE) and to identify the conflicting requirements (AR).

However, further ways are foreseen to depict the problem, since several matters can hinder a thorough description of the system under investigation. In case of any circumstance impeding the definition of a contradiction, the algorithm is designed to investigate a wide set of features viable to constitute the core of elements and terms to suggest solution paths or to be sought in proper knowledge bases. The designer is then guided to analyze the circumstances that determine missing functions or cause under-performances (PE), to pinpoint the resources needed by the system to work correctly (RE), to focus on the reasons that imply high costs (CO), to investigate further problems arising during the manufacturing of products or the delivering of services (PR). Eventually, the absence of a contradiction is due to any of the followings (highlighted in Fig. 1 with dotted lines):

- the user hasn't seized any possibility to modify the studied system and the phenomena that provoke certain underperformances (line 4);
- the attempts to identify a parameter entailing conflicting requirements have failed (line 5);
- the user hasn't succeeded to individuate a proper characterization of the undesired effect in terms of required resources (line 6), high costs (line 7) or problems having reference to any stage of the system lifecycle, whose features are influenced by the design and manufacturing/delivering process (line 8);
- certain criticalities are not considered worth to be further analyzed (line 9).

3.3.1 The logical block Initial Situation (IS block)

The block is aimed at defining, at first, the technical system to be analyzed, its overall goal and the main function it performs. The beneficiary of the system and the object subjected to the main function of the system are identified. The designer is then asked to characterize the technical device under investigation following the hierarchical logic of the System Operator and thus delineating the most relevant operative conditions to perform the function. The user,

in order to thoroughly describe the initial situation, is required to delimitate the operative space and time involved when the function is delivered. If the designer acknowledges missing functions or relevant under-performances, he is addressed towards the block Performance (line 10), otherwise he is redirected to the block Negative Effect (line 1).

3.3.2 The logical block Negative Effect (NE block)

The block aims at investigating the undesired effect that arises in the system, as well as its negative consequences. The user is required to indicate which element causes the appearance of the negative effect, the operative space and time of such harmful function, alike in ARIZ steps 2.1 and 2.2. A further check is carried out in order to verify whether the removal of the element, responsible for the undesired effect, implies any negative consequence. The accomplishment of the NE block leads the user towards the set of questions that check the existence of contradiction (AR block, line 2).

3.3.3 The logical block Contradiction (AR block)

The block is supposed to identify a TRIZ physical contradiction according to the logic of the Tongs model. The user is requested to focus on the parameters, concerning the previously identified element, that influence the extent of the negative effect. The consequences of modifying the parameters, i.e. reducing the impact of the negative effect, are evaluated up to revealing the decrease of a desired output. The positive effect which is impaired by a modification of the chosen parameter, as well as its operative time and space, are then identified along the logical block. The mismatching behaviours, faced as a result of increasing/decreasing the chosen control parameter, constitute the core formulation of the physical contradiction. The cognitive process holds therefore the purpose, as in ARIZ step 3.1, to individuate the opportunities of introducing an X-element, capable of removing the negative effect and providing benefits at the maximum extent, as figured out by the Ideal Final Result. If any parameter is individuated, whose variation provides benefits with no drawback, the procedure suggests to perform such modification and to reformulate the problem, thus restarting from the IS block (line 11). If it is not possible to identify a control parameter leading to the physical contradiction, the algorithm guides the user through the RE (line 12) or PR (line 13) blocks for a further characterization of the undesired effect.

3.3.4 The logical block Performance (PE block)

The block Performance is addressed to reformulate the system under investigation or the undesired effect. It is

accessed whenever the user recognizes any kind of under-performance of the system or the need for introducing a new function. First, it is required to define a performance to be enhanced or satisfied by the implementation of the new function and to explain the motivations for the increase of the performance itself. The user is then asked to individuate who or what would perceive the benefits of the improvements, who or what doesn't allow the enhancements in the current technical system. If any of the previously identified items is viable to be modified, specific directions are suggested to the user and he is directed back to the IS block (line 14). Besides, emerging requests of modifications of the production process are directed towards the PR block (line 15). Other situations bring to formulate the negative effect of the system in terms of an unsatisfactory performance and consequently to follow the NE block (line 16).

3.3.5 The logical block Resources (RE block)

The excessive amount of resources spent by a technical system is typically considered just as an administrative drawback due to the fulfilment of requirements. This logical block investigates the resources needed by the system, classifying them in terms of space, time, information, material and energy. When the designer judges the direct costs as the most critical resource spent during the system lifecycle, the algorithm guides him towards the CO block (line 17) for analyzing the reasons of the high expenditures. Among the amounts of resources spent, the user is asked to determine those representing the most challenging criticalities and whether this issue can be assumed as the negative effect to be targeted (NE block, line 18).

3.3.6 The logical block Costs (CO block)

In TRIZ terms costs reduction must be addressed by leveraging the internal resources of the system. The logical block is aimed at classifying what provokes high costs for the system use, production or maintenance. The resources responsible of the high costs are clustered with the same criteria of the RE block. The questioning procedure directs the designer towards the RE block (line 19) if the costs concern the user of the system, whilst it guides towards the PR block (line 20) if the expenditures characterize the production process.

3.3.7 The logical block Process (PR block)

This block investigates criticalities about the production process. The scope of the PR block is to reformulate the negative effect and the element that provokes it (line 21), downstream the individuation of the critical issues concerning the production of the

system. Since the focus of the investigation could be moved from the product to the design, manufacturing and assembling phases, the questions let the user change even the system to be analyzed (line 22).

4 Testing Activity and Discussion

The present section first describes the organization of the testing campaign set up to validate the proposed algorithm, implemented as a web application. Then, the results of the experimental activity are discussed in terms of efficiency, estimating the effectiveness of the system through a comparison of the outputs with previous experiences and its robustness, by evaluating the repeatability of the outcomes.

4.1 Test Group and Test Cases

The proposed dialogue-based algorithm has been tested by 30 Master Degree students in Mechanical Engineering at University of Florence and at Politecnico di Milano. All these students had received 20 lecture hours about TRIZ fundamentals, with different proficiency results. Further tests have been carried out by 4 PhD students and a postdoctoral research fellow in Mechanical Engineering with no TRIZ background, in order to appreciate differences and similarities according to different level of competences. The tests were run in laboratories where each person, in at most 90 minutes, had to analyze one of three real industrial problems (A, B, C) chosen for their different characteristics, in order to evaluate the capability of the algorithm in driving the user towards the logical blocks, which was considered the most proper for each case study. Although each problem structure depends on the user interpretation, the most accurate problem model would imply the identification of an appropriate physical contradiction; besides, it is expected that at least people should model case A as a resources reduction problem, case B as a negative effect and case C as the implementation of a new performance or the improvement of an existing one. Case A has been faced by 11 students and 2 PhD students; Case B was tested by 13 students and 1 PhD student; finally Case C was examined by 6 students, 1 PhD Student and 1 post-doctoral research fellow.

4.2 Overview of the Results and Discussion

The results of the problem situation analysis have been evaluated according to the following metrics:

- a good result is characterized by a precise description of the problem, as well as by an

- appropriate set of features and elements, viable to lead to a suitable information retrieval;
- a satisfactory result is characterized by a global representation of the problem under investigation, with an almost complete description of its main characteristics; the available information about the problem gives preliminary criteria for information gathering;
 - an unsatisfactory result relates to a poor description of the problem, rich of misinterpretations and with no useful information capable to enlarge the potential solution space.

Fig. 2 provides an overall outlook of the results achieved by the Master Degree Students from both the Universities; PhD students were considered separately.



Fig. 2. Results of the application of the algorithm at Politecnico di Milano and University of Florence.

In the assigned time, more than 60% of the Master Degree Students were driven towards one of the final nodes of the algorithm, as well as 23 out of 30 (76,6 %) gave at least a satisfactory description of the problem situation (Fig. 2, continuous line). However, just a small part of them (13,3% of the grand total) formulated a complete model of contradiction.

A comparison between the Master Degree students from both the academic institutions does not highlight noticeable differences, since 75% of them obtained positive results (approximately 80% in Florence and 70% in Milan), while students from Politecnico di Milano totally got better quality results (good 54%; satisfactory, 18%) than their mates from University of Florence (good 37%; satisfactory 42%). The students who properly formulated a contradiction through the dialogue-based system achieved the best results in terms of abstraction according to the Hill Model: they got to the description of a physical contradiction and also identified the main characteristics that the solution should have in order to solve the problem. Consistently with the problem solving models proposed in section 3.2 the algorithm has proved to be successful in stimulating the user in refining the problem under investigation, allowing to focus on different hierarchical levels of the system, thus moving

upwards or downwards in the System Operator (more than 50% of the students have modified their initial definition of “system”).

The convergent problem solving process described by the Funnel Model emerges by analyzing the body of results produced within this testing activity: the students frequently converged towards the same problem model, even if in many cases, this hasn’t resulted sufficient for formulating an appropriate contradiction.

By thoroughly investigating the procedures carried out by the students that obtained good results, it emerged that many of them achieved great benefits by changing the definition of the “technical system”: they progressively changed the scope of the problem by identifying the right detail level and the critical features to be improved or to be removed. It is noticeable that all these students, regardless of the test case under analysis, considered the problem related to unsatisfactory performances of the technical system. The iteration of the procedure gave them a different perspective of the whole problem and by means of problem reformulation one third of them identified a critical contradiction for the problem solution. Besides, the students of this group that didn’t get to the definition of a contradiction leveraged their knowledge building an appropriate description viable for a profitable information retrieval. Most of these students (about 85%) came indeed to one of the final nodes of the procedure with positive conclusions.

On the other hand, the students that didn’t succeed in obtaining valuable results often followed an odd logic since they experienced some difficulties in distinguishing between elements/components of the system and their parameters. About half of them tried to force the procedure towards the direction of a solution they had intuitively elaborated, rather than using the dialogue based system as a guiding tool to gradually explore the characteristics of the problem under investigation. Differently from their colleagues who obtained positive result, 57% of these students didn’t get to the end of the procedure, without taking therefore advantages from the refinement of the definition of the system.

It is equally important to verify whether the goal of approaching the problem with the right branch of the procedure has been met or not. By considering the sequence of steps that all the students went through, a simple analysis of Pearson’s correlation remarked that the students, regardless their success in exploiting the procedure, followed very similar paths of analysis.

About the potential differences in the solving path followed by more specialized people, the group formed by the PhD students and the postdoctoral research fellow produced only good or satisfactory results. In three cases they got to a good formulation of

a contradiction, thus abstracting the problem and identifying the main features of the solution. In the remaining two cases the description of the problem was just satisfactory, but useful to perform a relevant information search.

The same test group of MS students has been involved also in manual tests without any computer support, but with the possibility to access their own books and the slides of the 20 hours course they had attended. The same assignments mentioned in section 4.1 have been submitted, even if with a different order.

By comparing the overall outcomes of the manual tests with those obtained through the proposed dialogue based system, the share of students showing negative results drops from roughly 35% to about 27%. However, an in-depth analysis of the results highlights that students that had valuably employed problem solving methods or tools by themselves (approximately 46% of the grand total) didn't obtain particular benefits in approaching the situation by means of the dialogue-based system. On the contrary, the greatest benefits of the procedure emerge with those students that had previously showed more limited skills in the employment of systematic problem solving techniques. In fact, more than two thirds of them described the problem in a more appropriate way than they had been capable without computer support.

5 Conclusions and Future Activities

The present paper proposes a model for computer-aided systematic problem solving, which has been adopted as a reference for the development of an original algorithm aimed at guiding designers, even without any TRIZ background, in the generation of inventive conceptual solutions. The algorithm has been implemented in a prototype web application already tested with MS and PhD students, obtaining positive results especially with the students with poorer systematic problem solving skills.

The tests performed so far have demonstrated that the proposed system is suitable to combine several expected benefits of the most acknowledged problem solving techniques. First, cognitive capabilities are enhanced by soliciting the analysis of the problem from different perspectives, thus overcoming psychological inertia as typically addressed by TRIZ System Operator. Indeed, while the overall results of the test have been satisfactory, the proposed algorithm needs to be improved in terms of supporting the identification of a proper model of contradiction.

The system is also structured in order to elicit lacks of knowledge by the user, either in terms of limited understanding of the mechanism originating the

problem, or missing physical/chemical effects suitable to deliver a certain function. Such knowledge lacks will be used as inputs for a patent-mining tool capable to extract relevant information from patent texts within or even outside the problem domain. The complete system will be tested within a project of the EraSME EU Programme, by involving a number of Small and Medium Enterprises from Italy and Spain.

Acknowledgements

This research is partially funded by the EraSME EU Programme. Special thanks are also dedicated to Nikolai Khomenko for the valuable suggestions at the beginning of this research.

References

- Altshuller GS, (1999) *The Innovation Algorithm: TRIZ, Systematic Innovation and Technical Creativity*. Technical Innovation Center Inc., Worcester
- Cascini G, Jantschgi J, Khomenko N, Murashkovska I, Sokol A, Tomasi F, (2008) TETRIS: Teaching TRIZ at School - Meeting the educational requirements of heterogeneous curricula. *Proceedings of the 8th ETRIA TRIZ Future Conference*, Twente, The Netherlands, November 5-7, 123-130
- Cavallucci D, Khomenko N, (2007) From TRIZ to OTSM-TRIZ: addressing complexity challenges in inventive design. *International Journal of Product Development* 4:4-21
- Cavallucci D, Rousselot F, Zanni C, (2009) Assisting R&D activities through definition of problem mapping. *CIRP Journal of Manufacturing Science and Technology* 1:31-136
- Dorst CH, (2006) Design Problems and Design Paradoxes. *Design issues* 22:4-17
- Funke J, Frensch PA, (2007) Complex problem solving: The European Perspective. In: DH Jonassen Ed., *Learning to solve complex scientific problems*, Lawrence Erlbaum, New York, 25-47
- Howard TJ, Culley SJ, Dekoninck E, (2008) Describing the creative design process by the integration of engineering design and cognitive psychology literature. *Design Studies* 29:160-180
- Khomenko N, De Guio R, Lelait L, Kaikov I, (2007) A Framework for OTSM-TRIZ Based Computer Support to be used in Complex Problem Management. *International Journal of Computer Application in Technology* 30:88-104
- Lubart T, (2005) How can computers be partners in the creative process: Classification and commentary on the Special Issue. *International Journal of Human-Computer Studies* 63:365-369
- Simon HA, (1973) The structure of ill-structured problems. *Artificial Intelligence* 4:181-201

Creative Engineering Design Aspects given in a Creativity Training Course

Joaquim Lloveras¹, Miguel-Angel Saiz¹, Carlos García-Delgado², Jairo Chaur³, Lluís Claudi⁴, Anna Barlocchi⁵, Laura Carnicero⁶

¹ Technical University of Catalonia (UPC), Spain

² Freelance Architect, Spain

³ Iale Tecnología, Spain

⁴ Freelance IQS, Spain

⁵ ZMB Patents, Spain

⁶ Centro Técnico SEAT (PS-1), Spain

Abstract. In the development of the conceptual engineering design phase, it is essential to raise new ideas of solutions. The postgraduate creativity course named: "Creative formation in the innovation of products or services" given at: "Fundació UPC" of Technical University of Catalonia (UPC) in Barcelona, helps the students to increase their competence to raise and manage the creativity. The course has two main modules; the first gives a general view of creativity training while the second aims to apply this creativity in a company and understand the innovation processes. Generally speaking the course is mainly addressed to engineers and technicians with some R+D+I responsibilities for conceptual product design in a company. This paper shows the course experience and its evolution, and also addresses some creativity techniques that are grouped by similar aspects of mental processes involved. These aspects are ordered by the degree of conscience to unconscious mind.

Keywords: creativity-training course, mental processes, conceptual design, technological watch

1 Introduction

New ideas are needed to initiate a process of innovation, which also need a large amount of different factors and efforts oriented to reach an innovated product. In the current world a developed country bases its competitiveness on the innovations of products or services.

However, in most countries the development of the creative faculty of a person is not foreseen in the current educational system. Study is mostly based in memory training and some systems are out of experimentation. Generally speaking, childhood is a great period for creativity, but later a person loses this aptitude by several causes, the education among them.

The result is that poor abilities in the creative mental faculties are attained.

The aim of this creativity-training course, for postgraduate students, is to recover and to enhance the student's creative faculty.

The spark of a good idea is the "Holy Grail" that companies search for to reach a significant innovation allowing them to dominate the market and obtain profits, and the results is normally an increase of the social wealth and comfort. This main objective is sometimes more modest, and small innovations allow the survival of the company, and even to earn profits.

The production of ideas and the quality of such ideas in an innovative company is the real interest of this creativity-training course, but other cases are also admitted. The evolution of the students of this course has been from mainly engineering students at the beginning to varied professionals of different disciplines nowadays, because of the transversal or multidisciplinary content of the course.

2 Creativity-training Course Modules

The course is given each year from 1996-97 academic course until now and was called initially: "Creative Phase in the Innovation of Product or Service". From 1999-00, that was introduced new matters and was called: "Creative Formation in the Product and Service Innovation" (Lloveras et Al., 2004).

The new course proposal will be named: "Creative formation of product or service innovation in a company". It is a postgraduate program of "Fundació UPC" of Technical University of Catalonia (UPC) in Barcelona. This new course is adapted to Bologna European process, is based in European Credit Transfer System (ECTS), and is planned to start in

2010-11 or 2011-12 academic course. Will have 15 credits ECTS, that is about 90 hours in-classroom given in 25 days between January and end of June, and about 285 hours of student work, that makes a total of 375 hours of student dedication.

The general goal of this postgraduate program is that the student come out prepared to be a quality-creative person in their individual work or in teamwork, and they know how to apply this creativity to the innovation in a company.

The new course structure (Figure 1) has two main modules: A) Methods and techniques of creativity, and B) Creativity and innovation inside companies. Each module has four subjects (S1A to S4A, and S1B to S4B); the names and the contents of matter are briefly explained below.

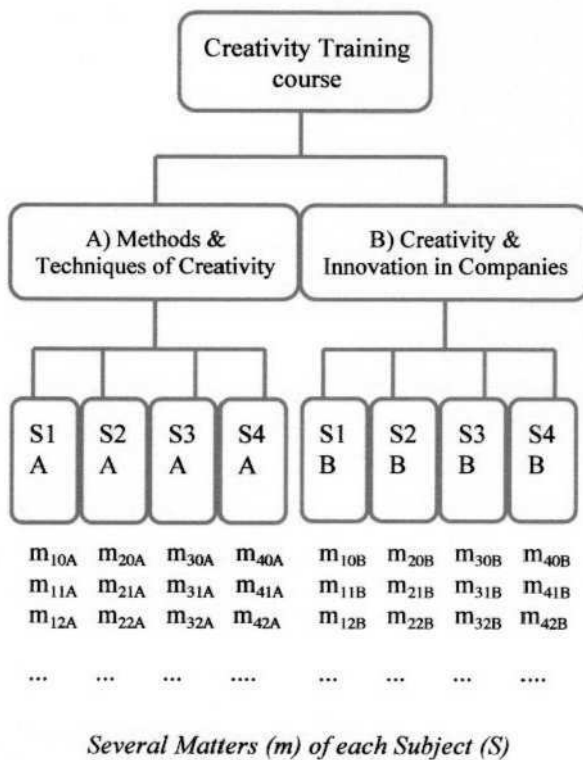

Fig. 1. Scheme of creativity course structure

2.1 Methods and Techniques of Creativity (Module A)

This module is for creativity training and to do that several methods and techniques of creativity and some conceptual design processes are treated in order to achieve an adequate knowledge’s, abilities and attitudes.

The four subjects (S1A to S4A) of this module are:

- conceptual design process;
- creativity techniques;
- software of creativity;
- invention theory;

The subject of conceptual design process treats of the “elastic” structure that characterise this first phase of design, and it emphasizes in ample objectives (see section 3.3) and introduces the creativity techniques that are used in this phase of conceptual design.

In the creativity techniques subject, are teaches and practiced the betters of these techniques. Some of them are practiced in the subject: Software of Creativity, with several software programs (Chaur, 2005).

The subject: Invention Theory, explains the real paradigms of occidental culture, their positive and negative characteristics for science and creativity. Also shows the relationship between: memory, subconscious and rational thought, especially in the creative act.

Each of these subjects have several matters (see figure 1), and these matters are rearranged in section 3 by mental processes for creativity. From point of view of conscious or rational, to unconcious mind or subconscious.

Also one exercise of general concepts revision it is performed in this module by Exchange of Mental Schemes (EMS) method (see section 2.3).

2.2 Creativity and Innovation Inside Companies (Module B)

This module has two main objectives. The first one is to show the existing relation between creativity and innovation. The second one is to teach different ways of improving the use of creativity inside of companies.

Different methods and aspects are took into account to achieve the first objective: exposition of theories relating competitive advantage with innovation and creativity, the exposition of examples of innovations; lectures, analysis and discussions of biographies of inventors, scientists and creative people, extracting of all of them the main features related with creativity, as e.g. its own inventor, its relation with the team, the complementarily between the members team, the importance of transmitting ideas to other people, the organizational settings, the quantity of spent efforts, the paper of different aspects as the chance, the play, the observation, the pleasure, the intuition, the unconsciousness, the way of overcoming the obstacles and so on.

Other type of methods and aspects are related with the second objective: the main paper of the strategy, the organization, the devoted resources inside the

company; the importance of a clear definition of the objectives of the company in short, medium and long term; the facilities of giving ideas inside the companies, the use of divergent methods in a early phase of new product developments, the network organization inside (between all departments) and outside the company (with universities, technological centers, suppliers,...), the employ of methods of creativity as brainstorming, TRIZ, ..., and different combination of them, the importance of aborting the critical aspects respect ideas till to be more clear, the use of innovation teams or creative teams inside companies as promoters teams of innovation, the employ of creative courses inside companies,...

All the treated aspects of both objectives are exposed with the aim of real experiences inside companies. These two objectives are not only worked by the students in classes but also by mean of different activities made by home works as, e.g., lectures, reflections, observations of their diary settings (house, work, friends...), search of innovative proposals and realization of prototypes for solving the proposed problems.

This module is devoted to application of precedent module of general creativity inside companies. The titles of four subjects (S1B to S4B) are:

- inventions and patent system;
- technological watch and competitive intelligence;
- creativity and innovation in the company practice;
- thinking engineering;

Also in this module there is an exercise of EMS (II). Next is the explanation of these subjects:

2.2.1 *Inventions and the patent system*

This part of course is dedicated to Intellectual Property (IP), and in particular to patents, as a complement to the generation of ideas; certain knowledge of the patent system is necessary to protect the results of the creative process and prevent third parties from copying the technical ideas.

Indeed any person who works in research and innovation needs to be familiar with at least some aspects of the patent system for different reasons, such as:

- patent databases are an enormous source of technical knowledge that is not found elsewhere, and for inventors, patents are a reference for comparing their own inventive production, and can also be a source of inspiration for new technical ideas; furthermore some ideas and solutions proposed

in expired or abandoned patents are free to be employed;

- a good knowledge of the state of the art, including patents, is essential to avoid wasting time investigating something that is already known, or investing in fields of technology that may be blocked by one or several patents;
- when considering a potential commercial or industrial activity, one must assess the risk of infringing third parties' IP rights;
- patents are assets which can be sold or licensed, and can therefore be employed to obtain benefits from the creative process.

All these reasons show the interest of IP knowledge and the close relation with this course. It must also be pointed out that in our country the patent system is not yet widely known amongst innovators in university and industry, so it is important to spread the information and raise awareness about the patent system, its usefulness and also its pitfalls.

The main topics are:

- IP rights and their main aspects: copyright, trademarks, designs, patents, know-how;
- patents and utility models: concept, rights they confer, basic outline of patent prosecution, assignments and licenses;
- patentability: novelty, inventive step and industrial application;
- structure of a patent specification: patent claims and their importance;
- patent infringement;
- patenting strategies: what, where, when, how to; managing a patent portfolio;
- practices of searches in patent databases.

2.2.2 *Technological watch and competitive intelligence*

Some principles of technology watch based on patent and other scientific publications, from which it is possible to construct the state-of-art of a specific technology are explained and also practiced through Internet.

Technology Watch (TW) refers to the dynamic process of monitoring and strategic analysis of scientific and technological advances and the competitive, trade, environmental and regulatory aspects. It aims to improve the decision making processes in organizations, reducing the uncertainty detected in markets and identifying new opportunities for R & D. Its results are also used within the strategic decision-making process of various areas within organizations. TW activities require tools that are capable of fulfilling the need for valuable information,

in a time-sensitive fashion and at the lowest possible cost. Valuable information can only be obtained through the implementation of an entire intelligence cycle, which begins with planning, continues with the selection of information sources, information analysis, dissemination, utilization within the decision-making processes, and ends with its valuation through the undertaking of both strategic and technical actions.

During the practices, the students seeking patent and scientific articles related to any specific topic that they choose, in order to indicate the sources of information in the “hidden web” and to extract bibliographic data (data mining). From these data it is possible to make different types of analysis.

Then, when the documentation generated by technology watch is significant and technological trends are known, is possible to analyze this information with company potentials and finally to show an interesting direction of future for a company (competitive intelligence).

2.2.3 Creativity and innovation in the company practice

This subjects starts with the explanation of basic concepts and processes of creativity and innovation from company point of view.

The main topics are:

- innovation, marked and company;
- individual creativity;
- creative model;
- how to potentiate the creativity in professional ambiance;
- examples of application in professional ambiance.

2.3 Exercise of Exchange of Mental Schemes (EMS)

The Exercise of Exchange of Mental Schemes (EMS) (Carnicero, 2007) is common in both modules of the course, and consists in the discussion of concepts learned in the module. This discussion is initially incentivated by lecturer that gives some guidelines and is performed only by students in team group without lecturer presence. This process between equals gives more freedom to ask between them, and the result is the elimination of bad understood topics, that is, the elimination of some conceptual errors. To the end of group discussion, the students can ask some concepts, and the lecturer put questions to team group.

The result for individual students, is the elimination of errors and deeper comprehension of concepts.

3 Mental Processes for Creativity Used in This Course

Thinking about the experience of creativity techniques teaching, was permitted to find some similarities between them, from the point of view of mental processes involved. Several different mental processes are used when creativity techniques are applied. Here are grouped in five aspects of similar mental proceses.

These proposed groups would reflect the main aspect of mental processes used in creativity techniques (Lloveras, 2010). Follows the proposed five aspects of mental processes and their contents are ordained here by degree of conscious used: between rational to near subconscious (see figure 2).

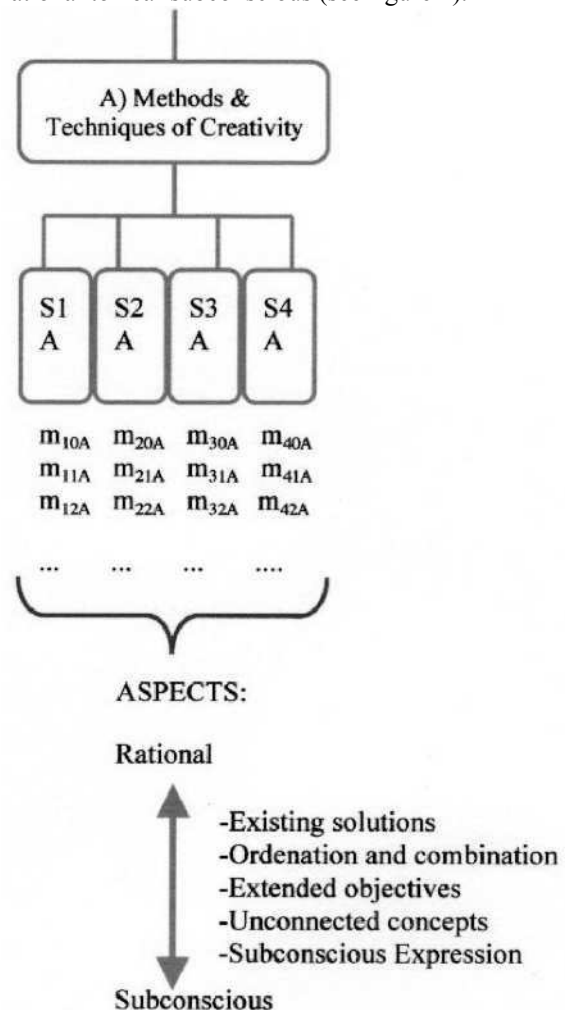

Fig. 2. Matters (m) of subjects (S) from A module, that are grouped by aspects of mental processes involved

Each subject (S1A to S4A) have one or several matters that can be grouped by similar aspects of mental or cognitive processes. The five different aspects are

explained below (sections: 3.1 to 3.5), from rational to subconscious.

All these creativity techniques that are explained in the course, they can be used for engineering design. Also other disciplines can use them, except patents and TRIZ that are more appropriate for engineering.

The contents of these similar aspects of mental mechanisms are the matters that belong to the subjects explained before. These subjects are noted in the text into parentheses.

3.1 Based on Existing Solutions

Here the basic mental process is the comparison between the creativity focus and known solutions.

There are two cases: those based on guided inspiration of existing technical solutions, and those based on analogies with known solutions.

3.1.1 Based on guided inspiration of existing technical solutions

This aspect is specific for the subject: conceptual engineering design.

- the existing technical solutions are well documented in **patents** that permit to find similar solutions and also be inspired by them, (subject: Inventions and patents);
- **TRIZ** is the acronym of "The theory of solving inventor's problems" (Altshuller, 1990), based on an analysis of a great amount of patents, describes 40 inventive principles that help to solve contradictions between 39 engineering parameters, (subjects: Creativity Techniques and Software of creativity).

3.1.2 When concepts related with creative focus are actively find

The mind finds actively concept related with creative focus (analogy) that aids to explain new ideas.

- **analogy** (Gentner, 1983);
- **Sinectic** (Gordon, 1961) techniques. Sinectic is based in analogies.

3.2 Based on the ordenation and combination of concepts and ideas

The ordenation of ideas permits a better analysis of them, and facilitate to find new ones, or new combination between them.

- based to group similar ideas of solution that is draw as a map called **Mind Maps** (Buzan, 1996), or **Concepts fan** (De Bono, 1992),

(subjects: Creativity Techniques and Software of creativity);

- based in lists of questions to answer, as several **Check-list**, or **SCAMPER** (Eberle, 1996), (subject: Creativity Techniques);
- based in combination of possible solutions from a functional model of product, as: **Morphological matrix** (Zwicky, 1969), (subject: Creativity Techniques);
- based in the ordenation of in-group discussion. Six aspects of a project have their own time of discussion; **Six Thinking Hats** (De Bono, 1986). This procedure permits better production and ordenation of ideas for a project.

3.3 Based on Ample Objectives to Think

Next, five visions to think, that can be used in early moments of design development. This manner to see ample, or extended, the objectives, can bring new approach and new ideas.

These items can be combined between them, (subject: conceptual design).

- all things can always be **better designed**, or always improved. Even well designed things or things that function well;
- imagination of **ideal thing** (Osborn, 1993). All technical objects evolve to ideal through successive improvements. To imagine technical objects, or services, in ideal state -even magical ideal state-, makes the thought possibly closer to the ideal that the technology will evolve in the future and that is an advantageous thought front other thoughts without this focalization;
- **imagination of future**. To think how an object will evolve when pass a lot of time, for example 25 or 50 years. It is similar than previous one but here there are a limit in time;
- expression of **desires**. A participant/s explains how an object, or service, would have to be according to its desire.
- Attention to **all ideas**. All the ideas arising in creativity sessions can be saved for their future possible application, even those out of creativity focus.

3.4 Based to Find Relations between Unconnected Concepts

It is a mental process that occurs when the mind tries to relate concepts that are without clear connexion. The

following topics of this section are treated in the Creativity Techniques subject.

- **by chance.** Random words or images are joined with creative focus. The mind establishes links between them and new ideas can emerge;
- **provocation techniques** -Lateral thinking- (De Bono, 1994). The creative focus are linked with concepts opposite to common sense, then the mind try to explain possible connections and new ideas can emerge.

3.5 Based on a Better Expression of Subconscious

The subconscious is a tank of concepts of every mind have, and these concepts sometimes are added between them to create new ideas. These new ideas are not easy to reach the conscious level, and there are some techniques to improve this communication between subconscious and concious.

Several topics related below, are treated in several subjects, as: Creativity Techniques, Software of creativity and Invention theory.

- to be **alert**. Because fugacity of the ideas. When appear ideas in mind they must be recorded in some sustract, i.e.: pencil and paper, before them desappear;
- to separate ideas apparition of their critical judice of mind. Is expresed the first idea that comes from mind about creative focus. **Brainstorming**, (Osborn, 1993), and some variants: Alternancies, Brainwriting, 6-3-5, Brainwriting pool, etc. (subjects: Creativity Techniques and Software of creativity);
- based to be aware with semiconscious state. As ideas in wake up period. In that case is needed to write these ideas before than they disapear: **Sleep-writing**;
- based in **latency** period. The mind ever works included when the person makes another task or even sleep. Then an idea of solution can come after some time;
- mind **relaxation, meditation**. Are well-known methods to diminish the mind stress or to liberate mind blockages. That permits better mind performance and better subconscious connexion.

4 Discussion and Conclusions

Engineering design and creativity (Eder, 1996), is an interesting and necessary relationship that one promote

the other. Quality innovations are demands from society and they are produced by the companies, that have great competence between them in a free market. Then the companies that they have great creativity potential and good processes of produccion can have good innovated products that permits their suces in the market. That means, that new ideas (creativity) are necessary in this process.

There are several manners to have new ideas, and several authors' writes about creativity and their application as are cited before, and also there are others that have good contributions, as (Michalko, 2001), (Sternberg, 1999), etc.

The conceptual engineering design is the first phase to have innovated products, and can start after several studies of viability that include technological surveillance and competitive intelligence, which are favourable to the interest of the company. Also it is possible to have an idea and after that analyse their viability and start conceptual designs. Several iterative designs and creative ideas are needed to reach an innovated product.

4.1 Creativity-training Course

This creativity-training course helps to students to have knowledge, abilities and attitudes for produce new ideas and understand the keys of company innovation.

The effective use of these different creativity techniques can depend of several causes, for example: the individual personality, how fit the person in a working-group, the ambience, etc. A good strategy for a person is to try different creativity techniques and search the most appropriate. Also this strategy is valid for a working-group. But it would be recommendable to try to use other techniques periodically.

At the beginning of the course a creativity test it is done to the students. Few of them have a great punctuation and some others have low punctuation, normally the average punctuation of students is over that the general average of people. The students with high punctuation are detected quickly by its creative quality in class exercises. No creativity test is made at the end of course, but the students say that they are more creative than the beginning of course. That has been tested in another creativity course (Boccardo, 2007).

Anonymous surveys to the students at the end of he course have been made, and these surveys generally show a good acceptance and profit of this course. In these surveys to students, they also make recommendations about possible improvements of the course.

This creativity-training course starts in 1996-97 academic year, with three professors, nowadays there are seven professors and the hours of classroom are increased. The course is of student payment, and in spite of low advertising of the course, survives until now. The course is self-sustained by student fees incomes (from 1996-97).

The number of students is low and varies from course to course. Approximately half of them come from companies or institutions, and there are some free places that are offered every course.

This course was started with more theoretical subjects than nowadays, which is more practical. Also today is more focused on industry application than in early years.

The contents of this course have evolved, with knowledge evolution of professors, with detected necessities or desires of students or of the market. The course structure and their current contents, has been explained above.

4.2 Aspects of Mental Processes Involved

In this paper, the structure of course is showed, and also is proposed five aspects of mental processes involved in creativity techniques, that are ordained in five categories that range from the rational processes to the unconscious mind processes.

Other techniques of creativity, not treated here, can be put in different aspects of mental processes mentioned. Also, some of the creativity techniques can be joined with some others and the melt can have different aspects of mental processes.

Perhaps in the future, the neurosciences will be able to give a deeper understanding of the mental processes, their similarities and the neuronal circuits involved.

References

- Altshuller G, (1990) And suddenly the inventor appeared; TRIZ, the theory of inventive problem solving, Technical Innovation Center, Inc. Worcester, Ma
- Boccardo R, Lloveras J, (2007) Prepararse para el Cambio, una Aproximación a la Inventiva en Ingeniería. VII Reunión Nacional de Currículo. I Congreso Internacional de Calidad e Innovación en Educación Superior. Universidad Simón Bolívar. Caracas, Venezuela. CD-ROM: 181.pdf, 11 pp
- Buzan T, (2000) The Mind Map Book. Penguin Books
- Carnicero L, Lloveras J, (2007) Practical application of the knowledge transfer EMS (Exchange of Mental Schemes) methodology to industrial environment. 16th International Conference on Engineering Design, ICED'07. Design for Society. La Villette, Paris, France. Full paper: CD-ROM: Information Systems and Knowledge Management, P-32, 12 pp
- Chaur J, Lloveras J, (2005) Research Study in Support Creativity Software as Tool to Assist the Conceptual Design Stage. 15th International Conference on Engineering Design (ICED 05). Melbourne, Australia, CD-ROM: stream 61, 389.34, pp 10
- De Bono E, (1986) Six hats to think. Little, Brown: Nueva York
- De Bono E, (1992) Serious Creativity: Using the Power of Lateral Thinking to Create New Ideas. HarperBusiness
- De Bono E, (1994) El Pensamiento Creativo. Paidós: Barcelona
- Eberle B, (1996) Scamper. Prufrock Press:Wako, Texas
- Eder WE, (1996) EDC Engineering Design and Creativity. Proceedings of the Workshop EDC. W.E. Eder (Ed.) State Scientific Library. Pilsen, Czech Republic, Nov. 95, Serie WDK 24, Workshop Design-Konstruktion. Pub.V. Hubka. Edition Heurista Zurich
- Formación Creativa para la Innovación de Producto o Servicio.
http://www.fundacio.upc.edu/presentacio.php?id=40968800&cercadorav=true&clave=formacio+creativa&area_selc=-1&tipo_selc=-1&metodo_selc=-1&durada_selc=-1&mes_selc=-1&poblacio=-1 (May 2010)
- Gentner D, (1983) Structure-mapping: A theoretical framework for analogy. *Cognitive Science* 7:155-170
- Gordon WJ, (1961) Synectics: The development of creative capacity. Harper and Row:New York
- Lloveras J, (2010) Agrupaciones de técnicas creativas dadas en un curso de formación creativa. II Forum Internacional y V Jornadas Innovación y Creatividad. Formación universitaria transdisciplinar e intercultural. GIAD (DOE-UB). Barcelona, 10-12/06/2010, 1-7
- Lloveras J, Garcia-Delgado C, Claudi L, Segura P, (2004) Creative formation. Structure and some results of this course for product and service innovation, Proceedings of the Design 2004. 8th International Design Conference. The Design Society. Ed. Marjanovic. Pub. Faculty of Mechanical Engineering and Naval Architecture, Zagreb, (Croatia), Vol. 1, May 17-20, 653-658
- Michalko M, (2001) ThinkerToys. Ed. Gestion 2000: Barcelona
- Osborn AF, (1993) Applied Imagination (3rd ed.). New York:Charles Scribner's Sons
- Sackman H, (1974) Delphi Assessment: Expert Opinion, Forecasting and Group Process. R-1283-PR, April 1974. Brown, Thomas, "An Experiment in Probabilistic Forecasting", R-944-ARPA, 1972 - RAND paper
- Sternberg R, (1999) Handbook of Creativity. Cambridge University Press:NY
- Zwicky F, (1969) Discovery, Invention, Research - Through the Morphological Approach. Toronto: The Macmillian Company

Design Image and Inspiration

Differential Approach of Design Image and Similarity Cognition
Yi Ting Huang and Hung Hsiang Wang

Poetry and Design: Disparate Domains but Similar Processes
Erin L. Beatty and Linden J. Ball

Design by Customer: a Management of Flexibilities
Risdiyono and Pisut Koomsap

Differential Approach of Design Image and Similarity Cognition

YiTing Huang and Hung-Hsiang Wang
National Taipei University of Technology, Taiwan

Abstract. This research provides a pilot method to measure the product image similarity from different subjects and evaluate the different judgement of product design. This approach is based on Tversky's similarity and experimental psychology, researching on the relationship between connections of specific design image and similarity of the presentation of masters' series of works when surveying the feelings from different group of industrial design (3D) and visual communication design (2D) students. We obtained insights that series of works with specific design identifications of masters' designs, we found very high similarity between their pair of products; the higher design image, the saliency will be higher than the other. The other finding is regarding to different subjects group have significant different opinion when comparing the harmonic level or imaginative level with two products due to different feelings, imagination and understanding, especially when identifying the product's shape and scale, material, metaphor and features. Furthermore, it is also an interesting problem to apply the results of this paper into the field of creativity.

Keywords: Similarity, Design Image, Cognition and Identity

1 Introduction: The Cognitive Perspective through Similarity Experiments

Masterpieces of design masters become classical are supported by classical design concept, works of a master always have consistency of design concept and image identity. Therefore, works of a master always have strong similarity through different periods.

The approach is focus on the relationship of specific image and similarity between works of two Scandinavia masters Aalto as harmony image and Aarnio as imagination image by experiment basis in Study3 Similarity of Figures of Tversky's Studies of Similarity.

Product Identity is the highly important issue in brand marketing, and product identity positioning needs to be done by cooperation of industrial designer, branding decision maker, and visual communication designer. Therefore, a common consensus of image should be defined before cooperation. However, is

there difference between industrial (3D)designers and visual communication (2D)designers in perspective of products?

In most of those surveying in design creativity and cognition related topics, the subjects are categorized as design-educated and non-design-educated group. Very few researching for difference of the perspective are based on design-educated subjects but in different design curriculum.

The aim of the research to be reported was develop an empirical and quantitative approach that if the image and similarity in existence between design masters' series works through 2D and 3D design training based subjects. It can also provide an open problem to design image evaluation in creative design process.

2 Literatures Review

2.1 Studies of Similarity

In Studies of Similarity (Tversky, 1978), It has been proofed the contrast model, the connection of similarity is in directionality and asymmetry. Which means 2 objects denoted as p and q, if the q is more prominent than the p, and then $s(p,q) > s(q,p)$, it means the p is more similar to q rather than q is more similar to p.

(S=Similarity, $s(p,q) > s(q,p)$)

Take this as an example; as American, the US is more prominent and salient than Mexico, take the US as (q) and Mexico as (p), we will proportionally say Mexico is similar to the US rather than Mexico is similar to the US. (above conclusion is based on the Similarity Study 1 and Study2).

Ortony (1985) has deeply researching about the similarity in Saliency, Similes, and the Asymmetry of Similarity, he finally brought up the formula of

$s(p,q)=\theta f(p\cap q)-\alpha f(p-q)-\beta f(q-p)$ and highlighted the asymmetry of similarity.

Tversky cited this concept in comparison of figures and proved by experiments, if we compare the similarity of 2 figures by specific criteria, e.g. compare the goodness of the visualization with object p and object q, if the goodness of object q is prominently higher, then $s(p,q)>s(q,p)$, and $s(p,q)=\theta f(p\cap q)-\alpha f(p-q)-\beta f(q-p)$.

Contrast Model is used by researching of products and brands, and there is Evaluation of Brand Extensions: The Role of Product Feature Similarity and Brand Concept Consistency (Park, 1991) as well, but it focused on product feature similarity and brand concept consistency; there is no research for similarity of product figure design by specific design image. Therefore, this approach based on Tversky's directionality & asymmetry of similarity for the further researching, hope to achieve a preamble for the product identification evaluation.

2.2 Product Identity and Image of Design

Product identity is transformed from semantic transformation, the most direct way to understand branding is to extract insight of semantic transformation and image design in a series of products that have consistent concept designed by the same designer (Karjalainen, 2003).

Image issues are including: feeling, sensing, style and so on. So far, most image researchers are focusing on the figure of product, material... etc. Some had proved that semantic approach is also applicable in machinery tools, and different cultures have different cognition (Salvador, Pedro and Margarita, 2005). Cognition of the products is decided by designers and consumers. By researching the sense of product figure, we concluded that designers and consumers are significantly different between each other, in other word the same product figure might impress designers and consumers differently (Hsu, Chuang and Chang, 2000).

In branding researching, identity is that branding company defined and want to bring to the consumers. Consumers might recognize it as specific image; the consistency of cognition between consumers and branding companies will be obtained by semantic communication and creation (Karjalainen, 2003).

Design master's series of works are defined as classic with consistent image such as humorous or fantastic, etc, and its' progress and value are the same as branding, which we called it as designer brand. That's why this research refer to the concept of image and branding identity, based on Karjalainen (2003)'s brand communication concept model, we place

master's masterpieces at one end and design-educated subjects at the other end. Then we come out a concept as figure 1, the identity and image concept of masterpiece, and the communication gap is the semantics cognition.

On the other hand, extract the specific meaning of identity from the life stories, reference related books to defined that the design identity of Aalto is harmony (Lahti, 2007), and design identity of Aarnio is imaginative (Gura, 2007) the designative image for the respondents of this research.

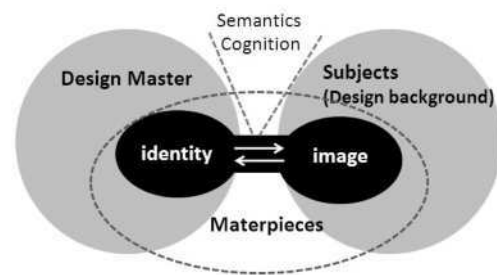

Fig. 1. The concept of identity and image for masterpieces (from this study)

2.3 Difference of Identification for the Product Image in 2D and 3D Designers

Compare the courses between industrial design and visual communication design department in the university in Taiwan. We found that industrial design department curriculums are focused on the product development phases of "creative brainstorming", "prototyping", "3D CAD/CAM graphing and prototype developing" courses (You, Yang, Liao, 2007), Whilst visual communication design students are focusing on colour, communication Design, visualizing, aesthetics, psychology, marketing, multimedia, advertisement, computer graphing, animation and relevant fields, their design concept is from "artistic visual feeling" transforming to "communication and functionality" (Mei-Wei Yang, 2003) For design science, sense, imagination, and cognition are more linear in sequence and depth, and inspire feelings respectively. (Ming-Huang Lin, Hsu-Fan Ai, 2003).

Mathias (1993) found that expert designers whom we called design masters use drawing and modelling for synthesis to embody the ideas in physical form. Kokotovich (2000) found design in that drawing and design representation appear to play a central role in the design thinking process, and in creative 3D responses, industrial designers performer better than visual communication students.

The research is based on above theories and findings, raising the hypothesis: Industrial Designers and Visual Communication designers will have difference perspective in product figure and image.

3 Approaching Methods

3.1 Hypothesis

Following above motive and analyzing, we have 3 hypotheses as followings:

H_a: There is no connection of similarity and harmony (or similarity of imagination) between two products of the same designer

H_b: There is no difference of similarity recognition at the same pair of product between different subjects group.

H_c: There is no difference of image recognition at the same pair of product between different subject groups.

3.2 Survey Approaches and Steps

3.2.1 Sampling Baseline

(1) Subjects Samples

There are two categories of subjects, all of them are 2~4 year university students, one category is of 57 sophomore and junior students from I.D.(industrial design) department, and the other is of 54 sophomore and senior students from V.C.(visual communication) department. Totally, the effective sample size is 111.

(2) Sample of Designer's Series of classic products

In this research, we refer to the first and second modern master designer, Aalto (1898-1976) and Aarnio (1932-) of the book, The A-Z of Modern Design (2006), for their several periods of products. We sample 15 products of Aalto and group in 8 pairs for the similarity of product image survey, each pairs denoted one object as p and the other object as q, see table (1), whilst sample 13 products of Aarnio and group in 8 pairs for the similarity of product image survey, as table (2); the sample quantity were created from Similarity Study3 (Tversky, 1978).

Table 1. Primary information of Aalto masterpieces similarity of product image survey

















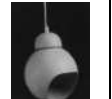















1			2		
	p	q		P	q
3			4		
	p	q		P	q
5			6		
	p	q		P	q
7			8		
	p	q		P	q

Table 2. Primary information of Aarnio masterpieces similarity of product image survey

1			2		
	p	q		P	q
3			4		
	p	q		P	q
5			6		
	p	q		P	q
7			8		
	p	q		P	q

(3) Choosing Baseline for Identifying Similarity of Image of Product Figure

We extracted Lahti's (Lahti, 2007) comments for ALVAR AALTO in the book that research on Aalto's product: Aalto emphasized on "harmony of human and nature" concept in his product and furniture design, on

the other hand, Aarnio’s products in Scandinavian furniture (Gura, 2007) and The A-Z of Modern Design (Polster, 2006) were rich in imagination and experimentally use plastic material boldly in his design. Hereafter, we took Aalto’s “harmony of human and nature” as specific image for the baseline of similarity measurement, and Aarnio’s imagination as semantic symbol.

3.2.2 Survey Questionnaire and Surveying

We use structured questionnaire and refer to the questionnaire of Study3 Similarity of Figures in Studies of Similarity (Tversky, 1978). The questionnaire is categorized as set1 (Similarity survey for Aalto’s products) and Set 2 (Similarity of Aarnio’s products).

In the SET1 questionnaire, there are 15 Aalto’s products and categorized as 8 pairs, each pair has a product of “p” and a product of “q”. The respondents will check the better “harmony of human and nature” sense item intuitively. If one felt product “q” is more harmony than “p” and then check on q.

On the other hand, for the second question, if one chose the “q” is more harmony and then he should evaluate how much “q” is similar to “p” in grade from 1~20. Lower grade means weaker similarity, and higher grade indicates stronger similarity.

Vice versa, if ‘p’ is chosen and then grade how much the similarity is from 1~20.

In the SET2 questionnaire, there are Aarnio’s products and categorized as 8 pairs, each pair has a product of “p” and a product of “q”. The subjects will check the item of more “imaginative” sense intuitively. Subjects will check more imaginative product between “p” and “q”, and grade the similarity from 1~20.

The samples of the questionnaire for 8 pairs of SET1 and SET2 are as above table (1) and table (2).

4 Survey Results and Analysis

4.1 Analysis of Connection between the Harmony and Similarity of Different Products

















This section is mainly to research the analysis of connection between the harmony (or imaginative) and similarity of different products, we ignore difference of subjects in this research and sample size is 111, average the amount of “p” or “q” being picked and the amount of grades for similarity respectively; For example, in Aalto group1(table3), subjects thought q is more harmony sense (N(q)=94 at 84.7%) and the grades of “p is similar to q” is up to 16.20, therefore we concluded: the higher harmony the product is , the

similarity of the other product will be stronger. Next, we will analyse Set 1: Aalto’s series of products and Set 2 Aarnio’s series of products.

4.1.1 Connection between the harmony and similarity of Alvar Aalto’s different products

In the 8 pairs of Aalto’s products, when evaluating the harmonization of product p and q according to “the harmony between human and nature”, we can find the average grades of similarity of Group 1,3,5,7 are 15.75,11.64,13.04,13.51 in the summary (table3), compare to the baseline 10.5, the similarity is high; Group 2 (M=6.67), Group 4 (M=6.95), Group 6 (M=6.82), Group 8 (M=8.26) are lower than 10.5, but higher than 5 (somewhat similar).

Table 3. Aalto’s products image similarity survey results in number, mean and T test

	p	q	s(q,p)	s(p,q)	N(p)	N(q)	M	t
1			13.24	16.20	17	94	15.75	11.80***
2			6.70	6.42	99	12	6.67	-10.66***
3			11.18	12.34	67	44	11.64	2.56*
4			6.94	6.95	53	58	6.95	-10.47***
5			13.01	13.27	11	100	13.04	6.38***
6			6.91	6.67	68	43	6.82	-9.80***
7			13.5	13.6	60	51	13.5	7.10***
8			9.04	7.67	63	48	8.26	-5.56***

*** p<.001, ** p<.01, *p<.05







In the table 3, the amount of picking p or q according to “the harmony between human and nature”, and compare to s(p,q) and s(q,p), we found: except Group3 and Group7, all the other group are N(p)>N(q), and s(p,q)>s(q,p); And in the Set1 T testing, All p<.05 also proved : all the mean of the 8 pairs in T testing are different significantly. Therefore the alternative hypothesis of Ha is acceptable; When product was recognised as stronger harmonious, then the other product would be higher similar.

4.1.2 Connection between the imagination and similarity of Aarnio's different products

In the 8 pairs of Aarnio's products, Group 1 (M=12.58), Group 6 (M=12.73) are the highest grades in similarity, and the data of 2 pairs, p<0.001(table 4), shows very significant difference.

Regarding the imagination, Group 1 (N(q)=60, s(q,p)=12.9), Group 6 (N(q)=104, s(q,p)=12.87) also answer the hypothesis HA: The stronger imaginative the product is, the similarity of the other product is stronger.

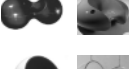
Table 4. Aarnio's products image similarity survey results in number, mean and T test

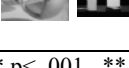
p	q	s(q,p)	s(p,q)	N(p)	N(q)	M	t
1		12.2	12.90	51	60	12.6	4.51***
2		4.65	5.47	51	60	5.09	-16.86***
3		7.87	7.26	84	27	7.72	-7.22***
4		6.27	7.18	44	67	6.82	-8.76***
5		10.80	9.89	30	81	10.1	-.85
6		10.71	12.87	7	104	12.7	5.02***
7		9.75	9.6	63	48	9.68	-1.71
8		4.24	4.40	21	90	4.37	-18.51***

*** p< .001, ** p<.01, *p<.05

Generally, the mean of T testing for similarity survey to 8 pairs of Set2, except Group 5, 7, the p>.05, are less prominent. All the rest, p<.05, on the other hand, except Group5 is violate to the policy of "if [N(p)>N(q) then s(p,q)>s(q,p)]", All the rest groups are tenable for the hypothesis, Therefore we prove the hypothesis Ha is acceptable in SET2 survey researching.

4.2 Difference of similarity identifying to a pair of product between different education background subjects

According to the analysis of independent sample T testing, except the 3rd pair of Set1 and 2nd pair of

Set2, p<.05(Table 5,Table 6) are prominent, all the rest 14 pairs are less prominent in similarity of image for both ID and VC students. In other words, only 2 of 16 pairs are taken as prominent in similarity of image for both ID and VC students. This demolished the hypothesis HB: there is difference of similarity identifying to a pair of products between industrial design(3D) and visual communication(2D) subjects.

Table 5. Aalto products' similarity mean of t test analysis

	Dept.	M	SD	t	F
Similarity	ID	11.68	4.42	.10	1.59*
Group3	VC	11.59	5.01		

*** p< .001, ** p<.01, *p<.05

Table 6. Aarnio products' similarity mean of t test analysis

	Dept	M	SD	t	F
Similarity	ID	4.26	3.11	-	1.46**
Group2	VC	5.96	3.46	2.72	

*** p< .001, ** p<.01, *p<.05

Further analysis on the difference of image similarity identifying between ID and VC students, Aalto's 3rd pair of product were a lake look plate and a lake look ice tray, According to our sense and understanding, we assumed that ID students will evaluate the similarity by functionality and material perspective, whilst VC students will evaluate by colour and shape, this makes difference between 2 types of respondents.

And Aarnio's 2nd pair of products were a Pony Seat and a Tipi Seat, we assumed that ID students will evaluate the similarity according to figure design of the round shape and design concept of animal look implication of metaphor in ID students' perspective of sense, imagination and understanding, whilst VC students will intuitively grade the similarity by the impact of difference between horse and bird. This makes different.

4.3 Difference of identifying specific image (harmony or imagination) to a pair of product between different education background subjects

Here we use descriptive cross analysis and independent sample T testing to research the difference of identifying specific image (harmony or imagination) to a pair of product between ID and VC subjects.

4.3.1 Cross analysis of harmony image recognising for Aalto's products by different educated background group

In this experiment, we will analyze which is stronger sense of "harmony between human and nature" image

in 8 pair of Aalto’s products, and cross analyzing the percentage and amount of p and q were picked by ID and VC students, and then compare to the analysis of independent sample T testing (ID vs VC) (table7), we found except Group 4 and Group8 ID and VC background subjects have little difference, all the rest 6 pairs p<.05 are significantly different between 2 parties. In other words, when recognizing harmony image for Aalto’s products, ID students and VC students have significant difference in perspective and image recognition.

Table 7. Aalto products’ harmony analysis of independent sample T testing

	Dept.	M	SD	t	F
Harmony Group1	ID	1.86	.35	2.23	21.19***
	VC	1.69	.47		
Harmony Group2	ID	1.12	.33	-6.72	38.26***
	VC	1.65	.48		
Harmony Group3	ID	1.32	.47	1.59	10.48**
	VC	1.19	.39		
Harmony Group5	ID	1.93	.26	3.43	62.97***
	VC	1.69	.47		
Harmony Group6	ID	1.46	.50	-6.52	197.06***
	VC	1.94	.23		
Harmony Group7	ID	1.26	.44	-2.42	15.04***
	VC	1.48	.50		

*** p<.001, ** p<.01, *p<.05

Further analysis of Aalto’s Group 1, Group 3, Group 6, those are developed from the classic lake look, but different in materials and functionality and some scale of figure for each pair, and Group 2, Group 5 and Group 7 are furniture design, same style but different scale, e.g: tall and short chairs or single and double sofa; From the result of analysis of different sense of 2 groups of subjects for the 6 pairs of design products, we can infer that ID and VC students will evaluate the “harmony between human and nature” according to “scale of figure”, “ materials” and “functionality”, and apparently, 2 parties have significant different idea in “scale of figure”, “ material” and “functionality”.

4.3.2 Cross analysis of imagination recognising for Eero Aarnio’s products by different educated background group

In this experiment, we analyzed which is stronger sense of “imagination” image in 8 pair of Aarnio’s products, and cross analysing the percentage and amount of p and q were picked by ID and VC students, and then compare to the analysis of independent sample testing (ID vs VC) (Table 10).We found in Group 3,4,5,8 where p<.05, are apparently different,

and for the other pair, 2 parties have no significant difference in imagination perspective.

In Group3, Group4 and Group5, all products are apparently implicit the metaphor and functionality of chair. Group3 are Tomato Chair and Pastil Chair and Group4 are Screw Table and Baby Rocket, and Group5 are Tomato Chair and Formula Chair.

And Group8 are inspired by bubble concept, Bubble hanging Chair and Double Bubble Lamp, but 2 functionalities are totally different, one is chair and the other is a lamp.

From the difference of sense of imagination for the 4 pairs of product between 2 parties,

We can infer that ID and VC students would evaluate the imagination according to the metaphor and functionality of the design, and apparently ID and VC subjects have different idea to the image of metaphor and functionality.

Table 8. Aarnio products’ imagination analysis of independent sample T testing

	Dept.	M	SD	t	F
imaginative Group3	ID	1.30	.46	1.39	7.97**
	C	1.19	.39		
imaginative Group4	ID	1.77	.42	3.95	17.39***
	VC	1.43	.50		
imaginative Group5	ID	1.77	.42	1.02	4.16*
	VC	1.69	.47		
imaginative Group8	ID	1.86	.35	1.35	7.51**
	VC	1.76	.43		

*** p<.001, ** p<.01, *p<.05

According to the inference of the analysis in this section, we proved that hypothesis of HC, there is different idea in the harmony (or imaginative) of image between ID background and VC background subjects.

5 Conclusion and Suggestion

5.1 Conclusion

This research is based on Tversky’s studies of similarity and experimental principle of Study 3-Similarity of Figures, sampling with Aalto and Aarnio’s product, 8 pairs of each, and 2 group of subjects, Industrial Design students and Visual Communication students.

Evaluating the “harmony” and grading for the similarity for each pair of Aalto’s 8 pair of products, whist evaluating the “imagination” and grading for the similarity for each pair of Aarnio’s 8 pair of products.

Here is the result and key finding of this approach:

(1) Design Master would design his product in specific semantic identification (e.g. Aalto's harmony and Aarnio's imagination); products are similar to each other in a pair, and higher harmony (or imaginative) product q, the prominence and salience are higher than the other product p, therefore, the similarity of 2 product is $s(p,q) > s(q,p)$. (s =similarity).

The result proved Tversky's discourse of similarity: when 2 things are in contrast model, the similarity is in directionality and asymmetry and applicable for evaluating the classic products of masters.

In the result of this research we discovered, there is always a design image in masters' classic masterpieces. And there's similarity between products of different periods. And the stronger sense of design image, the prominence and salience of similarity is higher than the other.

(2) When evaluating specific design image of the products, different education background subjects have different perspective. In this research, ID and VC department have different curriculums and different training, and it caused different sense, imagination, and understanding when evaluating harmony and imagination, thus, there is significant difference in evaluating harmony and imagination. Compare to the analysis of stimulus of questionnaire, we infer that ID and VC background subjects have different idea about the image that conveyed from scale of shape, materials and functionality when evaluating harmony. On the other hand, they have different idea about the metaphor and functionality when evaluating imagination of products.

(3) Compare to Tversky's contrast model. If p and q were defined as products, then P and Q individually represents the characteristic set of p and q, and the similarity of p and q as formula:

$$s(p,q) = \theta f(P \cap Q) - \alpha f(P \setminus Q) - \beta f(Q \setminus P)$$

Based on above formula to analyze Aalto's 3rd pair of product: a lake look plate and a lake look ice tray, According to our sense and understanding, we assumed that ID students will evaluate the similarity by functionality and material perspective, whilst VC students will evaluate by colour and shape. Regarding to Aarnio's 2nd pair of products were a Pony Seat and a Tipi Seat, we assumed that ID students will evaluate the similarity according to figure design of the round shape and design concept of animal look implication of metaphor in ID students' perspective of sense, imagination and understanding, whilst VC students will intuitively grade the similarity by the impact of difference between horse and bird. Therefore, we can

make conclusion that ID and VC students have few in common on the attributes when evaluating the specific image. When weighting for different attributes, then there is significant difference of understanding.

This research provides a pilot method to measure the product image similarity from industrial design and visual communication subjects and evaluate the the different judgement of product design. Furthermore, it is also an interesting problem to apply the results of this paper into the field of creativity, especially in creativity education for integrating 2D and 3D design.

5.2 Suggestion

(1) Sample selection:

In this research, we survey the difference between ID and VC students in evaluating the similarity of classic design, and those classic design in the questionnaire are products, and we chose the pair of products according to the perspective of product designing concept by author. Therefore, we suggest that following researchers may select other sample which like graphic visual design pieces for better objectively analysing the difference of appreciation of aesthetics between ID and VC students for more cross analyzing in design creative and design evaluation research field.

(2) Following research advice:

In this approach, we mainly research on similarity of specific image of masters' classic works, and conclude the connections of similarity between product of prominent image and the extended products. If we take design master as a brand, then the same way, we can research on evaluation of similarity of brand and product identity, look forward to prove a new idea for the branding recognition research.

References

- Tversky A, (1978) Studies of Similarity. Hebrew University, Jerusalem 4:79-98
- Ortony A, (1985) Salience, Similes, and the Asymmetry of Similarity. *Journal of Memory and Language* 24(5): 569-594
- Polster B, (2006) *The A-Z Modern Design*. Merrell Publishers Limited
- Fiell C, Fiell P, (2005) *Scandinavian Design*. Taschen GmbH
- Park CW, Milberg S, Lawson R, (1991) Evaluation of Brand Extensions: The Role of Product Feature Similarity and Brand Concept Consistency. *Journal of Consumer Research* 18(2): 185-93
- Gura J, (2007) *Scandinavian Furniture (A sourcebook of Classic Designs for the 21st Century)*. Thames & Hudson

- Hsu SH, Chuang MC, Chang CC, (2000) A semantic differential study of designer's and user's product form perception. *International Journal of Industrial Ergonomics* 25:375–391
- Kokotovich V, Purcell T, (2000) Mental synthesis and creativity in design: an experimental examination. *Design Studies* 21(5):437–449
- Mathias JR, (1993) A Study of the Problem Solving Strategies used by expert and Novice Designers. PhD Thesis, University of Aston, Birmingham, UK
- Lahti M, (2007) Objects and Furniture design of Alvar Aalto. Ediciones Poligrafa
- You M, Yang M-Y, Liao P, (2007) Survey of Industrial Design Students' Learning Attitudes. *Design Journal* 12(2):15–36
- Yang M-W, (2003) Factors Affecting Students Getting into the Visual Communication Program: Empirical Evidence from Students in the Technological Universities/Colleges in Taiwan. *Design Journal* 8(3):39–55
- Lin M-H, Ai H-F, (2003) The Aesthetic Judgement and Symbolic Connotation in Product Design – A Case Study Based on Swatch. *Design Journal* 9(1):47–62
- Product design elements as brand manifestations, University of Art and Design Helsinki
- Mondragón S, Company P, Vergara M, (2005) Semantic differential applied to the evaluation of machine tool design. *International Journal of Industrial Ergonomics* 35(11):1021–1029
- Karjalainen T-M, (2003) On Semantic Transformation: Product design elements as brand manifestations. Proceedings of the "Common Ground" International Design Conference, London, September 5-8 2002

Appendix

Questionnaire example of Study3 (Tversky, 1978)

Study 3: Similarity of Figures

Two sets of eight pairs of geometric figures served as stimuli in the present study. In the first set, one figure in each pair, denoted p, had better form than the other, denoted q. In the second set, the two figures in each pair were roughly equivalent with respect to goodness of form, but one figure, denoted p, was richer or more complex than the other, denoted q. Examples of pairs of figures from each set are presented in the blow Fig 2.

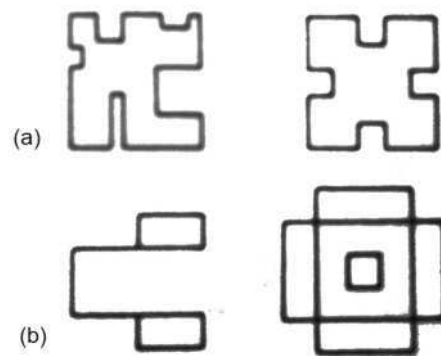

Fig. 2. Examples of pairs of figures used to test the prediction of asymmetry. (a) Example of a pair of figures (from Set 1) that differ in goodness of form. (b) Example of a pair of figures (from Set 2) that differ in complexity.

We hypothesized that both goodness of form and complexity contribute to the salience of geometric figures. Moreover, we expected a "good figure" to be more salient than a "bad figure," although the latter is generally more complex. For pairs of figures that do not vary much with respect to goodness of form, however, the more complex figure is expected to be more salient.

A group of 69 subjects received the entire list of 16 pairs of figures. The two elements of each pair were displayed side by side. For each pair, the subjects were asked to choose which of the following two statements they preferred to use: "the left figure is similar to the right figure," or "the right figure is similar to the left figure." The positions of the figures were randomized so that p and q appeared an equal number of times on the left and on the right. The proportion of subjects that selected the form "q is similar to p" exceeded 2/3 in all pairs except one. Evidently, the more salient figure (defined as previously) was generally chosen as the referent rather than as the standard.

To test for asymmetry in judgments of similarity, we presented two groups of 66 subjects each with the same 16 pairs of figures and asked the subjects to rate (on a 20-point scale) the degree to which the figure on the left is similar to the figure on the right. The two groups received identical booklets, except that the left and right positions of the figures in each pair were reversed.

Poetry and Design: Disparate Domains but Similar Processes

Erin L. Beatty and Linden J. Ball
Lancaster University, UK

Abstract. Despite parallels between the structure of poetry composition tasks and design tasks, no research seems to have explored the consequences of these correspondences for understanding skilled behaviour in these two disparate domains of creative endeavour. In our study we interviewed five expert poets about their creative practices and conducted a thematic analysis comparing these practices to key findings concerning the nature of design expertise. Our discussion focuses on three behavioural equivalences associated with poetry composition and innovative design: (1) the role of sources of inspiration in contextualizing activity and in informing the creation of solution ideas; (2) the involvement of Darke's primary generators in scoping tasks in terms of core objectives; and (3) the flexible nature of problem and solution representations, as captured by the notion that problem and solution spaces co-evolve.

Keywords: Creativity, poetry, design, inspiration, primary generator, problem-solution co-evolution

1 Introduction

People are capable of incredible feats of creative endeavor across all domains, yet our understanding of the processes by which these creative acts occur remains limited (Runco, 2007). Poetry composition is a particularly neglected research area, which is surprising given its status as a key domain of creative expression. Most of our current knowledge concerning the nature of poetry-writing skills derives from autobiographical accounts written by expert poets (Curtis, 1996; Mengert and Wilkinson, 2009). While these first-hand reports are valuable in introducing issues that may be associated with poetic expertise, it nevertheless remains critical to validate and extend the insights deriving from these reports through in-depth empirical analyses focusing on the imaginative processes of expert poets themselves.

The few existing empirical studies of poetry writing tend to adopt an educational perspective, focusing primarily on how *novices* write poetry. For example, Groenendijk et al. (2008) examined the impact of writing processes on final poem produced in

students with a novice level of skill in poetic composition. It was found that writing production in the first half of the session, and revision toward the end of the session, were associated with better quality poetry as judged by experts, whereas pausing and early revision had a negative effect.

Most empirical evidence in the poetry domain, however, is centered not on poetry composition but on how students read and interpret poetry. For example, Eva-Wood (2004) found that college students who were instructed to "think-aloud" and "feel-aloud" while reading poetry made more elaborative and better quality comments than students who were only requested to think-aloud. Earthman (1992) found that college freshman read literature in a "closed" manner, while graduate students read in a more "open" manner. Graduate students were open to ambiguity and layers of meaning in texts while freshmen were unwilling or unable to cope with such complications and subtleties.

Peskin (1998) compared how novices and experts constructed meaning when reading poems. Experts made allusions to other literary works, contextualized a poem within its poetic domain, and anticipated the direction of the poem's progression. Novices made such connections infrequently and achieved only simplistic representations of poems that lacked depth. They also spent less time overall attempting the task than the experts. Peskin's findings illustrate how difficult understanding poetry can be for novices, and imply that processes of composition will likewise be difficult for those with limited experience. Moreover, such observations underline how important it is to investigate the nature of *expert* performance in order to derive a rich understanding of the creative processes of those who are genuinely skilled within this domain.

Much of the difficulty surrounding poetry composition seems to derive from the task's ill-defined nature. Ill-defined problems are those where goals are vague, where optimal solutions are unknown, and where limitations of the problem space are unclear (Simon, 1973). Poetry writing exemplifies this definition, with the poet typically starting from a point where they have uncertain goals, unclear constraints, and a limitless set of actions that can be taken. Indeed,

there are no universal rules that dictate what a poem can or cannot be, despite the availability of dictionary definitions of a poem such as “a composition in verse, usually characterized by concentrated and heightened language in which words are chosen for their sound and suggestive power as well as for their sense, and using such techniques as metre, rhyme, and alliteration” (Collins English Dictionary, 2003). Poetry composition is, therefore, most certainly an ill-defined problem in the same way that innovative design is conceived to be (Ball et al., 1997; Simon, 1973).

The overlap between poetry composition tasks and design tasks in terms of their lack of definition is useful from a research perspective since it suggests that common processes may underpin activities in both domains. This means that we can make some good assumptions about the processes that may play out in poetry composition using insights gleaned from several decades of research on expert design practice (for reviews see Cross, 2006; Visser, 2006). Three findings from the design research literature seem especially likely to show parallels in the poetry domain, given its emphasis on the production of original, inventive and imaginative outputs. We describe these findings below before we then describing our study that focused on five expert poets.

1.1 Sources of Inspiration

The first finding relating to expert design that we were interested in examining in the context of poetry writing concerned the role of so-called “sources of inspiration” in informing the creation of new design solutions (Eckert and Stacey, 2000). As Eckert and Stacey explain: “Almost all design proceeds by transforming, combining and adapting elements of previous designs, as well as elements and aspects of other objects, images and phenomena”. Designers appear to use a wide variety of sources of inspiration, including previous design cases, analogies, works of art, and objects and phenomena from life and nature (Casakin and Goldschmidt, 1999; Ball et al., 2004; Christensen and Schunn, 2007; Ball and Christensen, 2009).

Eckert and Stacey’s own research on knitwear design supported the view that such sources of inspiration provide a “vocabulary” for communicating ideas to others. Thus a reference to the color blue from a particular year is distinct from a reference to the color blue from another production period. While this referent lacks coherence from the outside, for those within the field it is highly contextualized and information-rich. It is, therefore, the act of naming these sources of inspiration which provides a context for the designer’s work within their larger field and which informs the creation of innovative designs.

These inspiration sources get combined with previous design decisions and, in combination, become units of information that can more easily be discussed and recalled. These units thereby provide a method for managing information complexity within the design process. In our study we were alert to the potential role of inspiration sources in informing poetic narratives at all stages of their development.

1.2 Solution-Focus and Primary Generators

The second general finding from studies of expert designers that we wished to examine in relation to poetry composition concerned its highly “solution-focused” nature (Cross, 2006). This emphasis on solution generation in design seems to be a consequence of the ill-defined nature of design tasks. Design problems are not of a type where all of the information needed to solve them is available to the solver, such that they are neither open to exhaustive analysis nor amenable to single “correct” solutions. Indeed, much of the information to solve the task can only be discovered by generating and testing solutions and by using these results to refine an understanding of the problem. What this effectively means is that in design problem solving a solution-focused strategy is preferable to a problem-focused one (Cross, 2006).

The solution-focused strategy of designers often necessitates a reliance on an initial organizing principle to structure activity (Cross, 2006). One interesting notion in this regard is that of the “primary generator”, espoused by Darke (1979) in the context of her interview-based studies of expert architects. Darke’s architects tended to impose a limited set of objectives on the task as a way to constrain the space of possibilities. Objectives related to notions such as wishing to express the site, maintain social patterns or provide for a particular relationship between dwelling and surroundings. Darke viewed these objectives or initial concepts (i.e., the “primary generator”) as providing architects with a “way into the problem”, while also enabling them to explore and understand the problem in a “conjectural” manner (i.e., by testing the adequacy of initial conceptualizations of a solution).

Lloyd and Scott (1995) similarly described a moment when architects articulate how they “see” a design, referring to this as the designer’s “problem paradigm”, and suggesting that until this point is reached the designer is engaged in trying to place the design problem within their area of experience. Schön (1988) likewise described “problem setting” as the process by which individuals “name” things they attend to and then “frame” the context that the named item is then examined within. Schön suggested that expert designers frame the design problem in order to

create circumstances under which a solution can be sought.

Although the negative consequences that can arise from a selective focus on single solution ideas has been noted (e.g., Ball et al., 1998), it appears that these consequences may be more of a problem for novices (where initial ideas can embody major inadequacies) rather than experts (where initial ideas often end up being successful; Ball et al., 2001). For experts there is now mounting evidence that an early narrowing of the solution space is often vital for effective design development since it enables the designer to manage complexity through a focus on core objectives and constraints. In the present study we anticipated discovering evidence for early deployment of primary generators to guide poetic explorations.

1.3 Co-Evolution of Problem and Solution Spaces

The third observation from design research that we wished to examine in the context of poetry writing is that design problems and solutions are flexible, as captured by the notion that problem and solution spaces “co-evolve” (Maher et al., 1996). As Dorst and Cross (2001) state: “It seems that creative design is not a matter of first fixing the problem and then searching for a satisfactory solution concept. Creative design seems more to be a matter of developing and refining together both the formulation of a problem and ideas for a solution, with constant iteration of analysis, synthesis and evaluation processes between the two notional design spaces – problem space and solution space”. These ideas relate closely to the role of primary generators in design and the view that design activity is conjectural in nature, whereby expert designers use solution attempts as “experiments” that assist in identifying information about the problem. In contrast, novices may get stuck in their attempts to understand the problem before even beginning to generate solutions (Cross, 1990), getting bogged down in the problem space. In examining our interview data we were vigilant for any evidence that problem-solution co-evolution might be a feature of expert approaches to poetry composition.

2 Method

2.1 Participants

Five participants (2 male; 3 female, mean age: 34.8 years) were recruited on the basis of having published poetry. Participants had between 10 and 60 published poems (mean: 29 poems). They had been writing

poetry for an average of 9.6 years, and writing in general for an average of 16.4 years. Across the sample there were three published short story collections, one novel, two poem pamphlets, 13 individual short stories, and 145 published poems. Two poets had a bachelor’s degree and three had (or were pursuing) a graduate degree.

2.2 Materials and Procedure

Participants were asked 11 interview questions, including predetermined prompts and customized questions generated during interview. In this paper we focus on responses relating to the following questions: Where do you find inspiration? [Is it from the same place?]; Is there a specific process you like to use or a pattern you have noticed?; How do you revise your work? Participants were interviewed individually and the value of their personal observations was stressed.

3 Results

Verbal responses were analyzed for thematic content to determine both general and unique patterns within the sample. The results we present are limited to responses to the topics of inspiration, writing process, and revision, since these responses were most likely to reveal insights relating to our orienting assumptions concerning the nature of expert poetry composition.

3.1 Inspiration

Inspiration is difficult to study experimentally since it cannot be guaranteed to occur. Yet poets are a group of individuals who are highly motivated to self-manage their moments of inspiration. It is with this in mind that we questioned our participants about their sources of inspiration under the assumption that as experts they would have the metacognitive skills to discuss it. Across all of the responses there seemed to be one common frame of reference, which was that the poets wrote about what they were familiar with. They were inspired by what they saw to a varying degree in their lives, their families, and their daily experiences.

Participant 4 explicitly stated that: “I’m a lot more interested in the mundane, the everyday and just the everyday things that people say to each other when they are on the street, or how they look at each other - just ordinary people doing ordinary things can be much more poetic - and I see my job as taking that inspiration trying to make it poetic”. While this participant focused on things that they witness there is a distance between them and what they write about.

Participant 3 indicated that they had been working on a series of poems with a strong narrative: "...but I didn't know that that's what I was doing until I was into doing the poems". They went on to point out that they heard someone say: "I used to swim there with Michael", and I just thought that was a really beautiful line, so I put it into this poem and then I thought 'Who's Michael?'" This quotation seems to exemplify both the characteristics of having a primary generator and also of solution-focused writing.

This poet also indicated that there was more than one large theme in their work (e.g., grief), but they were not aware of the theme until they were well into the creation process. They explained that: "it's always a bit like that, linking things, but you push ahead with it and you look back to see if there's a pattern and at that point you start dropping some things and building up on others". This comment speaks to the highly conjectural nature of their writing process, whereby some things are tried out and developed if they work, whereas other things are attempted but omitted if they fail to show promise. Participant 5 stated that: "it sounds so pretentious. I would say where I find it [inspiration] is actually in me. I don't look for it and I think actually if you start looking for it you go blind - really you don't see it - and I think that the inspiration is when it sparks inside you. If I do go looking for it it's about being very still and quiet and seeing what comes up." Participant 5 had the most metaphysical interpretation to the question. Their opinion of actively searching for inspiration was quite negative.

Participants 1 and 2 both named their own lives as sources of inspiration. Participant 1 said: "I suppose the core inspiration is probably the deepest conflicts in your own life", and they also stated that "the centre core or the 'engine' of the book, as my favourite editor says, is always something that is some sort of conflict or circumstance that is very important to you". When asked about what inspired them to write Participant 2 stated the following: "Mostly in life and in family and in social constructs." Both Participants 1 and 2 also stated that the topics they write about should be very important. Participant 2 noted: "You write from conflict, you write for what is important for you because [you] have to be passionate about it for it to be interesting. To make it relevant to other people you better find it important". This explanation takes the audience into account. It raised the idea that successful poetry makes people "feel" something and that the best way to do that is to feel something yourself about the poetry. This is certainly supported by Eva-Wood's (2004) findings that students encouraged to "feel-aloud" were better at understanding poems.

There were a range of responses to Question 3, especially pertaining to the degree to which personal experience was used as inspiration for writing. The

majority of participants drew upon their own life experience and all participants were able to articulate what in the past had inspired them to write.

3.2 Writing Process

Our participants seemed to represent a continuum of how much they were able to activate their own writing process. Participant 4 represents one extreme, where their focus was placed on taking in what initial concepts were available to them. By comparison, Participant 1 appeared to take an active role in blending information, seeking and applying it to their preferred technique, where they expand the information to fit what they are working on.

Participant 4 indicated that they recognized that their usual method of writing starts with "collecting lines". They stated that: "For me it's always been about kind of collecting these lines and phrases and words as they come in and then seeing what they're saying, and seeing what they're trying to tell me, and trying to build something with that afterwards". Participant 4 placed an emphasis on the organic nature of their process, whereby they focus on collecting these lines and connecting them together. The 'active' portion of their process is not focused on this initial stage when the line first appears, since the individual believes that the emergence of this first line is not within their control. Moreover, this individual specifically stated that they cannot sit down and decide to write a poem: "I'll collect these lines and then try and work out what they are saying. I know some poets can sort of sit down and say 'Okay, I'm going to write a poem today about this; or this has happened so I'm going to write a poem'. But I've never been able to do that". This notion of collecting lines and working from them seems to have qualities in common with the concept of the primary generator. These initial lines have a way of delimiting the boundaries of the poetic design space, providing focus for later writing activity.

Participant 2 also spoke about a single, initiating idea that sounded similar to a primary generator. For them this first idea can come from a variety of sources: "there is an initiating idea that just sort of comes out of experience or just sort of family events sometimes. Often though, it's a matter of reading poetry and being prepared to write, and almost forcing the writing where it's read a poem, chose an image or a word or something out of the poem that speaks to you, and write from that. Write your own experiences from that point using either using that as a jumping off point, [or] using that as a part of the poem". This participant seems to have a way of seeking out inspiration when they talk about reading poetry and choosing something that 'speaks' to them. It is not entirely within their

control to determine what will spark that feeling but they are able to put themselves on the path.

Participant 3 described their writing process as being focused on solution generation that is not solely dependent upon feeling inspired. As they put it “laying it down is almost a different process. It’s just that you’re into more of a sense of work about it ... You’re not hanging around waiting to be inspired; you’re sort of getting on with it, and somewhere in the getting on with it something good will happen”. Our interpretation of this is that only by producing something can it later be evaluated. Such a solution focus is consistent with Cross’ (2006) claim that design progresses in a highly solution-focused way.

Participant 1 indicated that to pursue their writing they used a “relaxation technique which I think helps you separate yourself from your ordinary everyday life”. This statement points to Participant 1’s belief that there are different mental spaces, with the creative space being different from the one normally used when dealing with daily occurrences. They went on to describe their theory of the imagination: “you don’t imagine something up; you always have to look at something in order to get the information because your information isn’t in your head. You go out and look at the details; you go out...and spy on people, which is a lot of fun. You go to coffee shops and you look and you listen and you try to use all of these details and you take that information home and you do your relaxation technique and then you embroider once you’ve freed your mind”.

Participant 5 is unusual within the sample because while the other individuals seem to be describing a process that exists at a point that varies along a continuum, Participant 5 instead seems to describe these different points along this continuum as within their normal range of writing processes. They state that: “Sometimes, very occasionally, I will sit down and something that comes out, an expulsion and that can be prompted by a bit of thinking prior. There was a poem I wrote having seen a play and the next morning I got up and I had to get that play out of my system. It was incredibly powerful...and I just sat down. And when [poems] come out like that they are almost there and they need very little striking out, but that hasn’t happened that often. I suppose they fall into categories”. So this experience seems to be of limited internal control. This rare type of poem comes into existence rather suddenly and nearly fully formed: “There is that category [and] there is the category of having an idea that I chip away at on the paper. Then there is the idea that sits in my head and I chew slowly over and over - that slowly starts to come out in the written word”. These two categories are differentiated by the space where they are developed. The second category is worked primarily on paper (a concrete,

real-world and visible space), while the third category is worked through primarily in the mental space. Participant 5 further stated that: “Then there is the other, which is a bit more of melding of styles which I have done a lot of written research for, and then I bring that research together. So there are four different ways I would say I go about it. And I don’t know what the preference is because I like them all - because they all serve different jobs”. This fourth and final category seems to represent an effort to create new and previously uncharted territory. In other parts of the interview Participant 5 spoke of setting challenges in order to explore the poetic form they had created.

3.3 Revision

Never is it clearer that poetry composition is, by its very nature, based on iteration than when poets discuss revision. While it might not be represented in each quotation here, all participants mentioned the need to repeatedly revise what they had written. Participants focused on three main issues within the revision process: (1) the need to gain objectivity; (2) the need to repeat the process of editing; and (3) that view that reading aloud was an effective strategy for finding the “gaps” or problem areas within a poem. These three themes will be explored simultaneously below, which reflects the way in which participants talked about them in an interdependent manner.

When discussing their revision process Participant 1 stressed its time consuming nature: “what [I] do [when] I get my manuscript to a certain point and get a section to a certain point [is] then I print it off and then I go through it again and again on my own and I edit it and re-edit it and it goes through maybe ten edits before I show it to anyone”. Participant 1 used a metaphor for the revision process where the writer is working on a pad of paper and the perfect work is on the bottom sheet and each round of revisions allows the writer to tear off the top sheet bringing the writer closer to the perfect work. For Participant 1 the general theme being expressed through this metaphor is the ‘repetition’ of the editing process.

Both Participants 2 and 3 used reading aloud as a way to isolate instances of disfluency in their writing. Participant 2 stated that: “I do a fair bit of reading aloud. There are two things that happen. One is pushing to get through how much you’ve set for yourself to edit, and that can be catching the glaring things, the places where you stumble, the place where it’s very unclear or big gaps, those sorts of things, but then also you have to have a focused approach where anything that has niggled but you look at it and you’re not sure what’s wrong...you have to stop and really look at those three or four lines that might be ten to

twenty words, or sometimes is only two lines it might be eight words and often what it is [is] too much condensing when what you need often in those places is simplicity - so, simplifying complex situations while maintaining coherence and clarity". Participant 3 echoed this sentiment as follows: "Go back and look at it. Read it over again, sometimes read them out loud because I like read them out loud, but it's also the rhythm that I'm writing for my own speech rhythm, so if I read it a few times I realize when I get to that bit it goes 'chkk' then maybe I need to change it because that's not a good thing to happen in the middle". It is apparent from the statements of Participants 2 and 3 that the read-aloud method depends upon their personal intuitions and feelings about where things are working or not working in the poem.

Participants 4 and 5 both spoke of trying to gain objectivity in the assessment of their poems. Their primary method for increasing objectivity was to put poems away and wait several weeks before reassessing them to determine what needed to be changed. Participant 4 stated: "I'll try and if I get a full first draft of a poem that I think I'm quite happy with I'll tend to put it away for a week or two and just leave it just as it is and try not to do anything to it, and then come back to it because then it's when you've been writing something and you've been working on it you can't judge it...so you put it away and you come back to it and immediately you see everything that is wrong with it, whether the rhythm is off and lines that don't work. I'll maybe do that two or three times with a poem. Rewrite it, put it away again, and then think 'well I'll come back to that again in two weeks' - eventually it just gets to a point that you're happy with it, so maybe you send it away to a magazine".

Participant 5 seems to be describing fixation, where they are focused on this single solution when they say that: "what sometimes happens is if I finish a poem [and] that I might have a bit of time, and I finish it say in the morning of a day - basically I can't let it alone then and if I've got a day for writing and I will spend that day tweaking it and fiddling about and it just gets under my skin, which isn't necessarily the best way of doing it, but it just becomes - I become quite obsessed by it and then I'll put it away". Fixation can be a negative factor when it stifles creative idea production and prevents other solutions from being pursued (Ball et al., 2001; Ball et al., 1998; Janssen and Smith, 1991). They go on to say that: "The best thing to do is write it and put it away not having done all that stuff before hand, so I may or may not do that, so I put it away and not look at it for however long, and ... they don't get looked at for a while and as [I think] 'oh, what about that poem' and I'll go back to it...and then I'll either read it aloud [or] if it's a longer poem I'll record it so I can listen to it and hear myself

again with objectiveness now that I'm no longer the active reader". So, Participant 5 makes use of multiple strategies as part of their revision process, including fixation, revision delay, and reading aloud.

Participant 2 made a novel and interesting point regarding the inspiration of the poem in the editing process, when they stated that: "There is an editing line that 'you must kill all your dearest little babies' because what was the inspiration for the poem is no longer a part of the poem. Often what was the perfect line that you love so much is often unnecessary in the poem when it's finished, because the poem is now saying what that line meant to you but wasn't in the line. It was in the story or the moment or the inspiration of the poem". The idea that your initial clever thoughts are made redundant by the output that you have produced is intriguing.

Our brief review of revision activities has focused on the multiple strategies employed by the participants during the revision process and their view that revision is cyclical in nature, with reading-aloud facilitating intuitive analysis, and time delays allowing for the attainment of a degree of objectivity. Future research could explore evidence of fixation and sketching during revision.

4 Discussion

We focus our discussion on the three orienting themes presented in the introduction, which we believed would be relevant to expert poetry composition: (1) the possible role of "sources of inspiration" (Eckert and Stacey, 2000) in contextualizing poetic activity and in informing the creation of novel ideas; (2) the potential involvement of "primary generators" (Darke, 1979) in scoping the poetry-writing task in terms of solution-oriented objectives; and (3) the flexible nature of problem and solution representations in poetry writing, as captured by the idea that problem and solution spaces "co-evolve" (Dorst and Cross, 2001; Maher et al., 1996). All three themes derive from a wealth of design research conducted over several decades.

In terms of sources of inspiration, all the poets we interviewed seemed to be inspired by one common factor, which related to what was "familiar" to them and, thereby, in some sense what was "ordinary", "mundane" or "everyday" (e.g., daily experiences, family circumstances and personal conflicts). The degree of commonality across these poets was striking, and probably attests to the simple fact that what was familiar to these individuals was also what they were passionate about. This passion was explicitly acknowledged by some of these poets when they explained that successful poetry makes the audience

“feel” something, and that the best way to embody such emotional connotations within the poem is to feel something yourself about what is being written.

In relation to the role of primary generators and solution-focused processing in poetry composition, there seemed to be a wealth of evidence supporting the poets’ tendencies to find an early way into the poem via a key objective or concept that paved the way toward subsequent solution exploration. Most of the poets commented on developing their poems from an initial idea or from a “first line” that had come to them. One poet even spoke of the first line eventually becoming redundant by the end of the writing process because the poem as a whole was now “saying” what had been originally inspired by that first line.

We are intrigued by this latter notion that primary generators may become redundant once they have served such a crucial role in sparking off the writing process in the first place. This observation seems to validate the role of such primary generators in providing the poet with a platform to frame their subsequent exploration of a topic in a conjectural manner while also affording a way for the poet to manage the complexity of the poetry-writing task itself. Solution-focused behaviour and the conjectural aspect of poetry writing also seems to be revealed in the dominant role that revision plays in the process, with the poets describing revision as something that they needed to do as well as an aspect of the process that they enjoyed.

In relation to the issue of co-evolution of problem and solution space, Dorst and Cross (2001) reported that the designers they studied: “...did not treat the design problem as an objective entity”, rather, individual designers took different interpretations and those interpretations themselves changed constantly during the course of the task. We acknowledge that our interview-based data did not allow us to provide clear-cut insights into the way in which poetry composition involves problem and solution representations that are highly fluid in nature. Certainly the importance of revision in poetry writing is suggestive of such fluidity, as is the claim that first lines may end up being omitted from the final poem. But we prefer to see this evidence as “indicative” of flexible problem-solution co-evolution rather than being definitive.

The inability of our data to address this matter more fully is, perhaps, a limitation of the interview method itself, which is retrospective in nature and divorced from the dynamics of poetry composition as it happens in real time. Uncovering more compelling evidence for problem-solution co-evolution will no doubt require the use of process-tracing methods such as verbal protocol analysis (Cross, 2001), and we are intending to deploy such approaches in our next empirical studies of expert poets.

Of course, with the benefit of hindsight it may be that poetry composition is a domain that is less well suited to the concept of problem-solution co-evolution than we had anticipated. In design situations, for example, it is typically the case that there is some sort of task that the designer needs to tackle or a problem that needs to be solved. This task or problem is something explicit that can be pointed at, even if it is that “Quality x” must be improved in “Product y”. But within the area of poetry composition, this language seems to break down when one starts to try to separate “problems” from “solutions”. Even if you take the perspective that solutions inform the poet’s conception of the problem after they have started to develop the solution (i.e., the poem), it is still not clear what the problem might be. Once the poet has a full draft of a poem and has entered the revision stage then arguably they can be seen as having a problem, with the revision process reflecting solution-seeking behaviour. But before that - when the poet is in the inspiration stage - what is the problem?

This latter question is one that seems to need an answer before we can address convincingly the issue of how poetic problems are solved. Is the problem the need to expand the initial point of inspiration, thus making the solution the act of writing? Or perhaps the problem is the poet’s need to “create” such that writing becomes the solution? These macro-level questions may seem unnecessary, except that we have a situation where the output under analysis seems to be *both* the problem and the solution. Plus, the lens through which we explore this output could well change our interpretation of what is involved in terms of process, so this is a highly pertinent philosophical and practical quandary that is ongoing in our own research.

A criticism of our study could be that we seem to be presenting evidence for the existence of a continuum of responses for the questions that we asked our interviewees, rather than evidence for either complete commonality across the poets or for binary differences. Why, then, are our participants answering differently? We have two main suggestions in this regard. First, we have what amounts to a small sample of poets, which can accentuate individual variability because of random factors. Second, we note that strict binary differentiation is rare within human behaviour, and usually implies some extreme biological basis (which we have no reason to expect) or some strong aspect of external behavioral reinforcement within society. In this latter respect, educational experience is one way through which society can provide reinforcement systems that ensure people are either very similar or very different, but our poets were largely self-taught and had only periodically engaged in writing partnerships and mentorships. Self-tuition, on the other hand, encourages idiosyncratic differences

to arise since individuals are reacting to their own random interactions with the world in the absence of a formalized education structure. As such, it may be the very lack of formal training in poetry writing that promoted a degree of variety in our participants' responses. Nevertheless, as was clear in our study, despite individual differences in poetic expression and approach there were certainly some dominant trends that cut across our sample.

To conclude, the current study represents a first step in the investigation of what we term "poetic design" – an area that is clearly wide open for future investigation. The data presented here suggest that there are aspects of striking commonality between poetry and design, and such similarities can hopefully be used to inform future studies.

Acknowledgements

This work was funded by a EU Marie Curie Framework 7 grant to DESIRE: Creative Design for Innovation in Science and Technology Network, EC Grant Number PITN-GA-2008-215446 and the Natural Sciences and Engineering Research Council of Canada. We would like to thank the poets for their time.

References

- Ball LJ, Christensen BT, (2009) Analogical reasoning and mental simulation in design: Two strategies linked to uncertainty resolution. *Design Studies* 30:169–186
- Ball LJ, Evans JStBT, Dennis I, Ormerod TC, (1997) Problem-solving strategies and expertise in engineering design. *Thinking and Reasoning* 3:247–270
- Ball LJ, Lambell NJ, Reed SE, Reid FJM, (2001) The exploration of solution options in design: A 'Naturalistic Decision Making' perspective. In Lloyd P, Christiaans H, (eds.), *Designing in Context*, Delft University Press, Delft, The Netherlands, 79–93
- Ball LJ, Maskill L, Ormerod TC, (1998) Satisficing in engineering design: Causes, consequences and implications for design support. *Journal of Automation in Construction* 7:213–227
- Ball LJ, Ormerod TC, Morley NJ, (2004) Spontaneous analogising in engineering design: A comparative analysis of experts and novices. *Design Studies* 25:495–508
- Casakin H, Goldschmidt G, (1999) Expertise and the visual use of analogy: Implications for design education. *Design Studies* 20:53–175
- Christensen BT, Schunn CD, (2007) The relationship of analogical distance to analogical function and pre-inventive structure: The case of engineering design. *Memory and Cognition* 35:29–38
- Cross N, (1990) The nature and nurture of design ability. *Design Studies* 11:127–140
- Cross N, (2001) Design Cognition: Results from protocol and other empirical studies of design activity. In Eastman C, McCracken M, Newstatter W, (eds.), *Design Knowing and Learning: Cognition in Design Education*, Oxford: Elsevier, 79–103
- Cross N, (2006) *Designerly Ways of Knowing*. London: Springer
- Curtis T, (ed.) (1996) *How Poets Work*. Wales: Seren/Poetry Wales Press Ltd, Bridgend
- Darke J, (1979) The primary generator and the design process. *Design Studies* 1:36–44
- Dorst K, Cross N, (2001) Creativity in the design process: Co-evolution of problem-solution. *Design Studies*, 22:425–437
- Eckert C, Stacey M, (2000) Sources of inspiration: A language of design. *Design Studies* 21:523–538
- Earthman, EA, (1992) Creating the virtual work: Reader's processes in understanding literary texts. *Research in the Teaching of English*, 26:351–384
- Eva-Wood AL, (2004) Thinking and feeling poetry: Exploring meanings aloud. *Journal of Educational Psychology* 96:182–191
- Groenendijk T, Janssen T, Rijlaarsdam, G, Van den Bergh H, (2008) How do secondary school students write poetry? How creative writing processes relate to final products. *Educational Studies in Language and Literature* 8:57–80
- Jansson DG, Smith SM, (1991) Design fixation. *Design Studies* 12:3–11
- Lloyd P, Scott P, (1995) Difference in similarity: Interpreting the architectural design process. *Environment and Planning B: Planning and Design* 22:383–406
- Maher ML, Poon J, Biulanger S, (1996) Formalising design exploration as co-evolution: A combined gene approach, in Gero JS, Sudweeks F, (eds.), *Advances in Formal Design Methods for CAD*, London: Chapman and Hall
- Mengert C, Wilkinson JM (2009) *12 x 12 Conversations in 21st Century Poetry and Poetics*. University of Iowa Press, Iowa City
- Peskin J, (1998) Constructing meaning when reading poetry: An expert-novice study. *Cognition and Instruction*, 16:253–263
- Poem, (2003) *Collins English Dictionary: Complete and Unabridged*
- Runco M, (2007) *Creativity - Theories and Themes: Research, Development, and Practice*. New York: Academic Press
- Schön DA, (1988) *Designing: Rules, types and worlds*. *Design Studies* 9:181–190
- Simon HA, (1973) The structure of ill structured problems. *Artificial Intelligence* 4:181–201
- Visser W, (2006) *The Cognitive Artifacts of Designing*. Mahwah, NJ: Lawrence Erlbaum Associates

Author Index

<i>Acuna, A</i>	265	<i>Goel, A K</i>	115
<i>Aoussat, A</i>	131	<i>Goldschmidt, G</i>	29,63
<i>Askland, H H</i>	183	<i>Gu, N</i>	183
<i>Ball, L J</i>	257,315	<i>Hain, K</i>	273
<i>Barlocchi, A</i>	297	<i>Helms, M</i>	115
<i>Beatty, E L</i>	315	<i>Howard, T J</i>	157
<i>Becattini, N</i>	289	<i>Huang, Y</i>	307
<i>Becker, B</i>	165	<i>Jimenez-Narvaez, L M</i>	241
<i>Bianchi-Berthouze, N</i>	131	<i>Jin, Y</i>	149
<i>Borgianni, Y</i>	289	<i>Kerne, A</i>	35
<i>Bouchard, C</i>	131	<i>Kim, J</i>	131
<i>Carnicero, L</i>	297	<i>Kim, Y S</i>	57,105
<i>Cascini, G</i>	289	<i>Koomsap, P</i>	323
<i>Chakrabarti, A</i>	49,123	<i>Kröper, M</i>	97
<i>Chan, J H</i>	89	<i>Lesage, A</i>	199
<i>Chaur, J</i>	297	<i>Lindberg, T</i>	97
<i>Chen, C</i>	149	<i>Lindemann, U</i>	23
<i>Chou, J Y</i>	209	<i>Linsey, J S</i>	35,165
<i>Choulier, D</i>	79	<i>Lloveras, J</i>	297
<i>Christian Bastien, J M</i>	199	<i>Maher, M L</i>	41
<i>Claudi, L</i>	297	<i>McMahon, C A</i>	157
<i>Collado-Ruiz, D</i>	71	<i>Meinel, C</i>	97
<i>D'souza, N S</i>	281	<i>Morimoto, K</i>	249
<i>Dekoninck, E A</i>	157	<i>Mougenot, C</i>	231
<i>Dorta, T</i>	199	<i>Nagai, Y</i>	3,9,139,215
<i>Fay, D</i>	97	<i>Nagasawa, Sachiko</i>	249
<i>Fraundorfer, M</i>	273	<i>Nagasawa, Shin'ya</i>	249
<i>García-Delgado, C</i>	297	<i>Ostad-Ahmad-Ghorabi, H</i>	71
<i>Gero, J S</i>	15	<i>Pérez, E</i>	199

<i>Rappl, C</i>	273	<i>Tseng, W S W</i>	257
<i>Risdiyono</i>	323	<i>Tversky, B</i>	209
<i>Rotini, F</i>	289	<i>Vattam, S</i>	115
<i>Saiz, M A</i>	297	<i>Wang, H-H</i>	89,307
<i>Sano, K</i>	215	<i>Watanabe, K</i>	231
<i>Segrera, A</i>	241	<i>Williams, A</i>	183
<i>Shin, J H</i>	105	<i>Wiltgen, B</i>	115
<i>Shin, Y K</i>	105	<i>Wormald, P W</i>	175
<i>Smith, S M</i>	35	<i>Yamada, K</i>	139
<i>Sosa, R</i>	265	<i>Yen, J</i>	115
<i>Srinivasan, V</i>	123	<i>Yue H</i>	157
<i>Taura, T</i>	3,9,139,215	<i>Zeiler, W</i>	191
<i>Tschimmel, K</i>	223	<i>Zouein, G</i>	149

Design by Customer: A Management of Flexibilities

Risdiyono^{1,2} and Pisut Koomsap²

¹ Islamic University of Indonesia, Indonesia

² Asian Institute of Technology, Thailand

Abstract. In order to satisfy customers, mass production system adopts the concept of Design for Customer where products are generated by translating identified customer needs into product specifications. When voice of majority is used, this system could not give optimum satisfaction to all customers as there will always be a gap between customer requirements and the design parameters. Some customers who may have individual specific needs are forced to relax their requirement and to accept the available product in the assortment. This paper proposes a new approach of Design by Customer to increase customer satisfaction by enabling customers to involve more in value creation. Customer involvement is believed as a way to reduce the gap between what customer really needs and what manufacturer can provide. Based on the practical example, it is concluded that the DbC concept is highly applicable depending on three aspects: customer need, manufacturing capability and engineering constraint.

Keywords: design by customer, customer satisfaction, flexible product specification

1 Introduction

The concept of manufacturer-centric product design and development in mass production system has been the mainstay of commerce for hundreds of years. In this traditional model, designers and engineers play the most significant role in identifying the product specifications while a user's only role is to have needs, which manufacturers then identify and fill by designing and producing new standard products (see Fig. 1) In this so called 'Design for Customer – DfC' environment, products are developed by manufacturer in a closed way and then the manufacturers usually use patents, copyrights, and other protections to prevent imitators from free riding on their innovation investment. However, empirical studies show that users are the first to develop many industrial and consumer products and about 10-40 percent engage in developing or modifying products (Hippel, 2005). The main reason is that customers in many cases need to make some modifications on the available products to fit their specific requirements. This fact depicts that

the manufacturers, due to the use of 'voice of majority' concept in identifying customer need, become imperfect agents in translating voice of customer into product specification as deviation will always exist in every translation process.

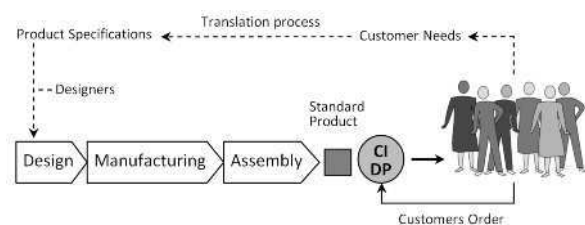

Fig. 1. Simplified view of mass production system

In order to make deviation as small as possible, an active customer involvement in value creation was then introduced. The term customization and personalization are commonly used to accommodate individual specific need (Duguay et al., 1997). A popular way of product customization is by configuration design, where customers can choose different components and assemble them together to form a product (Tseng and Du, 1998; Radder and Louw, 1999). Family Based Design (FBD), Product Family Architecture (PFA), modularization and product platform have been well recognized for this purpose (Jiao and Tseng, 1999). All the modules are pre-produced according to forecast demands (anticipative) to shorten delivery time. No inventory for final product is needed as assembly process is postponed until customer order comes. In this environment, the product design team does not translate customer needs into general design parameters but into product variety. The position of customer involvement decouple point (CIDP), a point where customer order arrives at the production cycle, is moved upstream in the value chain, so that customers' role is not only to have needs but also to configure/assemble their own product from available pre-defined parts. The simplified view of mass customization system can be found in Fig. 2.

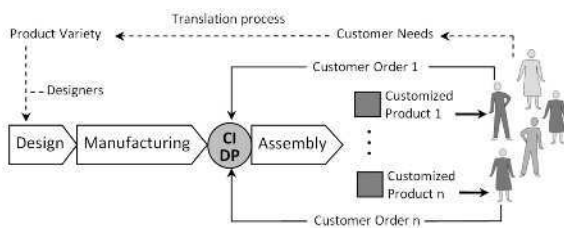

Fig. 2. Simplified view of mass customization system

In order for companies to increase the change that a wide range of customer requirements is satisfied, a larger product variety (solution space) is required. However, product variety does not guarantee that customers find exactly what they want. It is more likely that customer preferences can be matched with products existing in the assortment. Increased variety also means increased complexity and can make mass confusion (Piller, 2005).

Although in the mass product customization customer involvement is increased, the system still adopts Design for Customer concept as all the parts are designed by designers. Again, there will be a deviation between customer requirements and product specifications and (at the end) some customers are forced to relax their requirements and to accept the un-optimum final configuration. This will result in low level of customer satisfaction which is very important and considered increasingly becoming a key element of business strategy (Gitman and McDaniel, 2005).

This paper proposed a new approach of Design by Customer (DbC) which provides a very flexible product so that customers do not need to relax their requirements as the design parameters can be adjusted to meet the requirements. Customers are no longer only searching for goods which satisfy them but they can also involve in making their own design.

2 Design Dimensions

The term ‘design’ has many different meanings. To some it means the aesthetic design of product such as the external shape of a car and on the other hand, design can mean establishing the basic parameters of a system (Boothroyd et al., 1994). In this paper it refers to the process of originating and developing a plan for a product, structure, system, or component with intention. Noble and Kumar (2008) considered that design can be classified into three dimensions i.e. Utilitarian Design, Kinesthetic Design and Visual Design.

Utilitarian design focuses on the practical benefits a product may provide. This dimension attempts to achieve functional differentiation through making

products that simply work better in very tangible ways, including effectiveness, reliability, durability, safety and to other competitive advantages relative to other offerings like multi functionality and modular product architecture.

A kinesthetic design emphasizes how a user physically interacts with the product. One interesting aspect of this strategy is the ability to potentially enhance both functional differentiation and emotional value. For example, a tool with well-designed ergonomics can both do a job well, and feel comfortable and satisfying to the user. There are several tactics a firm can pursue to enhance the kinesthetic of their goods. Ergonomics is probably the best-understood concept in this group. Human factors is a related area, but focuses more explicitly on the precise measurement of the human body in order to develop more comfortable and enjoyable products and experiences.

Visual Design is probably the closest element aligned with what design means to most observers. Visual design is driven by form, color, size and the desire to communicate value to the consumer without necessarily interacting with the product. Visual design is mainly focused on the creation of emotional value.

Products can be classified based on the level of their design dimension contents as shown in Fig.3. Machinery for example, is considered as having high content of utilitarian design (performance, precision, speed, safety, etc.) as well as kinesthetic design (user friendly, easy to use, low noise, etc), whilst its visual design content is considered low (color, shape, etc.). In contrary, art product and decoration are classified as having low content of both utilitarian and kinesthetic design with high content of visual design. This classification method may also applicable to categorize all parts of a product to see what the most important part’s design dimension is. Fig. 4 shows the example of classification of notebook’s parts based on its design dimension contents.

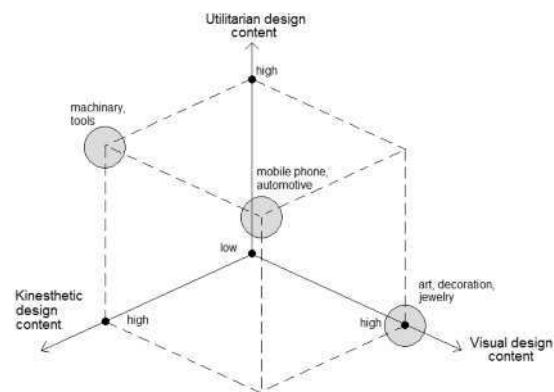

Fig. 3. Three dimensions of design content

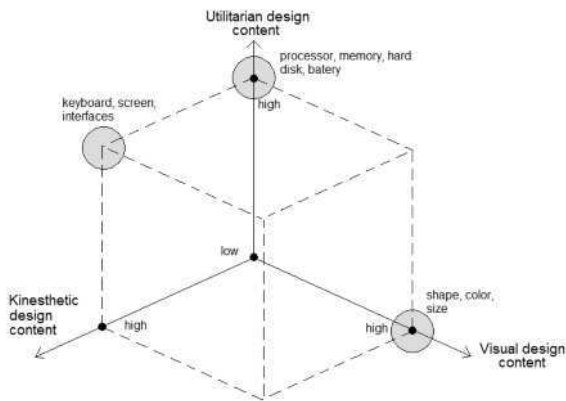

Fig. 4. Example of design dimension contents classification of notebook parts

3 Design by Customer as a Management of Flexibilities

Flexibility is considered as one of important aspects that customers consider in making buying decision. Anderson (2006) suggested giving customers flexibility in prices, service and delivery in order to increase market share. This paper proposes a flexibility in product specification, so that customers can specify their need by directly modifying the available product or designing by themselves. Customers should not be forced to relax their requirements but the product specifications should be adjustable. This means DbC concept tries to increase the flexibility level of mass customization by moving CIDP into the early stage of value chain activity to accommodate individual customer’s personal needs which neither mass production nor mass customization systems could fulfil (Fig. 5). As the decoupling point moves upstream in the value chain, the degree of flexibility is expected to increase because customers would have the possibility to involve in creating product at earlier stages.

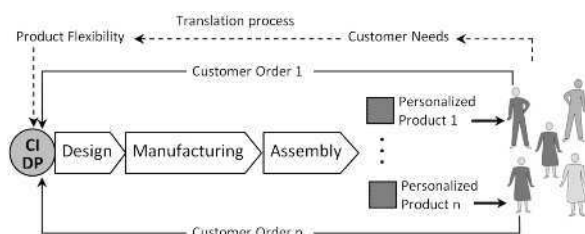

Fig. 5. Simplified view of DbC system

The decoupling point may not only influence the flexibility level but also cost and delivery time. If it is

closer to the customer, lower cost and shorter delivery times can be achieved. Accordingly, if it is placed at the beginning of the production process, it could be assumed that higher cost and longer delivery times would be necessary. Hence the challenge of DbC concept is to manage the product flexibility so that the product can be delivered in a comparable price and in an acceptable delivery time.

Norman (2004) argued that modifying purchased ready-made product is the popular way and the most widely followed method adopted by customers to satisfy their individual requirement. Newly constructed, identical-looking houses soon transform themselves into individual homes as their occupants change furnishings, paint, window treatments, lawn, adding rooms, changing garages, and so on. Modifying implies the activity of altering, changing, adding, removing some features from original product to form a new different one. However, there are always some parts kept in their origin form without any modification.

It is worthy to note that in design by customer system, customer refers to end user who may have a wide range of design ability and experience. Thus, the system should consider carefully the level of customer involvement in value creation. The critical questions are; how to involve customer as less as possible (to reduce complexity) but in the same time can increase customer satisfaction as much as possible? How to determine the level of customer involvement in value creation especially in defining which product’s features customers can customize or modify so that it can give maximum benefit for both manufacturer and customers?

As customers may have different background of expertise, allowing customer to modify some of parts is more practical than to design from scratch. Our needs are getting more complex in this ever-more technological, information-rich age, hence it is an impossible dream that many of us would possess the skills and time required to design and construct the products required in everyday life. From the manufacturer point of view, it is also difficult to quickly response customer requirements without any initial constraints. Hence the best way is to use a product structure analysis where a product is decomposed into many parts or sub-assemblies and then analyzed their level of flexibility; whether it is possible and valuable for customers to modify the parts or providing variety (mass customization) is enough.

The analysis is based on three aspects, including (1) customer need, (2) manufacturing capability and (3) engineering constraints. The first aspect deals with the question of ‘can we increase customer satisfaction by allowing them to modify or design the part?’ while

the last two focus on the investigation whether the modification will have problem in manufacturing process (manufacturability, production time, cost, etc.) and engineering-related issues (safety, stability, basic performance, etc). The general processes of the product structure analysis can be summarized as follows:

2. Decompose the product into many parts or subassemblies (chunks)
9. Analyze the flexibility of every chunk. When customer allowed to modify:
 - Can it increase customer satisfaction?
 - Is it easy (time and cost) to make?
 - Are there any engineering constraint?
10. Classify chunks based on their flexibility

Based on this analysis, a product may consist of some fix parts which due to some reasons are considered very difficult for both customer and manufacturer to modify; some may have high possibility to be modified or designed by customers; and others may fit for mass customization. A good product structure analysis will result in a good product with high flexibility without any problem in manufacturing and assembly.

4 Practical Implementation

Basically, the new concept of design by customer (DbC) introduced in this paper can be applied to all commercial products, of course with dissimilar flexibility level. Type of product, market demand, and manufacturer capacity are three important factors determining the product flexibility. In this research, wood-based table clock product is selected to be an example for the implementation of the proposed concept as it has all those three design dimensions. It should show the time accurately (utilitarian); easy to read, to adjust and to change battery (kinaesthetic); and good in appearance (visual). Fig. 6 shows the example of table clock product made from wood board and its main parts.

When product structure analysis is performed, all these three main parts should be carefully analyzed in order to get optimum flexibility. A market research to investigate whether the flexibility of each chunk can increase customer satisfaction is an important step to be conducted together with the analysis of manufacturing capability (ease to make, cost, time, etc.) and engineering constraints (stability, safety issues, etc.).



Fig. 6. Wood-based table clock and its decomposition

4.1. Customer need investigation

Customer needs can be investigated by using several method. In this practical example, customer needs were investigated by using simple questionnaire. The main purpose is to explore voice of customers on what flexibilities that can attract them more. Fig. 7 shows the result of questionnaire from 107 respondents where six features of design by customer concept on table clock making were investigated. Customers were requested to scale the attractiveness level of each feature which is set from 1 (not attractive) to 5 (very attractive). From this figure, it is observed that all features are considered having high attractiveness. Hence, offering flexibility to customer in designing and modifying shape, size and colour of table clock product using online system is promising.

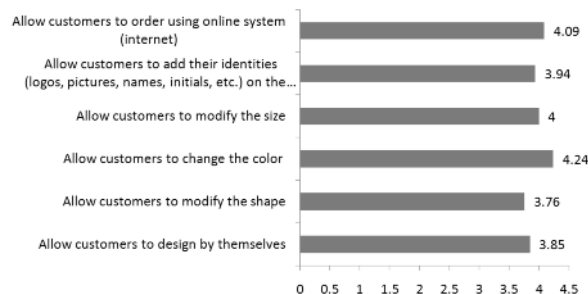

Fig. 7. Importance level of design by customer system's capabilities

4.2 Manufacturing Capability

This table clock consists of three parts i.e. insert clock, body and support. Each part has its own specific characteristic and design content which will affect the management decision on how flexible the part is. When it has been observed that adopting DbC concept in table clock product can create a significant effect on customer satisfaction, manufacturing capability is then investigated. Ease to manufacture, cost, and time are three important parameters to justify the level of manufacturing capability of every part. The body and

support have three properties including material, shape and color. It is highly possible to let customer design or modify these parts as available manufacturing system can support it. Time and cost are reasonably accepted as an automatic process is adopted (Fig. 8).

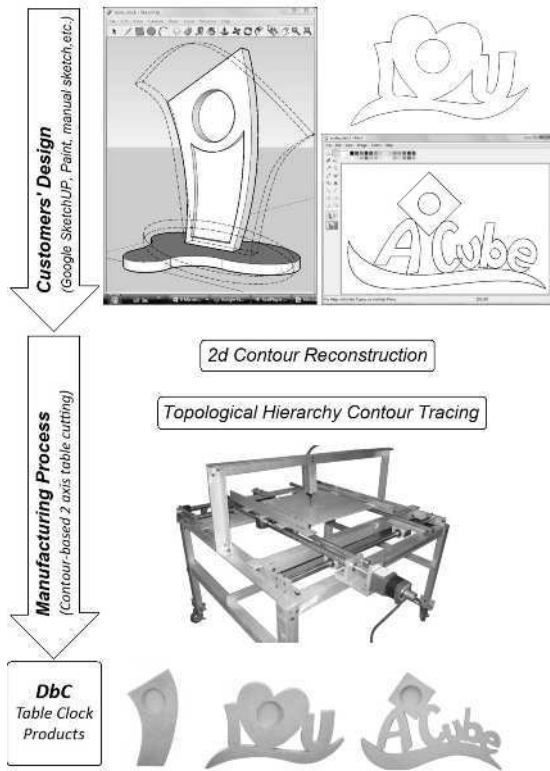

Fig. 8. General platform to manufacture DbC table clock

Considering that customers in this paper refers to end users who may have a wide variety of design experience, to enhance its flexibility the DbC system

should be capable to respond a variety of design inputs from customers. This wood-based table clock DbC system can accommodate some type of customer’s designs including those from Google SkethUp free software, Paint, paper-based sketch and any kind of CAD system. The inputs are then transformed into general format of 2D contour lines, traced later using topological hierarchy contour tracing. By using point-to-point (PTP) numerical control system XY table cutting, the parts are manufactured.

For insert clock, the optimum way for flexibility is by providing customers some variety of its model considering that it is provided by third party and has a very complicated functional design contents which may difficult for customer to design.

4.3 Engineering Constraints

Engineering constraints analysis is very important to avoid bad designs which may result in serious safety problems, terrible performance, instability, etc. Since table clocks can be categorized as decorative products where the interaction with the users is mainly based on visual contact, engineering constraints are not critical. When customer allowed to design, product stability problem may happen, but it is relatively easy to recognize.

By doing the analysis of these three aspects, the wood-based table clock product becomes very flexible as customer has possibilities to customize insert clock (many different designs), to modify the body and support (both shape and color) or even to initiate new design of them. Table 1 summarizes the example of flexibility analysis for this wood-based table clock product. Based on the aforementioned illustration, it is very clear that the concept of design by customer to increase customer satisfaction is basically an issue of

Table 1. Flexibility analysis of wood-based table clock

Parts	Design content	Product Structure Analysis			Solution for flexibility
		Can it increase satisfaction?	Is it easy to make?	Any engineering constraint?	
	Visual design (shape, size, finishing)	Yes, based on survey it is very attractive to modify (design) shape, size, colour, and also to add text and figure	Yes, this is a wood-based product which can be made from wood-board using simple 2D operation. Rapid Manufacturing is also possible	The size of hole is fixed (to insert the clock). It is possible that customer may design unstable products. However, it is easy to handle	Provide customers part variety and allow them to modify or design by themselves (CIDP : Mass Customization and Design by Customer)
	Functional (movement) and visual (case, bezel, dial, hands, color)	No, customer prefer to choose from assortment	No, the clock is made by third party and it is difficult to personalize	Yes, the clock system is very complicated	Allow customers to choose from available different designs (CIDP: Mass Customization)

management of flexibilities. The key concern is on how to optimize the product flexibility in order to reduce the gap between customer requirements and product specifications. Fig. 9 shows some examples of table clock product designed by customers.



Fig. 9. Examples of wood-based table clock DbC products

5 Conclusion

Design by customer (DbC) concept has been introduced in this paper as a management of flexibilities. The concept argues that customer satisfaction can be achieved when the gap between customer requirements and product specifications are kept as small as possible. Compared to the concept of design for customer (DfC) in mass production and mass customization, DbC provides better product flexibility where customers are not forced to adjust their requirement based on available inflexible product specification as the product specifications are adjustable to meet customer requirements. The practical illustration shows that the concept of DbC to provide flexible product is highly applicable depending on three aspects, i.e. customer needs, manufacturing capability and engineering constraints.

References

- Anderson C, (2006) *The Long Tail: Why the Future of Business Is Selling Less of More*. New York: Hyperion
- Boothroyd G, Dewhurst P, Knight W, (1994) *Product Design for Manufacture and Assembly*. New York: Marcel Dekker
- Duguay CR, Landry S, Pasin F, (1997) From mass production to flexible/agile production. *International Journal of Operations & Production Management* 17(12): 1183–1195
- Gitman LJ, McDaniel CD, (2005) *The Future of Business: The Essentials*. Mason, Ohio: South-Western
- Hippel E, (2005) *Democratizing Innovation*. London: The MIT Press
- Jiao J, Tseng MM, (1999) An Information Modeling Framework for Product Families to Support Mass Customization Manufacturing. *CIRP Annals - Manufacturing Technology* 48(1):93–98
- Noble CH, Kumar M, (2008) Using product design strategically to create deeper consumer connections. *Business Horizons* 51(5):441–450
- Norman DA, (2004) *Emotional design: why we love (or hate) everyday things*. New York: Basic Books
- Piller FT, (2005) Glossary: Mass Customization, Open Innovation, Personalization and Customer Integration in Frank Piller's Web Site on Mass Customization & Open Innovation. Available online at: <http://www.mass-customization.de/glossary.htm#mc>, accessed May 25, 2010
- Radder L, Louw L, (1999) Mass customization and mass production. *The TQM Magazine* 11(1):35–40
- Tseng MM, Du X, (1998) Design by Customers for Mass Customization Products. *CIRP Annals - Manufacturing Technology* 47(1):103–106