

Evolutionary Genetics

Second Edition

John Maynard Smith
School of Biological Sciences,
University of Sussex

OXFORD
UNIVERSITY PRESS

Disclaimer:

This book contains characters with diacritics. When the characters can be represented using the ISO 8859-1 character set (<http://www.w3.org/TR/images/latin1.gif>), netLibrary will represent them as they appear in the original text, and most computers will be able to show the full characters correctly. In order to keep the text searchable and readable on most computers, characters with diacritics that are not part of the ISO 8859-1 list will be represented without their diacritical marks.

Oxford University Press, Great Clarendon Street, Oxford OX2 6DP

Oxford New York

*Athens Auckland Bangkok Bogota Bombay Buenos Aires
Calcutta Cape Town Dar es Salaam Delhi Florence Hong Kong
Istanbul Karachi Kuala Lumpur Madras Madrid Melbourne
Mexico City Nairobi Paris Singapore Taipei Tokyo Toronto
and associated companies in
Berlin Ibadan*

Oxford is a trade mark of Oxford University Press

Published in the United States

by Oxford University Press Inc., New York

John Maynard Smith, 1998, reprinted 1999

All rights reserved. No part of this publication may be reproduced, stored in a retrieval system, or transmitted, in any form or by any means, without the prior permission in writing of Oxford University Press. Within the UK, exceptions are allowed in respect of any fair dealing for the purpose of research or private study, or criticism or review, as permitted under the Copyright, Designs and Patents Act, 1988, or in the case of reprographic reproduction in accordance with the terms of licences issued by the Copyright Licensing Agency. Enquiries concerning reproduction outside those terms and in other countries should be sent to the Rights Department, Oxford University Press, at the address above.

This book is sold subject to the condition that it shall not, by way of trade or otherwise, be lent, re-sold, hired out, or otherwise circulated without the publisher's prior consent in any form of binding or cover other than that in which it is published and without a similar condition including this condition being imposed on the subsequent purchaser.

A catalogue record for this book is available from the British Library

Library of Congress Cataloging in Publication Data

(Data available)

ISBN 0 19 850232 X Hbk

ISBN 0 19 850231 1 Pbk

Typeset by Footnote Graphics, Warminster, Wilts

Printed in Great Britain by Butler & Tanner Ltd, Frome

Preface to the Second Edition

The main difference between this and the first edition is the addition of a final chapter on the use of molecular data for the construction of phylogenetic trees. I have done this in response to suggestions from teachers who have used the book as a course text. There are, of course, several excellent computer packages into which one can, more or less mindlessly, plug one's molecular data, and recover a tree with mysterious 'bootstrap values' attached to it. I think it is important, therefore, that biologists should understand the logic underlying these packages, and this I have tried to explain. But I do urge them to remember that molecular data can be used to answer questions about the mechanisms of evolution, as well as about phylogeny.

I have also taken the opportunity to rewrite some sections that students have found confusing. The two chapters that seem to have caused most difficulty are those on the evolution of sex, and on evolutionary game theory. It is ironic that these are the topics on which I have concentrated my own research: perhaps I am too close to them to see the difficulties. In any case, I have rewritten both chapters, and hope that they are now easier to follow.

In general, the discussion of current areas of research in the first edition has stood the test of time rather well. I have expanded some sections, in particular those on the evolution of prokaryotes, and on parasitism and mutualism. Finally, I have corrected a few errors that crept into the first edition, for which I apologize.

J.M.S.
SEPTEMBER 1997

Preface to the First Edition

Ever since Darwin, the theory of evolution has been the main unifying idea in biology. It is natural selection that has made biological systems different from physical or chemical ones. Today, there is an increasing tendency for biology students to specialize either in molecular and cellular biology, or in the biology of whole organisms and populations. Some such specialization is perhaps inevitable, because no one can know everything: it is in any case better than the old division into botanists and zoologists. A course in evolution, however, should unite both streams. Much of molecular biology makes sense only in the light of evolution: the techniques of molecular genetics are essential to a population biologist.

This book is intended as a text for advanced undergraduates: I hope it will also be useful to graduate students. It aims to do two things. First, it provides a basic grounding in those aspects of genetics, both population and molecular, that are needed to understand the mechanisms of evolution. Secondly, it discusses a range of topics, from the evolution of plasmids and of gene families to the evolution of breeding systems and of social behaviour, upon which current research in evolution is mainly concentrated, and attempts to show how the basic principles discussed in the first part of the book can be applied. I am convinced that a proper training in science requires that undergraduates are confronted by the problems of contemporary science. Only then can they see science as an activity, and not as a body of received doctrine. In discussing contemporary problems, I have expressed my own point of view, but I have also given references in which alternative views are expressed.

This is a book about the mechanisms of evolution. It does not describe the techniques, molecular, biometric, or cladistic, whereby phylogenies can be reconstructed. It discusses palaeontology only to the extent needed to ask whether the fossil record demonstrates the existence of mechanisms, such as species selection, other than those deduced from a study of existing organisms.

Further Reading, References, and Definitions

At the end of each chapter, I give a short list of further reading. I have not attempted to give a complete list of references. There is an excellent bibliography of population genetics in Crow and Kimura (1970). I have, however, given references to particular sets of data quoted in the text, and of some classic papers: these are listed at the end of the book.

A number of technical words and phrases are printed in bold type when they first appear, and a short definition is given: the page numbers in the index referring to these definitions are also in bold type.

Some mathematical derivations, and additional factual materials on particular topics, have been set aside from the main text in boxes. You do not need to read the boxes to follow the main text, but some of the problems at the end of the chapters require that you do so.

Problems

The problems at the end of the chapters are an integral part of the book. Solving problems is the only way to learn population genetics. Answers, and an outline of how they were obtained, are given at the end of the book. If you get a different answer, you may be mistaken, or I may be mistaken, or there may be an ambiguity in the question. Obviously, I have tried to avoid the last two possibilities, but I cannot be sure that I have succeeded. I suspect that you will find the problems, or some of them, difficult, but I hope that you will enjoy doing them. Remember that you cannot expect to know the answer to a problem instantly, or merely by looking up the relevant page in the text: it may take time and effort. Those that require more mathematical skill, or extra knowledge, are marked \star . Some are open-ended, in the sense that they do not have a unique correct answer: this should be obvious from the question.

Computer Projects

At the end of most chapters, I have suggested a few computer projects. All these (with one exception that is indicated) can be carried out in BASIC on a micro-computer. I have used many of them as final-year assessment exercises for undergraduates studying population genetics at Sussex. For a student with little previous programming experience, a project should take up to six weeks to complete and write up, assuming the student is also attending lectures and practicals. I have sometimes stated that a problem is tricky to program: beginners should steer clear of them. Students without previous programming experience will need a fair bit of help to get started, and most students need some help in formulating the basic model.

Some of the projects are aimed at solving problems that can be solved analytically. This is not as silly as it sounds. Most theoreticians nowadays check their results by simulation, or use simulation to suggest results that might be provable analytically. Also, if you write a program to solve a problem that cannot be solved analytically, it is essential to check the program by running some special cases (e.g. a case with no selection) whose results are known analytically: otherwise there is no way of being sure that the program is doing what it is intended to do.

Background Knowledge

I have assumed some knowledge of genetics, mathematics, and statistics, as follows.

Genetics

Mendelian genetics, the chromosome theory and the nature of meiosis, sex-linked inheritance, the meaning of recombination in classical genetics. The structure and role of DNA, RNA, and protein as described in an elementary biology text. I have not assumed a knowledge of parasexual processes in prokaryotes (transformation, transduction, transposition), or of the nature and behaviour of reiterated DNA in eukaryotes: these matters are described in the text.

Mathematics

Elementary algebra, the manipulation of symbols, and the solution of simple equations. The use of x - y coordinates. The meaning of dx/dt as a rate of change. I have not assumed a knowledge of integration, how to solve differential or difference equations, partial differentiation, or of matrix algebra: but a knowledge of these topics would be of great value if you plan to pursue evolutionary genetics further. But to paraphrase Mr Truman, if you can't stand algebra, keep out of evolutionary biology.

Probability and Statistics.

The first requirement for a population geneticist is an ability to calculate probabilities. Plenty of practice in doing this is provided by the problems at the ends of chapters. But I do assume you know how to use the concept of probability. The following ideas are made use of in the text (usually with a brief explanation): the binomial theorem of probabilities, the Poisson distribution, the normal or Gaussian distribution, the meaning of statistical significance, the χ^2 test, means, variances, covariances, and regression. Clearly, therefore, it would be well to attend a course in probability and statistics before reading this book.

One final word. Forty years as a biologist, and five years before that as an engineer, have convinced me that the main difficulty one faces in a subject like population genetics (or mechanics) is not the mathematics itself, or the biology itself: it is how to fit them together. The only way one can learn to make useful models of the world, whether one is designing an aeroplane or studying the evolution of altruism, is by doing it: in practice, that means by solving problems. The problems and computer projects are intended to help you to acquire the necessary skills.

J.M.S.
UNIVERSITY OF SUSSEX
6 APRIL 1988

Contents

1	3
Evolution by natural selection	
Darwin's theory	3
Evolution <i>in vitro</i>	4
Lamarck, Weismann, and the central dogma	8
Further reading	12
Problems	12
Computer projects	13
2	15
Models of populations	
Models of population growth	15
Selection in an asexual population	17
The accuracy of replication	20
Genetic drift in finite populations	24
Further reading	27
Problems	27
Computer projects	28
3	31
Evolution in diploid populations	
Gene frequencies and the Hardy-Weinberg ratio	31
The concept of fitness	36
The spread of a favourable gene	38
Further reading	45
Problems	45
Computer projects	46

4		<u>49</u>
The variability of natural populations		
The evidence for genetic variability		<u>49</u>
Mutation		<u>53</u>
The maintenance of variation		<u>64</u>
Further reading		<u>76</u>
Problems		<u>76</u>
Computer projects		<u>77</u>
5		<u>81</u>
Evolution at more than one locus		
Linkage disequilibrium		<u>81</u>
Heterostyly in plants		<u>84</u>

Mimicry in butterflies	<u>85</u>
Linkage disequilibrium in natural populations	<u>87</u>
Normalizing selection and linkage disequilibrium	<u>88</u>
Further reading	<u>90</u>
Problems	<u>90</u>
Computer projects	<u>91</u>
6	<u>93</u>
Quantitative genetics	
Nature and nurture	<u>93</u>
The additive genetic model	<u>95</u>
A more realistic model	<u>108</u>
Experiments in artificial selection	<u>113</u>
Quantitative variation and fitness	<u>117</u>
The maintenance of genetic variation for quantitative traits	<u>118</u>
Further reading	<u>121</u>
Problems	<u>121</u>
Computer projects	<u>122</u>
7	<u>125</u>
A model of phenotypic evolution	
The hawk-dove game <small>梲</small> model of contest behaviour	<u>125</u>
Asymmetric games	<u>128</u>
More than two pure strategies	<u>130</u>
Continuously varying strategies	<u>131</u>
Will a sexual population evolve to an ESS?	<u>134</u>
Further reading	<u>135</u>
Problems	<u>135</u>

Computer projects	<u>136</u>
8	<u>139</u>
Finite and structured populations	
Inbreeding	<u>139</u>
Genetic drift	<u>143</u>
The rate of neutral molecular evolution	<u>146</u>
Mitochondrial DNA	<u>151</u>
Migration and differentiation between populations	<u>154</u>
The establishment of a new favourable mutation	<u>159</u>
Further reading	<u>160</u>
Problems	<u>160</u>
Computer projects	<u>160</u>
9	<u>163</u>
Evolution in structured populations	
Selection in trait groups	<u>163</u>
The evolution of co-operation: synergistic selection	<u>164</u>
The evolution of co-operation: relatedness	<u>167</u>
The group as the unit of evolution	<u>173</u>
The shifting balance theory	<u>179</u>

Further reading	<u>180</u>
Problems	<u>181</u>
Computer projects	<u>182</u>
10	<u>185</u>
The evolution of prokaryotes	
The evolution of gene function	<u>185</u>
Phages, plasmids, and transposable elements	<u>187</u>
The evolution of phages and their hosts	<u>189</u>
The evolution of plasmids	<u>190</u>
The evolution of transposons	<u>192</u>
The population genetics of <i>E. coli</i>	<u>194</u>
The evolution of viruses	<u>195</u>
Further reading	<u>198</u>
Computer projects	<u>199</u>
11	<u>201</u>
The evolution of the eukaryotic genome	
The nature of the genome	<u>201</u>
The haemoglobin gene family	<u>203</u>
Duplication and the increase of DNA content	<u>207</u>
The ribosomal genes	<u>209</u>
Unequal crossing over and gene conversion	<u>210</u>
Repetitive DNA	<u>213</u>
The evolution of chromosome form	<u>219</u>
Further reading	<u>223</u>
Computer projects	<u>223</u>
	<u>225</u>

12

The evolution of genetic systemsI. Sex and recombination

The natural history of sex 225

Why not be a parthenogen? 230

The advantages of sex 234

The evolution of recombination 241

Further reading 248

13

The evolution of genetic systemsII. Some consequences of sex

The sex ratio 251

Selfing and outcrossing 255

Hermaphroditism 255

Sexual selection 258

Further reading 263

Problems 263

Computer projects 264

14	<u>267</u>
Macroevolution	
Species and speciation	<u>267</u>
Patterns of evolution	<u>274</u>
Coevolution	<u>285</u>
Further reading	<u>296</u>
Problems	<u>296</u>
Computer projects	<u>297</u>
15	<u>300</u>
Reconstructing evolutionary history	
How to construct a phylogenetic tree	<u>300</u>
The reliability of trees	<u>303</u>
What use are phylogenetic trees?	<u>305</u>
Further reading	<u>306</u>
Answers to problems	<u>307</u>
References	<u>315</u>
Index	<u>323</u>

To Carol and S閙

**Chapter 1—
Evolution by Natural Selection**

Darwin's theory	3
Evolution <i>in vitro</i>	4
Lamarck, Weismann, and the central dogma	8
Further reading	12
Problems	12
Computer projects	13

Darwin's Theory

In *The Origin of Species*, Darwin argued that all existing organisms are the modified descendants of one or a few simple ancestors that arose on Earth in the distant past. We now know, over 3000 million years ago. He also argued that the main force driving this evolutionary change was natural selection. The argument is as follows. Living organisms multiply, and would increase indefinitely were not their numbers limited by death. Organisms also vary, and at least some of the variation affects their likelihood of surviving and reproducing. Finally, organisms have the property of 'heredity': that is, like begets like. The essential feature of heredity is illustrated in Fig. 1.1. Notice that heredity can be defined only for entities that both multiply and vary. We do not think of a rock, which is the same today as it was yesterday, as having heredity, because it does not multiply. But multiplication and variation are not sufficient. Fire multiplies, provided that fuel is supplied, and it varies, but it does not have heredity, because the nature of a fire depends on its present 'environment'—fuel, wind, etc.—and not on whether it was lit by a match or a cigarette lighter.

Darwin, then, argued that organisms do in fact multiply and vary, and that they have heredity, and that, in consequence, populations of organisms will evolve. Those organisms with characteristics most favourable for survival and reproduction will not only have more offspring, but will pass their characteristics on to those offspring. The result will be a change in the characteristics present in the population. The evolutionary change does not require that any individual should change, although it does require that new variants arise in the process of reproduction, because otherwise the essential variability of the population would disappear.

The theory of natural selection not only predicts evolutionary change: it also says something about the kind of change. In particular, it predicts that organisms will acquire characteristics that make them better able to survive and reproduce in the environment in which they live. That is, it predicts the adaptation of organisms

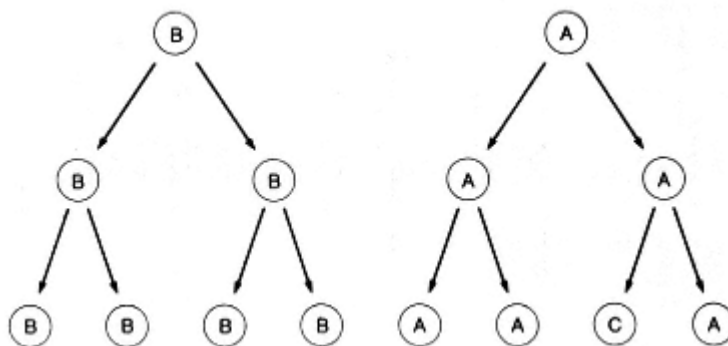

Figure 1.1

Heredity and variation. The meaning of heredity is that, when multiplication occurs, like gives rise to like: A gives rise to A, and B to B. Variation requires that this rule is occasionally broken, as when A gives rise to C.

to their environments. Of course, Darwin was well aware that organisms are adapted before he thought of his theory: adaptation is the most obvious and all-pervasive feature of living things, and one that any theory of evolution must explain. One of the main strengths of Darwin's theory is that it does explain adaptation: as we shall see, its only serious rival, the Lamarckian theory, cannot do so.

There are, however, obvious inadequacies in the theory illustrated in Fig. 1.1. In particular:

1. The figure defines heredity, but says nothing about its mechanism. In fact, organisms are not replicated in the process of reproduction. They die, and only their gametes are passed on. Modern genetic theory asserts that the only thing that is exactly replicated is the information in the DNA (or, in some viruses, the RNA): other structures must develop anew in every generation. (Some possible exceptions are discussed below.)
2. The figure implies that each individual has only one parent. In higher organisms, biparental sexual reproduction is typical, although not universal. Even in prokaryotes, DNA from different ancestors may come together in a single descendant.

In brief, Fig. 1.1 ignores the phenotype-genotype distinction, and it ignores sex. A large part of this book is concerned with these two complicating factors. First, however, I discuss some experiments in which sex is absent, and in which the distinction between genotype and phenotype, although not wholly absent, is minimal. These experiments concern the evolution of RNA molecules *in vitro*.

Evolution *in vitro*

There is an RNA virus, Q β , that infects the bacterium *Escherichia coli*. The virus genome codes for an enzyme β replicase that replicates RNA. The enzyme

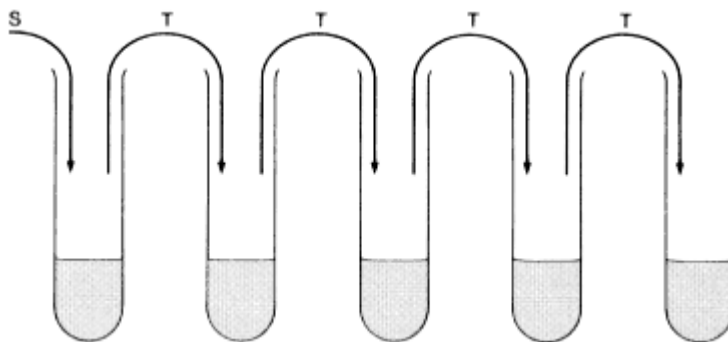

Figure 1.2

The evolution of RNA molecules *in vitro*. Initially, each test tube contains a solution of the four nucleotides—ATP, GTP, UTP, and CTP—from which RNA is made, and an enzyme that will replicate RNA. RNA molecules are added as a seed (S) to the first tube. After 30 min, a drop of solution is taken from the first tube, and added to the second (T); after a further 30 min, a drop is taken from the second tube, and added to the third, and so on.

works well *in vitro*, and will replicate almost any RNA molecule in a test-tube, if it is provided with the four necessary monomers from which RNA is made—ATP, GTP, UTP, and CTP. Hence one can follow the evolution of a population of RNA molecules *in vitro*. The experimental system is shown in Fig. 1.2. A primary RNA template is added to a test-tube containing Φ replicase and the four monomers. After about 30 min, a small fraction of the contents of the tube is withdrawn and added to a second tube: this process can be repeated for 100 or more transfers.

If replication was exact, the RNA molecules present after 100 transfers would be identical to the original template. But replication is not exact. The probability that a 'wrong' base—that is, one not complementary to that in the strand being copied—will be incorporated is about 1 in 10 000, per base, per replication. Other errors also occur, when part of a strand is not copied at all (deletion), or is copied twice (duplication). There is therefore variation upon which selection can act. But why should one RNA strand be better or worse than another? There are two reasons. One rather boring reason is that, within limits, short strands are replicated faster than long ones. A more interesting reason is that RNA molecules have a three-dimensional structure, because a molecule bends back on itself, forming hairpin-like structures held together by pairing between complementary bases. This is illustrated in Fig. 1.3, which shows the secondary structure of a molecule 218 bases long which, because of its secondary structure, is replicated particularly rapidly by Φ replicase.

Experiments of the kind shown in Fig. 1.2, then, ought to lead to Darwinian evolution, and they do. After a number of transfers, the initial template molecules are replaced by a population of molecules, similar or identical to one another, and replicating much more rapidly. Of particular interest are experiments in which no initial template molecules are added. One might then suppose that, with nothing

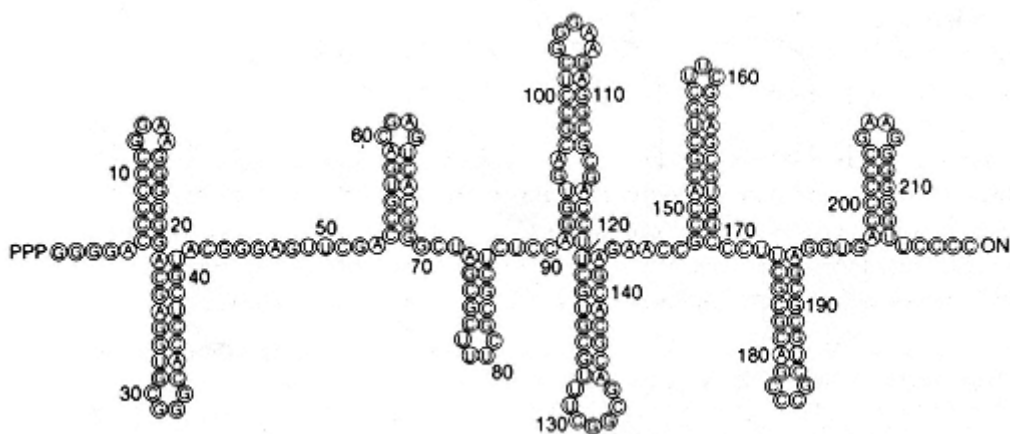

Figure 1.3
An RNA molecule that evolved *in vitro*. (From Orgel 1979.)

for the enzyme to copy, nothing would happen. However, after a substantial time delay, very short RNA templates, consisting of only a few nucleotides, do appear, and their length increases in subsequent transfers. (There is some controversy about whether the initial oligomers really appear *de novo*, by linking monomers, or whether they are present as impurities, but this is unimportant in the present context.) Evolutionary change finally comes to a halt. The nature of the final population depends on experimental conditions—for example, ionic composition of the medium, and presence of inhibitory drugs. For any particular set of conditions, however, the length and sequence of the final population is repeatable. The molecule in Fig. 1.3 is one such end-point. It also closely resembles a molecule, known as a minivariant, that is found naturally in *E. coli* infected by the Φ virus. How does this minivariant come to exist in nature? It could not multiply by itself in *E. coli*, if only because it does not code for a replicase. However, if a cell is infected by a functional Φ virus, the minivariant can exist as a kind of super-parasite, relying on the replicase coded for by the virus, which itself relies on many enzymes coded for by the host bacterium. The *in vitro* experiment repeats, in a test-tube, the evolutionary process that gives rise to the minivariant in nature.

The first moral to be drawn from these experiments is that natural selection can produce highly improbable results. There are 4^{218} , or 10^{128} , different RNA molecules 218 bases long. The one illustrated in Fig. 1.3 is unique in being the one replicated most rapidly by Φ replicase in the conditions of the experiment. How have we been able to produce this one unique sequence so quickly? Thus, there are approximately 10^6 RNA molecules in a test-tube just before transfer. After 100 transfers, we have tried out at the most 10^8 molecules. We seem to have been very lucky to have hit the optimal sequence so soon. If we could look at 10^6 molecules every half hour, each one different from every other, it would take 10^{107} years to have a reasonable chance of finding the uniquely best one.

It is a fallacy to imagine that natural selection works by trying out, at random, all possible phenotypes until, by chance, it hits on the best one. Instead, natural selection is a process analogous to hill-climbing, in which the best phenotype is reached by a series of steps, each step leading to a type that is fitter than the previous one (the precise meaning of 'fit' is discussed in Chapter 3). Applied to the *in vitro* experiment just described, this concept of hill-climbing implies the following. The process started with a short random sequence A, and ended with a unique sequence Z that is replicated particularly rapidly. For this to happen, there must be a series of intermediates, A-B-C-...-M-N-...-Z, such that:

1. Each step or example, M-N can arise by a single mutation that is, a base substitution, deletion, or duplication.
2. Each step increases replication rate. There could be some debate about whether a few of the steps could be 'neutral', in the sense of neither increasing nor decreasing replication rate, but the calculations in the last paragraph show that if most steps were neutral we would never arrive at Z.
3. The total number of steps is not very great. Note that, by base substitution, one can travel from any RNA molecule n bases long to any other of the same length in a maximum of n steps, although there is no guarantee that all the steps would be improvements.

If these conditions hold, the population will evolve from A to Z reasonably quickly. The fact that the *in vitro* experiments do repeatedly lead to the same end-point can be taken as evidence that, in this case, the three necessary conditions do hold. However, it is worth noticing that the end-point or example, the molecule of Fig. 1.3 may not be, as implied above, the uniquely best sequence. Thus it may be that, starting from A, there is an uphill path to Z, but that there is some other molecule, say OPT, which is replicated even more rapidly than Z, but which cannot be reached by hill-climbing from A, because to reach OPT would require the simultaneous incorporation of several mutations, each by itself deleterious.

These *in vitro* experiments, then, do illustrate the power of natural selection to generate the improbable. However, they have limitations as models of evolution. First, it is in a way disappointing that evolutionary change comes so quickly to a halt. In the real world, evolution seems to continue indefinitely. What is needed if this is to be so? This question is harder than it looks: it will be discussed briefly in the last chapter. A more immediate limitation lies in the absence of a clear distinction between phenotype and genotype, and of a process of development. In a sense, the genotype of an RNA molecule is its base sequence, and its phenotype is its three-dimensional structure. The analogue of development is then the process of folding. This is correct, but the situation is too simple to provide an adequate background for discussing the main alternative to Darwinism, which is the theory commonly referred to as Lamarckism, discussed in the next section.

The point of describing these *in vitro* experiments is to illustrate three fundamental ideas:

1. A population of entities (in this case, molecules) that have the properties of multiplication, variation and heredity will evolve so that they are better adapted to survive and reproduce.
2. This process of natural selection can give rise to structures whose probability of arising by chance in a single step is vanishingly small.
3. The process is analogous to hill-climbing. It doesn't work if there is no hill to climb: that is, if there is no series of intermediate steps leading to the summit.

Lamarck, Weismann, and the Central Dogma

The theory that today goes under the name of Lamarckism is a much modified version of the views of the French biologist Lamarck (1744-1829). We cannot simply dismiss this theory as false, for two reasons. First, it is not so obviously false as is sometimes made out. Secondly, it is the only alternative to Darwinism as an explanation of the adaptive nature of evolution. The idea is as follows. During its life, an organism may adapt to its environment. The classic, and convenient, example is that a blacksmith develops arm muscles appropriate to his trade. Other examples are that humans living at high altitudes produce more red blood cells, that humans acquire immunity to diseases to which they are exposed, and that they learn to drive on the correct side of the road. All these changes make them better able to survive, and all are responses to a particular environment during an individual lifetime. If this kind of adaptation is to be relevant to evolution, the changes that occur in an individual must have some effect on the nature of its offspring. If they do, this will contribute to the evolution of new and improved adaptations.

Darwin accepted this possibility, under the term 'the effects of use and disuse', although he thought that natural selection was a more important cause of evolution. When he said that he rejected Lamarck's views, it was not this idea he was rejecting, but Lamarck's belief that organisms have an inherent drive to evolve into higher and more complex forms. Darwin saw, correctly, that to explain the evolution of complexity in this way is like explaining the fact that the universe is expanding by saying that it has an inherent tendency to get bigger. The Lamarckian theory of the inheritance of acquired characters was explicitly rejected by August Weismann (1834-1914). He claimed (Fig. 1.▲) that, starting from the fertilized egg, there are two independent processes of cell division, one leading to the body or 'soma', and the other the 'germ line' leading to the gametes that form the starting point of the next generation. Of these two cell lines, the soma will die, but the germ line is potentially immortal.

Weismann's central claim was that the germ line is independent of changes in

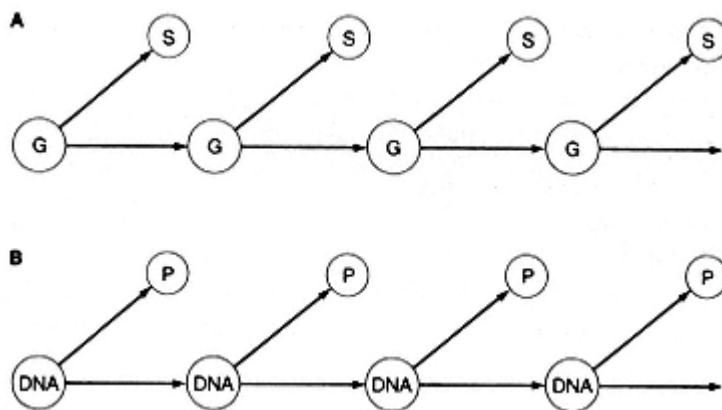

Figure 1.4
Weismann and the central dogma.

the soma. If this is true, then acquired characters cannot be inherited. But it is not clear why he thought it was true. He did point out that in most animals—for example, vertebrates and insects—the primordial germ cells that will give rise to the gametes are set aside early in development. This is true enough: if the primordial germ cells are absent, or are destroyed, they cannot be replaced, and the animal is sterile. However, this does not prove Weismann's point, for two reasons. First, in higher plants there is no independent germ line: any cell in a growing shoot can give rise to gametes. Yet the non-inheritance of acquired characters is held to be as true of plants as of animals. Secondly, the energy and material needed for the production of gametes are provided by the rest of the body, so there are opportunities for the soma to influence the germ line. In fact, Weismann's insight was to realize that what is relevant is the passage, not of material or energy, but of information. In effect, he could not see how the large muscles of a blacksmith could so influence the sperm he produced that his sons would develop large muscles. That Weismann saw that the problem is one of information transfer is shown by his remark 'If one came across a case of the inheritance of an acquired character, it would be as if a man sent a telegram to China, and it arrived translated into Chinese.'

Today, we would express Weismann's argument in molecular terms. Figure 1.4B shows the 'central dogma' of molecular biology, which asserts that information can pass from DNA to DNA, and from DNA to protein, but not from protein to DNA. By 'information' is meant the base sequence of DNA, which is transmitted to new DNA molecules in the process of replication, and which specifies the amino-acid sequence of proteins in the process of translation.

It is important to be clear about what is being asserted by the central dogma. It is not true that DNA can replicate without proteins: enzymes are needed. Further, changes in enzymes can alter the way in which a particular DNA sequence is translated. What does seem to be true, however, is that, if a protein with a new

amino-acid sequence is present in a cell, it cannot cause the production of a DNA molecule with the corresponding base sequence. Notice that this is not a logical necessity. Machines that translate information can sometimes work both ways: a tape recorder can translate sounds into magnetic patterns on a tape, and vice versa. But some machines translate only in one direction: you cannot cut a record by singing into the speaker of a record-player. The central dogma claims that the relation between nucleic acids and proteins resembles a record-player, and not a tape recorder.

The fact that information passes from DNA to protein through an RNA intermediate complicates the argument, but does not alter the essentials. There are RNA viruses that code for an enzyme called reverse transcriptase that can copy RNA base sequences into DNA. This means that the flow of information is as in Fig. 1.5.

If the central dogma is true, and if it is also true that nucleic acids are the only means whereby information is transmitted between generations, this has crucial implications for evolution. It would imply that all evolutionary novelty requires changes in nucleic acids, and that these changes are essentially accidental and non-adaptive in nature. Changes elsewhere in the egg cytoplasm, in materials transmitted through the placenta, in the mother's milk might alter the development of the child, but, unless the changes were in nucleic acids, they would have no long-term evolutionary effects. The rest of this book is based on the assumption that this neo-Darwinist picture is correct. But first, I review some contexts in which the assumptions are dubious, or actually false.

1. *Cell differentiation.* The cells of higher organisms are differentiated. For example, fibroblasts, epithelial cells, leucocytes, and so on. The differences between these cells are hereditary, in the sense defined in Fig. 1.1; that is, they are stable through many cell divisions. However, with a few exceptions (e.g. in the immune system), the differences are not caused by differences in DNA

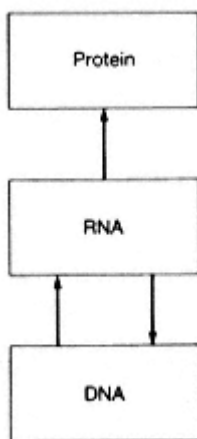

Figure 1.5
The flow of information in the genetic system.

base sequence, but by different states of activation of genes. Typically, these different states are abolished (or were absent in the germ line) when gametes are produced. However, we cannot rule out the possibility that some changes in gene activation might be transmitted in sexual reproduction. The members of a clone of *Daphnia* can have different morphologies: for example, they develop spines in the presence of predators. The change in morphology is adaptive; it occurs in response to an environmental stimulus; and once it has occurred, it is transmitted through the egg. Almost certainly, it is caused by changes in gene activation and not by changes in the base sequence.

2. *Changes in gene amplification.* Perhaps the clearest example of Lamarckian inheritance occurs in flax (*Linum*). If flax plants are treated with high levels of fertilizer, their morphology changes (Cullis 1983). These changes persist for a number of sexual generations (although not indefinitely) in the absence of the fertilizer treatment. It turns out that, in the cells of the modified plants, some DNA sequences (including ribosomal genes) are present in a higher number of copies. Thus the changes involve gene amplification, but probably not the appearance of new sequences.

3. *Cortical inheritance in ciliates.* The surfaces of ciliated protozoa contain complex patterns of cilia. If the pattern in an individual is changed, either accidentally or by surgical interference, the new pattern may be transmitted through many binary fissions. This transmission occurs independently of any change in nuclear DNA. It seems that there is a second hereditary mechanism, not dependent on nucleic acids, and subject to Lamarckian effects: a possible mechanism is described by Sonneborn (1970). It is not known whether any comparable mechanism exists outside the ciliates.

4. *Cultural inheritance.* If an animal learns where the water-holes are, or what plants are safe to eat, this information may be transmitted to its offspring, and to more distant descendants. In our own species, cultural inheritance is the basis of historical change.

To summarize, the strict assumptions of neo-Darwinism are contradicted by transmissible states of differentiation, by transmissible gene amplification, and by the existence of alternative hereditary mechanisms (cortical inheritance, cultural inheritance) not dependent on nucleic acids. How does this affect evolution theory?

Much the most important modification arises from cultural inheritance, because the traits that are acquired during a lifetime and then transmitted are often adaptive in nature: an animal that knows which berries are edible is more likely to survive. Given sufficient capacity for learning and cultural communication, a population can adapt to its environment by non-genetic means. The mechanisms of history and of evolution are so different that it is best to distinguish clearly between them. However, they may interact.

Other alternative hereditary mechanisms, and in particular cortical inheritance, are of less importance, because they are not adaptive: that is, the change occurring in an individual's life does not, in general, improve survival.

The significance of the experiments with flax is harder to evaluate. It is not clear that the morphological change adapts the plant to increased fertilizer, but it may well do so. If so, we are looking at an adaptation of the genetic system itself, enabling a parent plant to produce seedlings adapted to a changed environment. Until we know more of the molecular mechanisms involved, it is hard to decide how common processes of this kind may prove to be. However, if the morphological change is indeed adaptive, the genetic system responsible for the gene amplification and its transmission must itself have evolved by natural selection.

There remains the question why Lamarckian inheritance is not more common than it is: the examples given above are the best there are, and they are atypical. The short answer is that Lamarckian inheritance is rare because the central dogma is true, and because nucleic acids are overwhelmingly the most important carriers of genetic information. That, however, is to give an explanation in terms of genetic mechanisms. We would like also to know why the genetic mechanism is like that. If a tape recorder can be designed to transmit information in both directions, surely a genetic mechanism with a two-way flow of information from phenotype to genotype as well as from genotype to phenotype would have evolved. The answer is that most phenotypic changes (except learnt ones) are not adaptive: they are the result of injury, disease, and old age. A hereditary mechanism that enabled a parent to transmit such changes to its offspring would not be favoured by natural selection.

Further Reading

Darwin, C. (1859). *On the origin of species*. Murray, London.

Problems

The following problems are based on Dawkins' (1986) computer model of evolution by natural selection. They provide good practice in calculating probabilities. They also illustrate the power of selection to generate highly improbable results. (Two hints about calculating probabilities. First, if you can't calculate the probability that something will happen, calculate the probability that it won't. Secondly, a useful approximation: $(1 - x)^n \cong e^{-nx}$, if x is small and n is large.)

Dawkins models the evolution of the message 'METHINKS IT IS A WEASEL'. For simplicity, ignore spaces, and let the 'correct' 19-letter message be 'METHINKSITIS.AWEASEL'. Start with a single 19-letter message, in which each letter is randomly chosen from the 26 letters.

1. How many such messages are there?
2. What is the probability that (a) at least one of the 19 letters is correct, (b) exactly one letter is correct?

Ten copies are made of the original message. In copying each letter, there is a chance of 99/100 of incorporating an unchanged letter, and of 1/100 of incorporating a changed letter (a 'mutation') which may, with equal probability, be any one of the other 25 letters.

1. Suppose that, in the original sequence, none of the letters matched the correct message. What is the probability that, in at least one of the 10 copies, at least one letter does match the message?

The best of the 10 copies (that is, the copy that matches the required message at the largest number of sites) is chosen as the 'parent' of the next generation: if two or more copies match at the same number of sites, one is chosen at random. This parent is used to generate 10 more copies, in the same way.

4. If the original sequence did not match the correct message at any sites, approximately how many generations will pass before a message matching at least one site is obtained?

5. Sooner or later, a message correct at 18 out of 19 sites will be obtained. What is the probability that, among the 10 copies of such a message, one will be correct at all 19 sites?

6. What, in your opinion, is the least realistic feature of this model, regarded as a model of evolution by natural selection?

Computer Projects

Simulate Dawkins' 'METHINKSITISAWASEL' model of evolution, as described in the problem above. How long does it take to evolve from 0 to 19 correct letters? Modify it to allow for recombination. For example, keep two sub-populations of n messages. Once every r generations, take the best message from each population, and generate two new sub-populations by recombination between them. Does such a population evolve faster than a single population of $2n$ individuals, from which two are selected every generation?

**Chapter 2—
Models of Populations**

Models of population growth	15
Selection in an asexual population	17
The accuracy of replication	20
Genetic drift in finite populations	24
Further reading	27
Problems	27
Computer projects	28

The *in vitro* experiments described in the last chapter demonstrated that evolution occurs in a population of entities that have heredity. In this chapter, I develop some simple models of population growth and evolutionary change, aimed at answering the following questions:

1. In what circumstances will one type replace another selectively?
2. Can selection lead to the evolution of two different but coexisting types?
3. How accurate must the hereditary process be?

Models of Population Growth.

Imagine a population growing asexually, by binary fission. For example, a population of bacteria. Suppose that, at time t , the population contains x individuals, and that we can watch one of these for a short time δt . Let the probability that it will divide during that time be $r\delta t$: for the present, assume that r is constant. Then the increase in the number of individuals is

$$\delta x = r\delta t \cdot x. \quad (2.1)$$

As $\delta t \rightarrow 0$, this equation can be replaced by the differential equation,

$$dx/dt = rx, \quad (2.2)$$

of which the solution is

$$x = x_0 e^{rt}, \quad (2.3)$$

where x_0 is the number of individuals at time $t = 0$.

Taking logarithms of both sides, this becomes

$$\ln x = \ln x_0 + rt. \quad (2.4)$$

That is, if we plot the natural logarithm of the number against time, we get a straight line with slope r is called the intrinsic rate of increase. Because of this

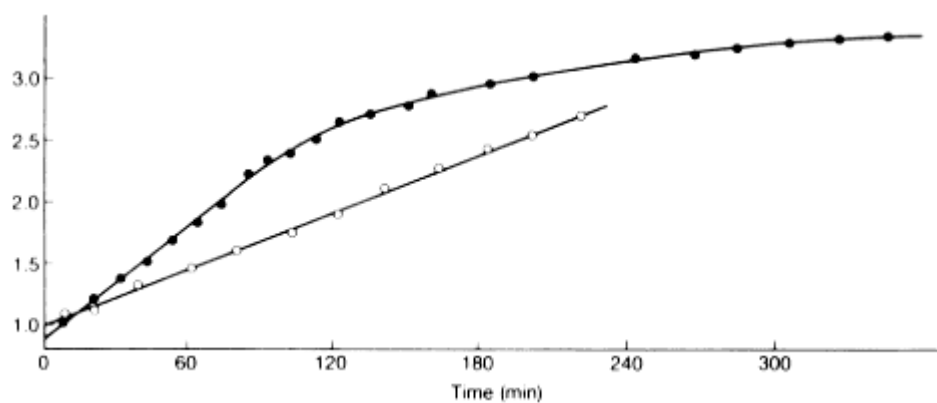

Figure 2.1

Growth of two cultures of *E. coli*. Closed circles, in nutrient broth; open circles, in synthetic medium. Turbidity is proportional to number of cells per unit volume. (From Stent 1963.)

linearity, growth obeying Equation 2.4 is called logarithmic growth. Figure 2.1 shows that bacterial populations do, for a time, obey this law.

Will r in fact be constant? There are several reasons why it might not be. For example:

1. *Synchrony*. Suppose we start with a population of bacteria which had all just completed division. Then, if the inter-division time was, say, 30 min, there would be no divisions for that period, and then all the cells would divide almost simultaneously. Thus r would not be constant, and the population would grow in a stepwise manner. If the division time was exactly 30 min for all cells, the synchrony would last for ever. In practice, however, there would be some variation either side of 30 min, and in time the synchrony would be lost. There is a theorem, due to Lotka, which says that if there is a population whose members have age-specific birth and death rates—that is, which have a fixed probability both of reproducing and of dying as a function of age, then in time that population will reach a stable age distribution: after that, the proportion of the population that is of any age remains constant. In our model, the death rate is zero, and the birth rate is fixed, with a narrow peak at 30 min. Lotka's theorem says that in time our population will reach a stable age distribution. At any instant, some cells will just have divided, and others will be about to divide, but, if we choose a cell at random, its chance of dividing will be constant. This justifies Equation 2.1 as a representation of a population in a stable age distribution.

2. *Inherited differences between cells*. Suppose that there are cells with different division times, and that these differences are transmitted to daughter cells. Then the proportions of different kinds will change with time, and r will not be constant. Thus Equation 2.4 assumes no inherited differences.

Even if the population is asynchronous and genetically uniform, it cannot increase logarithmically for ever. Sooner or later, a shortage of resources must bring the increase to a halt. It was this insight that both Darwin and Wallace acquired by reading the economist Malthus, and which led them to the idea of natural selection. The effect of resource limitation is allowed for in the logistic equation:

$$dx/dt = rx(1 - x/K). \quad (2.5)$$

Although this equation is the basis of much of theoretical ecology, it has weaknesses, which are discussed in Box 2.1. It does, however, have two essential features, which make it adequate for our present needs:

1. When x is small, it reduces to Equation 2.2: this corresponds to the fact that populations, when small, often increase exponentially.
2. Population growth slows down, and reaches an equilibrium level K (see Fig. 2.2). K is called the carrying capacity. If, initially, $x < K$, the population rises towards K , and if $x > K$ the population falls towards K . Note that the approach to K occurs without oscillations. This does not mean that fluctuations in population size cannot occur in the real world, but only that Equation 2.5 was chosen because it is a convenient description of populations that do not oscillate.

Selection in an Asexual Population

We are now in a position to ask our first question: in what circumstances will selection lead to the replacement of one kind of organism by another? Suppose that the numbers of the two kinds are x and y , respectively. Then we might describe their growth by the equations:

$$\begin{aligned} dx/dt &= r_1x(1 - x/K_1), \\ dy/dt &= r_2y(1 - y/K_2). \end{aligned} \quad (2.6)$$

It is then easy to see what will happen: x will increase to K_1 , and y will increase to K_2 . The two populations will coexist indefinitely. There will be no selective replacement of one by the other.

The reason for this rather disappointing result is that, in Equation 2.6, we have assumed that the two populations are limited by different resources. This is implicit in the fact that the growth of each is unaffected by the other. Let us, therefore, make the opposite assumption that the two kinds have the same resource requirements. That is, we assume that the growth of x is slowed down as much by the value of y as it is by the value of x , and vice versa. Then

$$\begin{aligned} dx/dt &= r_1x[1 - (x + y)/K_1], \\ dy/dt &= r_2y[1 - (x + y)/K_2]. \end{aligned} \quad (2.7)$$

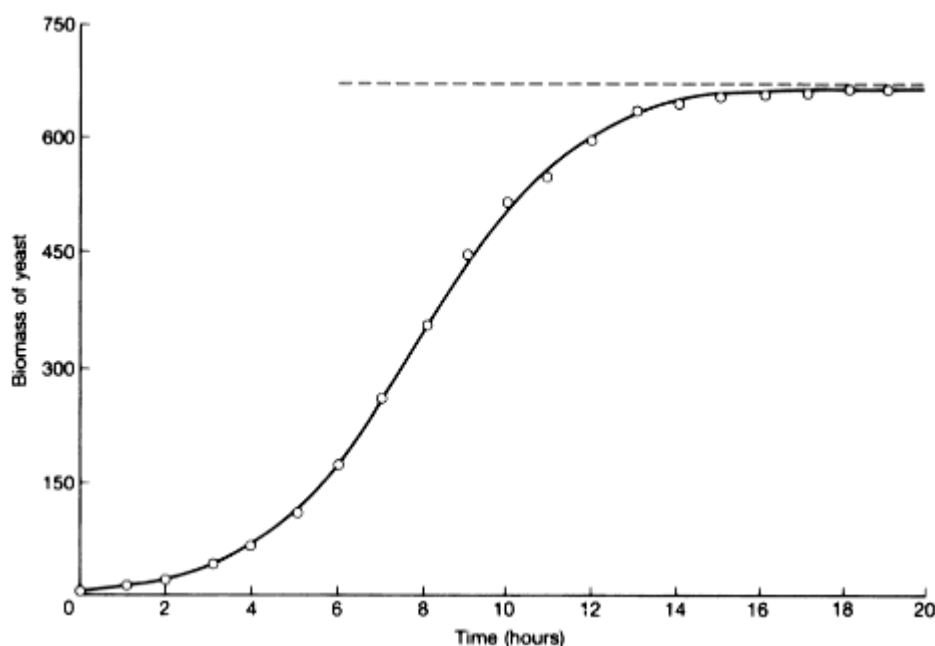

Figure 2.2

A comparison of the growth of yeast in a culture with logistic growth (from Allee *et al.* 1949).

It is now easy to see that, if K_1 and K_2 are different, one kind will eliminate the other. Thus suppose that $K_1 > K_2$. Then x will increase until $x + y = K_1$. At this point, $x + y > K_2$, and hence dy/dt is negative. Thus y will decrease: in fact, y decreases to zero, so that x selectively eliminates y .

The essential point, then, is that natural selection will cause the replacement of one type by another if, and only if, the two are competing for resources, or, more generally, are limited by the same factors. In ecological terms, they must be controlled by the same negative density-dependent factors. In *in vitro* experiments, this is certainly the case: all RNA molecules are competing for the same replicase enzymes, and the same nucleotides.

There is one feature of the conclusion from Equation 2.7 that is misleading. Since x wins if $K_1 > K_2$, and y wins if $K_2 > K_1$, it might seem that only a difference in carrying capacity K , and not in intrinsic rate of increase, r , could lead to selective replacement: in ecological language, it suggests that only traits that affect resistance to density-dependent factors are subject to natural selection. This is an unfortunate feature of the logistic equation: it is shown in Box 2.1 that selective replacement occurs between forms that differ only in intrinsic rate of increase.

In comparing Equations 2.6 and 2.7, we compared a model in which the two types had no limiting factor in common, and one in which the limiting factors were

identical. Box 2.2 deals with the intermediate case, in which the limiting factors are similar but not identical. Two main conclusions emerge:

1. Coexistence is favoured if each kind has a greater inhibiting effect on its own growth than it does on the other.
2. When there is coexistence, each kind has a higher rate of increase than its competitor when it is rare, and its competitor is common.

Usually, the model in Box 2.2 is thought of as applying to competition between species, and as giving the conditions that must be satisfied if two species are to coexist. However, it applies equally well to competition between different geno-

Box 2.1—

A Non-logistic Model of Population Growth and Competition

There is an important difference in kind between Equations 2.2 and 2.5. This can be expressed by saying that Equation 2.2 can be microscopically justified, whereas Equation 2.5 is descriptive and phenomenological. Thus Equation 2.2 derives from a description of what individual cells are doing—for example, that they are asynchronous, genetically identical, and not resource-limited. Equation 2.5 does not. For example, it is possible for dx/dt to be negative (when $x > K$), and therefore there must be deaths as well as births, but it was nowhere stated how births and deaths contribute. The justification for Equation 2.5 is that it accurately describes some cases of change in population number, and that it is mathematically simple. In fact (as indicated in Problem 1) it is possible to derive Equation 2.5 from a consideration of what individuals are doing, but it was presented here as purely phenomenological.

It may help to note that this contrast between phenomenological and microscopically justified theories is common in science. A classic example is the contrast between statistical mechanics, in which the behaviour of a gas is deduced from the behaviour of individual molecules, and classical thermodynamics, which describes systems in terms of global properties—temperature, heat, entropy, etc.—without microscopic derivation. Most theories in biology have both microscopic and phenomenological features.

Let us replace Equation 2.5 by an equation based on the behaviour of individuals. The change in x is equal to the number of births, minus the number of deaths. We can write

$$\delta x = (\text{birth rate} - \text{death rate})x\delta t.$$

If we assume that the death rate is constant, but the birth rate is density-dependent, this becomes

$$\delta x = [r(x) - d]x\delta t.$$

We need a form for $r(x)$. At this point, the model becomes descriptive. We need a form in which $r(x) = r$ when x is small, and tends to zero as x tends to infinity. Algebraically, the simplest form is $r(x) = r/(1 + x)$. Then

$$\frac{dx}{dt} = \frac{rx}{1+x} - dx. \quad (2.8)$$

This equation can be integrated, to give a pattern of growth that would be indistinguishable from logistic growth, with intrinsic rate of increase r , and carrying capacity $K = (r - d)/d$.

Suppose now that two types, x and y , have identical limiting factors. Then

$$\begin{aligned} \frac{dx}{dt} &= \frac{r_1x}{1+x+y} - d_1x, \\ \frac{dy}{dt} &= \frac{r_2y}{1+x+y} - d_2y, \end{aligned} \quad (2.9)$$

Then $dx/dt = 0$ when $1 + x + y = r_1/d_1$, and $dy/dt = 0$ when $1 + x + y = r_2/d_2$. In competition, that type will win that has the larger value of r/d .

The relevance of this is as follows. It might seem from the analysis of Equation 2.6 in the main text that only differences in carrying capacity, and not of intrinsic rate of increase, could lead to selective replacement. This, however, is a peculiarity of the logistic equation. For the more realistic model of Equation 2.9 differences in either birth or death rate, or both together, can influence the outcome.

types in an asexual population. The conditions for the coexistence of different types in a sexual population are more complex: they are discussed in Chapter 4. However, it is worth noting at this stage that condition 2 above amounts to saying that the fitness of a type depends on its relative frequency in the population, increasing as it becomes less frequent. Thus the stable equilibrium illustrated in Fig. 2.3 is an example of 'frequency-dependent selection', as discussed on page 69.

The Accuracy of Replication

If the replication process were exact, no new variants would arise, and evolution would slow down and stop. The *in vitro* experiments work only because enzyme replication of RNA is not exact. However, evolution would also be impossible if the replication process were too inaccurate. Thus although an occasional error in replication, **omutation**, may lead to an improvement in adaptation, most will lead to deterioration. Hence, too high an error rate will lead to loss of adaptation. I now

**Box 2.2—
Competition Between Two Types**

By analogy with Equations 2.6 and 2.7, we can write

$$\begin{aligned}\dot{x} &= r_1x(1 - bx - cy), \\ \dot{y} &= r_2y(1 - fx - gy),\end{aligned}\tag{2.10}$$

to describe the population sizes x and y of two types which inhibit one another's growth, but to a degree different from that with which they inhibit their own. In these equations, I have used the notation \dot{x} and \dot{y} , instead of dx/dt and dy/dt , for the rates of change of x and y . The constants r_1 and r_2 are the intrinsic rates of increase of x and y ; b and g measure the inhibiting effects of each type on its own increase, and c and f the inhibiting effects of each type on the growth of the other. In the notation of the main text, $K_1 = 1/b$, and $K_2 = 1/g$.

We can represent the state of the two populations at any moment by the values of x and y . Therefore we can also represent the state as a point in a two-dimensional **state space**. We can then describe changes in the two populations in time by attaching an arrow to each point in state space, indicating the direction in which the system will move. Then, by joining these arrows together to form trajectories, we can obtain a picture of how the populations will behave, as shown in Fig. 2.3.

We decide on the directions of the arrows by examining Equations 2.10. Thus

- (a) If $1 - bx - cy > 0$, then $\dot{x} > 0$, and the arrow must tend upwards: if $1 - bx - cy < 0$, the arrow tends downwards.
- (b) If $1 - fx - gy > 0$, then $\dot{y} > 0$, and the arrow must tend to the right: if $1 - fx - gy < 0$, the arrow tends to the left.

The trajectories in Fig. 2.3 are deduced from these facts. Provided that, initially, neither x nor y equals zero, the system will move to a stable equilibrium, with both types present.

Of course, it cannot be true that two types can always coexist, regardless of the nature of the interactions between them. Figure 2.3 assumes that $b > f$ and $g > c$. In words, this means that the inhibiting effect of each species on itself is greater than its inhibiting effect on the other. This would be true, for example, if the two types compete for some kinds of food, but if there are also kinds of food taken only by one type or by the other.

If one, or both, of these inequalities are reversed, stable coexistence is no longer possible. It is a useful exercise to draw the trajectories in state space when both inequalities are reversed (see Problem 6).

try to make this idea quantitative. How accurate must replication be if adaptation is to be maintained? This question is discussed in Box 2.3.

Equation 2.13 gives the critical value of Q , the accuracy of replication, if the

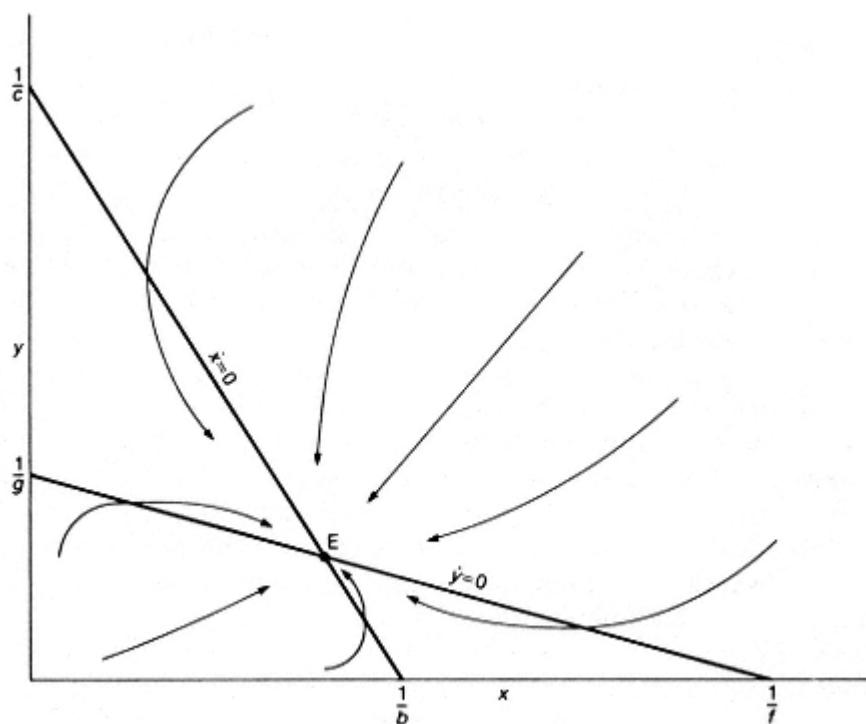

Figure 2.3

Trajectories in state space for competition between two types, with densities x and y , described by Equations 2.10. The bold lines are the loci of points for which $\dot{x} = 0$, and $\dot{y} = 0$. The point E is a stable equilibrium.

Box 2.3—

The Accuracy of Replication

Imagine a population of replicating RNA molecules. There is some unique sequence, S , that produces copies at a rate R : all other sequences produce copies at a lower rate, r . Thus sequence S is in some way superior to all others. A sequence produces an exact copy of itself with probability Q . If x_0 and x_1 are the numbers of copies of S and non- S respectively, then, ignoring deaths,

$$\begin{aligned} dx_0/dt &= RQx_0, \\ dx_1/dt &= rx_1 + R(1 - Q)x_0. \end{aligned} \quad (2.11)$$

In writing down these equations, I have assumed that when an error occurs in the replication of a non- S sequence, it gives rise to another non- S sequence: that is, I have ignored the very small probability that a non- S sequence will give rise to an S sequence.

We are interested in the survival of optimal molecules. At first sight, Equation 2.11 suggests that they will survive provided that $RQ > 0$. If there is

no mortality, this is correct: if an optimal molecule survives for ever, then the number of such molecules will increase provided that some copies, however few, are also optimal. But of course there will be some mortality. What, then, is the minimum value of Q , given mortality? Adding the two equations gives

$$d(x_0 + x_1)/dt = Rx_0 + rx_1 - D(x_0 + x_1).$$

Can optimal molecules survive when deaths balance births (as must be the case in the long run)? That is, when

$$D = \frac{Rx_0 + rx_1}{x_0 + x_1} = Rp + r(1 - p), \quad (2.12)$$

where p is the proportion of the molecules in the population that are optimal. The equation for x_0 , the number of optimal molecules, is

$$dx_0/dt = RQx_0 - \{Rp + r(1 - p)\}x_0.$$

Hence, at equilibrium,

$$Q = p + \frac{r}{R}(1 - p).$$

As the accuracy, Q , decreases, so the proportion, p , of optimal molecules at equilibrium will also decrease. The lowest value of Q compatible with any optimal molecules being present occurs when $p \approx 0$, and

$$Q \approx r/R. \quad (2.13)$$

adapted sequence, S , is to be maintained by selection against the deterioration caused by mutation. If the replication rate of the mutants is only slightly less than that of the optimal sequence (i.e. weak selection), then the accuracy Q must be high, because the mutant particles compete with S for resources. What if mutants replicate slowly: in the extreme case, suppose they do not replicate at all? It does not follow that any degree of accuracy, however low, will be sufficient. Thus S particles will not be immortal: there will be some rate of destruction, or 'death rate', even in the absence of competition from non- S particles. On average, each S particle must, during its life, produce one perfect S copy. Hence if the average number of copies per S particle before it is destroyed is R , then $Q > 1/R$ is necessary.

The critical accuracy, then, depends both on the success of non- S copies, and, if non- S particles have a low replication rate, on the average number of copies produced by an S particle during its lifetime. In practice, it seems unlikely that evolution would be possible if $Q < 1/2$.

The practical implication of this is that it places a limit on the size of the genome,

for any given replication accuracy. Thus consider a genome of n nucleotides, and let the probability that an error is made in replication be u per nucleotide. Then $Q = (1 - u)^n \cong e^{-nu}$. Hence the maintenance of adaptation requires, very approximately, that $nu < 1$. Three very different error rates exist: the rate for replication in the absence of enzymes, which may have occurred during the origin of life; the rate for replication of RNA, which does not involve a 'proof-reading' stage; and the rate for the replication of DNA, with proof-reading. The values are, very approximately, as follows:

	error rate (u)
non-enzymic replication	1/10-1/100
RNA replication	10^{-3} - 10^{-4}
DNA replication	10^{-9} - 10^{-10}

The requirement that $nu < 1$ then explains the fact that the genome of RNA viruses is never greater than about 10^4 bases, and of higher organisms no greater than 10^8 bases. It also raises an important difficulty for theories of the origin of life. The genome could not become greater than 100 bases in the absence of specific replication enzymes, yet a genome of less than 100 bases could hardly code for such an enzyme: for further discussion of this problem, see Eigen *et al.* (1981), and Maynard Smith and Szathmari (1995).

Genetic Drift in Finite Populations

The models considered so far have been deterministic: that is, they have assumed that the proportions of individuals of different kinds in the next generation is exactly what would be expected from the known probabilities of survival and reproduction. It is as if we were to assume that, if we toss a coin 100 times, we will get exactly 50 heads. This deterministic assumption, as far as proportions or frequencies are concerned, is approximately true if the population is large, and exact only if the population is infinite. In small populations it may be seriously in error. The proportions of different kinds will fluctuate by chance: such fluctuations are referred to as **genetic drift**.

To get some idea of the magnitude of this effect, suppose that we have an asexually reproducing population of N individuals, in each generation. There are two types, a and A , which do not differ in likelihood of survival or reproduction: that is, there is no selection. In one generation, let the frequencies of a and A be p and q , respectively: that is, there are Np of type a and Nq of type A . In reproduction, each type produces offspring like itself. Let p' and q' be the frequencies of a and A in the next generation. In an infinite population, $p' = p$ and $q' = q$. If the population is of finite size N , however, the frequencies in the next generation may not be the same as the frequencies in this, because some individuals will, by chance, have more offspring than others. It is helpful to imagine producing, not

one offspring generation of size N , but repeating the process many times. If we then measure the frequency, p' , of a in each trial, we can calculate the expected value of p' : that is, the average value in repeated trials. If there is no selection, the expected value is unchanged: that is $E(p) = p$ and $E(q) = q$. However, p' will vary from trial to trial, because of chance fluctuations. We can measure the variability of p' by its variance: that is

$$V = E(p' - \bar{p}')^2,$$

where p' is the mean value of p' . Since $p' = p$, we have that $V = E(p' - p)^2$. Alternatively, we can measure the variability of p' by its standard deviation.

$$\sigma(p') = V^{1/2},$$

The variability of p' will depend on the variability of family size. Thus if every member of the population has exactly one offspring, then $p' = p$ and $V = 0$. A more realistic assumption is that family size has a **Poisson distribution**: this is the distribution that would be obtained in a large population if each of the total of N offspring was assigned randomly to one of the N parents, independently of how the other offspring were assigned. If so, each offspring has a probability p of being a . The probabilities that there will be 0, 1, 2, . . . N offspring of type a are given by successive terms of the **binomial distribution**, $(p + q)^N$: that is

$$p^N, Np^{N-1}q, \frac{N(N-1)}{2} p^{N-2}q^2, \dots, q^N.$$

The binomial distribution has the properties shown in Table 2.1. Thus suppose that $p = q = 1/2$. Then

$$\sigma(p') = \sqrt{\frac{pq}{N}} = \frac{1}{2\sqrt{N}}.$$

For populations of various sizes:

Population size, N	10	100	1000	10^6
p' { mean	0.5	0.5	0.5	0.5
SD	0.158	0.05	0.0158	0.0005

Table 2.1

The binomial theorem. Type a individuals occur with probability p in a population of N .

The probabilities of 0, 1, 2 . . . N individuals of type a are given by the terms of $(p + q)^N$.

	Number of a individuals	Frequency of a individuals
Mean	Np	p
Variance	Npq	pq/N
Standard deviation	\sqrt{Npq}	$\sqrt{pq/N}$

Thus in a population of 100, if there are 50*a* individuals in one generation, the number may well be less than 45, or more than 55, in the next: in fact, there is a chance of about one-quarter that the number will lie outside these limits. It is more difficult to estimate by how much the frequency is likely to have changed after, say, 10 to 100 generations, because the fluctuations will be sometimes upwards and sometimes downwards. The problem is treated in Box 2.4. The important points to bear in mind are as follows:

1. In a finite population, the frequencies of different types will fluctuate from generation to generation, in the absence of natural selection. Therefore, if one wishes to demonstrate that selection has occurred by comparing the relative frequencies of different types in successive generations, one must show that the changes are greater than those that would be expected by chance.
2. The smaller the population, the greater the fluctuations in frequency.
3. In a finite population, one type will ultimately become fixed by chance, all others having been eliminated. Figure 2.4 illustrates this process, for two initially equally frequent types, in a population of 50 individuals.

**Box 2.4—
Genetic Drift**

Imagine a population of N asexual individuals, with separate generations. The N individuals in the next generation are produced one by one, and each new individual is equally likely to be produced by any one of the N parents.

In some future generation, all the individuals will, by chance, be descended from a single individual in the present generation. How long will this take? There are two different ways in which we might ask this question, but they have the same answer:

1. How long will it be before the whole population is descended from one individual in the present generation?
2. How many generations must we go into the past to find the single common ancestor of the whole present population?

The answer is that the expected time is $2N$ generations, with a standard error a little greater than N . This conclusion holds for any constant population of N replicators, if the number of copies of a particular replicator has a Poisson distribution. It is applied to the spread of a selectively neutral gene, and to mitochondria on p. 153. The result is derived by a method, the diffusion approximation, that is beyond the scope of this book. It is well explained by Roughgarden (1979). For sceptics, it is easy to check the result by simulation.

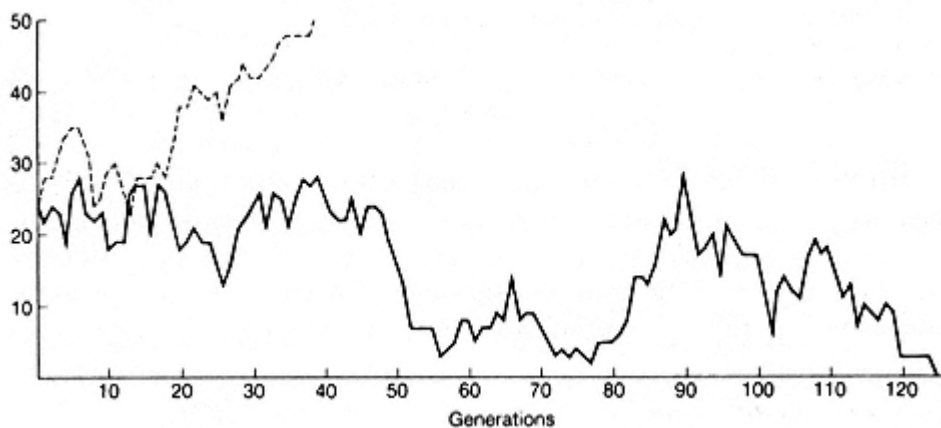

Figure 2.4

Genetic drift. Two selectively equivalent types, a and A , reproduce asexually, in a total population of $N = 50$. Family size is Poisson-distributed. The graphs show the number of a individuals in two of the first three simulations carried out: the third simulation lasted 227 generations before all N individuals were a .

Further Reading

Eigen, M., Gardiner, W., Schuster, P., and Winkler-Oswatitsch, R. (1981). The origin of genetic information. *Scientific American* **244**, 88-118.

Maynard Smith, J. (1974). *Models in ecology*. Cambridge University Press.

Problems

1. A population of size x has a constant birth rate, r , and a death rate of cx : that is, an individual has a probability of dying that is proportional to the population size. Write down a differential equation describing the growth of the population. What is the carrying capacity?
2. In a population of RNA molecules 100 nucleotides long, the error rate for a cycle of replication (A-U-A or G-C-G) is 0.001 per nucleotide. (a) What is the probability of the exact replication of the whole molecule? (b) A unique sequence, S , replicates at a rate 20 per cent greater than all other sequences, which have equal rates. At equilibrium between selection and mutation, what fraction of the population consists of S sequences? (c) What is the maximum error rate per nucleotide compatible with the existence of S at equilibrium?
3. Suppose that you have the numbers from which Fig. 2.4 was plotted, and you suspect that the numbers were invented, and are not the result of simulation. Suggest some simple statistical tests that might confirm your suspicion.
4. In an asexual population of 1000, there are 700 true-breeding individuals of kind A , and 300 of kind B . Assuming no selection, what, approximately, is the probability that there will be more than 73 A individuals in the next generation? What have you assumed?
5. In a diploid population of 500, how many generations will elapse, on average, before all

the alleles at a selectively neutral locus are replicas, with or without mutation, of a single allele in this generation?

6. If, in the model described in Box 2.2, $b < f$ and $g < c$, what will happen?

Computer Projects.

Simulate genetic drift. Start with a population of N asexual types, all different. Produce a new population by random sampling, and continue until all are identical. Use the program to check the statement that the expected time is $2N$ generations, with a standard deviation a little greater than N .

Chapter 3— Evolution in Diploid Populations

Gene frequencies and the Hardy-Weinberg ratio	<u>31</u>
The gene pool approach	<u>32</u>
The mating table approach	<u>34</u>
The concept of fitness	<u>36</u>
The spread of a favourable gene	<u>38</u>
Further reading	<u>45</u>
Problems	<u>45</u>
Computer projects	<u>46</u>

In this chapter, I consider for the first time a sexually reproducing population. I shall consider diploids, because most sexual species are diploids, but it is well to remember that many algae are both haploid and sexual. I shall also assume that both population sizes and fitness differences are large enough to justify a deterministic treatment: chance events are discussed in Chapter 8.

Gene Frequencies and the Hardy-Weinberg Ratio

This chapter is concerned with changes in the frequencies of genes in large populations. I start by defining the 'frequency' of a gene. Consider a large population of sexually reproducing diploids. Suppose that at some autosomal locus there are two possible alleles A and a (I use upper- and lower-case symbols so as to avoid unnecessary subscripts, and not to imply dominance and recessivity). There are then three possible genotypes, AA , Aa , and aa . Imagine that we count a large sample, N , of the population, classifying each one according to its genotype, with the following results:

Genotype	AA	Aa	aa	Total
Number	n_1	n_2	n_3	N
Frequency	$P = n_1/N$	$Q = n_2/N$	$R = n_3/N$	

From the numbers, we can calculate the genotype frequencies, P , Q , and R , as shown. Note that $P + Q + R = 1$.

We now define the frequency of the allele A as the number of A genes in the population, divided by the total number of genes: in performing this calculation, we treat each individual as if it contained exactly two genes. Thus, writing p for the frequency of A , and $q = 1 - p$ for the frequency of a , we have:

$$p = (2n_1 + n_2)/2N; q = (n_2 + 2n_3)/2N, \quad (3.1)$$

or, equivalently, $p = P + 1/2Q$; $q = 1/2Q + R$; and, obviously, $p + q = P + Q + R = 1$ (see Fig. 3.1).

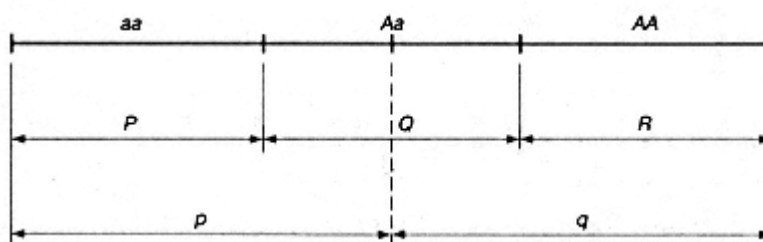

Figure 3.1
The relationship between the genotype frequencies at a locus,
 P , Q , and R , and the gene frequencies p and q .

This definition can easily be extended to any number of alleles at a locus. If we know the numbers, or frequencies, of all the possible genotypes, it is a trivial matter to calculate the frequencies of the alleles. Can we do the reverse? That is, can we calculate P , Q , and R when we know p and q ? In general, we cannot: there is no way of calculating three unknowns from two equations. However, we can do so if we assume that mating is 'random': that is, if the genotypes (at this particular locus) of the two parents of a child are independent. There are two ways of tackling the problem: they give the same answer, but it is worth following both.

The Gene Pool Approach

Imagine that we look at a random zygote (i.e. a fertilized egg) just after fertilization. It will have received one allele, A or a , from its father, and one from its mother, according to the following scheme:

gene from father	gene from mother	joint probability
A	A	$p \times p = p^2$
A	a	$p \times q$
a	A	$q \times p$
a	a	$q \times q = q^2$

$\left. \begin{array}{l} p \times q \\ q \times p \end{array} \right\} = 2pq$

In this table, it is assumed that the joint probability of getting, say, A from father and a from mother is the product of the two separate probabilities. This is justified only if the two events are independent of one another, and hence only if mating is random. Thus suppose, as a counter-example, that allele a is for blue eyes (so that aa genotypes have blue eyes, and Aa and AA have brown eyes), and also that there is assortative mating for eye colour, so that blue-eyed people tend to marry one another. Then if a child gets the gene a from its father, it is somewhat more likely to get a from its mother also than would be the case if it got gene A from its father.

The conclusion, then, is that under random mating we expect the three genotypes in the proportions p^2 AA : $2pq$ Aa : q^2 aa , Where p and q are the frequencies of alleles A and a among the gametes. This is the famous 'Hardy-Weinberg' ratio, named after its two independent discoverers. Note that it is achieved after one

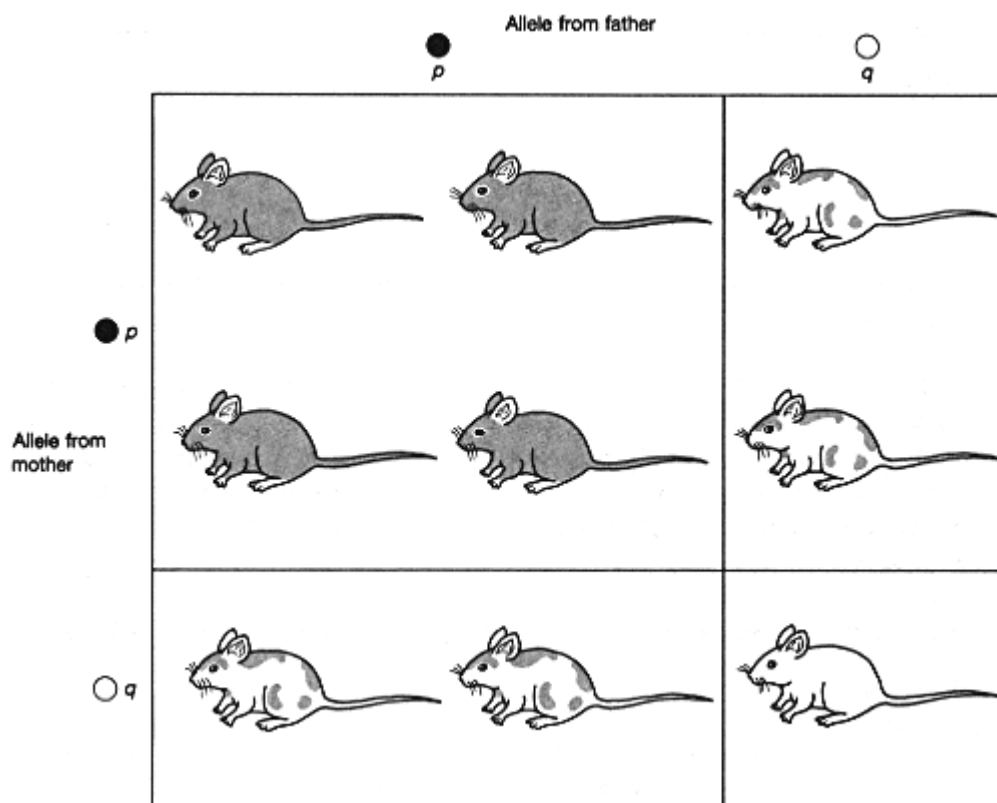

Figure 3.2
A geometrical representation of the Hardy-Weinberg ratio.

generation of random mating: the offspring will be in the Hardy-Weinberg ratio even if the parents were not. A geometrical representation of the argument is given in Fig. 3.2.

It is important to note several assumptions that were made in deriving the result:

1. Mating is random.
2. The frequencies p and q are the same in males and females.
3. p and q are the frequencies among successful gametes: that is, gametes that contribute to zygotes. Hence it is not enough to calculate p and q from the frequencies P , Q , and R of the genotypes in the adult population. These genotype frequencies must be weighted by their fertilities.
4. The frequencies among zygotes are recorded before any selection has acted.

I headed this section the **gene pool** approach because it is equivalent to supposing that the adult population contributes genes to a gene pool, and that new diploid zygotes are formed by drawing two genes, at random, from this pool. We

shall meet this way of thinking again in Chapter 8. I now turn to an alternative way of deriving the Hardy-Weinberg ratio.

The Mating Table Approach

As before, let the frequencies of genotypes AA , Aa , and aa in the adult breeding population be P , Q , and R . Table 3.1 lists the different possible matings, their frequencies, and the offspring produced. Note that the frequency of the mating $AA \times Aa$ is $2PQ$, because there are two possible cases, $AA \text{ ♀} \times Aa \text{ ♂}$, and $Aa \text{ ♀} \times AA \text{ ♂}$, each with frequency PQ . Adding up the offspring gives $p^2 AA : 2pq Aa : q^2 aa$. Note that the four assumptions listed above (random mating, equal gene frequencies in the two sexes, breeding adults and not total adults counted, no selection) have again been made.

In deriving the Hardy-Weinberg ratio, it is easier to use the gene pool approach, and there is no real need to set out the full mating table. However, it is useful to introduce mating tables here, because they are needed in more complex cases or example, if mating is not random.

If a sample is found not to be in the Hardy-Weinberg ratio, there are various possible explanations:

1. Selection has operated between the formation of zygotes and the time of sampling.
2. Mating is not random. This may be caused by the alleles themselves: for example, if alleles in a plant affect flowering time, mating for those alleles would not be random. It can also be for reasons that have nothing to do with the alleles themselves: for example, if mating between relatives is common, then mating will not be random even for alleles which have no effect on mating.

Table 3.1

The Hardy-Weinberg ratio derived from a mating table.

Mating	Frequency	Progeny		
		AA	Aa	aa
$AA \times AA$	p^2	p^2	—	—
$AA \times Aa$	$2PQ$	PQ	PQ	—
$AA \times aa$	$2PR$	—	$2PR$	—
$Aa \times Aa$	Q^2	$Q^2/4$	$Q^2/2$	$Q^2/4$
$Aa \times aa$	$2QR$	—	QR	QR
$aa \times aa$	R^2	—	—	R^2
Totals	$(P+Q+R)^2$ =1	$(P+Q/2)^2$ = p^2	$2(P+Q/2)(Q/2+R)$ = $2pq$	$(Q/2+R)^2$ = q^2

3. The sample is not from a single population. It is shown in Box 3.1 that if a sample is composed of two sub-samples, each from a random-mating population, but with different frequencies of allele A , then in the total sample there will be more homozygotes and fewer heterozygotes than would be predicted by the Hardy-Weinberg ratio. This, the **Wahlund effect**, is a common cause of the departure of real data from the Hardy-Weinberg ratio.

4. Genotypes have different likelihoods of being included in the sample.

As an application of the Hardy-Weinberg ratio, consider the data collected by da Cunha on *Drosophila polymorpha*. Two alleles at a locus determine abdomen colour: EE is dark, Ee intermediate, and ee is pale. Table 3.2 gives the frequencies of these types among 8070 flies collected in Brazil. There is a highly significant deficiency of heterozygotes, compared to the numbers expected from the Hardy-Weinberg ratio.

One possible explanation is that heterozygotes are less viable in the wild, but this is unlikely, because laboratory measurements suggested that heterozygotes had a higher viability than either homozygote. It is conceivable that abdomen colour influences mate choice: if there is a tendency for like to mate with like, this could explain the discrepancy. Perhaps the most plausible explanation is that the flies are not drawn from a single random-mating population. It was shown in Box 3.1 that if a total sample is made up of several sub-samples, each of Hardy-

**Box 3.1—
The Wahlund Effect**

Suppose that two alleles are segregating in a species. Two samples, each of size $N/2$, are taken from different random-mating populations, with frequencies of A of 0.2 and 0.7, respectively. If the two samples are pooled, the expected numbers in the joint sample of N are:

$$AA: (0.04 + 0.49) N/2 = 0.265N$$

$$Aa: (0.32 + 0.42) N/2 = 0.370N$$

$$aa: (0.64 + 0.09) N/2 = 0.365N$$

$$\text{Total} = N$$

Thus the overall frequency of A is $(2 \times 0.265 + 0.37)/2 = 0.45$, and hence, if the pooled sample had been taken from a single random-mating population, the expected frequencies of the genotypes would be 0.2025 AA :0.495 Aa :0.3025 aa . The actual numbers in the pooled sample show a deficiency of heterozygotes relative to these expectations.

It is not difficult to show that such a deficiency of heterozygotes is to be expected whenever a total sample is made up by pooling samples from random-mating populations with different gene frequencies.

Table 3.2Abdomen colour in *Drosophila polymorpha* (Cunha 1949).

	Gentotype dark EE	intermediate Ee	light ee	Total
Observed (<i>O</i>)	3969	3174	927	8070
Expected from H-W ratio (<i>E</i>)	3825	3462	783	
<i>O-E</i>	144	-288	144	
$(O-E)^2/E$	5.42	23.96	26.48	55.86

$$p(E) = \frac{2 \cdot 3969 + 3174}{2 \cdot 8070} = 0.6885$$

$$p(e) = 1 - p(E) = 0.3115$$

χ^2 with one degree of freedom = 55.86. $P \ll 0.001$. (Note that there is only one degree of freedom, because p has been calculated from the data.)

Weinberg ratio but with different gene frequencies, then the total sample will have an excess of homozygotes.

Perhaps the main utility of the Hardy-Weinberg ratio is in developing theoretical models: if, in a model, we assume random mating, we reduce the number of variables with which we have to deal. However, it does have some empirical value in providing a null hypothesis when seeking evidence of natural selection or of assortative mating. The snag is that it is not a particularly sensitive way of detecting selection (see Problem 3). Also, it will fail to detect selection arising from differences of fertility rather than viability.

The Concept of Fitness

Before we can calculate how the frequencies of genes in a population will change in time, we need some measure of the survival and reproduction of the different genotypes. This measure is **fitness**, which has a technical meaning in population genetics. The definition is easiest for populations with separate generations. For example, an annual insect in which all adults that breed in one year die before the next. Then the fitness of a particular type, A , is the expected number of offspring contributed by an A individual to the next generation. Fitness is estimated from one particular stage in the life cycle. Usually the zygote to the corresponding stage in the next (see Fig. 3.3). Then the fitness of zygotes of type A is the expected number of zygotes in the next generation to which an A zygote in this generation will contribute gametes. That is:

'fitness of an A zygote' = 'probability that an A zygote will survive to breed' × 'expected number of offspring, given that it does survive'.

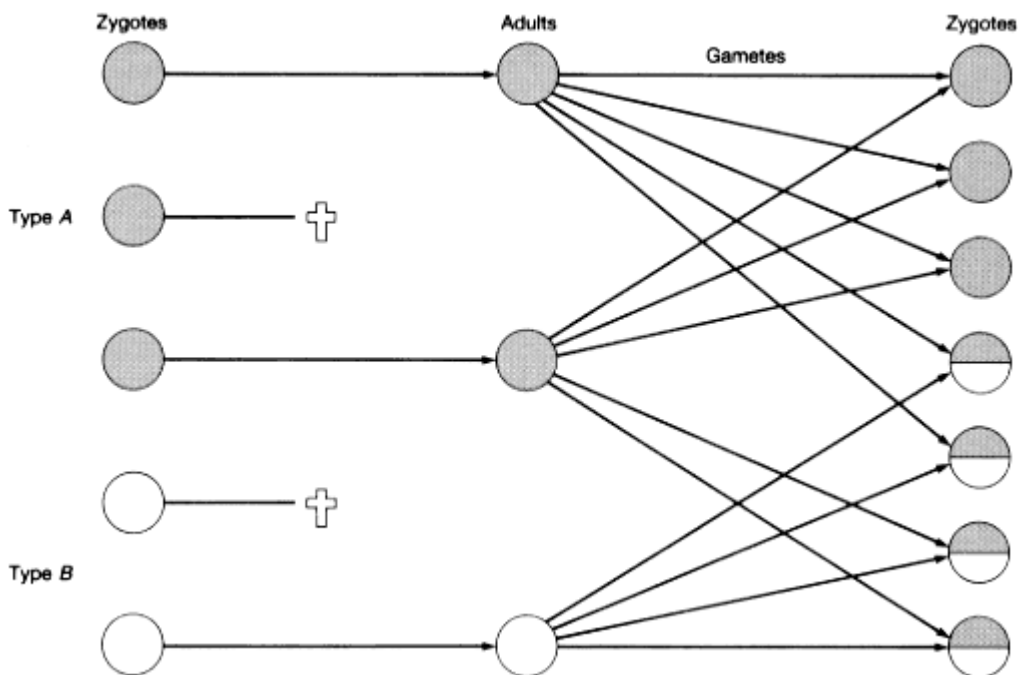

Figure 3.3

The definition of fitness when generations are separate. Type *A* has a $2/3$ chance of surviving, and survivors contribute five gametes to the next generation, giving an absolute fitness of $2/3 \times 5 = 10/3$. Type *B* has a $1/2$ chance of surviving, and contributes four gametes, giving an absolute fitness of 2. If we are concerned only with the relative fitnesses of different zygotes, it would be convenient to take the fitnesses of *A* and *B* as $W(A) = 1$, and $W(B) = 2 \div 10/3 = 0.6$. Note that the diagrams represent average values of survival and fertility: individuals would vary either side of those averages. Note also that, in defining fitness, we are concerned only with the performance of genotypes: we do not keep track of particular alleles.

What has just been defined is 'absolute' fitness. More often, however, population geneticists use 'relative' fitnesses. For example, a model may assume that the fitnesses of genotypes *AA*, *Aa*, and *aa* are 1, 1, and 0.5 respectively. If these were absolute fitnesses, that is, actual numbers of offspring, then the population size would decline in every generation. In practice we make the (often tacit) assumption that population numbers are regulated, and that all we are concerned with is the change in gene frequency in a constant population. It is therefore sufficient to use relative fitnesses, reducing one of the fitnesses to unity, and scaling the others by the same factor. For example:

Genotype	<i>AA</i>	<i>Aa</i>	<i>aa</i>
Absolute fitness	W_1	W_2	W_3
Relative fitness	1	W_2/W_1	W_3/W_1

Some assumptions lying behind the definition of fitness need clarification:

1. Fitness is a property, not of an individual, but of a class of individuals. For example, of individuals homozygous for allele A at a particular locus. Thus the phrase 'expected number of offspring' means the average number, not the number produced by some one individual. If the first human infant with a gene for levitation were struck by lightning in its pram, this would not prove the new genotype to have low fitness, but only that the particular child was unlucky. Usually we ascribe a fitness to a 'genotype', meaning a class of individuals with some genetic characteristic in common.
2. Fitness is specific to an environment. Thus in my lifetime, myopic individuals have had a high fitness, because they were less likely to be put in military uniform and shot at. In a hunter-gatherer society, myopics would probably have a low fitness. We can, if we wish, define fitness not for one specific environment, but for a set of environments, each encountered with some probability.
3. Fitness is measured over one generation. It requires further computation to predict what will happen over many generations.
4. Fitness is a property of classes of individuals, and not genes. The reason for this is that selection typically acts on individuals. However, we will meet contexts in which it is useful to ascribe fitnesses so-called 'marginal fitnesses' to genes: an example occurs on p. 65.
5. Populations do not have fitnesses. Essentially, this is because populations do not reproduce, and hence there is no 'generation' over which fitness could be measured. Possible exceptions are discussed in Chapter 9 (the units are populations of viruses in a single host), and in Chapter 14 (the units are species).

Complications arise if generations are not separate. Thus, consider a species like our own. Let there be two genotypes, one of which has an average of three children before the age of 25, and none after, and the other of which has four children after age 25, and none before. Which is fitter? And by how much? R.A. Fisher proposed that, in such cases, fitness is best measured by the 'Malthusian parameter', defined in Box 3.2. Essentially, this parameter is the intrinsic rate of increase of the genotype in question. Fortunately, most conclusions based on models with separate generations extend to the more complex case with overlapping ones. We need to bother about these complications only if we are interested in the evolution of agespecific traits. For example, senescence, or age of first breeding.

The Spread of a Favourable Gene

Consider the spread of a favourable gene in a random-mating population. Let A , a be the favourable and unfavourable alleles, respectively, and let p_n be the frequency of A among new zygotes in generation n . The fitness of AA is $1 + s$, of

Box 3.2— Overlapping Generations

It is hard to define fitness when generations overlap, as they do in humans. As a start, we need a description of the growth of a population of identical individuals. For simplicity, suppose that a female reproduces at a series of discrete moments—say at age 1, 2, 3 . . . years, and so on (for continuous breeding, the summation signs below would have to be replaced by integral signs).

Let ℓ_x = probability that a female survives to age x , and m_x = expected number of female offspring produced by a female of age x .

Note that males are relevant only in ensuring that females are fertilized. Then the total expected female offspring to a female in her lifetime is

$$R_0 = \sum_{x=0}^{\infty} \ell_x m_x. \quad (3.2)$$

R_0 is called the net reproductive rate. If $R_0 > 1$ the population will grow. There is an important theorem, due to Lotka, which says that, if the values of ℓ_x and m_x remain constant, then after a sufficient period of time the population will acquire a 'stable age distribution'. That is, the proportion of females of any age—say 30 years—will remain constant. The total population will then increase exponentially at a rate r : that is, $N = N_0 e^{rt}$, and so will the number of females of any particular age. To find r , we solve the equation

$$\sum_{x=0}^{\infty} \ell_x m_x e^{-rx} = 1. \quad (3.3)$$

The simplest way to solve this equation is by trial and error, substituting various values of r .

Why should this equation be true? To see this, imagine a population that has reached its stable age distribution. Let the number of females born in some particular year, t_0 , be T . Then, of these T females, the number born to females of age n is equal to (number of females born n years ago) $\times \ell_n \times m_n$. But the number of females born n years ago is $T e^{-rn}$. Hence, summing over all values of n , $\sum \ell_n m_n T e^{-rn} = T$, which is Equation 3.3.

r is called the intrinsic rate of increase, or Malthusian parameter. Suppose now that the population consists of genetically different females, with different values of ℓ_x and m_x . R. A. Fisher proposed that the appropriate measure of fitness of a genotype in a sexual population is the corresponding value of r . The full justification of this proposal is beyond the scope of this book. However, some feel for it can be obtained by considering a population consisting of a mixture of asexually reproducing females, each with characteristic values of ℓ_x and m_x , and hence of r . Once each type had reached a stable age distribution, each would be increasing at a rate measured by its Malthusian parameter: the type with the largest value of the parameter would increase in frequency relative to the others.

Some numerical cases will help to illustrate how this works out:

Case 1

Type A females all survive for 5 years, and then produce 6 female offspring and die. Then $R_0 = 6$, and $6e^{-5r} = 1$, or $r = 0.358$.

Type B females all survive for 2 years, and then produce 3 female offspring and die. Then $R_0 = 3$, and $3e^{-2r} = 1$, or $r = 0.549$.

In this case, Type B is fitter than Type A, although it has a lower net reproductive rate. In a growing population, it pays to reproduce young.

Case 2

As case 1, but each type of female produces only one female offspring.

For Type A, $R_0 = 1$, and $e^{-5r} = 1$, or $r = 0$.

For Type B, $R_0 = 1$, and $e^{-2r} = 1$, or $r = 0$.

The two types are of equal fitness. In a stationary population, the genotype with the higher value of R_0 has the higher fitness.

Case 3

As case 1, except that both types of female produce only 0.5 female offspring.

For both types, $R_0 = 0.5$.

For Type A, $0.5e^{-5r} = 1$, or $r = -0.139$.

For Type B, $0.5e^{-2r} = 1$, or $r = -0.346$.

Type A is fitter. In a diminishing population, it pays to breed late.

The weakness of this model of growth and selection in populations with overlapping generations is that there is no mechanism of population regulation. In real populations, either ℓ_x or m_x would decrease with increasing population size.

Aa is $1 + hs$, and of aa is 1. By choosing the value of h we can consider a dominant favourable allele ($h = 1$), a recessive allele ($h = 0$), or an allele of intermediate dominance ($h = 1/2$). For the moment, we will assume that the fitness differences arise because different genotypes have different probabilities of survival (viabilities), and that, if they do survive, the three types are equally fertile. Then, in generation n

Genotype	AA	Aa	aa
Fitness	$1 + s$	$1 + hs$	1
Frequency of zygotes	p_n^2	$2p_nq_n$	q_n^2
Relative proportions of adults	$p_n^2(1 + s)$	$2p_nq_n(1 + hs)$	q_n^2

I have written 'relative proportions' rather than 'frequency' in the last row because the entries do not add up to one. Thus the sum of the three entries is:

$$\begin{aligned}
 T &= p_n^2 + sp_n^2 + 2p_nq_n + 2hsp_nq_n + q_n^2 \\
 &= 1 + s(p_n^2 + 2hp_nq_n).
 \end{aligned}
 \tag{3.4}$$

The frequency of allele A in the next generation of zygotes, p_{n+1} , is equal to its frequency among the adults of generation n . That is:

$$p_{n+1} = [2 \times \text{number of } AA \text{ adults} + \text{number of } Aa \text{ adults}] / 2T,$$

or

$$p_{n+1} = \frac{p_n^2(1+s) + p_nq_n(1+hs)}{1 + s(p_n^2 + 2hp_nq_n)}. \quad (3.5)$$

Suppose that, instead of having different viabilities, the three genotypes were equally likely to survive to breed, but that their fertilities were in the ratio $1 - s : 1 + hs : 1$. Then the last row of the table no longer gives the relative proportions of adults (which are $p^2 : 2pq : q^2$), but it does give the relative contributions of AA, Aa, and aa adults to the gene pool from which the next generation is formed. Hence Equation 3.5 still holds.

What we would like to get from this equation is an expression for p_n as a function of the initial frequency, p_0 , and the fitness coefficients h and s . Unfortunately, we cannot in general do that. We can, however, proceed in one of two ways. First, we can look at the initial increase in A when it is rare (p small): this is done in Box 3.3. It turns out that if A is completely recessive ($h = 0$), the initial increase is very slow. If A is partially or wholly dominant, p_n is given by

$$p_n = p_0 e^{shn}. \quad (3.6)$$

Box 3.3—

The Increase in a Favourable Gene When Rare

Equations such as 3.5 are called finite difference equations. Provided that the change in one time interval is small, such an equation can be approximated by a differential equation. To do this, we find an expression for δp_n , the change in p_n in one generation. That is

$$\delta p_n = p_{n+1} - p_n = \frac{p_n^2(1+s) + p_nq_n(1+hs)}{1 + s(p_n^2 + 2hp_nq_n)} - p_n.$$

After some fiddling, this reduces to

$$\delta p_n = \frac{sp_nq_n[p_n + h(1 - 2p_n)]}{1 + s[p_n^2 + 2hp_nq_n]}.$$

If s is small, the change in p in a single generation is small, and we can replace this by a differential equation. Since, for s small, the denominator is approximately equal to 1, we have

$$\frac{dp}{dt} = spq[p + h(1 - 2p)]$$

where t is measured in generations.

If we are interested only in the initial increase of A (p small, $q \approx 1$), this becomes

$$\frac{dp}{dt} = sp(p + h).$$

If A is partially or wholly dominant, we have

$$\frac{dp}{dt} = shp, \quad \text{or} \quad p_n = p_0 e^{shn}.$$

If A is recessive ($h = 0$), then $dp/dt = sp^2$, and for small p the rate of increase is very slow.

That is, A increases exponentially, at a rate determined by the selective advantage hs , in the heterozygotes. These results make intuitive sense. If A is rare, it occurs primarily in heterozygotes, so that its rate of increase will depend on sh . If it is wholly recessive, it will be shielded from selection, and so will increase very slowly.

Alternatively, we can easily solve Equation 3.5 on a computer for any particular values of p_0 , h , and s . Figure 3.4 shows the results for $s = 0.1$ (a 10 per cent selective advantage), for the frequency change from $p = 0.01$ to $p = 0.99$. This confirms that the initial increase of a recessive gene is very slow. Note that the final fixation of the dominant gene is also very slow, for the same reason: when a recessive allele is rare it is not exposed to selection.

The classic example of the spread of a dominant gene under selection is the evolution of industrial melanism in the moth, *Biston betularia*. Prior to 1850, the only form of this moth recorded was of a speckled grey colour—the so-called 'typical' form. In 1850, an almost black moth, the 'carbonaria' form, was reported from Manchester. A century later, up to 95 per cent of moths from industrial areas in Britain were *carbonaria*, although populations from rural areas are still mainly of the typical form. The black colour is caused by a dominant gene. A similar spread of melanic forms has been recorded from no less than 70 species of moth, all of which have the habit of resting during the day on exposed surfaces, in particular the trunks and branches of trees. In all but one of the analysed cases, the melanism that has been established is caused by partly or wholly dominant genes, although recessive mutations causing melanism are known to occur in several species.

An obvious explanation is that the change has been caused by selective predation. In industrial areas, the lichens on trees are killed by pollution, so that the background is dark, and the *carbonaria* form is hard to detect against it, whereas the typical form is hard to see on the lichen-covered trees in rural areas. Supporting this explanation is the fact that many bird species do feed on these

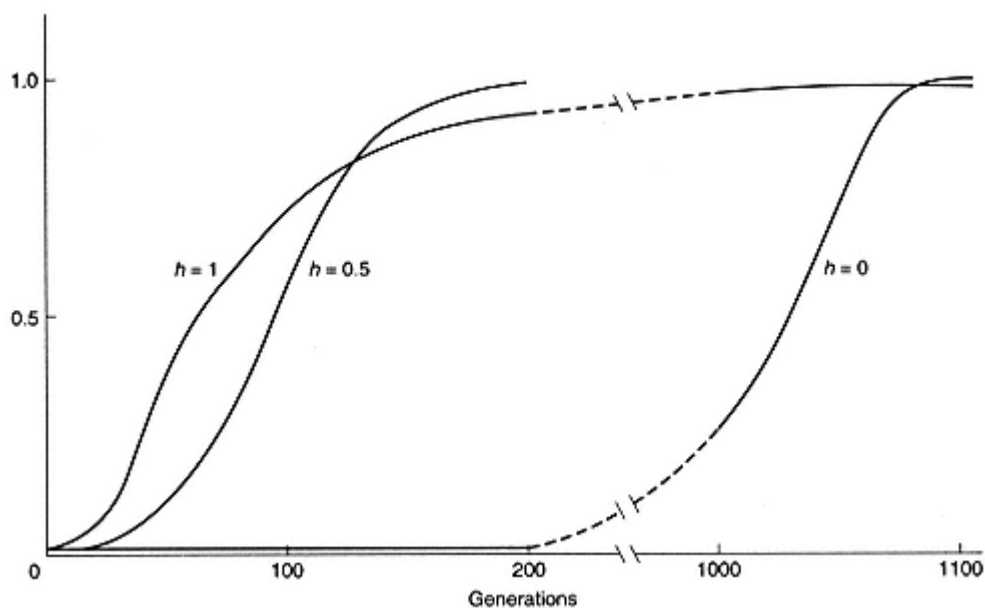

Figure 3.4
Increase in frequency of a favourable gene. Fitnesses, $aa = 1.0$; $Aa = 1 + 0.1h$; $AA = 1.1$. Initial frequency of $A = 0.01$.

moths, and do find the typical form more easily on a polluted background. More direct evidence comes from mark-release experiments. Kettlewell marked moths with paint under the wings so that they could be recognized, and released them in an industrial area near Birmingham. Moths were later recaptured in a mercury-vapour light trap, with the results shown in the upper half of Table 3.3. The results are consistent with the selective hypothesis: a smaller proportion of the typicals were recaptured, suggesting that more had succumbed to predation. However, the data would also be explained if typical forms are more likely to move away from the site of release and recapture, or if they were less easily attracted to light traps. These alternatives are ruled out by the second experiment shown in the table: in a rural area in Dorset, a larger proportion of typicals were recaptured.

Why, in almost all cases, is the melanic gene that has spread dominant, or partly so? It is important to understand that this is not because only dominant mutations occur, or because only they are selectively favoured. It is because favourable recessive mutations spread very slowly. If, in some species, both dominant and recessive melanic mutations had been present in low frequency in 1800, only the dominant one would have had time to become common. Mutations with partial dominance spread almost as rapidly as complete dominants.

Of greater practical importance is the rapid spread of genetic resistance to insecticides (reviewed by Wood, 1981). The first case was recorded in 1908. Resistance had been reported in 14 species by 1948, in 224 by 1967, and in 364 by

Table 3.3

The numbers of moths, *Biston betularia*, released and recaptured in two regions (Kettlewell 1955).

	<i>carbonaria</i>	Typical	Total
Birmingham (urban)			
Released	154	64	218
Recaptured	82	16	98
% recaptured	53.2	25	
Dorset (rural)			
Released	473	496	969
Recaptured	30	62	92
% recaptured	6.3	12.5	

1976: the numbers continue to rise. On analysis, resistance in natural populations has always turned out to be due to one or a few genes. It is rarely wholly recessive: most commonly, the resistant allele is partially dominant.

There was at one time considerable argument about whether the relevant mutations were caused by the insecticides themselves. Since some insecticides are mildly mutagenic, one cannot rule this out, but it has been shown that the effect is not a necessary one. Bennett (1960) produced a strain of *Drosophila melanogaster* that was resistant to DDT, but whose ancestors had never been exposed to the insecticide. He did this by the process of family selection, illustrated in Fig. 3.5. In each generation, the offspring of each pair were divided into two groups, of which

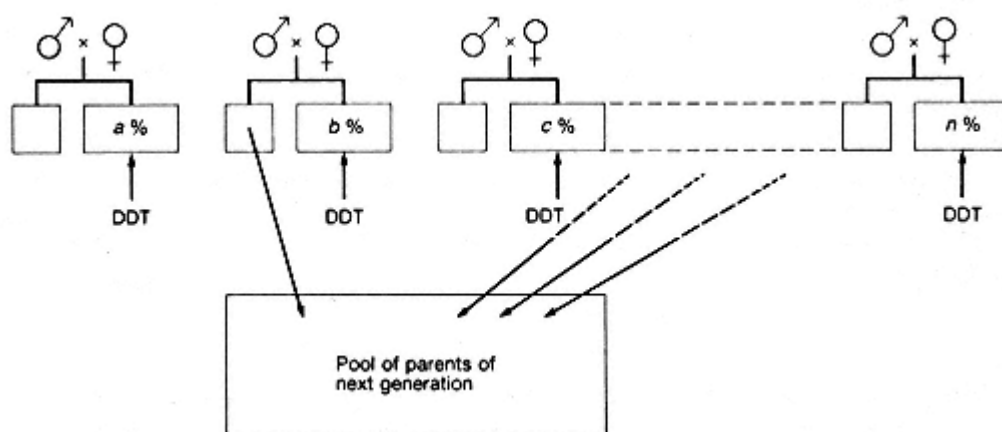

Figure 3.5

Design of sib-selection experiment for DDT resistance. Each family is split into two, and half is exposed to insecticide. The proportions surviving exposure are $a\%$, $b\%$, etc. Those families with the highest proportion of survivors (in the figure, it is assumed that $b\%$ is a high proportion) are used as parents of the next generation, but the parents are chosen from the unexposed half of the population.

one was exposed to DDT. The siblings of those groups with the highest resistance were then used as parents of the next generation. This sib-selection technique is a powerful way of demonstrating the non-Lamarckian nature of genetic adaptation.

How does genetic resistance work? In rough order of importance, the main mechanisms are:

1. *Detoxification*. For example, DDT is broken down by an enzyme (DDT-dehydrochlorinase) in *Musca*, *Aedes*, and other insects. DDT may also be oxidized.
2. *Alteration of the site of action*. For example, organophosphates work by inhibiting the enzyme AChE (acetylcholinesterase). Resistance has evolved by altering the AChE so that it is no longer inhibited in mites, ticks, blowflies, and mosquitoes, among others.
3. *Reduced penetration through the cuticle*. This is unusual, but a gene for impermeability has been established in houseflies.
4. *Behavioural avoidance of the insecticide*.
5. *Accelerated excretion*.

Further Reading.

The material on population genetics, in Chapters 3-6 and 8, is covered in the following textbooks, sometimes in greater detail:

Crow, J.F. (1986). *Basic concepts in population, quantitative and evolutionary genetics* W.H. Freeman, New York.

Hartl, D.L. (1980) *Principles of population genetics*. Sinauer, Sunderland.

Roughgarden, J. (1979). *Theory of population genetics and evolutionary ecology: an introduction*. MacMillan, New York.

A full account of the mathematical theory is given in:

Crow, J.F. and Kimura, M. (1970). *An introduction to population genetics theory*. Harper and Row, New York.

Problems

1. 500 mice were trapped on a farm and classified for the fast (F) and slow (S) electrophoretically detectable alleles at a locus, with the following results:

Genotype	FF	FS	SS	Total
Number	91	208	201	500

Are these results consistent with the Hardy-Weinberg ratio? If not, what explanations are there for the deviation? What observational tests of these explanations can you suggest? (Note: these data were invented.)

2. In London, 5 per cent of all male cats are ginger. What is the expected frequency of ginger females and of tortoiseshell females? (Ginger is a sex-linked recessive; tortoiseshell is the heterozygote.) What assumptions have you made?

3. Two alleles are present in equal frequencies in a random-mating population. The heterozygote has a viability 5 per cent greater than either homozygote. Would you expect to detect this difference in a sample of 1000 adults?
4. If mating is random, but the gene frequencies at a locus are different in breeding males and females, prove that there is an excess of heterozygotes, relative to the Hardy-Weinberg ratio, among their progeny.
5. At the ABO locus, three alleles determine four phenotypes according to the following scheme: genotypes AA and AO specify the A blood group; BB and BO specify the B group; AB specifies the AB group; OO specifies the O group. In a random mating population, the gene frequencies are $0.3A:0.2B:0.5O$. (a) What blood group frequencies are expected? (b) A child with blood group A has an A father and a B mother. If the child has a full sib, what is the probability that the sib is group A?
6. A monocarpic (flowering only once) species of plant is dioecious (separate sexes), with a 1:1 sex ratio. There are two types of female: type A produces 200 seeds at age 5 years, and type B produces 300 seeds at age 7 years. 98 per cent of seeds fail to give rise to plants; there is no other mortality before flowering. Calculate the net reproductive rate, R_0 , and the Malthusian parameter, r , for each type. Is the population increasing or decreasing? Which type has the higher fitness?
7. A gene with a frequency of $1/100\,000$ in a very large random-mating population increases fitness by 1 per cent. How many generations would it take to raise the gene frequency to $1/100$ if (a) the gene is dominant, (b) the gene is recessive? (Remember that, when p is small, $d\phi/dt = sp^2$; why might your answer to this part of the question be seriously misleading in practice?)

Computer Projects

Consider a population of females, living for a number of years, but breeding only once a year. For each age, choose a constant probability of surviving to that age, and a constant fertility for females that do survive. Write a program that will follow the age distribution in such a population, and use it to check that there is a stable age distribution. (If you know some matrix algebra, it would be interesting to look up the 'Leslie matrix', as a way of representing such a population, and to compare the idea of a stable age distribution with that of an eigenvector.)

Chapter 4— The Variability of Natural Populations

The evidence for genetic variability	49
Mutation	53
The nature of mutation	53
The balance between mutation and selection	55
Deleterious mutations in natural populations	57
The rate of mutation	60
The maintenance of variation	64
Heterosis	65
Frequency-dependent selection	69
A variable environment	70
Balance between selection at different levels	75
Further reading	76
Problems	76
computer projects	77

The Evidence for Genetic Variability

There are two rather different ways in which a population may respond genetically to a changed environment. One, suggested by the examples of melanism and insecticide resistance, is as follows. When the new conditions first arise, the required mutations are either absent or very rare. There is an inevitable delay in the response of the population while the required mutations occur and increase from their initial low frequencies. The implication of Equation 3.6 is that, even for a fully dominant gene, it takes three times as long for the frequency to increase from, say, 1 in 100 000 to 1 in 100 as it does from 1 in 100 to 1 in 10: the subsequent increase from 1 in 10 will be rapid. During the first period, little observable change in the population would occur.

A rather different picture emerges from observations on one of Darwin's Galapagos Island finches, *Geospiza fortis*, on Daphne Major, a small islet of 40 hectares (Boag and Grant 1981). A serious drought in 1977 caused an 85 per cent decline in the population. At the same time, there was an increase in linear dimensions (bill, wing, tarsus) of from 2 to 5 per cent, because the larger birds were better able to survive on the large seeds that were the main available food during the drought. There is good evidence that differences in metrical traits in these finches are mainly genetic. Clearly this response did not depend on initially rare mutations. The relevant genetic variability must already have been present in the population. There are two main sources of information about genetic variability in natural populations. The first comes from the response to artificial selection. If a sample of a sexually reproducing species is brought into the laboratory, it will be found to respond to artificial selection for almost any trait. Box 4.1 lists some of the traits which have responded to selection in *Drosophila*, and also two traits for which no genetic variance was found. There is no reason to think that *Drosophila* is peculiar in this respect.

Given that populations respond to artificial selection in this way, how do we know that the response is due to genetic variance already present, and not to new

**Box 4.1—
The Response of *Drosophila* Populations to Selection**

Characteristics that have been altered by artificial selection in *Drosophila* include the following: abdominal bristle number, wing length, longevity, ovary size, mating speed, tendency to move towards light or upwards in a gravitational field, and degree and nature of expression of mutant genes.

Two extensive experiments failed to produce any genetic change. The first concerned the expression of the mutant ocelliless in *D. subobscura* (Maynard Smith and Sondhi 1960). Mutant flies lacked one or more of the ocelli (simple eyes) and bristles on top of the head. Selection could alter which structures were present and which absent: for example, a population was produced whose members usually had the two posterior ocelli but not the front one. However, an experiment in which all selected parents had the left ocellus but not the right one produced no change from the initial state in which the probabilities of the presence of the left and right ocellus were equal (although selection did increase the frequency of asymmetric flies but left- and right-handed ones equally).

A second trait for which there seems to be little genetic variance in *Drosophila* is the sex ratio. In a particularly large-scale experiment, Toro and Charlesworth (1982) selected for a male-biased sex ratio, by counting many sibships in each generation, and continuing from those with the highest proportion of males. The proportion of males in the initial population was 0.5004, and after nine generations it was 0.4993.

These two experiments show that there are traits that vary, but for which there is no heritable variation. They are, however, exceptional.

mutation? This is usually obvious from the rate of response, which is greatest in the first few generations. More direct evidence is that we do not get an equivalent response if we start from a genetically homogeneous population (produced, for example, by prolonged inbreeding see p. 100).

A second source of information about the genetic variability of natural populations comes from the study of protein variability, particularly by electrophoresis. A piece of tissue (or, in the case of small organisms like *Drosophila*, the whole animal) is ground up to disrupt the cells, and centrifuged to remove insoluble material. The soluble proteins are then placed in a well at one edge of a gel immersed in an electric field. The proteins travel through the gel at a rate depending on their charge and configuration. Those present in large amounts can then be made visible by using a protein stain, but enzymes are present in too low a concentration for this to be possible. However, a specific enzyme can be made visible by supplying an appropriate substrate and a dye that will indicate the occurrence of the relevant reaction. Suppose, then, that a population is segregating

for a pair of alleles at a locus determining a monomeric enzyme. If the resulting enzymes differ sufficiently to be separable on a gel, homozygous individuals will be recognizable by the presence of single bands, in different positions for the two types. Heterozygotes will show both bands. If the enzyme is dimeric, the heterozygote will show the two parental bands, plus a third intermediate band representing the hybrid dimer. These interpretations are often clear-cut, but need checking by breeding experiments in doubtful cases.

Not all genetic variability at a locus will be revealed in this way. Usually, only changes that alter the charge on an amino acid will be detected: the actual proportion will depend on the skill and effort expended. In typical studies perhaps one quarter of all variants are detected, but this figure should not be taken as more than a rough guide. Given a body of data on a number of loci, two measures of population variability can be made:

1. Proportion of loci 'polymorphic' in the population. A locus is treated as polymorphic if the frequency of the commonest allele is less than 0.99. The value chosen is arbitrary, but some choice has to be made. Thus, if one looked for long enough, one would find rare alleles at every locus. The choice of 0.99 is intended to ensure that deleterious alleles maintained by recurrent mutation are not included.
2. Average proportion of loci heterozygous in an individual. This proportion is necessarily lower than the proportion polymorphic. For example, suppose that at some locus there are two selectively neutral alleles, with frequencies 0.2 and 0.8. This locus is polymorphic, but, if mating is random, only $2 \times 0.2 \times 0.8$, or 32 per cent of individuals are heterozygous.

Some data on electrophoretic variability in natural populations are given in Box 4.2.

Ultimately, the only way of finding out what fraction of the total genetic variability in a population is detected by a technique such as electrophoresis is to determine the DNA sequence of a sample of genes at a locus from that population. This is a less laborious task than it used to be. A classic study is Kreitman's (1983) sequencing of 11 allelic genes from *Drosophila melanogaster* coding for the enzyme alcohol dehydrogenase. There is an almost universal polymorphism for two electrophoretically separable alleles, *F* and *S*, at this locus, caused by the substitution of threonine by lysine at a particular site. Kreitman sequenced five *Adh-F* and six *Adh-S* alleles. He found no variation among his 11 genes (other than the *F-S* polymorphism itself) that would cause a change in the protein coded for. This suggests that the variability detected by electrophoresis is a substantial part of the total protein variability.

However, he did discover a number of previously hidden polymorphisms, including 13 base substitutions in the coding region of the gene that, because of the redundancy of the code, do not alter an amino acid, and 29 further substitutions in

**Box 4.2—
Electrophoretic Variability**

Table 4.1 summarizes a large body of data on the electrophoretic variability of natural populations. The main conclusion is that most species show extensive variability: usually more than 10 per cent of the loci examined were found to be polymorphic. The main trend observable from the table is that vertebrates tend to be less variable than invertebrates. A more detailed look at the data (Fig. 4.1) shows that the variability of most invertebrates is rather similar to that of vertebrates (average heterozygosity less than 0.1), but that a substantial fraction show very high variabilities.

Table 4.1

Electrophoretically detectable variability in animals and plants (from Futuyma 1986, data mainly from Selander 1976).

	Number of species examined	Average number of loci per species	Average proportion of loci Polymorphic per population	Heterozygous per individual
Insects				
<i>Drosophila</i>	28	24	0.529	0.150
Others	4	18	0.531	0.151
Haplo-diploid wasps	6	15	0.243	0.062
Marine invertebrates	9	26	0.587	0.147
Marine snails	5	17	0.175	0.083
Land snails	5	18	0.437	0.150
Fish	14	21	0.306	0.078
Amphibians	11	22	0.336	0.082
Reptiles	9	21	0.231	0.047
Birds	4	19	0.145	0.042
Rodents	26	26	0.202	0.054
Large mammals	4	40	0.233	0.037
Plants	8	8	0.464	0.170

People have searched for other factors associated with electrophoretic variability. Only three such factors are well established:

1. Monomeric enzymes are more variable than multimeric ones.
2. Proteins of high molecular weight are more variable than smaller proteins.
3. Large populations are more variable than small ones. For example, populations that have been confined for a long time to a cave or island tend to be uniform. A striking case is the cheetah. All individuals examined from

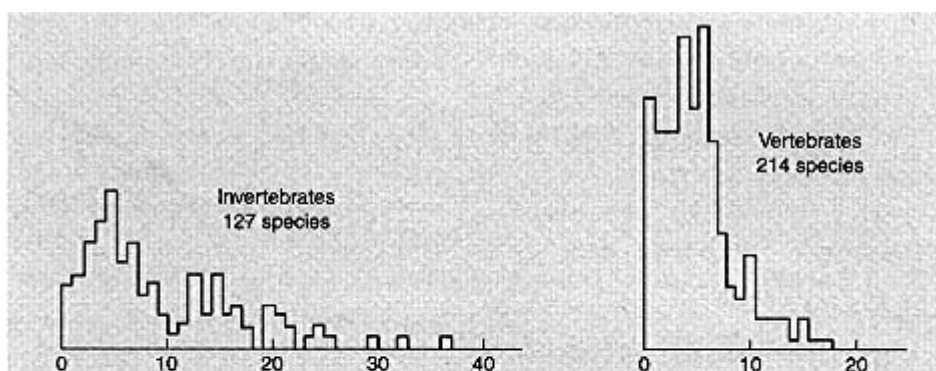

Figure 4.1 Distribution of average heterozygosity for species of invertebrates and vertebrates. Only species in which 20 or more loci were examined are included. (From Nei and Graur 1984.)

East Africa were monomorphic at all 52 loci studied (O'Brien *et al.* 1985). Skin grafts between individuals were accepted, as they are between members of an inbred line of mice. This degree of uniformity is greater than would be predicted from the present numbers of cheetahs (although that number is not large), and suggests a small bottleneck of numbers in the recent past.

These three generalizations are consistent with the 'neutral mutation theory', discussed in Chapter 8. For further details, see Nei and Graur (1984).

non-translated regions of the chromosome ('introns' and flanking regions see p. 203).

A technique of detecting genetic variability that is increasingly used in population genetics, because it is more sensitive than protein electrophoresis, but less time-consuming than DNA sequencing, is the use of restriction endonucleases. There are enzymes that cut DNA at particular sites. The method is discussed further on p. 87.

Data from electrophoresis and from artificial selection tell the same story: natural populations of sexual species are genetically variable. The rest of this chapter is concerned with the processes that cause and maintain that variability. I first discuss mutation, the origin of all genetic variation; I then consider processes that can maintain two or more alleles at intermediate frequencies in a population.

Mutation

The Nature of Mutation

A mutation can be defined as any change in the base sequence of the DNA in the genome. Mutations may involve:

1. Base substitution: the replacement of one base by another.
2. The insertion or deletion of single bases. Such mutations involve a 'frame shift' in the process of translation.
3. Inversion of a section of DNA. Figure 4.2 shows that this results in the insertion into the transcribed strand of an inverted portion of the complementary strand, and is therefore likely to be lethal if it occurs in a non-essential region of the DNA. Viable inversions presumably involve breaks in non-essential regions, and are such that the instructions concerning which strand is to be transcribed are preserved.
4. Duplication or deletion of a section of the DNA.

These kinds of mutation occur at different rates, and are differently affected by mutagenic agents, but there is no reason to think that there is any constraint *at the level of the DNA* on what mutations can occur. Some kinds (for example, Type 2) are almost certain to be lethal if they occur in an essential region of the DNA. But this is a constraint on what mutants will survive, and not on what will occur in the first place. In any particular species there will be severe limitations on the kinds of adult mutant phenotypes one observes: one will not find adult insects, or vertebrates, with an occluded gut. But these constraints arise from physiology and development, and not from the mutational process itself: so far as we know, there is no class of DNA sequence that cannot arise by mutation.

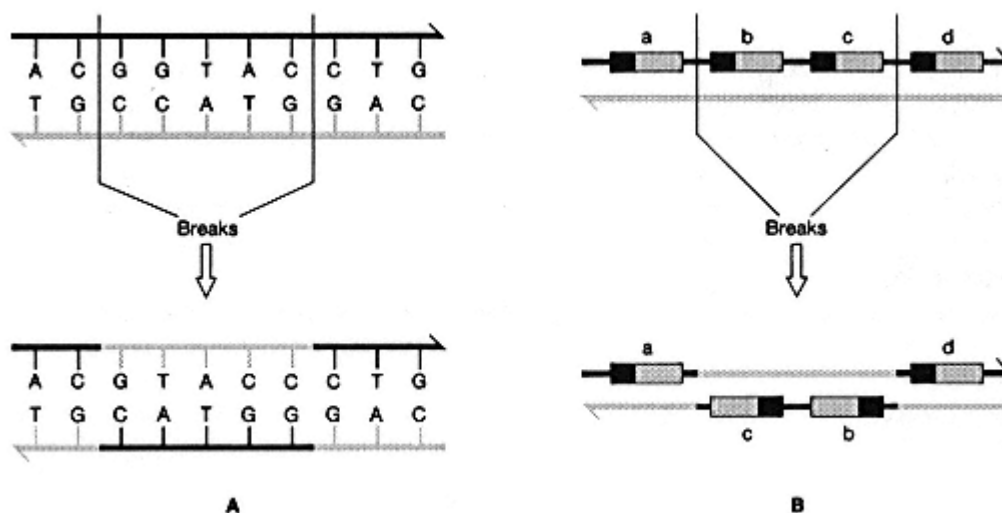

Figure 4.2

Intragenic (**A**) and chromosomal (**B**) inversions. In both diagrams, the transcribed DNA strand is indicated by a bold line. In **A**, the breaks occur within a transcribed region, and the resultant protein is almost certain to be non-functional. In **B**, the breaks occur in non-transcribed regions. Each of the four transcribed regions, a, b, c, and d, has its own signal (indicated by a black region) indicating the start of transcription. The inversion, therefore, need have no phenotypic effect.

The Balance Between Mutation and Selection

It is common sense that most mutations that alter fitness at all will lower it. Ransom changes are as likely to lower the fitness of organisms as they are to reduce the efficiency of automobiles or computer programs. I start the study of mutation, therefore, by considering the distribution of deleterious mutations in populations, first in a theoretical model, and then empirically.

How many deleterious mutations do we expect to find in natural populations? We answer this question by noting that, in the long run, the rate at which new deleterious mutations occur must equal that at which mutations are eliminated by selection. Consider a large random-mating population of size N . At some locus, a symbolizes the wild-type allele and A a mutant allele (or class of alleles). If p is the frequency, in new zygotes, of A , we have:

Genotype	aa	Aa	AA
Fitness	1	$1 - hs$	$1 - s$
Number of zygotes	Nq^2	$2Npq$	Np^2

First we calculate the number of A genes, present in these zygotes, that are lost by selection. There are $2Np$ A genes, of which a proportion hs die selectively. Each death eliminates one A gene. Hence $2Npqs$ A genes are eliminated in heterozygotes. There are Np^2 AA homozygotes, of which a proportion s die: each death eliminates two A genes. In total, then

$$A \text{ genes lost} = 2Npqhs + 2Np^2s = 2Nps(qh + p).$$

Also, in each generation, new A genes arise by mutation. Let the mutation rate from a to A (i.e. the probability, per generation, that an a gene will mutate to A) be u . There are $2Nq$ a genes in the population, and hence $2Nqu$ new A genes arise by mutation in each generation. (We ignore back mutation from A to a for two reasons. First, there are relatively few A genes. Secondly, there are many possible mutation changes that will convert a functional (a) gene into a non-functional one (A), but there may be only one that will restore function to A .)

At equilibrium the number of new mutations equals the number eliminated. That is,

$$\begin{aligned} 2Nqu &= 2Nps(qh + p), \\ \text{or } qu &= ps(qh + p). \end{aligned} \quad (4.1)$$

If A is fully recessive ($h = 0$), $qu = p^2s$, or, since $q \cong 1$,

$$p \cong \sqrt{(u/s)}. \quad (4.2)$$

If A is partially or wholly dominant, $p \cong qh$, so

$$p \cong u/sh. \quad (4.3)$$

In the special case of a dominant lethal, $sh = 1$, and hence $p = u$. All mutants in the population in this generation arose in the last one.

What fraction of the population dies each generation because of deleterious mutation at a locus? This fraction is known as the **mutational load**.

Consider first a fully recessive gene. From Equation 4.2, the fraction of the population affected is $s^2 = u/s$. Of these, a proportion s die. Hence the mutational load is $u/s \cdot s = u$. For a partially or wholly dominant deleterious gene, homozygotes are very rare, and we need only take account of the heterozygotes, whose frequency is approximately $2p = 2u/sh$. Of these, a proportion sh die. Hence the mutational load is $2u$.

Note that the mutational load at a locus depends only on the mutation rate, and not on the selective coefficient. This conclusion could have been reached without going through the algebra of the preceding paragraphs. The essential point is that, at equilibrium between mutation and selection, the number of new mutations occurring in the population in a generation equals the number eliminated by selection. The number of new mutations in a diploid population of size N is $2Nu$ per generation. If the mutation is dominant, each selective death removes only one mutant gene, so $2Nu$ deaths must occur every generation. For a recessive, each death removes two genes, so Nu deaths must occur. Note that this argument, originally due to J.B.S. Haldane, has not assumed random mating. The mutational load is not only independent of s ; it is also independent of the mating system.

Can we combine the mutational loads from many loci, to obtain a total load? Suppose, for example, that the load at a single locus is 0.001, and that there are 1000 loci. Does this imply a total load of $1000 \times 0.001 = 1$; that is, does mutation cause the death of the whole population? Things are not quite as bad as that. Thus the chance that an individual will not die because of mutation at a particular locus is 0.999. If we can assume that his chance of dying because of mutation at one locus is independent of his chances of dying because of mutation at other loci, then his chance of surviving is $(0.999)^{1000} = 0.368$, so that the total mutational load is 0.632. But can we assume that loci act independently in this way? Only if the following two things are true:

1. The presence of a mutation at one locus is independent of the presence of mutations at others: this is usually a reasonable assumption.
2. The effect of mutations on fitness are multiplicative: that is, the fitness of an individual with several mutations is the product of the fitnesses of individuals carrying each mutation on its own. This assumption is reasonable for lethal or serious mutations, but doubtful for less serious ones. Thus suppose that individuals with only one or two mutations suffer no serious loss of fitness, but that the presence of a larger number does seriously reduce fitness: that is, they act **synergistically**. Then the total mutational load will be lower than that based on the multiplicative assumption, because each selective death removes a

larger number of mutations. There is some evidence that mildly deleterious mutations do act synergistically.

The idea of a genetic load can be related to that of mean fitness, $\bar{W} = \sum P_i W_i$, where P_i is the frequency of the i th genotype, and W_i is its fitness. Thus let the load be L . Then the fraction of the population surviving, relative to the fraction that would survive if all had the fittest genotype, is $1 - L$. This can be written

$$\begin{aligned} 1 - L &= \frac{\bar{W}}{W_{\text{MAX}}}, \\ \text{or} \quad L &= \frac{W_{\text{MAX}} - \bar{W}}{W_{\text{MAX}}}. \end{aligned} \quad (4.4)$$

In this form, the idea of a genetic load can be applied in contexts other than recurrent mutation (see, for example, Problems 6, 7, and 8).

Deleterious Mutations in Natural Populations.

Much of what we know about deleterious mutations in natural populations depends on *Drosophila*, and in particular on the technique of extracting a chromosome from an individual, and producing a population of flies homozygous for replicas of that chromosome. This technique, invented by H.J. Muller, is shown in Fig. 4.3. It depends on:

1. the fact that there is no recombination in male flies; and
2. the possibility of eliminating (or at least reducing to a very low level) recombination in the female by introducing complex inversions.

In this way, one can ensure that a single chromosome is replicated, if necessary for many generations, without possibility of recombining.

In the final generation of Fig. 4.3, if there were no viability differences we would expect approximately $1 + 2M$ phenotypes. If there is a lethal mutation on the 'wild-type' chromosome, we expect no wild-type progeny. The experiment therefore provides a way of measuring what fraction of chromosomes, extracted from a wild population, carry lethal mutations. Measurements of this kind have been made on a number of *Drosophila* species. When allowance is made for the fact that, by chance, some 'lethal' chromosomes carry more than one lethal gene, and for the fact that the measured chromosome is only part of the whole genome, it turns out that an average of one lethal (or almost lethal) mutation per genome is typical (the estimates ranged from 0.33 to 2.37).

It is critical that, in these experiments, what we demonstrate is the lethality of a chromosome when homozygous: we can only deduce that the lethality is caused by genes at one or a few loci. There is no way we can produce flies that are homozygous at one gene locus, but segregate randomly elsewhere.

Given that estimates of the percentage of lethal second chromosomes in

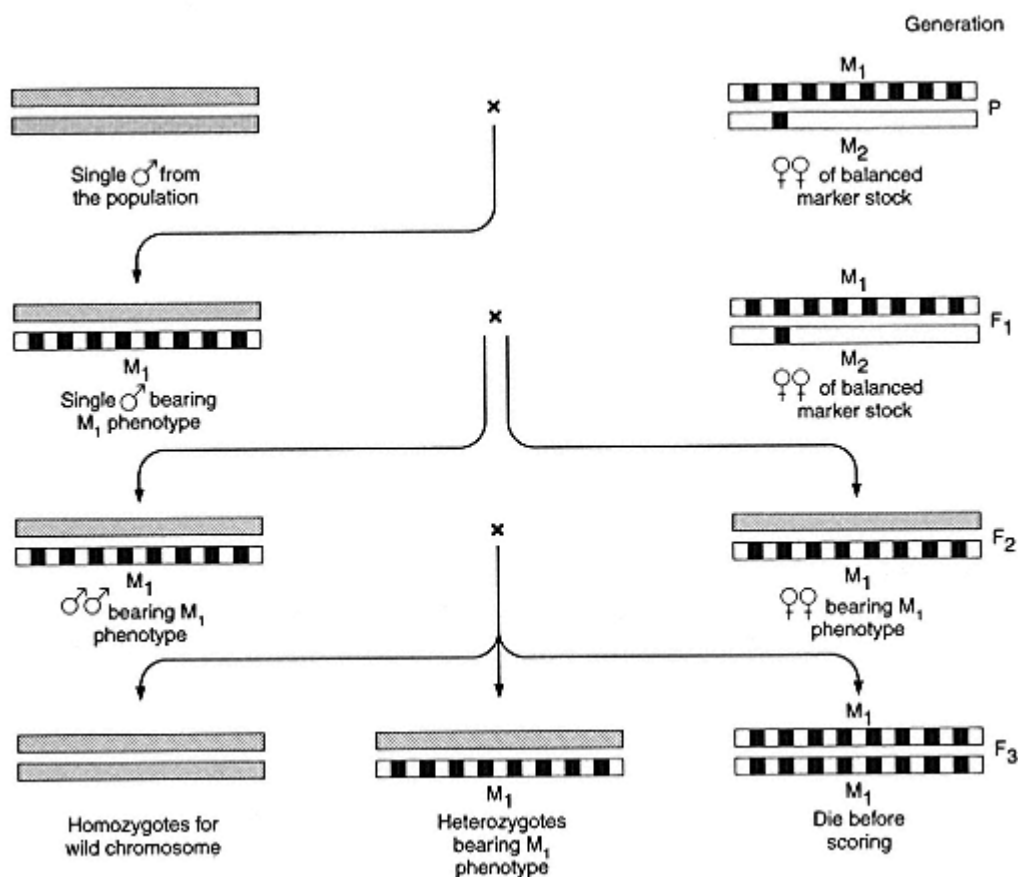

Figure 4.3

Replication scheme for sampling a chromosome from a population and providing a large number of individuals homozygous for that chromosome (from Lewontin 1974).

populations of *Drosophila melanogaster* varied from 12.3 to 61.3, we can ask how many gene loci there are on that chromosome at which lethal mutations are possible: that is, how many 'essential' genes are there? There are two quite different ways of answering this question:

1. We can look at the 'allelism' of the lethals we find. If the heterozygote between two lethal chromosomes is itself lethal, then the two chromosomes carry allelic lethals. To use this method, clearly we must have lethals extracted from different populations. You will understand this method better when you have solved Problem 2.

2. We can induce lethals in a particular chromosome region, and find out how closely they are packed. For example, Hochman (1971) estimated that there are 36 loci susceptible to lethal mutation on the fourth chromosome of *D. melanogaster*, which is about 2.6 per cent of the euchromatic length of the genome.

Fortunately, these two methods give approximately the same answer: there are 1000 essential gene loci in *Drosophila*. Since there is about one lethal mutation per genome, this implies a frequency, per lethal, of 0.001.

What of the viabilities of flies homozygous for chromosomes that do not carry lethal genes? To answer this question, it is not enough to count offspring in a cross of the kind shown in Fig. 4.3, and compare the results with the expected 1:2 ratio, because $+/M$ flies are also of reduced viability. We therefore proceed as follows. Let $+^1$ and $+^2$ be two wild-type chromosomes. We compare the offspring ratios in crosses of the kind $+^1/M \times +^1/M$ (giving homozygous viabilities) with ratios in crosses $+^1/M \times +^2/M$ (giving heterozygous viabilities). The method is illustrated in Problem 9. Figure 4.4 shows the results of such an experiment. It is clear that, not only are there lethal chromosomes, but also that most non-lethal chromosomes have lowered viability.

Again, there is no way of telling whether the reduced viability of a given chromosome is caused by a few mutations, or by many mutations of small effect. Also, it is not clear from the figure whether the overlap between the two distributions represents experimental error (only 200 flies were counted from each cross), or whether there are chromosomes of high viability in the homozygote. Population cage experiments help to answer this question. If a cage is set up containing $+^1/M$ flies only, then the lethal mutant M will be eliminated if $+^1/+^1$

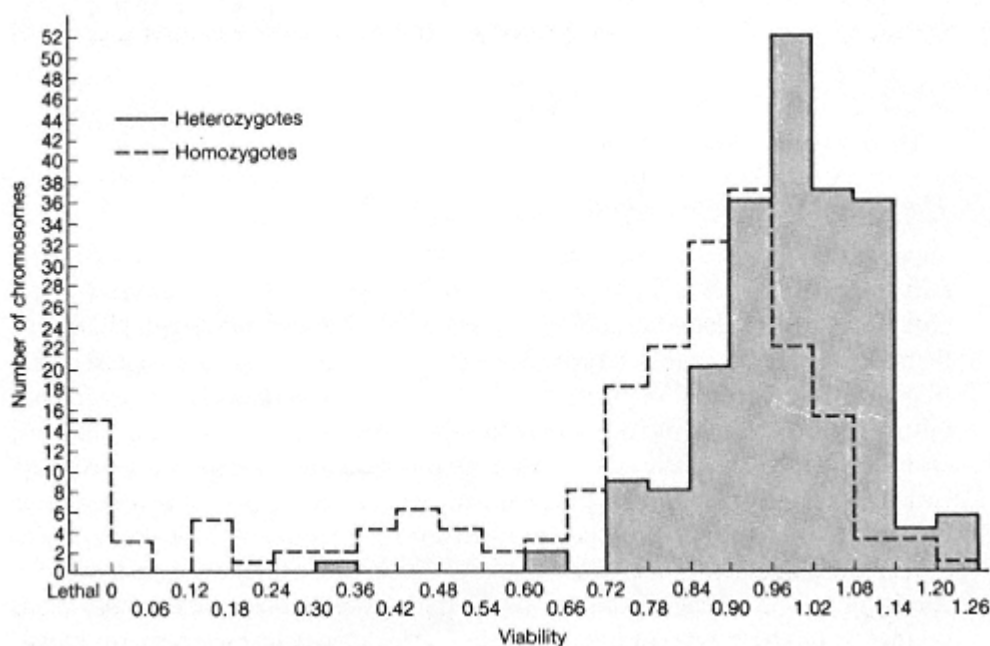

Figure 4.4
Relative viabilities of second chromosome homozygotes, and heterozygotes, in
Drosophila pseudoobscura (data from Dobzhansky *et al.* 1963).

is fitter than $+^1 / M$. In fact, such cages continue to segregate for M . However, if the cage is set up with many wild-type chromosomes, $+^1 / M$, $+^2 / M$, $+^3 / M$, and so on, the mutant M is rapidly eliminated. But it has so far proved impossible to find a wild-type chromosome that, in homozygous condition, is fitter than $+^1 / M$. Notice that in population cage experiments not only viability but other fitness components (e.g. fecundity, mating success, longevity) are relevant. Probably for this reason the average fitness of $+^1 / +^1$ homozygotes, compared to $+^1 / +^2$ heterozygotes, is about 0.25, which is much lower than the viability data of Fig. 4.4 suggest.

To conclude, both lethal and deleterious mutations are common in natural populations. Very approximately, *Drosophila* populations carry one lethal mutation per genome, and there are 1000 essential loci, so that a typical frequency for a lethal recessive is 0.001. Most chromosomes from natural populations are of low fitness in homozygous condition, and often of very low fitness.

The Rate of Mutation.

The last section was concerned with the 'standing crop' of deleterious mutations. I now turn to the problem of estimating the rate at which new mutation is occurring. There are in fact at least four different kinds of rate that one might estimate:

- (1) the rate of base substitution, per base, per replication;
- (2) the rate at which new mutations occur at a gene locus, per generation;
- (3) the rate at which lethal or deleterious mutations accumulate on a chromosome;
- (4) the rate at which new phenotypic variance is generated by mutation.

These will be considered in turn.

The Rate of Base Substitution

Suppose that, in a bacterium such as *E. coli* that is able to live in the absence of a particular nutrient say tryptophan one isolates a mutant unable to grow in the absence of tryptophan, because it lacks a particular enzyme, tryptophan synthetase; this is referred to as **forward mutation**. It is then possible to measure the frequency in a bacterial population of cells carrying **back mutation**, by plating out, say, 10^9 cells and counting the relatively small number of growing colonies, each derived from a single cell carrying a back mutation. One must then convert such a measure of the frequency of cells carrying a back mutation into an estimate of the rate of back mutation per cell division: one simple way of doing this is illustrated in Problem 10. It is also necessary to check that a growing colony does consist of cells in which the original forward mutation in the gene for tryptophan synthetase has been reversed, and not cells in which the defect has been overcome in some other way.

If the original forward mutation is known to be a change in a single base, say

A → T, then a measurement of back mutation estimates the rate of mutation T → A per cell division (that is, per replication). One conclusion from such experiments is that rates are rather variable, and depend on the neighbouring bases. However, most values lie in the range 10^8 - 10^{10} . The rate is similar for prokaryotes and simple eukaryotes. Data on higher eukaryotes (e.g. mammals) are harder to obtain, but suggest a similar value.

It is worth asking how such an astonishing degree of accuracy is achieved. There are three stages. In the first, a polymerase enzyme inserts a new base, with a probability of error of about 1 in 10^8 . This is the only stage in RNA replication, and hence this is the per base mutation rate. In DNA replication, there is then a **proof-reading** stage: an enzyme bound to the polymerase recognizes wrong bases, and removes them, giving the polymerase a second chance to insert the correct base. The chance of an error escaping detection at this stage lies between 1/100 and 1/1000. Finally, there is a third stage **mismatch repair**. Immediately after replication, when the new and old strands are still distinguishable (for example, because the new strand is not yet methylated), an enzyme recognizes any remaining mismatch. If one is detected, the new strand is removed, for some hundreds of bases, and resynthesized. The chance of an error escaping detection at this stage is about 1/100. Combining these three stages gives an estimated mutation rate of between 10^8 and 10^9 . Actual measurements suggest that accuracy is better than this by a factor of about 10; this is not a serious disagreement for such a difficult measurement.

The Rate of Mutation at a Locus

By a sufficient expenditure of hard work, we can record the frequency with which mutations occur at specific loci. For example, Schleger and Dickie (1971) found 25 new coat-colour mutations at five loci in the mouse, in over two million gametes tested, giving an average rate of visible mutants of 1.1×10^{-6} per locus, per generation. Two separate estimates of the rate at which new electrophoretically detectable mutations occurred in *Drosophila* were close to 4×10^{-6} , per locus, per generation.

These estimates cannot be very accurate, but they are clearly much higher than those for base substitution rates. There are two reasons for this. First, a 'generation' in a mouse or a fly represents 20-30 cell divisions (remember, $2^{20} \cong 10^6$, so 20 cell divisions can give a million cells). Thus the values just quoted for mice and *Drosophila* suggest a rate per cell division of between 10^8 and 10^7 . This agrees rather well with estimates of the rate per cell division in bacteria of mutations destroying the function of genes specifying enzymes. Hence, it seems that mutation rates per cell division are similar in prokaryotes and eukaryotes.

A second reason why these per-locus rates are much higher than base substitution rates is that many different base substitutions would be recorded as

mutations. Thus suppose an enzyme contains 200 amino acids. The corresponding gene contains 600 coding bases, each of which can mutate in three ways, giving a total of 1800 different possible base substitutions. Not all of these would be recorded as mutations. Because of the redundancy of the code, some would be 'synonymous', and would make no alteration in the protein produced. Some that did alter the amino acid composition of the protein would not alter its function in a recognizable way. But probably between 100 and 1000 of the possible substitutions would be detectable, so that measured rates per gene locus, per replication, should be greater by two or three orders of magnitude, as in fact they are.

Before leaving the problem of per locus mutation rates, it is worth asking whether we cannot use an indirect method of estimation, based on Equation 4.1. Thus data suggest a frequency in natural populations of *Drosophila* of recessive lethals per locus of the order 0.001. If $fu = p^2$, this implies a per generation mutation rate of 10^6 . Since this agrees reasonably well with the direct estimates, we can rest content, but there are good reasons for distrusting such indirect estimates, at least for autosomal recessive mutations. First, we do not know that the mutations are fully recessive. As is clear from Equation 4.1, if the mutant is only slightly deleterious (or beneficial) in heterozygotes, this would substantially alter our estimate of fu . Secondly, the equation assumes random mating. If mating between relatives is common, this also would alter our estimate of fu . For these reasons, it is best to regard any agreement between indirect and direct estimates as a lucky accident.

These objections do not apply to dominant lethal mutations, and are less serious for sex-linked mutations. Problem 3 gives a numerical example for chondroplasia in humans. The estimated mutation rate is 4.3×10^{-5} . Although there is no reason to doubt this estimate, there cannot be many dominant mutations with rates as high as this.

The Accumulation of Deleterious Mutations

By a simple extension of the breeding system of Fig. 4.3, one can maintain a single chromosome heterozygous and free of crossing over for many generations, and then measure its viability in homozygous condition. Mukai (1969) maintained 101 second chromosomes of *D. melanogaster* for 60 generations in this way, testing them for viability at intervals. As expected, some chromosomes accumulated lethals or sub-lethals: these are omitted from the analysis. (In fact, Mukai estimated a rate of accumulation of lethals of 0.0063 per generation: if we assume 300 loci susceptible to lethal mutation, this implies a per locus rate of 2.1×10^{-5} , which agrees well with the per locus rates quoted in the last section.) The results are plotted in Fig. 4.5. After 60 generations, the mean homozygous viability of chromosomes lacking well-defined lethals had fallen to about 50 per cent of its initial value.

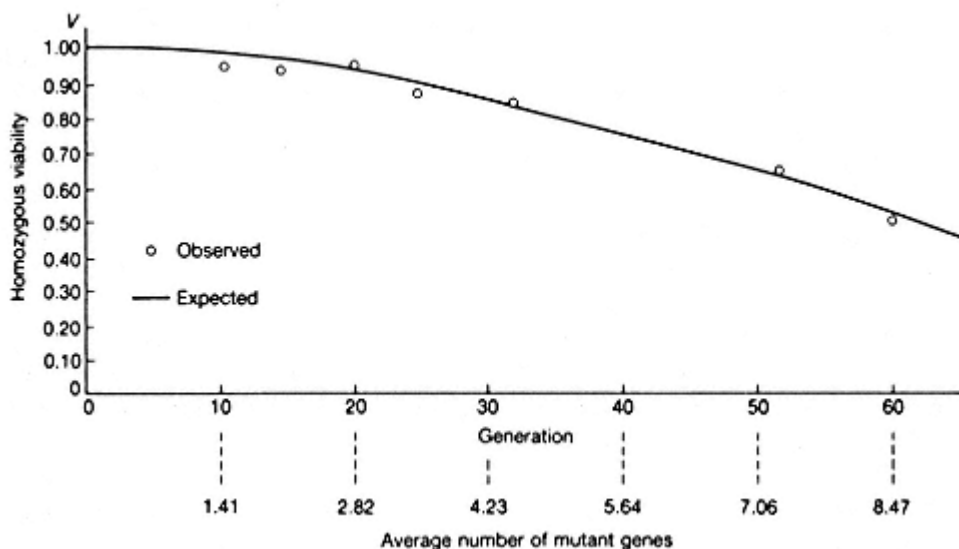

Figure 4.5

Average viability of homozygotes for *D. melanogaster* chromosomes, kept in heterozygous condition for varying numbers of generations. Lethal and sub-lethal chromosomes are omitted.

The average number of mutant genes per chromosome was estimated from the variance in viability between lines. The full line gives the expected viability, assuming a mutation rate of 0.14 per chromosome, per generation. (After Mukai 1969.)

Can we decide whether this decline was caused by mutations at many loci on each chromosome, each of small effect, or to relatively few mutations, each of large effect? The only clue we have is the variability between chromosomes. Thus if large numbers of mutations at many loci are responsible, we would expect all lines to respond in much the same way, whereas if few mutations are involved, some chromosomes will be free of mutation and others will have several, and there will be appreciable variation in viability. Hence, by using the observed variability between lines, and assuming that all mutations have equal effects on viability, one can estimate the most plausible number. This best estimate indicates a mutation rate of 0.14 per generation, and an average number of eight mutations per chromosome after 60 generations. If this is correct and the argument is reasonable it implies that the rate of slightly deleterious mutations is over 20 times higher than the rate of lethal mutations.

The Generation of Phenotypic Variation by Mutation

If one extends the breeding system of Fig. 4.3 to include all the main chromosomes simultaneously, it is possible to construct an 'isogenic line', homozygous at almost all loci. Such lines are usually sick and hard to maintain. If all differences between flies were caused by genes, then the members of an isogenic line would be pheno-

typically identical. Of course they are not: indeed, they are often more variable in morphology than wild populations. However, they do conform to theoretical prediction in one important respect—they lack *heritable* variation: for example, if one selects and mates together the largest flies, their offspring are on average no larger than the rest of the population. How rapidly does mutation restore heritable variation to an isogenic line? Clayton and Robertson (1955) estimated that between 0.1 per cent and 0.2 per cent of the variation typical of a natural population is generated by mutation in each generation. In other words, it would take between 500 and 1000 generations for mutation to restore the original genetic variability for phenotypic traits such as size or bristle number. As will be explained in Chapter 6, this observation is somewhat paradoxical, since it seems to require a higher per-locus mutation rate than is suggested by other types of measurement.

We can now summarize our conclusions about mutation rates, although it is important to remember that these are based on rather few experiments, and still fewer organisms. In particular, the reliance on the chromosome-manipulating techniques available in a single species *Drosophila melanogaster*, is worrying. With these reservations:

1. The error rate per base per replication is of the order of 10^{-10} . There is no reason to think it is very different in prokaryotes and eukaryotes.
2. The rate of mutation producing visible or lethal effects, per gene locus per generation, in higher eukaryotes is of the order of 10^{-5} .
3. Slightly deleterious mutations are more frequent than lethals, and perhaps 20 times as frequent. A likely explanation for part of this difference is that there are non-essential gene loci at which mutations are mildly deleterious but not lethal.
4. Phenotypic variation in morphological traits is generated by mutation at a rate per generation of about 0.1 per cent of the variation typical in natural populations.

The Maintenance of Variation

We are not in a position to offer a classification of the causes of variation in natural populations:

1. *Variation selectively neutral*. Different types do not differ appreciably in fitness, and hence none has been eliminated by selection. To analyse this possibility requires that we consider finite populations, so discussion is postponed to Chapter 8.
2. *Selection-mutation balance*. Less fit types are maintained in the population by repeated mutation. For mutations at specific loci, this was discussed above on p. 55. The possibility that variation for quantitative traits is maintained in this way is discussed in Chapter 6.

3. Balance of selective forces.

- (a) Heterosis: the heterozygote at a locus is fitter than either homozygote;
- (b) frequency-dependent selection;
- (c) fitnesses vary in space and time;
- (d) selection acts differently at different levels.

Before discussing the various processes under 'Balance of selective forces' in detail, it is worth making a general point about method. If we want to show that two alleles A and a , are maintained by selection in a population, it is usually sufficient to show that each of them will increase in frequency when rare. It is easier to show this than it is to find the frequency p , at which there is a stable equilibrium. If we can show that each allele increases when rare, we have demonstrated the existence of **protected polymorphism**.

Heterosis

Suppose that the fitnesses of the three genotypes at a locus are:

Genotype	AA	Aa	aa
Fitness	$1 - s$	1	$1 - t$

It is at once obvious that there is a protected polymorphism. Thus when allele A is rare, the population consists primarily of aa individuals, with a few Aa . Allele A then occurs in individuals of higher-than-average fitness, and therefore increases in frequency. By an identical argument, allele a increases when rare.

What is the frequency, \hat{p} , at which there is an equilibrium? The standard, and clumsy, way of answering this question is as follows. Define the frequency of A in generation n as p_n . Calculate (exactly as in Equation 3.5) the value of p_{n+1} in terms of p_n , s and t . At equilibrium, p does not change, so $p_{n+1} = p_n = \hat{p}$. This equation can be solved for \hat{p} . The only objection to the method is that the algebra is rather messy.

An alternative method is to calculate the 'fitnesses' of the genes: that is, the number of copies in the next generation of a gene in this. Thus the fitness of allele A is given by:

$$\begin{aligned} & (\text{probability that } A \text{ finds itself in an } AA \text{ genotype}) \times (\text{fitness of } AA) + \\ & (\text{probability that } A \text{ finds itself in an } Aa \text{ genotype}) \times (\text{fitness of } Aa). \end{aligned}$$

$$\begin{aligned} \text{That is,} & \quad W(A) = p(1 - s) + 1 - p, \\ \text{and similarly,} & \quad W(a) = p + (1 - p)(1 - t). \\ \text{At equilibrium,} & \quad W(A) = W(a), \text{ or } p = t/(s + t). \end{aligned} \tag{4.5}$$

This possible method of maintaining variability has been familiar since the early days of population genetics. The classic example was sickle-cell anaemia. A mutant

of the β chain of haemoglobin in humans, symbolized S , has the following properties:

S/S homozygotes die of anaemia,

$S/+$ heterozygotes do not suffer from anaemia, but are resistant to malaria,

$+/+$ homozygotes are susceptible to malaria.

It follows that, in regions where malaria is a significant selective force, the heterozygote is the fittest of the three genotypes. In some malarial regions of Africa, the S allele is present in frequencies as high as 15 per cent.

Until the development of electrophoretic methods, however, it was rarely possible to recognize all three genotypes at a locus, so the prevalence of heterosis was hard to evaluate. When extensive electrophoretic data became available, it was widely expected that many other examples of heterosis would be discovered. This expectation was strengthened by the fact that it is physiologically plausible that a heterozygote, with two enzymes catalysing the same chemical reactions, but with different rate constants, specificities, or dependence on physical conditions, might be fitter than either homozygote. This expectation, however, has not been realized, and this has led most population geneticists to conclude that single-locus heterosis is a rare phenomenon. I am not convinced. Thus, it was clear from the outset that we could not expect to find many polymorphisms with the large fitness differences characteristic of sickle-cell anaemia. Fitness differences of 1 per cent or less would be quite sufficient to account for genetic variability, but would not be easily demonstrated. The matter is discussed further in Box 4.3.

Box 4.3—

Further Data on Heterosis

The best studied example of heterosis, by Dobzhansky and his colleagues, concerns variation in chromosome order in *Drosophila pseudoobscura*. All natural populations of this species are polymorphic for gene order on chromosome III. A number of gene orders, with names like STANDARD, ARROWHEAD, and CHIRICAHUA, are found. Individuals can only be classified for gene order when they are larvae, by examining the salivary gland chromosomes. There is good evidence that heterosis accounts for the variability. The strongest comes from studies in population cages, in which flies can be maintained for many months, and samples of larvae can be taken from time to time and classified for gene order. A typical experiment is shown in Fig. 4.6. A population approaches the equilibrium frequency from above and below, demonstrating that the equilibrium is stable. Adult flies taken from the cage can be classified by a breeding test: thus if a fly is mated to one of known chromosome type, and its larval offspring characterized, the genotype of the tested fly can be deduced. When this was done, an excess of heterozygotes was found over that predicted

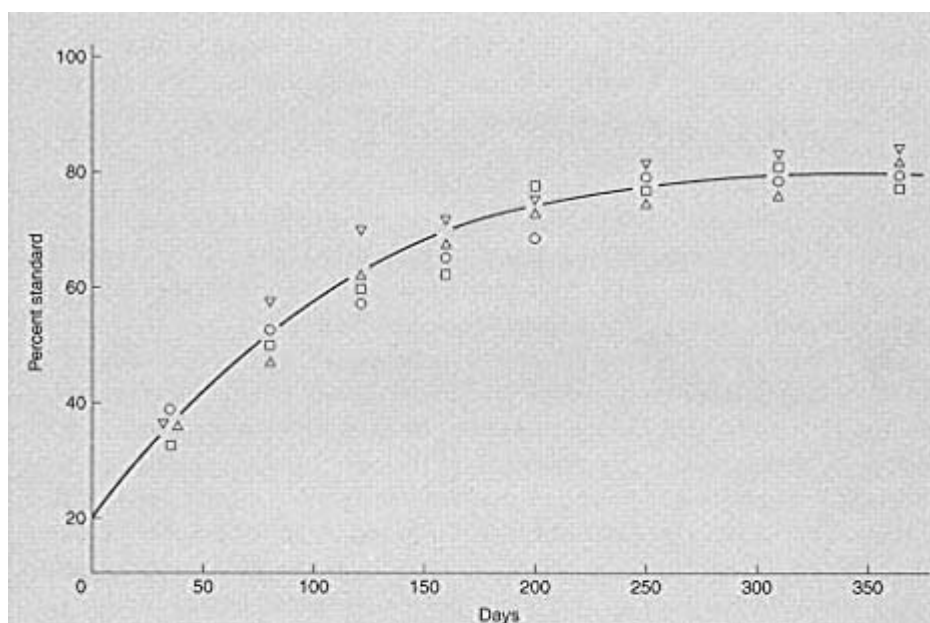

Figure 4.6 Frequency of STANDARD chromosomes in a population cage experiment with *Drosophila pseudoobscura*. Data from four replicates are shown. The populations were started with 20 per cent of STANDARD and 80 per cent of CHIRICAHUA chromosomes. (After Dobzhansky 1951.)

by the Hardy-Weinberg ratio. That this was due to selection, and not to assortative mating, was demonstrated by taking samples of eggs from the cage. If these were raised in optimal conditions, with little mortality, the resultant larvae were found to fit the Hardy-Weinberg ratio in chromosomal type.

There is no serious doubt that chromosomal polymorphism in *D. pseudoobscura* is maintained by heterosis. A few comments are needed. First, inversion polymorphism is widespread in the Diptera, but rare in most other taxa. This is because, in most taxa, meiosis in inversion heterozygotes leads to a proportion of aneuploid gametes, and hence lowered fertility. This does not happen in the Diptera, because there are no chiasmata in male meiosis, and in female meiosis any aneuploid nuclei that are formed finish up in the polar bodies, and not in the egg pronuclei.

A second comment concerns the relation between chromosomal and genetic heterosis. Almost certainly, the superior fitness of inversion heterozygotes in *Drosophila* has nothing to do with the effects of the inversion itself, but arises because different chromosome orders carry different alleles. There is electrophoretic evidence that this is so. It arises because genetic recombination between different orders is rare or absent. However, two kinds of allelic effects

on fitness could be involved (Fig. 4.7). In Type I, inversion heterozygotes are also heterozygous for heterotic alleles at various loci: in this case, inversion heterosis is caused by genic heterosis. In Type II, the advantage of inversion heterozygotes arises from interactions between loci. I have shown the simplest kind of interaction: each order carries one recessive deleterious mutation. Therefore, both gene order homozygotes have a lower fitness than the heterozygote, yet there are no individual loci that are heterotic. It is because of this second possibility that one cannot conclude from the prevalence of inversion heterosis that there is also widespread genic heterosis.

One advantage of population cage experiments is that they enable us to observe the cumulative effects of selection over many generations. One might therefore suppose that the method could be used to investigate heterosis at single loci, when selection is too weak to measure over a single generation. Such experiments would indeed be decisive if it were not for the phenomenon of linkage. The relevance of linkage is illustrated by an experiment by Jones and Yamazaki (1974) on the esterase-6 locus in *Drosophila pseudoobscura*. They found that if they established a population cage, segregating for two alleles at this locus, with only a small number of flies, there were marked changes of frequency at the enzyme locus. But if the cage was established with a large number of flies, the frequency changes were less marked. This strongly suggests that the changes observed in the first type of cage were caused by selection, not on the esterase locus itself, but on loci linked to it.

An alternative method (Mitton and Grant, 1984) of deciding whether electrophoretic variability is maintained by heterosis is to take a sample of individuals from a natural population and record for each its growth rate (or some other measure of success) and its genotype at a number of enzyme loci. A positive correlation has been observed between growth rate and number of

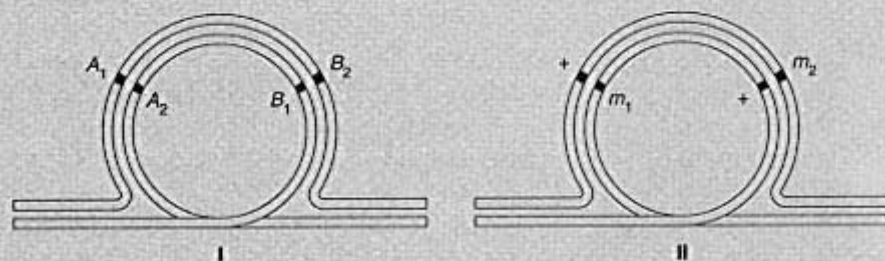

Figure 4.7 Two ways in which effects at individual loci could cause inversion heterosis. The chromosomes are shown paired, as they would be in the salivaries. In **I**, there are two heterotic loci: that is, A_1/A_2 is fitter than A_1/A_1 or A_2/A_2 , and similarly at the B locus. Of course, a single heterotic locus would be sufficient. In **II**, there are two loci, at each of which there is a deleterious recessive allele, m_1 and m_2 , respectively. This is the simplest form of interaction between loci generating inversion heterosis.

loci heterozygous in several species of oyster, in a mussel, in a salamander, in white-tailed deer, in quaking aspen, and in several conifer species. One possible explanation is that the effect is caused by the genes whose products are being recorded: that is, heterozygotes at these specific loci do indeed grow faster. A second possibility is that individuals that are more homozygous for the enzyme loci are more homozygous at other loci as well, and that it is these other loci that are relevant. This would be plausible if the populations sampled consisted of individuals that were inbred to varying degrees. This is a reasonable explanation for the tree species, in which seed dispersal is limited and pollination often occurs between neighbours, but it is implausible for oysters and mussels, which have planktonic larvae. The interpretation of these data is still controversial, but they do lend some support to the idea that single-locus heterosis is widespread.

Frequency-dependent Selection

The basic idea is very simple. If two types exist in a population, and if the fitness of each is greater when it is rare, then stable coexistence will result. This is true whether the two types reproduce asexually, or are different genotypes in a sexual population.

There are good ecological reasons for thinking that frequency-dependent selection is a major cause of genetic variability. Many of the most obvious kinds of selection are likely to be frequency-dependent in their effects. For example:

1. *Disease*. As Haldane was the first to point out, parasites will evolve so as to attack most effectively the common genotypes in the host population; therefore rare host genotypes will be at an advantage. Similarly, hosts will acquire immunity to the common types of parasite, so rare types of parasites will be at an advantage.
2. *Predation*. If predators form a 'search image' of their prey, unusual individuals are more likely to escape predation.
3. *Resource utilization*. If different genotypes have slightly different resource requirements, this may favour coexistence, for essentially the same reason that species with different requirements can coexist.
4. *Behavioural variability*. In many situations the benefits of particular behaviours are frequency-dependent, and this may lead to a 'mixed strategy' being stable: examples include foraging behaviour, fighting, and male mating behaviour. In such situations, the population may become genetically polymorphic, or individuals may be flexible in their behaviour.

Direct evidence for genetic polymorphism at individual loci being maintained by frequency-dependent selection is equivocal. Most of the experiments concern

larval viability in *Drosophila*. Evidence both for and against frequency-dependent selection on enzyme loci is extensive. However, it is hard to believe that the resource requirements of larval *Drosophila* can be so finely differentiated that they can be responsible for the maintenance of a substantial part of the observed polymorphism.

Two final points are worth making. First, there is nothing artificial about assuming that fitnesses are frequency-dependent. The artificial assumption is that relative fitnesses are constant: its justification is mathematical convenience, not truth. Secondly, the most widespread and dramatic genetic polymorphism, that of sexual dimorphism, is certainly maintained by frequency-dependent selection: as Fisher pointed out, in a sexual species, whichever is the rarer sex has most children.

Rather little work has been done on genetic models in which fitnesses are frequency-dependent. The natural way to analyse such cases is to think about evolutionary change in the phenotype directly, as described in Chapter 7.

A Variable Environment.

It seems only common sense that a population should be more diverse genetically if it lives in a variable environment. However, this conclusion depends critically on the nature of the environmental variability.

Variability in Space

The first, rather obvious, point is that the environment, if it is to maintain genetic variability, must vary in a 'coarse-grained' manner. Thus if we imagine the environment to be made up of patches of different types, these patches must be large relative to the movement of an individual organism. If this were not so, each individual would experience many patches, but all individuals would, during their lives, experience the same set of conditions. Therefore, each genotype would have a fixed fitness, and the variable environment would not maintain a variable population. Clearly, an environment that is coarse-grained to a sedentary organism may be fine-grained to a mobile one.

We are concerned, then, only with coarse-grained environments. Figure 4.8 shows two models, due to Dempster (1955) and Levene (1953), which, although apparently similar, lead to different conclusions. They are worth following in some detail, because of the light they shed on the way models in population genetics are constructed and analysed.

Both models consider two alleles, A and a , at a locus (they can readily be extended to many alleles). Both assume a single random-mating population, and two kinds of patch (this, too, can be extended). In Dempster's model, fixed proportions, c_1 and c_2 , of the zygotes settle in patches 1 and 2 respectively (note that $c_1 + c_2 = 1$). Once in a patch, each genotype has a fixed absolute fitness, or chance of surviving. Survivors from each patch join a single random-mating

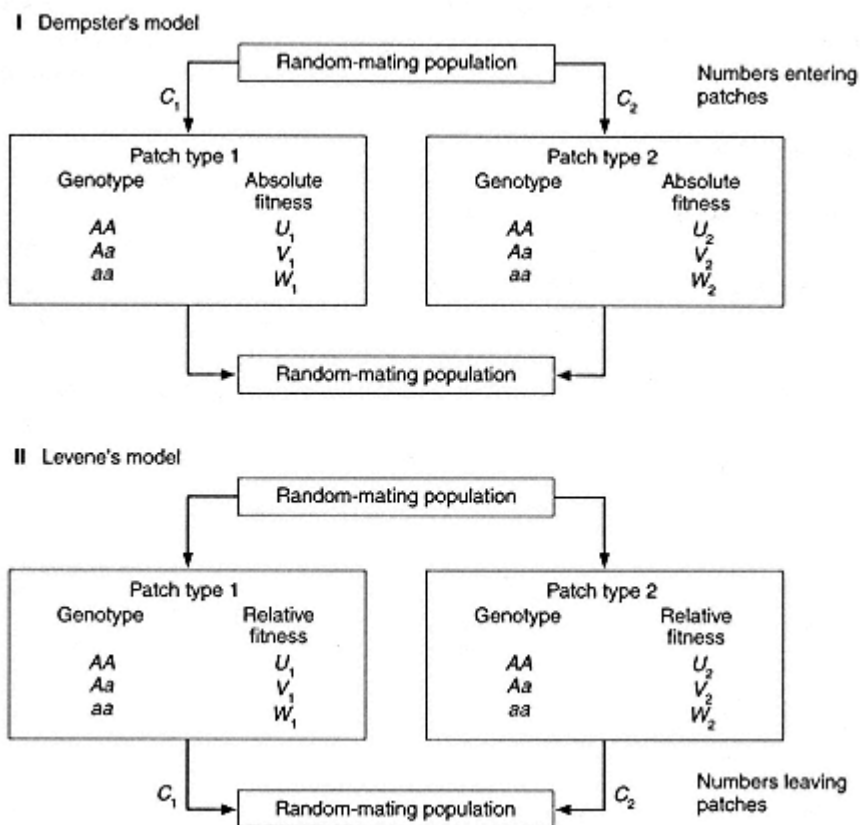

Figure 4.8
Models used to investigate whether polymorphism can be maintained
in a variable environment.

population to produce, without selection, the next generation of zygotes. We can first ask, what is the fitness of genotype AA , averaged over environments. That is, if we select a random AA zygote, what is its probability, $W(AA)$, of survival? Clearly, $W(AA) = c_1 U_1 + c_2 U_2$. Similarly, $W(Aa) = c_1 V_1 + c_2 V_2$ and $W(aa) = c_1 W_1 + c_2 W_2$.

The essential feature of Dempster's model is that these genotypic fitnesses are constants, and independent of gene frequency. It shows that there can be a stable polymorphism only if the heterozygote is fitter than either homozygote. To see this, suppose that one allele A , is fully dominant in both patches: that is, $U_1 = V_1$ and $U_2 = V_2$. Then $W(AA) = W(Aa)$. Either $W(AA) > W(aa)$, in which case allele A will be fixed, or $W(AA) < W(aa)$, and a will be fixed. It will only be by pure accident, for one particular value of c_1 , that they will be equal. It is possible for Aa to be fitter than AA or aa , even if there is no heterosis in either patch. This would be so, for example, if $U_1 = V_1 > W_1$ and $U_2 < V_2 = W_2$; that is, if one homozygote is

fitter in patch 1, and the other in patch 2, and if the heterozygote is always as fit as the fitter homozygote. But it would be better to think of this as an example of heterosis arising because of the greater environmental tolerance of the heterozygote.

Dempster's model, then, suggests that environmental variability contributes little to the maintenance of genetic variability, except through the superiority of heterozygotes. In a haploid organism, there would be no polymorphism. Before leaving the model, however, it is worth asking how it supposes the population is regulated. There is no explicit assumption, but there is a tacit one that regulation acts on the random-mating population as a whole, and not on the separate patches: if this were not so, the absolute fitnesses in the patches could not be constants, as is assumed. This will become clearer when we consider the alternative, Levene's model.

In Levene's model, zygotes produced by random mating settle, in excess numbers, in the two patches. Each patch then produces fixed proportions, c_1 and c_2 , of adults to the next random-mating population: thus it is assumed that density-dependence operates separately within each patch. The fitnesses U_1 , U_2 , etc. are the *relative* probabilities of survival of the different genotypes. In Box 4.4, the model is analysed for A dominant (i.e. $V_1 = U_1$; $V_2 = U_2$); if polymorphism can be maintained in this case, it cannot be ascribed to heterosis. The method is to find the conditions for a protected polymorphism: they are

$$\begin{aligned} \text{for } A \text{ to increase when rare} & \quad \frac{c_1 U_1}{W_1} + \frac{c_2 U_2}{W_2} > 1, \\ \text{for } a \text{ to increase when rare,} & \quad \frac{c_1 W_1}{U_1} + \frac{c_2 W_2}{U_2} > 1. \end{aligned} \quad (4.8)$$

Box 4.4—

Levene's Model with Dominance

The assumptions of the model are shown in Fig. 4.8. If the frequency of allele A in the random-mating population in one generation is p , then the numbers surviving in the two patches are as shown in Table 4.2. Combining the two patches, the total number of genes is $2(c_1 + c_2) = 2$. The number of A genes is

$$\frac{c_1 U_1}{T_1} (2p^2 + 2pq) + \frac{c_2 U_2}{T_2} (2p^2 + 2pq) = 2p \left(\frac{c_1 U_1}{T_1} + \frac{c_2 U_2}{T_2} \right).$$

Hence the frequency p' of A in the next generation is

$$p' = p \left(\frac{c_1 U_1}{T_1} + \frac{c_2 U_2}{T_2} \right).$$

Table 4.2

Levene's model with dominance

	Genotype			Total
	AA	Aa	aa	
Zygotes settling in patch 1	p^2	$2pq$	q^2	1
Survivors in patch 1	$p^2 U_1$	$2pq U_1$	$q^2 W_1$	$T_1 = U_1 + q^2(W_1 - U_1)$
Numbers surviving in patch 1	$\frac{p^2 U_1 c_1}{T_1}$	$\frac{2pq U_1 c_1}{T_1}$	$\frac{q^2 W_1 c_1}{T_1}$	c_1
Numbers surviving in patch 2	$\frac{p^2 U_2 c_2}{T_2}$	$\frac{2pq U_2 c_2}{T_2}$	$\frac{q^2 W_2 c_2}{T_2}$	c_2

When p is small, $T_1 \approx W_1$ and $T_2 \approx W_2$, so

$$p' = p \left(\frac{c_1 U_1}{W_1} + \frac{c_2 U_2}{W_2} \right).$$

Hence the condition for allele A to increase when rare is

$$\frac{c_1 U_1}{W_1} + \frac{c_2 U_2}{W_2} > 1. \quad (4.6)$$

By a similar calculation

$$q' = pq \left(\frac{c_1 U_1}{T_1} + \frac{c_2 U_2}{T_2} \right) + q^2 \left(\frac{c_1 W_1}{T_1} + \frac{c_2 W_2}{T_2} \right),$$

and when q is small, $T_1 \approx U_1$ and $T_2 \approx U_2$, so

$$\begin{aligned} q' &= q(1 - q) + q^2 \left(\frac{c_1 W_1}{U_1} + \frac{c_2 W_2}{U_2} \right) \\ &= q + q^2 \left(\frac{c_1 W_1}{U_1} + \frac{c_2 W_2}{U_2} - 1 \right). \end{aligned}$$

Hence the condition for allele a to increase when rare is

$$\frac{c_1 W_1}{U_1} + \frac{c_2 W_2}{U_2} > 1. \quad (4.7)$$

If both Equations 4.6 and 4.7 are satisfied, there is a protected polymorphism.

To see what these imply, consider a numerical example, Let $c_1 = c_2 = 1/2$; that is, equal-sized patches. Also, since we are interested only in the relative fitnesses in each patch, we can take $U_1 = U_2 = 1$. Then Equation 4.8 becomes

$$1/W_1 + 1/W_2 > 2; \quad W_1 + W_2 > 2.$$

There is nothing impossible about these conditions; for example, they are satisfied by $W_1 = 2$; $W_2 = 0.5$. The conclusion differs from Dempster's because overall fitnesses are now frequency-dependent. To see this, suppose that aa is of low fitness in patch 1, and high fitness in patch 2. Then, when a is rare, aa genotypes will have little competition in patch 2, so many will survive. The point becomes still clearer if we take the extreme case, in which AA and Aa are lethal in patch 2, and aa is lethal in patch 1. It is then obvious that both alleles will be maintained.

However, unless the selective differences are large, the conditions for polymorphism are far from robust. To see this, let us take a pair of values of W_1 and W_2 and ask for what range of values of c_1 (relative frequency of patches) polymorphism can be maintained. Some values are

W_1	W_2	Range of c_1 permitting stable polymorphism
1.01	0.99	0.5-0.505
1.5	0.5	0.5-0.75

These ranges seem narrow. If conditions changed, so that the relative frequencies of the two patch types fell outside the range, then a previously stable polymorphism would become unstable.

Levene's model can be modified in several ways so as to be more favourable for the maintenance of polymorphism:

1. *'Habitat selection'*. Females contribute their offspring to the patch type in which they were raised. This could happen by a process equivalent to imprinting, or, in plants or sessile animals, because of limited dispersal.

2. *Mating within a patch*. In the limit, there could be two regions, each containing a separate random-mating population. If AA were fitter in one region, and aa in the other, it is obvious that both alleles would be maintained, one in each region. If so, neither population would be polymorphic: when different regions contain different genotypes, a species is said to be polytypic. There will be intermediate cases, in which some movement occurs between patches: polymorphism is then more easily maintained than if mating is random.

Variability in Time

Can polymorphism be maintained if the environment varies in time rather than space? Consider first the case of two asexual types. If the relative fitnesses vary from generation to generation, but if these fitnesses repeat themselves regularly in an n -generation cycle, it should be clear that stable coexistence is impossible. Thus if we take the fitness of Type 1 in the i th generation as W_i , relative to a fitness of 1 for Type 2, the overall 'fitness' over n generations will be $W = W_1 \cdot W_2 \cdot \dots \cdot W_n$, compared to 1 for Type 2. W will either be greater than or less than 1, and Type 1

will either be fixed or eliminated. The same conclusion holds if fitness values occur with fixed probabilities, rather than following a fixed cycle.

One might therefore be tempted to conclude that genetic polymorphism cannot be maintained in a sexual population at a locus with complete dominance, but this is not so. It can be shown that polymorphism is stable if the arithmetic mean fitness of the recessive is greater than 1, while its geometric mean fitness is less than one. This would be so, for example, if *aa* was 1.1 times as fit as *AA* or *Aa* in most generations, but if all recessives were killed off by an epidemic disease once every 20 generations.

Balance between Selection at Different Levels

Suppose that allele *A* is favoured relative to *a* by natural selection acting on individual organisms, but that Mendelian segregation is distorted, so that gametes from heterozygotes more often carry allele *a* than *A*. Selection is then also acting at the level of gametes, but in a different direction. A similar conflict could exist between selection on individuals, and on groups of individuals. It is shown in Box 4.5 that selection in different directions at different levels can lead to stable polymorphism, though it need not do so.

Box 4.5—

Selection at Different Levels

For simplicity, imagine that animals interact in groups of two. Let there be two kinds of individuals, *A* and *S*—these can be thought of as standing for 'altruistic' and 'selfish'. The fitness of an individual depends on its own behaviour, and that of its partner, according to the scheme of Table 4.3.

Table 4.3

Selection at different levels

		Type of pair					
		<i>A</i>	<i>A</i>	<i>A</i>	<i>S</i>	<i>S</i>	<i>S</i>
Fitness		4	4	2	5	1	1
		Fitness matrix					
				Partner			
				<i>A</i>	<i>S</i>		
		<i>A</i>		4	2		
		Individual					
		<i>S</i>		5	1		

Note that, in the 'fitness matrix', the entries are the fitnesses of the individuals on the left, paired with the partner indicated above.

If pairs are formed randomly, then each type is the fitter of the two when it is rare. Thus if S is rare, it usually pairs with an A , and has a fitness of 5, whereas A has a fitness of 4. If A is rare, it usually pairs with S , and has a fitness of 2, whereas S has a fitness of only 1. Since each type increases in frequency when it is rare, there must be a stable polymorphism. (Note the similarity between this argument, and that used on p. 65 to explain the maintenance of polymorphism by heterosis.)

It is not hard to imagine circumstances in which fitnesses might vary like this. Consider, for example, watching for a predator when feeding in a flock. Suppose that a flock (of two in the example) is reasonably safe so long as at least one member is watching, but that watching wastes time that could be spent feeding, whereas a flock in which no bird is watching is seriously at risk. The relative fitnesses would then vary as shown in the table, with A representing watchers, and S birds that do not watch. Watching would be maintained in the population (even if the members of a flock were unrelated), but would not go to fixation. I return to this way of looking at natural selection and evolution in Chapter 7.

Further Reading

Lewontin, R.C. (1974). *The genetic basis of evolutionary change*. Columbia University Press, New York.

Nei, M. (1987). *Molecular evolutionary genetics*. Columbia University Press, New York. (Particularly Chapters 8 and 10.)

Problems

- Four loci were examined electrophoretically in a population. At the first, three alleles were found, with frequencies 0.12, 0.7, and 0.18; at the second, two alleles had frequencies 0.37 and 0.63; no variation was detected at the other two loci. What is the average proportion of heterozygous loci?
- Twenty-six recessive lethals were isolated from different populations of *Drosophila* species. None were allelic to any of the others. (a) How many combinations had to be tested to decide this? (b) Is the result consistent with the idea that there are approximately 1000 'essential' loci in *Drosophila*? (c)* Given that there are 1000 loci, what is the probability that exactly one allele pair would be found? (d) How does the existence of 'gene families', described in Chapter 11, affect estimates of the number of essential loci based on measurement of the allelism of lethals?
- In humans, achondroplasia (a form of dwarfism with short arms and legs) is caused by a dominant gene. In one study, 10 achondroplasics were found among 94 075 births. 108 achondroplasics left 27 children, whereas 457 normal sibs left 582 children. Estimate the mutation rate at the locus.

4. The frequency of individuals homozygous for a recessive lethal gene in a randommating population is $1/10\,000$. (a) If the population is in equilibrium between mutation and selection, calculate the mutation rate. (b) Ignoring mutation, and assuming that the gene is maintained in the population by heterosis, what are the relative fitnesses of the heterozygote and the 'wild-type' homozygote?
5. Devise a breeding scheme, similar to that in Fig. 4.3, to establish a population of *Drosophila* isogenic for the X chromosome.
6. If the relative fitnesses of AA , Aa , and aa are 0.95, 1, and 0.5, what is the frequency of allele A at equilibrium? What is the genetic load associated with the locus?
7. Suppose that individuals homozygous for the sickle-cell gene S , have zero fitness, and that the frequency of S in the population is 0.1. If this is an equilibrium, what is the fitness of the normal homozygote, relative to that of the heterozygote? What is the genetic load?
8. In a diploid random-mating population, genotypes AA and Aa are dark, and aa is pale. Because of frequency-dependent predation, the relative fitness of dark individuals is $0.75 - P$, and of pale individuals is $1.5 - P$, where P is the frequency of pale individuals. What is the frequency of A at equilibrium? Is the equilibrium stable? What is the genetic load?
9. Using the breeding scheme illustrated in Fig. 4.3, the following crosses were set up, and the offspring counted: $+1/M \text{♀} + 2/M \text{♂}$ gave 467 + :201 M offspring; $+1/M \text{♀} + 1M \text{♂}$ gave 376 + :197 M offspring. Calculate the viability of $+1/+1$ homozygotes, taking the viability of $+1/+2$ as unity.
10. A mutant of *E. coli* is unable to grow in the absence of tryptophan. A single mutant bacterium was placed in each of 100 tubes, containing a medium with tryptophan. When the population had increased to 10^8 cells per tube, the cells were plated on a medium without tryptophan, and the number of growing colonies recorded. 72 tubes produced no colonies. Estimate the back mutation rate.

Computer Projects

1. Two loci, with two alleles at each (A, a and B, b) are segregating in an infinite random-mating population. The relative fitnesses at the single loci are:

AA	Aa	aa	BB	Bb	bb
1	$1 - s/2$	$1 - s$	1	$1 - t/2$	$1 - t$

The fitnesses combine multiplicatively. For example, the fitness of abb is $(1 - s)(1 - t)$. The frequencies of alleles A and B are $p(A)$ and $p(B)$. The fitness at each locus depends on the gene frequency at the other, according to the following scheme: $s = h[p(B) - 0.5]$; $t = k[p(A) - 0.5]$, where h, k are constants between 0 and 1. The state of the population can be plotted as a point with coordinates $(p(A), p(B))$. Simulate the population, and plot its changes in state. (This is a diploid genetic version of Dawkins' 'Battle of the sexes' game. The dynamic behaviour is unexpected.)

2. Write a program simulating Levene's model, and use it to check conditions (4.8) for a stable polymorphism. Modify the program to include 'habitat selection' by females: that is, mating is random, but females lay eggs in the patch in which they were born. Does habitat selection make a stable polymorphism more likely?

Chapter 5— Evolution at More than One Locus

Linkage disequilibrium	81
Heterostyly in plants	84
Mimicry in butterflies	85
Linkage disequilibrium in natural populations	87
Normalizing selection and linkage disequilibrium	88
Further reading	90
Problems	90
Computer projects	91

In this chapter, I discuss some of the complications that arise when a population is genetically variable at more than one locus. It would be convenient if changes of gene frequency at each locus occurred independently of changes at others. There are two reasons why this may not be so. First, the effects on the fitness of an individual of the genes at one locus may depend on what alleles are present at another: that is, there may be **epistatic** effects on fitness. Examples are given on pp. 83-9. Secondly, if the two loci are linked, changes in frequency at one locus may cause changes at the other.

The essential concept in analysing such interactions is that of **linkage disequilibrium**: this is defined below.

Linkage Disequilibrium.

In a diploid population, two alleles, A and a , are segregating at one locus, and alleles B and b are segregating at a second. There are then four possible gametes ab , aB , Ab , and AB . Let their frequencies in the gametic pool be p_{ab} , etc. We can also define the frequencies among the gametes of alleles a and b . Thus:

$$p_a = p_{ab} + p_{aB}; \quad p_A = p_{Ab} + p_{AB} = 1 \times p_a$$

$$p_b = p_{ab} + p_{Ab}; \quad p_B = p_{aB} + p_{AB} = 1 \times p_b$$

Note that, to find the gametic frequencies, we must find three values (the fourth is then given by the fact that the frequencies must add up to one). It is therefore not sufficient to know the two allele frequencies, p_a and p_b : one cannot find three unknowns from two equations.

However, we could find the gametic frequencies if we make the additional assumption that alleles at the two loci occur in gametes independently: that is, the probability that a gamete carries allele a is independent of whether it also carries B or b . If this were true we would have $p_{ab} = p_a p_b$, and similarly for the other gametic types. If these equations hold, we say that the gametes are in linkage equilibrium.

In practice, the assumption of independence need not hold. We therefore write

$$p_{ab} = p_a p_b + D,$$

where D measures the departure from linkage equilibrium. Then we have

$$p_{aB} = p_a - p_{ab} = p_a - p_a p_b - D = p_a(1 - p_b) - D = p_a p_B - D,$$

and, in general

$$\begin{aligned} p_{ab} &= p_a p_b + D \\ p_{aB} &= p_a p_B - D \\ p_{Ab} &= p_A p_b - D \\ p_{AB} &= p_A p_B + D. \end{aligned} \quad (5.1)$$

These equations can be treated as a definition of the **linkage disequilibrium**, D . Alternatively, it follows from these equations that

$$D = p_{ab} p_{AB} - p_{aB} p_{Ab}. \quad (5.2)$$

Box 5.1—

The Approach to Linkage Equilibrium

Using the notation in the main text, and writing p'_{ab} , D' , etc. for the values of p_{ab} , D , etc. in the next generation we have

$$p'_{ab} = p'_a p'_b + D'.$$

In the absence of selection, $p'_a = p_a$, and $p'_b = p_b$, so

$$\begin{aligned} p'_{ab} &= p_a p_b + D' \\ &= p_{ab} - D + D', \end{aligned}$$

or

$$D' = D + p'_{ab} - p_{ab}. \quad (5.3)$$

That is, the change in DF is equal to the change in the frequency of ab gametes. Now the number of ab gametes in the next generation is the sum of two terms:

1. The number of ab gametes in this generation that do not recombine: that is, $p_{ab}(1 - r)$.
2. The number of new ab gametes that arise by recombination. New ab gametes can only come from genotypes ax/xb , where x stands for any allele. The frequency of such genotypes is $2p_a p_b$; the factor 2 arises because allele a could come from father and b from mother, or vice versa. The proportion of the gametes produced by an ax/xb parent that are ab is $r/2$, where r is the rate of recombination. Hence the number of new ab gametes produced is $2p_a p_b r/2 = r p_a p_b$.

Hence $p'_{ab} = p_{ab}(1 - r) + r p_a p_b$. Substituting into Equation 5.3 gives

$$\begin{aligned} D' &= D + p_{ab}(1 - r) + r p_a p_b - p_{ab} \\ &= D - r(p_{ab} - p_a p_b) = D(1 - r). \end{aligned}$$

How will the value of D change? It is shown in Box 5.1 that, in an infinite random-mating population with no selection,

$$D_{n+1} = (1 - r)D_n, \quad (5.4)$$

where D_n is the value of D in the n th generation, and r is the rate of recombination between the loci. If the loci are unlinked, D will halve in each generation. Box 5.2 makes some further comments on the coefficient D .

The conclusion that D declines rapidly to zero rests on the assumptions of an infinite population, no selection, and recombination between the loci. If loci are linked, and particularly if they are tightly linked, we expect to find disequilibrium in two situations:

1. *Strong selection with epistatic fitnesses* Thus imagine two loci in a haploid population, with alleles A, a at one locus and B, b at the other. Suppose that genotypes AB and ab are of high fitness, and Ab and aB of low fitness: these fitnesses are epistatic, in the sense that the effects of alleles at one locus depend

Box 5.2—

Some Comments on the Coefficient of Linkage Disequilibrium

D , as defined by Equation 5.2, is a number lying between -0.25 and $+0.25$. It takes its greatest value when only ab and AB gametes exist, and when $p_a = p_b = 0.5$: then $p_{ab} = p_{AB} = 0.5$, and $D = 0.25$. One drawback is that the value depends on the allele frequencies at the individual loci. Suppose that there is complete disequilibrium, but that $p_a = p_b = 0.1$: then $D = 0.1 \times 0.9 = 0.09$. The value of D has changed from 0.25 to 0.09 although in both cases the disequilibrium is complete. For some purposes, it is convenient to have a parameter which depends only on the degree of association between the alleles, and not on their frequencies. Such a parameter is D' , the ratio between the actual value of D , and the maximum value it could have for the given allele frequencies. That is,

$$D' = (p_{ab} \cdot p_{AB} - p_{aB} \cdot p_{Ab}) / (p_{ab} \cdot p_{AB} + p_{aB} \cdot p_{Ab}). \quad (5.5)$$

D' can vary from -1 to $+1$: for both the numerical examples above, $D' = 1$, indicating complete association.

In most cases, the sign of D depends on the arbitrary choice of how we name the alleles. However, this is not so when the two loci affect the same phenotypic trait. It is then conventional, in Equation 5.2, to use a and b for alleles producing similar effects, and A and B for alleles producing the opposite effect (for example, a and b are alleles for small size, and A and B for large size). Then D is positive when alleles with similar effects are in coupling (that is, an excess of $++$ and $--$ gametes), and negative when they are in repulsion (an excess of $+ -$ and $- +$ gametes).

on what allele is present at the other. Selection will then generate linkage disequilibrium. More complex epistatic interactions can occur in a diploid. Two cases of selectively maintained linkage disequilibrium will be discussed: heterostyly in plants and mimicry in butterflies, on pp. 84-7. Both these topics raise interesting evolutionary problems, and we shall revisit them later in the book. On p. 88 it is explained that epistatic fitnesses arise inevitably in the commonest type of natural selection.

2. *Finite population size.* In a finite population, a particular mutation may be a rare, or even a unique, event. Suppose that the mutation $a \rightarrow A$ occurs only once in a population. It will occur in a particular chromosome, carrying a particular set of alleles. Thus allele A is initially in linkage disequilibrium.

Heterostyly in Plants

In most species of *Primula*, individual plants are hermaphrodite, but they are of two kinds (Fig. 5.1): pin plants have a long style and short anthers, and thrum plants a short style and long anthers. Pollen of one type will only grow down the style of the other: hence selfing is impossible, and so too is crossing between two plants of the same type.

Genetically, the difference behaves as if it were caused by a single gene difference, with pin being heterozygous, Aa , and thrum homozygous recessive, aa . However, occasionally a cross-over takes place within the locus, giving rise to one of two complementary kinds of 'homostyle' (long homostyles and short homostyles), with the stigma characteristic of one strain and the pollen characteristic of the other: these homostyles are self-fertile. Analysis shows that there are at least

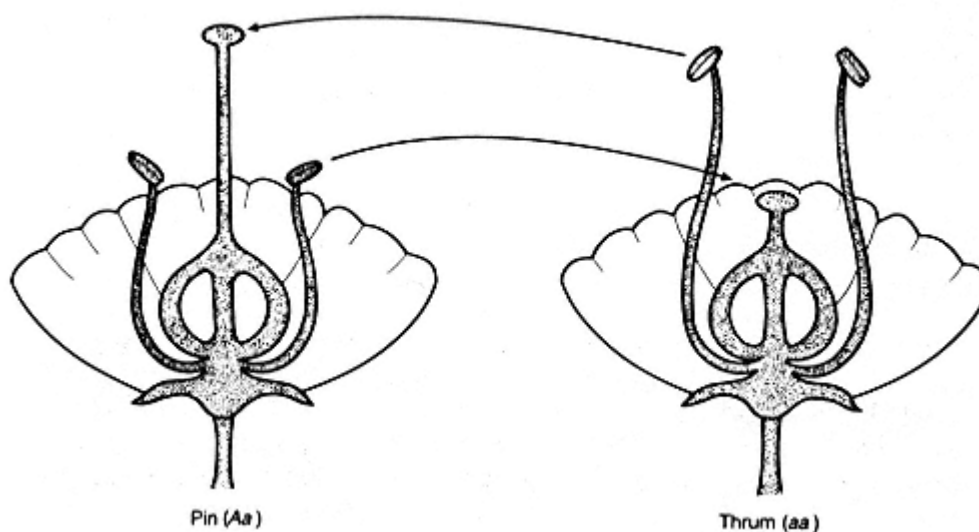

Figure 5.1

Structure of pin and thrum flowers in a distylous species. The arrows show the direction of effective pollination.

three separable but tightly linked loci: thus pin plants are $A_1A_2A_3/a_1a_2a_3$, and thrum plants are $a_1a_2a_3/a_1a_2a_3$.

The evolution of self-sterility is discussed further in Chapter 13. For the present, it is sufficient to appreciate that cross-over (homostyles) are eliminated from most natural populations because of the selective disadvantage of self-fertilization. Thus a situation of extreme linkage disequilibrium is maintained by a combination of strong selection and tight linkage.

Distyly is found in 13 different plant families, and tristily (three self-sterile morphs) in three more.

A complex locus of this kind is sometimes referred to as a **supergene**. It differs from a gene family of the kind discussed in Chapter 11. A gene family consists of several genes, often tightly linked, that perform similar or identical functions: it is therefore plausible that the members of the family arose by the duplication of a single original gene, and in some case we have direct evidence of this. In contrast, the components of a supergene perform very different functions, and so cannot have arisen by duplication: it is not plausible that genes affecting the lengths of style and anther, and physiological incompatibility of pollen and stigma, could have arisen by duplication.

How, then, do supergenes evolve? There are two possibilities: the loci were unlinked when the polymorphism first arose, and have subsequently been brought close to one another; or the loci were, by chance, tightly linked from the beginning. We will return to these possibilities after discussing a second example of a supergene.

Mimicry in Butterflies

Some insects gain protection from predators by being distasteful, or toxic, or both. Predators learn to avoid such prey. Learning is accelerated, and the protection increased, if the prey species is brightly coloured. Given that some species are warningly coloured, however, it will pay other species to resemble them. Such mimicry can take two forms:

- (1) Batesian mimicry: the mimic species is itself palatable, but resembles a distasteful model;
- (2) M^{üllerian}erian mimicry: two or more distasteful species resemble one another.

When thinking about mimicry, the crucial thing to bear in mind is that the degree of protection depends on the relative abundance of the model and mimic. In Batesian mimicry, if the mimic species is rare relative to the model, it will gain protection, but if it is common relative to the model, predators will learn to associate the colour pattern with palatable prey, so that the model will lose protection, rather than the mimic gaining it. In M^{üllerian}erian mimicry, in contrast, the different species give protection to one another, since all are distasteful: there is no tendency for a species to lose protection as it becomes commoner.

The three species of African swallowtail butterflies *Papilio memnon*, *dardanus*, and *polytes*, are palatable. The females are Batesian mimics of different model species in different parts of Africa, and are often genetically polymorphic in a single region, mimicking several different models (Plate 1, between pp. 78 and 79). This makes sense, when we remember that the fitness of each kind of mimic decreases as it becomes commoner relative to its model: this is a classic example of polymorphism maintained by frequency-dependent selection (see p. 69). The males are non-mimetic, perhaps because their success in mating depends on maintaining the black and yellow pattern, although direct evidence for this is lacking.

The mimicry polymorphism is determined by a supergene. In *P. memnon*, the component loci, in order on the chromosome, determine presence or absence of a tail on the hindwing, hindwing pattern, forewing pattern, colour of basal triangle on forewing, and colour of abdomen. As in heterostyly in *Primula*, it is clear that these genes cannot all have arisen by duplication. Nevertheless, there are grounds for thinking that the loci have been linked from the beginning. Thus suppose, initially, that females evolve as mimics of one model species. If they become too common relative to the model, a mutation, say A_1 , giving a degree of resemblance to a second model, might establish itself in the population as a rare variant. However, A_1 would not be a precise mimic, and would gain only partial protection: as it became commoner, predators would learn to distinguish it from the model. Suppose that a second mutation, A_2 , improves the resemblance. Almost certainly, although improving the resemblance of A_1 to the new model, the new mutation would reduce the resemblance of non- A_1 females to the original model. If so, A_2 would increase in frequency only if it was tightly linked to A_1 : if there was close linkage, A_1A_2 genotypes could increase in frequency without damaging the mimicry of non- A_1 females.

It seems likely, therefore, that the component loci of the mimicry supergene have been linked from the beginning. A similar conclusion has been drawn for the heterostyly supergene in *Primula*. This mode of origin requires the fortunate accident that genes capable of mutating to give the necessary phenotypes happened to exist close to one another on the chromosome. On balance, however, this is more likely than that the genes were initially unlinked.

In both mimicry and heterostyly supergenes, the essential points are that the population is polymorphic at several loci simultaneously, and that high fitness requires that several genes, at different loci, be either all present, or all absent. It is interesting to compare this situation with Müllerian mimicry in the tropical American butterflies, *Heliconius melpomene* and *H. erato*. Both these species are distasteful. As in *Papilio*, strikingly different colour varieties exist. In Müllerian mimicry, however, there is no loss of protection as a morph becomes commoner: it is therefore not surprising that, in any given area, the two species are monomorphic, and closely resemble one another (see Plate 2, between pp. 78 and 79). In

Papilio, the suggested reason why the loci concerned with mimicry are tightly linked is that, in a polymorphic population, a modifier mutation that improves one morph is likely to damage another, and so can spread only with tight linkage. *Heliconius* populations are monomorphic, so there is no reason to expect tight linkage, and it is not present. Geographical races differ at many colour and pattern loci, but in general these are unlinked.

The existence of supergenes raises the following question. Are supergenes atypical, or are they extreme examples of a common phenomenon? To put the same question in another way, is most of the genome in linkage equilibrium, with supergenes representing a rare exception, or is it common for epistatic selection to maintain blocks of genes in partial linkage disequilibrium? We do not know, but evidence outlined in the next section suggests that linkage disequilibrium is atypical, except for very tightly linked loci.

Linkage Disequilibrium in Natural Populations

Given two or more polymorphic enzymes determined by genes on the same chromosome, one can look for linkage disequilibrium between them. A classic study by Langley *et al.* (1977) examined 11 polymorphic enzymes in *Drosophila melanogaster*, six on chromosome 2 and five on chromosome 3. They measured gamete frequencies in the same population early and late in the season, separated by about three generations. Of the 25 pairwise comparisons, only one showed a significant value of D on both occasions. One other comparison, that gave a significant D on the first but not the second occasion, can reasonably be interpreted as a chance result of sampling. The indication from this and other experiments is that linkage disequilibrium between loci that are not tightly linked (say, greater than 1 per cent crossing over) is the exception rather than the rule.

A different picture emerges if we look at very tightly linked loci. This is most easily done for **restriction site** polymorphisms. The method is as follows. There are endonucleases that cut DNA only at specific sequences, usually of four or six bases. By treating a length of DNA with such an enzyme, one obtains fragments from which it is possible to deduce where the corresponding restriction sites were situated: By using several enzymes, one can build up a **restriction map** of the region. Some changes in base sequence cause new restriction sites to appear, or existing ones to disappear. The method can be used to look for polymorphism over relatively short regions of chromosome, of the order of 100 kb (1 kb = 1000 bases). Of course, one does not find all the polymorphisms that would be found by DNA sequencing, but the method is quick enough to be practicable, and it does discover a small but calculable proportion of the polymorphisms that are present, including those in non-coding DNA.

It is typical to find disequilibrium between these tightly linked restriction sites. An interesting example concerns the sickle-cell gene in man. The β globin gene is

usually found situated on a 7.6 kb fragment, but in about 3 per cent of cases it is on a 13 kb fragment. However, in Afro-Americans, Kan and Dozy (1978) found that the *S* allele was associated with the 13 kb fragment in 68 per cent of cases. This represents a very high degree of disequilibrium between the *S* allele and a restriction site. There is no reason to think that this is maintained by epistatic selection, as in the supergenes discussed earlier. The more likely explanation is that a unique mutation of the β globin gene gave rise to the *S* allele in the recent past perhaps in the past 10 000 years and that it occurred on a chromosome carrying the 13 kb fragment. There has not yet been time for recombination to bring these tightly linked loci into equilibrium, but the fact that 32 per cent of *S* alleles are associated with the 7.6 kb fragment shows that some crossing over has occurred.

To summarize, linkage disequilibrium is characteristic of very tightly linked loci. In most cases, it reflects the fact that a unique mutation must be in linkage disequilibrium when it first occurs. Occasionally, groups of tightly linked loci are maintained in almost complete disequilibrium by epistatic selection. More loosely linked loci, with 1 per cent or more recombination, are usually close to linkage equilibrium.

Normalizing Selection and Linkage Disequilibrium

In one of the earliest attempts to measure natural selection, Bumpus (1899) measured the wing lengths of sparrows killed in a storm, and sparrows that survived. He found that the survivors contained an excess of birds with wings of average length, and a deficiency of birds with very long or very short wings. Many subsequent measurements of natural selection on quantitative traits have given the same picture: typical individuals do better than either extreme. Such selection is referred to as **normalizing** or **stabilizing** selection.

Normalizing selection gives rise to linkage disequilibrium, even if the genes affecting the trait do so in an additive way, without epistatic interactions. The reason is that if an individual has alleles for a high value of the trait at one locus, selection will favour alleles for a low value at a second locus, and vice versa. Sufficiently intense normalizing selection can produce chromosomes carrying a series of + and - alleles in repulsion: that is, + - + - and - + - + chromosomes. This effect is illustrated by a computer simulation in Box 5.3. Ultimately, normalizing selection in the absence of mutation produces a population homozygous for a set of alleles giving the optimal phenotype, but this process is slow, and in the short run linkage disequilibrium is more important than changes in gene frequency in reducing phenotypic variance.

These are theoretical predictions. We have no data to confirm the predictions, and such data would be hard to come by, even if the predictions are correct, because of the difficulty of identifying individual loci affecting quantitative traits.

Box 5.3—**Normalizing Selection: A Simulation**

In an infinite, random-mating diploid population, suppose that size is determined by two alleles at each of two loci. The possible genotypes, and the corresponding phenotypes, are shown in Fig. 5.2. Thus $aabb$ is 10 units, and every substitution of A for a , or of B for b , adds one unit, so that $AABB$ is 14 units. The initial gene frequencies are $p(a) = 0.4$, and $p(b) = 0.6$. The initial population, shown in the figure, is assumed to be in linkage equilibrium. In each generation, selection acts on the adult population, with fitnesses as shown.

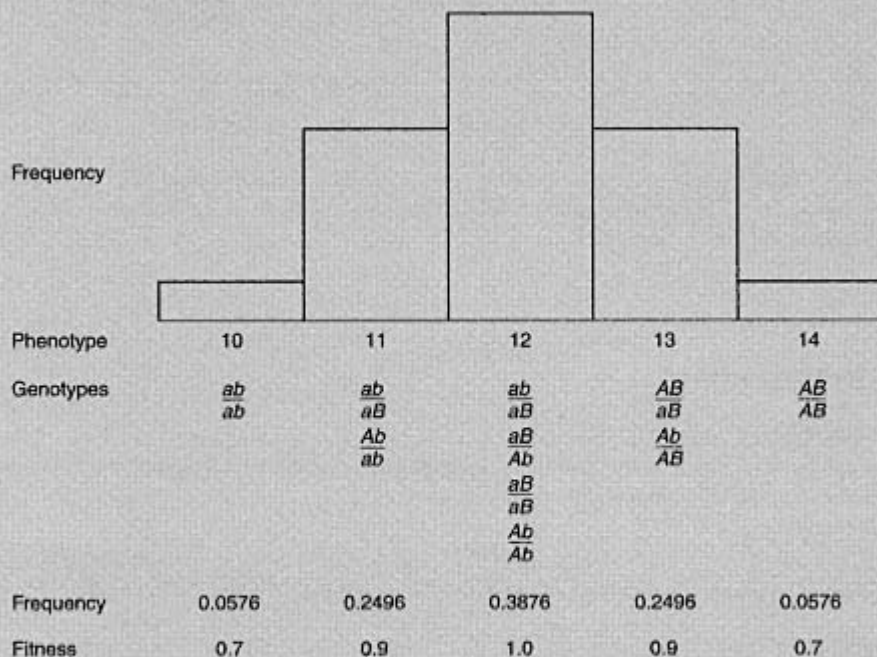
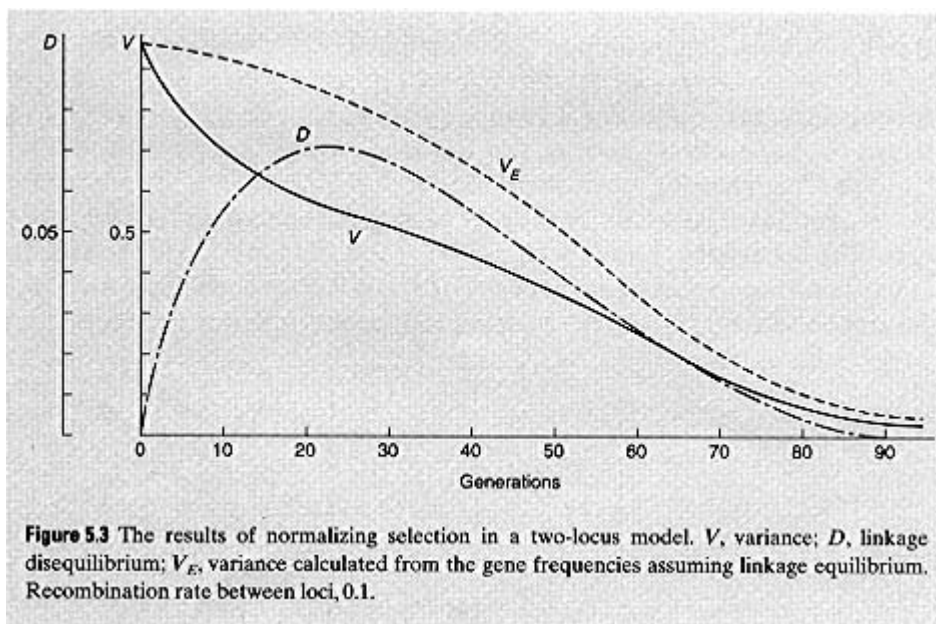

Figure 5.2 A simulation of normalizing selection: the initial population. Gene frequencies: $p(a) = 0.4$; $p(b) = 0.6$. Assuming linkage equilibrium, the initial gamete frequencies are $p(ab) = 0.24$; $p(aB) = 0.16$; $p(AB) = 0.36$; $p(AB) = 0.24$. The genotypic frequencies are then calculated assuming random mating.

The results of simulation, assuming a rate of recombination between the two loci of 0.1, are shown in Fig. 5.3. After 20 generations, the variance has fallen from 0.96 to 0.59: this drop is largely due to linkage disequilibrium. However, after 90 generations the variance has fallen to about 5 per cent of its initial value, but now the drop is caused by allele fixation at the individual loci, so that most individuals have the genotype $AAbb$.



Further Reading

On mimicry:

Turner, J.R.G. (1977). Butterfly mimicry: the genetical evolution of an adaptation *Evolutionary Biology* **10**, 163-206.

On heterostyly:

Charlesworth, B. and Charlesworth, D. (1979). The evolutionary genetics of sexual systems in flowering plants. *Proceedings of the Royal Society* **B205**, 513-30.

Problems

1. The frequencies of gametes AB , Ab , aB , and ab are 0.1, 0.2, 0.3, and 0.4 respectively. What is D ?
2. For the values of question 1, what will be the value of D after four generations, if the recombination rate between the loci is 0.1?
3. In a diploid population, allele A is fully dominant to a , and B is fully dominant to b . If the only data available are the frequencies of the four phenotypes, is it possible to decide whether the population is in linkage equilibrium?
4. In a haploid sexual population, size is affected by two loci, with two alleles at each locus AB is larger than Ab or aB , which are both larger than ab . The four haplotypes are in linkage equilibrium. The fitnesses of AB , Ab , and aB are 1, $1 + s$, and $1 + t$ respectively. Will the linkage disequilibrium in the next generation be positive, zero, or negative if (a) the fitness of ab is $(1 + s)(1 + t)$; (b) the fitness of ab is $1 + s + t$?

Computer Projects.

Write a program to generate Fig. 5.3. Plot the fitnesses of genotypes AA , Aa , and aa during the 90 generations. How can it be that a locus at which the heterozygote is fitter than either homozygote can nevertheless go to fixation?

Chapter 6— Quantitative Genetics

Nature and nurture	<u>93</u>
The additive genetic model	<u>95</u>
Phenotypic distributions	<u>96</u>
Resemblances between relatives	<u>97</u>
The effects of inbreeding	<u>100</u>
The effects of directional selection	<u>103</u>
A more realistic model	<u>108</u>
Experiments in artificial selection	<u>113</u>
Quantitative variation and fitness	<u>117</u>
The maintenance of genetic variation for quantitative traits	<u>118</u>
Further reading	<u>121</u>
Problems	<u>121</u>
Computer projects	<u>122</u>

Nature and Nurture

The subject of this chapter is the inheritance of traits that are influenced by genes at many loci—that is, of polygenic inheritance. Such traits are also influenced by the environment. Of course, a phenotype that can be caused by a single mutation may also be caused by a specific environment: for example, a fruitfly may lack a particular crossvein in the wing because it is homozygous for the mutant cross-veinless, or because it was exposed to a heat shock as a pupa. The 'nature-nurture' problem is discussed here, however, because the analysis of causation becomes difficult for polygenic traits.

A difference between two individuals may be genetic or environmental: that is, it may be caused by differences between the genes present in the fertilized eggs from which they developed (that is, by **nature**), or by differences between the environments in which they were raised (that is, by **nurture**). To a geneticist, any difference that is not genetic in the above sense is environmental. The reason for treating this distinction as fundamental is that, unless Lamarckism is true, only genetic differences will influence the nature of the progeny. Of course, children may resemble their parents because they share a common environment, and not only because they share genes. You will notice that, in many of the models discussed in this chapter, it is explicitly assumed that genetic and environmental factors act independently: that is, relatives do not share a common environment. Models which allow for shared environments, or for the fact that traits acquired by a parent may be transmitted culturally to the children, are necessarily more complex.

However, the definition does lead us to lump together as environmental several distinct kinds of difference:

1. Differences caused by external environmental conditions—for example temperature or nutrition.
2. Differences due to developmental noise. Figure 6.1 shows the number of abdominal bristles in an isogenic line of *Drosophila*. The members of an

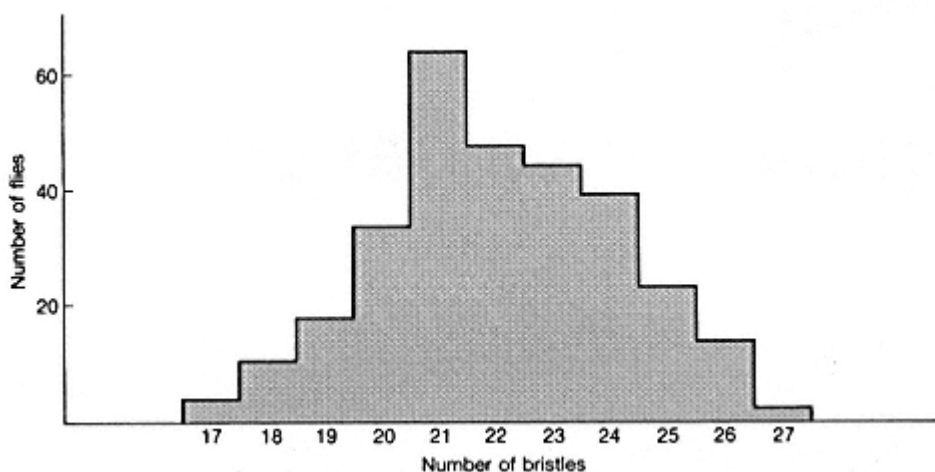

Figure 6.1

Variability in an isogenic line of *Drosophila melanogaster*. Numbers of males with different numbers of bristles in a population made isogenic for all chromosomes by the technique illustrated in Fig. 4.3 (data from Dr K. Fowler).

isogenic line are genetically very similar to one another, yet, even if raised in as uniform an environment as possible, they differ in phenotype, often to a marked degree. It is possible that these differences are caused by minor and uncontrollable differences in the external environment, but it is more likely that they arise from chance internal events during development.

3. Cytoplasmic effects. There may be a difference in non-chromosomal DNA (for example, mitochondrial or chloroplast DNA). Such differences can have long-term evolutionary consequences, although the pattern of inheritance is different. They are ignored in this chapter, and discussed on pp. 151-4. Other cytoplasmic effects occur, but are much less stable; they too are ignored in this chapter.

Usually, both genetic and environmental causes of variation are present simultaneously. If so, the first question to ask is whether they act **additively**. Thus consider the two sets of data in Table 6.1. Scottish flies are larger than those from Israel, and flies raised at 15°C are larger than those raised at 25°C. These two effects act additively, in the sense that the effect of temperature is almost the same in the two populations (20.4 units in one population, and 20.6 in the other), and the effect of genotype is the same at the two temperatures (9.9 units at 15°C and 10.1 units at 25°C). Additivity implies that the joint effect is the sum of the separate effects.

Contrast this with the data on growth rate in mice. Strain A grows faster with good nutrition, but slower with bad nutrition. The effects of genes and environment are no longer additive.

Table 6.1

The interaction between genotype and environment

A Wing length in *Drosophila subobscura*, in arbitrary units (original data)

Origin of population	Temperature during development	
	15癡	25癡
Scotland	130.2	109.8
Israel	120.3	99.7

B Growth between 3 and 6 weeks of age of two strains of mice (Falconer 1981)

	Good nutrition	Bad nutrition
Strain A	17.2	12.6
Strain B	16.6	13.3

Now suppose that we have a single, genetically variable population, living in a range of environments. The phenotypic variability of the population for some trait can be measured by its variance,

$$V = \frac{1}{n} \sum (x_i - \bar{x})^2, \quad (6.1)$$

where x_i measures the phenotype of the i th individual, \bar{x} is the mean value, and n the number of individuals. If genetic and environmental factors act additively, as in the example of wing length in *Drosophila*, and if there is no association between the genotype of an individual and its environment, then

$$V = V_G + V_E, \quad (6.2)$$

where V_G and V_E are the genetic and environmental variances, respectively. A third term V_{GE} , is needed if there is gene-environment interaction, as for growth rate in mice. When there is such interaction, it is useful to think of the **norm of reaction** of a genotype: this is the set of phenotypes produced by the genotype in different environments.

The important points made in this section are:

1. Differences can be genetic or environmental: only genetic differences will affect the nature of the offspring.
2. Causes may act additively or non-additively: if causes act additively, the effect of cause A is the same, whether or not cause B has also acted.

The Additive Genetic Model

In this section, I work out some of the consequences of a simple model, which has two main assumptions:

- (1) all differences are genetic; and
- (2) genes act additively.

The assumption about additive gene effects has two parts, concerning within-locus and between-locus effects. Within a locus, it assumes that the phenotype of the heterozygote Aa is exactly intermediate between the homozygotes, aa and AA . Thus the effect of introducing the first A allele ($aa \rightarrow Aa$) is the same as the effect of introducing the second allele ($Aa \rightarrow AA$). Between loci, it assumes that the effect of a gene substitution at one locus is independent of what alleles are present at a second locus. Thus, in a haploid the difference between ab and aB is the same as the difference between Ab and AB . Within a locus, the alternative to additivity is dominance: between loci, it is **epistasis**. In terms of variance, therefore, we can write

$$V_G = V_A + V_D + V_I$$

where V_a = additive genetic variance; V_D = dominance variance; and V_I = variance due to epistasis (= interaction between loci).

The reason for singling out the additive genetic variance for special attention is that, as we shall see, it is the component of the total variance that causes the response of a population to selection, natural or artificial.

Of course, our model is not true of real populations. The environment does affect the phenotype, and genes do not always act additively. However, it is illuminating to work out the consequences of the simple model, and to compare these with the results of experiments, particularly on artificial selection. One can then ask what changes in the model are needed to explain the facts.

Phenotypic Distributions

Figure 6.2 shows the distribution of some quantitative traits. Their common characteristic is that they are approximately normal, or Gaussian. This is what we expect on our model. If only a few loci are involved, we expect the phenotypic distribution to be skewed (Fig. 6.A), unless allele frequencies happen to be 0.5, but as the number of loci increases, the skew disappears (Fig. 6.B), even if allele frequencies are not 0.5, provided they are not very extreme. (Mathematically, this follows from the fact that the binomial distribution, $(p + a)^n$, tends to the normal as n increases.)

It is important to realize, however, that the prevalence of normal distributions does not prove that our model is correct. A normal distribution is expected whenever a number of separate causes act additively: the causes could equally well be environmental. Thus in Fig. 6.1, of variation in an isogenic line, the causes cannot be genetic.

A second reservation is that phenotypic distributions are not always Gaussian. One reason is as follows. Imagine a population of geometrically similar organisms

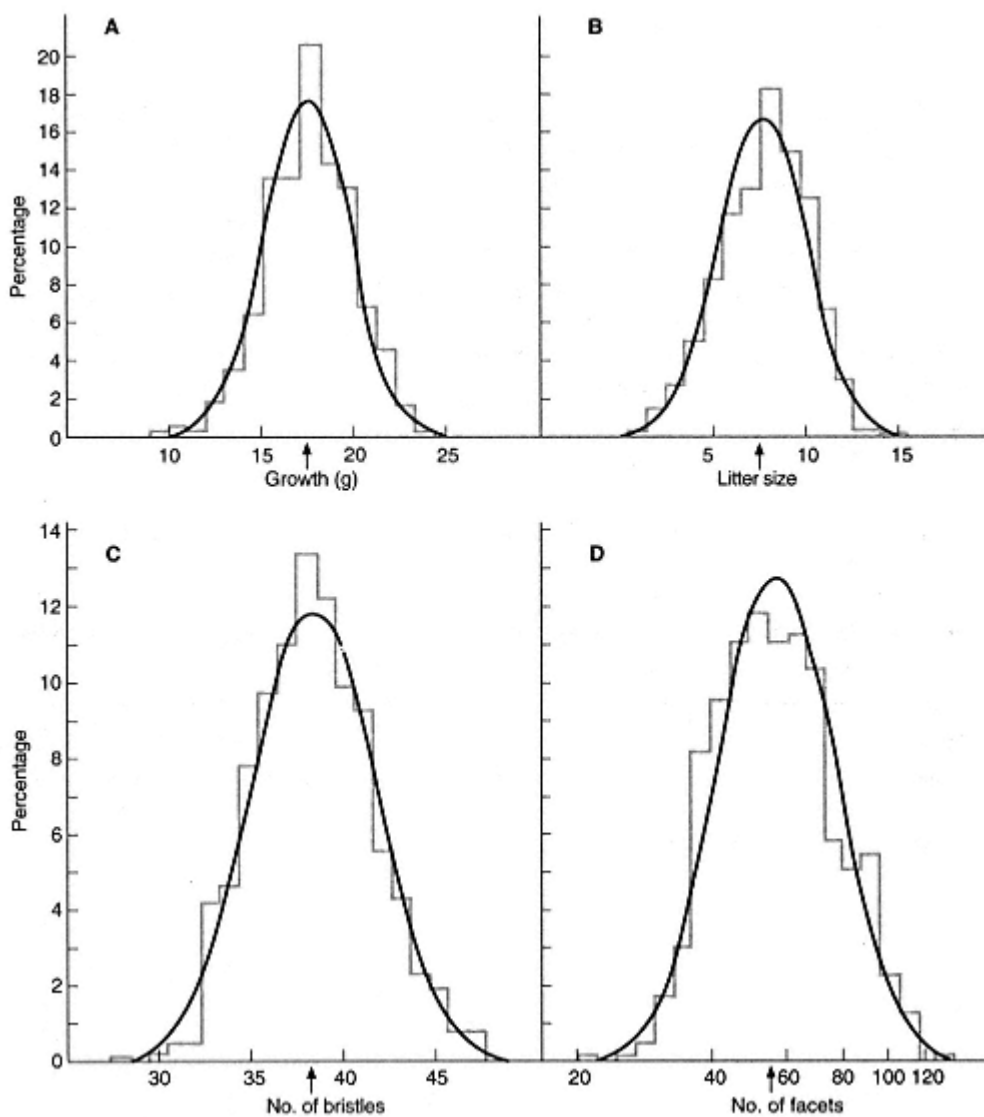

Figure 6.2

Frequency distribution of four quantitative traits, with normal curves superimposed: **A** mouse, growth from 3 to 6 weeks of age; **B** mouse litter size; **C** *Drosophila melanogaster*, abdominal bristle number; **D** *D. melanogaster*, number of eye facets in the mutant Bar. (After Falconer 1981.)

of different absolute size. If their heights are normally distributed, their weights cannot be, and vice versa, because $\text{weight} \propto (\text{height})^3$

Resemblances between Relatives

How similar, on the additive genetic model, do we expect relatives to be, when compared to two random members of the population? The most direct approach is

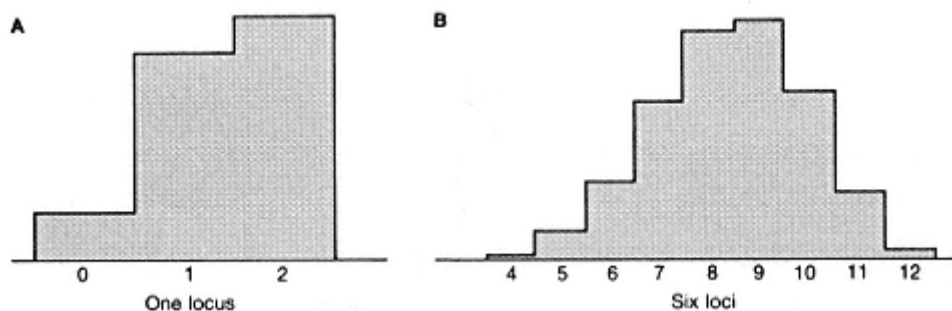

Figure 6.3
Phenotypic distributions of a trait determined by additive genes. Two alleles per locus, with frequencies 0.3 and 0.7.

to ask: what fraction of their genes are identical by descent? That is, what fraction are identical because they are copies of a gene in a relative. Remember that if we sample two genes at a locus randomly from the population, they may be identical, and they may not. What we are interested in, however, is the additional similarity arising from the genetic relationship.

We therefore imagine the genes of an individual as being of two kinds: those that are identical copies of genes present in a relative, and those that are a random sample of the genes in the population. This approach is applied in Box 6.1, for autosomal genes in a diploid population. The results are summarized in Table 6.2.

It is shown in Box 6.2 that the correlation between parent and offspring for our

Box 6.1—

Genes in Common Between Relatives

Figures 6.4 and 6.5 show how the proportion of genes in an individual that are identical copies of genes in a specified relative can be estimated.

Suppose that we have pairs of measurements, z_1 and z_2 , of some trait—say height—of pairs of relatives. The mean values are \bar{z}_1 and \bar{z}_2 . Since we are assuming that all differences are genetic, and that genes act additively, there should be some measure of resemblance which, if our model is true, has the values shown in Table 6.2. The appropriate measure is the covariance, or, more precisely, the correlation coefficient. Thus

$$\text{Cov}(z_1, z_2) = \frac{1}{n} \sum (z_1 - \bar{z}_1)(z_2 - \bar{z}_2), \quad (6.3)$$

and the correlation between z_1 and z_2 is

$$r = \text{Cov}(z_1, z_2) / \sigma_1 \sigma_2, \quad (6.4)$$

where $\sigma_1^2 = \frac{1}{n} \sum (z_1 - \bar{z}_1)^2$ and $\sigma_2^2 = \frac{1}{n} \sum (z_2 - \bar{z}_2)^2$.

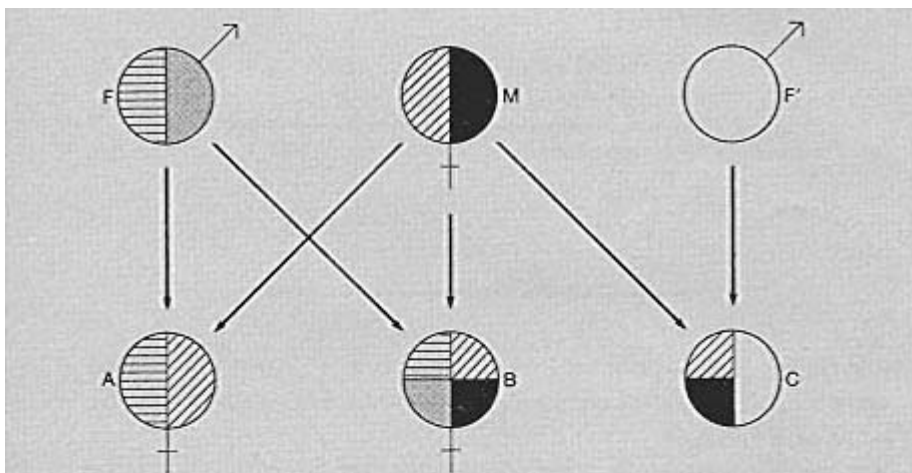

Figure 6.4 Genes in common between parents and offspring, sibs, and half-sibs. Offspring A received half her genes from father (F), and half from mother (M). B is a full sib of A, and has half her genes identical to those in A—one-quarter through F and one-quarter through M. C is a half-sib of A, with a different father, F', but the same mother. Only one-quarter of C's genes are identical to genes in A.

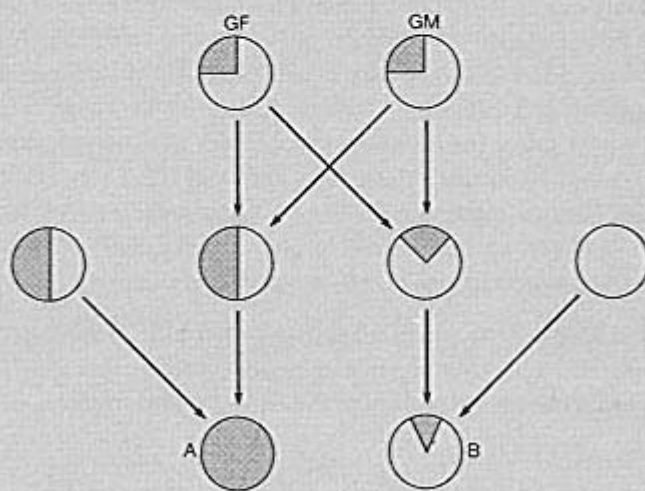

Figure 6.5. Genes in common between cousins. A and B are first cousins. Consider A's genes. One-quarter come from grandfather (GF) and one-quarter from grandmother (GM). Of these, one-quarter were transmitted to B. Hence the fraction of B's genes that are shared with A is $\frac{1}{4}(\frac{1}{4} + \frac{1}{4}) = \frac{1}{8}$.

model is indeed one-half, corresponding to the fact that they have half their genes identical by descent. The same correspondence can be shown, with more difficulty, for other relationships.

It is helpful to have some intuitive feel for why the correlation coefficient is the

Table 6.2

Fraction of genes identical by descent in a random-mating diploid population

Parent-off spring	1/2
Full sibs	1/2
Half-sibs	1/4
First cousins	1/8

right measure. This is done in Box 6.3, where it is shown that r does indeed measure the causes that are common to the members of a pair, as a fraction of the total causes of variation.

Suppose that we find, in some population, that the correlation between the heights of sibs is indeed one-half. Does this prove that our model is correct, and in particular that all variance is caused by genes with additive effects? It does not, for two reasons:

1. In many species, sibs share an environment as well as genes. Sib correlations of approximately one-half are not uncommon for human traits, but by themselves they prove little, because the common causes may be environmental.
2. Genes that act non-additively may cause correlations between sibs, but not between parent and offspring. This is illustrated in Table 6.4, for a trait determined by a single overdominant locus, with phenotypes $aa = 0$, $Aa = 1$, and $AA = 0$, and allele frequencies of a and A of 0.5. There is a resemblance between sibs, because some families are all 0, and some are all 1. But there is no correlation between parent and offspring: AA , Aa , and aa fathers have, on average, the same proportions of different kinds of offspring.

It follows that a sib correlation of 0.5 proves rather little. But a correlation of 0.5 between parent and offspring, if environmental correlations can be ruled out, would indicate that our model is close to the truth for that trait.

The Effects of Inbreeding

What does our model predict as the result of continued inbreeding—that is, of mating together close relatives? Suppose that, starting from an outbred population, we mate brother and sister in every generation. Consider a single locus, with two alleles a and A , segregating in the initial population. As we inbreed, sooner or later we will mate $AA \times AA$ or $aa \times aa$. Once that has happened, the line will be genetically homozygous at that locus indefinitely, barring new mutation. If the initial population was segregating at many loci, an inbred line will become homozygous at successively more loci. The rate of this process is treated theoretically on

Box 6.2—**The Correlation Between Parent and Offspring**

In a diploid random-mating population, the value of some trait is determined by two alleles at a locus, with values $aa = 00$, $Aa = 1$, and $AA = 2$. The frequency of allele a is p . Table 6.3 shows the mean values of sons from each type of father. In calculating the offspring from, say, an Aa father, we note that the father contributes alleles a or A with probability $1/2$, and that, in either case, the mother contributes alleles a and A with probabilities p and q , respectively.

Table 6.3

The parent-offspring correlation at an additive locus

Father Genotype	Frequency	Phenotype	Son			Mean phenotype of sons
			aa 0	Aa 1	AA 2	
aa	p^2	0	p	q	—	p
Aa	$2pq$	1	$p/2$	$p/2 + q/2$	$q/2$	$1/2 + q$
AA	q^2	2	—	p	q	$1 + q$

$$\begin{aligned} \text{Now} \quad \sum(x - \bar{x})(y - \bar{y}) &= \sum xy - \bar{x} \sum y - \bar{y} \sum x + n\bar{x}\bar{y} \\ &= \sum x - n\bar{x}\bar{y}. \end{aligned}$$

For our model, $n = 1$ (since we are working with frequencies), $\bar{x} = \bar{y} = 2q$, and $\sigma_x^2 = \sigma_y^2 = 2pq$. From the table

$$\begin{aligned} \sum xy &= 0 \times p^2q + 2pq(\frac{1}{2} + q) + 2q^2(1 + q) \\ &= pq + 2q^2 + 2pq^2 + 2q^3 \\ &= pq + 2q^2 + 2q^2(p + q) = pq + 4q^2. \end{aligned}$$

$$\text{Hence} \quad \text{Cov}(xy) = pq + 4q^2 - (2q^2) = pq,$$

$$\text{and} \quad r = \text{Cov}(xy)/\sigma_x\sigma_y = pq/2pq = 0.5.$$

Hence the correlation between father and son (or, since we are considering autosomal genes, between parent and offspring of either sex) is one-half. If the trait is affected by genes at many loci, the value of r is unaltered, provided that genes at different loci combine additively.

p.000. For the present, however, we can make a number of qualitative predictions from our model.

1. An inbred line will become phenotypically more uniform, until finally all members are identical. This, of course, does not happen, because inbreeding does not eliminate environmental variance. However, if genetic and environmental effects are additive and independent, so that $V = V_G + V_E$, we would expect phenotypic variance to decline, as V_G tends to zero. This expectation is

**Box 6.3—
The Correlation Coefficient**

Suppose that we have measurements, z_1 and z_2 , on pairs of relatives, for example sibs. It is convenient to take these measures as departures from the mean values: hence the mean value of z_1 and of z_2 is zero. The correlation coefficient is then

$$r = \sum z_1 z_2 / (\sum z_1^2 \sum z_2^2)^{1/2}. \quad (6.5)$$

The values of z_1 and z_2 are made up of two components, one of which is common to the two members of a pair, and the other of which takes independent values for the two members. That is

$$z_1 = x_1 + y_1; \quad z_2 = x_2 + y_2,$$

where x_1, x_2 are the common components, and y_1 and y_2 the independent components. Thus $x_1 = x_2$ for each pair. Then

$$\begin{aligned} \sum z_1 z_2 &= \sum (x_1 + y_1)(x_2 + y_2) \\ &= \sum x_1^2 + \sum x_1 y_2 + \sum x_2 y_1 + \sum y_1 y_2. \end{aligned}$$

Now the expected value of a term such as $\sum x_1 y_2$, consisting of the product of two independent variables, is zero. This is because the cases in which the two values have the same sign (+ + or - -) are exactly balanced by those in which they have opposite signs (+ - or - +). Hence

$$\sum z_1 z_2 = \sum x_1^2, \quad (6.6a)$$

and, by a similar calculation,

$$\sum z_1^2 = \sum x_1^2 + \sum y_1^2; \quad \sum z_2^2 = \sum x_2^2 + \sum y_2^2. \quad (6.6b)$$

In the case of pairs of relatives, the values of the independent components of variance, $\sum y_1^2$ and $\sum y_2^2$, will be equal. Hence, substituting from Equations 6.6a and 6.6b into Equation 6.5, we have

$$r = \sum x_1^2 / (\sum x_1^2 + \sum y_1^2). \quad (6.7)$$

We can therefore regard r as a measure of the variance that is common to the members of a pair, as a fraction of the total variance. For our additive genetic model, the value of r is equal to the fraction of genes in the two members of a pair that are identical by descent.

often not realized: it is common to find that inbred lines are more variable than the outbred populations from which they were derived. This is evidence that inbreeding reduces the capacity of organisms to regulate during development: inbreeding reduces canalization, or developmental homeostasis.

Table 6.4

Resemblance between sibs, and between parents and offspring, for a trait determined by a pair of alleles with overdominant effects. Gene frequency = 0.5

Parents		Frequency	Offspring phenotypes		Combined offspring		
♂	♀		0 (AA or aa)	1 (Aa)	0	1	
AA	AA	1	1	0	}	2	2
AA	Aa	2	1/2	1/2			
AA	aa	3	0	1			
Aa	AA	2	1/2	1/2	}	4	4
Aa	Aa	4	1/2	1/2			
Aa	aa	2	1/2	1/2			
aa	AA	1	0	1	}	2	2
aa	Aa	2	1/2	1/2			
aa	aa	1	1	1			

Note that the three kinds of male have the same frequencies of 0 and 1 offspring, so the parent-offspring correlation is zero, but there are families that are all 0 and 1: the sib correlation is 0.25.

2. An inbred line will become genetically uniform, and will no longer respond to artificial selection. This prediction is born out by experiment. In vertebrates, a second proof of the genetic uniformity of inbred lines is possible: skin can be grafted between members of a line.

Inbreeding has one other effect that is not predicted by the additive model. It is usually accompanied by a massive decline in fertility, viability, and other fitness components. This is illustrated in Fig. 6.6. One reason for inbreeding depression is that the line becomes homozygous for deleterious recessives that were present in the initial population. A second possible reason is that there are some loci at which the heterozygote is fitter than either homozygote (see p. 65): if so, inbreeding will inevitably lead to a decline in vigour. There has been considerable argument about whether this second effect is important: the causes of inbreeding depression are discussed further in Box 6.4.

The Effects of Directional Selection.

Figure 6.9 defines some of the terms used to describe directional selection:

The **selection differential**, S , is the difference between the mean value of the selected parents, and that of the population as a whole.

The **response**, R , is the difference between the mean value of the offspring generation, and that of the population in the previous generation.

The **intensity of selection**, I , is S/σ_p , where σ_p is the phenotypic standard deviation of the population before selection.

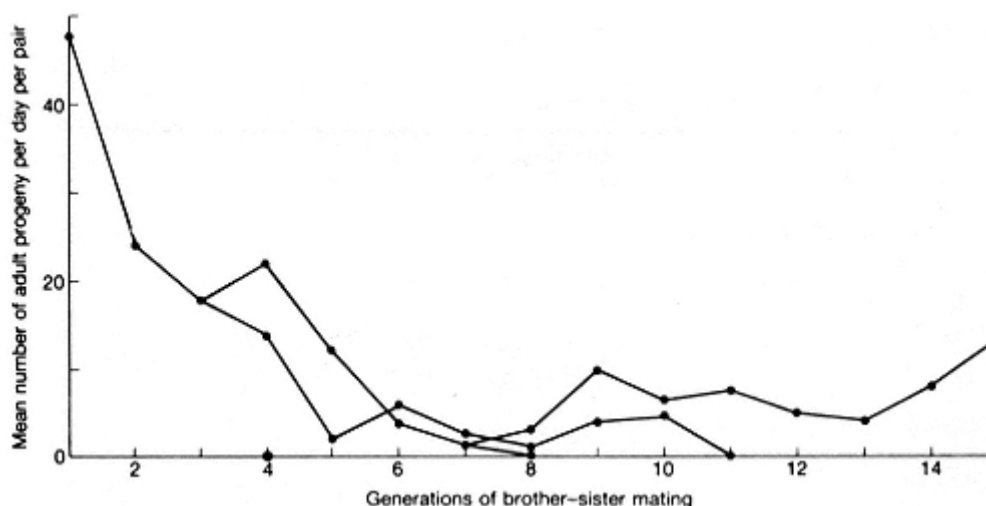

Figure 6.6

The effects of inbreeding in *Drosophila subobscura*. The line was split in generations 3 and 7: only one sub-line survived (Hollingsworth and Maynard Smith 1955). The line was continued for 100 generations, but the productivity did not rise above 10-15 offspring per day.

Box 6.4—

The causes of inbreeding depression

The phenomena to be explained are as follows. Inbred lines derived from naturally outbreeding populations show a decline in viability, fertility, and growth rate. When inbred lines are crossed, the F_1 hybrids are usually as vigorous as the members of the original outbred population: that is, they show hybrid vigour (see Fig. 6.7 for an example).

There are two possible reasons for inbreeding depression:

1. **True overdominance:** that is, there are loci at which the heterozygote is fitter than either homozygote.
2. **Associative overdominance.** Different inbred lines become homozygous for different deleterious recessive genes. For example, one line might have the genotype $m_1 + / m_1 +$, and another $+ m_2 / + m_2$. The F_1 between them would be $m_1 + / + m_2$, and would be of high fitness, because the deleterious genes m_1 and m_2 are recessive.

It is certain that some part of the decline in fitness is caused by deleterious recessive genes. As inbreeding continues, however, the more serious recessives (e.g. lethals) will be eliminated by selection. Lines which do not die out recover somewhat in vigour, as shown in Fig. 6.6. They do not recover fully, because, by chance, some deleterious alleles will become fixed, and once this happens only back mutation can remove them.

How can we decide whether truly overdominant loci are also important?

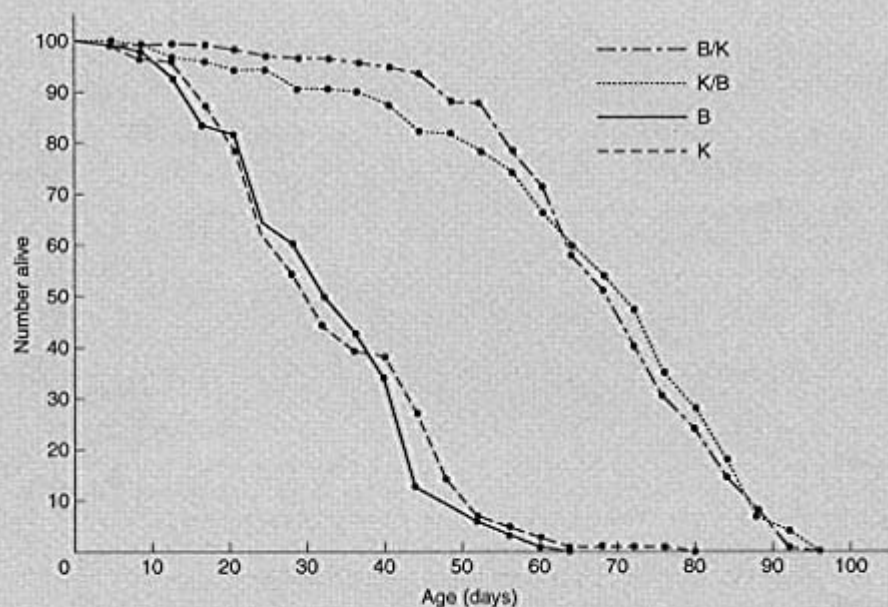

Figure 6.7 An example of hybrid vigour. Survival curves for two inbred lines, B and K, of *Drosophila subobscura*, and the F_1 hybrids, B/K and K/B, between them (sexes combined). (From Clark and Maynard Smith 1955.)

There are two possible methods. One is to identify the particular loci involved. Box 4.3 presented evidence that some enzyme loci that are polymorphic in natural populations are truly overdominant. But we have no evidence that such loci are important in inbreeding depression.

The second is to use the methods of quantitative genetics. Suppose that inbreeding depression is caused by homozygosity for regions of chromosome: I leave open for the moment whether this is true or associative overdominance. Let us call the chromosome regions a and A , without implying that these are single genes. The phenotypes are $aa = 0$, $Aa = 1$, and $AA = 0$: that is, homozygotes are of low vigour.

Two inbred lines have the genotypes aa and AA . Figure 6.8 shows the genotypes and phenotypes of the F_1 and F_2 hybrids, and also of progeny obtained by backcrossing F_2 individuals to the parental lines. It has been assumed in the figure that chromosome regions a and A behave as units: that is, if the cause is associative overdominance, the loci would have to be fairly tightly linked.

Notice the following facts:

1. Members of the F_2 differ in phenotype.
2. The offspring of different F_2 individuals, averaged over the two backcrosses, always have the same mean values. However, if A were dominant to a , there

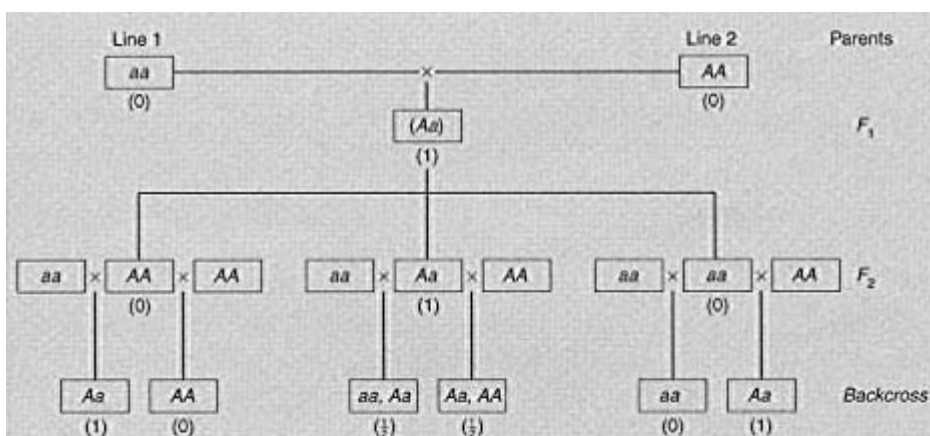

Figure 6.8 F_1 , F_2 , and backcross generations between two inbred lines, assuming that the phenotypes are $aa = 0$, $Aa = 1$, and $AA = 0$. Mean phenotypes are shown in parentheses. Note that the three F_2 genotypes have different phenotypes, but the average phenotypes of their backcross progeny are the same.

would be differences between the mean values of the offspring of different F_2 individuals.

Therefore, by comparing these two kinds of variance—between F_2 individuals, and between the mean values of their backcross offspring, we can get a measure of how much overdominance there is among the F_2 (the exact method of analysing the variance is described by Bulmer 1980).

Möll *et al.* (1964) used this method to analyse crosses between inbred lines of maize. They found appreciable overdominance, but this could be from either of the two causes. They therefore interbred the F_2 for a number of generations, and repeated the analysis on the F_8 . Now if the cause of overdominance is the presence of repulsion linkages between deleterious recessives ($m_1 +$ and $+ m_2$), this procedure, by allowing recombination and hence reducing linkage disequilibrium, should destroy the overdominance. This is in fact what they found. They concluded that, in maize, hybrid vigour can be accounted for by associative overdominance, and that there is no reason to assume the presence of truly overdominant loci.

If all or most of inbreeding depression is caused by homozygosity for deleterious recessives, it should be possible to produce an inbred line that is as vigorous as an outbred population. Thus different lines will be homozygous for different recessives. By crossing two lines, and then again inbreeding, one should obtain a new line with fewer deleterious genes. Repeating this process should ultimately produce inbred lines of high fitness: in contrast, if true overdominance is widespread, no inbred line can be of high vigour. In practice, it

has proved difficult to obtain vigorous inbred lines. However, there are natural experiments. Many plant species show a high frequency of self-fertilization in nature, but, almost always, there is occasional outcrossing. This provides the ideal breeding system for trying out many different homozygous genotypes, and eliminating the less fit.

Do naturally selfing plants show hybrid vigour when they are crossed? The degree of hybrid vigour is certainly not as great as it is when crossing inbred lines derived from natural outbreeders, but there is evidence for a small degree of hybrid vigour. For example the poppy *Papaver dubium* shows 75 per cent selfing in the wild. Gale *et al.* (1976) derived a number of selfed lines of *P. dubium*. When they crossed lines derived from the same wild population, they found that mean capsule number was usually greater in the hybrids than in either line. However, this does not prove that overdominant loci are important. Mutation is a continuing process. Inbred lines will carry mutations that have arisen recently: different lines will carry different mutations, and will display hybrid vigour when crossed.

The evidence from quantitative genetics, then, is consistent with the view that inbreeding depression is caused by homozygosity for deleterious recessives, and that hybrid vigour arises from associative overdominance. A species with a high level of inbreeding or selfing will have a low frequency of deleterious recessives, because the mutants that do occur will be rapidly eliminated. Most deleterious genes in such species will be of recent origin. At equilibrium between mutation and selection, however, the genetic load due to deleterious mutations will equal the mutation rate (see p. 56), and will be the same in an inbred and an outbred population. Even in a natural inbreeder there may be some benefits from outcrossing, because different lines will carry different recently arisen mutations.

How do we expect R to be related to S ? For our model, the answer is simple: we expect $R = S$. The reason is as follows. At each locus, the offspring generation has the same alleles, in the same frequencies, as the selected parents. Since all differences are genetic, and genes act additively, the mean offspring phenotype equals the mean parental phenotype: that is $R = S$. In practice, as will be discussed below, $R < S$: the response to selection is not as great as the selection differential.

We can now summarize some of the predictions of the additive genetic model:

1. Phenotypic distributions will be Gaussian: the fact that many actual distributions are approximately Gaussian is therefore consistent with the model, but it is not strong confirmation of it.
2. The phenotypic correlations between relatives will be equal to the proportion of genes identical by descent.

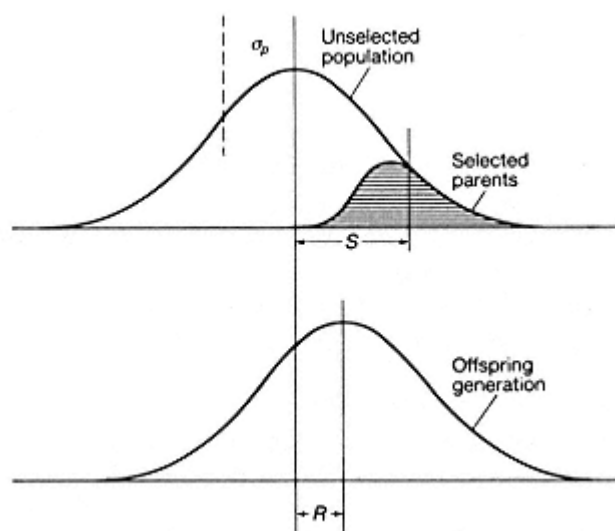

Figure 6.9
 Definition of some terms used in describing selection. The intensity of selection,
 $I = S/\sigma_p$; the realized heritability, $h^2 = R/S$.

3. Inbreeding will produce a population that is genetically and phenotypically uniform.
4. The response to selection, R , is equal to the selection differential, S .

We have already met some facts that do not agree with these predictions. In particular:

1. Inbred lines are phenotypically variable: however, the results of inbreeding do conform to prediction in that selection on an inbred line is usually ineffective.
2. Inbred lines usually show a loss of viability and fertility.
3. The response to selection is usually less than the selection differential.

The next section describes a more realistic model, allowing for environmental causes of variation, and for non-additive effects, which is able to account for these discrepancies.

A More Realistic Model

The most obvious fact that has been omitted from the model described above is that many differences are environmentally caused. I now introduce environmental variance, but for the time being I retain the additive assumption: that is, environmental and genetic factors act additively, as in Table 6A, and not as in Table 6.1B, and genes act additively, as assumed in the last section. We can then regard the phenotype, Y , as the sum of a genetic and environmental component,

$$Y = G + E, \quad (6.8)$$

and, if genotype and environment are independent, the total variance of Y is the sum of the genetic and environmental variances,

$$V = V_G + V_E.$$

Clearly, the introduction of environmental variance can explain the fact that inbred lines are phenotypically variable: V_G goes to zero, but V_E remains. However, with the additive model we still cannot explain why, in some cases, V is actually greater in an inbred line than in the outbred population from which it was derived. This requires non-additive effects, or gene-environment interaction: the effects of environmental factors on the phenotype are greater on an inbred than on an outbred genetic background.

Box 6.5—

The Response to Selection for the Additive Model

In reading this Box, it will be helpful to remember the argument of Box 6.3, which was that a correlation coefficient measures the variance that is common to the members of a pair, as a fraction of the total variance.

For the additive model, $Y = G + E$, where Y is the phenotype of an individual, and G and E are the genetic and environmental contributions to Y , it is convenient to measure Y as a departure from the mean value of the population: the mean values of G and E in the population are also zero. If we select a set of parents of mean phenotype \bar{Y}_P , and obtain offspring of mean phenotype \bar{Y}_O , then the selection differential $S = \bar{Y}_P$, and the response $R = \bar{Y}_O$.

The first point to establish is that, in any set of individuals, the mean value of G depends only on the gene frequencies, and not on the genotype frequencies. Thus:

Genotype at a locus	aa	aA	AA
Contribution to phenotype	0	d	$2d$
Frequency	P	Q	R

Then the contribution of the locus to G is $dQ + 2dR = 2dp$, where p is the frequency of allele A : the contribution depends on p but not separately on the genotype frequencies. If loci combine additively (that is, no epistasis), then G depends only on the gene frequencies.

The next point is this: if a set of individuals breed together and produce a new generation, then the mean value of G among the offspring equals the mean value among the parents. This follows from the fact that the gene frequencies among the offspring equal those among their parents.

We are now in a position to tackle the main problem. If we select a set of parents with mean phenotype \bar{Y}_P , what will be the mean phenotype \bar{Y}_O of their offspring?

We have $\bar{Y}_p = \bar{G} + \bar{E}$,
and $\bar{Y}_o = \bar{G}$.

The second equation holds because the offspring have the same genetic contribution as their parents, but are exposed to a typical range of environments, with zero mean.

What we need to know is the expected \bar{G} , given that we know \bar{Y}_p . That is, we need to know the value of b in the equation

$$\bar{G} = b\bar{Y}_p.$$

In statistical terms, b is the regression of \bar{G} on \bar{Y}_p . From statistical theory

$$\begin{aligned} b &= \frac{\text{Cov}(G, Y)}{Y_Y} = \frac{\Sigma GY}{\Sigma Y^2} \\ &= \frac{\Sigma G(G + E)}{\Sigma Y^2} \\ &= \frac{\Sigma G^2}{\Sigma Y^2} = \frac{V_G}{V_Y}. \end{aligned}$$

Hence, since $R = \bar{Y}_o$, and $S = \bar{Y}_p$,

$$R = \frac{V_G}{V_Y} S. \quad (6.9)$$

This equation is often written $R = h^2 S$, where h^2 is known as the heritability, and is the ratio of the additive genetic variance to the total variance. Remember that, in reaching this conclusion, we have assumed that genetic and environmental effects are additive, and that they are uncorrelated (we assumed $\Sigma GE = 0$).

What of the relation between response to selection and selection differential? It is shown in Box 6.5 that

$$R = h^2 S, \quad (6.10)$$

where
$$h^2 = V_G / (V_G + V_E). \quad (6.11)$$

In interpreting this equation, it is important that the derivation in Box 6.5 assumes additivity, and in particular that genes act additively. We have seen (Table 6.4) that there can be genetic variance, but no correlation between parent and offspring, and hence no response to selection. It is only the additive effects of genes that contribute to the response to selection. We should therefore rewrite Equation 6.11 as

$$h^2 = V_A / V, \quad (6.12)$$

where V_A is the variance due to the additive effects of genes, and V the total phenotypic variance. So defined, h^2 is the **heritability**, or, more precisely, the **narrow-sense** heritability. In contrast, the **broad-sense** heritability is defined as V_G/V , where V_G is the total genetic variance. Since only the additive effects of genes contribute to the response to selection, it is the narrow-sense heritability that should be used in the equation $R = h^2S$.

How are we to measure h^2 ? The simplest way is to carry out a single generation of selection, and measure R and S . Then $h^2 = R/S$. A heritability measured in this way is called **realized** heritability.

An alternative is to measure V_A from the resemblance between relatives: this method is described in Box 6.6.

One last point should be made about estimates of heritability. To say, for example, that h^2 for size in *Drosophila melanogaster* is 0.4 cannot be a universal truth. At best, it is true of a particular population in a particular range of environments. Thus h^2 measures the additive genetic variance as a fraction of the total variance. Any change that reduces the genetic variance, or increases the environmental variance, will reduce h^2 .

Before turning to the empirical data, it is useful to review some of the kinds of genetic variation that do not contribute to a selective response. There are three main categories:

Box 6.6—

Estimating h^2 From the Resemblance Between Relatives

If mating is random, and if there is no correlation between the environments of parents and their offspring, then only additive genes cause a resemblance between them. It was shown in Box 6.2 that half the additive genetic variance is common to a parent and a child. Hence the correlation coefficient between a parent and child is $r_{PO} = \frac{1}{2}V_A/V = h^2/2$, or $h^2 = 2r_{PO}$.

We cannot estimate h^2 from the correlation between full sibs, because (Table 6.4) non-additive genes can cause a resemblance between sibs. However, this objection does not arise in the case of half-sibs (see Fig. 6.10). Suppose a male has two offspring, by two different females. If the females are unrelated, and if the environments of the offspring are also random, then any similarity between the offspring must be caused by genes from the father. Now the genetic backgrounds and the environments in which these genes find themselves in the two offspring are uncorrelated (this is not so for full sibs because they also have a common mother). Hence a gene will only cause a resemblance between half-sibs if its effects are the same on different backgrounds and in different environments: that is, only in so far as it acts additively. On the additive genetic model, the correlation between half-sibs is $r_{HS} = 0.25$ (Fig. 6.4). Hence $r_{HS} = 0.25h^2$, or $h^2 = 4r_{HS}$.

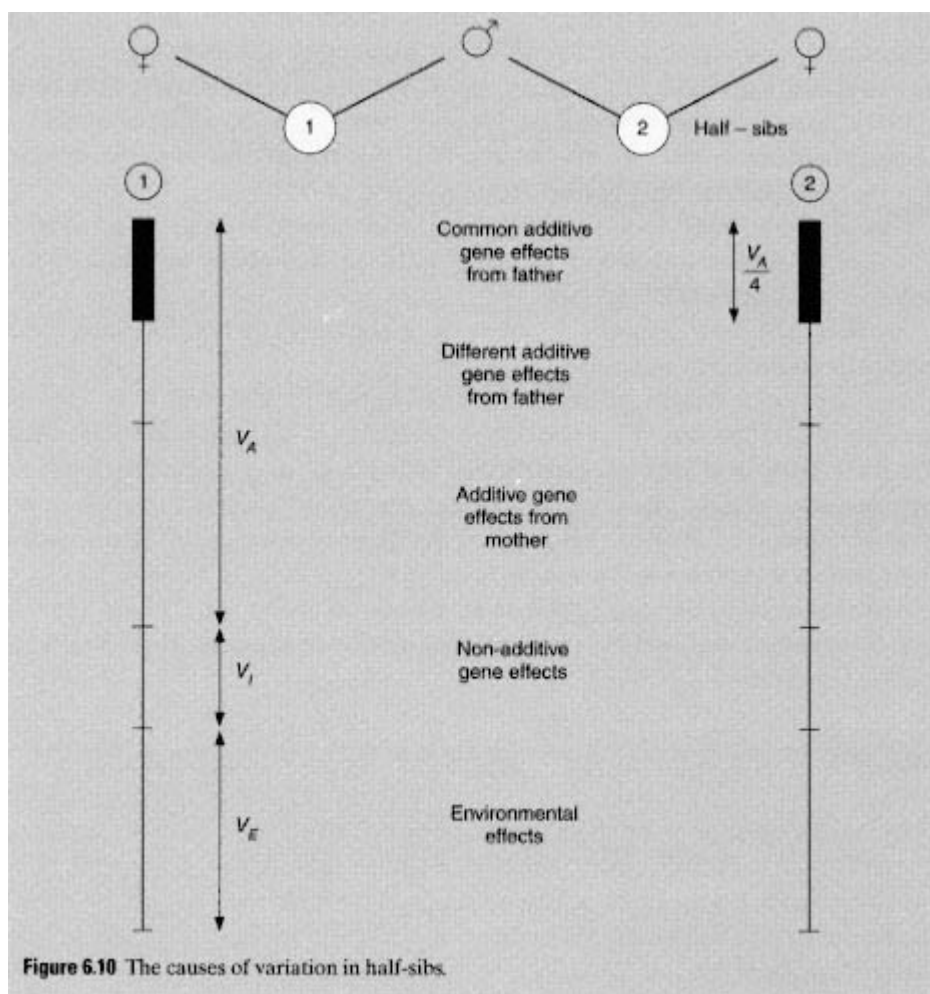

Figure 6.10 The causes of variation in half-sibs.

1. *Dominance interactions between alleles.* It was shown in Table 6.4 that, with complete overdominance ($aa = AA = 0$, $Aa = 1$), there is a correlation between sibs, but not between parent and offspring. If there is no parent-offspring correlation, there can be no response to selection.

2. *Epistatic interactions between loci.* To illustrate this, consider a haploid organism with two equally frequent alleles at each of two loci. Suppose that two of the genotypes ab and AB , are selected, and the other two, aB and Ab , are discarded. It is shown in Table 6.5 that, after the first generation, there is no response to selection. Yet there is genetic variation, and sibs do resemble one another. It is worth noting, however, that the equilibrium illustrated in the table is unstable (see Problem 8).

3. *Gene-environment interaction.* This is the phenomenon illustrated in Table 6. **B**.

Table 6.5

Selection with epistasis

	<i>ab</i>	<i>aB</i>	<i>Ab</i>	<i>AB</i>
Phenotype	1	0	0	1
Zygote frequencies, generation <i>n</i>	1/4	1/4	1/4	1/4
Adult frequencies after selection	1/2	0	0	1/2
Zygote frequencies, generation <i>n</i> + 1	3/8	1/8	1/8	3/8
Adult frequencies after selection	1/2	0	0	1/2
Zygote frequencies, generation <i>n</i> + 2	3/8	1/8	1/8	3/8
	and so on			

Zygote frequencies are derived from adult frequencies as follows:

Mating	Frequency	Genotype of offspring			
		<i>ab</i>	<i>aB</i>	<i>Ab</i>	<i>AB</i>
<i>ab ab</i>	1/4	1/4	0	0	0
<i>ab AB</i> <i>AB ab</i> }	1/2	1/8	1/8	1/8	1/8
<i>AB AB</i>	1/4	0	0	0	1/4
		3/8	1/8	1/8	3/8

Experiments in Artificial Selection

Figure 6.11 shows some of the results of an artificial selection experiment on the number of abdominal bristles in *Drosophila*: the results are typical of many such experiments. The following comparisons can be made with the predictions of the simple model:

1. The population did respond to selection in both directions. However, the response is asymmetric, being greater in the upwards-selected lines. Realized heritabilities in such experiments are less than one, because of environmental variance. Some values are given in Table 6.6: these are discussed further on p. 118.
2. The population reached a **selection limit**, beyond which further progress was difficult or impossible. Such limits are typical in laboratory experiments on artificial selection. They arise because the additive genetic variance present in the initial population has been fixed. The length of time taken to reach a limit, and the difference between the initial and final populations, depend on the number of loci involved: the matter is discussed further in Box 6.7.
3. After the selection limit was reached, populations in which selection was

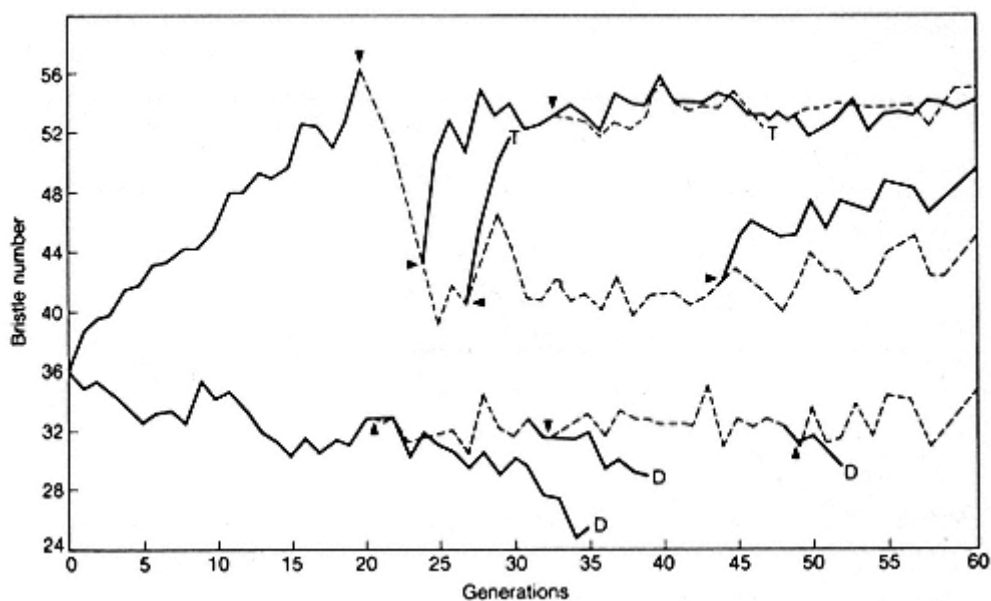

Figure 6.11

Response to selection for abdominal bristle number in *Drosophila melanogaster* (after Mather and Harrison 1949). Full lines, selected populations; broken lines, populations in which selection was relaxed; T, line terminated deliberately; D, line died out through infertility.

relaxed did not tend to return towards the original state, suggesting that there was little non-additive genetic variance for the trait. This is a little unusual: in many experiments there is some evidence for non-additive genetic effects, both in the presence of sib correlations at the selection limit, and in the tendency of selected populations to return towards their original state when selection is relaxed.

Table 6.6

Approximate values of realized heritability for traits in *Drosophila*

	h^2
<i>D. melanogaster</i>	
Abdominal bristle number	0.5
Body size (thorax length)	0.4
Ovary size	0.3
Egg production	0.2
<i>D. subobscura</i>	
Development rate	
(days from egg to adult)	
Slow-selected	0.2
Fast-selected	0.05

Box 6.7—***The Number of Loci Involved in the Response to Selection***

Suppose that, in the initial population, there are n loci affecting some trait, each with two additive alleles, with frequencies p and q . The difference between the two homozygotes is $2d$. Then the difference, D , between the mean values of the trait in up- and down-selected lines, when the selection limit is reached, is $2nd$. The additive genetic variance in the initial population is $2npqd^2$. Both D and V_A can be measured. Then

$$\begin{aligned} D^2/V_A &= 4n^2d^2/2npqd^2, \\ &= 2n/pq. \end{aligned}$$

Hence

$$n = \frac{pq D^2}{2 V_A}$$

It was suggested in the main text that the initial frequencies of the relevant loci are intermediate, essentially because there is no evidence of a large increase of V_A as selection proceeds. If $p = q = 1/2$, then

$$n = \frac{1}{8} \frac{D^2}{V_A}. \quad (6.13)$$

Using this formula, Falconer estimates that the number of loci involved in some selection experiments in mice and *Drosophila* is in the range 30–100.

The largest potential source of error in such an estimate lies in the assumption that $p = q = 1/2$. If $p = 0.01$, then $n \approx D^2/200 V_A$. Falconer's estimates would then lie in the range 1–5 loci. This is almost certainly an underestimate, but the value of 30–100 is probably an overestimate.

4. Flies in the final populations were of lowered fertility. Such **correlated responses** to selection are common. They may be caused by pleiotropic effects of the selected alleles, or by linkage disequilibrium between the selected alleles and loci affecting other traits: remember that these experiments are usually carried out on rather small populations, so that linkage disequilibrium due to chance is bound to be present.

One final question is crucial if we wish to extend these conclusions from artificial selection to evolution. How far does the existence of a selection limit depend on the fact that these experiments involve intense selection on a single trait in a small population? In these experiments, the response depends almost entirely on genetic variance present at the start. The number of new mutations, occurring after the start of the experiment, will be proportional to the number of generations, and to the number of parents in each generation: if both these are small, new mutations can play little part in the response.

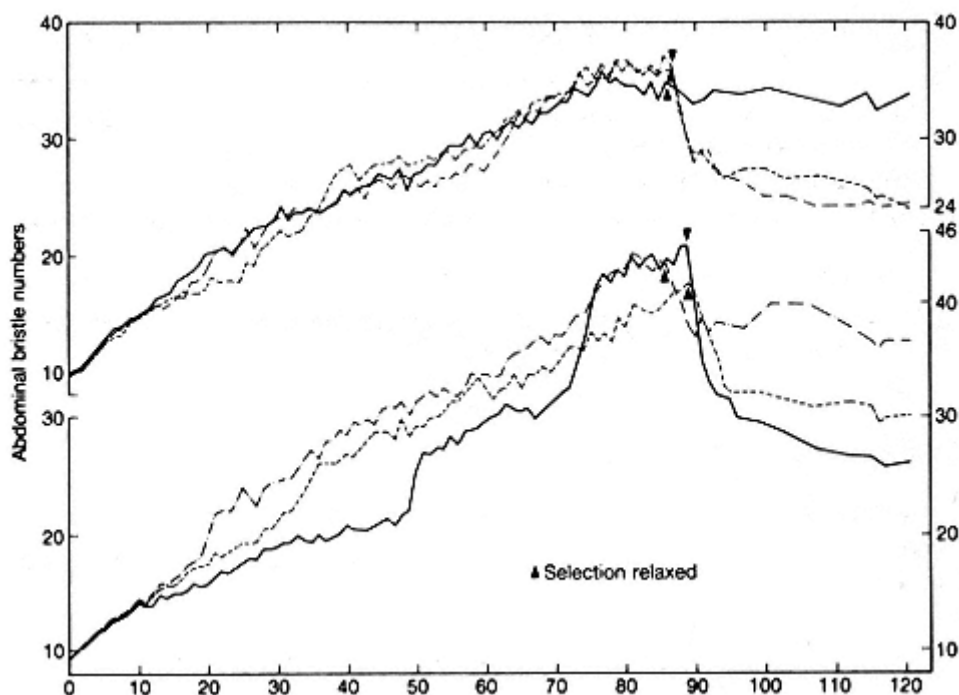

Figure 6.12

Response to long-term selection for abdominal bristle number, using 50 parents of each sex in each generation; six replicate lines were run (after Yoo 1980).

Experiments in which selection was practised for many generations on a larger population suggest that selection limits may indeed be an artefact of small population size: Fig. 6.12 shows the results of such an experiment. In each line, 50 parents of each sex were selected, out of a total of 500 flies scored for abdominal bristle number in each generation. Selection was continued for 86-89 generations. Averaged over six replicate lines, the initial number was 8.2, and the final number was 33.9 bristles, a fourfold increase. The increase was 16 times the phenotypic standard deviation in the initial population. In quantitative terms, this is a greater response than the increase in brain size between *Australopithecus* and ourselves, of which we are so proud. In evolutionary terms, however, 50 pairs is a small population, and a selection of 20 per cent intense. This is reflected in some details of the response. Most lines showed alternate periods of slow and rapid response: the latter reflect periods when new favourable mutants were spreading through the population. When selection was finally relaxed, all the lines showed a rapid return towards their original state: this is probably because some part of the response was due to mutants with the following properties:

Genotype	<i>aa</i>	<i>Aa</i>	<i>AA</i>
Bristle number	low	high	—
Fitness	high	high/low	lethal

Quantitative Variation and Fitness

The equation $R = h^2S$ relates the response to selection on some trait to the selection differential. Suppose, now, that the trait under consideration is not wing length or bristle number, but fitness. That is, expected number of offspring. A population, before selection, consists of a number of genotypes $g_1, g_2, \dots, g_i, \dots$. Let the frequency of g_i be p_i and its fitness be w_i . Then we can define the **mean fitness** as

$$\bar{w} = \sum p_i w_i \quad (6.14)$$

After selection has operated, the frequency of genotype g_i is $p_i w_i / \bar{w}$, and hence the mean fitness of the selected parents is

$$\bar{w}' = \sum p_i w_i^2 / \bar{w}.$$

Hence the selection differential on fitness is

$$S = \bar{w}' - \bar{w} = \sum p_i w_i (w_i - \bar{w}) / \bar{w}.$$

We want now to show that S is equal to V_w , the variance of fitness before selection. Thus

$$\begin{aligned} V_w &= \sum p_i w_i (w_i - \bar{w})^2 \\ &= \sum p_i w_i (w_i - \bar{w}) - \sum p_i \bar{w} (w_i - \bar{w}), \end{aligned}$$

and since the second term is zero,

$$V_w = \sum p_i w_i (w_i - \bar{w}),$$

and since, in a density-regulated population, $w = 1$, we have $S = V_w$. Remembering that $h^2 = V_A / V_w$, and that R is the change in the selected trait in one generation, Equation 6.10 becomes

$$\Delta \bar{w} = V_A, \quad (6.15)$$

where Δw is the increase in mean fitness in one generation.

This is a version of Fisher's 'fundamental theorem of natural selection'. His formulation was 'the rate of increase of fitness of any organism at any time is equal to its genetic variance at that time'. Clearly, by 'genetic variance' he meant additive genetic variance. Thus, if the genetic variance of a population was due entirely to genes with heterotic effect (see p. 100), and the population was at a selective equilibrium, then both Δw and V_A would be zero, so Equation 6.15 would be true, but the total genetic variance of fitness, V_w , would not be zero.

Fisher thought that his theorem could play the same role in biology as is played by the second law of thermodynamics in physics, by placing an arrow on time. Since a variance cannot be negative, Equation 6.15 implies that w can only increase, as entropy increases. There has been much subsequent debate about the theorem. My own view is that it cannot play an important role in biology. If it were true, it should be the case that natural selection necessarily increases the mean

fitness of a population in some meaningful sense: for example, that it can maintain a larger population size, or is better able to survive a change in the environment, or competition from other species.

Unfortunately, none of these conclusions follow. Consider, for example, the following plausible case. Selection within a species favours the larger individuals, because they are better able to defeat others in competition for scarce resources. The result is a steady increase in size, beyond the level that would be optimal in the absence of intraspecific competition. Hence the species becomes rarer, and less able to survive competition from other species. This illustrates one reason why Equation 6.15 can lead to misleading conclusions. It is based on the assumption that the fitness of a genotype is constant, and independent of what other genotypes are present. This is often not the case.

There is, however, one implication of Equation 6.15 that is illuminating. In most populations, the additive genetic variance of fitness will be small, because such variance will be used up by natural selection, just as artificial selection exhausts the additive variance for the selected trait. This conclusion is confirmed by the data in Table 6.6, showing that h^2 tends to be small for traits directly contributing to fitness. Three points need to be made:

1. In some cases, there was substantial non-additive genetic variance for fitness-related traits.
2. It would be wrong to conclude that the heritability of fitness will be zero, both because recurrent deleterious mutations will cause some heritable fitness differences, and because, in a changing environment, populations are not in equilibrium under selection.
3. Even if the heritability of fitness is small, there may be substantial heritability for particular components of fitness, if different components are negatively correlated. In *Drosophila*, for example, Rose and Charlesworth (1980) found that those genotypes that lay eggs rapidly when young tend to be short lived, and vice versa. This is not surprising, because there is evidence that, in females of the same genotype, laying eggs shortens life.

The Maintenance of Genetic Variance for Quantitative Traits

Why is there polygenic variation in natural populations? Ultimately, the origin is mutation, but why has not natural selection eliminated the less fit variants? From the arguments of Chapter 4, we can see that there are two possible answers:

1. There is a balance between mutation and selection.
2. There is a balance of selective forces (heterosis, frequency-dependence, selection for different types in different places or at different times).

Until relatively recently, the first of these possibilities was not taken very seriously as an explanation of polygenic variability. The arguments on page 55 led us to think that, if a mutant allele reduces fitness, even slightly, then its frequency in

a natural population would be very low^切 essentially because mutation rates are very low. Now there are good reasons for thinking that the quantitative variation discussed in this chapter cannot be caused by loci with one common and one (or more) very rare alleles. If it were so, the genetic variance of a population would increase when it was exposed to directional selection (see Box 6.7, and Problem 9), and this does not usually happen. Hence, it was generally assumed that variation was maintained by a balance of selective forces.

This assumption has been challenged by Lande (1975), who has argued that quantitative variation is maintained by recurrent mutation. He suggests that most populations, most of the time, are under normalizing selection. If so, and if mutations at many loci can affect each quantitative trait, then appropriate genetic variance could be maintained, without need to invoke opposed selective forces.

This claim is still controversial. Arguments about it tend to involve complex mathematics, and extensive computer simulations. However, it is possible to grasp what the argument is about. Essentially, Lande's claim rests on one idea, and one observation. The idea is as follows. If a population is under normalizing selection for a polygenic trait, in the absence of mutation, it will ultimately lose most or all of its genetic variance, but the loss of variance will be slow. The reason is illustrated in Fig. 6.13. If, then, normalizing selection is slow to eliminate genetic variance, it is more reasonable that mutation should maintain it.

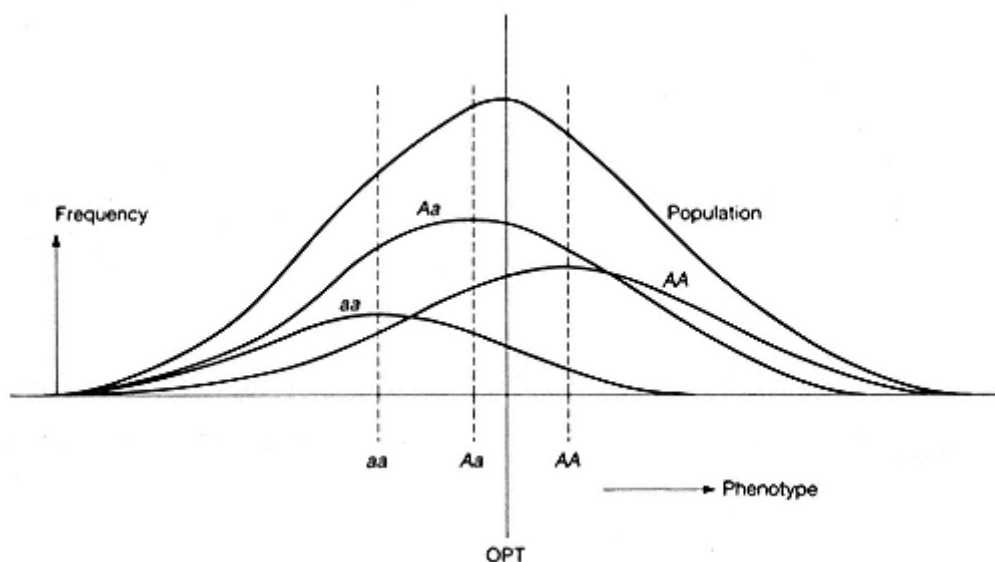

Figure 6.13

The effect of normalizing selection on the gene frequency at a locus. It is assumed that the population phenotype is normally distributed about the optimum value, OPT. The distributions aa , Aa , and AA are the phenotypic distributions of individuals with those genotypes at a particular locus. For the particular case shown, $p(a) < 0.5$ and $p(A) > 0.5$: normalizing selection will further reduce $p(a)$, until A is fixed. However, the mean of Aa individuals is close to the optimum, so the rate of approach to genetic homozygosity will be slow.

The fact concerns the rate at which new heritable variation is generated by mutation. To measure this, one first produces a genetically homogeneous population, by inbreeding or chromosome manipulation, and then watches to see how rapidly heritable variation reappears. Such experiments have been performed on *Drosophila*, maize, and mice, and on several traits in each species. All give results on the order of

$$V_m = V_E/1000, \quad (6.16)$$

where V_m is the new heritable variation arising by mutation in one generation, and V_E is the environmental variance. Since, for most traits, h^2 is on the order of 0.5, this is equivalent to saying that 1/1000th part of the genetic variance is regenerated by mutation each generation.

It is, I think, too early to say whether polygenic variation is in fact maintained by a balance between mutation and selection. However, the empirical results (Equation 6.16) are somewhat paradoxical. The nature of the paradox, and some possible resolutions, are discussed in Box 6.8. The matter is discussed further by Turelli (1986).

Box 6.8—

Is Polygenic Variation Maintained by a Balance Between Mutation and Normalizing Selection?

Suppose that there are n loci affecting a particular trait. Let u be the per locus, per generation mutation rate, and m the effect of a single mutation on the phenotype (of course, not all mutations will have the same effect: m is the root mean square of the value). Then, on the additive model, in a diploid population, the new genetic variance generated per generation is

$$2 \sum_{i=1}^n u m^2.$$

If, in a typical outbred population, v is the variance contributed by one locus, and if $h^2 = 0.5$, then Equation 6.16 implies

$$2 \sum_{i=1}^n u m^2 = 10^{-3} \sum_{i=1}^n v. \quad (6.17)$$

In Chapter 4 it was concluded that the mutation rate per gene, per generation is on the order of 10^{-5} . If so, $v \approx m^2/50$. But if the variance was caused by two or more alleles of approximately equal frequency, v would be of the same order as m^2 . This suggests that the standing genetic variance at a locus is caused by one common allele and one or more rare alleles. But, as explained in the main text, there are good reasons for thinking that polygenic variation is not caused by rare alleles: if it were, directional selection would increase genetic variance.

We are therefore faced with a paradox. There seem to be two possible ways out:
1. The polygenic mutation rate is much higher than 10^{-5} per locus, per

generation. This could be so. Thus the mutation rates estimated in Chapter 4 were for genes coding for proteins. As we shall see in Chapter 11, there is a great deal of DNA in the eukaryotic genome that is not translated. It is possible that changes in this DNA, while not altering the amino-acid sequence of any protein, may alter the rates or times at which proteins are synthesized. If so, such mutations could affect quantitative traits. This suggestion is highly speculative, but it cannot at present be ruled out.

2. There is something misleading about the empirical result summarized in Equation 6.16. It could be that the new heritable variability on which this estimate is based is not typical of the standing variability found in natural populations. Thus the new variability may involve mutations of relatively large effect (large m), whereas the standing variability involves allele differences of smaller effect.

Further Reading.

Bulmer, M.G. (1980). *The mathematical theory of quantitative genetics*. Oxford University Press.

Falconer, D.S. (1981). *Introduction to quantitative genetics* (2nd edn). Longman, London.

Turelli, M. (1986). In *Evolutionary processes and theory* (ed. S. Karlin and E. Nevo), pp. 607-28. Academic Press, New York. (An introduction to the question of whether quantitative variation is maintained by a balance between mutation and normalizing selection.)

Problems

(Problems 3 and 4 are from J.F. Crow 1986.)

1. Two alleles are segregating at each of six loci in a random-mating diploid population. At each locus, the phenotypic values of the genotypes are $-/- = 0$, $-/+ = 1$, $+/+ = 2$. The broad-sense heritability is one. Genes are additive between loci, so that the phenotype of an individual that is $-/-$ at all six loci is 0, and of one that is $+/+$ at all loci is 12. The frequencies of the $+$ allele at the six loci are 0.2, 0.3, 0.4, 0.6, 0.7, and 0.8. (a) What proportion of the population has phenotype 12? (b) What is the phenotypic variance of the population?
2. A population has genetic variance as described in Problem 1. There is also environmental variance. The total phenotypic variance is 6. Parents are selected whose phenotype is 1 unit above the population mean. What is the response to selection?
3. What is the heritability of sex?
4. Would you believe someone who told you that the correlation in intelligence between half-sibs is 0.3?
5. What is the coefficient of relatedness of a niece to her aunt?
6. In a population of *Drosophila*, the mean abdominal bristle number is 18. The

correlation between half-sibs is 0.1. A set of parents are selected with a mean number of 21. What is the expected bristle number of their offspring?

7. *A population of *Drosophila* has a mean abdominal bristle number of 24, with a standard deviation of 3. The realized heritability is 0.3. Selection limits were reached at 32 bristles in the up line, and 16 bristles in the low line. Assuming that the variance in the original population was caused by loci with two alleles at approximately equal frequencies, estimate the number of loci concerned.

8. Suppose that, in the example of Table 6.5, the adult frequencies after selection were $0.6b:0.4AB$. What will be the frequencies in the next generation?

9. The genetic variance of a population is caused by genes with additive effects. At half the relevant loci the + allele has a frequency of 0.99 and the - allele of 0.01, and at the remaining loci the frequencies of the + and - alleles are reversed. If the magnitude of the effect of an allele substitution is the same at all loci, would you expect the genetic variance to increase or to decrease under directional selection, and by how much?

Computer Projects

Usually, the simulation of polygenic inheritance requires a larger computer, and more sophisticated programming, than I have assumed in other chapters. There are two methods of computer analysis. The first is the Monte Carlo method which assumes a finite population. The genotypes of all the individuals in one generation are stored in an array. Two parents are chosen randomly, and one or more offspring are generated according to Mendelian laws and placed in an array holding the next generation, the process being repeated until the required number of offspring have been produced. The method has the advantage of realism, but only rather small populations can be simulated in a reasonable time. The alternative is to assume an infinite population, and calculate the genotype frequencies in the next generation deterministically. This can take a lot of computer time if the number of loci is large. Thus suppose there are six linked loci, with two alleles per locus. There are 64 gamete types whose frequencies must be stored in an array. To produce the next generation, assuming random mating (matters can become horrendous if we do not), we consider in turn the 2080 diploid genotypes (why 2080?) and calculate what proportion each one produces of the 64 gamete types. That takes time. If we add one locus, that would increase the time by a factor of 8. Things should get better when parallel-processing computers are available.

Because of these difficulties, the following project is suitable only for those with some computing experience:

A diploid organism has up to (say) six linked loci, with two alleles per locus. Write a procedure which, given the genotype of an individual, calculates the frequencies of all the gamete types produced, and adds those frequencies to an array holding the frequencies of the 64 possible gamete types. Assume a cross-over frequency of r between neighbouring loci. The procedure should allow for single and multiple crossing over. Assume no interference. Write the procedure in a language that

permits you to store a gamete as a binary number (with 0 and 1 specifying the alleles), that will convert binary into decimal numbers and vice versa, and that allows you to use operators AND and OR on single elements of a binary number. (A procedure of this kind is the guts of any program that simulates quantitative genetics.)

Chapter 7— A Model of Phenotypic Evolution

The hawk-dove game <small>性</small> model of contest behaviour	<u>125</u>
Asymmetric games	<u>128</u>
More than two pure strategies	<u>130</u>
Continuously varying strategies	<u>131</u>
Will a sexual population evolve to an ESS?	<u>134</u>
Further reading	<u>135</u>
Problems	<u>135</u>
Computer projects	<u>136</u>

It is often the case that the best thing to do depends on what others are doing, or, more formally, that the fitness of a genotype depends on the frequencies of other genotypes in the population. Examples include mating, dispersal, fighting and signalling behaviour in animals, growth patterns in plants, and even the replicative behaviour of viruses. Such cases are difficult to analyse using the methods of population genetics. It is often better to use evolutionary game theory, a method that concentrates on phenotypes rather than genotypes. In effect, it assumes an asexual population in which individuals produce offspring phenotypically identical to themselves. However, the method has been widely applied to sexual organisms.

I start by considering the fighting behaviour of animals. Contests are often settled by display, without escalated fighting, and contestants may pay attention to asymmetries in size or ownership. An explanation of such ritualized behaviour emerges from a simple model.

The Hawk-dove Game: A Model of Contest Behaviour

Suppose that two animals are competing for some resource. Two alternative behaviours, or 'strategies', are open to each contestant: 'hawk', H , fights in an escalated manner, and continues until it wins or is seriously injured; 'dove', D , displays, and retreats if its opponent escalates. The results of a contest are conveniently represented in a payoff matrix (Table 7.1): note that the entries are the *changes* in fitness resulting from the contest.

To model evolution, we imagine a population of individuals adopting different strategies. These may be one of the **pure strategies**, H or D , or the **mixed strategy**, 'play H with probability P , and D with probability $1 - P$ '. Individuals pair off at random, and accumulate the appropriate payoffs. They then produce offspring identical to themselves, in numbers equal to a constant initial fitness, plus a payoff. Such a population will evolve to an **evolutionarily stable strategy**, or ESS, if one exists. The conditions for a strategy to be an ESS are set out in Box 7.1.

Table 7.1

The hawk-dove game

	H	D
H		2
D	0	1

In this payoff matrix, the entries represent the payoffs (that is, changes in fitness) to an individual adopting the strategy on the left, if its opponent adopts the strategy above. The numerical values are chosen to represent a contest in which:

- (1) hawk does well against dove, but dove retreats before being injured;
- (2) two hawks engage in an escalated fight, and risk serious injury;
- (3) two doves share the resource.

Box 7.1—**Condition for an ESS**

Suppose that the members of a population have one of two phenotypes, *A* or *B*: these phenotypes are often referred to as strategies. Before reproducing, an individual engages in a pairwise interaction with a random partner. Its fitness consists of a constant value, *K*, plus a payoff: this payoff is the change in fitness resulting from the interaction. If *A* is the phenotype of an individual, and *B* of its partner, then the payoff is written $E(A, B)$, which can read as 'the payoff to *A* against *B*'. Hence, if the frequencies of *A* and *B* are $p(A)$ and $p(B)$, respectively, their fitnesses are:

$$\begin{aligned} W(A) &= K + p(A)E(A, A) + p(B)E(A, B), \\ W(B) &= K + p(A)E(B, A) + p(B)E(B, B). \end{aligned} \quad (7.1)$$

After the interaction, individuals reproduce their kind (that is, *A*s produce *A*s, *B*s, produce *B*s, and so on), and then die. The numbers of offspring produced are proportional to their fitnesses. Thus the model is one of natural selection in an asexual population. Knowing the payoffs and the initial frequencies, it is simple to calculate the frequencies in the next generation, and, by iteration, in subsequent generations. It is often more fruitful, however, to ask whether there is any evolutionarily stable strategy, or ESS. An ESS is defined as a phenotype such that, if almost all individuals have that phenotype, no alternative phenotype can invade the population.

For pairwise interactions, we find the conditions for a phenotype to be an ESS as follows. Let *I* be the phenotype of most members of the population, and *M* an alternative 'mutant' phenotype with frequency p , where $p \ll 1$. Then

$$\begin{aligned} W(I) &= K + (1 - p)E(I, I) + pE(I, M), \\ W(M) &= K + (1 - p)E(M, I) + pE(M, M). \end{aligned} \quad (7.2)$$

Then I is an ESS if, for all alternative strategies, M , $W(I) > W(M)$ when $p \ll 1$. That is, when

$$\text{either} \quad E(I,I) > E(M,I) \quad (7.3a)$$

$$\text{or} \quad E(I,I) = E(M,I) \text{ and } E(I,M) > E(M,M). \quad (7.3b)$$

Thus if Equation 7.3a is true, the values of the last terms in Equation 7.2 do not matter, because $p \ll 1$, but if $E(I,I) = E(M,I)$, the stability of I depends on these terms: that is, on Equation 7.3b.

Applying these conditions to the matrix in Table 7.1, it is clear that neither H nor D is an ESS. Thus $E(D,H) > E(H,H)$, so D can invade a population of hawks, and $E(H,D) > E(D,D)$, so H can invade a population of doves. Note that the fact that H does better in a contest between H and D does not mean that H is an ESS.

If we also allow mixed strategies, the hawk-dove game does have an ESS. Let I be the mixed strategy 'adopt H with probability P , and D with probability $1 - P$ '. Can we find a value of P such that I is an ESS? The first requirement is as follows: if I is an ESS, then, in a population of individuals adopting I , the payoff to an individual when, by chance, it plays H must be the same as the payoff when it plays D . The truth of this can be seen by a *reductio ad absurdum*. Suppose the payoff to one pure strategy, say H , is greater than the payoff to the other. Then a mutant that always played H could invade an I population, and so I would not be an ESS. This is an example of a general theorem which states that, if I is a mixed ESS, in which several pure strategies $A, B, C \dots$ are played with non-zero probabilities, then in a population of I strategists the payoffs to $A, B, C \dots$ must be equal.

We can use this theorem to find the stable value of P for the hawk-dove game. Thus we require

$$E(H,I) = E(D,I),$$

or, for the payoffs of Table 7.1,

$$2P + 2(1 - P) = 1 - P, \text{ or } P = 1/3.$$

That is, if there is a mixed ESS, it involves playing H with probability $1/3$ and D with probability $2/3$. But we have not yet shown that I is an ESS. Thus $E(H,I) = E(D,I) = E(I,I)$: to satisfy Equation 7.3b, we must now show that $E(I,H) > E(H,H)$ and $E(I,D) > E(D,D)$. In fact

$$E(I,H) = 1/3(-2) + 2/3(0) = -2/3 > -2,$$

$$\text{and} \quad E(I,D) = 1/3(2) + 2/3(1) = 4/3 > 1,$$

so both these conditions are satisfied.

We have established that 'play H with probability $1/3$: play D with probability

$2/3$ is an ESS of the game in Table 7.1. However, this requires that an individual can play a mixed strategy. What would happen if individuals can only play pure strategies H or D ? We have already seen that populations consisting entirely of H , or entirely of D , are unstable: each can be invaded by the other. An evolving population will come to consist of a mixture of $1/3$ pure H , and $2/3$ pure D . In other words, a population playing the game of Table 7.1 can evolve in one of two ways:

- (1) if individuals can adopt mixed strategies, the population will come to consist of mixed strategists, playing H and D with probabilities $1/3$ and $2/3$, respectively;
- (2) if only pure strategists are possible, the population will become genetically polymorphic, consisting of $1/3$ pure H and $2/3$ pure D .

The model can readily be extended to games in which more than two pure strategies are possible, or in which individuals engage in more than one interaction in a lifetime. If only two pure strategies are possible, there is always at least one ESS. If more than one ESS exists (as for the matrix in Table 7.2), the population will evolve to one or the other, depending on its initial state. If there is a mixed ESS, then a polymorphic population, containing the two pure strategists in the ESS proportions, is also stable.

I turn now to some extensions of the model.

Asymmetric Games

Suppose that there is some asymmetry in size, appearance, or role between the two partners. This asymmetry can influence the choice of behaviour. For example, let us modify the hawk-dove game of Table 7.1 by supposing that the contest is over some resource, and that every contest is between a prior occupant of that resource, and a recent arrival. For brevity, these will be called the 'owner' and the 'intruder', although it is important to appreciate that these terms do not imply that animals have a concept of ownership: all that is required is that the behaviour of an animal should change if it is left for some time in undisputed possession of some resource.

Given such an asymmetry, we can introduce a third strategy, B , or 'bourgeois': 'If owner, play H : if intruder, play D '. This is what would happen if the readiness of an animal to defend a resource increases sharply with the time for which it has held it.

Table 7.2

A two-strategy game with two ESSs

	<i>A</i>	<i>B</i>
<i>A</i>	4	2
<i>B</i>	1	3

B cannot invade *A* and *A* cannot invade *B*.

If we assume, as is plausible, that the genes that determine choice of strategy H , D , or B are independent of the circumstances that determine whether an individual is an owner or an intruder (that is, we assume that roles and strategies are independently determined), then each strategy type will be an owner in half the interactions, and an intruder in half. The payoff matrix is then given in Table 7.3.

The essential point in deriving this matrix is that, in a contest between two B s, if one is owner (H) then the other is intruder (D), so that an escalated fight never occurs. It is now easy to see that B is an ESS against both H and D , or any mixture of H and D . The original mixed ESS, 'Play H with probability $1/3$ and D with probability $2/3$ ', is no longer an ESS: it can be invaded by B .

Thus by introducing an asymmetry we have altered the evolutionary outcome. Note that B is an ESS even if ownership does not alter the outcome of an escalated fight, or the value of the resource.

What kinds of asymmetries will be used as cues to settle contests? Essentially any asymmetry that can influence the behaviour of the two contestants. Thus suppose that A is stronger than B , but that this difference cannot be perceived by the contestants. Then the strength difference might influence the outcome of an escalated fight, but cannot influence the choice of behaviour (H or D). If, however, the size difference can be perceived, perhaps after some initial display, then it is likely to determine behaviour. Figure 7.1 gives an example in which animals appear to adopt the bourgeois strategy.

In the game of Table 7.3, there is a role asymmetry between the contestants (owner and intruder), but no difference in the strategies available to them (H and D). In other pairwise interactions, differences in role are associated with

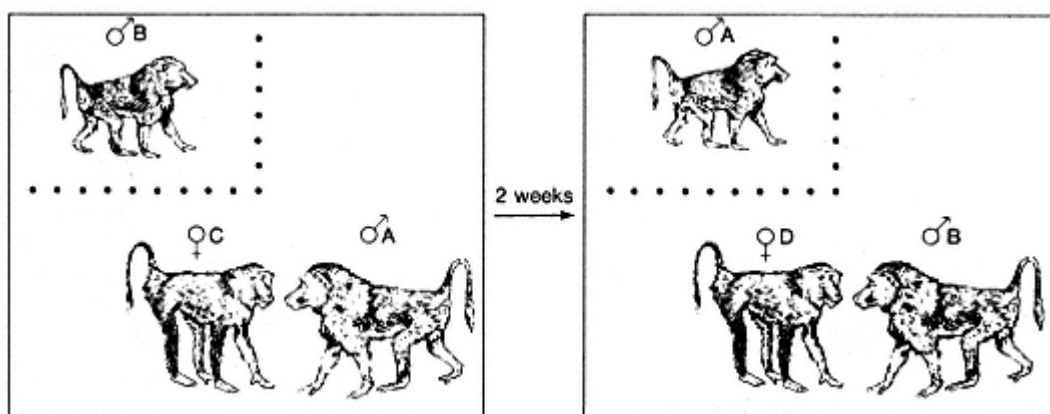

Figure 7.1

An experiment by Kummer *et al.* (1974). A male baboon, A, and a female, C, previously unknown to one another, were placed in an enclosure. A second male, B, was placed in a cage, from which he could observe the pair. Male A formed a bond with female C. When male B was released from the cage, he did not challenge male A for access to the female. Later, the same experiment was performed with a new female, D, and with the roles of the males reversed: this time, male A did not challenge male B.

Table 7.3

The asymmetric hawk-dove game

	<i>H</i>	<i>D</i>	<i>B</i>
<i>H</i>		2	0
<i>D</i>	0	1	1/2
<i>B</i>		1 1/2	1

differences in the set of possible strategies. This is so, for example, in interactions between male and female, or parent and offspring.

More than two Pure Strategies

If more than two pure strategies are possible, there may be no ESS: if so, the population will continue to evolve in a cyclical manner indefinitely. Box 7.2 gives an example of a game with no ESS. Figure 7.2 shows how the dynamics of a population containing three types, or strategies, can be represented graphically.

Surprisingly, an example of animals playing the rock-scissors-paper game has recently been described (Sinervo and Lively 1996). Male side-blotched lizards, *Uta stansburiana*, have one of three mating strategies. Orange-throated males establish large territories, within which live several females. A population of such males can be invaded by males with yellow throats: these 'sneakers' do not defend a territory, but steal copulations. The orange males cannot defend all their females.

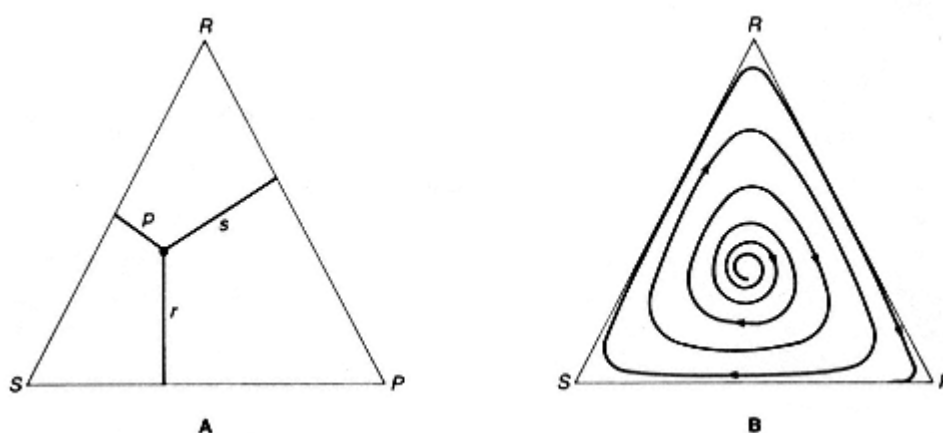

Figure 7.2

Suppose there are three possible strategies, *R*, *S*, and *P*, with frequencies *r*, *s*, and *p*. The state of the population can be represented as a point in an equilateral triangle, called the 'simplex', as shown in **A**.

This is because the sum of the perpendiculars from any point on to the sides is a constant, and therefore the condition $r + s + p = 1$ is satisfied. The dynamics of the population can be represented as a trajectory in the simplex. This is done for the rock-scissors-paper game of Table 7.4 in **B**.

**Box 7.2—
A Game With No ESS**

Consider the payoff matrix in Table 7.4. This corresponds to the children's game, 'rock-scissors-paper', with the additional assumption that both players pay a small sum, e , to the bank if there is a draw. Let M be the mixed strategy, 'play R , S , and P each with probability $1/3$ '. Then we can write down the following payoffs:

$$E(R,R) = -e, E(R,M) = -e/3,$$

$$E(M,R) = -e/3, E(M,M) = -e/3,$$

and M satisfies the conditions of Equation 7.3 against R , and also against S and P . In fact, M is an ESS. If, however, only pure strategies are permissible, the genetic polymorphism $1/3R, 1/3P, 1/3S$ is unstable, and the population cycles indefinitely. This illustrates the point that, with more than two pure strategies, the conditions for stability of the mixed strategy, and of the corresponding polymorphism, are not the same. It is also possible to find matrices for which the polymorphism is stable, but the corresponding mixed strategy is not.

Now consider the case when e is negative: that is, both players receive a small reward for a draw. Clearly, M is now not an ESS: it can be invaded by R , S , or P . In fact, the game has no ESS, pure or mixed.

Table 7.4

The rock-scissors-paper game

	R	S	P
R	-e	+1	-1
S	-1	-e	+1
P	+1	-1	-e

However, a population of yellow-striped males can be invaded by blue-throated males, which maintain territories large enough to hold one female, which they can defend against sneakers. Once sneakers become rare, it pays to defend a large territory with several females. Orange males invade, and we are back where we started. In the field, the frequencies of the three colour morphs cycled with a period of about 6 years.

Continuously Varying Strategies

Consider the following examples:

(a) The 'size game'. Size is genetically determined, and the fitness of an individual depends on its size relative to others in the population. This game may have no

ESS (Maynard Smith and Brown 1986). Although first conceived of as a model of male-male competition for mates, the model may be relevant in many other contexts. For example, consider the evolution of plant height: a tree needs to be tall to compete with its neighbours, but growth in height uses up time and resources.

(b) The sex ratio: that is, the proportion of male and female offspring produced by a parent. This problem is discussed in Box 13.1.

(c) Foraging in flocks: how much time should an individual spend searching for food and how much watching for predators? This problem is considered in Box 7.3.

(d) The 'war of attrition' game (Maynard Smith 1974): for how long should an individual continue to compete for some resource?

In each of these cases, the phenotype of an individual can be described by a single continuous variable, x . The problem consists of finding an evolutionarily stable value, or distribution of values, of x . The general method is described in Box 7.3.

Box 7.3—

The ESS When the Possible Strategies are continuously distributed.

Suppose that the phenotype of an individual is adequately represented by a single continuous variable, x : thus x might be the proportion of time a bird spends searching for food when it is foraging in a flock. Usually, x will be constrained to lie between certain limits, a and b : for example, the proportion of time spent searching must lie between 0 and 1. The fitness of an individual depends both on its own phenotype, and on the distribution of phenotypes in the population. We want to find the evolutionarily stable distribution. There are three possibilities:

1. There is some unique value, x^* , such that, if almost all individuals have the phenotype x^* , no mutant with $x \neq x^*$ can invade (there could be more than one unique ESS).
2. There is some distribution, $\phi^*(x)$, which is stable. That is, the proportion of the population lying between x and $x + \delta x$ is $\phi^*(x)\delta x$. Note that $\int_a^b \phi^*(x) dx = 1$.
3. There is no ESS.

Consider first the case of a unique ESS, x^* . Let the fitness of a rare mutant of phenotype x in an x^* population be $W(x, x^*)$. Then the condition for x^* to be an ESS is $W(x, x^*) < W(x^*, x^*)$, for all $x \neq x^*$. In words, this condition states that, in an x^* population, a mutant x is less fit than a typical x^* individual. Figure 7.3 shows the three ways in which this condition might be satisfied.

To find x^* in any particular case, we must first find an expression for $W(x, x^*)$. To illustrate the method, consider a very crude model of birds foraging in

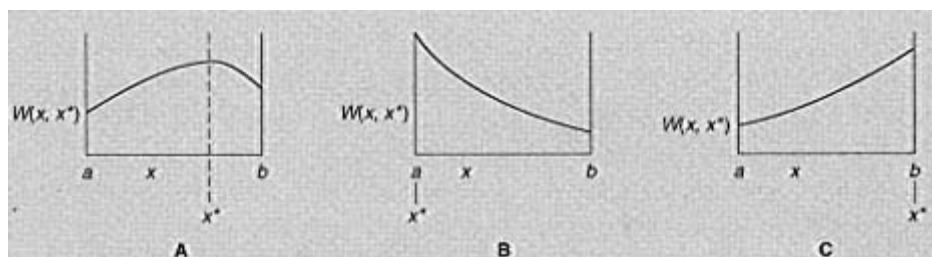

Figure 7.3 The ESS in a continuous game. $W(x, x^*)$ is the fitness of a mutant x , in a population of phenotype x^* . If x^* is an ESS, then $W(x, x^*)$ must be a maximum when $x = x^*$. The three possibilities are shown.

groups of two. Let x be the proportion of time spent searching. Consider a mutant, x , and a typical individual, x^* : the proportion of time during which both are searching, and hence neither is watching for predators, is xx^* . Hence kxx^* is the probability that one of them is killed by a predator, and $1 - kxx^*$ is the probability that the mutant (or the typical partner) survives. The food the mutant obtains if it does survive is given by Cx . Hence an estimate of its fitness is $Cx(1 - kxx^*)$. (This is intended to illustrate the method of finding an ESS, and not as a satisfactory model of foraging in groups.) Hence

$$W(x, x^*) = Cx(1 - kxx^*).$$

We first check whether $x^* = 0$ or $x^* = 1$ is an ESS (corresponding to Fig. 7.3B and C).

When $x^* = 0$, $W(x, x^*) = Cx$, and this is not a maximum when $x = 0$, so $x^* = 0$ is not an ESS.

When $x^* = 1$, $W(x, x^*) = Cx(1 - kx)$. Provided $k < 1/2$, this is a maximum when $x = 1$. Hence, for $k < 1/2$ (that is, predation risk not too high), the ESS is to search all the time

If $k > 1/2$, we seek an ESS intermediate between 0 and 1, corresponding to Fig. 7.3A. We require that $W(x, x^*)$ be a maximum when $x = x^*$: that is

$$dW(x, x^*)/dx = 0; d^2W(x, x^*)/dx^2 < 0; \quad (7.4)$$

where the differentials are evaluated at $x = x^*$.

Applying this to our example,

$$dW(x, x^*)/dx = C - 2Ckx,$$

and hence $C - 2Ck(x^*) = 0$, $x^* = 1/2k$. Further,

$$d^2W(x, x^*)/dx^2 = -2Ck,$$

which is negative, as is required for stability. Hence, for $k > 1/2$, the ESS is given by $x = 1/2k$.

Suppose that we find that there is no unique ESS. There is still the possibility that there is some distribution $\phi^*(x)$ that is stable. This is a continuous version of a mixed ESS. To find ϕ^* , we rely on the fact, discussed on p. 127, that the fitness of all components of a mixed ESS must be equal. The mathematical techniques for finding ϕ^* in any particular case, and for demonstrating its stability, are beyond the scope of this book. The 'war of attrition' game (Maynard Smith 1982) is an example of a game for which the ESS is such a distribution.

Will a Sexual Population Evolve to an ESS?

The ESS model assumes asexual reproduction, with like begetting like. Can the conclusions be extended to sexual diploids?

First, suppose that the ESS, pure or mixed, is a phenotype corresponding to a genetic homozygote. In this case, no difficulty arises: a population composed of such homozygotes would be evolutionarily stable. Any mutant, dominant or recessive, would be eliminated by selection.

A second possibility is that the ESS is a mixed strategy, but genetic homozygotes determine only pure strategies. Will the population evolve to a stable genetic polymorphism, with the different phenotypes occurring in the ESS frequencies? If the ESS contains only two pure strategies, as in the hawk-dove game, the answer is yes. Thus suppose that AA and Aa specify H and aa specifies D , and that the ESS is $1/3 H:2/3 D$, as before. When allele A is rare, AA and Aa will be fitter than aa , because $E(H,D) > E(D,D)$. Hence allele A will increase in frequency when rare. By a similar argument, a will increase when rare. There will be a stable polymorphism when the fitnesses of AA , Aa , and aa are equal. This occurs when the frequency of D is $2/3$, and hence the frequency of the allele a is $(2/3)^{1/2} = 0.816$. If the heterozygote, Aa , specifies some intermediate mixed strategy, it is still true that the population will evolve to a stable polymorphism with the phenotypes H and D in the ESS frequencies, although this is a little more difficult to prove.

Things are more complicated if the ESS includes more than two pure strategies, or if it is some distribution, $\phi(x)$, of a continuous variable. There is then no guarantee that a sexual population, in which genetic homozygotes specify pure strategies, will evolve to a polymorphic state corresponding to the ESS. One reason for this is that, if $\phi(x)$ is not a normal distribution, it is quite likely that there will be no distribution of gene frequencies that would produce the required phenotypic distribution.

It is therefore not a general truth that a sexual population will evolve to an ESS. The genetic system may be unable to generate the required phenotypic distribution, or, if there are more than two pure strategies in the ESS, the polymorphic

population may not be stable. However, there are two important cases in which the ESS distribution will be stable in a sexual population:

- (1) The ESS, pure or mixed, can be specified by a genetic homozygote;
- (2) A mixed ESS contains only two pure strategies, and the genetic system can produce a polymorphic population, with the phenotypes in the ESS proportions.

Further Reading

Maynard Smith, J. (1982). *Evolution and the theory of games*. Cambridge University Press.

Problems

Problems

1.

R	S	
R	4	2
S	1	3

 Individuals are of two types, R and S . They interact in random pairs with payoffs as shown. (a) What are the evolutionarily stable state(s) of the population? (b)* Suppose that R and S are determined by a pair of alleles at a locus, with aa specifying R and Aa and AA specifying S . The initial frequency of $A = 0.4$. What will be the final state of the population?

2.

R	S	
R	1	3
S	4	2

 Individuals of types R and S interact in random pairs, with payoffs as shown. Suppose that R and S are determined by a pair of alleles at a locus, with AA and Aa specifying R , and aa specifying S . What will be the stable frequency of allele a ?

3. What are the ESSs of the following matrix?

	A	B	C
A	1	6	2
B	5	2	2
C	2	2	3

- 4.* Two animals compete for an indivisible resource R . There is a cost-free assessment phase of the contest, after which an animal knows whether it is larger or smaller than its opponent. Individuals can then escalate or withdraw. If both escalate, the winner gains the resource R , and the loser pays a cost, C . The larger wins with probability P , where $P > 0.5$. (a) Can the strategy 'always escalate' be an ESS? (b) Can the strategy 'escalate if smaller, withdraw if larger' be an ESS? (c) Suppose that the loser is killed. How, in a real population, would you attempt to estimate C ? (Assume that, independent of its strategy, an animal has a 50 per cent chance of being the larger.)

5. Birds form winter flocks of two members that stay together through the winter. Individuals may watch for predators, or not watch. If at least one of the pair watches, both members survive the winter. If a bird is a member of a flock in which neither watches, there is a 50 per cent chance that it is killed. Non-watchers get more to eat, so, if they do survive, they raise five offspring next summer, whereas

watchers raise only four offspring. (a) What is the evolutionarily stable state? (b) Suppose flocks are of five birds. Provided that at least one watches, the flock is safe. If none watch, there is 50 per cent mortality. Is there a mixed ESS? What is the frequency of watchers at the ESS?

Computer Projects

1. The state of a population with three strategies A , B , and C , can be represented as a point in an equilateral triangle, or 'simplex' (see Fig. 7.2). The dynamics can then be represented by trajectories in the simplex. Write a program that accepts as inputs the nine entries in a 3×3 payoff matrix, and the initial frequencies of A , B , and C , and plot the dynamics. The program should enable you to plot as many trajectories as you like, with different initial conditions, for a given matrix. (Remember that fitnesses must be zero or positive, whereas the payoffs in the matrix are changes in fitness, and may be negative.)
2. Investigate the dynamics of the 'rock-scissors-paper' game described in Problem 4, for pure and mixed strategies, when there is a small positive payoff for a draw.
3. The 'size game'. Members of an asexual population grow to a size m (which can vary), and then reproduce. Their chance of surviving to size m is a decreasing function of m (for example, e^{-m}). The breeding success of an individual of size m is an increasing function of z (say $a + bz$), where z is the fraction of the population smaller than m . Assuming that m is genetically determined, with offspring identical to their parents, how will m evolve? (Assume that m has to take a series of discrete values say 1, 2, 3, 4, . . . In calculating z , take all those smaller, plus half those exactly the same size.) This is an example of a large class of 'games' in which the possible phenotypes are continuously distributed.

Chapter 8— Finite and Structured Populations

Inbreeding	<u>139</u>
Genetic drift	<u>143</u>
The rate of neutral molecular evolution	<u>146</u>
Mitochondrial DNA	<u>151</u>
Migration and differentiation between populations	<u>154</u>
The establishment of a new favourable mutation	<u>159</u>
Further reading	<u>160</u>
Problems	<u>160</u>
Computer projects	<u>160</u>

So far, I have assumed that gene frequency changes due to selection are large compared to those due to chance. This is justified only if the population is large, the alleles being considered are not very rare, and selection is not very weak. Even in a large population, the assumption of random mating will be misleading if dispersal is limited, so that individuals mate with neighbours that may be related to them, or if the population is divided into local, partially isolated breeding groups, **demes**. These complications are analysed in this chapter. Except in the last section, it will be assumed that frequency changes due to selection are small compared to those due to chance; this is equivalent to assuming that the alleles are selectively neutral. Before starting on this chapter, you should re-read pp. 24-7.

Inbreeding

By inbreeding is meant the mating together of close relatives. The most intense form of inbreeding is self-fertilization in an hermaphrodite. Figure 8.1 shows a population, starting from a single heterozygote, in which all offspring are produced by selfing. The proportion of heterozygotes is halved in each generation:

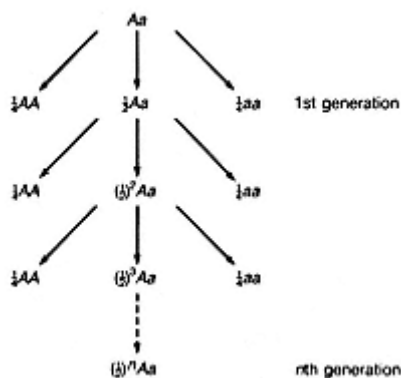

Figure 8.1
Selfing. The frequency of heterozygotes is halved in each generation.

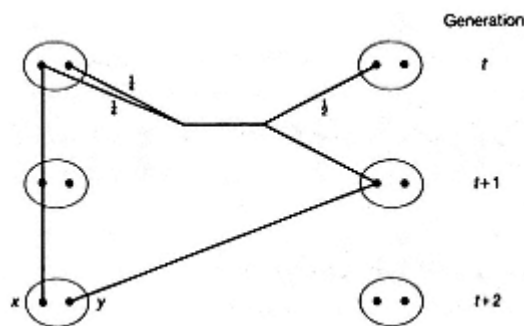

Figure 8.2
Brother-sister mating.

after three generations of selfing, it is $(1/2)^3 = 1/8$. In the absence of selection and mutation, the proportion will be $(1/2)^{10} \cong 1/1000$ after 10 generations, and approximately one in a million after 20 generations.

In a **dioecious** species (i.e. a species with separate sexes), the closest form of inbreeding is the repeated mating of brother and sister (Fig. 8.2). This too, in the absence of selection and mutation, must ultimately lead to genetic homozygosity, but it is harder to calculate the rate at which this happens.

Let G_t = probability that, in generation t , an individual is homozygous at a locus; $H_t = 1 - G_t$ = probability that an individual is heterozygous, and R_t = probability that two genes drawn randomly, one from each of two individuals, are identical.

Then
$$G_{t+1} = R_t \tag{8.1}$$

because the two genes in an individual in generation $t + 1$ were drawn randomly from the two individuals in the previous generation.

Now consider the two alleles, x and y , in an individual in generation $t + 2$. The probability that they are identical is, by definition, G_{t+2} . Where did x and y come from?

With probability $1/2$, they came from different grandparents in generation t ; if so, they are identical with probability R_t .

With probability $1/4$, they are copies of different genes in the same grandparent; if so, they are identical with probability G_t .

With probability $1/4$, they are copies of the same gene in the same grandparent; if so, they are certainly identical.

Putting these facts together, we have

$$G_{t+2} = R_t/2 + G_t/4 + 1/4,$$

or, using the fact that $R_t = G_{t+1}$,

$$G_{t+2} = G_{t+1}/2 + G_t/4 + 1/4. \tag{8.2}$$

This is a 'finite difference equation' for G_t . Clearly, if we know the values of G_t in two successive generations, we can calculate G_t in the next generation, and in the

next, and so on. In fact, the equation is also analytically soluble: that is, if we know G_0 and G_1 , we can find an expression for G_t without having to calculate all the intermediate values. The important conclusion is that, after the first few generations, the probability H_t that an individual is heterozygous is reduced by a factor of 0.808 in each generation.

The earliest evidence that brother-sister mated lines become genetically homozygous was the finding that they do not respond to artificial selection. The prediction has also been confirmed by showing that inbred lines are homozygous for electrophoretic markers, and, in vertebrates, by the fact that skin grafts are accepted between members of a line. It is important, however, to remember that the prediction assumes no selection, or at least very weak selection. Brother-sister mated lines of *Drosophila subobscura* usually remain heterozygous for inversions: one line was still segregating for inversions on three separate autosomes after 100 generations of brother-sister mating, indicating strong selection against structural homozygotes. This species may be unusual, because of the prevalence of inversions in natural populations, but it does show that one must be careful about the assumption of no selection.

The effects of inbreeding on fertility and viability were discussed in Chapter 6, and the evolution of inbreeding in nature is discussed in Chapter 13.

I now use this example to define some terms that are widely used in the study of finite populations. Consider an individual in generation t of a brother-sister mated line. There are two reasons why such an individual might be homozygous:

1. The two genes at a locus may be copies of the same gene in an earlier member of the line, during the last t generations: if so, they are said to be **identical by descent**, or IBD for short.
2. They may be alike because the allele A was common in the population from which the line was derived, and two or more A alleles were present in the founders of the line. If so, the genes are identical, but not identical by descent.

To give a second example, a man may have the O blood group (genetically, O/O) because O is a common allele, or because his parents were cousins, and his two O genes are copies of a single O gene present in a great-grandparent. Only in the latter case would we say that the genes are IBD.

It will be apparent that there is something arbitrary about the definition of identity by descent. Even in a large random-mating population, two genes may be identical because they are copies of an ancestral gene in the distant past; indeed, identity always indicates common ancestry. In using the idea, therefore, we select some past generation, and say that only descent from a common ancestor as, or more, recent than that will count as identity by descent. In analysing an inbred line, we would choose the foundation of the line as the critical point, because we are interested in how much more homozygous is a member of the line than a member

of the outbred population from which it was derived. In the case of cousin marriage, we choose three generations back, because we are interested in how much more likely is a child of a cousin marriage to be homozygous than a random member of an outbred population.

Given the concept of identity by descent, we can define two important coefficients:

The **coefficient of kinship**, F_{JK} , is the probability that two homologous genes, drawn randomly from two individuals J and K , are IBD.

The **coefficient of inbreeding**, F_I , is the probability that the two alleles at a locus in individual I are IBD.

If J and K are the parents of I ,

$$F_I = F_{JK}. \quad (8.3)$$

These coefficients should be compared to the coefficient of relatedness, defined in Box 9.1. Box 8.1 shows how values of F can be calculated.

Suppose that in a large population there are two alleles A and a , at a locus, and that the frequency of A is p . Some matings are between relatives, and the average coefficient of inbreeding is F . If the two alleles in an individual are IBD, then the individual is AA with probability p , and aa with probability $1 - p = q$. Hence the genotype frequencies in the population are

$$\begin{aligned} P_{AA} &= pF + p^2(1 - F) \\ P_{Aa} &= 2pq(1 - F) \\ P_{aa} &= qF + q^2(1 - F), \end{aligned} \quad (8.4)$$

Thus one interpretation of F is that it is the proportion by which heterozygosity

Box 8.1—

How to Calculate the Coefficient of Kinship

In Fig. 8.3A, genes x and y are drawn at random from two half-sibs. The probability that x came from the mother is $1/2$; so is the probability that y came from the mother. If both came from the mother, the probability that they are copies of the same gene is $1/2$. Since x and y can only be IBD if they are copies of the same gene in the mother, $F = \frac{1}{2} \times \frac{1}{2} \times \frac{1}{2} = 1/8$.

Figure 8.3B shows full sibs. Genes x and y have a probability of $1/8$ of both coming from mother and being IBD; they also have a probability $1/8$ of being IBD through the father. Since these possibilities are mutually exclusive, $F = 1/8 + 1/8 = 1/4$.

More generally, the coefficient of kinship between two individuals, J and K , is

$$F_{JK} = \sum \left(\frac{1}{2} \right)^{n+1}.$$

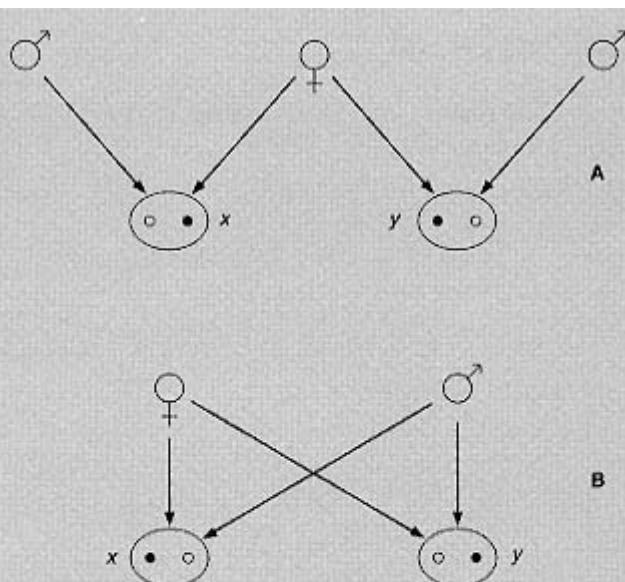

Figure 8.3 Half-sibs and full sibs.

where n is the number of steps in a path from J to a common ancestor and back to K , and the summation is over all such paths. This formula assumes that the common ancestors are not inbred, and are unrelated.

As an exercise, use this formula to check that F for first cousins is $1/16$.

is decreased, relative to that in a random mating population with the same gene frequency.

Genetic Drift

How rapidly will heterozygosity be lost from a population of size N ? One method of solution, similar to the method used to analyse brother-sister mating, is given in Box 8.2. The conclusion is that, provided N is not too small, heterozygosity declines by a factor of $(1 - 1/2N)$ in each generation. Other provisos are that the sex ratio should be 1:1, that only fertile adults should be counted, and that there should be no mutation or selection.

I want now to obtain the same result by a simpler method (see Fig. 8.5). Let F_t be the coefficient of kinship between any two individuals in generation t : that is, it is the probability that genes x and y are IBD. Let P be the probability that x and y are copies of the same gene in generation $t - 1$. We then define the **effective**

**Box 8.2—
Genetic Drift**

If G_t is the probability that an individual in generation t is homozygous, then (Fig. 8.4), by a method exactly analogous to that used to derive Equation 8.2 for brother–sister mating:

$$G_{t+2} = \frac{N-1}{N} G_{t+1} + \frac{1}{2N} G_t + \frac{1}{2N}, \quad (8.5)$$

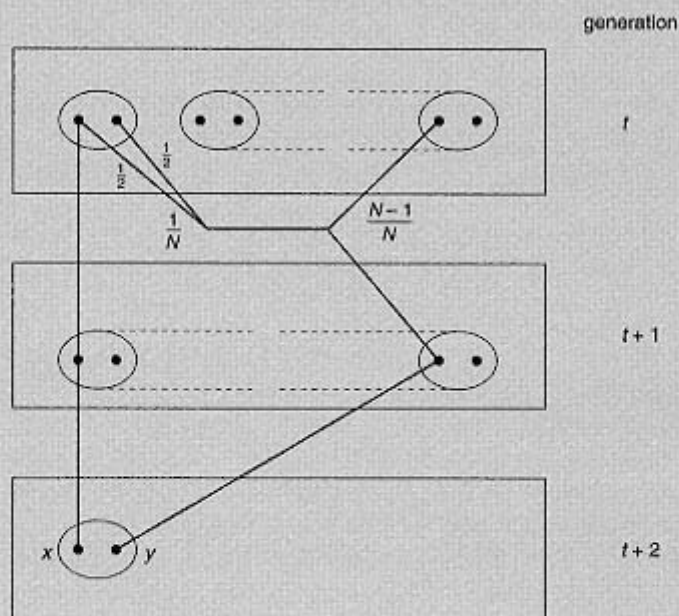

Figure 8.4 Drift in a population of size N . In the absence of selfing, genes x and y certainly come from different individuals in generation $t + 1$. They come from different individuals in generation t with probability $(N - 1)/N$. If they come from the same individual (probability $1/N$), they have a probability of $1/2$ of being copies of the same gene.

where N is the population size. This assumes that gene y is equally likely to have come from any individual in generation t , independently of where gene x came from. This, in turn, requires that the sex ratio be 1:1, that only fertile adults are counted in N , that family size has a Poisson distribution, and that there is no bar to brother–sister mating (if there were such a bar, gene y could not come from the same individual as gene x).

Equation 8.5 is analytically soluble. It predicts that, when t is not small, $1 - G_t$ is reduced by a factor of λ in each generation, where

$$\begin{aligned} \lambda &= 1 - 1/2N + 1/4N^2 - \dots \\ &\approx 1 - 1/2N. \end{aligned}$$

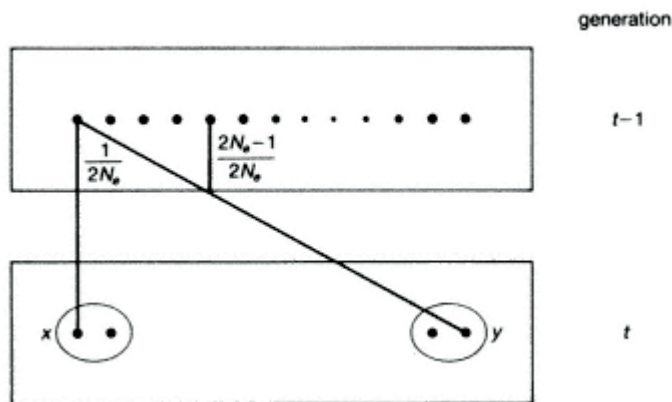

Figure 8.5
The 'gene-pool' approach to drift.

population size, N_e , as that size which makes $P = 1/2N_e$: that is, the effective population consists of a 'pool' of $2N_e$ genes, each equally likely to be transmitted. Then

$$F_t = 1/2N_e + (1 - 1/2N_e)F_{t-1}. \tag{8.6}$$

Since the coefficient of inbreeding in one generation equals the coefficient of kinship in the preceding one, this same equation will hold if we interpret F as the coefficient of inbreeding. Then, if we write $1 - F_t = Het_t$, the probability of being heterozygous,

$$Het_t = (1 - 1/2N_e)Het_{t-1}.$$

That is, the predicted rate of loss of heterozygosity is exactly as it was for the more explicit model of Fig. 8.4. This can be taken as a justification of the **gene pool** approach, and of the concept of an effective population size: remember that N_e is the same as the actual population size if all members are equally likely to produce offspring.

A difficulty arises if the numbers of males and females are unequal. Thus suppose that a population consists of M breeding males and F breeding females. We imagine a pool of genes, half derived from males and half from females. If two genes are drawn at random from this pool, it is easy to show that the probability that they are identical is $P = (1/M + 1/F)/8$. However, we defined the effective population size, N_e , as that size which made $P = 1/2N_e$. Therefore, N_e can be calculated from the equation

$$\frac{1}{N_e} = \frac{1}{4} \left(\frac{1}{M} + \frac{1}{F} \right).$$

Note that, when $M = F$, $N_e = M + F$, as expected.

So far, I have ignored mutation. Suppose now that in each generation there is a

mutation rate. I also suppose that new alleles that arise by mutation are different from any allele previously existing in the population: this 'infinite alleles' assumption turns out to be a reasonable approximation. We can then modify Equation 8.6 to

$$F_t = (1 - \mu)^2 [1/2N_e + (1 - 1/2N_e)F_{t-1}]. \quad (8.7)$$

Thus $(1 - \mu)^2$ is the probability that neither of the two genes whose identity is being measured have mutated.

In time, an equilibrium will be reached between the addition of new mutations, and their loss by drift. That is, $F_{t+1} = F_t = \hat{F}$. Then, since μ is small, Equation 8.7 becomes

$$\hat{F} = (1 - 2\mu)[1/2N_e + (1 - 1/2N_e)\hat{F}].$$

or
$$\hat{F} = \frac{1}{1 + 4N_e\mu}. \quad (8.8)$$

This gives the proportion of homozygotes at a locus, at equilibrium between mutation and drift. If $N_e \gg 1$, there will be few homozygotes; if $N_e \ll 1$, most individuals will be homozygous.

At first sight, this formula seems to offer a way of testing the idea that most electrophoretic variants found in natural populations are selectively neutral. Thus F can be measured, and N_e can be roughly estimated, so that the 'neutral mutation rate', can be calculated, and comparisons made between species, and between the values of μ calculated from Equation 8.8 with the independent estimates derived from observed rates of evolution (see p. 148). Unhappily, there is a reason why this cannot usefully be done. The time it takes a population to approach the equilibrium given by Equation 8.8 is of the order of N_e generations. Thus it would take the human population between 10^9 and 10^{11} years to reach the equilibrium appropriate to its present size. The actual level of heterozygosity in our species depends far more on population numbers during the Pleistocene, which were probably small, than on our present numbers. Unfortunately, we cannot estimate past numbers. The best we can do with Equation 8.8 is to note that, if we find a species, such as the cheetah, with an unusually low level of genetic variability, this indicates a recent and dramatic bottleneck in numbers.

The Rate of Neutral Molecular Evolution.

When amino-acid sequences of proteins were first published, it was suggested by Kimura (1968) and by King and Jukes (1969) that many of the observed changes had occurred because they were selectively neutral, and, by extension, that much of the isozyme variation being discovered was also selectively neutral. If there are selectively neutral mutations, a very simple and general result holds for the rate at which they will be incorporated in evolution (Fig. 8.6). First, we must distinguish

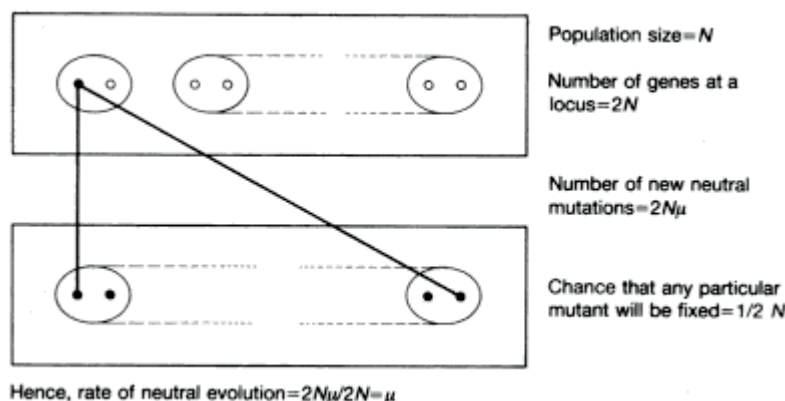

Figure 8.6
The rate of neutral evolution.

sharply between mutation, and evolutionary substitution. We will say that **substitution** has occurred if copies of a new mutation, with or without further mutational change, come to be the only genes present at that locus in the population: we will also say that the new mutation has been **fixed**.

In a diploid population of N individuals, there are $2N$ genes at each locus. In each generation, there will be $2N$ new selectively neutral mutations at the locus, where μ is the per generation neutral mutation rate. Consider the $2N$ genes present in any generation: it must be the case that, at some time in the future, all the genes in the population will be copies of one of these $2N$ genes. The chance that a particular neutral mutation will be the one that is ultimately fixed is $1/2N$: it has exactly the same chance as all the other $2N - 1$ genes, because that is what the word 'neutral' means. Hence in each generation the number of new neutral mutations that occur, and that are fixed, is $2N \cdot 1/2N = \mu$. In other words, the rate of evolution is equal to the mutation rate. The great beauty of this result is that, unlike Equation 8.8, it is independent of the population size, past or present.

Let us dissect the term 'neutral mutation rate'. Consider a gene coding for a protein of length L amino acids, and let the probability of a mutation per amino acid per generation be u . The total rate of mutation is then uL per generation. Many of these will be deleterious, and an occasional one may be beneficial. Let f be the fraction that are neutral, in the sense, given above, that selective effects on gene frequency are small compared to the effects of drift. The neutral mutation rate is then

$$\mu = uLf. \quad (8.9)$$

Is the prediction of a uniform rate of evolution borne out? We cannot compare the amino acid (or nucleotide) sequence of a living organism with that of an ancestor. The best we can do is to compare two contemporary sequences. It is usual to count only point mutations, and to ignore the much rarer additions and de-

letions of amino acids. Suppose that we observe n substitutions in a protein of length L amino acids: that is, a proportion $P = n/L$ of the amino acids have changed. If, from fossil evidence, we can estimate that the latest common ancestor of our two organisms existed T years ago, we can say that a proportion P of sites differ after T years of evolution. We want to convert this into a rate k , where k is the probability of a substitution per site, per year. If we simply wrote $k = P/2T$, this would be an underestimate, because we would miss cases in which two or more substitutions have occurred at the same site: for example, if a leucine in the common ancestor had changed to valine in one descendant and to isoleucine in the other, we would count this as one change, and not as two.

We therefore proceed as follows. If k is the probability of a change at a site per year, then $1 - k$ is the probability of no change in a year, and $(1 - k)^{2T}$ the probability of no change in the whole period of $2T$ years. Since k is small and T large, $(1 - k)^{2T} \cong e^{-2kT}$. Hence

$$\begin{aligned} P &= 1 - e^{-2kT} \\ \text{or} \quad k &= -\ln(1 - P)/2T, \end{aligned} \quad (8.10)$$

where P is the proportion of sites substituted, and T the time to a common ancestor.

Table 8.1 gives estimates of evolution rates for a number of proteins. They are strikingly different. The main reason is that different kinds of proteins are subject to different selective constraints. For example, fibrinopeptides are short, terminal regions of the protein fibrinogen that are cleaved off before the remainder of the protein forms a clot: it seems unlikely that their exact sequence is important.

Table 8.1

Rate of amino acid replacement in different proteins.
Rates are the mean number of replacements per site per 10^9 years

Protein	Rate
Fibrinopeptides	8.3
Insulin C	2.4
Ribonuclease	2.1
Lysozyme	2.0
Haemoglobins	1.0
Myoglobin	0.9
Insulin A and B	0.4
Cytochrome C	0.3
Histone H4	0.01

Insulin C is a region of the proinsulin molecule that is discarded, whereas regions A and B form the active molecule. The data in the table are consistent with the view that the different rates reflect the fact that, in slowly evolving proteins, a larger proportion of the mutations that occur are disadvantageous. This conclusion is supported by the fact that those substitutions that do occur are in less critical regions of the protein: for example, they are more often on the surface of the protein, because changes in amino acids in the centre of the molecule would be more likely to affect its stability. However, it is not clear whether the substitutions were neutral (so that faster evolution is caused by a higher value of α in Equation 8.9) or selectively advantageous. What is clear is that few mutations were either neutral or advantageous in histone H4, and that many were in fibrinopeptide and insulin C.

Stronger support for the neutral theory comes from data on nucleotide sequences of DNA. There are certain kinds of change which we would expect usually to be neutral. They are

1. **Synonymous** changes in the third sites of codons: that is, changes that do not alter the amino acid coded for. Approximately 2/3 of the changes that occur at third sites are synonymous.
2. **Introns**: that is, non-coding regions of genes that are spliced out from the mRNA (see p. 203).
3. **Pseudogenes**: that is, duplicated genes that no longer code for proteins (see p. 204).

The neutral theory predicts that these sequences should evolve more rapidly than any other, because α in Equation 8.9 is close to unity, and that they should all evolve at about the same rate. These predictions are borne out: the rate is, very approximately, 3×10^{-9} per year. This agrees rather well (remembering that an amino acid is coded for by three bases) with the rate of evolution of fibrinopeptide (Table 8.1). There is, of course, a danger of arguing in a circle here: one of the reasons we think that the sequences of introns are unimportant is that they evolve rapidly. However, the data on introns, third sites, and pseudogenes are close to what the neutral theory predicts, and one cannot ask more than that.

What of the prediction that the rate should be constant for a given class of protein? The best data are for some proteins in eutherian mammals. It is thought that the various orders diverged late in the Mesozoic, some 80 million years ago, and that the phylogeny is well represented by Fig. 8.7. This does not imply that the splitting of the various lineages was simultaneous, but only that the period of branching was brief compared to the subsequent period of divergence. If so, we can use contemporary sequences to estimate the mean rates of divergence, and, more important, the variance of these rates. This is done in Table 8.2. If the neutral theory is true, we expect the number of substitutions in different lineages, for a given protein, to have a Poisson distribution: that is, the mean and variance should

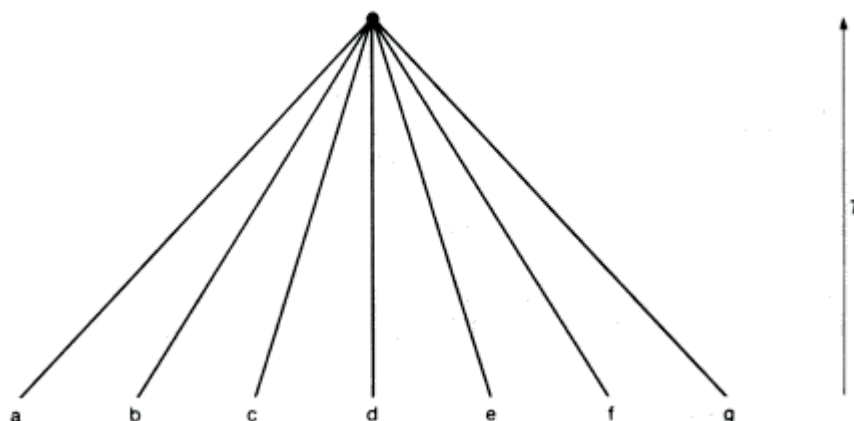

Figure 8.7
An approximate phylogeny of the orders of eutherian mammals.

be equal, so that the expected value of $R = S^2/M$ is unity. Of the five comparisons, all are greater than one, and two are significantly so.

The interpretation of Table 8.2 is controversial. Kimura sees it as evidence that evolution rates, if not exactly constant, are more nearly so than one would expect on a selective hypothesis. Gillespie thinks that the observed differences in rate call for a selective explanation, and suggests that there have been intermittent bursts of evolutionary change.

An important question is whether the amount of change occurring in a lineage depends on absolute time, or on the number of generations that have elapsed. The theoretical prediction is that the evolution rate should depend on the mutation rate. Now the mutation rate is more nearly constant per generation than per year. This is because mutations occur mainly when DNA is replicated, and the number of cell divisions per generation is not much greater in long-lived animals like ourselves than it is in a mouse or rat. Hence, on the neutral theory, we would expect the amount of change per million years to be less in long-lived animals. Until recently, the consensus has been that this is not so, and that the rate is uniform per year, and not per generation. If so, this presents the neutral theory with a serious difficulty. However, Li *et al.* (1987) suggested that DNA sequence changes in rodents have been 4-8 times faster than in higher primates, and 2-4 times faster than in artiodactyls, and that rates have been slower in apes and humans than in monkeys. This is in accord with the neutral theory, at least as far as the largely silent changes in DNA sequence are concerned.

Finally, whether or not the neutral theory is true, at least some changes in proteins are adaptive. For example, the llama is a relative of the camel that lives at high altitudes: its haemoglobin (a protein often quoted in support of the neutral theory) differs from that of the camel by a single mutation, which confers on it a greater affinity for oxygen. The barred goose, which migrates over the Himalayas

Table 8.2

Rate of amino-acid sequence divergence in mammals (from Gillespie 1984, based on data from Kimura 1983)

Protein	Number of species	Mean substitutions per lineage M	Variance of substitution number S^2	$R = S^2M$
Haemoglobin α	6	13.15	18.30	1.39
Haemoglobin β	6	15.61	54.19	3.47*
Myoglobin	6	12.77	23.83	1.87
Cytochrome C	4	8.55	30.92	3.62*
Ribonuclease	4	21.99	62.68	2.85

*Values significantly greater than one.

at an altitude of 9000 m, has a haemoglobin that differs from that of the greylag goose in a similar way. In the deer mouse, *Peromyscus maniculatus*, the haemoglobin is polymorphic: one morph has a higher oxygen affinity, and is commoner at high altitudes. Mice from high altitudes can exercise for longer at low oxygen tensions, and mice from low altitudes can exercise for longer at high oxygen tensions (Perutz 1983).

Mitochondrial DNA

The mtDNA of higher animals is a circular molecule of some 16 000 bases, coding for 13 mRNAs, 22 tRNAs and 2 rRNAs. It contains no repetitive DNA, spacers, or introns. To a population geneticist, its most interesting characteristic is that it is maternally inherited. Usually, all the copies in an individual are identical (that is, individuals are **homoplasmic**), but populations may be highly polymorphic. This suggests that, at some point in the germ-line, the effective number of copies must be small: otherwise, sequence diversity would build up within individuals.

The complete sequence is known for human, mouse, and bovine mtDNA, and shorter sequences are known for several other species, particularly primates. Population studies, however, depend mainly on **restriction mapping**, in which the presence and distribution of particular 4- and 6-base sequences are mapped, using endonucleases which cut DNA at those specific sequences.

The rate of base substitution is much higher than in nuclear DNA (Fig. 8.8). An estimate of the initial rate of sequence divergence is 20×10^{-9} per site per year, or some 10 times faster than the highest rates in nuclear DNA. This probably reflects a higher mutation rate. However, as the figure shows, the rate soon flattens out. This is because many bases are conserved: in mammals, about 2/3 of the bases coding for tRNA are conserved, as are 2/3 of the bases at the first two sites of

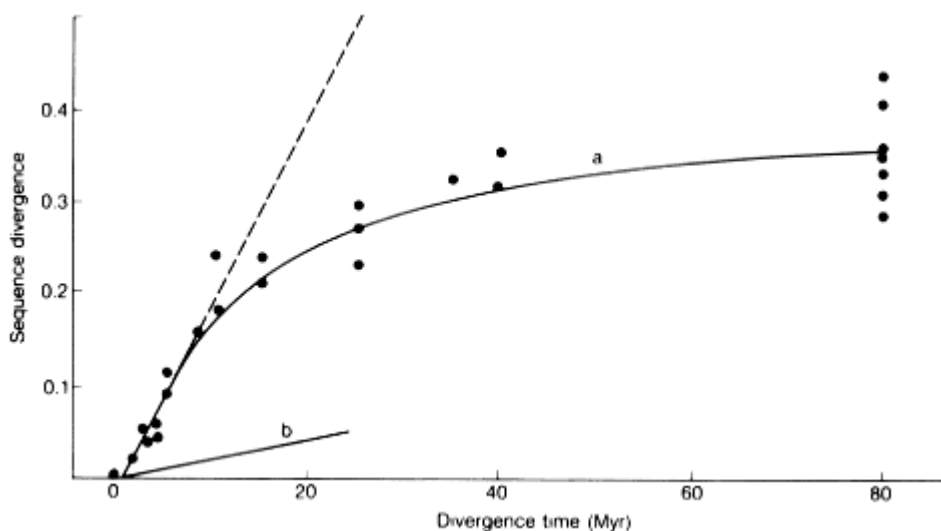

Figure 8.8
The rate of nucleotide substitution in (a) mtDNA and (b) single-copy nuclear DNA
(after Brown *et al.* 1979).

codons in protein-coding regions. The high rate of substitution makes mtDNA particularly valuable in studying relationships in recently diverged lineages.

Transitions ($A \rightleftharpoons G$, $T \rightleftharpoons C$) are much commoner than transversions ($A, G \rightleftharpoons T, C$). This complicates the analysis of mtDNA data: those interested in the details should consult Hasegawa *et al.* (1985).

The existence of a large DNA molecule inherited, without crossing over, in the female line provides various kinds of unique information. The first concerns geographical structuring. Figure 8.9 shows a phylogeny of the deer mouse, *Peromyscus maniculatus*, deduced from mtDNA restriction maps, and superimposed on the geographical sources of the collections. The essential point is that phylogenetically related populations are geographic neighbours. This implies that new *Peromyscus* populations were derived from ancestral populations in the same region, and that mtDNA does preserve information about ancestry. In contrast, there are no significant differences in allozyme frequency between the major populations recognized from mtDNA.

It is worth asking why it is that mtDNA is more informative in this context than nuclear DNA. The essential factor is that mtDNA does not recombine. Figure 8.10 shows an imaginary historical scenario, in which mtDNA would reveal ancestry, whereas nuclear DNA would not.

There are two interesting cases in which mtDNA has failed to reveal much geographical differentiation. The first is that of the American eel, *Anguilla rostrata*. There is no observable differentiation between populations in streams entering 4000 km of the Atlantic coast of North America. The explanation is that

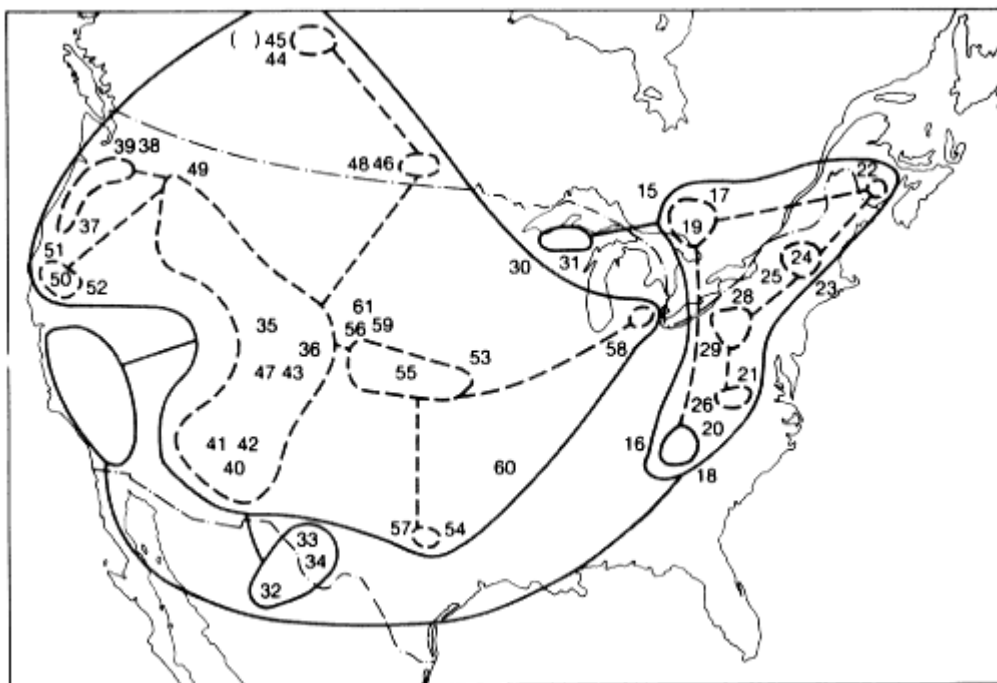

Figure 8.9

The mtDNA phylogeny of the deer mouse, *Peromyscus maniculatus*, superimposed on the geographical sources of the collections (simplified, from Avise 1986).

the adults leave fresh water, and breed in the tropical mid-Atlantic, from whence the larvae are transported by ocean currents back to the coastal streams. Effectively, therefore, *A. rostrata* consists of a single panmictic population.

Our own species affords a second example. Restriction maps of human mtDNA reveal rather little sign of geographical structuring. This suggests that existing human races migrated from a common centre in the relatively recent past: if we accept a divergence rate of 20×10^{-6} per site per year, then the mean time of divergence of human races is of the order of 50 000 years.

mtDNA data may also help to estimate population size in the past. Consider a population in which the effective number of females is N_e . Their mitochondria are derived from their mothers, and from their mothers' mothers, and so on. How far must we go back into the past to reach a single female whose mitochondria are ancestral to all those in the present population? The answer (Box 2.4) is, approximately, $2N_e$ generations. If we compare mtDNA from existing humans, and accept a divergence rate of 20×10^{-6} per site per year, we can conclude that the single common ancestor in the female line existed some 200-400 000 years ago, or 10-20 000 generations.

It is important to understand that the claim that all existing human mito-

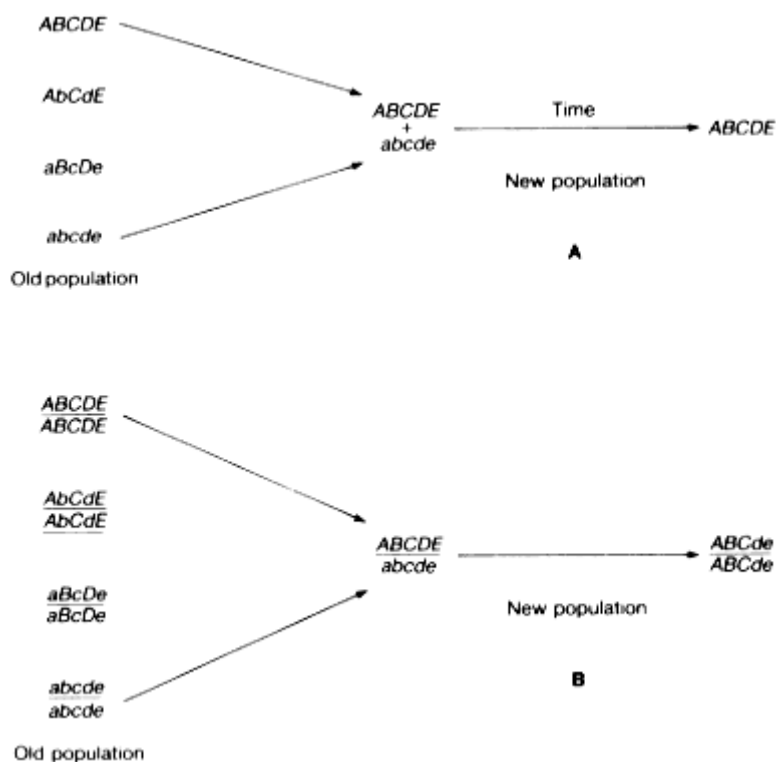

Figure 8.10

Reconstructing phylogeny from (A) mitochondrial and (B) nuclear DNA.

In each case, there are four old, genetically differentiated populations.

A new population is established by immigrants from two of these.

By drift or selection, this population becomes genetically uniform.

The phylogeny can be partially reconstructed in case (A), but not in case (B).

chondria are probably derived from a single female living less than half a million years ago does not imply that our ancestral lineage was ever reduced to a single pair, or that only one female at that date has contributed to our nuclear genome. Indeed, it is quite consistent with the view that the effective number of females never fell below 5-10 000, and that most of those females have contributed nuclear genes to the present population (see Fig. 8.11).

Migration and Differentiation between Populations

The concept of a random mating population is an abstraction. In real populations, individuals are more likely to mate with neighbours. Figure 8.12 shows three possible models in which this is taken into account. They are:

A Wright's island model. The population is divided into partially isolated demes. A small fraction of the individuals breeding in a deme have migrated in

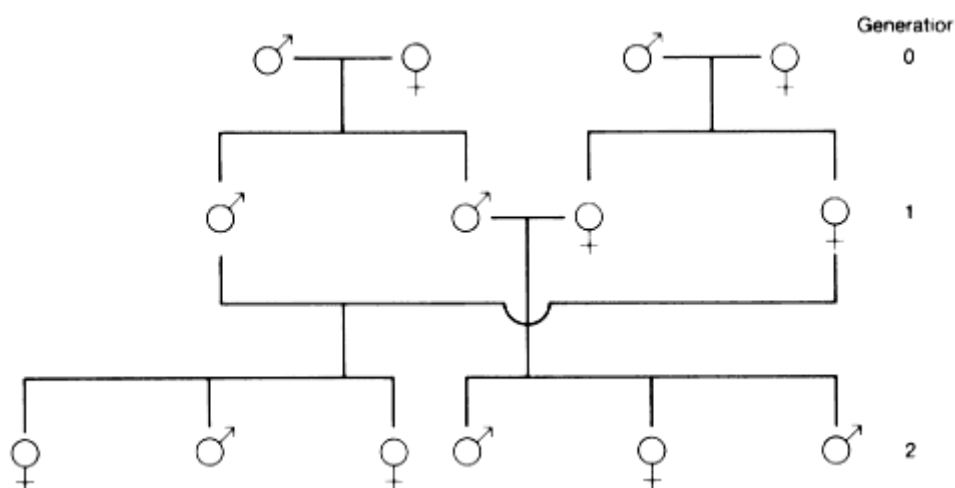

Figure 8.11

A simple pedigree in which all the individuals in generation 2 trace back, in the female line, to a single female in generation 0, yet all four parents in generation 0 have contributed nuclear genes to all the individuals in generation 2.

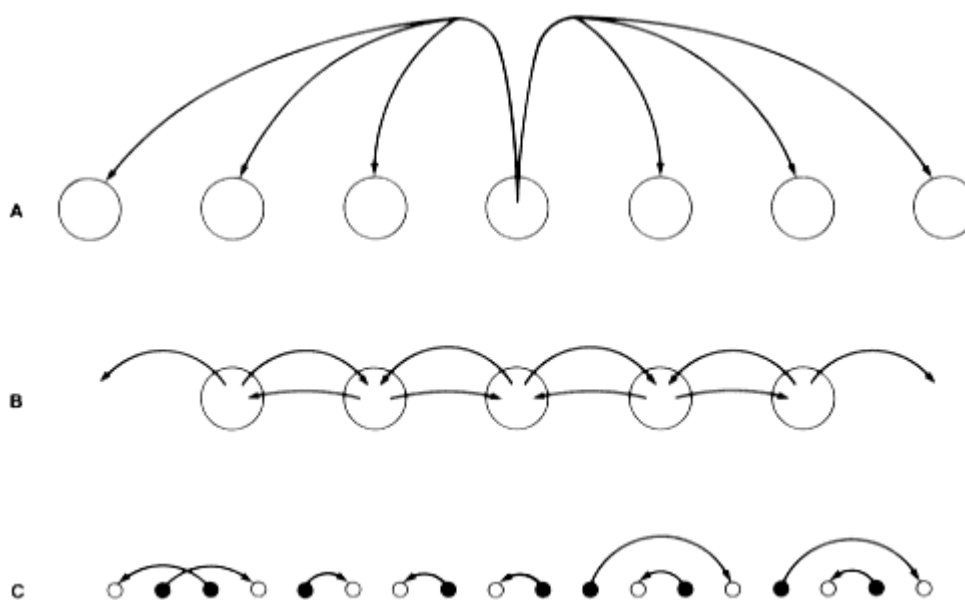

Figure 8.12

Models of migration. **A** the island model; **B** the stepping-stone model; **C** the continuous model. In **A**, migrants from one deme only are shown. In **C**, only males (♂) are shown migrating, but this is not essential to the model.

from another deme. When an individual does migrate, it is equally likely to move to any other deme.

B The stepping-stone model. This is identical to the island model, except that a migrant always moves to the next deme in line.

C The continuous model. There are no demes, but dispersal distances are short, so that mates were born close to one another. Either one or both sexes can migrate.

The second and third models assume a one-dimensional habitat (for example a stream or a shore line) but it is easy to see how they could be extended to two dimensions. I shall only analyse the first model. Although the least realistic, it is the most tractable mathematically. What we want to know is this: how different genetically are different demes? Alternatively, how much migration must there be before demes come to resemble one another? Nei (1975) introduced a measure that compares the variability within a deme with the variability between demes:

$$G_{ST} = \frac{H_T - \hat{H}_S}{H_T}, \quad (8.11)$$

where H_T = the probability that two homologous genes from different demes are identical, and \hat{H}_S = the probability that two homologous genes from the same deme are identical.

Box 8.3—

Drift in a Structured Population

Let G_{St} = probability, in generation t , that two genes drawn at random from the same deme are identical;

G_{Dt} = probability, in generation t , that two genes drawn at random from different demes are identical;

n = number of demes;

N_e = effective population size of a deme;

a = probability that two parents breeding in the same deme were born in the same deme;

b = probability that two parents breeding in different demes were born in the same deme.

In Fig. 8.13, individuals are represented at the moment of conception, as new zygotes. Consider genes x and y . The probability that they are identical is, by definition, G_{St} . With probability a , genes x and y are copies of genes in the same deme in generation $t - 1$: if so, they have a probability $1/2N_e$ of being copies of the same gene. Hence, ignoring mutation,

$$G_{St} = a \left[\frac{1}{2N_e} + \frac{2N_e - 1}{2N_e} \cdot G_{St-1} \right] + (1 - a)G_{Dt-1}.$$

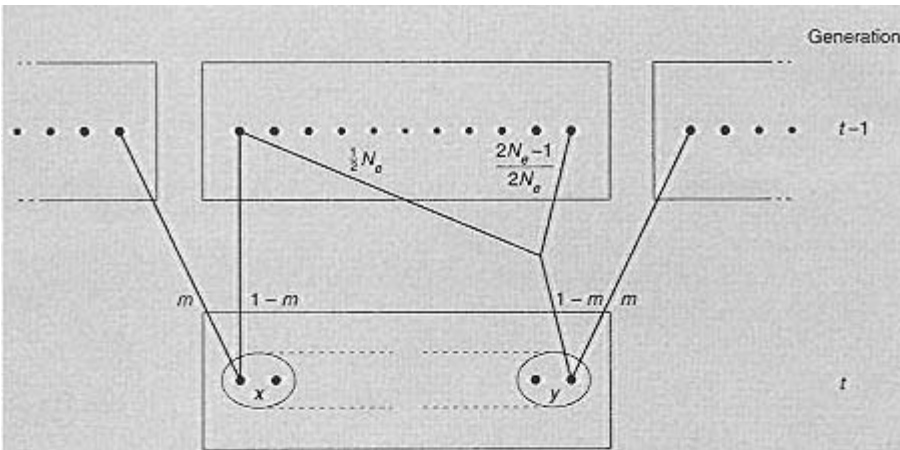

Figure 8.13 The island model.

To allow for mutation, we must multiply the RHS by $(1 - u)^2$: this is to assume an 'infinite alleles' model, since we suppose that two genes are identical only if no mutation has occurred. A similar argument leads to an equation for $G_{D,t}$, so that, writing $1/2N_e = c$ for simplicity,

$$\begin{aligned} G_{S,t} &= (1 - u)^2 \{ a[c + (1 - c)G_{S,t-1}] + (1 - a)G_{D,t-1} \} \\ G_{D,t} &= (1 - u)^2 \{ b[c + (1 - c)G_{S,t-1}] + (1 - b)G_{D,t-1} \}. \end{aligned} \quad (8.12)$$

We now need expressions for a and b . If the number of demes, n , is large, then a is approximately equal to the probability that both parents are non-migrant: that is, $a \approx (1 - m)^2 \approx 1 - 2m$. The value of b is approximately (probability that one of the two parents is a migrant) \times (probability that it migrated from the same deme as the non-migrant parent). That is, $b \approx 2m(1 - m)/(n - 1) \approx 2m/n$.

$$\text{Thus} \quad a \approx 1 - 2m; \quad b \approx 2m/n; \quad c = 1/2n. \quad (8.13)$$

At equilibrium between migration and mutation, $G_{S,t} = G_{S,t-1} = \hat{G}_S$, and $G_{D,t} = G_{D,t-1} = \hat{G}_D$. Hence we have two equations that can be solved for \hat{G}_S and \hat{G}_D . In doing this, we assume that m and u are small, and that n and N_e are large, so that we can ignore terms such as u^2 , m/N_e , etc. The solutions are

$$\hat{G}_S = \frac{m + nu}{m + nu + 4nN_e mu} \quad \hat{G}_D = \frac{m}{m + nu + 4nN_e mu}. \quad (8.14)$$

Unfortunately, these results suffer from the same drawback as the result $\hat{F} = 1/(1 + 4N_e u)$, obtained on p. 146: the time taken to approach the equilibrium is of order $1/u$ generations. However, in this case we are not so

much interested in the absolute values of \hat{G}_S and \hat{G}_D as in their relative values. Accordingly, Nei (1975) introduced the coefficient

$$G_{ST} = \frac{H_T - \hat{H}_S}{H_T},$$

where $H_T = 1 - \hat{G}_D$ = probability that an individual whose parents came from different demes is a heterozygote; and $\hat{H}_S = 1 - \hat{G}_S$ = probability that an individual whose parents came from the same deme is a heterozygote.

Substituting from Equation 8.14 gives

$$G_{ST} = \frac{1}{1 + 4N_e m}, \quad (8.15)$$

The significance of this result is discussed in the main text.

It is shown in Box 8.3 that, at equilibrium between mutation and migration,

$$G_{ST} = \frac{1}{1 + 4N_e m}, \quad (8.16)$$

where N_e is the effective size of a deme, and m the proportion of breeding individuals that are migrants. This result assumes that the number of demes n , is large, and that the mutation rate μ , is small. Given these plausible assumptions, G_{ST} does not depend on n or μ , but only on $N_e m$, the effective number of migrants per deme, per generation. If $N_e m \gg 1$, $H_T \cong \hat{H}_S$, and there is little genetic differentiation between demes: if $N_e m < 1$, then $H_T \gg \hat{H}_S$.

The beauty of G_{ST} is that the equilibrium value is approached fairly rapidly. The time taken is of order $1/m$, rather than $1/\mu$. The equilibrium values of H_T and \hat{H}_S , given in Box 8.3, do depend on the mutation rate, and are approached much more slowly: they suffer from the same disadvantage as the estimate \hat{c}_F (Equation 8.8). Table 8.3 gives some values of G_{ST} . In only one case is there substantial genetic differentiation: this is perhaps not surprising, in view of the rather small amount of migration needed to maintain genetic homogeneity.

How robust is Equation 8.15 to changes in the model? One assumption made in deriving it is that a mutation always produces an entirely new allele, not already present in the population: it is an infinite alleles model. Fortunately, the expression for G_{ST} remains unaltered if we assume only a small number of possible allelic states. A more serious limitation was the 'island' assumption, that a migrant is equally likely to move to any other deme. Stepping-stone models are hard to analyse, but have been extensively simulated. For two-dimensional models, the conclusion that one migrant per deme per generation is sufficient to maintain a fair degree of genetic similarity between demes remains true. For linear models (streams or shore lines) greater degree of diversity does develop.

Table 8.3

Analysis of genetic diversity within and between groups (data from Nei 1975).

Species	Number of populations	Number of loci	H_r	H_s	GST
Human major races	3	35	0.130	0.121	0.070
Yanomama Indian villages	37	15	0.039	0.036	0.069
House mouse	4	40	0.097	0.086	0.119
Kangaroo rat	9	18	0.037	0.012	0.674
<i>Drosophila equinoxialis</i>	5	27	0.201	0.179	0.109
Horseshoe crab	4	25	0.066	0.061	0.072
Club moss	4	13	0.071	0.051	0.284

The Establishment of a New Favourable Mutant

I conclude this chapter by discussing a rather different stochastic effect. A favourable mutation occurs, in the first instance, in a single individual, and will be present only in a small number of individuals for a number of generations, until it is common enough to be treated deterministically. During this period, there is a real possibility of the chance loss of a favourable mutation. The likelihood of this happening depends on the distribution of family sizes. For example, suppose that 99 per cent of all female zygotes die before they reproduce, and that the remaining 1 per cent produce 200 offspring. Imagine a favourable dominant mutation that does not alter the chance that a female will reproduce, and which increases to 300 the number of offspring she produces if she does. In a deterministic model, such a mutant has a selective advantage of 50 per cent, but a new mutation has a probability of 0.99 of being lost by chance in the first generation. In contrast, if all typical female zygotes produce exactly two offspring, and mutant females produce exactly three offspring, the selective advantage of the mutant is again 50 per cent, but a new mutation has no chance of being lost.

This problem, for more plausible family size distributions, was first solved by Haldane: his method was later improved by Fisher and by Malecot. If family size has a Poisson distribution, the chance that a favourable mutation will be established in a large, random mating diploid population is $\frac{2s}{1+s}$ where the fitness of the mutant heterozygote is $1+s$. The derivation of this result is difficult, but the result is easy to remember. The implication is important. A new mutation that confers a 1 per cent selective advantage in the heterozygote has a 1 in 50 chance of being established. The selective advantage in the homozygote is irrelevant, because in the first few critical generations the new gene is too rare to occur in the homozygous state. At first sight, it might seem that a fully recessive favourable mutation has no chance of being established. However, this is true only for an infinite random-

mating population: if there is some degree of inbreeding, a fully recessive mutation does have a chance of occurring in homozygotes, and so does have a chance of being established.

Further Reading

Avise, J.C. (1986). Mitochondrial DNA and the evolutionary genetics of higher animals *Philosophical Transactions of the Royal Society* **B312**, 325-42.

Slatkin, M. (1985). Gene flow in natural populations *Annual Review of Ecology and Systematics* **16**, 393-430.

For a full account of the neutral mutation theory:

Kimura, M. (1983). *The neutral theory of molecular evolution*. Cambridge University Press.

For a critique of the theory:

Gillespie, J.H. (1987). Molecular evolution and the neutral allele theory *Oxford Surveys in Evolutionary Biology* **4**, 10-37.

Problems

1. In a diploid outbred population, there is an average of three recessive lethals per haploid genome. Two unrelated individuals are crossed, and their offspring mated brother to sister. What is the expected viability of the F_2 ?
2. A self-fertile hermaphrodite plant was heterozygous at six enzyme loci. Its progeny were selfed for four generations. (a) Would you be prepared to bet, at evens, that a randomly chosen F_4 plant is homozygous at all six loci? (b) The first F_4 plant examined was heterozygous at five of the six loci: what would you conclude?
3. A dairy herd consists of six breeding bulls and 50 cows. What is the effective population size?
4. In a large random-mating population, a dominant mutation A occurs, such that Aa has a selective advantage of 1 per cent over typical aa individuals. (a) What is the probability that A will be established? (b)* Suppose that A is established: what is the expected number of copies of A after 60 generations?
5. The rate of evolution at the β -haemoglobin locus in mammals is approximately 0.15 amino acid substitutions per gene per million years. The heterozygosity at the locus in man is less than 0.01. The effective size of the human population is over 10^4 . Do these facts disprove the neutral mutation theory? If not, why not?

Computer Projects

A natural population carries a number of slightly deleterious recessive genes. Fitnesses are $m/m = 0.9$; $m/+$ and $+/+ = 1.0$. A brother-sister mated line is started from this population. The original male is heterozygous, $+/m$, at three loci, and the original female is $+/m$ at three other loci: all six loci are unlinked. Write a simulation to answer the following questions. How many generations does it take, on average, to produce a genetically homogeneous line? In what proportion of cases is the line homozygous for 0, 1, 2, . . . 6 deleterious recessives?

Chapter 9— Evolution in Structured Populations

Selection in trait groups	<u>163</u>
The evolution of co-operation: synergistic selection	<u>164</u>
The evolution of co-operation: relatedness	<u>167</u>
The group as the unit of evolution	<u>173</u>
The shifting balance theory	<u>179</u>
Further reading	<u>180</u>
Problems	<u>181</u>
Computer projects	<u>182</u>

There are two ways in which the structure of a population may affect its evolution. First, mating may not be random: in particular, there may be partially isolated demes, or close relatives may mate with one another. Secondly, even if mating is random, selection may act on groups of interacting individuals, rather than on individuals in isolation. I discuss the latter possibility first.

Selection in Trait Groups

Figure 9.1 shows a simple model of selection, suggested by Wilson (1975). The members of a large random-mating population break up into **trait groups** of n individuals: selection acts while they are associated in trait groups. The fitness of an individual (that is, its expected contribution to the next generation) depends on its own genotype and on the genotypes of the other members of the group. After selection, the surviving individuals re-enter a random-mating population, where they contribute gametes to the next generation.

For simplicity, suppose that there are two genotypes, A and a . The A individuals are 'altruists', in the sense that they perform some act which lowers their own fitness by c (where c stands for 'cost'), and increases the fitness of each of the $(n - 1)$ other members of the trait group by $b/(n - 1)$, where b is the total 'benefit' conferred. Then the fitnesses of an A and an a individual, respectively, are

$$\begin{aligned} W_A &= W_0 - c + rb/(n - 1), \\ W_a &= W_0 + rb/(n - 1), \end{aligned}$$

where W_0 is the fitness of an individual that neither performs, nor receives the benefits of, an altruistic act, and r is the number of A individuals among the $(n-1)$ other members of the group.

Now suppose that the frequency of A in the population as a whole is p , and that individuals assort into trait groups at random. Then the expected number of A

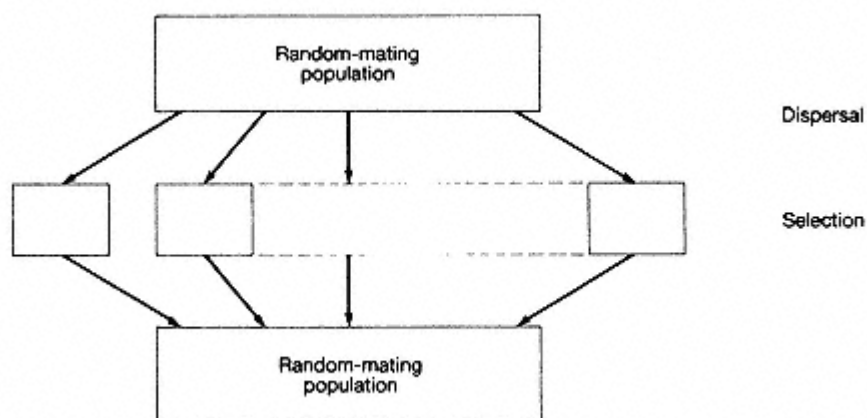

Figure 9.1
The trait-group model.

neighbours (that is, other members of a group) is $(n - 1)p$, and is the same for A and a individuals. Since fitness effects combine additively, we have

$$W_A = W_0 - c + pb,$$

$$W_a = W_0 + pb.$$

Hence, if c is positive (that is, if the act really does cost something) $W_a > W_A$ and, provided the difference is heritable, a will replace A . Hence, for the particular assumptions we have made, the value of b is irrelevant in determining the direction of evolution. The only thing that matters is the direct effect of an individual's actions on its own fitness (that is c); its effects on others (b) are irrelevant.

If this were all, there would be little point in writing this chapter. But in reaching our conclusion, we have made two critical assumptions: if we relax either of them, interesting things happen. The assumptions are:

1. fitness effects combine additively; and
2. individuals assort randomly into trait groups.

I first consider the effect of relaxing the additivity assumption, and then that of random assortment. Before continuing, however, note that the assumption of discrete groups is not really essential to the argument: what is important is that each individual should interact with a limited number of neighbours, but this could take place in a continuously distributed population.

The Evolution of Co-operation: Synergistic Selection.

Before turning to a formal treatment of non-additive fitness interactions, consider the following example, which shows that there is nothing magical or implausible about them. A pride of lions consists of a group of females, their young, and a group

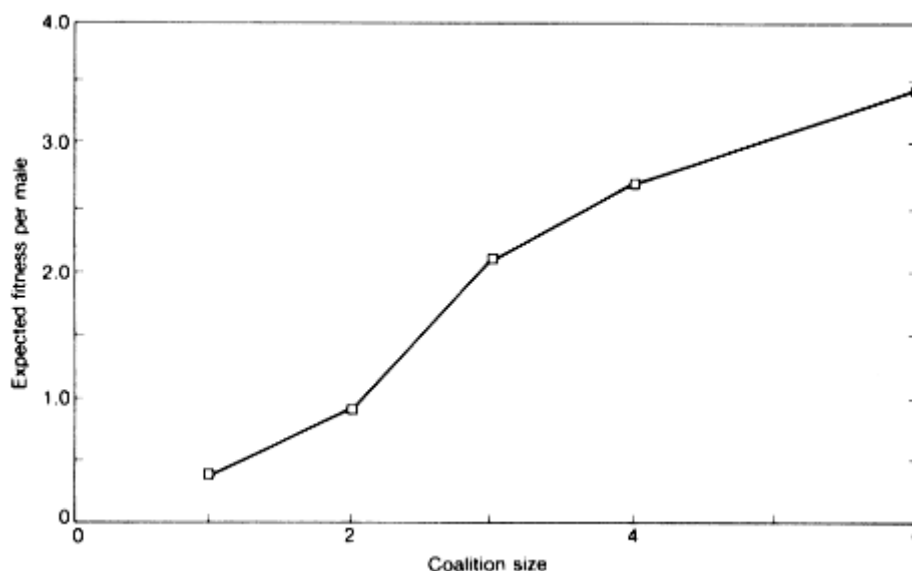

Figure 9.2

The reproductive success of male lions (from Packer *et al.* 1985).

of males which share sexual access to the females, and bar access by other males. A single male is, typically, unable to hold a group of females, and to prevent take-over by other males. Figure 9.2 shows the expected fitness of individual males, as a function of the size of the group to which they belong. Clearly, a male that is willing to co-operate is fitter than one that is not, provided that it can find a partner with which to co-operate.

Figure 9.3 gives a formal description of such cases. As in the last section W_0 is the fitness in the absence of any interaction, c the cost of co-operation, and b the benefit to an individual if its partner co-operates. The term s is the additional fitness of a co-operator if its partner also co-operates: it is the non-additive synergistic effect of co-operation. The payoff matrices can be interpreted in two ways. If interacting groups consist of two individuals, then the entries are the fitnesses of an individual adopting the strategy on the left, if its partner adopts the strategy above. For groups of more than two, the entries are the fitnesses of an individual adopting the strategy on the left, if all other members of the group adopt the strategy above. In the latter case, the information is sufficient to show whether C , or D , or both, are ESSs: if neither is an ESS, then the ESS is a mixed strategy, but additional information would be required to find the equilibrium frequencies.

If b and c are positive (that is, real costs and benefits), and if $b > c$ (synergistic effect greater than cost), then both C and D are ESSs. That is, co-operation is stable once it evolves, but it cannot invade a population of defectors: in the lion example, a co-operative male would gain no advantage if it could not find a partner. This situation may be typical. How, then, can co-operation get established in the

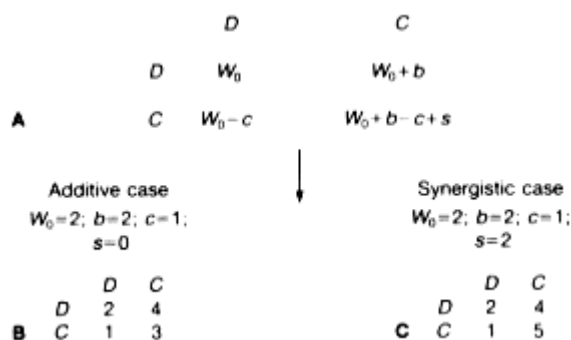

Figure 9.3
 Models of co-operation. **A** the general case; **B** an additive example; **C** a synergistic example. Two strategies are considered: *C*, co-operate, and *D*, defect (do not co-operate). *c* = Cost of cooperation; *b* = benefit conferred; and *s* = synergistic effect.

first place? A likely answer is that interacting individuals are often related. This has two rather different effects, both favourable to the evolution of co-operation.

1. Even when *C* is rare, if one member of a family is *C* there is a reasonable chance that other members of the same family will be *C*. Hence, if individuals interact with members of their own family, a individual has a reasonable chance of interacting with another *C*. Thus, for a payoff matrix like that of Fig. 9.3C, co-operation can spread even when it is rare in the population as a whole.
2. As we shall see in the next section, co-operation may spread even for the payoff matrix of Fig. 9.B, if interactions are between relatives.

In the social sciences, the payoff matrix of Fig. 9.B is called 'the Prisoner's Dilemma'. It is paradoxical in the following sense. Regardless of what one's partner does, it pays to play *D*: hence a rational person plays *D*. Since one's partner is rational too, he also plays *D*, and one's expected payoff is 2: yet if both were irrational, and played *C*, the payoff would be 3. One way of escaping from this paradox is to suppose that the 'game' is played repeatedly by the same two opponents. Then more complex strategies are possible, in which one's play in each game depends on what one's opponent did last time. One such simple strategy is 'Tit for Tat' (TFT): that is, play *C* in the first game, and then play in each game what one's partner played last time. Table 9.1 shows the payoff matrix for *D* and TFT, if

Table 9.1

Payoffs in the repeated Prisoner's Dilemma

	<i>D</i>	<i>C</i>		<i>D</i>	TFT
<i>D</i>	2	4		<i>D</i>	20 22
		10 → times			
<i>C</i>	1	3		TFT	19 30

the game is played 10 times between the same two partners. Formally, this resembles the matrix of Fig. 9.3C: TFT is an ESS if once it evolves. This is an example of reciprocal altruism, as proposed by Trivers (1971).

The Evolution of Co-operation: Relatedness

I have agreed that there are two reasons why the effects of one individual's behaviour on the survival of another might alter gene frequencies. The first, that effects on fitness combine non-additively, was discussed in the last section. I now turn to the second reason: that the interacting individuals may be genetically related. I do this by considering a specific problem, that of 'altruism' between siblings.

First, the model. Imagining a large random-mating diploid population of birds, with a clutch size of two. The birds are monogamous, so the members of a clutch are full sibs. In typical members of the population (genotype aa), the probabilities of survival of the older and younger sib are 1 and k , respectively, where $k < 1$. A rare dominant gene, A , for 'altruistic' behaviour has the following effects. If present in the older sib, it causes that sib to be less greedy for food, so that its survival probability becomes $1 - c$ and that of its sib becomes $k + b$, where $k + b < 1$: it has no effect if present in the younger sib. It may be helpful to remember that c means 'cost' and b means 'benefit'.

The model will be analysed in three different ways:

1. By listing all possible sibships, and what happens in them. This 'long-hand' method takes a lot of space, but it is clear, and may give confidence in the results of the other two methods.
2. A 'gene-centred' method, in which I ask whether the effects of a gene are such as to increase or decrease its frequency in the population.
3. A method based on relatedness.

The first method is set out in Table 9.2, which lists the possible matings, with their frequencies, and the kinds of families produced. It is then easy to calculate that A increases, when rare, provided that $B/2 > c$.

A more intuitive method of reaching the same result is shown in Fig. 9.4. We add up all the effects of gene A on its own replication. Suppose that a surviving chick has an expected number of offspring \bar{N} : this is equivalent to saying that it produces \bar{N} successful gametes. By reducing its chance of survival by c , gene A reduces the number of copies of itself transmitted by the elder sib by $\bar{N}c/2$: the $1/2$ arises because A is a rare gene, so the elder sib is Aa , and transmits allele A to only half its gametes. A increases the number of copies of itself transmitted by the younger sib by $\bar{N}bp$, where p is the probability that a gamete produced by the younger sib is A . Hence allele A increases in frequency provided that $bp > c/2$.

Table 9.2

Co-operation between sibs

Family	Possible families (older sib first in each case)							
	<i>aa</i>	<i>aa</i>	<i>aa</i>	<i>Aa</i>	<i>Aa</i>	<i>aa</i>	<i>Aa</i>	<i>Aa</i>
Fitness	1	<i>k</i>	1	<i>k</i>	1- <i>c</i>	<i>k+b</i>	1- <i>c</i>	<i>k+b</i>
Mating								
<i>aa aa</i>	1		—		—		—	
<i>aa Aa</i>	} 1/4		1/4		1/4		1/4	
<i>Aa aa</i>			1/4		1/4			

If *A* is a rare allele, and if mating is random, we can ignore *AA* individuals, and *Aa Aa* matings. Typical *aa* offspring arise from *aa aa* matings: hence the fitness of *aa* is $(1 + k)/2$. *Aa* individuals are of three kinds.

Offspring type	Probability	Fitness
Older sib	1/2	1- <i>c</i>
Younger sib, with <i>Aa</i> older sib	1/4	<i>k+b</i>
Younger sib, with <i>aa</i> older sib	1/4	<i>k</i>

Hence the fitness *Aa* is $(1-c)2 + (k+b)/4 + k/4 = (1+k)/2 - c/2 + b/4$. Therefore, *A* increases if $b/2 > c$.

What is *p*? Since *A* is rare, a gamete produced by the younger sib will be *A* only if it is identical by descent to the gene *A* in the older sib. The probability of this being so is equal to the probability that a gene drawn at random from the younger sib is identical by descent to a gene drawn at random from the older sib: that is, $p = F$, where *F* is the coefficient of kinship between full sibs (see Box 9.1). Further,

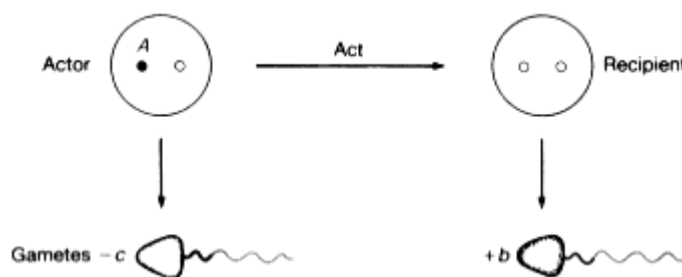

Figure 9.4

A gene-centred model of altruism. Gene *A* causes the 'actor' to perform an act. The results of the act are (1) to reduce by *c* ('cost') the number of gametes transmitted by the actor, and (2) to increase by *b* ('benefit') the number of gametes transmitted by the recipient. The loss of *A* genes is $-c/2$, and the gain of *A* genes is bp , where *p* = probability that a gamete produced by the recipient is identical by descent to *A*.

(Note: this assumes that gene *A* is rare.)

**Box 9.1—
The Coefficients of Kinship and Relatedness**

The coefficient of kinship, F_{IJ} , between two individuals was defined on page 000 as the probability that two homologous genes, drawn randomly from two individuals, I and J , are identical by descent: that is, are copies of the same gene in a recent ancestor.

The coefficient of relatedness, r_{IJ} , of individual I to individual J is the proportion of genes in J that are IBD to genes present in I ; equivalently, it is the probability that a random gene sampled from J is IBD to a gene present in I .

In a diploid species, $r_{IJ} = r_{JI}$. Further, a random gene from J has two chances: it can be identical to one of the homologous genes in I , or to the other. If I is not itself inbred, these two possibilities are independent and mutually exclusive. Since each has the probability F_{IJ} , we have

$$r_{IJ} = 2F_{IJ} \quad (9.1)$$

In a haplo-diploid, it is no longer always true that $r_{IJ} = r_{JI}$. The calculation of coefficients of relatedness in haplo-diploids is discussed in Box 9.2.

since the population is diploid, $F = r/2$, where r is the coefficient of relatedness between full sibs. Hence the condition for the spread of allele A , when rare, is

$$bF > c/2 \quad \text{or} \quad rb > c. \quad (9.2)$$

This is **Hamilton's rule**. For full sibs, $r = 1/2$, so Equation 9.2 gives the same result as we obtained by the long-hand method. However, we did not assume any particular relationship in deriving Equation 9.2. For example, if the chicks had the same mother but different fathers; $r = 1/4$, so the requirement is $b/4 > c$.

So far we have assumed that allele A is rare. We can, however, extend Equation 9.2 to cover the case when A is not rare. The easiest way to see that this extension is justified is to use a third approach, based on relatedness: Fig. 9.5 gives a geometrical interpretation of the argument. Let us call the elder sib the 'actor' and the younger sib the 'recipient'. The 'action' has the effect of reducing by Nc the number of offspring produced by the actor, and increasing by Nb the number produced by the recipient. Now we can picture the genome of the recipient as consisting of two parts:

1. a fraction r , consisting of genes IBD to genes in the actor; and
2. a fraction $(1 - r)$, consisting of genes that are a random sample of the genes in the population (note that, in assuming this, we are assuming random mating).

Hence, as far as their effect on gene frequency is concerned, the additional Nb offspring produced by the recipient are equivalent to Nbr offspring produced by the actor, plus $Nb(1 - r)$ offspring with a gene frequency equal to that of the

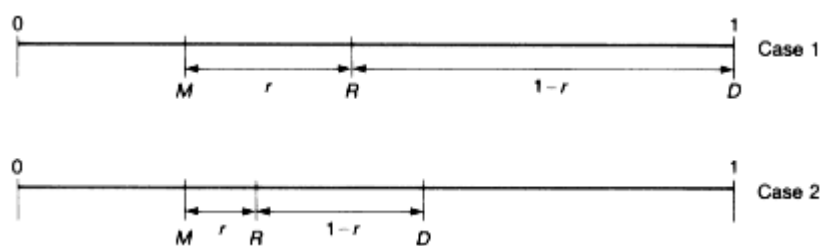

Figure 9.5

A geometric interpretation of relatedness. The frequency p of an allele A is plotted on a line from 0 to 1. D is the 'donor', or 'actor': in Case 1, D is AA , so $p = 1$; in Case 2, D is Aa , so $p = 1/2$. M is the population mean. R is the 'recipient' of the act. Any particular recipient is either aa , Aa , or AA , and so has a p value of 0, $1/2$, or 1. The R in the diagram is the average, or expected, value of p in the recipient. The genes in R consist of a fraction r drawn from D , and $(1-r)$ from the population, where r is the coefficient of relatedness of the actor to the recipient (that is, the fraction of the recipient's genes that are IBD to genes in the actor). Hence $p_R = rp_D + (1-r)p_M = p_M + r(p_D - p_M)$, as shown in the diagram. (After Grafen 1985.)

population. Clearly, only the Nbr offspring have any effect in altering the population gene frequency: the $Nb(1-r)$ make no difference. Hence, even for a common gene, the direction of gene frequency change is determined by the sign of $Nbr - Nc$: that is, Hamilton's rule still applies.

Some important assumptions were made in deriving the rule:

1. Random mating, in a large population. The extension of Hamilton's rule to cover cases of inbreeding is complicated.
2. Costs and benefits combine additively to determine the fitness of a given genotype. In the particular model analysed, an individual can only be an actor if it is the older sib, and a recipient if it is the younger sib, so that no question arises of how costs and benefits combine in determining the fitness of an individual. In other interactions, however, such as that between male lions discussed in the last section, the effects may combine non-additively. If the interacting individuals are relatives, both synergistic and relatedness effects are present: an account of how to analyse such cases is given by Queller (1985).
3. Diploidy. An important application of these ideas is to the evolution of sociality in haplo-diploids. The extension of Hamilton's rule to haplo-diploids is discussed in Box 9.2.
4. Weak selection. In calculating r , it is assumed that all genotypes have the same chances of survival, and of transmitting genes. If selection is strong, the value of r calculated from a pedigree is an inaccurate measure of the proportion of genes that are IBD.
5. The gene frequency is the same among potential donors and potential recipients. Thus suppose that allele A , in our model, caused a chick to hatch sooner. When rare A , would usually be present in elder chicks: it would therefore suffer the disadvantages of altruism without receiving the benefits,

and could not spread. Difficulties of this kind arise if genes affecting behaviour have pleiotropic effects, or if they are in linkage disequilibrium with other genes.

6. Genetic relatedness is the only cause of genetic similarity between interacting individuals. Thus an allele A for altruistic behaviour could spread if individuals carrying A tend to congregate, regardless of relatedness. Note that this, too, requires pleiotropy, or linkage disequilibrium.

Box 9.2—

Relatedness in Haplo-diploids

How should Hamilton's rule be applied to haplo-diploids? There are two preliminary questions that must be dealt with:

1. How shall we value genes in males and females? In a diploid species, a gene transmitted to a son, and to a daughter, contribute equally to the fitness of a parent. Is the same true for haplo-diploids? The answer is yes. I will show this for the special case of a population with a 1:1 sex ratio. In such a population, females have, on average, one son and one daughter, and males have one daughter: females have twice as many offspring as males. However, a gene in a female is transmitted to only half her offspring, whereas a gene in a male is transmitted to all his daughters. These two effects exactly cancel out, and the expected number of copies, in any future generation, of a gene in a male equals the expected number of copies of a gene in a female.
2. How shall we estimate b and c ? It turns out that the most convenient measure is in terms of the expected number of offspring gained and lost. This has the rather odd consequence that a male wasp that sacrificed itself to ensure the survival of a female would suffer a cost of -1 , and confer a benefit of $+2$. (It would be possible to measure b and c in lifetimes, so that the values of a male and a female life were equal, but this would force us to redefine the coefficient of relatedness in an unintuitive way.)

Thus, in applying Hamilton's rule, we count costs and benefits in terms of offspring gained and lost, and we value sons and daughters equally. As for diploids, r_{IS} is the proportion of genes in the recipient, S , that are IBD to genes present in the actor, I . Figure 9.6 gives some values of r_{IS} .

Notice that $r_{\text{sister, brother}} = 1/2$, and $r_{\text{brother, sister}} = 1/4$. Let us check that Hamilton's rule works for these two cases. First, consider a gene A causing a female to lose c offspring, and causing her brother to have an additional b offspring. The loss of A genes is $c/2$ (because a female transmits the A gene to

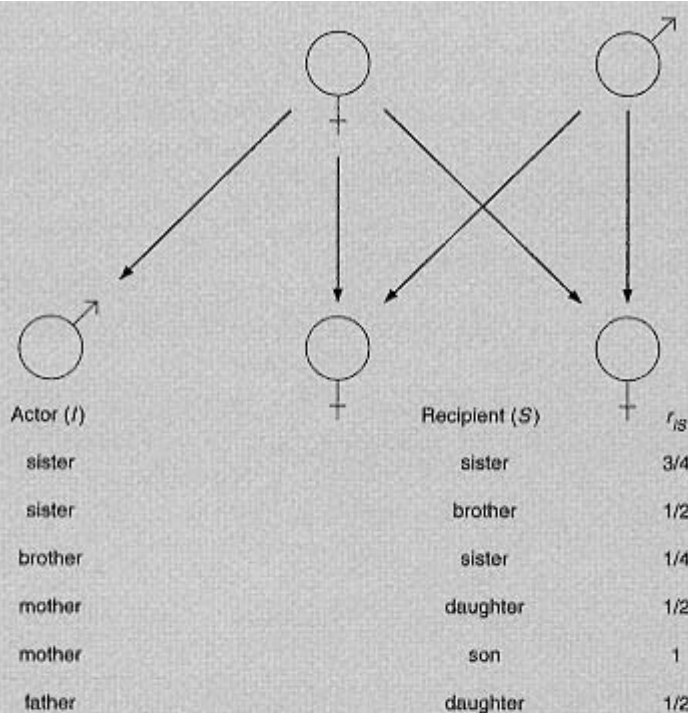

Figure 9.6 Coefficients of relatedness for haplo-diploids. As an example, consider the calculation of $r_{\text{brother,sister}}$. A gene in a female came from her mother with probability 1/2, and from her father with probability 1/2. In the former case, there is a probability 1/2 that an identical gene was transmitted to her brother; in the latter case, it certainly was not. Hence $r = \frac{1}{2} \times \frac{1}{2} + \frac{1}{2} \times 0 = \frac{1}{4}$.

Now consider a gene A causing a male to lose c offspring, and causing his sister to have b additional offspring. The loss of A genes is c (because all the male's gametes carry A). The female has a probability of 1/2 of carrying a gene IBD to A (thus A was certainly present in her mother, and had an even chance of being transmitted): if she does have it, she transmits it to half her gametes. Hence the gain of A genes is $b/4$, and A increases in frequency if $b/4 > c$. Again, this agrees with $rb > c$.

Thus we have a method of applying Hamilton's rule to haplo-diploids. A feature of Fig. 9.6 that has attracted attention is that a female is more closely related to her sisters than to her daughters. Hence a gene causing a female to raise sisters rather than daughters would be favoured by selection. How important has this been for the evolution of eusociality in the hymenoptera? Some people have argued that it has little relevance, because, at least in the early stages of the evolution of eusociality, a female would not distinguish the sexes of her siblings, and would raise both brothers and sisters. Her *average* relatedness to her siblings is the same as to her own daughters, and so the

genetic system does not give any special bias towards sociality. According to this argument (Andersson 1984), the reason why sociality has evolved repeatedly among the hymenoptera, and not, for example, among the diptera, is that prolonged maternal care is common even in solitary hymenoptera. The alternative view is that, when allowance is made for a bivoltine life history and a fluctuating bias in the sex ratio, haplo-diploidy can still provide a bias towards the evolution of sociality. The argument (Seger 1983; Grafen 1986) is difficult, but interesting.

The rule, $rb > c$, was given by Hamilton in a paper in which he introduced the concept of **inclusive fitness**, as an alternative to the classical fitness of population genetics. This concept is briefly explained in Box 9.3. In thinking about particular cases, however, it is usually easier to apply the rule $rb > c$, or to use a more directly gene-centred approach. Very often, a helpful way of thinking about the evolution of some behavioural trait is to imagine a gene of very low penetrance, and to ask, on those occasions when the gene is expressed (that is, when the trait appears) is the result an increase or a decrease in the number of copies of the gene?

In Box 9.4, Hamilton's rule is applied to the evolution of social behaviour in the wasp *Polistes*.

The Group as the Unit of Evolution

According to the theory of evolution by natural selection, any population of entities with the properties of multiplication, variation, and heredity will evolve in such a way that the component entities will acquire characteristics ensuring their own survival and reproduction. The relevant entities may be RNA molecules in a test tube (p. 5), or individual genes (as in the 'gene-centred' model of p. 168), or individual organisms (as in the phenotypic models of Chapter 7). If a species is divided into demes, can we regard the demes as entities that will evolve by natural selection? Thus a successful deme may split into two, and, if so, the 'daughter' demes will have some of the properties of the parent. If demes are units of evolution in a Darwinian sense, then we can expect them to evolve characteristics ensuring their own survival and reproduction. For example, demes might evolve mechanisms preventing them from outgrowing the available food, as proposed by Wynne-Edwards (1962).

The reason why we cannot safely regard demes as units of evolution is that they are themselves composed of entities that evolve: they are composed of organisms. The only reason why a deme has heredity (if we ignore cultural inheritance) is that its component organisms have heredity. All genetic differences, therefore, are subject to selection at two levels: selection between organisms within a deme, and

**Box 9.3—
Inclusive fitness**

In population genetics, the fitness of a genotype, say AA , is the expected number of offspring produced by individuals of that genotype. Provided that we correctly ascribe fitness to genotypes, we can calculate how the population will change. Why, then, do we have to take into account the offspring produced by relatives?

One answer is that we should not, but if so, we must be very careful to calculate fitnesses correctly. Thus suppose that A is an allele for sib altruism. Then AA individuals are likely to have sibs carrying the A allele, and hence are likely to receive help: in calculating the fitness of AA , we must allow for this help received from relatives. Hamilton called the fitness calculated in this way the **neighbour-modulated** fitness. It often turns out to be difficult to calculate: the calculation in Table 9.2 was of neighbour-modulated fitness. He therefore introduced an alternative, the **inclusive fitness**. For a given genotype, say AA , the inclusive fitness is the expected value of:

(number of offspring produced by AA) - (offspring produced by AA only because of help received from relatives) + (additional offspring produced by relatives of AA , because of assistance provided by AA , weighted by the coefficient of relatedness).

It is often easier to calculate the inclusive fitness, because we only have to take into account the direct effects of individuals. Hamilton showed that, if fitnesses are defined in this way, the direction and, approximately, the rate of gene frequency change predicted is the same as that predicted by the neighbour-modulated fitness.

selection between demes. If the same traits are favoured at both levels, no difficulty arises. But if a trait is disadvantageous to the individual, but favourable to a deme whose members have the trait, the relative effectiveness of selection at the two levels can be hard to estimate.

One way of thinking about the problem is illustrated in Fig. 9.7. The environment is supposed to be divided into 'patches': these could be food plants for a herbivorous insect, or hosts for a parasite, or cowpats for a dung fly. (In fact, resources need not be patchily distributed, provided that organisms remain in coherent groups for some other reason.) Individual organisms are of two kinds A , or altruistic, and S , or selfish. A group composed of A s is more successful than one composed of S s, but, within a group, S replaces A . A patch can be in one of three states: E , or empty; S , containing a population of S s; and A , containing a population of A s. For simplicity, I omit patches containing a mixture of A and S individuals.

Box 9.4—
An Example of Kin Selection

In the social wasp, *Polistes metricus*, nests are sometimes founded by a single female, and sometimes by a pair of females. In the latter case, the co-foundresses come from a single nest in the previous summer. One, the α female, is dominant, and lays most of the eggs; the β female does most of the foraging. The following account is based on the work of Metcalf and Whitt (1977a,b), but I have omitted some complications.

First, what question are we asking? In general, we want to understand the selective forces responsible for the evolution of the observed behaviour. This requires that we know what alternative behaviours are possible, and what would be the fitness of individuals adopting them. In this particular case, we want to understand the behaviour of the β females: why do they not abandon the joint nest, and establish a nest on their own? We know that this behaviour is possible, and can estimate the fitness of individuals adopting it, because some nests are founded by single females.

Metcalf and Whitt estimated that the number of reproductives produced by a pair of foundresses is 3.1 times that produced by a single foundress: this allows for nest survival, and for the success of nests that do survive. Next, we need to know the coefficient of relatedness, r , between co-foundresses. Consider first the simple case in which only the α female lays eggs, and in which females mate only once. Then co-foundresses are full sisters, and $r = 0.75$. We can then calculate the relative numbers of genes IBD to those of an α or β female that are transmitted to the next generation, as follows:

	Genes IBD to	
	α female	β female
α and β female together	3.1	$3.1 \times 0.75 = 2.325$
α and β female act alone	$1 + 0.75 = 1.75$	1.75

Hence, if the β female abandons the joint nest and acts on her own, the number of genes IBD to hers that are transmitted falls from 2.325 to 1.75.

Things are in fact more complicated. From electrophoretic studies, r between co-foundresses was only 0.63. This was partly because approximately 20 per cent of the eggs in a joint nest were laid by the β female (I omit the complication that the fraction is different for male and female eggs), and partly because foundresses usually mate at least twice. The latter fact can be deduced by examining the offspring of a solitary foundress homozygous for a polymorphic enzyme: if she produces both homozygous and heterozygous daughters, she has mated twice. The same data showed that, even though a female had mated twice, 90 per cent of daughters had the same father.

Accepting that β females produce 20 per cent of the offspring, and that $r = 0.63$, we can recalculate as follows:

	Genes IBD to	
	α female	β female
α and β female together	$3.1 (0.8 + 0.2 \times 0.63) = 2.87$	$3.1 (0.8 \times 0.63 + 0.2) = 2.18$
α and β female act alone	1.63	1.63

Again, if a β female abandons the joint nest, this reduces the number of genes IBD to her own that are transmitted.

In Box 9.2, I discussed whether haplo-diploidy has predisposed the hymenoptera to evolve sociality. I there considered the origin of eusociality to lie in a female helping her mother to raise her sibs. In *Polistes*, a female helps her sister to raise nephews and nieces. In this case, the haplo-diploid system does have a predisposing effect. In a diploid, the productivity of a joint nest, relative to a nest with a single foundress, would have to be higher before it would pay a β female to remain and raise her sister's children rather than her own, because r between sisters is lower.

The figure shows the kind of state transition that can occur:

1. An E patch can be converted to an A or an S patch, according to whether it is colonized by an A or an S individual.
2. A and S patches may become E , because of population extinction. I have shown the arrow $S \rightarrow E$ as stronger than $A \rightarrow E$, to indicate that A populations survive better than S populations.
3. A patches are converted into S patches, if there is an S immigrant into an A patch, or (less frequently) if an A individual mutates to S .

We want to know whether A can survive in competition with S . For this to be so, the number of S patches must not increase. This in turn requires that $M < 1$, where M is the number of migrants from an S patch that successfully invade (and transform) an A patch, or which colonize an E patch, during the lifetime of an S patch, from the time it arises (by colonization of an E patch, or conversion of an A patch), to the time it goes extinct. In effect M is the 'reproductive rate' of S patches.

For this condition to hold, the rate of migration must be low, and the survival time of patches must be short. It must also be true that new patches are colonized by one or a few individuals: if new patches were multiply colonized, the colonists would usually include an S individual, and the patch would become S .

These conditions are not impossible. They may hold, for example, for some parasites. If so, we can expect parasites to evolve traits that maximize the number of new parasites produced by a host, and not traits that make a parasite successful

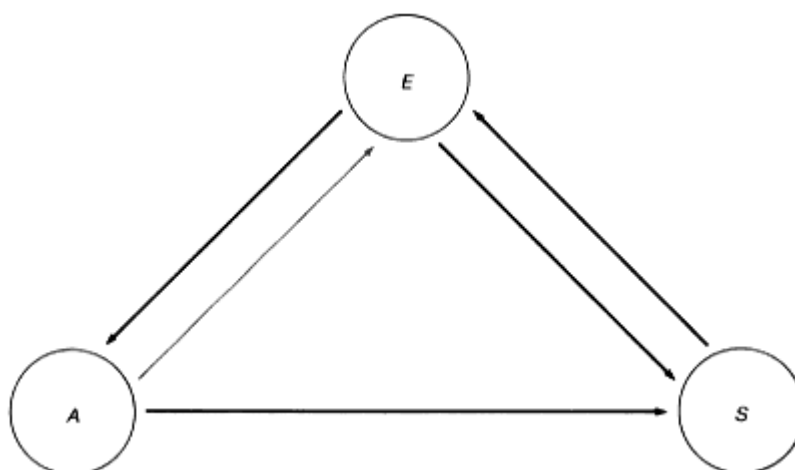

Figure 9.7

A model of group selection. Resource patches can be in one of three states: *A*, containing a population of altruists; *S*, containing a population of selfish individuals; or *E*, empty. The arrows indicate state transitions. Note that (1) an *A* patch can be converted into an *S* patch by a selfish immigrant, and (2) *S* patches are more likely to go extinct than *A* patches.

in competition with others in the same host. This may require that the host be kept alive, or at least not killed too quickly. Box 9.5 gives an example of parasite evolution.

There may be other cases in which demes are sufficiently isolated and short-lived, and are founded by sufficiently few colonists, for properties advantageous to the deme to evolve. But in most structured populations the degree of isolation is too small (see Table 8.3). Before accepting group advantage as the selective explanation of some trait, therefore, one must be satisfied that the population structure meets the rather stringent requirements.

Box 9.5—

The Evolution of the Myxoma Virus

Figure 9.8 shows the frequencies of myxoma virus strains of different virulence in Australia in 1950–51, when the virus was introduced to control rabbits, and at intervals up to 1981. Similar changes have occurred in the virus in Britain. These changes in the virus were measured by testing in a standard strain of rabbits: there has also been a slight increase in the resistance of the wild rabbits to the virus.

Evolution has led to the establishment of virus strains of an intermediate degree of virulence. The reason is as follows. The reproductive rate, R , of a virus infecting a rabbit is defined as the number of additional rabbits infected by viruses from that rabbit. R is the product of two terms:

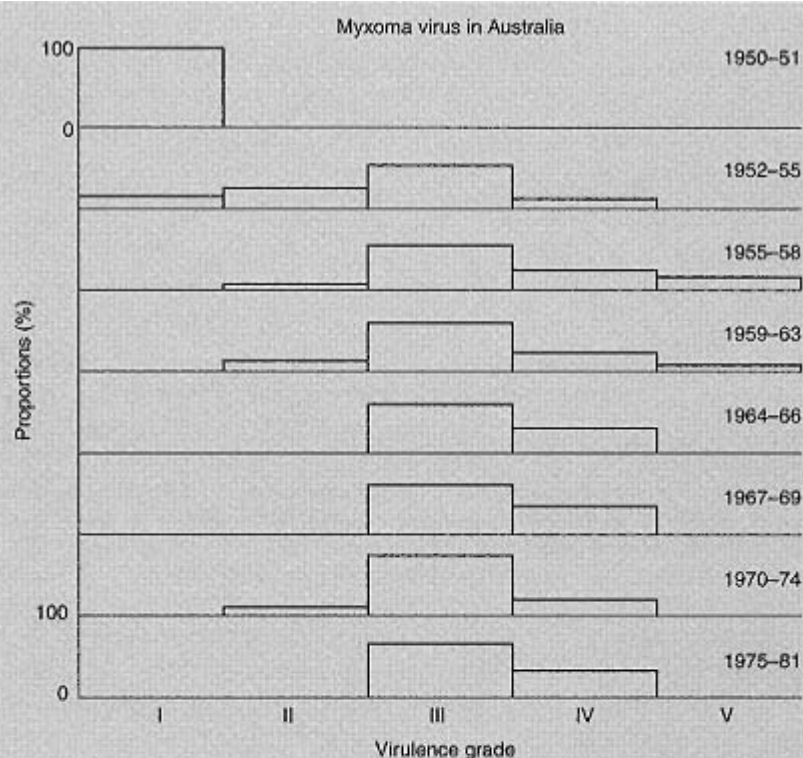

Figure 9.8 Proportions of the various grades of myxoma virus in wild populations of rabbits in Australia, from 1950-81 (data from Fenner 1983, quoted by May and Anderson 1983).

1. the rate, per day, at which new rabbits are infected: this will be an increasing function of the virulence of the virus; and
2. the time in days for which the original rabbit survives after being infected: this will be a decreasing function of the virulence.

Natural selection will favour the virus strain with the maximum value of R , which turns out to be a strain of intermediate virulence: highly virulent strains kill their hosts too quickly, and non-virulent strains have a low rate of further infection.

Notice that the argument that selection will maximize R assumes that all selection is between viral populations in different rabbits. This will only be true if, typically, a rabbit is infected only once. If a rabbit is infected by two different strains, between-strain selection within a host becomes important. This will tend to favour more virulent strains: there is no advantage to one strain that permits prolonged host survival if a second, more virulent, strain kills the rabbit quickly.

The Shifting Balance Theory

Sometimes, genotype G_1 is fitter than G_2 , yet evolution from G_1 to G_2 cannot occur in a large random-mating population. There are two simple cases ($>$ should be read as 'fitter than', and A as AA or Aa):

1. *Heterozygous disadvantage*. $AA > aa$, but $Aa < aa$. Then, starting with an aa population, allele A cannot invade, so AA cannot evolve.

2. *Epistatic fitness interactions*. For example, suppose that A is dominant to a , and B to b , and that $aabb < AB$, but $aaB < aabb$, and $Abb < aabb$. Then, starting from $aabb$, neither A nor B can invade.

Such situations can be described by saying that there are two adaptive peaks, separated by a valley (Fig. 9.9). In a large population, natural selection drives a population uphill: therefore, with the landscape of Fig. 9.9, a population can be trapped on a local peak and be unable to evolve to a higher one. If epistatic interactions are common, there can be many local peaks.

Sewall Wright's (1931) shifting balance theory of evolution was proposed to overcome this difficulty. Although a large random-mating population cannot evolve from a lower peak to a higher one, such a peak shift can occur by chance in a small population. Suppose that a population consists of a large number of small,

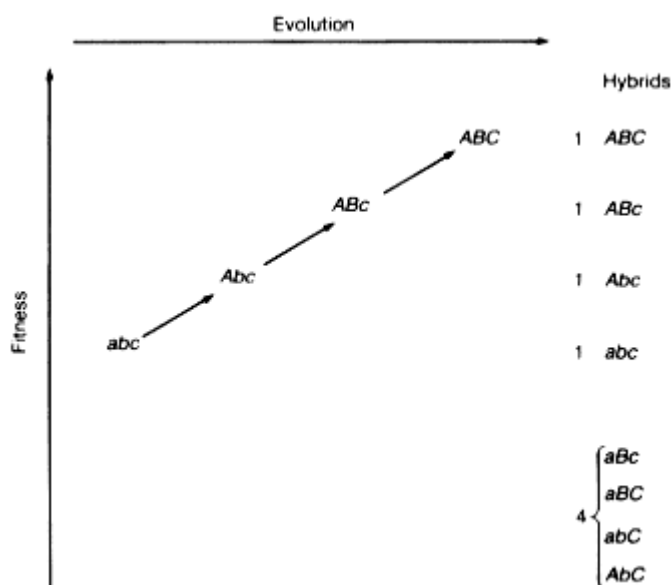

Figure 9.9

A case in which evolution could proceed by natural selection in a large population, and yet hybrids between the initial and final forms would show lower mean fitness than their parents. The organisms are haploid, with three relevant loci. It is assumed that fitness is increased if A replaces a ; if B replaces b only if A is present; and if C replaces c only if A and B are both present. The relative numbers of the different types of F_1 hybrid are shown on the right. Their fitnesses are indicated by their vertical positions; note that half the F_1 hybrids are less fit than either parent.

partially isolated demes. Occasionally, a deme will move to a higher peak. When this happens, the deme may be more successful in one of two ways: it may produce more migrants that enter other demes, or it may be more likely to split into two, or to colonize new patches. Thus, once a peak shift has occurred in one deme, the new genotype may spread through the population. Accordingly, Wright argued, the population structure most favourable for rapid adaptive evolution is that of a large population divided into many small, partially isolated demes. The small deme size makes peak shifts possible, and the large number of demes ensures that such shifts occur reasonably often.

There has been much debate about this idea. Three arguments are worth mentioning, although none is decisive:

1. The quantitative argument against group selection, based on Fig. 9.7, does not apply to Wright's model. The difficulty in explaining the evolution of altruism by inter-demic selection arises because a single 'selfish' immigrant can convert an altruistic into a selfish population. The analogous difficulty does not arise in Wright's model. Thus, for the epistatic case above, if a or b allele, or both, are introduced into an $AABB$ deme, they will usually be eliminated by selection.

2. There is one reason to think that peak shifts may have occurred in the evolution of chromosome structure (see p. 220): this is that structural heterozygotes usually have lowered fertility. If population structure has been such as to permit these peak shifts, then the same structure would permit the crossing of valleys arising from epistatic interactions.

3. An argument against the importance of peak shifts is as follows. People have sometimes been led to think that peak shifts are important by evidence from inter-population hybrids. It is certainly true that hybrids between geographically isolated populations are often of lowered viability or fertility. There can be every intermediate between fully fertile hybrids to the infertility characteristic of species hybrids. Unfit hybrids are sometimes seen as evidence that a valley must have been crossed in the evolution from one state to the other. This conclusion, however, is unjustified. It is quite possible for genotype G_1 to be connected to genotype G_2 by a series of steps, each of which would occur by natural selection in a large population, and yet for the F_1 hybrids between them to be of low fitness. A simple example involving three loci in a haploid is shown in Fig. 9.9. It is possible to construct an example involving only two loci in a diploid with dominance. Of course, this does not prove that peak shifts do not occur. But it does show that one of the arguments in favour of peak shifts is invalid: incidentally, it is not an argument that was ever used by Wright.

Further Reading

Grafen, A. (1985). A geometric view of relatedness. *Oxford Surveys in Evolutionary Biology* **2**, 28-89.

Hamilton, W.D. (1975). In *Biosocial anthropology*, (ed. R. Fox), pp. 133-55. Wiley, New York.

May, R.M. and Anderson, R.M. (1983). Epidemiology and genetics in the coevolution of parasites and hosts. *Proceedings of the Royal Society* **B219**, 281-313.

Trivers, R.L. (1971). The evolution of reciprocal altruism *Quarterly Review of Biology* **46**, 35-57.

Williams, G.C. (1966). *Adaptation and natural selection*. Princeton University Press.

Wilson, D.S. (1980). *The natural selection of populations and communities*. Benjamin Cummings, Menlo Park, California. (Expresses a different view on the evolution of cooperation.)

Problems.

1. The lizard species, *Cnemidophorus uniparens*, consists of a clone of genetically identical females, which is thought to have originated a few thousand years ago from a single cross of a male of one sexual species and a female of another. Would you expect the females of this species to be particularly altruistic towards one another?

2. In armadillos, a female produces a litter of four genetically identical offspring, that arise by the splitting of a single zygote. Would you expect armadillos to be particularly altruistic towards their sibs?

3. In the Ani (a cuckoo-like bird), two females sometimes lay in a single nest. One of the pair is dominant, and can throw out the eggs of her partner. Pairs can successfully raise 10 offspring. A single female can raise three offspring. How many eggs laid by the subordinate (out of 10) would you expect the dominant to leave in the nest if (a) the birds are unrelated, (b) they are full sibs? (Assume that, if the subordinate bird leaves, the dominant will not find another partner.)

4. In *Tribonyx mortieri* (a Tasmanian moorhen), breeding groups consist of a male and an unrelated female, or of two males and an unrelated female. Pairs raise on average five offspring, and trios raise seven offspring. In trios, one of the two males is dominant, but the two have equal sexual access to the female. If the dominant drives out the subordinate, the latter does not find another mate. Would you expect the subordinate to be driven out if: (a) the males are unrelated; (b) the males are full sibs; (c) the males are half-sibs?

5. In red deer, males hold harems. Imagine that a female can recognize her full brother, and can join his harem. Would you expect her to do so if the viability of an offspring from a brother-sister mating is half that of an outbred offspring? Would you expect the male to accept her into the harem if she tried to enter? (Assume that a male can fertilize all the females in her harem.)

6.* In an (imaginary) species of *Polistes* (see Box 9.4), nests with two foundresses produce three times as many reproductive offspring as nests with one foundress. In joint nests, 80 per cent of the eggs are laid by the α female. Females mate only once. Joint foundresses were raised in the same nest. In a particular population, 30 per cent of all nests have two foundresses. At equilibrium, what is the coefficient of relatedness, r , between joint foundresses?

Computer Projects

A species of gull typically lays two eggs. The young have a probability P of fledging. If one egg is lost, the single surviving young is certain to fledge. A dominant gene A , if present in the first young to hatch, causes it to eject the second egg, and hence to be certain to fledge. Write an exact genetic simulation, for an infinite, random-mating population, and use it to find for what value of P the gene A will spread. Does it depend on the frequency of A ? Compare the simulation results with the predictions using inclusive fitness. (Start with frequencies of AA , Aa , and aa among adults, which need not be in Hardy-Weinberg ratio. Set up the mating table, listing first and second young to hatch separately, and follow the fate of all the offspring.)

Chapter 10— The Evolution of Prokaryotes

The evolution of gene function	<u>185</u>
Phages, plasmids, and transposable elements	<u>187</u>
The evolution of phages and their hosts	<u>189</u>
The evolution of plasmids	<u>190</u>
Plasmids conferring resistance to drugs and antibiotics	<u>190</u>
Plasmids producing proteins that kill other bacteria	<u>191</u>
The F plasmid	<u>191</u>
The evolution of transposons	<u>192</u>
The population genetics of <i>E. coli</i>	<u>194</u>
Geographic variation, and variation between hosts	<u>194</u>
Populations from a single host	<u>194</u>
Plasmids in natural populations	<u>195</u>
The evolution of viruses	<u>195</u>
Further reading	<u>198</u>
Computer projects	<u>199</u>

The prokaryotes are cellular organisms which lack a nucleus, and whose DNA exists as a circular molecule. They belong to two major kingdoms, the eubacteria, including most bacteria and blue-green algae, and the archaebacteria, including methane-producing bacteria, and bacteria living in hot springs and highly saline environments. They lack a sexual cycle involving meiosis and gametic fusion, but there are a number of other ways in which DNA can be transferred from one cell to another. Most of this chapter is concerned with these processes and their evolutionary consequences. However, in the first section I describe experiments aimed at altering the function of single genes. These experiments were performed on bacteria because of the practical advantages these organisms offer, but the processes they reveal may well go on also in eukaryotes.

The Evolution of Gene Function

The prokaryotes offer unique opportunities to study the evolution of new functions in the laboratory, because of the very large numbers of individuals that can be maintained (10⁹ cells per ml), the short generation time (≅ 30 min), and the possibility of selecting the one individual out of many millions that has the required phenotype. Several studies have been made of the acquisition by bacteria of the ability to use unfamiliar substrates. Clarke (in Bendall 1983) has studied the growth of *Pseudomonas aeruginosa* on various amides as sole nitrogen source. Growth depends on the action of an amidase in hydrolysing amides to produce ammonia:

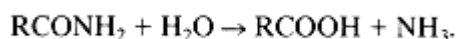

The wild-type enzyme can hydrolyse the 2-carbon amide, acetamide (CH₃CONH₂), and the 3-carbon amide, butyramide, but not the 4-carbon amide, butyramide, or more complex amides. By selecting on a medium in which butyramide was the sole nitrogen source, a strain B6 was obtained that could grow on this medium. This

strain has a mutant enzyme differing by a single amino-acid substitution from the wild-type. Using B6 as a starting point, further strains were obtained that could grow on other amides, including phenylacetamide. Two points are worth noting. First, several different evolutionary pathways were found, all ending in enzymes able to hydrolyse phenylacetamide, but differing in thermal stability and in other ways: an adaptive problem need not have a unique solution. Secondly, the mutant enzymes had lost most, and in some cases all, of their activity for acetamide, the substrate of the wild-type enzyme.

Typically, bacteria do not produce an enzyme specific for a particular substrate unless that substrate is present in the medium: to do so would be wasteful. Instead, the presence of the substrate induces the synthesis of the corresponding enzymes, as first demonstrated for the *lac* operon of *E. coli* by Jacques Monod and François Jacob. Hence, to grow on a new substrate, a bacterium must have an enzyme able to catalyse that substrate, and the enzyme must be induced by the substrate. The experiments on amidases were performed on strains 'constitutive' for the enzyme: that is, mutant strains that produced the enzyme without being induced. However, in further experiments a strain was produced that could grow on butyramide, and was induced by it. The history of this strain is shown in Fig. 10.1.

After obtaining strain 3, which was constitutive and possessed amidase B, two further steps were needed. First, genetic recombination with the original wild-type strain gave strain 4, which was induced by acetamide (like the wild-type), but had amidase B (like strain 3). This new strain could no longer grow on butyramide: it had the necessary enzyme, but was not induced. Further selection for growth on butyramide produced a number of constitutive mutants (i.e. reversion to the state of strain 3), and one mutant that was induced by butyramide. Thus it was possible to produce a strain that had the new enzyme, appropriately regulated.

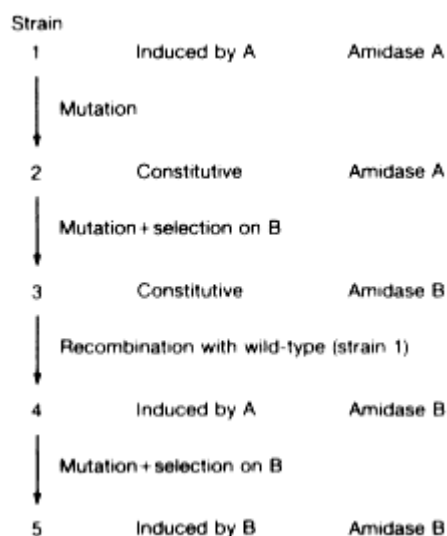

Figure 10.1

The history of a strain of *Pseudomonas* able to grow on butyramide, and induced by it (after P.H. Clarke, in Bendall 1983).

Similar experiments have been performed on other bacteria, for other enzyme functions. *Klebsiella aerogenes* selected for growth on ribitol responded, not by mutations improving the efficiency of the enzyme, but by duplicating the gene, and so increasing the amount of enzyme synthesized. The ability of *E. coli* to utilize lactose depends on the enzymes coded for by the *lac* operon. When the structural genes were deleted, and selection for growth on lactose applied, evolution took place in another operon, *EBG*, which previously had performed no essential function.

It is clear, then, that selection can alter the specificity and control of genes coding for enzymes. It may well be that, in nature, the common way in which bacteria acquire new metabolic abilities is by acquiring a plasmid carrying the relevant genes, and not by mutation in genes already present. This process is discussed later in the chapter. However, all genes, whether or not introduced by a plasmid, must at some time have acquired their present functions by mutation, recombination, and selection, and the experiments described in this section illustrate that process.

Phages, Plasmids, and Transposable Elements

This section gives a brief description of the parasites and symbionts that are relevant to an understanding of prokaryote evolution, and defines a number of useful terms.

1. **Bacteriophages**, or **phages** for short, are viruses parasitic in bacteria. When outside the cell, they consist of a DNA (or occasionally, a single-stranded RNA) core, surrounded by a protein coat that protects the DNA, and helps to introduce it into a new host cell. Once inside a cell, the phage DNA redirects the host metabolism into the synthesis of new virus particles, which are released on the death of the host cell, and which must then infect a new host. This cycle is known as the **lytic cycle**. In **virulent** phages, only the lytic cycle occurs. In contrast, the DNA of **temperate** phages can be inserted into the host chromosome as a **prophage**. It then replicates with the host: no new virus particles are produced, and the host cell is not damaged. A bacterium carrying a prophage is said to be **dysogenic**. Such a cell is immune to further infections by the same type of phage. Occasionally, a prophage is induced to enter the lytic cycle.

2. **Plasmids** are extra-chromosomal circular DNA molecules. They differ from phages in that they do not have an extra-cellular stage in their life cycle, and hence do not have genes coding for coat proteins. A major distinction is between **conjugative** plasmids, which cause effective contact to take place between their host cell and other cells, usually by the production of long thread-like pili extending from the cell wall, and non-conjugative plasmids.

Conjugation enables copies of a plasmid to pass to another cell. Some plasmids are non-conjugative but **mobilizable**, in that they can pass to another cell if conjugation is caused by another plasmid. For obvious reasons, a plasmid that is both conjugative and mobilizable is said to be **self-transmissible**.

3. **Transposable elements, transposons**, are pieces of DNA that can transpose from one site in a chromosome or plasmid to another. Two points about transposition are important. First, when a copy of a transposon is inserted at a new site, the original copy usually remains at the old site: transposition is therefore a form of replication. Secondly, although transposition involves the breaking and rejoining of DNA, it does not require sequence homology between the transposon, and the chromosome: in this respect it differs from the homologous recombination that causes crossing over between chromosomes in both prokaryotes and eukaryotes. Transposons are typically several thousand bases long, and often carry antibiotic-resistance genes. **insertion sequences** are shorter transposable elements, of approximately 1000 bases.

The widespread occurrence of phages, plasmids, and transposons means that pieces of DNA are rather readily transferred between bacteria, even between rather distantly related bacteria. This raises two questions about the reality of, say, *Escherichia coli* as a species.

First, suppose that we could, in imagination, trace the ancestry of the genes present in *E. coli* today back for a million years, or for 50 million years. Would these ancestral genes be found in a single kind of bacterium? Alternatively, would they be found in many different, unrelated bacteria? If this question was asked, not of *E. coli*, but of the house mouse, the answer is that all, or almost all, the genes would be found in a single ancestral species (although, if we went back 50 million years, that ancestor would not be a mouse). One reason for thinking this is that phylogenies based on the amino-acid sequences of different proteins give, at least approximately, the same tree. The answer is less obvious for *E. coli*. Some present-day genes have, in all probability, come from different and unrelated ancestors. But the majority have probably been together for a long time. Perhaps the strongest evidence for this is the close similarity between the linkage maps of *E. coli* and *Salmonella typhimurium*, which could hardly be so if horizontal transfer of genes was a common event in evolution.

The answer to our first question, then, is that many, and perhaps most, of the genes of *E. coli* have been together for a long time, although some have recently been acquired via phages or plasmids. A second question is as follows. Do all *E. coli* belong to a single species, separate from other species, as mistle thrushes belong to a species separate from song thrushes, fieldfare, and redwings? The answer is probably no. Thus a related 'species', *Shigella*, is distinguished from *Escherichia* by the fact that it causes dysentery, but DNA hybridization suggests

that some *E. coli* are more similar to some *Shigella* than they are to other *E. coli*. This is not surprising: in the absence of sexual reproduction, there is no reason to expect organisms to fall into well-defined species (see p. 267).

The Evolution of Phages and their Hosts

Bacteria can evolve resistance to attack by particular phages in three ways:

1. Exclusion: change in the bacterial surface prevents entry of the phage. Phage mutants that overcome such exclusion can occur.
2. Restriction: restriction endonucleases are enzymes that cleave DNA at particular sites, specified by short sequences of 4-6 nucleotides. These enzymes have been widely exploited by molecular biologists. Again, phages can evolve resistance to particular endonucleases. Just as vertebrates must not make antibodies against their own tissues, the host bacterium must not succumb to its own enzymes: one of the ways in which this is achieved is by the action of further enzymes that methylate specific cleavage sites.
3. Incompatibility: replication of the foreign DNA is slowed down or stopped.

The coevolution of virulent phages and their hosts is not in principle hard to understand. Genes in the host that confer resistance will spread if phages are present: there is, however, evidence that resistance genes lower fitness in the absence of phage, so they will not become fixed in the host population. At the same time, phage genes that overcome resistance will be favoured. The result will be an evolutionary arms race. The evolution of temperate phages is more puzzling. A bacterium may gain some benefit from the presence of prophage. Most obviously, it gains protection against further infection by the same phage. Some phages carry genes for antibiotic resistance, or other traits favourable for the host. It is common to find that some advantage is conferred on the host, even when no specific mechanism is known: for example, in a chemostat experiment phage λ was found to confer a selective advantage on *E. coli* of 3 per cent per hour. Hence, we would not in general expect to find host genes that resist the integration of the phage.

But why should phage genes evolve that mediate integration into the host chromosome? Would not the phage increase in numbers more rapidly if it remained in the lytic cycle? The answer is clearly yes, but only if the local density of bacteria is high. If host density is low, a prophage that was induced to enter the lytic cycle would kill its host, but none of the daughter particles might find a new host. There are good theoretical reasons, therefore, to expect that temperate phage should be integrated as a prophage when host density is low, and enter the lytic cycle at high densities. As yet, little evidence exists to test this prediction. We shall meet other cases in which we would expect host density to be important in the next section.

The Evolution of Plasmids

In general, it is best to think of phages as parasites, and plasmids as endosymbionts which survive by benefiting their hosts. It is in principle possible for a self-transmissible plasmid to maintain itself in a bacterial population, even though it lowers the fitness of the host cell, but in fact most plasmids carry genes that benefit their hosts, for example by conferring resistance to antibiotics, drugs, or heavy metals, by producing toxins, by coding for restriction enzymes, or by utilizing novel substrates.

We can therefore expect selection on both host and plasmid genes to favour the regular transmission of plasmids to daughter cells at cell division. Plasmid copy number is in fact regulated: in some there are 1-2 copies per cell, and in others 10-100. Even in the former kind, daughter cells usually receive a copy: the frequency with which plasmid-free cells arise after cell division is as low as 1 in 10^6 .

Three kinds of plasmid will be discussed in more detail:

Plasmids Conferring Resistance to Drugs and Antibiotics

These plasmids are usually self-transmissible. They are formed (Fig. 10.2) by the union of a 'resistance transfer factor', or RTF plasmid, carrying the genes needed for conjugation and replication, and an 'r-determinant', consisting of an insertion element and genes determining drug resistance.

The spread of these plasmids has been the most dramatic, and from a human point of view the most damaging, evolutionary event of recent years. Bacterial strains isolated before 1940 have plasmids, but none carrying antibiotic resistance. When R plasmids were first discovered by T. Watanabe in the late 1950s, most carried only one or two drug resistances. Today, it is typical to find four or five drug resistance genes carried by a single plasmid. This shows how bacteria can evolve rapidly to meet changed circumstances by acquiring plasmids. R-plasmids have evolved recently by the insertion of resistance genes into pre-existing plasmids.

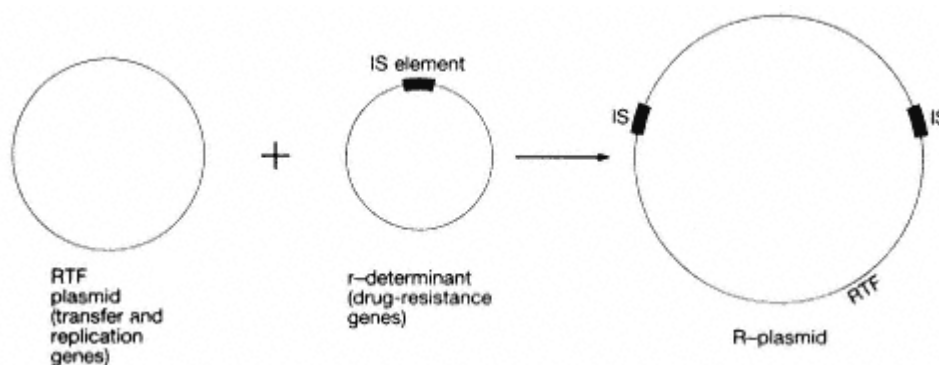

Figure 10.2
The origin of a drug-resistant plasmid.

However, there is no reason to think that the resistance genes themselves have originated since 1940. Antibiotics are produced naturally by other organisms as weapons in inter-specific competition, and genes giving resistance to them are probably ancient. The existence of plasmids means that such genes can be acquired by bacteria that need them.

It is not only antibiotic resistance that can be acquired in this way. Bacteria such as *Pseudomonas* that can utilize a wide range of substrates often acquire the necessary enzymes from plasmids.

Plasmids Producing Proteins that Kill other Bacteria.

ColE1 is a plasmid that codes for a 'colicin' that kills other bacteria. It is mobilizable, but requires the presence of a conjugative plasmid, such as the F plasmid described below, before it can transfer to a new cell. In most cells, the colicin-producing gene is repressed, and a gene that produces a protein protecting the cell against colicins is switched on. Colicin production can be induced, for example by UV light. When this happens, the cell is killed, and colicins are released. These kill other bacteria that do not carry the plasmid: bacteria with the plasmid are protected.

This is an entertaining example of kin selection. A colicin gene that is expressed kills its host and itself, but in so doing kills other bacteria that do not carry an identical gene. Clearly this is advantageous only if there is resource competition between the bacteria. At high densities, the death of competing bacteria leads to increased multiplication of the survivors. Hence a gene that produces colicins has two effects: it destroys itself, but it increases the multiplication of bacteria carrying identical copies of itself. The net effect may be to increase the number of copies of the gene. But this will be true only at high densities. As in the case of temperate phages entering the lytic cycle, we can expect the induction of colicin production to be influenced by population density, but evidence is lacking.

The F Plasmid

The F plasmid is a conjugative plasmid that has been of particular interest to geneticists because it can mediate recombination between bacterial genes. Its life cycle is shown in Fig. 10.3. F⁻ cells lack the plasmid. In F⁺ cells the plasmid is present as a separate DNA circle. If F⁻ and F⁺ cells are mixed, conjugation takes place, and copies of the plasmid enter the F⁻ cells, which become F⁺. At first sight, therefore, it seems puzzling that most *E. coli* in nature are F⁻. The explanation seems to be that expression of the genes mediating conjugation, and in particular the production of pili, is costly to the bacterium. At low densities, therefore, F⁺ bacteria are at a selective disadvantage. In fact, in bacteria carrying conjugative plasmids, the genes mediating conjugation are repressed much of the time.

Occasionally, the F plasmid is integrated into the bacterial chromosome, to give

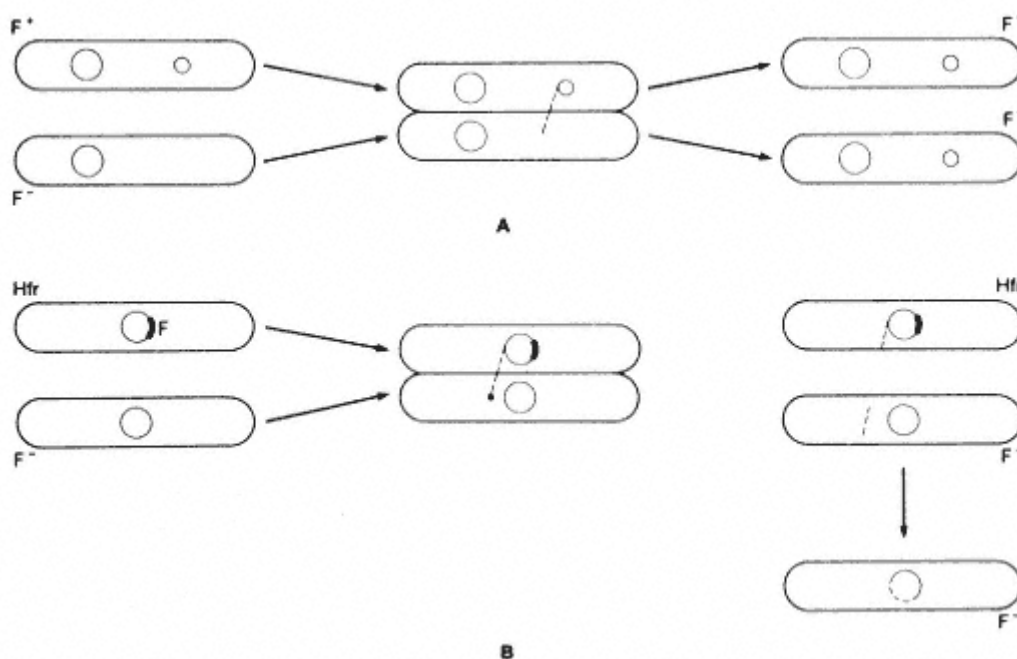

Figure 10.3

The life cycle of the F plasmid. **A** Conjugation between F^+ and F^- bacteria: both exconjugants are F^+ . **B** Conjugation between Hfr and F^- bacteria: the F^- ex-conjugant remains F^- but its chromosome contains regions from both original conjugating bacteria.

an Hfr ('high frequency of recombination') cell. If conjugation occurs between an Hfr and an F^- cell (Fig. 10.3), a small part of the F plasmid, together with part of the bacterial chromosome, enters the F^- cell. It is rare for the whole of the F plasmid to be transmitted, so the F^- cell remains F^- . After conjugation, however, the F^- cell contains its own original bacterial chromosome, and a substantial part of the donor chromosome. Homologous recombination then occurs, giving rise to a new bacterial chromosome, carrying genes from both the F^+ and the F^- cell. The residual chromosome fragments are lost.

The evolutionary significance of these events is unclear. Their relevance to bacterial evolution is considered on pp. 196-7. Here we will note only that conjugation by Hfr cells confers no advantage on the genes of the F plasmid, which are not transmitted.

The Evolution of Transposons.

The number of copies of an insertion sequence can increase in one of three ways:

1. increase, by transposition, of the number of copies in a given replicon (i.e. bacterial chromosome or plasmid);

2. transfer, by transposition, to a new replicon; and 3. increased multiplication of the replicon in which it is inserted.

A high copy number per replicon does not in itself increase the chances of long-term survival of the element, and may reduce it if the fitness of the replicon is reduced by the presence of many copies of the element. It is therefore not surprising that transposons carry genes regulating their own copy number. (The selective forces affecting copy number may be more complex, and more interesting, than this case; see Box 10.1.) The mechanism in IS50 is ingenious. The element has two

Box 10.1—

Natural selection on transposition rate

It seems likely that selection on a transposon can alter its overall rate of transposition, but probably not the precise sites to which it is transposed: this would be the case for the mechanism of regulation in IS50. For reasons given in the main text, we would expect selection to reduce transposition rate as copy number increases, essentially because high copy number reduces the fitness of the host organism. There will, however, be counter-balancing selection for increased transposition, because of the potential advantages of insertion into a new replicon. Actual transposition rates will reflect a balance between these two selective forces.

This balance may work out differently in prokaryotes and eukaryotes. Consider first the extreme case of a bacterium with no plasmids or phages, and lacking recombination. Selection would tend to reduce the transposition rate almost to zero, because there is never a second replicon in the cell to which the transposon might move. In the real world, there will be selection for non-zero transposition rates, because there is often more than one replicon per cell (chromosome + plasmids), and, probably less important, when conjugation leads to recombination between bacterial chromosomes, a transposon is more likely to be present in the recombinant chromosome if it is initially present in several copies. However, the balance of selective forces seems to have favoured restricted transposition rates, and transposons that enhance the fitness of their hosts.

Contrast this with the situation in eukaryotes. Consider a transposon present in a single copy in a zygote. The number of next-generation zygotes to which it is transmitted can be increased by transposition in two ways. Transposition to a different chromosome will increase the proportion of gametes carrying it. So with transposition to a different site in the same chromosome, if crossing over takes place between the new and old sites. For this reason, selection favouring high transposition rates is strong. This makes sense of the fact that transposons usually confer fitness benefits on their prokaryote hosts, but seem, on what little evidence we have, to lower the fitness of eukaryotes.

This argument is speculative, but suggests further questions. For example, how do transposons behave in asexual eukaryotes?

regulating genes. One, which codes for a protein that activates transposition, *isI*-acting: that is, it activates only the element of which it is part. The second codes for a diffusible inhibitor of transposition. Hence, as copy number increases, the local strength of activation remains constant, but of inhibition increases: this results in self-limitation of copy number.

If, as seems plausible, selection on IS elements will lead to self-regulation of copy number, and if, as is certainly the case, IS elements are often linked to genes conferring an advantage on the host cell, then there is no selection on the host to evolve resistance to transposition, and such resistance is not observed.

The Population Genetics of *E. coli*

E. coli inhabits the lower intestine of warm-blooded vertebrates. In this section, I review data on the genetic variability and population structure of natural populations.

Geographic Variation, and Variation Between Hosts

Genetic variation in surface antigens, and in the electrophoretic properties of enzymes, have been studied from different parts of the world, and from different hosts. Of 20 enzymes studied, 18 were polymorphic, with from 2 to 19 alleles per locus. This indicates that *E. coli* genes are substantially more variable than human ones. Clones isolated from humans and other animals did not differ significantly. Most of the genetic variability is contained within samples from a single locality.

An important question concerns the role of genetic recombination. If recombination is frequent, we would expect genotypes to occur approximately in linkage equilibrium (p. 82). This is not what is found. Thus, of the 109 strains in which the 20 enzymes mentioned above were recorded, three pairs of clones of electrophoretically identical type were found in geographically distant locations, and seven more pairs were found that were identical except for one locus. Given the observed degree of genetic variability per locus, the chance of finding even a single pair of clones that were identical is small, unless the two clones are derived from a common ancestor without recombination. Since the members of a pair were geographically distant, this implies that clones are long-lasting and widely distributed. However, DNA sequencing has shown that horizontal transfer of chromosomal DNA fragments between strains of *E. coli* is relatively frequent. The most likely mechanism for such transfer is **transduction**, a process in which a phage accidentally incorporates host DNA, and transfers it to a new cell, where it may be incorporated into the chromosome by recombination.

Populations from a Single Host

In a heroic experiment, 550 clones were isolated from a single human over a period of 11 months. In all, 53 distinct electrophoretic types were identified. Of

these, two were present for most of the period; the others were transient, appearing for a few weeks only. This means that the host was repeatedly infected by new clones, most of which failed to establish. As in the study of geographical variation, there was no evidence of genetic recombination.

Plasmids in Natural Populations

Most *E. coli* in nature carry plasmids. In all, over 250 different plasmids have been identified. Some carried drug resistance genes, or other genes conferring recognizable phenotypes, but most were cryptic, in the sense that they produced no detectable phenotypic effect: of course, this does not mean that they had no effect.

The picture, then, is of a highly variable population, with little geographic or host-specific differentiation, and consisting of a large number of long-lasting clones. The ubiquity of plasmids, and the wide range of functions they are known to perform, shows their importance in the adaptation of *E. coli* to particular environments.

The frequency of horizontal gene transfer varies greatly between different types of bacteria. It is particularly common in species such as *Bacillus*, *Streptococcus*, and *Neisseria*, which are competent for **transformation**, a process in which DNA is actively taken up from the surrounding medium and incorporated into the chromosome. Usually there is selective uptake of DNA with a particular species-specific recognition sequence, which is widely distributed on the chromosome of the species in question, thus ensuring preferential uptake of homologous DNA.

The Evolution of Viruses

One example of viral evolution has already been discussed. In Box 9.5, I described the evolution of the myxoma virus. In doing so, I took as the measure of fitness the reproductive rate R of a virus infecting a rabbit, defined as the number of additional rabbits infected by viruses from that rabbit. Such a definition ignores selection between viruses in the same rabbit. It is therefore only justifiable if, typically, a rabbit is infected by only one clone of viruses, and if mutation does not generate new variation too rapidly. This section discusses a quite different problem in viral evolution, in which it is essential to take into account differences between viruses in a single cell population. This is the evolution of **multi-compartment** viruses.

The genome of many plant viruses is of single-stranded RNA. Some of these are multicompartiment viruses: that is, a single type of protein capsule encloses one of two different genomes A and B . These genomes have complementary functions: for example, one may code for the capsule protein, and one for an RNA replicase. If growth is to take place, therefore, a cell must be infected by at least one particle of each kind.

Why should such an odd state of affairs have evolved? One suggestion is that it makes possible recombination between different A and B genomes, and so confers a long-term advantage on the population. However, Nee (1987) has suggested a much simpler explanation, in terms of selection operating within a viral population. He imagines that the original state was a complete virus C , carrying both A and B genes. Mutation would give rise to incomplete viruses I , carrying a functional A gene and a non-functional B gene, or vice versa, and also to junk viruses J , carrying no functional genes. In a population of C , I , and J viruses, C viruses would have a selective advantage, because each C virus is certain to replicate if it enters a cell, whereas an I virus will replicate only if complemented by a virus carrying the other function, and a J virus only if complemented by viruses carrying both functions. If these were the only fitness differences, C would be the typical form, and I and J particles would be maintained by recurrent mutation, as deleterious mutations are always present in natural populations.

However, I and J also have a selective advantage, in being more likely to produce replicas belonging to the same class as themselves. Because of the low accuracy with which RNA is replicated, this may be an important effect. For simplicity, suppose that the A and B genomes contain the same number, n , of bases. If the error rate per base is u , the probability that an I virus will give rise to an I virus of the same kind is $(1 - u)^n$ and the probability that a C virus will give rise to C is $(1 - u)^{2n}$. We can probably ignore back mutation (that is, an I virus giving rise to a C), because, once a non-functional mutation has occurred, further mutations, including deletions, can occur without having any further deleterious effects. There may be additional fitness differences arising because C , I , and J viruses are replicated at different rates within a cell (the minivariant discussed in Chapter 1 can be thought of as a particle which, freed from any constraints imposed by the need to code for a protein, has evolved a sequence that is replicated particularly rapidly).

There is, therefore, a balance of selective forces. C viruses are always replicated, but with lower accuracy: I viruses need complementation, but are replicated with greater accuracy, and perhaps more rapidly. The evolutionary dynamics of a population of C , I , and J viruses is analysed further in Box 10.2. The crucial parameters turn out to be the accuracy of replication $Q = (1 - u)^n$ and the

Box 10.2—

The Evolution of Multicompartiment Viruses

For simplicity, suppose that the two kinds of incomplete virus, A and B , are identical in accuracy and rate of replication. They will then be present in equal frequency.

Let x_C , x_I , and x_J be the frequencies, in one generation, of C viruses, of each type of I virus, and of J viruses, respectively. Then $x_C + 2x_I + x_J = 1$.

Let $Q = (1 - u)^2$ be the accuracy of replication of an I virus. Let R be the probability that an incomplete virus is complemented. Let r be the probability that a junk virus is complemented.

Ignoring differences in replication rate, Table 10.1 gives the kinds and numbers of replicas produced by each viral type. Hence we can write down the following equations for the frequencies after one cell generation:

$$\begin{aligned}x'_C &= Q^2 x_C / T \\x'_I &= [Q(1 - Q)x_C + QRx_I] / T \\x'_J &= [(1 - Q)^2 x_C + 2(1 - Q)Rx_I + rx_J] / T,\end{aligned}\quad (10.1)$$

where T is the total number of copies. That is

$$T = x_C + 2Rx_I + rx_J. \quad (10.2)$$

Table 10.1

Evolution in multicompartiment viruses. Number of replicas of various types from complete (C), incomplete (A and B), and junk (J) viruses

Parental type	Offspring type				Total
	C	A	B	J	
C	Q^2	$Q(1-Q)$	$Q(1-Q)$	$(1-Q)^2$	1
A	—	RQ	—	$R(1-Q)$	R
B	—	—	RQ	$R(1-Q)$	R
J	—	—	—	r	r

Q is the probability that a single genome, A or B , will be replicated accurately. R is the probability that an incomplete virus, A or B , will be complemented; r is the probability that a junk virus will be complemented.

We now need to know R and r . Suppose that a total of N cells are infected by NM particles. M is the multiplicity. Consider an incomplete A virus. R is the probability that the cell it infects is also infected by a B or a C virus. The number of such viruses is $NM(x_C + x_I)$. The chance that any one of them does not infect a particular cell is $1 - 1/N$. Hence, if infection is random,

$$R = 1 - (1 - 1/N)^{NM(x_C + x_I)} = 1 - e^{-M(x_C + x_I)}. \quad (10.3)$$

If x_C is small, $r = R^2$; if x_C is not small, r is a little more difficult to calculate.

These equations are easy to simulate. Some results are shown in Fig. 10.4. They illustrate the general conclusion that complete viruses are eliminated

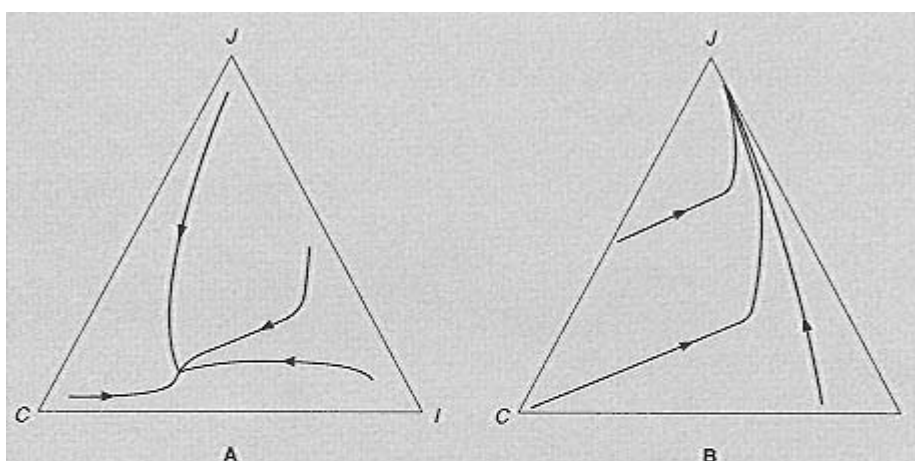

Figure 10.4 The evolution of multicompartiment viruses. **A** Multiplicity $M = 1$; accuracy of replication $Q = 0.9$. **B** $M = 10$, $Q = 0.5$. In case **A**, complete viruses, C , are present at equilibrium, but incomplete and junk viruses are also present. In case **B**, complete viruses are eliminated. The population evolves to the multicompartimental state.

if the multiplicity is not small, and if Q is not too high. This makes intuitive sense. High multiplicity increases the likelihood of complementation, and so favours incomplete viruses: a low accuracy of replication handicaps complete viruses.

number of particles infecting a single cell, called the **multiplicity of infection**, M . If a cell is usually infected by a single particle, then C is the typical form, and I and J are maintained by recurrent mutation (although they may be present in high frequency). But if M is not small, C viruses may be eliminated entirely from the population, leaving only I and J . In effect, a population of multicompartiment viruses will evolve. There is no need to invoke the advantages of recombination, or indeed any advantage to the population as a whole.

Further Reading

Clarke, P.H. (1983). In *Evolution from molecules to men* (ed. B.S. Bendall). Cambridge University Press.

Finnegan, D.J. (1985). Transposable elements in prokaryotes. *International Review of Cytology* **93**, 281-326.

Futuyma, D.J. and Slatkin, M. (ed.) (1983). *Coevolution*. Sinauer, Sunderland. (Particularly the articles by B.R. Levin and R.E. Lenski; J.A. Barrett; and R.M. May and R.M. Anderson.)

Hartl, D.L. and Dykhuizen, D.E. (1984). The population genetics of *Escherichia coli*. *Annual Review of Genetics* **18**, 31-68.

Selander, R.K. and Whittam, T.S. (1983). In *Evolution of genes and proteins* (ed. M. Nei and R.K. Koehn). Sinauer, Sunderland.

Computer Projects

1. Write a program to simulate the evolution of multicompartiment viruses, representing the results as trajectories in an equilateral triangle (or simplex), as in Fig. 10.4. Extend the results by simulating a case in which two types of incomplete virus, A and B , have different replication accuracies: for example, let them have accuracies Q_A and Q_B , and the complete virus an accuracy of $Q_A \cdot Q_B$. (You now have four variables, so you cannot plot all the necessary information in a triangle.)

Chapter 11— The Evolution of the Eukaryotic Genome.

The nature of the genome	<u>201</u>
The haemoglobin gene family	<u>203</u>
Duplication and the increase of DNA content	<u>207</u>
The ribosomal genes	<u>209</u>
Unequal crossing over and gene conversion	<u>210</u>
Repetitive DNA	<u>213</u>
The element copia in <i>Drosophila</i>	<u>213</u>
P factors and hybrid dysgenesis	<u>214</u>
The <i>Alu</i> sequences of primates	<u>215</u>
Highly repetitive DNA	<u>216</u>
The role of repetitive DNA in evolution	<u>216</u>
The evolution of chromosome form	<u>219</u>
Further reading	<u>223</u>
Computer projects	<u>223</u>

The Nature of the Genome

Before the structure and role of DNA was discovered, the eukaryotic chromosome was pictured as a series of genes strung together like beads on a string, with a centromere whereby it could be moved about during mitosis and meiosis. Genetic recombination was thought to occur by breaking and rejoining the string between the beads. With the discovery of DNA, the distinction between beads and string disappeared. The genes are arranged end to end, so that the whole chromosome is one immense DNA molecule, and recombination occurs within genes. However, the precise order of genes on the chromosome is probably not needed to enable them to function properly during development: one good reason is that, in *Drosophila* and many other organisms, extensive chromosome inversions have little or no effect on the phenotype. Genes are strung together to form chromosomes because otherwise they could not be properly partitioned during cell division.

One reason for doubting the correctness of this picture of the chromosome as a string of unique genes is the so-called 'C-value paradox'. Different species have strikingly different amounts of DNA per nucleus. Typical values are given in Table 11.1. Some of the differences make sense in terms of the complexity of the adult organism. For example, it is not surprising that there is more DNA in the nucleus of a human than of a nematode, or of a nematode than a yeast. But can it really require five times as much DNA to specify a newt than a man, or 500 times more DNA to specify a fritillary than a cress plant? DNA content per cell does have some phenotypic effects. In both plants and animals, cell size increases linearly with DNA content per nucleus, and cell cycle time also increases. But the need for larger cells (even if it exists) large cells may be the unselected consequence of a high DNA content) could be brought about without a corresponding increase in the number of unique genes.

Table 11.1 also gives estimates of the proportion of the DNA that codes for proteins. These estimates are based on identifying corresponding RNA molecules

Table 11.1

DNA content per haploid genome (data from Cavalier-Smith 1985)

	Genome size (pg)	Percentage of genome coding for protein
<i>Escherichia coli</i> (a bacterium)	0.0036 .005	~ 100
<i>Saccharomyces cerevisiae</i> (a yeast)	0.009	69
<i>Caenorhabditis elegans</i> (a nematode)	0.088	25
<i>Drosophila melanogaster</i>	0.18	33
<i>Homo sapiens</i>	3.5	9 7
<i>Triturus cristatus</i> (a newt)	19	1.5 .5
<i>Protopterus aethiopicus</i> (a lungfish)	142	0.4 .2
<i>Arabidopsis thaliana</i> (an annual weed)	0.2	31
<i>Fritillaria assyriaca</i> (a monocot)	127	0.02

1 pg of DNA corresponds to approximately 10^9 base pairs.

in the cytoplasm. They are not very accurate, because not all genes are expressed in all tissues, but they are probably of the right order. It is clear that in some organisms a large part of the DNA codes for nothing.

Much of the DNA in the genome is present in many copies. There are many different kinds of repeated DNA. A rough classification is as follows:

1. **Gene clusters.** Many proteins are present in an individual in several different forms, coded for by distinct but similar genes. An example, haemoglobin, is discussed below.
2. **Tandemly repeated genes** with identical functions. An example, discussed below, is the set of several hundred genes coding for ribosomal RNA.

Although interesting, these two types of repeated DNA do not substantially alter the picture of a chromosome consisting of a string of genes, each with a unique role. Gene clusters evolve, presumably, because of the need for several similar but not identical products. Tandemly repeated genes are a response to the need for a large amount of a particular product (or, in the immune system, of a large number of similar but not identical products). The next two categories, however, are not so easily explained in terms of the needs of the organism.

3. **Middle-repetitive, dispersed DNA.** These are DNA sequences, varying in length from a few hundreds to thousands of nucleotides, usually present in only tens or hundreds of copies per genome, and dispersed throughout the genome, often with only a single copy at each site.

4. **Highly repetitive DNA.** These are short sequences, each present in very large numbers, often in tandemly arranged blocks. A particular sequence may be present on all chromosomes, but be concentrated in particular regions, for example near the centromere.

The presence of the last two kinds of repetitive DNA raises two questions:

1. Is repetitive DNA present because it increases the fitness of the individual organism, or is it in effect parasitic, as suggested by Doolittle and Sapienza (1980) and by Orgel and Crick (1980)?
2. How does the 'concerted evolution' of repetitive DNA occur, so that one species comes to have many copies of sequence A, whereas a closely related species has many copies of a slightly different sequence, B?

The Haemoglobin Gene Family

In vertebrates, oxygen is transported in the blood bound to a protein, haemoglobin. The protein is tetrameric. In adult humans, it is formed of two α and two β peptides: in fetal humans of two α and two γ peptides: and in embryos, of two ϵ and two ζ peptides. The tetrameric structure facilitates reversible combination with oxygen. The presence of three distinct proteins also makes functional sense, in terms of the different oxygen requirements of adult, fetus, and embryo, and the need to transfer oxygen across the placenta.

All the peptides have common features, in amino-acid sequence and tertiary structure, sufficient to indicate that the genes coding for them have a common origin, and have arisen by the duplication of a single original globin gene. As we shall see, study of the genes themselves confirms this view. In humans, the genes are arranged in two clusters, the α and β clusters, on different chromosomes. Figure 11.1 shows the human β cluster, and, for comparison, the cluster in mouse and rabbit. The following features are important:

1. Each structural gene consists of three **exons** and two **introns** (Fig. 11.2). An RNA transcript of the whole gene is made, but the two sections homologous to the introns are spliced out before the mRNA passes to the cytoplasm, where it is translated. Thus, only the exons code for the amino-acid sequence of the peptide. Introns occur in all the structural genes, in both α and β clusters, at exactly homologous positions. Introns are typical of structural genes in eukaryotes. There are two possible views about their origins. One is that introns are degenerate transposable elements (see p. 188), which were inserted into the gene in the very distant past, but which have now lost the capacity for trans-

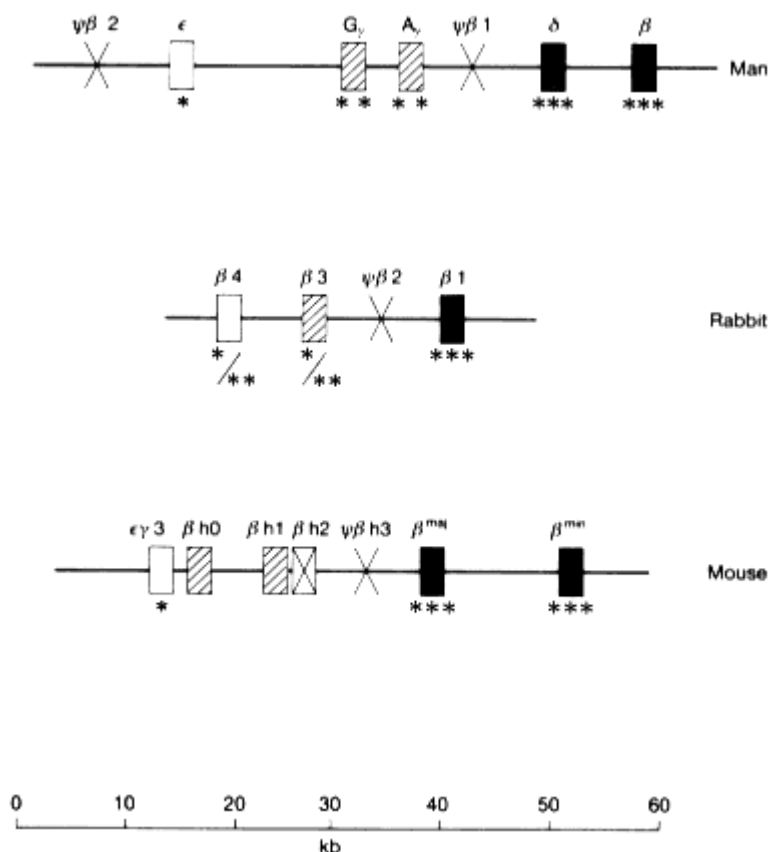

Figure 11.1

The β -haemoglobin gene cluster (after Jeffreys *et al.*, in Bendall 1983).

■ genes homologous to the human β ; □ genes homologous to the human ϵ ;
 ▨ genes homologous to the human γ ; ▩ pseudogenes. Stages of expression:
 *, embryonic; **, fetal; ***, adult. Scale bar is in kb (that is, base pairs $\times 10^{-3}$).

position. The only sequence specificities they have retained are the terminal sequences that make splicing-out possible: the loss of these would be lethal for the organism, and hence for the intron itself.

An alternative view, suggested by Gilbert (1978), is that the exons represent ancestral 'minigenes', coding for small but functional peptides, and that modern genes arose by the bringing together of several such units. The idea is attractive. If it is correct, we would expect each exon to code for a different functional region of the protein.

2. In addition to the functional genes, there are **pseudogenes**. These have sufficient sequence homology, and the same exon-intron arrangement, to show that they have arisen by the duplication of functional genes. However, they contain frame-shift mutations that make it certain that they are not translated

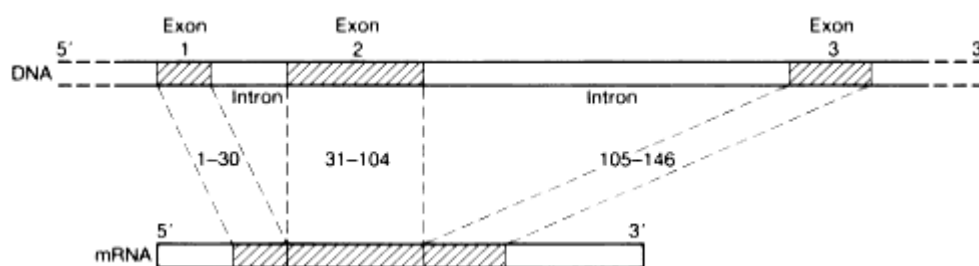

Figure 11.2

The mouse β -globin gene, and its messenger RNA (after Phillips *et al.*, in Bendall 1983).

to functional peptides. They are 'fossil' genes that have lost their function. They diverge rapidly in sequence: the genome may contain many pseudogenes that have diverged so far that they can no longer be recognized.

The genome contains a secondary category of pseudogene differing from those in the β -haemoglobin cluster in two ways: they lack introns, and are unlinked to the functional genes to which they are homologous. They are thought to have arisen by reverse transcription from mRNA, followed by insertion into the chromosome.

3. The exons and introns each make up about 8 per cent of the DNA in the cluster. The remaining 84 per cent, consisting of a mixture of unique and repeated sequences (including an Alu sequence see below), is of unknown function. Surprisingly, however, it diverges rather slowly in nucleotide sequence, at some 20 per cent of the rate of introns and silent sites in coding regions (see p. 149).

Figure 11.3 gives a phylogenetic tree of the human globin genes, since the original α - β duplication some 500 million years ago. This event can be dated from the fossil record. Thus hagfish and lampreys and therefore, presumably, the ancestral jawless vertebrates have a monomeric haemoglobin, whereas bony fish and tetrapods have α and β peptides. The duplication, therefore, must have taken place after the origin of the jawed vertebrates, but before the split between the ancestors of the tetrapods and of the bony fishes: this gives us a date of about 500 million years. The other dates in this figure are based on the assumption that the different genes arose by duplication at the nodal points, and have subsequently diverged at a constant rate: for example, a figure of 200 million years implies a number of substitutions about 2/5 of that separating the α and β chains.

In fact, the assumptions on which Fig. 11.3 is based turn out to be false in at least one respect. The difference in sequence between the two human γ genes is small, suggesting a very recent origin of the duplication. Yet we know that this duplication must be at least 40 million years old. It is present in the great apes and Old World monkeys, but absent in New World monkeys and lemurs, giving a date of 40 million years or more. The explanation is probably as follows. The duplica-

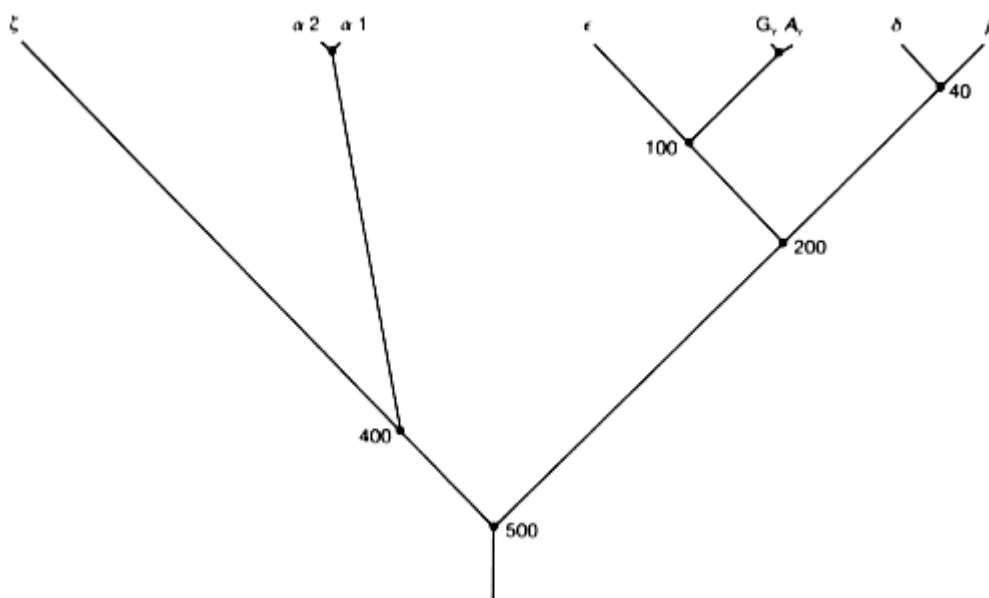

Figure 11.3

The phylogeny of the human haemoglobin genes (after Jeffreys *et al.*, in Bendall 1983), showing the estimated times of divergence in millions of years. The value of 500 MY for the duplication giving rise to the α and β genes is deduced from the fossil record. The other values are deduced from divergences in amino-acid or DNA sequences, as fractions of the divergence between the α and β chains.

tion did indeed take place some 40 million years ago, but in the human lineage a recent recombinational or gene-conversion event has homogenized the sequences. This possibility of homogenization means that we must treat phylogenies of the kind shown in Fig. 11.3 with caution.

The lower vertebrates provide more direct evidence that the α and β genes did indeed arise by duplication. In the toad *Xenopus tropicalis* the α and β genes are closely linked, as would be expected on the duplication hypothesis. How did they come to be on separate chromosomes in mammals? One possible explanation is that a chromosome doubling event (allopolyploidy) took place during the origin of the mammals, giving rise to two α - β clusters. If the α gene was silenced in one of these clusters, and the β gene in the other, this would give rise to unlinked α and β genes, each of which could then diversify by further duplications. As it happens, something of this kind has recently happened in the genus *Xenopus*: the tetraploid species, *X. laevis*, has two unlinked α - β clusters, which have already undergone some functional differentiation.

There are haemoglobins in various invertebrates (including some annelids, insects, and molluscs). More surprising, leguminous plants (and several unrelated flowering plants) have a haemoglobin which acts to reduce oxygen pressure in the nitrogen-fixing root nodules. The gene coding for this leghaemoglobin has the two

introns characteristic of vertebrate haemoglobin, and an additional third intron. Does this mean that haemoglobin has evolved independently in plants and animals (if so, why the same introns?), or that it was present in the common ancestor of plants and animals (if so, why has it been lost from most animals and plants?), or that the gene has been transferred horizontally from animals to plants? Further work on the invertebrate and plant haemoglobins should answer these questions.

Duplication and the Increase in DNA content

The DNA content, and in particular the amount of coding DNA, has increased during evolution. Where has the additional DNA come from? There are, in principle, two possible answers: by duplication of pre-existing DNA, followed by sequence divergence, or by the *de novo* synthesis of sequences not homologous to any pre-existing DNA. We have no reason to think that the latter process occurs. However, effectively random sequences that could subsequently be programmed by selection could arise by duplication followed by a frame-shift mutation.

Duplication can happen in several ways:

1. **Unequal crossing over.** Figure 11.4 shows how unequal crossing over can lead to the production of tandemly arranged copies of the same DNA sequence. We have already seen evidence for the existence of such tandem copies in the haemoglobin gene family. Unequal crossing over can also give rise to repeated segments within a gene. An extreme example is the gene for collagen. The $\alpha 2(I)$ collagen gene from the chicken is approximately 38000 nucleotides long, has more than 50 introns (the largest number so far observed), and is largely composed of a (slightly variable) repeated sequence of nine bases, coding for glycine-X-Y, where X and Y are often prolines. When thinking about the evolution of highly complex repeated sequences, whether the repeats are of whole genes or parts of genes, it is important to remember that, once crossing over has given rise to a tandem repeat, further duplication events are more likely, because chromosomes can pair 'out of register' (see Fig. 11.4).

2. **Transposition.** A DNA sequence is replicated, and the copy is inserted at a new site in the chromosome. This sometimes involves transcription to RNA, and reversed transcription to DNA, before insertion.

3. **Polyploidy.** If chromosome replication takes place without cell division, the result is a tetraploid cell. As explained in Chapter 14, this is more likely to give rise to a fertile tetraploid if it happens in a diploid species hybrid. An example of tetraploidy in the toad *Xenopus*, was discussed in the last section. It has also happened in two groups of bony fish, the Cyprinidae and the Isospondylidi: some evidence is given in Table 11.2.

For some enzymes, the $4n$ species have more distinguishable loci than the $2n$ species. For example, *Salmo* has two distinguishable loci coding for SDH, and four

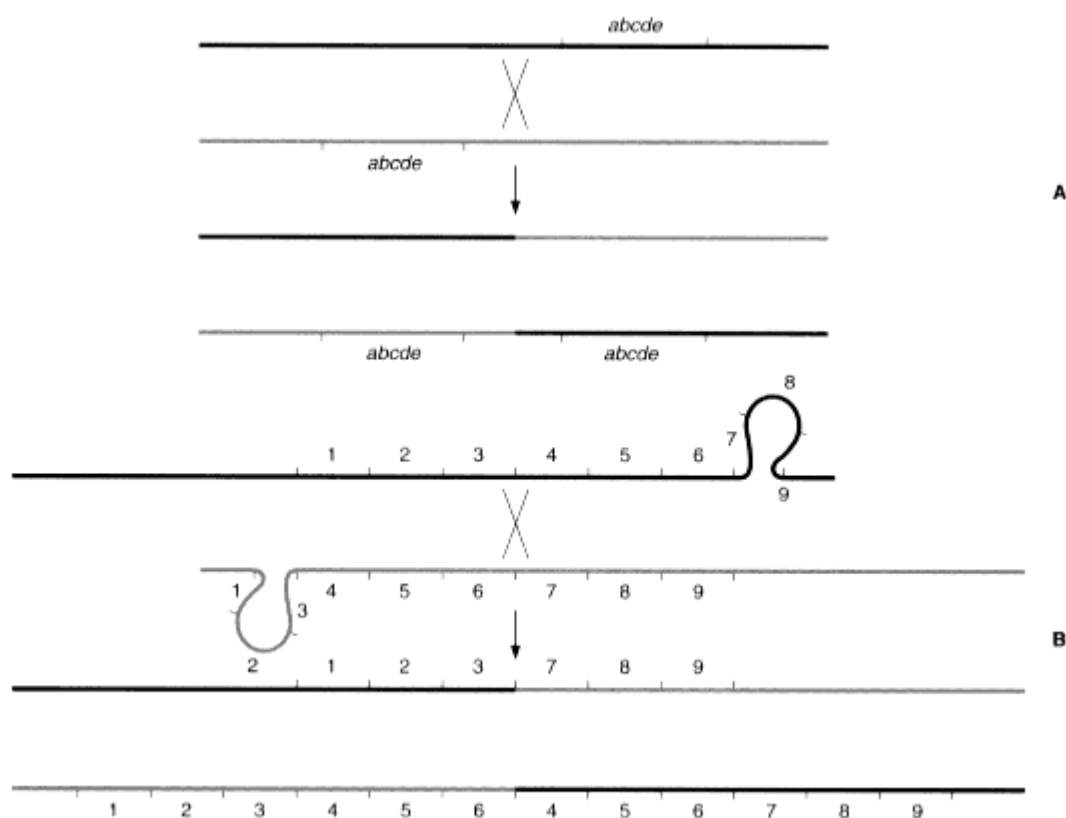

Figure 11.4

Unequal crossing over. **A** Origin of a tandemly arranged DNA sequence, *abcde*. In **B**, two chromosomes each carry nine tandemly arranged copies of the same sequence. They pair out of register, and crossing over gives rise to a chromosome with six copies, and one with 12 copies.

for LDH, compared to one and two loci, respectively, in its $2n$ relatives. However, there is one distinguishable 6-PGD enzyme, and three α -GPDH enzymes, in both diploid and tetraploid isospondylids. This may be because the duplicated loci have not diverged sufficiently for their products to be distinguished by electrophoresis, or because one of the duplicates has been inactivated by nonsense mutations.

It is worth listing the possible fates of a duplicated locus:

1. One copy may be inactivated.
2. The two loci may diverge, while maintaining the same basic functions, as has happened in the haemoglobin gene family.
3. The two loci may acquire different functions, while retaining a similar three-dimensional structure, and some degree of amino-acid homology. It is not easy to detect this when it happens. One example is afforded by the proteins lysozyme and α -lactalbumin, which have similar three-dimensional structures and about 35 per cent amino-acid homology. Lysozyme, which is present in all

Table 11.2

A comparison of diploid and tetraploid fish

		DNA content (% of human leucocytes)	Chromosome number	Number of chromosome arms
Cyprinidae				
2n	<i>Barbus tetrazona</i>	20	50	84
	<i>Tinca tinca</i>	30	48	80
4n	<i>Barbus barbus</i>	49	100	144
	<i>Cyprinus carpio</i>	50	104	150
	<i>Carassius auratus</i> (goldfish)	53	104	168
Isospondyli				
2n	<i>Clupea harengus</i> (herring)	28	52	60
	<i>Osmerus esperlanus</i>	19	54	70
4n	<i>Salmo irideus</i> (rainbow trout)	80	56 8	104
	<i>S. trutta</i> (brown trout)	80	77 2	100
	<i>S. salar</i> (Atlantic salmon)	103	54 0	72

vertebrates, is an enzyme that destroys the mucopolysaccharide component of bacterial cell walls. Lactalbumin is a major component of milk. On its own it has no known enzymic activity, but in combination with another protein it catalyses the synthesis of lactose.

4. One duplicate may acquire a new function, after undergoing frame-shift mutations that ensure that there will be no amino-acid homology, and no similarity in three-dimensional structure, between the new product and the old. No example of such a process is known. It would be even more difficult to spot than a change of function without loss of amino-acid homology. The only trace would be homology between the nucleotide sequences of the genes.

The Ribosomal Genes

Figure 11.5 shows an element coding for ribosomal RNA in *Drosophila melanogaster*. This element is tandemly repeated, with minor variations, about 200 times on both the X and Y chromosomes. This gene family illustrates the phenomenon of 'concerted evolution'. Other *Drosophila* species have a similar repeated unit. Within each unit, they have a shorter repeated unit, similar in sequence to the 250-nucleotide repeat in *D. melanogaster*, but one that lacks the *AluI*-sensitive sequence. How, then, did the *AluI* sequence spread, to the different short repeats within a unit, to the different units, and to the X and Y chromosomes? It is not

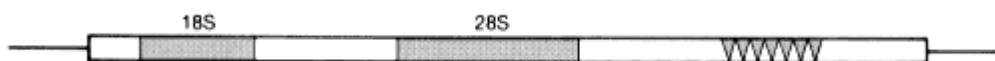

Figure 11.5

A repeating unit of DNA coding for ribosomal RNA in *Drosophila melanogaster*. The shaded regions, 18S and 28S, are the coding regions: the remainder of the unit consists of spacers. The small inverted triangles represent a region of internal repetition with a 250 bp periodicity, each containing a sequence recognized by the endonuclease.

AluI (after Dover, in Dover and Flavell 1982).

plausible that it should have arisen by mutation independently several thousand times, each mutation being established in the population. We seek mechanisms whereby a sequence that arises by mutation at one site can spread to other sites. Three such mechanisms have been proposed: unequal crossing over (the likely explanation in the case of the ribosomal genes), gene conversion, and transposition.

Unequal Crossing over and Gene Conversion

When the same DNA sequence is repeated in tandem, pairing can occur 'out of register' (either in meiosis, or between sister strands in mitosis), as illustrated in Fig. 11.4. Crossing over can then give rise to new chromosomes, one of which has two copies of elements that were present only once in the parental chromosomes. If this process continued without check, it would lead to a steady increase in the variability of copy number. If, however, individuals with too many copies, or with too few, are of lowered fitness, variation would not increase indefinitely. The result would be that, in time, all the repeated units would be copies of one original unit. This possibility is investigated further in Box 11.1. Note that unequal crossing over

Box 11.1—

Unequal Crossing Over

In principle, unequal crossing over can result in the homogenization of tandemly repeated sequences. The rate of homogenization may, however, be very slow. An analytical treatment is difficult, so I have simulated the process, with the following assumptions. In each generation, the population consists of N haploid gametes. To produce the next generation, two gametes are chosen at random, and a cross-over point is chosen randomly in each, giving two resultant gametes (see Fig. 11.6). If the number of copies of the gene in a gamete produced in this way lies within the permissible range, it becomes a member of the next generation. This process is repeated until N gametes have been produced. In the first generation, all chromosomes were supposed to have the same number of copies, the copies at a given site were identical, and the copies at different sites were different. The simulation was continued until all copies were identical, with the results shown in Table 11.3.

The Table gives estimates of the number of generations before the genes at

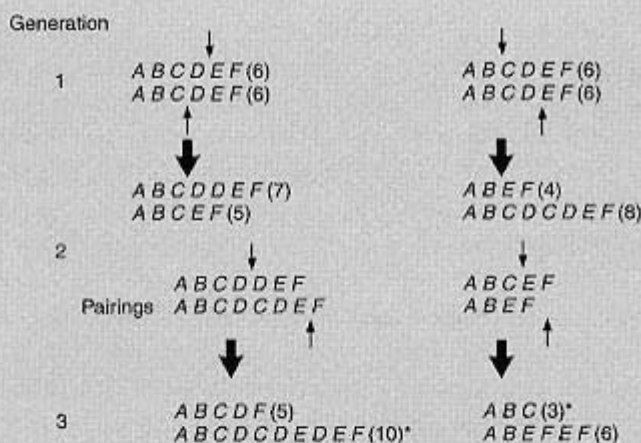

Figure 11.6 A simulation of unequal crossing over. In generation 1, all chromosomes have the same copy number (6 in this case), and all copies are different. The diagram shows two pairings, and the gametes produced. Two F_2 pairings are also shown, with the gametes passed to the F_3 ; two of these gametes exceed the permissible range of 4–8 copies, and are eliminated (*).

all sites are descended from the genes at a single site in an ancestor. When it is remembered that copy number for ribosomal RNA in *Drosophila* is about 200, and that the population size may be large (the relevant number is, of course, the number for the whole species), it will be clear that the process is very slow. To make matters worse, an appreciable genetic load is involved in maintaining the copy number within permissible limits: for these simulations, the load was 0.57, which is far higher than could possibly be the case for a single gene family. Of course, the genetic load would be lower if, as is plausible, unequal crossing over does not occur in every generation, and, when it does occur, the mispairing is less extreme. However, if this were so, the rate of homogenization would be still slower.

Table 11.3

Concerted evolution by unequal crossing over—number of generations before all of a set of tandemly repeated genes are copies of a single ancestral gene

Permissible number of gene copies	Number of haploid genomes		
	10	20	40
4–8	170 ± 15.5	287 ± 24.4	379 ± 40.5
8–16	398 ± 36.5	—	—
16–32	882 ± 87.5	—	—

The idea that the homogenization of tandemly arranged sequences is brought about solely by unequal crossing over must therefore be treated with caution. The process would be greatly speeded up if there is some selective process acting. This could act at the level of the organism, favouring individuals with a larger proportion of a particular sequence. Alternatively, selection may act at the level of the genes, favouring the spread of some particular sequences at the expense of others.

will not result in a set of identical units, because mutation continuously generates differences between them.

The best evidence that unequal crossing over does, in fact, occur comes from *Drosophila*. The sex-linked mutation *bobbed* is known to be due to a deficiency in copy number of rRNA genes, and to arise by unequal crossing over. In a selection experiment for reduced abdominal bristle number in *Drosophila*, Frankham *et al.* (1978) found that a rapid response that occurred in females but not in males was caused by chromosomes with a reduced copy number of ribosomal genes. These chromosomes were not present in the foundation population from which the selected lines were derived, so they presumably arose by unequal crossing over during the experiment. A minimum estimate of the rate of unequal crossing over was 3×10^{-6} , per gamete, per generation.

Unequal crossing over does provide a mechanism for the concerted evolution of tandemly repeated units. However, it cannot provide an explanation for the concerted evolution of a set of similar units distributed around the genome, because, if pairing and crossing over took place between such units, the result would be a major chromosomal rearrangement (in fact, a translocation if the elements were on different chromosomes), which would usually lead to lowered fertility. An alternative process is 'gene conversion'. It is known from the study of meiosis in fungi that, when two alleles pair at meiosis, occasionally one of the alleles is converted to resemble the other: from the pairing of alleles A_1 and A_2 , there emerge two copies of A_1 , or two copies of A_2 . The process can be biased, in that allele A_1 more often converts A_2 than vice versa. Gene conversion involves similar molecular processes to recombination, but need not lead to crossing over, and hence could occur between similar genes at different chromosomal locations without leading to infertility. The role of gene conversion in evolution is hard to evaluate.

Repetitive DNA

In this section, I first describe some well-studied examples of repeated sequences in eukaryotes, and then discuss their evolutionary significance. Before reading it, it would help to remind yourself of the description of transposition in prokaryotes in Chapter 10.

The Element Copia in *Drosophila*

About 15 per cent of the genomic DNA in *D. melanogaster* consists of moderately repetitive DNA (i.e. of the order of 100 copies); of this, one-half consists of 30 or so families of 'copia-like' elements. Figure 11.7 shows copia itself: the qualitative features are common to all the families.

There are some 30-50 copies of copia in a haploid genome of *D. melanogaster*. However, the sites occupied are different in different flies. A survey of geographical races found over 200 sites of possible integration, and there may be many more. In tissue culture cells, up to 150 sites may be occupied. These facts suggest

1. that the element can move to new sites; and
2. that the total number of elements per genome is regulated.

In these respects, copia resembles the insertion sequences and transposable elements found in prokaryotes. The mechanism of regulation is not known: however, copia DNA is transcribed, so it is possible that copia regulates its own copy number.

The mechanism whereby copia moves to new sites is also unknown. However, the structure of copia is very similar to that of retroviruses: all three kinds of repeats shown in Fig. 11.7, and their arrangement, are found in retroviruses. This strongly suggests a similar process of transposition. In retroviruses, the cycle is: DNA provirus - RNA transcript - extra-cellular virion - infection of new cell - reverse transcription and insertion of provirus into chromosome. There is no evidence for an extra-cellular phase in the life cycle of copia, but otherwise the cycle may be similar, and involve reverse transcription.

When a copia-like element moves to a new site, it can cause a mutation. This was

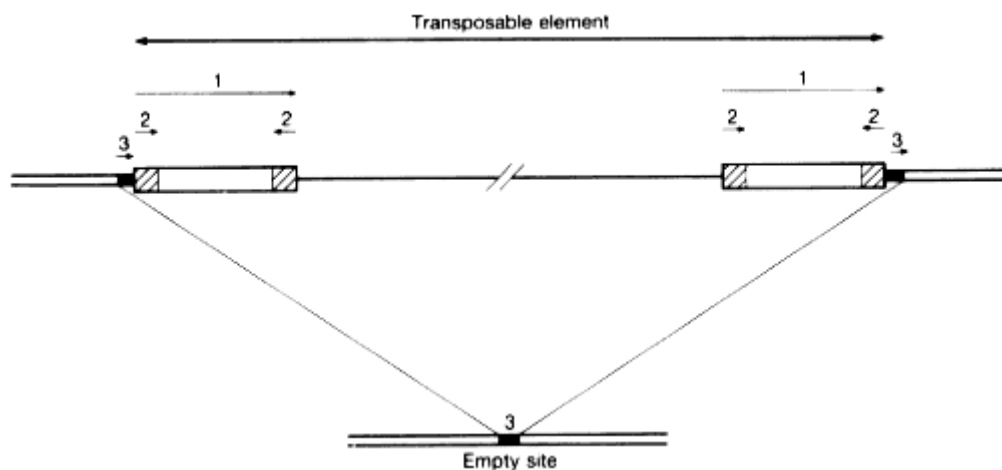

Figure 11.7

The copia element in *Drosophila* (after Finnegan 1985). The element contains the following repeats: 1, long direct repeat; 2, short inverted repeat; 3, repeat of a host sequence present only once in an empty site.

first realized when it was found that the *white-apricot* allele consists of a normal gene with a copia-like element inserted. A transposable element may also alter the expression of neighbouring genes. In vertebrates, transposable elements can cause cancers by inappropriate activation of genes. However, there is no reason to think that these elements play a necessary role in normal development. Thus copia is present at different sites in different flies, but at the same site in different tissues of the same fly: this is the opposite of what we would expect if these elements played a role in the normal control of gene activity.

P Factors and Hybrid Dysgenesis

P factors in *Drosophila melanogaster* were discovered because of their effects on the fertility of certain crosses. If freshly trapped males are crossed to females from a long-established laboratory stock, the hybrids show a number of abnormalities, including lowered fertility, recombination in males, and a high rate of visible mutations and chromosomal abnormalities among their progeny. The reciprocal cross, of laboratory males to females recently derived from the wild, showed no such abnormalities. This phenomenon of **hybrid dysgenesis** is now known to be caused by transposable P factors.

Flies from wild populations carry 30-50 copies of a sequence of about 3000 nucleotides. This DNA codes for two proteins, a transposase that mediates their movement to new sites in the genome, and a regulatory protein. In a P^+ strain, carrying such factors, transposition is an infrequent event. Laboratory stocks carry no factors \bar{P} . When chromosomes from a P^+ male are introduced into eggs from a P^- female, the transposition rate increases dramatically, in the absence of regulatory factors in the egg cytoplasm. It is this transposition that causes the phenomena associated with hybrid dysgenesis.

In addition to P factors, the genomes of P^+ flies contain deficient 'P elements', which cannot cause their own transposition, but which transpose in the presence of P factors. They are shorter than P factors, and are probably derived from them by deletion. Interestingly, they are absent in P^- laboratory strains.

There are two possible evolutionary explanations of these facts. Either P factors have been lost from laboratory strains, or they were absent from wild populations 40-50 years ago, when these strains were established, and have spread rapidly through the species since. A strain established by crossing P^+ and a P^- fly becomes P^+ , as the P factors spread by transposition. Even if P factors were ultimately lost from such a strain, we would expect some inactive P elements to remain, yet they are absent from old laboratory stocks. It is therefore hard to see how P factors could have been lost by laboratory strains: in time we shall know whether more recently established strains lose their P factors.

The rapid spread of P elements in the wild is easier to understand. It does, however, have one puzzling feature. Is it not rather a coincidence that such an

event should have occurred in the one species geneticists have chosen for study? The puzzle is made worse by the fact that a second factor, I, also appears recently to have spread through the species. It surely cannot be the case that elements of this kind, causing serious inviability and infertility, sweep through most species every 20 or 30 years. We are therefore driven to seek some reason why *D. melanogaster* should have been subject to these dramatic events. One possible explanation is that *D. melanogaster*, like the house mouse and the house sparrow, is a human commensal that has enormously extended its geographical range in recent years. This will have brought it into contact with many new species (although none, so far as we know, with which it forms fertile hybrids). This range extension may have enabled the P and I elements to invade *D. melanogaster* by horizontal transfer from another species.

The Alu Sequences of Primates.

In humans, there are some 3-5 × 10⁵ copies of a DNA sequence, *Alu* (the name derives from the fact that the sequence includes a cleavage site for the endo-nuclease *AluI*). *Alu* is 282 nucleotides long, is distributed throughout the genome, a copy occurring every 5-10 000 bases, and constitutes in all some 5 per cent of the genomic DNA. The *Alu* sequence is a dimer, consisting of two parts, each homologous to a small functional RNA molecule, 7SL RNA, present in birds and mammals, and involved in the synthesis of secreted proteins. The sequences are not identical: individual copies differ at about 10 per cent of sites from a typical 'consensus' sequence. An essentially similar *Alu* family of sequences exists in chimpanzees and in owl monkeys; in the galago, a prosimian, there is a similar sequence, but differing by a number of substitutions. These sequences are thought to transpose by the production of an RNA transcript, followed by reverse transcription and integration. They probably originated by reverse transcription from 7SL RNA.

Sequence families similar to *Alu* are characteristic of mammals. They are not known to contribute to the survival of the organism. The most plausible explanation for their presence is that they have evolved a sequence that, making use of the enzymes present in the mammalian cell, is particularly efficient at horizontal multiplication throughout the genome: that is, they are intra-chromosomal parasites. However, their presence does have important effects on mammalian evolution, because interactions between *Alu* sequences at different sites may cause structural rearrangements of the chromosomes. The rapid evolution of chromosome structure in mammals may therefore be caused by the presence of *Alu*-like dispersed sequences. Of course, only a small proportion of the structural mutations that occur, whether or not induced by the presence of *Alu*, will be established in evolution. However, the presence of these elements may generate a larger number of rearrangements as candidates for evolutionary change.

Highly Repetitive DNA

In the grasses, the DNA content of a haploid genome varies between 3.6 and 8.8 pg. Much of it consists of short sequences, with copy numbers that may be greater than a million, occurring in tandemly arranged blocks, distributed over the chromosomes, but concentrated in particular regions. This category of repeated DNA differs from those considered above, not so much in copy number (*Alu* is present in over 10^5 copies), as in its sequence and distribution. The sequences do not seem to show any features, such as terminal repeats and sites for polymerase activity, which function to ensure their transposition. They occur in tandemly arranged blocks, instead of being dispersed singly throughout the genome. Highly repetitive DNA of this kind occurs throughout the animal and plant kingdom, but in very varying amounts.

For any given family of repeated sequences, there is variability within species, but there is variability between species in what families are present. This indicates that new families can arise and spread rapidly through the genome. Unequal crossing over can explain changes in copy number in a given tandemly arranged block, but not the spread of a sequence to different chromosomes. The mechanism of such spread is not known for certain, but is thought to occur by the excision of a short length of DNA from the chromosome, the replication of that DNA to form a tandem array, and its reinsertion at a new chromosomal site.

The Role of Repetitive DNA in Evolution

It is too early to be confident about the evolutionary significance of repeated DNA. Gene clusters have evolved by duplication because of the advantage to the organism of having slightly different versions of a given functional protein. Tandemly repeated sequences with specific functions meet the need for a large amount of gene production (ribosomal genes, histone genes), or for the generation of a high degree of diversity (immunoglobulin genes). In the former case, unequal crossing over can cause concerted evolution, but there is room for doubt whether it operates quickly enough to account for observed sequence homogeneity.

In thinking about middle-repetitive dispersed DNA, and highly repetitive DNA, two general points should be remembered:

1. The interior of the cell, with its battery of enzymes that replicate and recombine nucleic acids, provides the ideal environment for parasitic DNA; we should not, therefore, be surprised if such DNA proves to be widespread.
2. We must distinguish between the selective pressures that have been responsible for the evolution of a molecule, and the effects it may have on evolution: in other words, we must distinguish between the 'function' of a molecule and its 'consequences'.

The case for regarding much middle-repetitive DNA as parasitic is strong. The similarity between copia-like elements and retroviruses is very striking, although

we do not know whether retroviruses have evolved from transposons, or transposons are retroviruses that have abandoned the extra-cellular stage of their life cycle. Either way, copia has structures that adapt it for transposition, as we would expect of a parasite. The fact that it is found at different sites in different flies, but the same site in different tissues of the same fly, is inconsistent with the idea that it plays a role in development. The case for a parasitic role is still stronger for P factors, since we know that flies are apparently quite normal without them. The evidence for self-regulation of copy number in P factors, and the possibility of such regulation for other elements, are also consistent with a parasitic role; an element that transposed too frequently (as P factors do after hybridization to a P fly) would lower the fitness of the host it infected, and therefore reduce its own chance of leaving descendents. Highly repetitive DNA is harder to interpret, because it is less obvious how its sequence affects its likelihood of spreading through the genome.

Even if repetitive DNA did not evolve because of any advantage it confers on the organism, it will still have consequences for organismic evolution. First, transposition causes both gene mutation and structural changes in chromosomes. Many laboratory mutants of *Drosophila* have been found to have been caused by the presence of a transposable element within the structural gene. Such mutations are unlikely to be important in evolution (except by increasing the genetic load) for two reasons. First, such a mutation would, almost certainly, destroy the function of the gene. Secondly, we know from sequencing studies that structural genes do not differ between species by the presence of larger insertions. If an element is inserted into a structural gene, and later imprecisely excised, this could cause a 'point' mutation that might be established in evolution: if so, transposition is an additional cause of a class of mutation that would happen anyway. More interesting is the fact that the insertion of elements into regions between structural genes can affect the regulation of those genes. Transposition, therefore, is a potential source of regulatory mutations.

Transposable elements may affect the evolution of the number and form of chromosomes (i.e. of the **karyotype**). It is interesting to contrast karyotypic evolution in mammals and in plethodontid salamanders. In many mammals, the karyotype evolves rapidly. In contrast, the genus *Plethodon*, although 80 million years old (i.e. as old as the placental mammals), is extremely uniform both in morphology and in karyotype. The DNA content per genome is large and highly variable between species, consisting mainly of dispersed middle-repetitive DNA. It seems that in some lineages there has been a gradual but uniform expansion of all the chromosomes, through the random insertion of additional DNA elements. This has not been accompanied by the evolutionary establishment of inversions or translocations. There are at least three possible explanations for this difference:

1. Mutations causing structural rearrangements are much commoner in mammals, perhaps because of interactions between the *Alu*-like elements that are

characteristic of mammals. Of course, the great majority of such mutations are not established in the population, but the presence of *Alu* elements may generate a much larger number of candidates for evolutionary change. This suggestion is speculative. At present, there is no reason to think that the sequence of *Alu*-like elements makes them particularly likely to generate inversions and translocations, or that the structure of the elements in *Plethodon* favours transposition without causing structural changes. The idea also assumes that the rate of karyotypic evolution is determined by the rate of mutation. This is contrary to what is almost certainly true of morphological evolution, whose rate is determined by the strength of selection. However, this is not unreasonable. Mutations causing specific karyotypic changes are very rare compared to mutations affecting structural genes, or the regulation of those genes. For example, the distribution of gene orders in *Drosophila pseudoobscura* and its relatives is consistent with the view that each inversion arose just once. So the idea that differences in karyotypic evolution between taxa is caused by differences between the nature of the repetitive DNA, although speculative, is not obviously false.

2. Mutants causing karyotypic change occur equally in both groups, but are less likely to cause severe infertility in mammals. A possible reason for this is that a mammal that produces a litter usually implants more embryos than can be brought to term. Hence if some embryos are aneuploid, and die very early, this does not reduce the fertility of the parents.

3. Karyotypic change is necessary for morphological change, and there has been strong selection for morphological evolution in the mammals. The weakness of this view is that there is little evidence of any causal link between morphological and karyotypic change.

It will be apparent from this discussion that we have a very poor understanding of the causes of karyotypic evolution, despite many careful investigations. I find the idea that karyotypic evolution is driven by mutations caused by transposable elements attractive, but it will remain speculative until we know more about the role of transposons in different taxa in generating karyotypic mutations.

It has been suggested that repetitive DNA may be important in speciation, in one of two ways. First, hybrid dysgenesis caused by P factors has been seen as a model for speciation. This does not seem sensible. If hybrids between P^+ and P^- flies were completely inviable or sterile, this would lead to the rapid elimination of the rare form. A newly arisen P factor would therefore have no chance of spreading. As it is, hybrids are not completely sterile, and the result has been the rapid spread of P elements through the species, without causing any dramatic change in the species, and without splitting the species into two. A more plausible suggestion is that repetitive DNA may spread differentially in two geographically isolated populations, causing hybrid sterility when those populations later meet. This may

sometimes happen. However, the DNA difference would have to be large: experiments in both *Drosophila* and grasses have shown that chromosomal pairing and chiasma formation is normal in hybrids between parents differing by up to 50 per cent in DNA content, although still greater differences can disrupt pairing. It is also worth remembering that hybrids between related species, if once formed, are often fertile, and the isolating mechanisms are ecological or behavioural.

A final suggestion is that transposons may transfer genes horizontally between species that are too distantly related to hybridize. This cannot be a common event, even on an evolutionary time-scale, because phylogenies deduced from DNA or amino-acid sequences are similar to those deduced from morphology, and this would not be so if distant gene transfer was common. But it may be occasionally happen. A possible example is the presence of leghaemoglobin in several groups of higher plants (see pp. 206-7).

A final caution is needed. Our knowledge of repeated DNA is recent and incomplete. It is therefore foolish to hold dogmatic views about its role in evolution.

The Evolution of Chromosome Form

A lot is known at the descriptive level about the evolution of the numbers and shapes of chromosomes—that is, of the karyotype—but, although we know something of the mechanisms of change, and of their consequences on fertility, the general significance of karyotypic evolution is obscure.

The haploid number of chromosomes, n , varies from one in the nematode *Parascaris* to 127 in the hermit crab *Eupagurus*, and over 250 in some ferns. In some taxa, the number is relatively uniform: for example, $n = 13$ in most dragonflies, and $n = 18$ in many snakes. In some groups, **acrocentric** (rod-shaped, with a terminal centromere) and **metacentric** (V-shaped, with a centromere in the middle) chromosomes can be distinguished: the number of chromosome arms may then be more constant than the number of chromosomes. There can, however, be big differences between related species. The most extreme example is the difference between the Assam sub-species of the Indian muntjac *Muntiacus muntjac vaginalis*, with $2n \text{ ♀} = 7$ and $2n \text{ ♂} = 6$, and the Chinese muntjac, *M. reevesi*, with $2n = 46$.

A change in karyotype requires at least two chromosome breaks, followed by a joining of the broken ends: some of the simpler changes are shown in Fig. 11.8. Such changes can be produced by radiation, and by some chemicals. However, it may well be that in nature the commonest cause of breaking and rejoining is recombination between repeated DNA elements: for example, P factors are known to produce chromosome rearrangements in *Drosophila*, and Alu-like elements probably do so in mammals. It is thought that the free ends of chromosomes cannot participate in rearrangements: thus inversions involving a single break, with the distal end rejoining in an inverted position, seem not to occur.

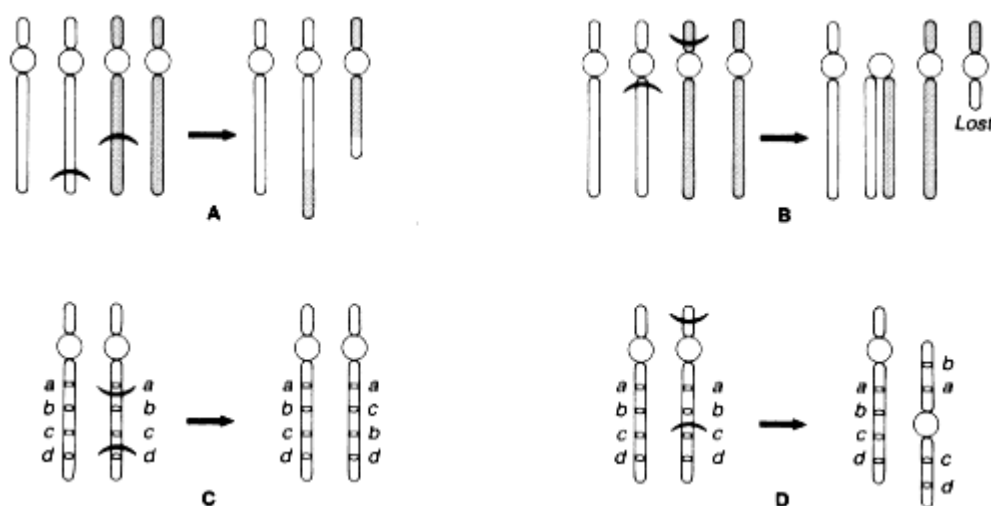

Figure 11.8

Origins of changes in chromosome structure. **A** A translocation; **B** a centric fusion; **C** a paracentric inversion; **D** a pericentric inversion. In **B**, a large metacentric chromosome is formed from two acrocentrics: in **D**, an acrocentric chromosome is converted into a metacentric carrying the same genes. represents non-homologous chromosomes; centromere; points of chromosome breakage or recombination; *a, b, c, d* represent genes.

The most important effect of such changes is a loss of fertility in the heterozygote for the new and old structures, as shown in Figs 11.9 and 11.10. This arises because up to 50 per cent of the gametes produced are aneuploid (i.e. lack some genes altogether, and have other genes present twice). Note that this loss of fertility affects only the heterozygote: homozygotes for the new karyotype are fully fertile.

How, then, can a new karyotype be established in a population? Since the heterozygote is of low fitness, whichever is the rarer form will be eliminated. The likely answer is that the transition from one karyotype to another occurs by chance in a small and partially isolated population. Note that, once a population has acquired a new karyotype, it will not readily lose it again if invaded by immigrants with the old karyotype, which will be locally rare and hence at a disadvantage.

Since structural heterozygotes are usually of low fertility, genetic polymorphism for karyotype is unusual. However, many species of *Drosophila*, and other Diptera, are polymorphic for paracentric inversions. This makes sense, because such inversions do not lower fertility in the Diptera. Thus Fig. 11.10 shows that aneuploid gametes arise from crossing over within the inversion. There is no crossing over in male Diptera. In females, the gametes with two centromeres, or with none, pass to the polar bodies, and the egg pronucleus is euploid.

Another case in which structural heterozygosity leads to no loss of fertility is that of centric fusions in the shrew, *Sorex araneus*. It is clear from Fig. 11.11 that

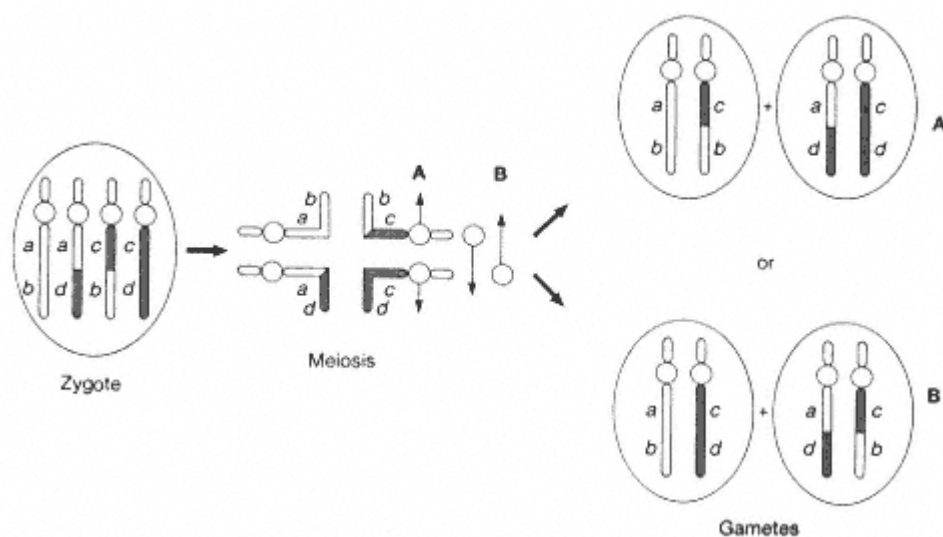

Figure 11.9

Meiosis in a translocation heterozygote. Depending on how the two pairs of centromeres disjoin, meiosis gives rise to: **A** aneuploid gametes, with some genes present twice, and some not at all; or **B** euploid gametes, with all genes represented once only. Notation as in Fig. 11.8.



Figure 11.10

Meiosis in a heterozygote for a paracentric inversion, with a single cross-over within the inversion. The four products are: an inverted and an uninverted chromosome, each with one centromere and a complete set of genes; a chromosome with two centromeres; and a chromosome with no centromere. Note that crossing over involves only two of the four strands.

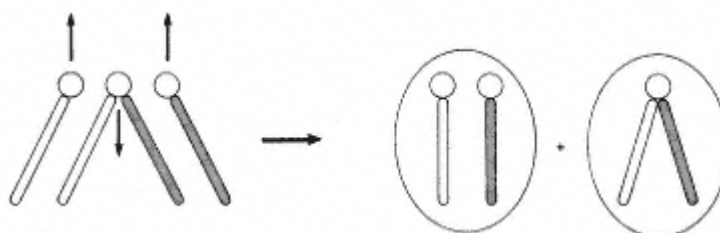

Figure 11.11

Meiosis in a heterozygote for a centric fusion. If, as shown, the centromeres of the two acrocentrics move together to one pole, and the centromere of the metacentric to the other pole, then all the gametes produced are euploid, and no infertility arises.

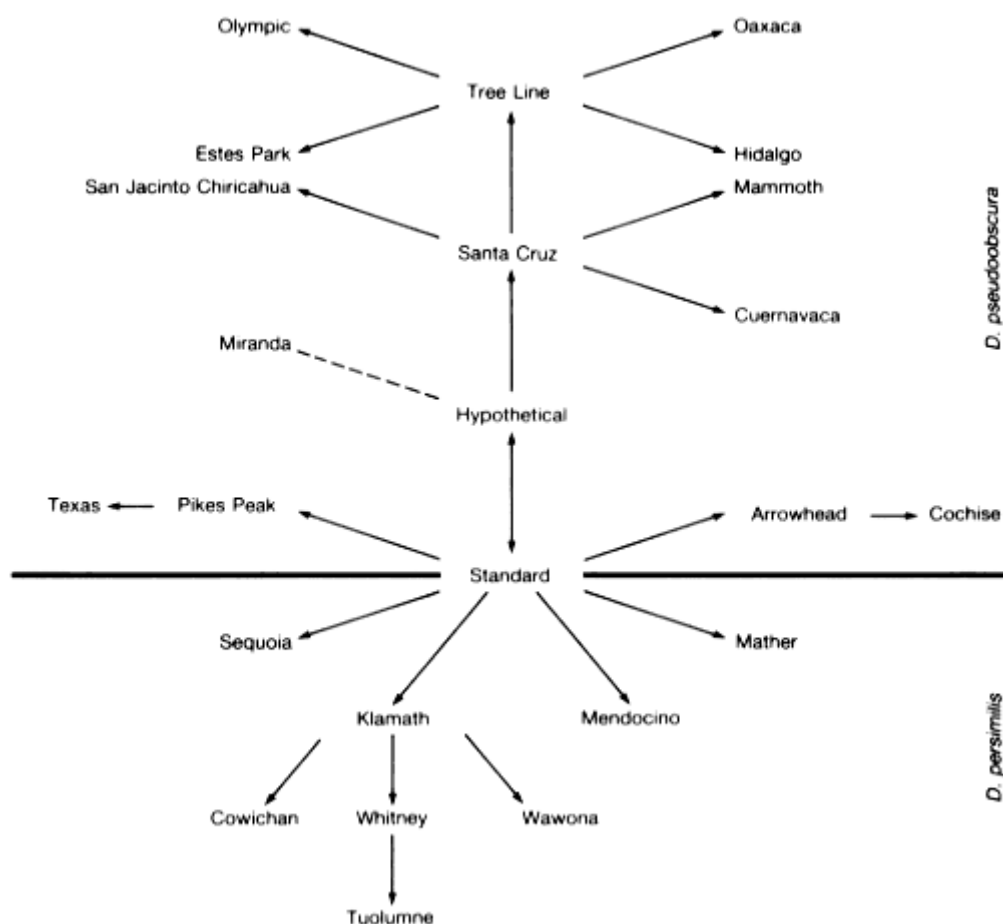

Figure 11.12

The phylogeny of the third chromosome in *Drosophila pseudoobscura* and *D. persimilis*. Arrows connect orders that differ by a single inversion. Standard is the only order present in both species. The Hypothetical order has not been found, but is a necessary link between Standard and Santa Cruz. The chromosome orders in a third species, *D. miranda*, can be derived from Hypothetical. Note that this is an 'unrooted' tree: the direction of evolution is unknown. (Adapted from Dobzhansky 1951.)

there will be no infertility if the centromeres of the two acrocentrics pass to one pole, and the centromere of the metacentric to the other. This is what happens in shrews: not surprisingly, natural populations are polymorphic for centric fusions. In other taxa, centric fusions may cause loss of fertility. For example, the house mouse, *Mus musculus*, has $2n = 40$, and the 'tobacco mouse', *M. poschiavinus*, differs by seven centric fusions, and hence has $2n = 26$. Hybrids between the two are of low fertility.

This mouse example, and the earlier example of the muntjac, illustrate a more general point. It seems that in some lineages, such as that connecting the Indian to the Chinese muntjac, or the house and tobacco mouse, the same kind of structural

change must have occurred repeatedly, affecting many different chromosomes. White (1978) describes a number of such cases, involving different kinds of change. He has called the process **orthoselection**. The term is unfortunate, because we have no idea what selective advantage, if any, is responsible, but the phenomenon is interesting.

In *Drosophila*, it is possible to locate the break points of the inversions with some accuracy, by examining the giant salivary chromosomes. Thus one can construct a phylogenetic tree of the gene orders of chromosome III of *D. pseudoobscura* and *D. persimilis* (Fig. 11.12). Each named order differs from its neighbours in the tree by a single inversion. One sequence, Standard, is common to both species. To complete the tree, one hypothetical order that has not been found must be included: this order is a plausible ancestor for the chromosomes of a third species *D. miranda*. We cannot tell the direction that evolution has taken: in taxonomic jargon, it is an unrooted tree. Two conclusions can be drawn. First, the establishment of each inversion was a unique event: otherwise, the figure would be a network, and not a tree. Secondly, once established, a chromosome order is long lasting: otherwise, there would be more than one gap in the tree.

Further Reading

Bendall, B.S. (ed.) (1983). *Evolution from molecules to men*. Cambridge University Press. (Particularly articles by D.C. Phillips *et al.*, A.J. Jeffreys *et al.*, and W.F. Bodmer.)

Dover, G.A. and Flavell, R.B. (ed.) (1982). *Genome evolution*. Academic Press, London.

White, M.J.D. (1978). *Modes of speciation*. W.H. Freeman, San Francisco.

Computer Projects

1. Unequal crossing over. Write a program to produce data similar to those in Table 11.3, and calculate the genetic loads. (This is not an easy program to write, and probably not for beginners.)

2. Peak shifts in finite populations. In a diploid, the three genotypes at a locus have phenotypes $aa = 1$, $aA = 1 - s$, $AA = 1 + t$; (aA is a chromosomal structural heterozygote of lowered fertility). A population of n males and n females (where n is small; say 5-20) mates randomly. If the initial population consists of one aA (a new mutant) and $2n - 1$ aa individuals, what is the probability that allele A will be fixed? What is the probability that A will be fixed if the initial unique individual is AA (a migrant from an already established AA population)? (You should check that the program is running correctly by answering the question when $s = t = 0$.)

**Chapter 12—
The Evolution of Genetic Systems:
I. Sex and Recombination**

The natural history of sex	<u>225</u>
Meiosis	<u>225</u>
Ploidy and cellular differentiation	<u>228</u>
Anisogamy	<u>229</u>
Hermaphroditism	<u>229</u>
Asexual reproduction	<u>229</u>
Why not be a parthenogen?	<u>230</u>
The cost of sex	<u>230</u>
The distribution of parthenogenesis	<u>233</u>
The advantages of sex	<u>234</u>
Sex accelerates evolution	<u>234</u>
Sex and the role of parasites	<u>234</u>
The accumulation of deleterious mutations: 1. 'Muller's ratchet'	<u>236</u>
The accumulation of deleterious mutations: 2. Synergistic selection	<u>237</u>
Interactions between beneficial and deleterious mutations	<u>239</u>
Long-term and short-term explanations	<u>239</u>
Summary	<u>241</u>
The evolution of recombination	<u>241</u>
Further reading	<u>248</u>

The evolution of genetic systems is perhaps the most difficult and exciting topic in evolutionary genetics. The difficulty arises in part from the complexity of the phenomena that have to be explained, and the bewildering array of facts that have to be borne in mind. More fundamentally, it arises because the genetic system affects not only the fitness of the individual, but also the evolutionary potential of the population: there is therefore a difficulty in deciding at what level, between-individual or between-population, selection has acted.

This chapter discusses why sex and recombination occur at all: the next chapter accepts that sex occurs, and discusses various consequences. Attention is confined to sexual processes as they can be observed today in eukaryotes. The essential feature of the sexual process is that genetic material from different ancestors is brought together in a single descendent. The analogous processes that occur in prokaryotes are so different that they require a separate treatment: they were discussed briefly in Chapter 10. However, in thinking about the origins of eukaryotic sex, it is worth remembering that the enzymes that today mediate genetic recombination during meiosis probably originated because of their role in DNA repair in our prokaryotic ancestors.

The Natural History of Sex

In this section, I describe the main features of the sexual process in eukaryotes, many of which will already be familiar.

Meiosis

In most eukaryotes, there is an alternation between haploid and diploid states (Fig. 12.1). Two haploid cells, or gametes, fuse to form a diploid zygote in the process of **syngamy**: the diploid zygote produces gametes by **meiosis**. The essential characteristics of meiosis are shown in Fig. 12.2. Each chromosome is replicated, to form two **chromatids**. Pairs of homologous chromosomes lie side by side to form

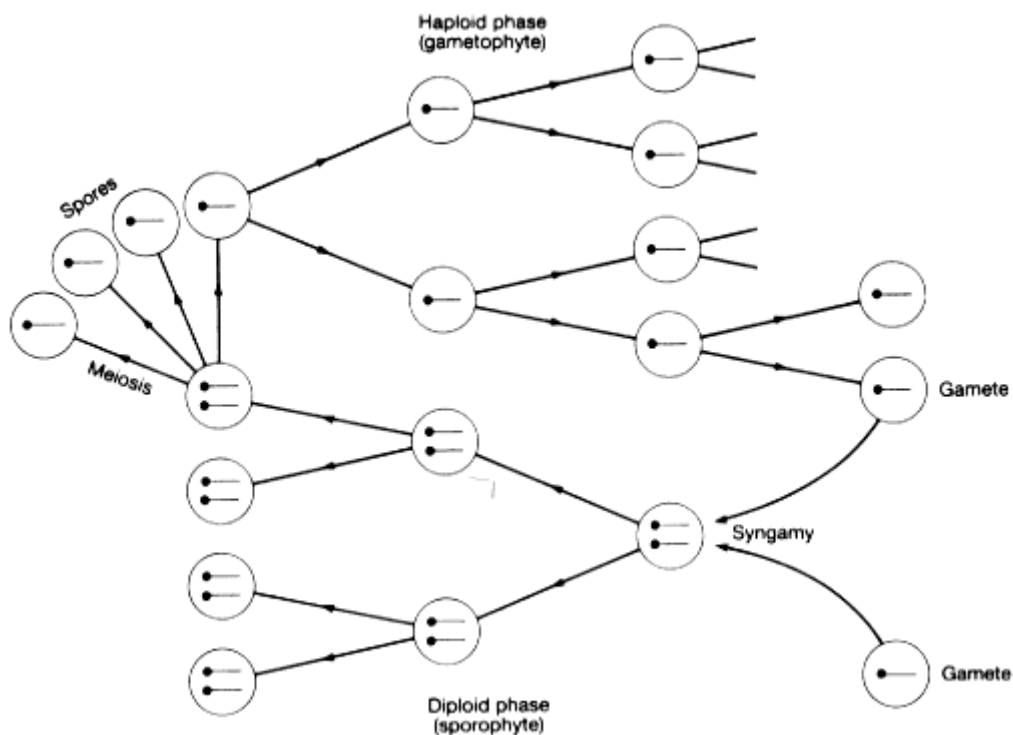

Figure 12.1

Life cycle with alternation of haploid and diploid phases: for simplicity, an organism with a haploid number of one is illustrated.

bivalents consisting of four chromatids, which are then distributed to four haploid nuclei by two meiotic divisions of the nucleus. **Crossing over** takes place at the four-strand stage, by breakage and reunion of two of the four chromatids at exactly homologous points. The result of crossing over is the formation of **chiasmata**, which are essential for proper disjunction: if no chiasmata are formed between two homologous chromosomes, both may pass to the same daughter cell, giving rise to aneuploid gametes. The **centromeres**, by which the chromosomes are attached to the spindle, and by which they are then moved to opposite poles, are not replicated until after the first meiotic division: consequently, the centromeres disjoin at the first meiotic division, as do any genes lying between the centromere and the first chiasma.

Although chiasmata are needed for proper disjunction in most eukaryotes, **achiasmate** meiosis has evolved on several occasions. It is most familiar in male Diptera, including *Drosophila*, but it is also found in female Lepidoptera. The effect is that no recombination occurs between genes on homologous chromosomes. Crossing over is also suppressed if the chiasmata are localized at the ends of chromosomes, as happens in many grasshoppers, and in female *Antechinus*, the

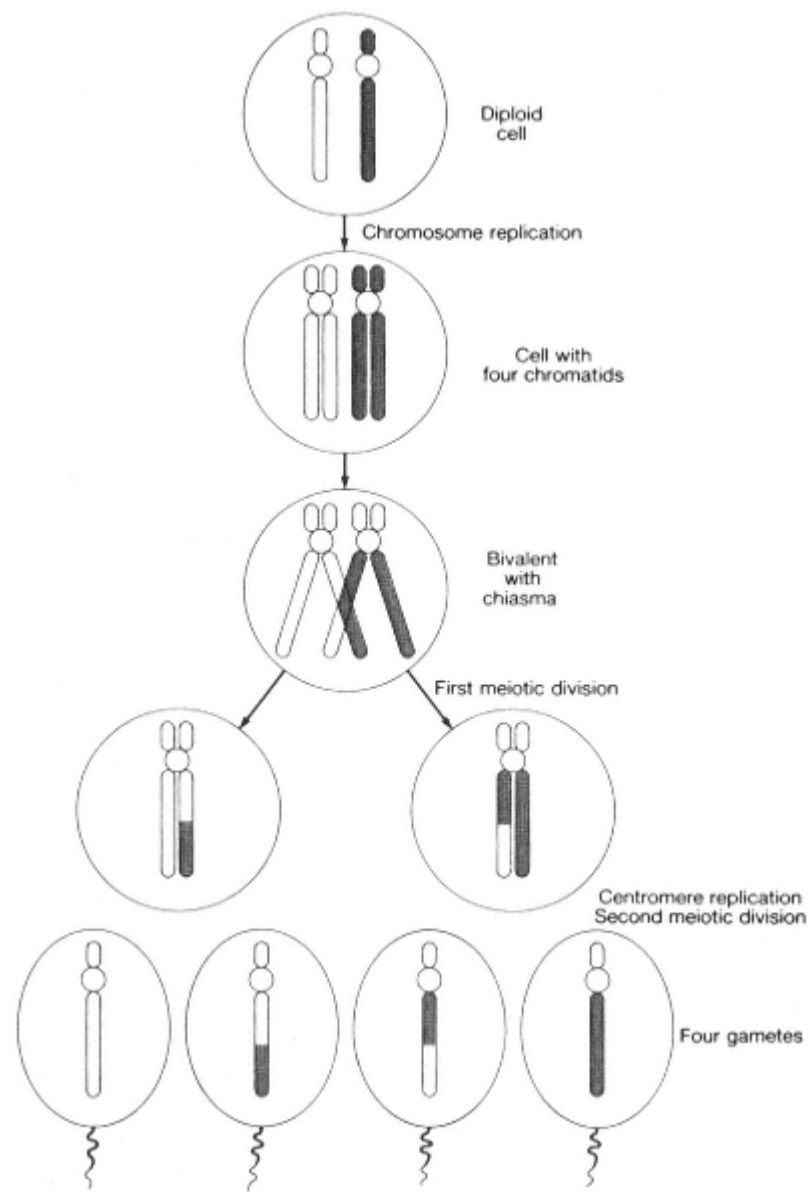

Figure 12.2
The essentials of meiosis.

only marsupial mammal so far investigated. No species is known in which crossing over is suppressed in both sexes.

A haploid-diploid alternation requires a special division in which the chromosome number is halved, but it is not clear why meiosis involves an initial doubling of the chromosome number, followed by two divisions. It is therefore intriguing

that a number of protists (that is, single-celled eukaryotes) have a 'meiosis' which appears to consist of a single cell division, not preceded by chromosome replication. It may be that this represents a primitive state from which typical meiosis has evolved.

Ploidy and Cellular Differentiation

There is great variability in multicellular organisms in the roles played by the haploid and diploid stages of the life history. Figure 12.1 shows diagrammatically the relation between the haploid **gametophyte** (that is, producer of gametes by mitosis) and the diploid **sporophyte**, which produces haploid spores by meiosis. In multicellular green algae (e.g. *Spirogyra*), the typical situation is for the multicellular stage to be haploid, alternating with a single-celled diploid stage. Occasionally, as in *Codium*, this situation is reversed, and the multicellular stage is diploid. On at least three occasions, there has evolved an alternating life history with morphologically identical multicellular haploid and diploid stages: an example is the green seaweed, *Ulva*. A similar alternation of morphologically identical haploid and diploid stages occurs in some brown algae (e.g. *Ectocarpus*), although in the largest species the main vegetative stage is diploid, and the haploid stage is microscopic (e.g. in kelp *Laminaria*) or reduced to a single cell (e.g. in *Fucus*).

In higher plants, there is an association between diploidy and a high degree of cellular differentiation. Thus in the bryophytes (mosses and liverworts) the main vegetative stage is the gametophyte, upon which the sporophyte grows parasitically. In the pteridophytes (ferns), the gametophyte is a flat leaf-like thallus, resembling a liverwort, and the main vascular plant is the sporophyte. Subsequent evolution continued this emphasis on the sporophyte, until in flowering plants the gametophyte was reduced to the pollen tube (male), and the ovule (female). In multicellular animals, the haploid phase has been reduced to the non-dividing gamete (egg or sperm).

These facts suggest that diploidy may be a precondition for the evolution of complex multicellular structures. This is partly confirmed by the situation in the fungi. The thread-like structure of a fungus, the **mycelium**, contains haploid nuclei. Two genetically different mycelia may fuse to form a **heterokaryon**. If so, the two types of nuclei do not fuse to form a diploid nucleus, but both types continue to divide, so that the heterokaryon contains nuclei of two genetically different types. The most complex multicellular structures formed by fungi are the fruiting bodies of basidiomycetes (for example, mushrooms and toadstools). These structures are heterokaryons, and there are special processes that ensure that each cell contains one nucleus of each of the two types (division with so-called clamp connections). Hence the cells of a mushroom, although not containing a diploid nucleus, do contain two sets of genes, one derived from each of the 'parent' mycelia that fused.

Anisogamy.

In many protists and algae, there is no morphological differentiation between male and female gametes. All gametes are small and motile. However, in such **isogamous** ('equal gametes') organisms, the gametes are usually of two types, + and -, and will fuse only with gametes of the opposite type. Higher plants and animals are **anisogamous**: that is, there is differentiation between a small motile gamete, the sperm, and a large non-motile gamete, the egg. In flowering plants, there is no motile sperm, and the 'gamete' is reduced to one nucleus of the gametophyte, or pollen tube.

Intermediates between isogamy and anisogamy exist in some groups of green algae. For example, the Volvocales form spherical multicellular colonies. The smaller species are isogamous, forming motile sperm. There are species of intermediate size, in which some colonies produce small motile gametes, and others larger motile gametes. Finally, in the largest species, some colonies produce sperm, and others large non-motile gametes, or eggs.

Hermaphroditism

In both plants and animals, eggs and sperm may be produced by different individuals, or by the same individual. The terminology is somewhat confusing: it is described in Box 12.1.

Asexual Reproduction

Many plants and animals can reproduce without syngamy. It is useful to distinguish three processes:

1. **Parthenogenesis**: development of a new individual from an unfertilized egg.
2. **Adventitious embryony**: development of a new individual from a single

Box 12.1—

The Terminology of Hermaphroditism

In animals, an individual that reproduces both as a male and a female is a *hermaphrodite*. Hermaphroditism can be simultaneous or sequential: in the latter case, the individual may reproduce first as a male and then as a female, or vice versa. A species that has separate male and female individuals is said to be **gonochoristic**.

In plants, the word hermaphrodite is confined to cases in which male and female functions are present in a single flower. Species in which a single individual has separate male and female flowers are **monoecious** ('one house'); note that to a zoologist a monoecious species would be hermaphrodite. Species with separate male and female individuals (holly, apples, hops) are **dioecious** ('two houses'). In this book, I use the word dioecious for both plants and animals with separate sexes.

somatic cell. Barring mutation, the genotype of the offspring is identical to that of the parent: in this respect it is identical to one form of parthenogenesis (apomixis; see below).

3. **Vegetative reproduction:** development of a new individual from a group of somatic cells, for example plant reproduction by bulbs, corms, rhizomes, or tillers. Again, barring mutation, the offspring are genetically identical to the parent: however, when we allow for mutation, the process differs in its genetic consequences, because a new individual may be a genetic mosaic.

Parthenogenesis is the process that has received most attention from evolutionary biologists. It can take several forms:

1. **Apomixis:** meiosis is suppressed, and the offspring are genetically identical to the parent.
2. **Automixis:** meiosis is retained, and diploidy is restored by fusion of two of the haploid products of meiosis, or of two genetically identical nuclei produced by the mitotic division of the haploid egg nucleus (Fig. 12.3). Typically, the offspring are homozygous at some or all of the loci at which the parent was heterozygous.
3. **Endomitosis:** meiosis is preceded by a round of chromosome replication, giving rise to a tetraploid cell (Fig. 12.4). Pairing then occurs between **sister chromosomes** (that is, chromosomes that have just arisen by the replication of the same parent chromosome), and meiosis then proceeds normally. As in apomixis, the result is to produce offspring genetically identical to the parent. This is the form of parthenogenesis in some lizards of the genera *Cnemidophorus* and *Lacerta*.

This brief list does not exhaust the mechanisms of parthenogenesis. However, the critical distinction is between those processes (apomixis, endomitosis) that produce offspring identical to the parent, and those (most forms of automixis) that produce offspring more homozygous than their parents. It is not hard to see why parthenogenesis of the latter kind is rather rare in nature: it is harder to see why the former kind does not triumph.

Why not be a Parthenogen?

The Cost of Sex

Consider an organism such as a herring, with equal numbers of males and females, and no parental care. In females, a gene *A* suppresses meiosis, and causes the production of diploid eggs that develop without fertilization into females genetically identical to the parent. Figure 12.5 shows that, when rare, such a gene would double in frequency in each generation. This result has been expressed by saying that there is a 'twofold cost of sex', arising from the needless production of males. It is clearer, however, to take a 'gene's eye view': a gene *A* that suppresses meiosis

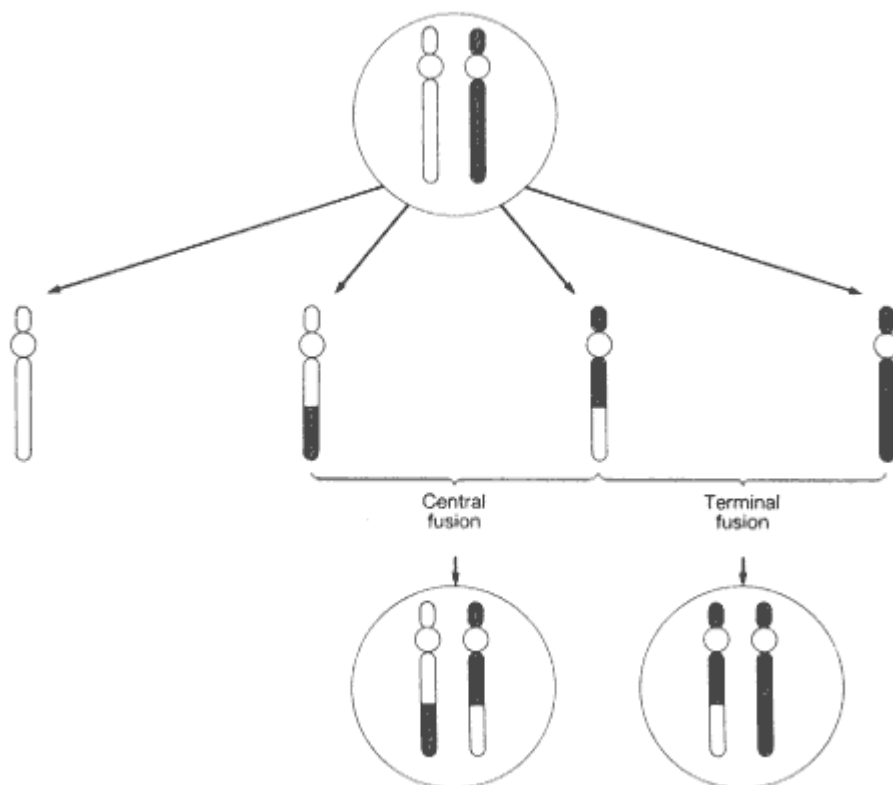

Figure 12.3

Automictic parthenogenesis. If, as in the diagram, diploidy is restored by fusion of two of the four products of meiosis, offspring may be homozygous at loci for which the mother was heterozygous, but, with central fusion, heterozygosity is always maintained for genes between the centromere and the first chiasma. In some automictic parthenogens (for example, *Drosophila mangabieri*), heterozygosity is maintained by combining central fusion with the suppression of crossing over. If diploidy is restored later, by the fusion of two nuclei derived by mitosis of a single product of meiosis, the offspring are homozygous at all loci.

is certain to be transmitted to all the eggs produced by a female, whereas a gene that permits meiosis is transmitted to only half.

The twofold cost of meiosis does not arise in isogamous organisms, so we do not have to allow for it when thinking about the origin of eukaryotic sex. The argument is complicated if there is paternal care, because the number of offspring a female can raise is greater if she has a mate: of course, she could pair with a male but produce eggs parthenogenetically. Figure 12.6 shows the situation in a self-sterile hermaphrodite: there is again a short-term advantage to parthenogenesis.

It is unlikely that a single mutation could be responsible for effective parthenogenesis. The argument in this section shows, however, that a parthenogenetic genotype, perhaps involving many genes, would increase in frequency unless there are counteracting selective forces. The problem is to identify those forces.

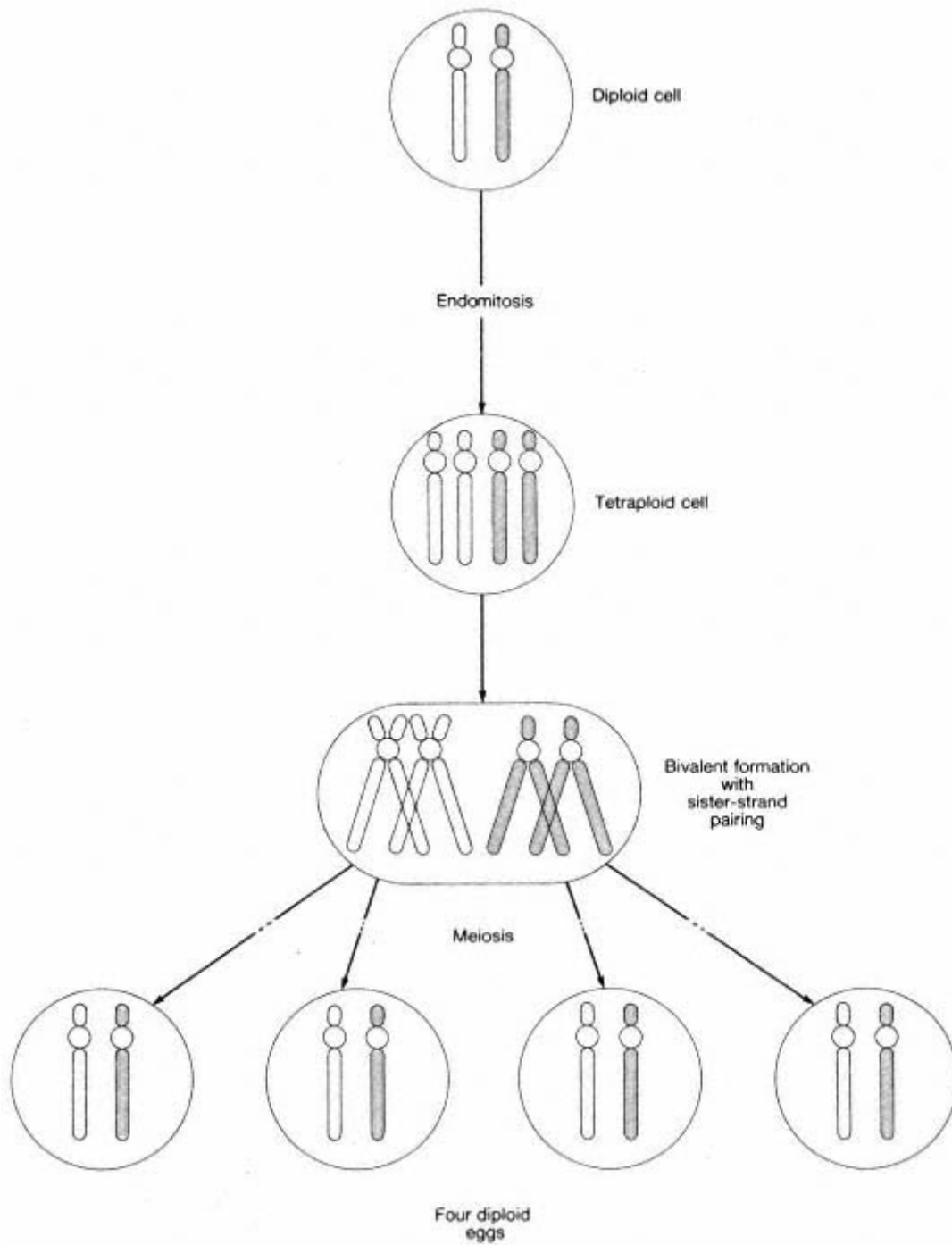

Figure 12.4
Parthenogenesis by endomitosis, followed by sister-strand pairing and meiosis.

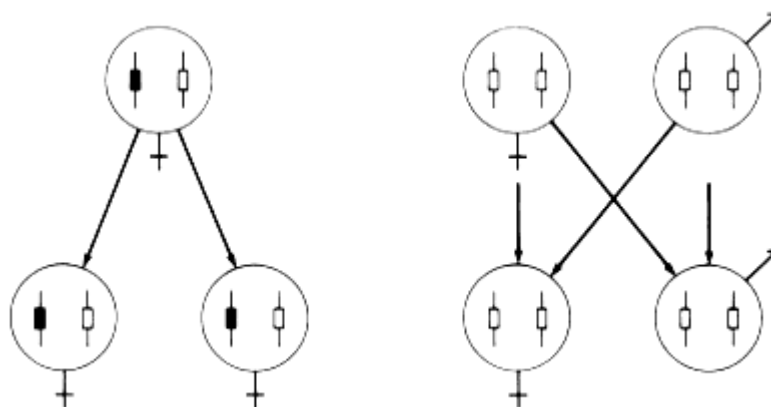

Figure 12.5

The cost of meiosis. ■ represents a gene that suppresses meiosis, causing a female to produce diploid offspring identical to herself. □ represents the sexual allele of ■. If females carrying ■ and □ are equally fecund, allele ■ doubles in frequency in a generation when rare.

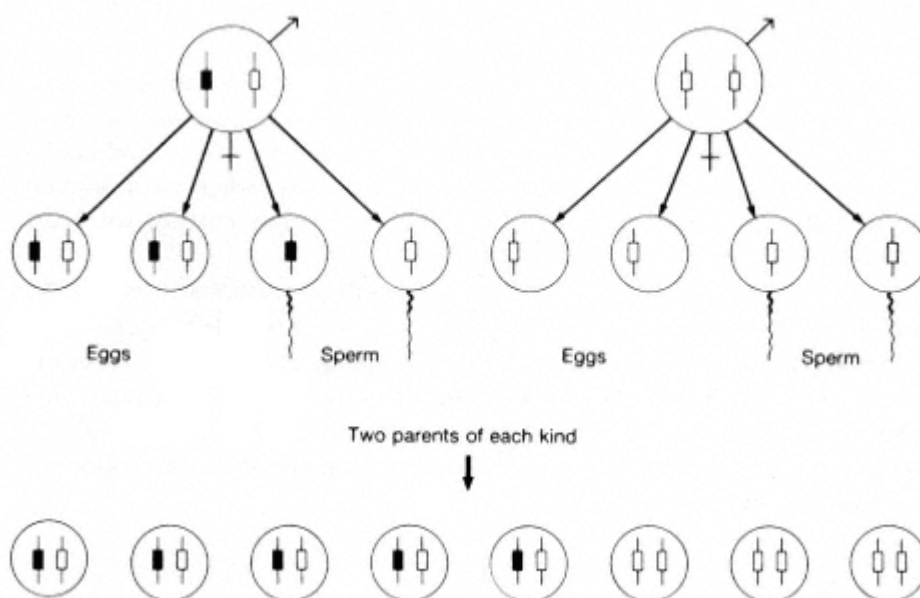

Figure 12.6

Parthenogenesis in a self-sterile hermaphrodite. ■ represents a gene that suppresses meiosis in the eggs, but not in sperm (or pollen). If in one generation half the individuals carried allele ■, in the next generation 5/8 of the individuals would do so.

The Distribution of Parthenogenesis

Parthenogenesis is widely distributed among both plants and animals, although there are some taxa (for example, gymnosperms and mammals) in which it has not been reliably reported. However, most parthenogens have close relatives that are sexual. It is unusual to find a family or higher taxon consisting wholly of partheno-

gens. The bdelloid rotifers, an order in which males have never been reported, constitute an exception. Some large taxa (for example, aphids, and cladocerans) are cyclically parthenogenetic: a number of generations of apomictic parthenogenesis alternate with a sexual generation: it is interesting that, in both the taxa mentioned, there are many varieties that have wholly abandoned sex.

This spotty taxonomic distribution suggests that parthenogenetic varieties may be successful in the short term, but that (with a few exceptions, such as the bdelloids) they have been unable to survive for a long time, or to undergo adaptive radiation. There are two possible explanations for this failure:

1. Parthenogenetic varieties evolve more slowly than sexual populations;
2. Parthenogenetic varieties accumulate harmful mutations.

These possibilities will be discussed in turn.

The Advantages of Sex

Sex Accelerates Evolution

The argument is shown in Fig. 12.7. Suppose that two favourable mutations A and B , occur in different individuals in the same population. Each will increase under selection. In a sexual population AB individuals can then arise by recombination. In an asexual population, an AB individual can arise only when an A mutation occurs in a B individual, or vice versa. Therefore the sexual population will evolve more rapidly.

Note that this argument does not apply to small populations, in which each favourable mutation that occurs will be fixed before the next one happens. Also, it does not apply if fitness interactions are strongly epistatic, so that AB is fitter than ab , but Ab and aB are of low fitness: if this is the case, recombination actually slows down evolution by breaking up favourable gene combinations when they occur.

We can conclude that, although recombination is not necessary for evolution by natural selection, it will often accelerate the process.

Sex and the role of Parasites

The fact that sexual populations can evolve more rapidly can only explain the ubiquity of sex if populations are frequently exposed to directional selection. This has led to the idea that parasites may play a crucial role in the maintenance of sex. An arms race between hosts and their parasites will prevent either population from achieving an optimal genotype. The effect is likely to be particularly strong for the host species, because parasites often have a short generation time, and so are likely to evolve rapidly.

There is empirical support for this idea. Lively *et al.* (1990) compared the intensity of parasite infection in a sexual fish, *Poeciliopsis monacha*, with that in

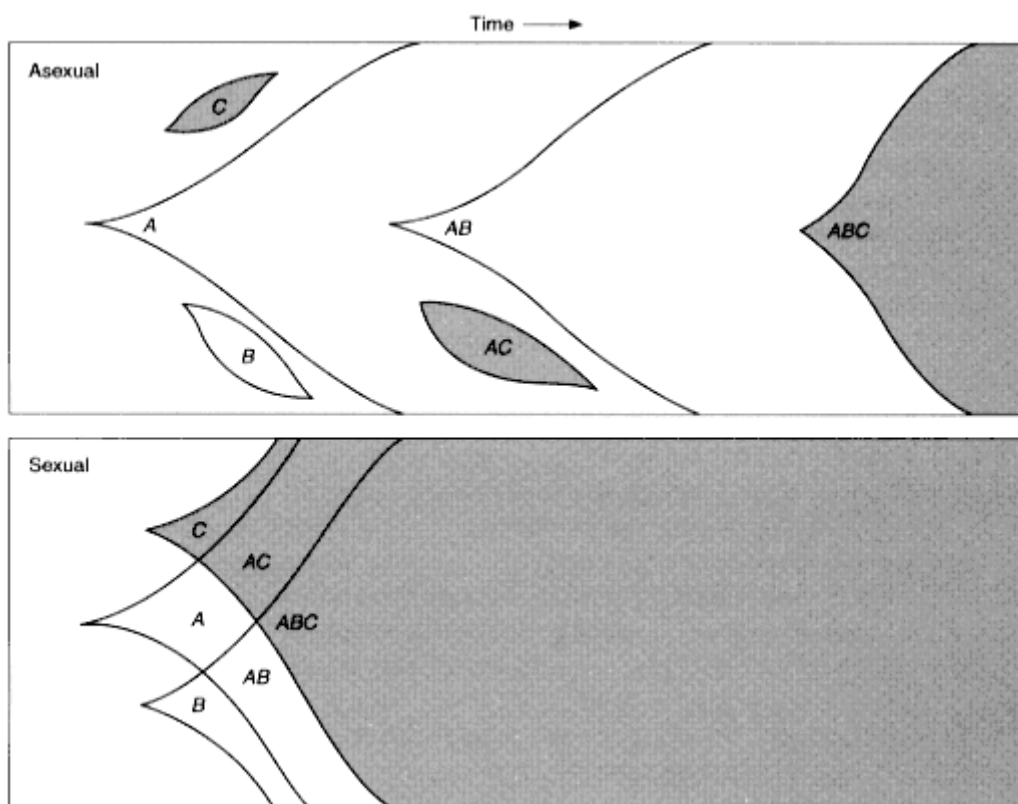

Figure 12.7
Evolution in sexual and asexual populations (after Muller 1932).

two clones of triploid asexual relatives, originating by hybridization between *P. monacha* and the related *P. lucida*. These fishes are infected by trematode larvae, which burrow through the body wall and form externally visible cysts, which can be counted, so that the build-up of infection can easily be measured. The first pool to be studied contained sexual *P. monacha* and members of one asexual clone, MML/I, which were found to be more heavily infected than the sexuals. A second pool was occupied by sexual fish, and by two distinct clones, MML/I and MML/II. The latter clone was more common, and more heavily infected than the sexuals. There was no difference in level of infection between the sexuals and the rarer clone, MML/I, showing that the heavier infection of MML/I in the first pool was due to its high relative abundance there, and not to any intrinsic susceptibility. Finally, in a third pool there had been a local population extinction, followed by reinvasion by a few sexual fish, and also by the clone MML/I. In this pool, the sexual fish were more heavily infected, perhaps because of the deleterious effects of inbreeding. However, after additional sexual fish had been experimentally intro-

duced into the pool, this effect was reversed, and the clonal fish were again more heavily infected.

These results show that (except when the sexual fish were highly inbred) the sexual population was more resistant to parasite infection than the clones. The probable explanation is that the sexual population was genetically more variable. If parasites evolve so as to attack the more common types in the host population, there will be an advantage to rare host genotypes, as suggested by Haldane (1949). This effect may not only favour rare genotypes at the expense of common ones within a sexual population, thus maintaining genetic polymorphism, but, as a number of authors have pointed out, may favour sexual as against asexual populations.

The Accumulation of Deleterious Mutations:

1. 'Muller's Ratchet'.

H.J. Muller pointed out that, in a population without recombination, there is a tendency for slightly deleterious mutations to accumulate. The argument is shown in Fig. 12.8. We classify the population into classes containing 0, 1, 2, . . . k deleterious mutations. Let the number of individuals in the optimal class, with no deleterious mutations, be n_0 . If n_0 is small, then there is in each generation a chance that, despite their high fitness, all n_0 individuals will die without leaving offspring.

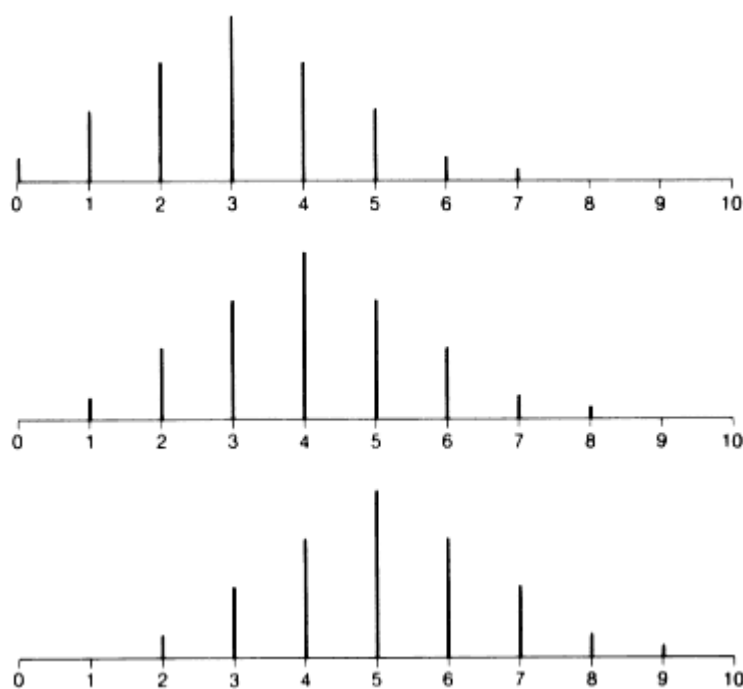

Figure 12.8

Muller's ratchet. The top diagram shows the initial distribution in an asexual population of individuals with 0, 1, 2, 3, . . . slightly deleterious mutations.

The lower two diagrams show the same population after the ratchet has clicked round one, and two, notches.

If so, the optimal class is lost, and can only be reconstituted by back mutation: in a sexual population it can be reconstituted by recombination. In Muller's phrase, the ratchet has clicked round one notch. The new optimal class will carry one deleterious mutation. In time, that class too will be lost, as the ratchet clicks again.

The process is relevant only if n_0 is small. It can be shown (Haigh 1978) that, if fitnesses combine multiplicatively, the equilibrium value of n_0 is

$$n_0 = Ne^{-U/s}, \quad (12.1)$$

where N is the population size, U the expected number of deleterious mutations per genome per generation, and s the selective disadvantage per mutation.

If s is small, then n_0 may be small even if N is large. For example, if $N = 100\,000$, $U = 0.1$, and $s = 0.01$, then $n_0 \cong 4.5$: deleterious mutations would accumulate rapidly. A sexual population with this mutation rate would be in no difficulty: the mean fitness \bar{W} , relative to a fitness of 1 for the optimal class, is $\bar{W} = e^{-0.1} = 0.905$.

Muller's argument applies not only to asexual organisms, but to any region of DNA that never recombines: for example, the Y chromosome. It also applies to populations with 100 per cent self-fertilization.

It is hard to decide how important this process has been. One difficulty is that it assumes that many mutations are unconditionally deleterious, and can be corrected only by back mutation. If one supposes that most mutations alter fitness through their effect on quantitative traits that are under normalizing selection, then each mutation can be counterbalanced by mutations in the reverse direction at many other loci. Unfortunately, we have at present no information concerning the accumulation of deleterious mutations in parthenogens.

The Accumulation of Deleterious Mutations:

2. Synergistic Selection

Muller's ratchet operates only in a finite population (although the population need not be small). What if the population is so large that the ratchet does not operate? Will recombination still reduce mutational load? It all depends on how deleterious mutations affect fitness (Kondrashov 1982). Suppose that a single mutation reduces fitness by a factor $1-s$. If n mutations, at separate loci, reduce fitness by a factor $(1-s)^n$, we say that the effects of deleterious mutations are multiplicative. In this case, an asexual and a sexual population would be affected identically, essentially because an infinite asexual population would be in linkage equilibrium.

Suppose, however, that deleterious mutations act **synergistically**: that is, each additional mutation has a greater effect on fitness. Then recombination can reduce the mutational load. The most extreme form of synergistic selection is truncation selection; fitness is unaffected by k mutations, but $k+1$ (or more) mutations are lethal. As shown in Box 12.2, if selection acts in this way, then, for the same rate of deleterious mutation, a sexual population suffers a much lower mutational

**Box 12.2—
Synergistic Selection and Recombination**

Figure 12.9 shows populations with (left) and without (right) recombination. Considering first the population with recombination, the top histogram shows the distribution of individuals with different numbers of mutations, assuming a

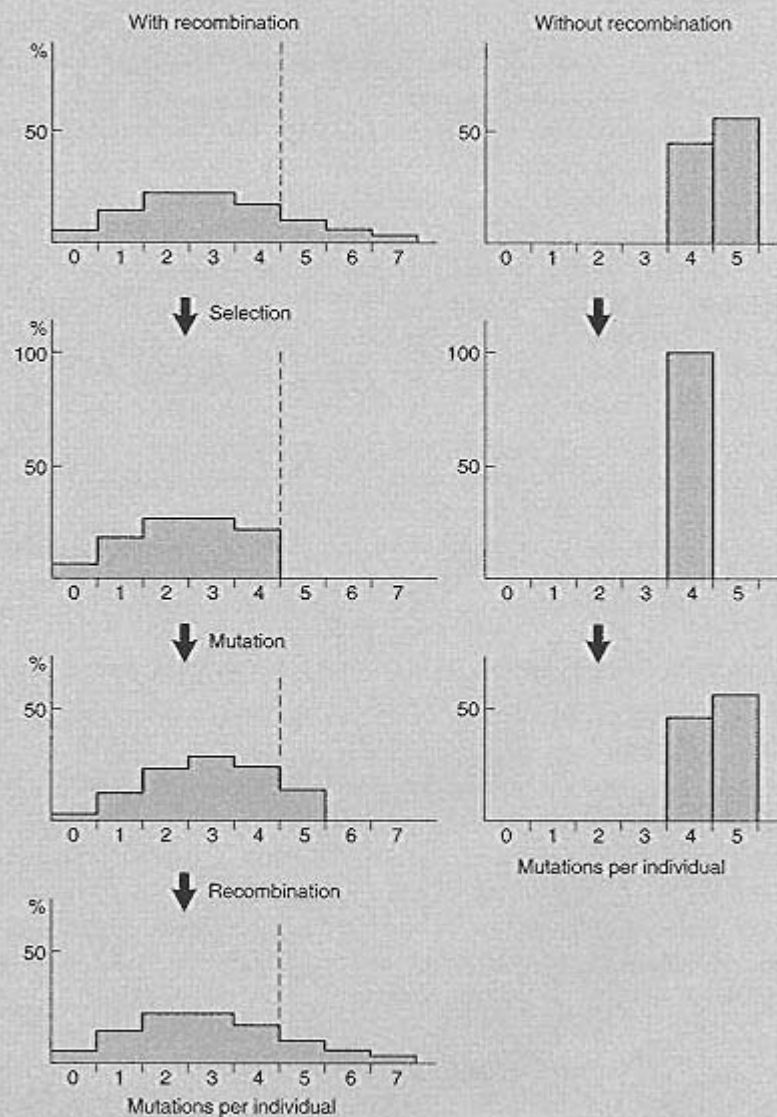

Figure 12.9 Number of mutations per individual in populations with (left) and without (right) recombination.

mean of three mutations per individual, randomly distributed. Truncation selection (the most extreme form of synergistic selection) removes all individuals with five or more mutations, but does not discriminate between individuals with fewer than five mutations. The result is a population with a mean of 2.45 mutations per individual. For each individual, there is then a probability of 0.55 of receiving one additional mutation, generating the population in the third row, again with a mean of three mutations per individual. Finally, recombination redistributes the mutations randomly, without altering the mean, thus restoring the original population distribution.

The population without recombination has the same assumptions about selection (all individuals with five or more mutations die) and mutation (each individual has a probability of 0.55 of receiving an additional mutation).

The crucial point is that 55 per cent of the asexual population dies selectively each generation, but only 15 per cent of the sexual one, even though the mutation rates are identical. The reason is that recombination increases the variance of the number of mutations per individual, and so makes selection more effective in removing them.

load. The reason is that recombination increases the variance in the number of deleterious mutations per individual, and so makes selection more effective.

Interactions between Beneficial and Deleterious Mutations

We have seen that a sexual population is superior to an asexual one both in accumulating beneficial mutations and in eliminating deleterious ones. Peck (1994) pointed out that the advantage of a sexual population is still greater if both types of mutation occur simultaneously. The reason is as follows. In an asexual population, only a small proportion of individuals whose carrying the fewest deleterious mutations have a chance of leaving descendants in the distant future. It follows that only those beneficial mutations that happen to occur in this small proportion of fit individuals have an appreciable chance of establishment. No such restriction applies to a sexual population, which will therefore accumulate favourable mutations more rapidly.

Long-term and Short-term Explanations

A simple explanation of the taxonomic distribution of parthenogens is as follows. Successful parthenogenetic varieties arise rather rarely, because a number of genetic changes are needed (in particular, to suppress meiosis and to initiate development without the stimulus of fertilization). Most such varieties are apomictic (or undergo some process genetically equivalent to apomixis), because automixis produces individuals homozygous for deleterious recessives. Once such a variety

arises, it is likely to be successful in the short run, because it gains the twofold advantage discussed above, and perhaps because apomixis is a means of perpetuating a successful heterozygous genotype. However, in the long run such varieties go extinct, because they cannot evolve so readily to meet changed circumstances, and perhaps because they accumulate slightly deleterious mutations.

This is a 'group selection' explanation: sex is individually disadvantageous, but confers advantages on the population. There are two reasons why such an explanation may be valid in this case:

1. There is reproductive isolation between parthenogenetic varieties and their sexual ancestors.
2. Parthenogenetic varieties arise rarely; therefore the relatively weak force of group selection is sufficient to prevent them from replacing their sexual relatives.

The present distribution of parthenogens makes sense on this hypothesis. For example, there are many asexual 'species' of the lizard *Cnemidophorus* (most of which probably arose by hybridization between sexual species), but they have not wholly replaced the sexual forms. This suggests that there must be some short-term advantage to sex that counterbalances the twofold cost of producing males. The likely explanation is that sex generates a greater number of different genotypes, adapted to a wider range of ecological conditions.

The idea that one or a few clones cannot replace a sexual species because the latter is more widely adapted ecologically is supported by data on the fish, *Poeciliopsis monacha*. Sexual individuals coexist in many Mexican streams with parthenogenetic strains that arise by hybridization with a related species, *P. lucida*. These strains belong to a number of clones (almost certainly representing different origins by hybridization) that differ ecologically and physiologically. Vrijenhoek (1984) found that the proportion of fish in a stream that are sexual decreases as the number of clones increases (Table 12.1). His explanation is that, as the genetic

Table 12.1

The frozen niche hypothesis. The percentage of a sexual females at a locality, according to whether one, or more than one, sexual clone is present in the river system (Vrijenhoek 1984).

	Number of river systems	Number of localities	Percentage asexual (mean \pm standard deviation)
Monoclonal rivers	4	33	7.2 .3
Multiclonal rivers	4	15	66.3 1.6

variability of the asexual population increases, the number of habitats within a stream to which sexual genotypes are better adapted decreases. In this particular case, the parthenogens cannot wholly replace the sexuals, because their eggs do not develop unless stimulated by sperm from a sexual male (so-called **pseudogamy**, because the sperm contributes no genes to the new individual). However, the data do show that the ability of parthenogens to replace their sexual relatives will depend on the number of clones present. This number may be small. For example, the asexual species *Cnemidophorus uniparens* has been shown by scale-grafting to consist of a single clone. It is perhaps not surprising that it has not wholly replaced its two parental species

Summary

It is not difficult to think of reasons why sexual populations should have a long-term advantage over asexual ones. They can evolve more rapidly to meet changing circumstances, and they will suffer less from the accumulation of deleterious mutations, either stochastically (Muller's ratchet) or deterministically (if fitness effects are synergistic). This is a group selection explanation, but it is plausible, because there is reproductive isolation between the competing types, and because the origin of new parthenogenetic clones may be a rare event. The taxonomic distribution of parthenogens fits rather well with this hypothesis.

However, there are difficulties with this explanation. In particular, why are facultative parthenogens rare? A gene causing a female to produce some of their offspring sexually and some by parthenogenesis is rare? A gene causing a female to produce some parthenogenetic offspring would have a short-term advantage, similar to the advantage of a gene causing obligate parthenogenesis, yet the population would retain at least some of the advantages of sex. It may be that such a situation would be short lived: once a mechanism for apomictic parthenogenesis had arisen, there would be strong individual selection converting facultative into obligate parthenogenesis. But there is a need for further research, both empirical and theoretical.

Much of the difficulty in understanding the evolution and maintenance of sex arises because it is rare for both sex and parthenogenesis to exist in the same population (although it does occur, particularly in cyclical parthenogens), and we are therefore uncertain whether to seek individual or group advantages. I now turn to a topic where the evolution of recombination rate in sexual populations is which this difficulty does not arise, because there is within-population variation for the trait.

The Evolution of Recombination

Imagine a diploid sexual organism in which the haploid chromosome number is one, and in which no chiasmata are formed in meiosis. There would be no re-

combination: all genes inherited from one parent would be transmitted together. A population of such organisms would not gain the benefits of rapid evolution discussed above, and would accumulate deleterious mutations by Muller's ratchet just as an asexual population. Recombination depends on the independent assortment of genes on different chromosomes, and, for genes on the same chromosome, on the formation of chiasmata.

Changes in chromosome number do occur, as described in Chapter 11, but it is not clear that the changes occur in response to selection for recombination: they may be non-adaptive consequences of the presence of repeated DNA sequences, as discussed on p. 217. The situation is different for changes in the number of chiasmata. The crucial point is that genetic variability has been found within populations for the frequency of recombination between genes on the same chromosome whenever it has been looked for (for example, in *Drosophila*, *Schistocerca*, *Tribolium*, and *Neurospora*). A trait for which there is genetic variability within populations will respond to selection. There are reasons, both theoretical and experimental, to think that there is selection tending to reduce recombination. Theoretically, if there are epistatic fitness interactions, the gene combinations present in adult organisms, which have survived selection, will be superior to those generated by recombination. There is empirical evidence for this prediction (Charlesworth and Charlesworth 1975). If, as therefore seems to be the case, there is sometimes selection tending to reduce recombination, there must be counterbalancing selection tending to increase it. Otherwise we would find localized chiasmata, or achiasmatic meiosis, to be the rule rather than the exception. What is the nature of selection favouring increased recombination?

Suppose that there are two alleles at a locus R , favouring a high rate of recombination, and r , favouring a low rate. Why should selection sometimes favour allele R ? There are two possible opinions. The first is that R alleles are selected because they repair damaged DNA, or play some other essential role in meiosis. For example, in resetting the developmental programme. A number of such ideas are discussed in Michod and Levin (1988). None seem to me convincing, essentially because they cannot explain the occurrence of syngamy and meiosis, but only of diploidy. The second opinion is that R alleles are selected because they give rise to new combinations of genes in future generations. If so, selection is indirect. The alleles have no effect on the fitness of individuals in which they find themselves. Instead R alleles, by causing recombination, tend to occur in association with genes at other loci that are of high fitness. This is a hitch-hiking explanation: R alleles are given a lift in frequency because selection is favouring alleles at other loci with which they are associated. I think that the existence of crossing over in eukaryotes requires a hitch-hiking explanation.

Consider first the explanation shown in Fig. 12.10. It suggests that R alleles spread because they produce one good chromosome out of two bad ones. It can be called the 'engine and gearbox' model, because one good motorcar can be made

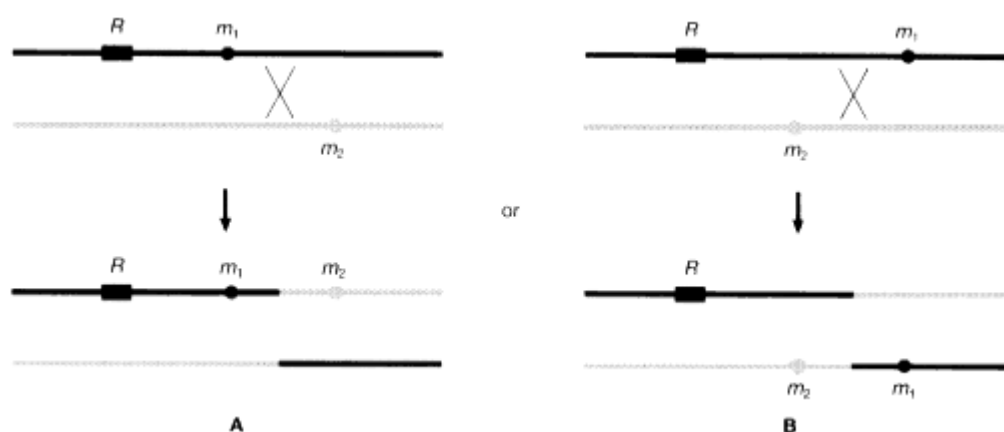

Figure 12.10

The 'engine and gearbox' model of recombination. A gene R mediates recombination between two lethal mutations, m_1 and m_2 . In case **A**, gene R is no worse off, because it was already linked to a lethal; in case **B**, gene R is better off. Selection is supposed to act on the haploid phase.

from two corks by taking the engine from one and the gearbox from the other. In this simple form, I think the argument is fallacious. The figure suggests that the R allele always starts out linked to a deleterious gene. But, as shown in Fig. 12.11, if genes are in linkage equilibrium, an R allele is just as likely to start out linked to no deleterious genes and to finish up linked to such a gene, as it is to start out (as in Fig. 12.10) linked to a deleterious gene and to finish up linked to no such gene. In short, it is as likely to lose as to gain by causing recombination.

The moral is that selection will alter the frequency of R alleles if, and only if, there is linkage disequilibrium. In seeking a hitch-hiking explanation, therefore, the first question is: what is the cause of the linkage disequilibrium? There are two possible answers:

1. chance: that is, the effects of finite population size;
2. selection: that is, epistatic fitness effects.

Consider first the effects of chance. In fact, we have already discussed two examples. The argument illustrated in Fig. 12.7 does assume a finite population. Thus, let the initial frequencies of the favourable alleles A and B be P_A and P_B , respectively. If the population were infinite, and fitnesses multiplicative, the initial frequency of the optimal genotype AB , would be $P_A P_B$. The frequency of this genotype would increase at a rate unaffected by recombination. But suppose the population were finite. The expected frequency of AB would be $P_A P_B$, as before, but, if P_A and P_B are small, the actual number of AB individuals would probably be zero. Therefore evolution in the absence of recombination would have to wait for a B mutation in an A individual, or vice versa. Similarly, the Muller's ratchet mechanism also depends on finite population size.

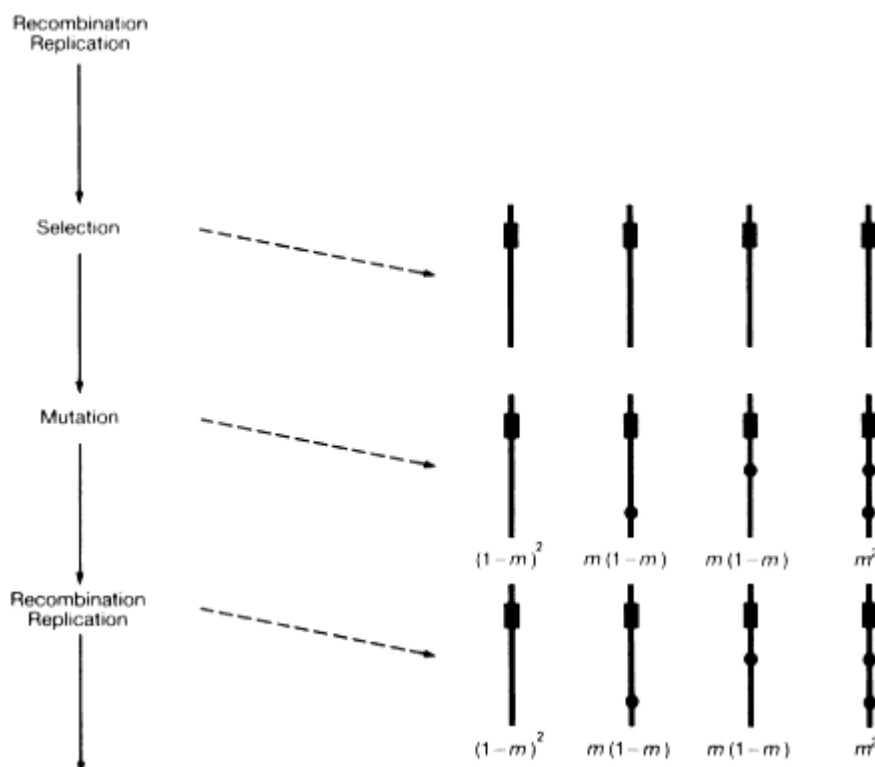

Figure 12.11

Recombination and linkage equilibrium. ■ represents a gene R mediating recombination. ● represents lethal mutations. After selection, there are no lethals. Mutation then produces lethals in linkage equilibrium. Therefore recombination does not alter the probability that R will be linked to a lethal, because all it does is to bring the frequencies closer to linkage equilibrium.

Thus one possible answer to our question is that linkage disequilibrium arises because of chance events in finite populations, and that R alleles are favoured in consequence. One possible objection to this argument is that the advantages of high evolution rate, or of avoiding the accumulation of deleterious mutations, were couched in terms of group advantage, and not of selection favouring one allele rather than another within a population. This objection need not be fatal. Thus, suppose that the high recombination allele, R , is recessive, and that no recombination occurs in Rr or rr genotypes. There would then be effective genetic isolation between chromosomes carrying the R and r alleles, and the 'group' advantage of that part of the population carrying R would result in an increase in frequency of R relative to r . However, we cannot get over the difficulty so easily if some recombination occurs in Rr genotypes.

I turn now to the possibility that the source of the relevant linkage disequilibrium is selection on genes with epistatic effects on fitness. We have seen

already (p. 89) that normalizing selection generates linkage disequilibrium between polygenes. However, normalizing selection would also favour alleles that suppress recombination. In contrast, if a population is under directional selection for a polygenic trait, then genes for high recombination will increase in frequency, provided that they are linked to the genes determining the selected trait. In brief, the mechanism is as follows:

1. Directional selection generates negative (that is, + - + -) linkage disequilibrium, which is less in rec^+ chromosomes (that is, chromosomes carrying the high recombination allele CH) than in rec^- chromosomes. This is not intuitively obvious, because + + + + chromosomes are the most favoured, so one might expect positive linkage disequilibrium: the reason for negative disequilibrium is given in Box 12.3.
2. In consequence, the rec^+ chromosomes contribute more to the genetic variance of the selected trait. Therefore they respond more to selection: that is, they accumulate selected alleles more rapidly.

Box 12.3—

Directional Selection Generates Linkage Disequilibrium

For simplicity, consider a haploid with two alleles at each of two loci, with additive effects on the selected phenotype, so that $ab = 0$; $aB, Ab = 1$; $AB = 2$. Let the initial gene frequencies be 0.5, and the linkage disequilibrium $D = 0$. Suppose that fitness increases linearly with phenotype, so that $ab = 1 - s$; $aB, Ab = 1$; $AB = 1 + s$. Table 12.2 shows that, after one generation of selection, $D = -s^2/16$, which is negative.

If fitness increases multiplicatively with phenotype $ab = 1$; $aB, Ab = 1 + s$; $AB = (1 + s)^2$ it is easy to see that D would remain at zero. Although this has been shown only for a numerical case, it is in general true that if fitnesses combine multiplicatively, then, if D is initially zero, it will remain at zero. But if, as will usually be the case, the increase in fitness is less than multiplicative, D will become negative.

Table 12.2

Directional selection generates linkage disequilibrium

Genotype	ab	aB	Ab	AB
Frequency	0.25	0.25	0.25	0.25
Fitness	$1 - s$	1	1	$1 + s$
Frequency after selection	$0.25(1 - s)$	0.25	0.25	$0.25(1 + s)$

Before selection, $D = 0$

After selection, $D = (1-s)(1+s)/16 - 1/16 = -s^2/16$.

3. Therefore, the rec^+ chromosomes increase in frequency: that is, the allele for high recombination CH , increases relative to the allele for low recombination CL .

Figure 12.12 shows a computer simulation illustrating this process.

A final possibility is that, even in a constant environment, deleterious mutations

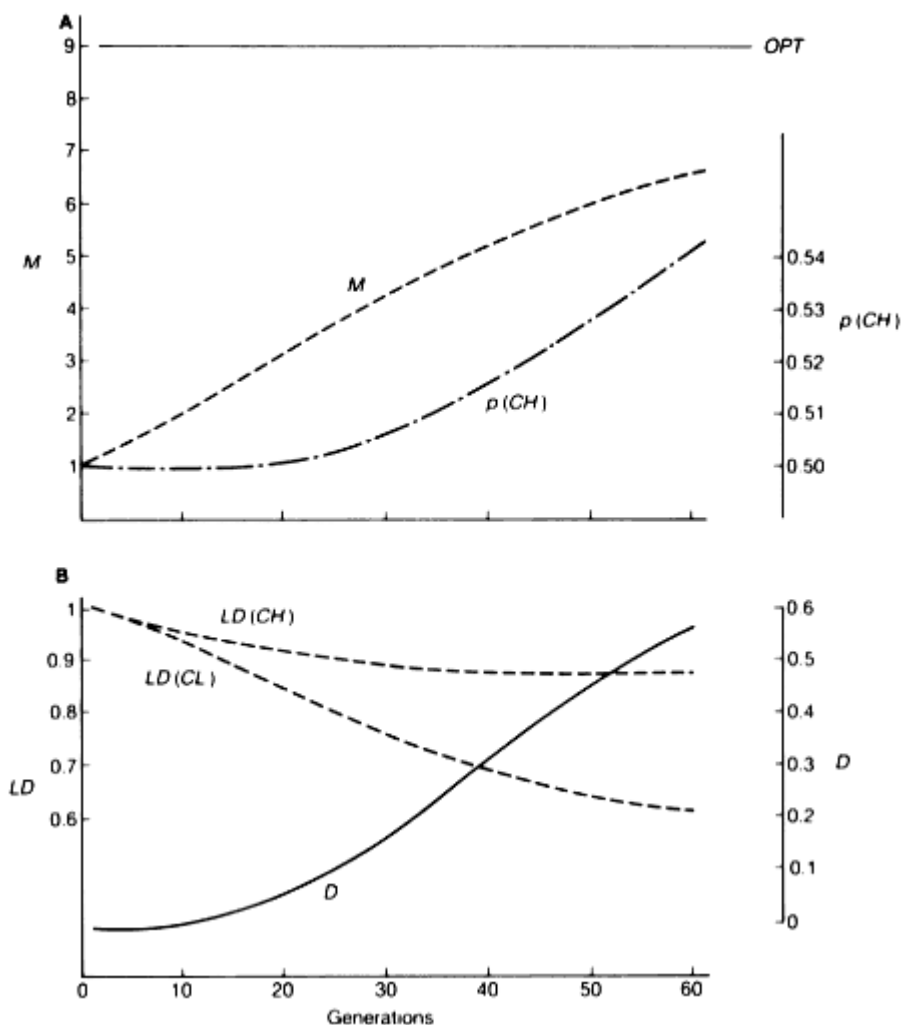

Figure 12.12

Simulation of the effects of directional selection on recombination (Maynard Smith 1988), in a six-locus polygenic model. **A:** OPT , optimal phenotype; M , population mean; $p(CH)$, frequency of allele for high recombination. **B:** D , difference in phenotype between individuals carrying only the high recombination (CH) or the low recombination (CL) chromosomes. $LD(CH)$ and $LD(CL)$ are measures of the linkage disequilibrium in the CH and CL chromosomes. $LD(CH) = V/V_{LE}$, where V is the actual variance of a population carrying CH chromosomes, and V_{LE} is the variance of a population carrying chromosomes with the same allele frequencies, but in linkage equilibrium. Thus $LD(CH) = 1$ if there is linkage equilibrium, and $LD(CH) < 1$ if there is negative (+ - + -) disequilibrium. $LD(CL)$ has a similar meaning for the CL chromosomes.

		Eliminating bad genes	Combining good genes
Origin of linkage disequilibrium	Chance	Muller's ratchet	Fisher-Muller
	Selection	Kondrashov, Feldman <i>et al.</i>	Parasites, shifting optimum

Figure 12.13

A classification of models in which selection favours alleles for high recombination.

will occur. If the effects of these mutations on fitness are multiplicative, then recombination is irrelevant (except in a finite population, because of the ratchet). But if the effects of deleterious mutations are synergistic, so that to have several such mutations has a greater deleterious effect than would be expected from the action of each by itself, then it can be shown (Feldman *et al.* 1980; Kondrashov 1982) that selection again favours alleles for recombination.

The argument of this section is summarized in Fig. 12.13. Models in which selection favours alleles for higher recombination rates can be classified by two criteria:

1. Is the source of the relevant linkage disequilibrium chance in a finite population, or selection on genes with epistatic fitness effects?
2. Is selection favouring the spread of new allele combinations in a changing environment, or eliminating unfavourable alleles in a constant one?

This two-way classification gives four types of model. Examples of each have been discussed, and are summarized in the figure.

The relative importance of these different processes is hard to evaluate. One possible approach is illustrated by the data in Fig. 12.14. The 'excess chiasma number' N , is the average number of chiasmata per meiosis, minus the haploid chromosome number. The logic of this is that one chiasma is needed per bivalent to ensure proper disjunction. It is clear that N increases with age at maturity. This suggests that models involving evolution in a changing environment may be the relevant ones, because selection may be more intense if generation time is long. The suggestion is confirmed by the fact that N is unusually high in domesticated animals, which have been exposed to intense artificial selection. No correlation was found between N and fecundity, although such a correlation would be

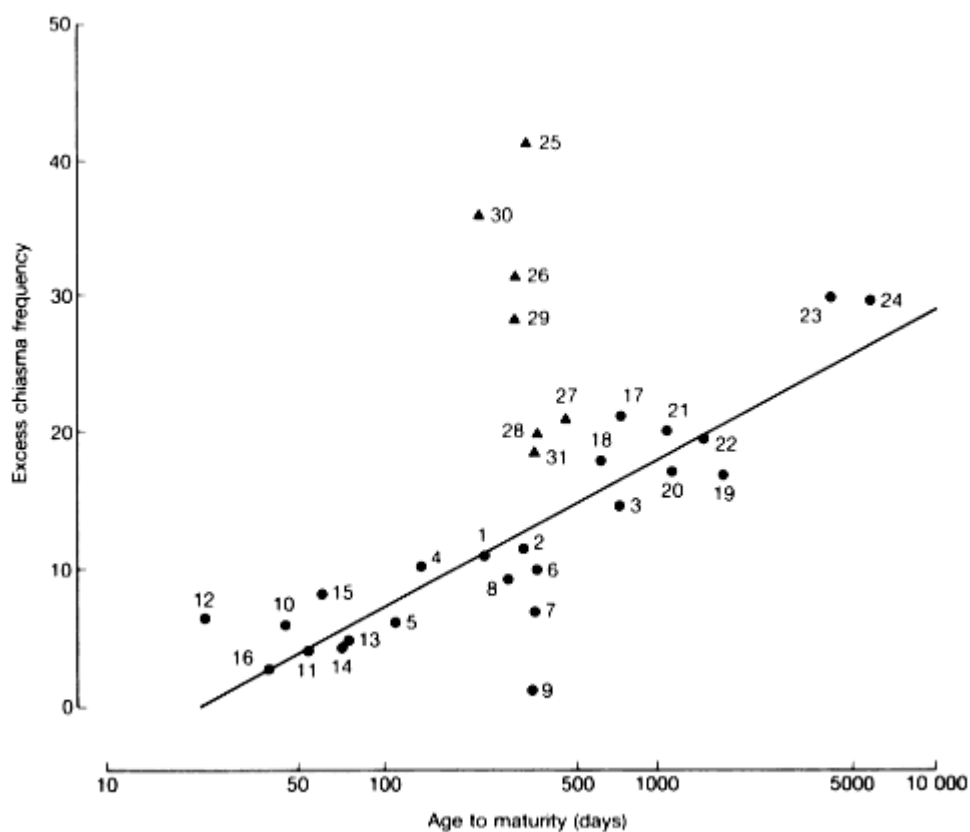

Figure 12.14

Chiasma number in male mammals, plotted against age to maturity. Excess chiasma number is the number of chiasmata, minus the haploid chromosome under. ■, Seven species of domestic mammal (not used in calculating the regression line). (After Burt and Bell 1987.)

expected if sib competition is an important process. No correlation was found between haploid chromosome number and either age at maturity or fecundity. This suggests that haploid chromosome number, unlike N , has not been adjusted to match life history variables.

Further Reading

Bell, G. (1982). *The masterpiece of nature*. University of California Press, Berkeley.

Michod, M. and Levin, B.R. (ed.) (1988). *The evolution of sex: an examination of current ideas*. Sinauer, Sunderland.

Maynard Smith, J. (1978). *The evolution of sex*. Cambridge University Press.

Williams, G.C. (1975). *Sex and evolution*. Princeton University Press.

**Chapter 13—
The Evolution of Genetic Systems:
II. Some Consequences of Sex**

The sex ratio	<u>251</u>
Selfing and outcrossing	<u>255</u>
Hermaphroditism	<u>255</u>
Sexual selection	<u>258</u>
Further reading	<u>263</u>
Problems	<u>263</u>
Computer projects	<u>264</u>

In this chapter, I assume sexual reproduction, and discuss some consequences.

The Sex Ratio.

It is a familiar fact that, in most dioecious species, there are approximately equal numbers of males and females. Why should this be so? One answer would be that, in most species, sex is determined by the segregation of X and Y chromosomes in the meiosis of the heterogametic sex (usually the male), and that meiosis generates a 1:1 ratio. This is true enough as far as it goes. If it were selectively advantageous to do so, however, organisms would surely have evolved some mechanism that produced a sex ratio different from 1:1. We therefore want a selective explanation for this ratio.

For the present, assume that the sex ratio is determined by genes acting in the parent: for example, genes could act in the heterogametic sex by altering the ratio of male- and female-determining gametes produced, or, in the homogametic sex, by altering the success of the two types of gamete in fertilization. However, I assume that a gene in a parent cannot alter its own likelihood of being transmitted to a gamete.

First, consider a verbal explanation of the 1:1 ratio. Suppose that there were more females in the population than males. Then males will have, on average, more children than females. Therefore, a gene acting in a parent would be transmitted to more descendants if it could cause that parent to produce the rarer sex—that is, sons. Similarly, if there were more males in the population than females, a gene causing parents to produce females would spread. Hence the only evolutionarily stable sex ratio would be 1:1, because only then is the reproductive value of a son equal to that of a daughter. This argument, originally due to R.A. Fisher, is made more precise in Box 13.1. In fact, it is shown that it is not the numbers of males and females that are equal at equilibrium, but the parental expenditure on males and females: if the costs of a son and a daughter are equal, equal expenditure implies a 1:1 ratio.

**Box 13.1—
The Evolution of Stable Sex Ratios**

Suppose that a pair can produce m sons and f daughters, where

$$m + kf = C. \quad (13.1)$$

In this equation, C represents the total possible 'expenditure' on offspring, and a daughter costs k times as much as a son.

Consider a random-mating population in which typical pairs produce m^* sons and f^* daughters. A rare dominant gene M causes females to produce m sons and f daughters, and is not expressed in males (an exactly similar conclusion follows for a gene expressed only in males). The frequency of $M/+$ females is P , and of $M/+$ males is p . P and p are small, so we can ignore M/M genotypes, and matings of $M/+ \times M/+$. If we ignore terms in P^2 , Pp , and p^2 , we have the values in Table 13.1.

Table 13.1

Evolution of the sex ratio in diploids

Mating		Frequency	Offspring per pair			
♀	♂		male $M/+$	$+/+$	female $M/+$	$+/+$
$M/+$	$+/+$	$P(1-p) \approx P$	$m/2$	$m/2$	$f/2$	$f/2$
$+/+$	$M/+$	$p(1-P) \approx p$	$m^*/2$	$m^*/2$	$f^*/2$	$f^*/2$
$+/+$	$+/+$	$(1-P)(1-p) = 1 - P - p$	—	m^*	—	f^*

Hence, among the offspring:

$M/+$ males	$Pm/2 + pm^*/2$,
$M/+$ females	$Pf/2 + pf^*/2$,
total males	$m^*(1-P) + mP = m^*$,
total females	$f^*(1-P) + fP = f^*$.

Hence, if P' and p' are the frequencies of $M/+$ females and males, respectively, in the next generation, we have

$$\begin{aligned} P' &= \frac{1}{2}P \frac{f}{f^*} + \frac{1}{2}p, \\ p' &= \frac{1}{2}P \frac{m}{m^*} + \frac{1}{2}p, \end{aligned} \quad (13.2)$$

Adding these equations gives

$$\begin{aligned} (P' + p') &= \frac{1}{2}P \left(\frac{f}{f^*} + \frac{m}{m^*} \right) + p, \\ &= (P + p) + RP, \end{aligned} \quad (13.3)$$

where

$$R = \frac{1}{2} \left(\frac{f}{f^*} + \frac{m}{m^*} \right) - 1. \quad (13.4)$$

Note that when $f = f^*$ and $m = m^*$, $R = 0$; that is, $(P + p)$ neither increases nor decreases. This is as expected, since gene M has no effect.

From Equation 13.1, $f = (C - m)/k$, and $f^* = (C - m^*)/k$. Substituting in Equation 13.4 and rearranging gives

$$R = \frac{(C - 2m^*)(m - m^*)}{2m^*(C - m^*)}. \quad (13.5)$$

Now if $R > 0$, the mutant M increases in frequency. Hence, if $m^* < C/2$, the mutant M increases in frequency if $m > m^*$, and if $m^* > C/2$, M increases in frequency if $m < m^*$. That is to say, if $m^* < C/2$, mutants increasing m^* will invade, and if $m^* > C/2$, mutants reducing m^* will invade. Hence the evolutionarily stable sex ratio is $m^* = C/2$. This implies that $m^* = kf^*$, and hence that expenditure on sons and daughters is equal. The best way of seeing what this means in practice is to work through the examples at the end of this chapter.

The stable sex ratio for a haplo-diploid species can be found in the same way. Table 13.2 lists the possible matings. Hence, in the next generation,

$$P' = \frac{P}{2} \frac{f}{f^*} + p,$$

$$p' = \frac{P}{2} \frac{m}{m^*}.$$

Table 13.2

Evolution of the sex ratio in haplo-diploids

Mating		Frequency	Offspring per pair			
♀	♂		male		female	
			$M/+$	$+$	$M/+$	$+/+$
$M/+$	$+$	$P(1-p) = P$	$m/2$	$m/2$	$f/2$	$f/2$
$+/+$	M	$p(1-P) = p$	—	m^*	f^*	—
$+/+$	$+$	$(1-P)(1-p) \approx 1 - P - p$	—	m^*	—	f^*

Hence, among the offspring:

M males	$Pm/2$,
$M/+$ females	$Pf/2 + pf^*$,
total males	m^* ,
total females	f^* .

Adding these equations gives

$$(P' + p') = \frac{1}{2}P\left(\frac{f}{f^*} + \frac{m}{m^*}\right) + p.$$

This is identical to Equation 13.3, so we again conclude that, at equilibrium, expenditure on sons and daughters is equal.

Exceptions to the rule are of particular interest. In some populations of the mosquito *Aedes aegypti*, there is a great excess of males, caused by a Y-linked gene *M*. Males carrying this gene produce an excess of sons, because X chromosomes are broken during meiosis, and sperm carrying deficient X chromosomes degenerate. If this were the whole story, natural populations of *Aedes aegypti* would consist mainly of males, and would be close to extinction. However, there are resistant X chromosomes, able to suppress the action of *M*. As one would expect, X chromosomes from Africa and central America, where *M* is commonly found, tend to be resistant.

In this example, Fisher's prediction of a 1:1 ratio fails, because one of its basic assumptions does not hold: the gene *M* does affect its own likelihood of being transmitted. This is an example of **meiotic drive**. Another assumption of Fisher's argument is that all males have an equal chance of mating, as do all females. If this assumption is false, this too can lead to a distorted sex ratio. The phenomenon, first described by Hamilton (1967), is the case of **local mate competition**. Consider a parasitic insect that lays several eggs in a host caterpillar. These eggs hatch and develop within the host, and pupate there. They then emerge and mate with one another before dispersing. If only one female lays eggs in each host, then females are mated by their brothers. What sex ratio should a female produce if she is to maximize the number of genes she transmits to future generations? Clearly, she should produce one son, and the rest of her offspring should be female.

Do parasitic animals with this life history produce female-biased sex ratios? The question has been studied mainly in haplo-diploid organisms, for two reasons. First, many haplo-diploids (particularly hymenoptera, and some mites) have the appropriate life history. Secondly, females of haplo-diploid species can choose the sex of each offspring, by fertilizing, or not fertilizing, each egg. Hence haplo-diploids are ideal for testing ideas about sex ratio evolution. In fact, parasitic haplo-diploids often produce highly female-biased sex ratios, as the theory predicts. The extreme example is a mite, *Acarophenax*, in which the female produces live young: the single male in the litter hatches, mates with his 15 or so sisters, and dies before he is born.

Before we accept these data as confirming theories about local mate competition, we must be satisfied that the biased sex ratios are not a direct adaptation

to haplo-diploidy. Box 13.1 shows that Fisher's prediction of a 1:1 ratio does apply to random-mating haplo-diploids. In fact, haplo-diploids that are neither parasitic nor social do have approximately equal sex ratios.

Selfing and Outcrossing

This section shows that there is strong selection favouring selfing in hermaphrodites. Since, in fact, selfing is the exception rather than the rule, there must also be strong selection against it: the obvious disadvantage is the low fitness of inbred offspring.

Consider first a hermaphroditic plant species, containing selfing and outcrossing individuals. Suppose that an outcrossing individual has, on average, n surviving offspring as the seed parent, and N offspring as the pollen parent. A selfing individual will transmit genes to the next generation in three ways:

- (1) via its own seed;
- (2) via its own pollen that fertilizes its own seed; and
- (3) via its pollen that fertilizes seed from other plants.

If, as seems reasonable, the quantity of pollen needed to fertilize its own seed is negligible compared to the total pollen produced, the selfing plant will have, by route (3), the same number of offspring, N , as an outcrossing plant. Hence, in comparing the fitnesses of the two types of plant, we need only take into account routes (1) and (2). If selfing and outcrossing plants produce the same number of seeds, and if those seeds are equally likely to survive to become adults, the selfer will transmit $2n$ genes for every n genes transmitted by the outcrosser. Clearly, selfing would increase in frequency very rapidly.

If the survival chances of offspring produced by selfing is $1 - s$ times that of offspring produced by outcrossing, then selfing will increase in frequency if $2(1 - s) > n$, or $1 - s > n/2$. This implies that the deleterious effects of inbreeding must be very severe if selfing is not to spread. The real situation is somewhat more complex, because the fitness of selfed progeny will depend on the number of generations of selfing (see Fig. 6.6, p. 104). It seems that, in most hermaphrodite species, the effects of inbreeding are severe enough to prevent the spread of selfing, but that, occasionally, the crisis of inbreeding illustrated in Fig. 6.6 is passed, and a reasonably viable selfing species evolves. Once it has arisen, it is unlikely to revert to outcrossing. Instead, investment in pollen, and in attractive flowers, is reduced.

Hermaphroditism

Why are some species hermaphroditic and others dioecious? To answer this question, we will ask whether a gene for hermaphroditism could invade a dioecious population. This is equivalent to asking whether the reproductive success of a

hermaphrodite, when rare, is greater than that of males and females. In what follows, I assume that hermaphrodites are effectively self-sterile.

Let R_m and R_f be the reproductive success of males and females, respectively. At equilibrium, if there is a 1:1 sex ratio, males and females have equal numbers of offspring: that is $R_m = R_f$. Let the reproductive success of a hermaphrodite be αR_m as a male, and βR_f as a female: α and β represent the potential reproductive success of a hermaphrodite. Clearly, since $R_m = R_f$, hermaphroditism can invade if $\alpha + \beta > 1$. Different hermaphrodites could allocate their resources between male and female functions differently, and so have different values of α and β . The set of all possible hermaphrodites can be represented by the set of all possible pairs of values of α and β . If this set is convex (Fig. 13. **A**), hermaphroditism will replace dioecy: if the set is concave (Fig. 13. **B**), dioecy will be evolutionarily stable.

What features will tend to make the set either convex or concave? Probably the main factor making for a convex set is a 'law of diminishing returns' on investment in gametes of a given sex. This supposes that, in a hermaphroditic plant, the production of pollen and of seeds is limited, at least in part, by the same resources. If so, a hermaphrodite might produce exactly half as much pollen as a male, and half as many seeds as a female. However, it is likely that a male that produced twice as much pollen as a hermaphrodite would not pollinate twice as many seeds, because of competition between its own pollen: if a plant produced enough pollen to fertilize all the seeds of a neighbour, it would not gain by producing twice as

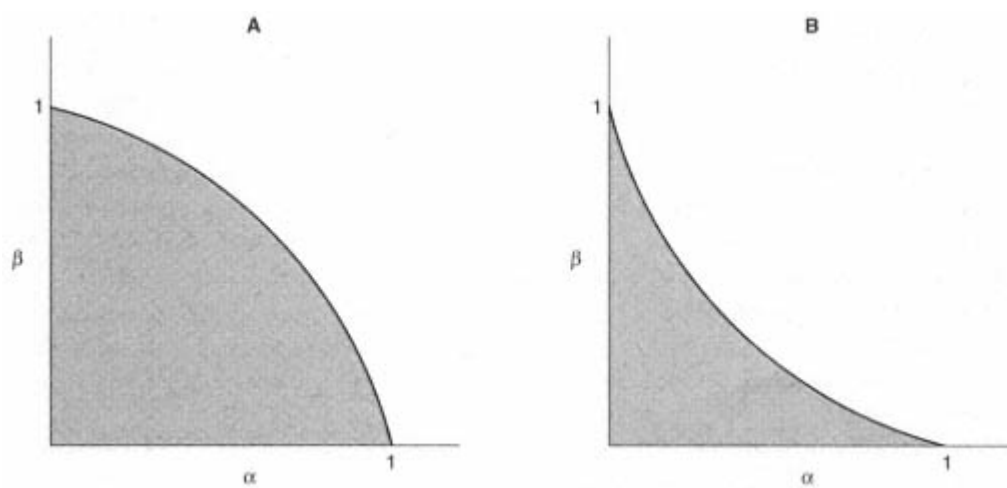

Figure 13.1

The evolution of hermaphroditism. α is a measure of the success of a hermaphrodite as a male, relative to a pure male; β is the breeding success of a hermaphrodite as a female, relative to a pure female.

The shaded areas represent the set of possible phenotypes. For a convex set, **A**, hermaphroditism is the evolutionarily stable state; for a concave set, **B**, dioecy is stable.

much pollen. Because of pollen competition, $\alpha > 1/2$. There may be a similar law of diminishing returns affecting seed production, if the seeds from a single plant compete with one another. If $\alpha\beta > 1/2$. Now if either $\alpha > 1/2$, $\beta = 1/2$; or $\alpha = 1/2$, $\beta > 1/2$; the set is convex, and hermaphroditism is favoured.

A second factor favours hermaphroditism in animal-pollinated plants: the same expenditure on petals and nectar serves both male and female functions. The effect of this is to produce a convex set (see Box 13.2). This may explain why dioecy is rarer in animal-pollinated than in wind-pollinated plants.

Box 13.2—

Resource Allocation in Hermaphrodites

Suppose that a single flower can produce n_1 seeds, each at a cost s , and N_1 pollen grains, each at a cost t , and that the cost of petals, nectar, etc. is u . Then the total cost of a hermaphrodite flower is $u + n_1s + N_1t$.

If the total expenditure by the plant is C , then a female plant produces $Cn_1/(u + n_1s)$ seeds, a male plant produces $CN_1/(u + N_1t)$ pollen grains, and a hermaphrodite produces $Cn_1/(u + n_1s + N_1t)$ seeds, and $CN_1/(u + n_1s + N_1t)$ pollen grains. Hence

$$\alpha = \frac{u + n_1s}{u + n_1s + N_1t} \quad \text{and} \quad \beta = \frac{u + N_1t}{u + n_1s + N_1t}.$$

Hence

$$\alpha + \beta = \frac{2u + n_1s + N_1t}{u + n_1s + N_1t}.$$

Thus $\alpha + \beta > 1$, and the set is convex. Further, the degree of convexity increases with the expenditure on attracting pollinators.

The main factor tending to make the set concave is the existence of organs which serve only one of the two sexual functions. For example, a male red deer which invested half as much in male weapons and excess size would probably obtain fewer than half as many matings: if $\alpha < 1/2$.

It is not surprising that most higher plants are hermaphrodites (strictly, the word hermaphrodite is used only for a plant whose flowers contain both male and female organs; however, monoecious plants, with separate male and female flowers on the same individual, obtain some of the resource-allocation advantages of hermaphrodites, and have the additional advantage of being less likely to self). Indeed, it is surprising at first sight that any plants should be dioecious. One reason may be that dioecy prevents self-fertilization. The 'law of diminishing returns' argument is supported by the fact that, in both gymnosperms and angiosperms (Table 13.3), dioecy is commoner in plants with animal-dispersed than wind-dispersed seeds: with wind dispersal (or often, non-dispersal), competition between

Table 13.3

The relation between breeding system and method of seed dispersal in angiosperms; numbers and percentages of angiosperm families (after Givnish 1982)

	Dioecy	Monoecy	Hermaphroditism
Seeds swallowed by animals	17 (27%)	3 (5%)	43 (68%)
Other modes of dispersal	10 (7%)	15 (11%)	117 (82%)

offspring of the same parent is likely to be more intense. Givnish (who collected the data in Table 13.3) has also argued that, in a species that attracts frugivores, a plant that produces twice as many fruits will attract more than twice as many animals, an increasing return on investment that would favour dioecy.

Sexual Selection

Darwin suggested the process of sexual selection to meet a difficulty that confronted his concept of natural selection. This difficulty is that some characteristics of animals do not seem to contribute either to their own survival, or that of their offspring. Such traits are the antlers of deer, and the plumage of male pheasants, peacocks, and birds of paradise. One might argue that antlers can be used in defence against predators: but if so one would expect them to be present in females also. Darwin suggested that these characteristics evolved because of selection operating during the acquisition of mates. He saw this as happening in one of two ways:

1. Competition between members of the same sex for access to mates. Usually, but not always, there is competition between males for access to females. This is because, in many species, the fecundity of a female is limited by her ability to lay eggs (or, in mammals, to bear and nurse her young), so that her fecundity would not be increased by access to more males, although, as Darwin pointed out, the fitness of her offspring could be affected by which particular male she mated with. In contrast, in a species with no paternal care, a male's fitness is increased by access to more females. Hence male competition for access to females is common. This analysis is borne out by the fact that in some species, such as sea horses and jacanas (wading birds), in which parental care is by the males only, females compete for access to males.
2. Choice by members of one sex of particular members of the opposite sex. In polygamous species, the choice is by females of males, but in monogamous species it may involve both sexes.

The first of these two processes does not present any special difficulty. The 'size game' described in Chapter 7 was originally developed as a model of male-male competition. The process can lead to an increase in size or weapons in one sex well

beyond the level that would evolve in the absence of such intra-sex competition. It is also likely to lead to sexual dimorphism in size. Figure 13.2 shows that, in primates, sexual dimorphism in size is greater in species in which a male can have access to more than one female than it is in monogamous species. The figure also shows that, in polygynous species, the degree of sexual dimorphism increases with size. It is not obvious why this should be so. One possible explanation is as follows. In polygynous species, male-male competition for mates leads to an increase in male size. Since most genes affecting size will affect both males and females, there will be a size increase in both sexes. But, because natural selection favours smaller size, and some genes have sex-limited effects, there will also be an increase in dimorphism. Hence both size and dimorphism will increase in evolutionary time: the species lying on the sloping regression line represent different stages in an evolutionary progression.

There are greater difficulties with Darwin's idea of choice. By female choice we mean any structure or behaviour in a female that makes her more likely to mate

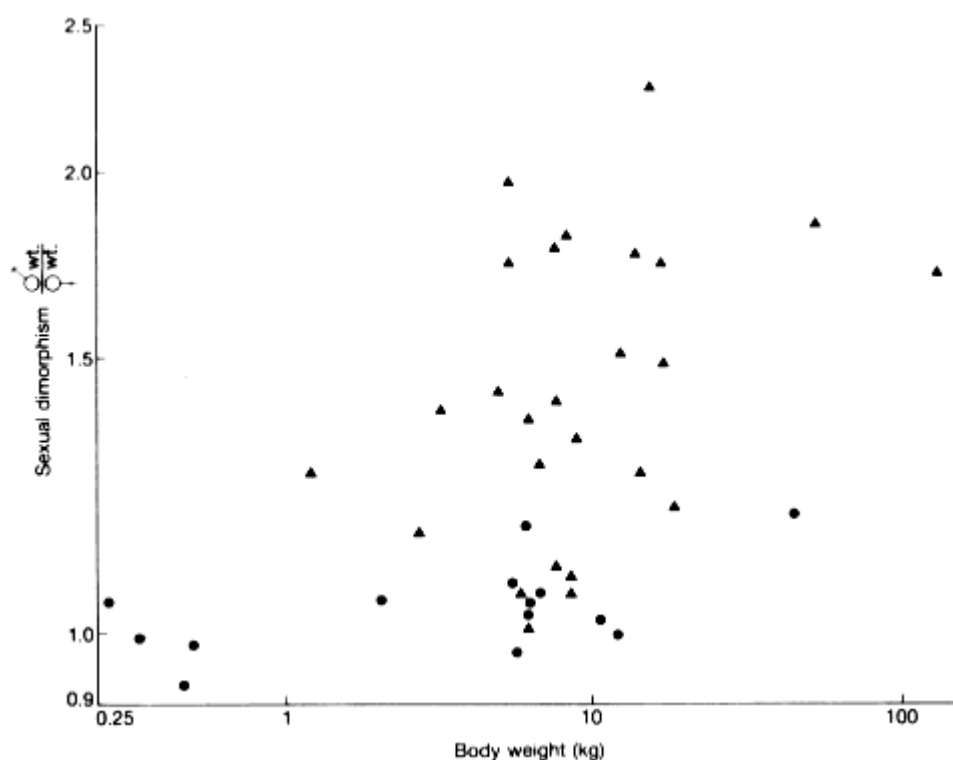

Figure 13.2

Sexual dimorphism and body weight in primates. The 'socionomic sex ratio' is the mean number of adult females per adult male in breeding groups. Species with a ratio of one (usually, the breeding group is a monogamous pair); ▲, species with a ratio greater than one. (Adapted from Clutton-Brock *et al.* 1977.)

with one male than another. I first give some evidence that choice in this sense exists, and then discuss why it has evolved. In *Drosophila subobscura*, when an unmated outbred female is placed with a young outbred male, mating almost always takes place within an hour, and usually within 15 minutes. If the male was inbred, however, mating took place in only about 50 per cent of cases within one hour (Maynard Smith 1956). This was not because the inbred males did not court or attempt to mount the females: they made repeated attempts to do so. The explanation lies in the courtship dance of the female. When approached by a male, she moves rapidly from side to side. The male attempts to move so as to keep facing her. If he succeeds, she stands still and allows the male to mate. If he lags too far behind, she moves away, and kicks off the male if he attempts to mount (as inbred males often did). Inbred males failed to mate because they failed to keep facing the female. This conclusion is confirmed by the fact that old males, and males carrying mutations affecting their locomotion or vision, also fail to mate.

The courtship dance of *D. subobscura* meets the definition of choice given above: it is a behaviour that makes a female more likely to mate with some males than others. However, the experiment did not demonstrate any genetic variance in choice: this is important, because a trait will only evolve if it is heritable. The existence of heritable variability in choice has been demonstrated in the ladybird *Adalia bipunctata*, by Majerus *et al.* (1983). In natural populations, melanic males have a higher mating success than non-melanics. Selection experiments, in which females that mated with melanics were chosen as parents of the next generation, demonstrated that there are genetic differences between females in the degree of preference they show for melanic males.

There is no reason to doubt, then, that female choice exists, and that it is variable. But why should it evolve? Darwin himself did not answer this question. There are a number of possible answers:

1. The choice is an unselected consequence of characteristics that evolved for other reasons. For example, female natterjack toads move towards calling males. By using loudspeakers, Arak (1983) showed that females move up a sound gradient. This would lead them to mate preferentially with the loudest males, but the behaviour could have evolved merely to ensure that the female mates with some male.
2. Females have been selected to mate with members of their own rather than other species. This is discussed further on p. 270. There can be little doubt that selection for species recognition occurs, and may have unselected consequences on choice between conspecifics. But it is hard to believe that such selection could, by itself, lead to the extreme elaboration of secondary sexual characters that worried Darwin.
3. Females have been selected to mate with males of high viability. If, for example, males differ in their load of deleterious genes, then a female that was able to

detect these differences, and mate with a male with few deleterious genes, would have offspring of higher-than-average fitness. Hence a gene causing her to choose would be transmitted to more descendants. It is tempting to interpret the behaviour of female *D. subobscura* in this way, although there is no evidence that, in nature, males with the athletic ability required for the courtship dance have, on average, fitter offspring. However, many animal courtships have the effect of testing the sensory and locomotor skills of the participants, and female choice of males of high viability is a plausible explanation.

4. If males with some trait, T , are, for whatever reason, preferred by females, then they get more matings, and are therefore fitter than males without the trait. Therefore it pays females to mate with T males. Hence both T , and the preference for T , are selected. This idea is due to R.A. Fisher, who thought that it could lead to a runaway process, in which both trait and preference were further elaborated. Fisher recognized that his process had to get started in some way: that is, there had to be some female preference initially present to prime the process. This initial preference could arise for any one of the three reasons listed above, but once it was present, Fisher argued, it could lead to extreme exaggeration of both the selected trait and the preference.

Fisher's argument is hard to follow. A number of attempts have been made to model it (e.g. O'Donald 1967; Lande 1981a; Kirkpatrick 1982). Box 13.3 describes Kirkpatrick's model. The consensus of a number of recent papers seems to be as follows. Given some initial preference for a trait T , sexual selection can cause it to evolve to a degree different from that favoured by viability selection alone. There is still debate about the significance of the line of equilibria, which is a feature of the models of Lande and Kirkpatrick. There is also debate about the extent to which an association will evolve between sexually selected traits, and traits that confer high viability in other contexts.

There is one feature common to these models of sexual selection that it is important to grasp. The gene or genes responsible for female choice do not increase the fitness of females that carry them. Either the choice genes have no effect on female fitness, as in the early models referred to above, or, if there is a cost to choice, in time expended or in other ways, the choice genes actually lower female fitness. They are not expressed in males at all. How, then, can selection increase their frequency? The answer is that, because of assortative mating, the choice genes are in linkage disequilibrium with genes that do affect fitness (remember that linkage disequilibrium does not require that the genes be on the same chromosome). For example, in Kirkpatrick's model, the choice gene P , and the gene determining the selected trait, T , will be positively associated, because P females tend to mate with T males. If T males are fitter than non- T (because of their high mating success), then as T increases in frequency, P will increase also because of linkage disequilibrium.

**Box 13.3—
A Model of Sexual Selection**

Kirkpatrick (1982) considers a sexual haploid population with two loci, and two alleles at each locus. Allele T determines the presence of some trait—say a long tail—and t its absence. The locus is not expressed in females. T males have a viability $1 - s$ times that of t males.

Females with allele P mate preferentially with T males. p females mate randomly. The locus is not expressed in males. Preference works as follows: if p_T is the frequency of T , and $1 - p_T$ of t , then a P female mates with a T male with probability $\alpha p_T / (\alpha p_T + 1 - p_T)$. Then $\alpha > 1$ implies a preference for T .

This model can be treated analytically: it is also easy to simulate. The results are shown in Fig. 13.3.

Lande (1981a) analysed a polygenic model. He also concluded that there would be a line of equilibria. However, in his model, the line could be unstable.

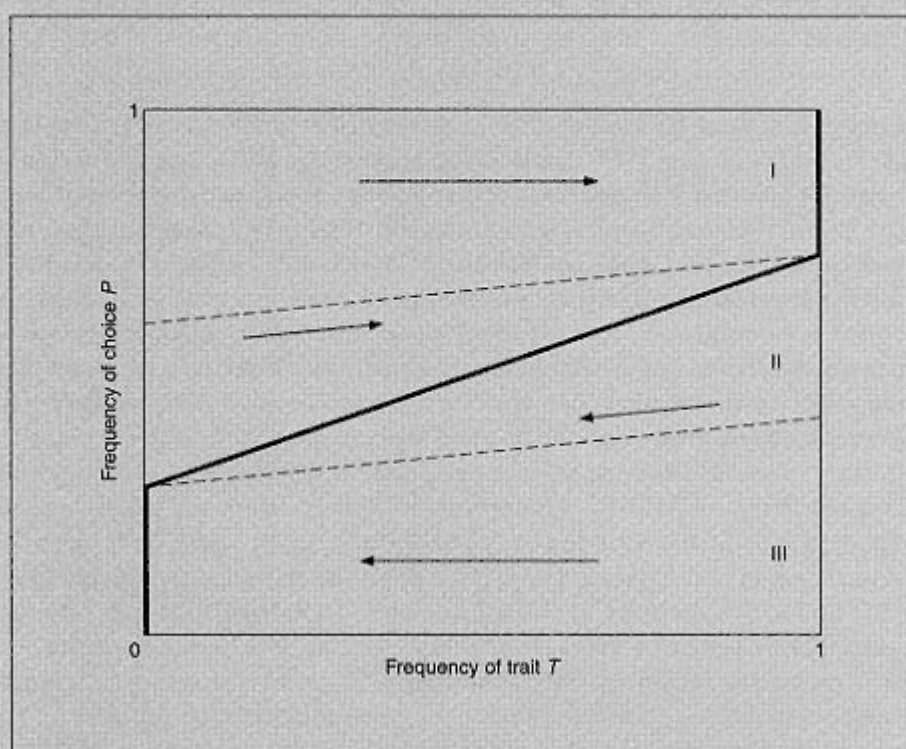

Figure 13.3 The dynamic behaviour of Kirkpatrick's model. The bold line represents the possible equilibrium states. If initial conditions lie in region I (choice common), then T is fixed; if they lie in region III (choice rare), then the more viable genotype, t , is fixed; if initial conditions lie in the intermediate region II, the population evolves to lie on the line of equilibria: if it is then disturbed,

Consequently, in a population lying initially above the line, both the trait and the preference for it would increase indefinitely, until some factor not allowed for in the model intervenes. Lande interprets this as illustrating Fisher's runaway process.

Further Reading

Bradbury, J.W. and Andersson, M. (ed.) (1987). *Sexual selection: testing the alternatives*. Wiley, New York.

Bull, J. (1983). *Evolution of sex determining mechanisms*. Benjamin Cummings, Menlo Park, California.

Charnov, E.L. (1982). *The theory of sex allocation*. Princeton University Press.

Problems

Part A In answering these questions on the sex ratio, assume (what may not be the case) that there are genes which, acting in a female, can alter, without cost, the sex ratio of her offspring at conception. For each of the following cases, do you expect a bias in the sex ratio at conception: if so, in favour of which sex? (N.B. the facts stated are only roughly true.)

1. In red deer, a hind is more likely not to breed if she produced a son in the previous year than if she produced a daughter.
2. In seals, the litter size is one. Males and females are the same weight at weaning, but males are more likely to die between weaning and sexual maturity.
3. In a mammal species with a litter size of 5-8, there are many sex-linked genes that cause death before implantation.
4. As Question 3, but the only effect of sex-linked recessives is to cause male sterility.
5. In a butterfly species (females heterogametic), there are many sex-linked recessives causing eggs to die before hatching.
6. A social spider lives in endogamous colonies, that produce new colonies by fission: there is no migration between colonies.
- 7.* An imaginary carnivore (not unlike a lion) produces litters of 2. Brothers cooperate in finding mates, so a male has a higher reproductive success if he has a brother. If a female has complete control over her sex ratio, what would you expect to happen?

Part B The answers to these questions are highly speculative: in each case, suggest an explanation for the observation, and, if possible, suggest further observations that might confirm or refute it.

1. Most annual weeds are self-fertile hermaphrodites.
2. Some plant species are 'gynodioecious': that is, there are hermaphrodites and females. Femaleness (that is, male sterility) is often caused by a cytoplasmic gene, transmitted in the ovule but not in the pollen.
3. Regular inbreeding is commoner in haplo-diploid species than in ecologically similar diploid ones.

4. Dioecy in plants is usually interpreted as an adaptation to prevent selfing; it is commoner in trees than in herbs.
5. Allopolyploidy (see Chapter 14) as a mechanism of speciation is rare in animals.

Computer Projects

1. Sexual selection. Consider a haploid sexual species with two alleles at each of two loci: T males have a long tail, and t males a short tail: their chances of survival are in the ratio 1 s :1. C females prefer to mate with T males, whereas c females mate randomly. The allele T has no effect in females, and allele C has no effect in males. First, devise a plausible formula for the frequencies of different kinds of mating, given the frequencies of T and C , and the fact that C females prefer T males. (Several different models are possible, giving different formulae: you may like to try more than one, but stick to simple formulae.) How do 'choice' and 'tail length' evolve? How does the final state of the population depend on initial conditions?
2. In a self-sterile hermaphrodite plant, a mutant A arises such that Aa and AA are self-fertile: they pollinate all their own seeds, and contribute as much pollen to the pollen pool as self-sterile aa plants. The viability of offspring produced by selfing is V_1 if the parent came from an outcross, and V_2 if the parent was itself the result of selfing. Ignore differences in fecundity. Model the evolution of such a population. If $V_1 = V_2 = V$, what value of V permits A to spread when rare? What value of V permits A to go to fixation? If $V_2 < V_1$, is a stable polymorphism possible?

**Chapter 14—
Macroevolution.**

Species and speciation	<u>267</u>
Patterns of evolution	<u>274</u>
The rate of evolution	<u>274</u>
Trends	<u>277</u>
Adaptive radiation	<u>279</u>
Extinction	<u>280</u>
Palaeontology and population genetics	<u>281</u>
Coevolution	<u>285</u>
Competition	<u>285</u>
Exploitation	<u>287</u>
Mutualism	<u>294</u>
The Red Queen	<u>295</u>
Further reading	<u>296</u>
Problems	<u>296</u>
Computer projects	<u>297</u>

This book has been concerned with processes that can be studied in contemporary populations over relatively short time-periods. Our picture of evolution on a larger scale (macroevolution) comes from comparative anatomy and embryology, from taxonomy and geographical distribution, and from palaeontology. The question naturally arises whether the processes of population genetics are sufficient to account for macroevolution. Very different views can be held on this question (see, for example, the books by Simpson and by Stanley in the Further reading section at the end of this chapter. I now briefly review some macroevolutionary phenomena with this question in mind.

Species and Speciation

Animals and plants are classified into species. Do the species of our classifications correspond to real divisions in the world, or are they merely arbitrary groupings that we need in order to communicate with one another? Are there really blue, great, coal, marsh, and willow tits in British woodlands, and western gray, dusky, and Hammond's flycatchers in the western US? In most cases (including the examples just given), the groups are real. Perhaps the most convincing evidence is the fact that pre-literate people often recognize the same species (and sometimes the same higher categories) as do modern taxonomists. If species were arbitrary divisions, this would not be so.

Three reasons have been suggested for the existence of species:

1. Only certain kinds of organism are possible. Thus consider the analogy with chemistry. There exist only a limited number of distinct elements, and a larger number of distinct compounds, because only those configurations of matter are stable. It has sometimes been argued that there are similar, but unknown, laws of biological form that permit only a limited number of distinct species. I mention this view because it has often been proposed, but I know of no

sensible reason for holding it: the facts of geographical distribution alone seem sufficient to disprove it.

2. The number of distinct ecological niches is finite, and determines the kinds of species that can exist. In a few cases, this may be true. For example, the wydah birds of Africa (*Vidua*) are brood parasites of Estrildid finches, and are usually species-specific. The nestlings mimic the pattern of spots in the gape of the host species, revealed when the nestling begs for food. The pin-tailed wydah parasitizes several species of waxbills, whose mouth patterns are the same. Thus the number of wydah species is limited by the number of potential host species. But this cannot be convincing as a general explanation. One reason is the absence of clear species distinctions in some parthenogenetic complexes, such as *Asteracium* (hawkweeds) and *Rubus* (brambles).

3. Species exist because organisms reproduce sexually. Blue tits are genetically similar to one another (and different from great tits) because they are descended from a common set of interbreeding ancestors (and great tits are descended from a different set). The two species will remain distinct in the future because they do not interbreed.

There is little doubt that the third explanation is correct. It follows that if two contemporary populations have no opportunity to interbreed, and have had no such opportunity for many generations, then it is largely a matter of convention whether we place them in the same species. The difference between such geographically isolated species may be as great as that between distinct sympatric species (**sympatric** means living in the same place; **allopatric** means living in different places), or there may be no distinguishable difference, or the degree of difference may lie anywhere between these extremes. This is what we would expect from explanation (3) above, but not from explanations (1) or (2).

This point is nicely illustrated by the birds of North America. In a number of cases (e.g. flickers, meadow larks, towhees, bluebirds, kingbirds, peewees) there are similar but distinguishable populations on the east and west coasts. Are these distinct species, or merely varieties? There are three possibilities:

1. There is a continuous series of interbreeding populations connecting the two forms. The populations are then treated as belonging to a single species.
2. There is a region of overlap between the eastern and western populations, in which they do not interbreed, but remain distinct. The populations are then placed in different species.
3. The two populations are geographically isolated. The decision as to whether they should be placed in one species or two is then a matter of convention.

It is widely agreed that the differences between species usually originate during geographical isolation: that is, speciation is allopatric rather than sympatric. The reason for this is that species typically differ at many gene loci: in the absence of geographic isolation, such a polygenic difference would be broken down by

hybridization more rapidly than it could be built up. It is in fact possible to devise processes that could lead to sympatric speciation (e.g. Maynard Smith 1966). In effect, they involve the establishment of a strongly selected single-gene polymorphism (for example, by Levene's mechanism see p. 71), followed by the association of mating isolation with that polymorphism. Such processes may occasionally occur, but no doubt allopatric speciation is the rule.

Table 14.1 classifies the processes, known as **isolating mechanisms**, that prevent the flow of genes between sympatric species. There is an important distinction between pre- and post-zygotic mechanisms. An individual that mates with a member of another species, and then produces inviable or infertile offspring, has wasted its reproductive effort. A gene causing it to be more likely to mate with a member of its own species would therefore be favoured by selection. This has led to the suggestion that pre-zygotic isolating mechanisms are the result of natural selection favouring isolation. I now discuss this possibility.

It is common to find that the most striking differences between closely related sympatric species concern characters used in mate recognition. For example, in Britain the three leaf warblers (willow warbler, chiffchaff, and wood warbler) are hard to tell apart in the field except by their songs. Closely related *Drosophila* species are often only distinguishable morphologically by examining their genitalia. However, such observations can be explained in two ways:

1. The **reinforcement** hypothesis. Genetic divergence in allopatry has reduced the viability or fertility of hybrids. After subsequent sympatry, initially slight differences in mate recognition traits have been exaggerated by selection in favour of pre-zygotic isolation.

Table 4.1

Factors that prevent gene flow between species

- I. Geographical
Species live in different places
- II. Factors preventing the formation of hybrids (pre-zygotic factors)
 - Plants*
 - A. Isolation by habitat: ecological isolation
 - B. Different flowering seasons
 - C. Pollination constancy by insects
 - D. Lack of pollen-tube growth down style of a different species
 - Animals*
 - Differences in courtship behaviour, and in signals used in mate recognition.
- III. Factors acting after the formation of hybrids (post-zygotic factors)
 - A. F_1 hybrids inviable
 - B. F_1 hybrids infertile
 - C. Hybrid breakdown: that is, F_1 hybrids viable and fertile, but F_2 and backcross hybrids inviable or infertile

2. Traits concerned in mate recognition evolve particularly rapidly, even in allopatry: pre-zygotic isolation evolves in allopatry, and not in response to subsequent sympatry and hybridization. There is, I think, no accepted term for this hypothesis: I shall call it the 'recognition in allopatry' hypothesis.

The best data bearing on the problem are those analysed by Coyne and Orr (1989) on 118 pairs of closely related species of *Drosophila*. For each pair, the following were estimated:

1. **Genetic distance.** This is an estimate, devised by Nei (1972), of the number of amino-acid substitutions in proteins that separate two species, based on electrophoretic data. Since rates of molecular evolution are, very approximately, constant, the genetic distance is an estimate of the time since divergence. One reason for thinking that it is a reliable estimate is as follows. Phylogenies (family trees) of the genus *Drosophila* based on genetic distance are almost identical to those based on inversions (see p. 223): since inversions are unique and irreversible events, they are the most reliable basis we have for the construction of phylogenies.

2. Post-zygotic isolation: that is, degree of hybrid inviability and infertility. Hybrid inviability was measured as follows. If both sexes, from both reciprocal crosses, were completely inviable, the measure = 1; if both sexes, from both reciprocal crosses, were at least partially viable, the measure = 0; intermediate values of 0.25, 0.5, and 0.75 imply that 1, 2, or 3 of the four possible types (two sexes \times two crosses) were inviable. A similar measure of sterility was used. It was found that hybrid inviability and infertility evolve at much the same rate.

3. Pre-zygotic isolation: that is, the degree of mating isolation, measured as $(1 - \text{frequency of matings between species} / \text{frequency of matings within species})$ in laboratory tests.

Mating discrimination, sterility, and inviability all increase gradually with time, as estimated by genetic distance. This confirms the impression gained from a study of geographical variation that speciation (at least, in *Drosophila*) is not a sudden event. Among allopatric species, pre- and post-zygotic isolation evolve at similar rates. For sympatric species, however, pre-zygotic isolation evolves more rapidly (Table 14.2). For species pairs with low genetic distance, strong pre-zygotic isolation is found *only* in sympatric pairs.

Table 14.2

Degree of isolation between pairs of *Drosophila* species
(Coyne and Orr 1989)

	Allopatric	Sympatric
Pre-zygotic isolation	0.25	0.62
Post-zygotic isolation	0.32	0.34

How are these results to be interpreted? We should not conclude, from the fact that mating discrimination evolves first in sympatric pairs, that the whole speciation process is sympatric. It is much more likely that the first steps took place in allopatry. However, we still have to choose between the two hypotheses listed above: reinforcement, or recognition in allopatry. I will consider them in turn:

1. The reinforcement hypothesis. This does predict the data of Table 14.2. There is, however, one fact that is awkward, at least at first sight. This is that some sympatric pairs show pre- but not post-zygotic isolation. Clearly, if there is no post-zygotic isolation, there is no selection favouring mate discrimination, so reinforcement cannot happen. But the difficulty may be more apparent than real. The measure of post-zygotic isolation used requires the complete inviability or sterility of at least one of the hybrid types: this is a very extreme requirement. There must be many cases in which the hybrids show some degree of lowered fitness in the wild that does not show up in the data as analysed. It will be important to look again at those cases that show pre- but not post-zygotic isolation.

2. Recognition in allopatry: that is, mate discrimination evolves more rapidly than post-zygotic isolation, even in allopatry. This hypothesis does predict some difference between sympatric and allopatric pairs, for the following reason. A pair of populations that have not evolved a fair degree of isolation, either pre- or post-zygotic, while allopatric are likely to fuse into a single interbreeding population if their ranges later come to overlap. Therefore we only expect to observe sympatric pairs that do show a fair degree of isolation, whereas allopatric pairs could show little or no isolation. But this does not really explain the data. If the 'recognition in allopatry' hypothesis were correct, we would expect to find that allopatric pairs, as well as sympatric ones, showed a greater degree of pre- than of post-zygotic isolation: in particular, we would expect to find some closely related allopatric pairs that show strong mate discrimination, and we do not.

The *Drosophila* data, then, support the reinforcement hypothesis. But the question is still open.

Sometimes, the hybrids between two species are sufficiently fertile to permit genetic analysis. We can then ask how many loci are responsible for particular differences. The number can be estimated by comparing the variability of the F_1 and F_2 hybrids. Thus, suppose that a difference is caused by alleles at a single locus: that is, one species is aa and the other AA . The F_1 is Aa , and is no more variable than the parental populations. The F_2 consists of $1aa:2Aa:1AA$, and is genetically more variable. Now suppose that a difference is caused by a very large number of independently assorting loci. Again, the F_1 is no more variable than either parental population. But now the F_2 is no more variable than the F_1 . Thus, at any single locus there are three possible genotypes. But the proportion of loci which are,

respectively, homozygous for the 'low' allele, heterozygous, and homozygous for the 'high' allele, will be the same in all individuals. For the same reason, if a number of people each toss a coin 10 000 times, all will get approximately the same proportion of heads.

Lande (1981*b*) describes how F_1 , F_2 and backcross data can be used to estimate the number of loci responsible for a phenotypic difference between two populations, and explains the assumptions on which the estimates are based. The estimates are minimum ones: one important reason for this is that separate loci may be linked, and therefore behave as if only one locus was involved. He applies the method to two species of Hawaiian *Drosophila* that differ in head shape by about eight phenotypic standard deviations in females, and to a still greater degree in males (Fig. 14.1) *D. silvestris* has a conservative head shape, and *D. heteroneura* has an extremely widened head. These species have a lek system of mating, and the wide head of male *D. heteroneura* probably evolved through female choice. The difference between females presumably evolved because most genes that affect males also affect females. Analysis of the F_1 and F_2 data on females suggest a minimum of six to eight separate loci: since there is no crossing over in males, and there are only five pairs of large chromosomes and one dot chromosome, the true number of separate loci may be substantially greater.

In other cases, a significant adaptive difference between two populations may be caused by one or by a few loci. Gottlieb (1984) suggests that this may be commoner in plants than in animals, and that differences between closely related species in structure, shape, orientation, and presence versus absence are frequently discrete, and appear to be governed by one or two genes. He quotes the columbine,

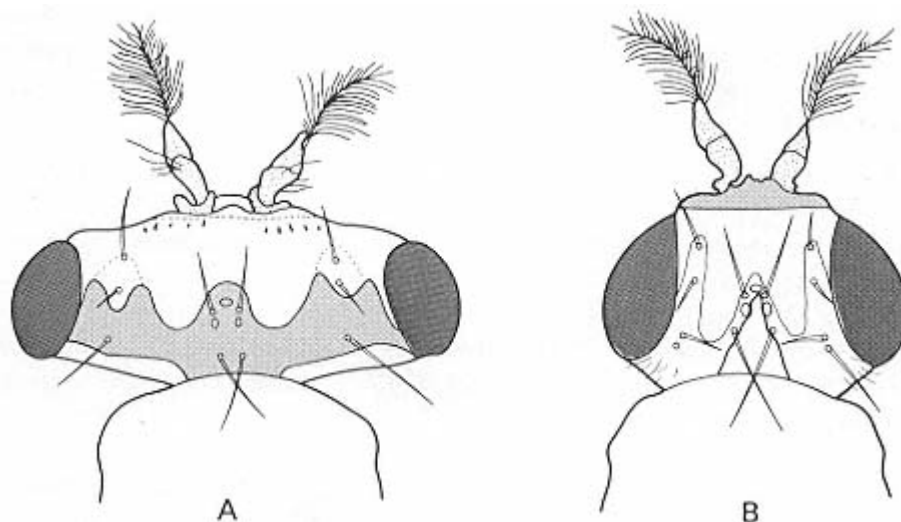

Figure 14.1
Head shape in **A** *Drosophila heteroneura* male, and **B** *D. silvestris* male. (From Val 1977.)

Aquilegia, as an example (Fig. 14.2). Members of this genus typically have nectar-containing spurs on each of the five petals, but in the primitive species *A. ecalcarata* these are replaced by small nectar-containing pockets. The F_2 between *A. ecalcarata* and other species indicates that the presence of a spur is caused by a single dominant gene. A second locus determines whether the spur is straight or curved at the tip (as in the figure), and a third locus whether the flowers are nodding (as in the figure) or erect. However, both length, and degree of curvature (if present), vary continuously, and are presumably polygenic. All these differences will affect which pollinators visit the flowers, and may therefore act as pre-zygotic isolating mechanisms.

What of the genetics of hybrid inviability and infertility? If a hybrid is inviable,

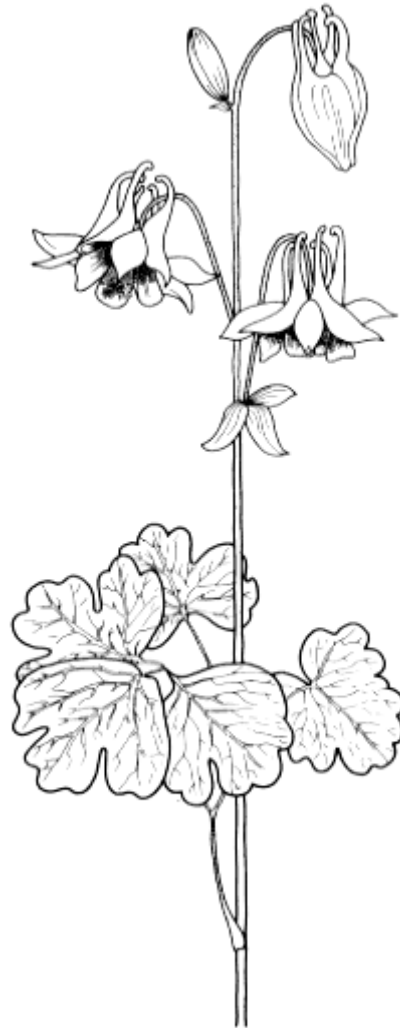

Figure 14.2
Aquilegia vulgaris.

does it follow that evolution has had to cross an adaptive valley? If so, it would imply that the process of speciation is in some way different from the typical hill-climbing process observed within populations. At the very least, it would suggest that the critical events took place by chance in a small population, as imagined in Wright's shifting balance model (p. 179). However, it was shown in Chapter 9 (Fig. 9.9, p. 179) that a large random-mating population can evolve by selection from state X to state Y , and yet the hybrids between X and Y can be of reduced fitness. In other words, hybrid inviability does not imply that an adaptive valley has been crossed. There is no reason to postulate atypical genetic events.

In practice, the events leading to a new species may often occur in small peripheral populations, because such populations are more likely to be exposed to an atypical environment and hence to directional selection, and to be sufficiently isolated spatially that genetic changes can occur without being swamped by gene flow from outside. There is little reason to think that small population size is itself important. However, some population geneticists would dissent strongly from this opinion: for an alternative view, see Templeton (1980).

So far, I have considered only cases in which both parental and daughter species are sexual diploids. In contrast, hybridization between two sexual species can give rise in one step to a new sexual tetraploid species, reproductively isolated from either parent. The process is known as allopolyploidy. Often, the diploid hybrid between two species is sterile, because the chromosomes from the two parent species fail to pair in meiosis. If, by chance, the chromosome number is doubled to give a tetraploid, each chromosome has one potential partner, and meiosis gives rise to regular diploid gametes, that can fuse to give a new tetraploid. The process is common in plants, both in domestication and in the wild, but rare in animals.

Patterns of Evolution

This section reviews some of the patterns detected by a study of the fossil record, and discusses how far they can be explained by natural selection within populations, and how far other mechanisms are called for.

The Rate of Evolution

First, we need a measure of the rate of evolution that is independent of scale: it should give the same estimate for an elephant that doubles in size in one million years (Myr) as for a fruitfly, and the same estimate for a species that doubles in size in one million years as for a species that quadruples (that is, doubles twice) in two million years. Haldane suggested that, if a measurement changes from x_1 to x_2 in n Myr, then

$$\text{rate of evolution} = (\ln x_2 - \ln x_1)/n \text{ darwins.} \quad (14.1)$$

Table 14.3 lists some results. The most obvious conclusion is that the shorter the time period over which the rate is measured, the higher the rate. This is in part an

Table 14.3

Measurement of the rate evolution (Gingerich 1983)

	Number of cases	Time-interval (geometric mean)	Rate in darwins (geometric mean)	Regression of ln (rate in darwins) vs. ln (time in Myr)
Selection experiments	8	3.7 yr	58 700	-0.9
Recent colonizations	104	170 yr	370	-2.08
Post-Pleistocene mammals	46	8200 yr	3.7	-0.68
Fossil vertebrates	228	1.6 Myr	0.08	-0.82
Fossil invertebrates	135	7.9 Myr	0.07	-0.59
Combined data	521			-0.85

artefact of the way in which the data were collected. Thus laboratory populations exposed to artificial selection are recorded, but not laboratory stocks maintained without selection. In the examples of recent colonization, the populations were in a new environment, and therefore probably exposed to directional selection. Examples of rapid evolution over periods of millions, rather than tens or hundreds, of years may be missing because, if they occurred, the initial and final populations might not be recognized as belonging to the same lineage.

Another possible reason for the inverse relation between time period and rate is that large changes in one trait may require that other genetically independent changes also occur. For example, it would probably be rather easy to lengthen the neck of an antelope by, say, 10 per cent. But to produce a functional giraffe by selection would require major changes in the heart and vascular system: otherwise, the animal would faint every time it lowered its head to drink. More generally, the very slow rate of evolutionary change, relative to change under artificial selection, may in part be due to the fact that, in nature, many different traits are changing simultaneously.

However, a major reason for the data of Table 14.3, and in particular for the negative relation between period and rate within categories (e.g. within invertebrate fossil lineages) as well as between categories, is that the direction of evolution is often reversed. As shown in Fig. 14.3, if there are reversals in direction, there will be a negative correlation between rate and period.

G.G. Simpson (1944 and later), one of the architects of the Modern Synthesis, emphasized how variable is the rate of evolution. More recently, critics of the Modern Synthesis (in particular, Eldredge and Gould 1972; Stanley 1979) have argued that the pattern of change usually observed is one of long periods of little or no change (stasis) interrupted by periods of rapid change (punctuation) occurring at times of lineage splitting (that is, of speciation). They have further

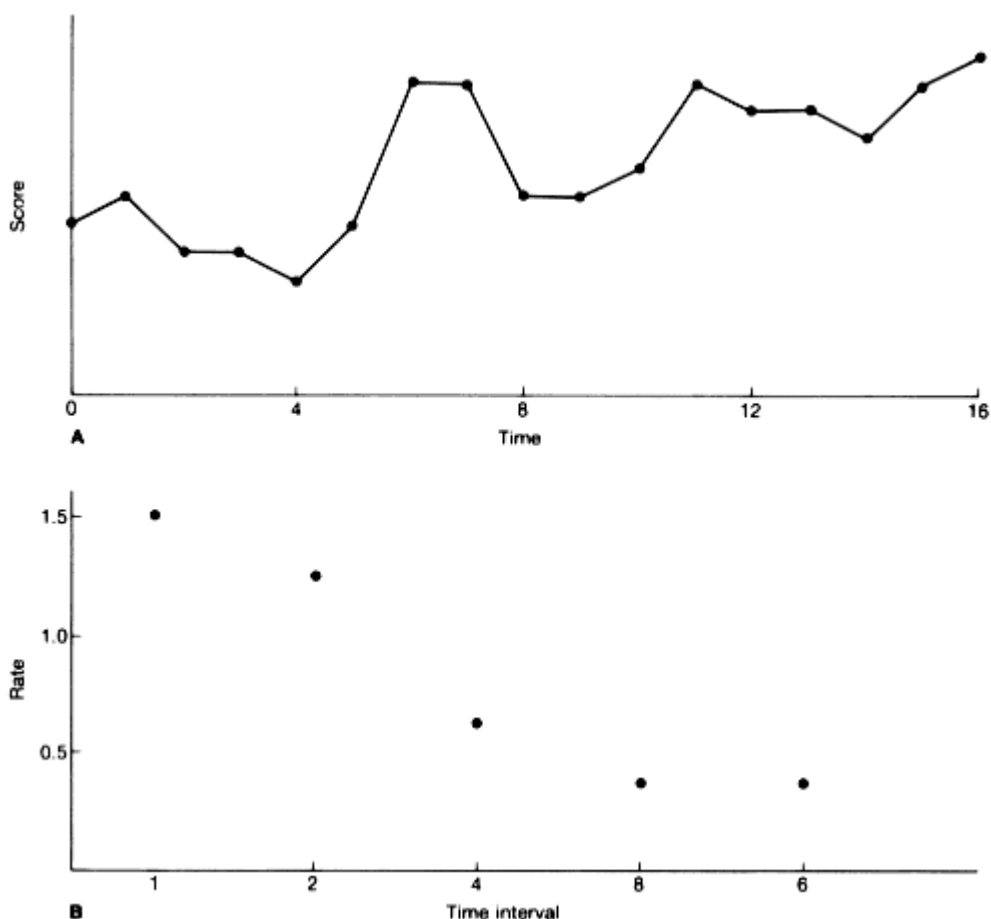

Figure 14.3

The transmission of parasites. **A**, Direct; **B**, **C**, horizontal. In **B** a host is infected from only a single source, and **C** from two sources.

argued that this pattern of stasis and punctuation means that the large-scale features of evolution (macroevolution) cannot be interpreted as the summed effects of changes of the kind that can be observed today within populations (microevolution).

The nature of the evidence on which this conclusion rests is best understood from the work of Eldredge (1985), one of the proponents of the theory, on mid-Devonian trilobites. During the Devonian, for some 8 million years, an inland sea covered much of what is now the central USA. Fossils from the mid-west, from the western shore of this sea, include three species of the trilobite genus *Phacops*. These differ in the number of rows of lenses in the compound eyes. The first, *P. milleri*, has 18 rows; the second, *P. rana*, has 17 rows; the latest, *P. norwoodensis*, has 15 rows. These species replace one another suddenly, without intermediates. The

same three species, in the same sequence, are found in New York state, from what was the eastern shore of the inland sea. However, in one quarry near Syracuse, Eldredge found a population intermediate between *P. milleri* and *P. rana*: some 50 specimens include ones with 18 rows, with 17 rows, and with 17 rows plus a variable number of lenses making up part of an 18th row. This intermediate population is some 3 million years older than the transition between *P. milleri* and *P. rana* in the west. A population intermediate between *P. rana* and *P. norwoodensis* has also been found in the east, with individuals having 15 1/2, 16, and 16 1/2 rows of lenses, but in this case it is impossible to say that this population is earlier than the sudden transition in the west, although on any rational interpretation of the data it must be.

The interpretation of these facts seems clear. On the eastern shore, the three species are connected by evolutionary intermediates. There are periods of stasis, separated by two periods of rapid evolution. On the western shore, the apparently instantaneous transitions represent the replacement of an earlier species by a later one that evolved elsewhere, in the east. Sudden replacements must often be explicable in this way. A palaeontologist of the future, studying sedimentary rocks laid down in Britain today, will observe the instantaneous replacement of the red squirrel *Sciurus vulgaris*, by the grey, *S. carolinensis*. Occasionally, we are fortunate enough, as Eldredge was with his trilobites, to observe a rapid evolutionary transition. In such cases, the rate of evolution is indeed rapid in comparison with what has gone before, and what will follow, but they are still slow compared to the rates to be expected under strong directional selection. It is therefore not obvious that the pattern of punctuation and stasis requires mechanisms other than natural selection within populations. I will return to this question on p. 281.

The pattern of stasis and punctuation may occur, but it is not a universal feature of the fossil record. Sheldon's (1987) study of trilobites during 3 million years of the Ordovician illustrates a different pattern. These animals were classified into species by the number of `pygidial ribs' 榑 feature of the exoskeleton. In one genus, *Ogygiocarella*, the specimens available before Sheldon's study fell into two `species', an earlier one with 11 ribs and a later one with 13. Figure 14.4 shows these data, together with Sheldon's own collections. The picture of distinct species, with few intermediates, is seen to be an artefact of the incompleteness of the record. In fact, all eight genera studied showed an increase in rib number during the period, but in no case is there a punctuational event separating an early and a later form.

It remains to be seen how common the punctuational pattern will prove to be. What is clear is that the matter can be decided only by a statistical study of populations.

Trends

It is common to observe in the fossil record a long-continued tendency to change in a given direction. For example, many lineages, both vertebrate and invertebrate,

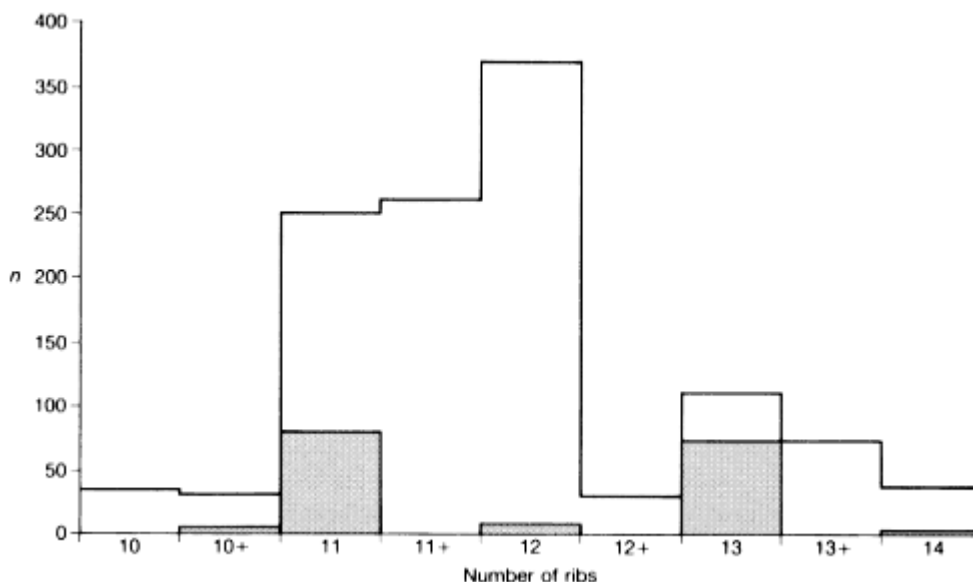

Figure 14.4

Pygidial ribs in trilobites. Intermediate numbers such as 11 + indicate 11 full ribs and one partially developed rib. The black histogram gives the numbers of individuals upon which two 'species', *Ogygiocarella debuchii* and *O. angustissima*, from different time horizons, were erected. The white histogram represents data collected later, mainly from rocks of intermediate age. (After Sheldon 1987.)

show a trend towards greater size. Herbivorous mammals usually show a trend towards hypsodonty (teeth that are high relative to their horizontal dimensions). The phenomenon is more striking when similar changes occur in parallel in related lineages. For example, many lineages of mammal-like reptiles during the Mesozoic showed parallel trends in the skull and teeth, including differentiation along the tooth row, reduced tooth replacement, development of a secondary palate, erosion of the dermal roof of the skull, and growth of the dentary relative to other bones in the lower jaw. It is hard not to interpret these changes as adaptations for chewing, or to conceive of any process other than natural selection within populations that could bring them about. During the same period, changes occurred in the limbs, girdles, and backbone, associated with the evolution of the mammalian mode of locomotion, in which the backbone is arched in a vertical rather than a horizontal plane.

Some trends can be explained in adaptive terms. Others, like the increase in the number of ribs in trilobites described above, are hard to interpret, because we know too little about the biology of now-extinct organisms. A few have been interpreted as maladaptive, and as caused by some inner and unexplained evolutionary inertia. A classic example is the great size of the antlers in the Irish elk, which may well have been a real handicap, both in escaping from predators, and as a drain on resources, particularly of calcium. However, as shown in Chapters 7 and 13, traits

can be exaggerated to a maladaptive level by intra-specific competition, and particularly by sexual selection, either by male-male competition or by a runaway process involving female choice.

Adaptive Radiation

In the early Palaeocene, the placental mammals were a rather uniform group, small and mainly insectivorous. They rapidly radiated into many adaptive zones, as herbivores and carnivores, arboreal and fossorial, in the air and in the sea. Such adaptive radiations are a common feature of the fossil record, at different scales. For example, an early group of placentals, the creodonts, evolved a range of carnivorous forms similar in morphology to modern weasels, dogs, bears, and hyenas. They were later replaced by modern fissipede carnivores, with a similar range of types, but these were a second radiation descended from a single creodont group.

An interesting but often unanswered question in such cases is this: does the newly radiating taxon cause the extinction, through competitive displacement, of the taxa earlier occupying the same ecological niches, or is the extinction of the earlier taxa the primary event, leaving the field open for the later radiation?

The analysis of such cases is not easy. Consider, for example, Fig. 14.5. One is

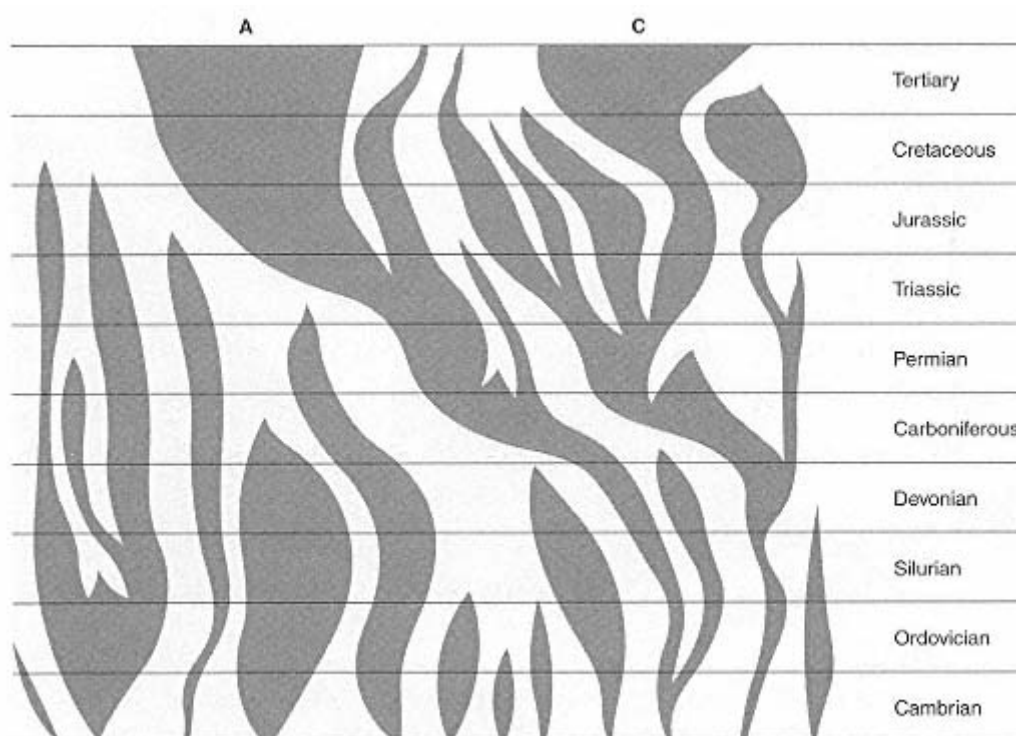

Figure 14.5

The abundance of different taxa in different geological periods: the horizontal width of a taxon at any time is approximately proportional to the number of genera.

tempted to ask, what biological invention by taxon A enabled it to radiate so successfully? What characteristic of the apparently conservative lineage, B, enabled it to radiate during the Cretaceous, and why was it later displaced by taxon C? The temptation should, however, be resisted, because the figure was drawn to represent a computer-generated phylogeny, in which the splitting and extinction of genera was a random event. Several people have found that such stochastic phylogenies have an embarrassing similarity to actual ones. The figure is not intended to demonstrate that phenomena such as adaptive radiation are not real, but only that one must proceed with caution when analysing real data.

Extinction

Figure 14.6 shows the numbers of families of marine animals present at various times in the geological record. One dramatic feature is the occurrence of several massive extinctions, the most recent being at the end of the Permian, and at the end of the Cretaceous. There is little doubt about the reality of these events, but there is

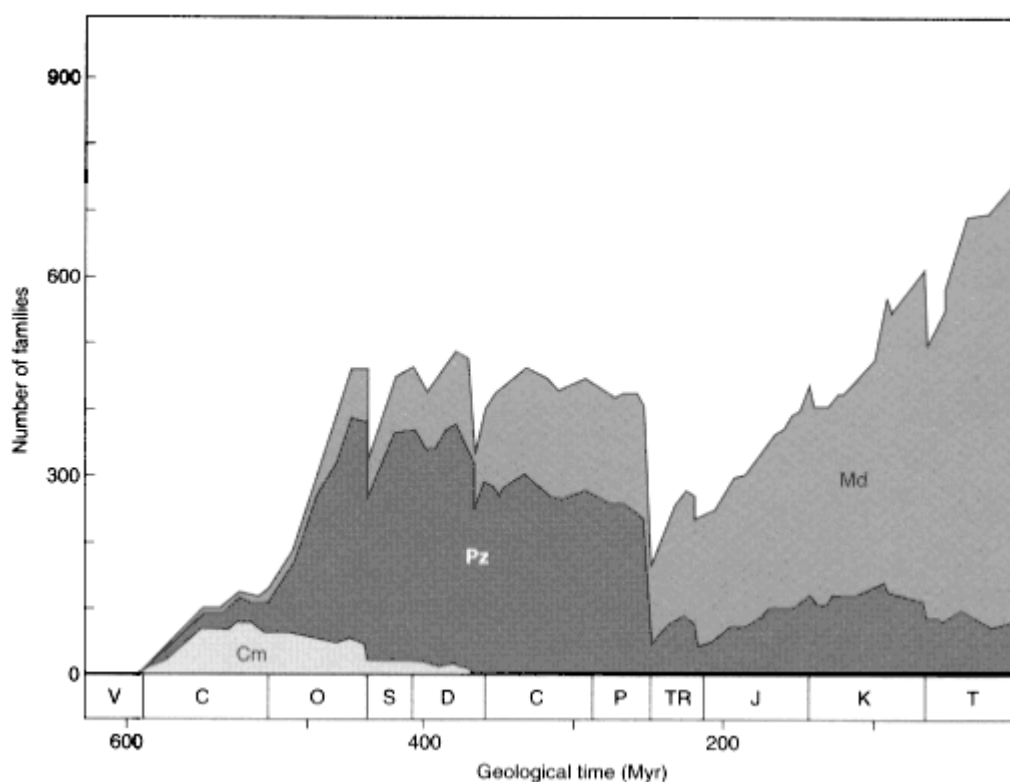

Figure 14.6

The history of taxonomic diversity of families of marine animals. The total number of families is divided into three evolutionary faunas: Cm, Cambrian fauna; Pz, Palaeozoic fauna; Md, modern fauna. (After Sepkoski 1984.)

still debate about how instantaneous were the extinctions (are we looking at something that happened overnight, or that was spread over, say, a million years?); about whether they were caused by a change in physical conditions or by some biological event (remember that the latest massive extinction—the one that is happening now—cannot be blamed on physical events); and about whether, if the cause was physical, it was extraterrestrial (for example, a shower of meteorites) or terrestrial (arising, perhaps, from continental drift). There is also debate about whether, in addition to these major events, there has been a series of smaller but still massive extinctions, and, if so, whether they have been irregular in time, or regularly periodic.

These mass extinctions raise further questions. Is there selectivity in which species go extinct? If so, what characteristics predispose species to extinction? After a mass extinction, is there evidence of particularly rapid speciation and diversification of the survivors?

Palaeontology and Population Genetics

It is perhaps inevitable that practitioners of these two branches of science should often misunderstand one another. It is not uncommon for palaeontologists to assert that population genetics cannot account for the fossil record, whereas population geneticists hold that there is nothing in that record that they cannot explain. Much misunderstanding would be avoided if it were understood that there is a sense in which both these views are correct. To a geneticist, there is nothing in observations such as those of Eldredge on trilobites which present any particular difficulty. Stasis can be explained by normalizing selection for a fixed optimum, and punctuation by periods of directional selection. The rates of change, although rapid by palaeontological standards, are slow to a geneticist: as J.S. Jones remarked, 'one man's punctuation is another man's gradualism'. There is no reason to suppose that the transitions took place in particularly small populations: if they had, we surely would not have been lucky enough to find traces of them. The transitions did not always, or even usually, involve the gradual transformation of the whole species, throughout its geographical range, but it has never been part of the Modern Synthesis to suppose that they did.

But such a reply, quite properly, would not satisfy a palaeontologist, who wants to know why evolution shows the patterns that it does. Why should there sometimes be normalizing selection for an unchanging optimum for millions of years? What causes punctuational events? The answers to these questions does not lie within population genetics, which only makes statements of the form 'IF there is selection of a given kind, and IF a population has certain properties, THEN the following changes will occur'. But genetics cannot tell us what the nature of the selective forces will be. It is in this sense that I think palaeontologists are right to say that population genetics cannot account for evolution.

If we are to gain an insight into the nature of selective forces, it must come, I

think, from a study of ecology. In particular, it must come from a study of the coevolution of interacting species, because the main selective forces acting on a species are likely to come from changes in its competitors, its predators, and its parasites. This is the topic of the final section in this book.

This, however, is not the conclusion drawn by many palaeontologists, who seek to explain the major patterns of evolution, not in terms of the selective forces acting on populations, but in terms of developmental constraints that limit the ways in which a population can respond to selection. There are such constraints. For example, monocotyledonous trees (palms) do not branch, unlike characteristic dicots such as oaks, maples, and poplars. The reason is that monocots never evolved a process of secondary thickening, whereby a twig can turn into a branch. In other words, a developmental constraint (absence of secondary thickening) has limited the evolution of a major taxon. As it happens, the constraint is not absolute: some monocots do branch (see Fig. 14.7).

The range of variation possible to a taxon, then, is limited by the pattern of development that has evolved in that taxon. Occasionally, as in the example of palm trees, we have some idea of the reason for the constraint. More often, we do not. To take another example from the monocots and dicots, the former almost

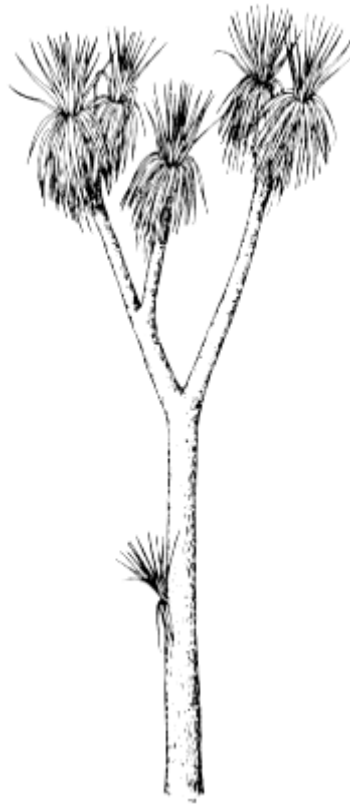

Figure 14.7
Cordyline australis, a
branching monocot.

always have flowers with three petals and three sepals: so far as I know, no monocot has a typical flower with a petal number greater than three. This cannot be explained in selective terms, because dicots, faced with the same range of potential pollinators, typically have four, five, or more petals. It is natural to suspect a developmental constraint, but we do not know what it is. It is not an absolute one, because occasional flowers with four sepals, petals, and stamens do occur (Fig. 14.8). Also, the constraint has not prevented the monocots from repeatedly evolving bilaterally symmetrical flowers: orchids are the most dramatic example.

The evolution of a taxon, then, depends on selective forces, which arise mainly from ecology, and on the available range of variation, as determined by its mode of development, which in turn reflects the past evolution of the taxon. Does the study of the fossil record suggest any mechanism of evolutionary change other than

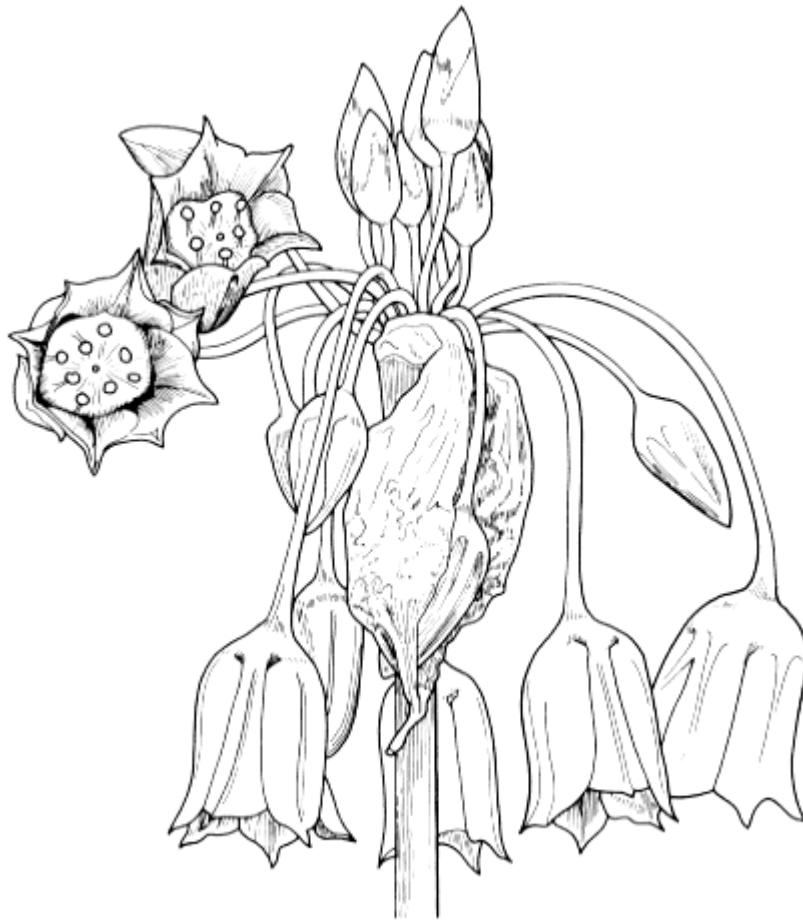

Figure 14.8

Flower head of *Allium siculum*, showing typical flowers with three sepals, three petals, and six stamens, and an atypical flower with four sepals, four petals, and eight stamens.

natural selection acting on the available variation, together, of course, with stochastic changes in gene frequency? A number of suggestions have been made, but most are not needed to explain the observed phenomena, and assume the existence of processes for which there is no basis in what we know of biology. One process, species selection, does need more serious discussion.

In effect, the suggestion is that the units of evolution are the entities that display multiplication, variation, and heredity, and which therefore evolve by natural selection, are species rather than (or as well as) individuals. In this model, births are replaced by speciation events, deaths by extinctions, and mutations by the punctuational changes that occur when lineages split. The punctuational theory, which in its extreme form holds that the transitions between species are effectively instantaneous and non-adaptive, leads necessarily to the view that species selection is the major directing force in evolution: there is, of course, no good reason for accepting this extreme view.

It is, I think, important to distinguish two processes, only one of which should properly be called species selection:

1. The replacement of species A by species B because of the superior competitive ability of B individuals. For example, consider the replacement of creodonts by modern carnivores, mentioned above. If (and this is an assumption) a particular creodont species was replaced by a fissipede species that was competitively superior perhaps because it was better at hunting the same prey when the process was essentially one of individual selection. Individuals competed for the same limiting resource, and the fact that they belonged to two different species has little to do with it. The traits by virtue of which the fissipedes won presumably evolved by natural selection between individuals in an ancestral fissipede population.

2. An increase in the number of species in taxon A, relative to the number in taxon B, because some characteristic of the species in taxon A make them more likely to speciate (equivalent to an increased birth rate), or less likely to go extinct (a reduced death rate). One example of this process was discussed in Chapter 12, where I argued that one reason for the maintenance of sexual reproduction is the lower capacity for evolution of asexual taxa. Two points are worth making about this example. First, the relevant trait, capacity to evolve, is characteristic of the species, or population, and not of the individual: populations, and not individuals, evolve. Secondly, it is unusual for there to be within-population variability for mode of reproduction, sexual or asexual: it is this that makes the species-selection explanation plausible. The fact that there is sometimes within-population variation means that species-selection cannot be the whole explanation: this is Williams' (1975) 'balance' argument.

A second possible example has been discussed by Vrba (1984). It concerns two sub-families of African antelopes, during the past 5 million years. The

Aepycerotini has, over the whole period, consisted of a single species, the impala, which feeds on a wide range of plants, and does not migrate. A second family, the *Alcelaphini*, are food specialists, and are therefore obliged to migrate to follow the available food. During the same period, there has been repeated speciation and extinction. In all, 28 species have been recognized, of which seven survive today. It seems that the main cause of the different patterns of evolution is the greater speciation rate of the *Alcelaphini*. If so, the important cause of speciation has probably been the ecological fact of food specialization, and hence the existence of unoccupied ecological niches, and not population structure: if the latter had been the important factor, we would expect the non-migratory impala to speciate more rapidly, because of the greater opportunities for geographical isolation. In any case, if we measure success by number of species, the *Alcelaphini* have increased sevenfold in 5 million years, and are out-competing the *Aepycerotini*. But it is not clear that this is the right measure of success: as Vrba points out, there are probably more individual impala in Africa than there are of all the *Alcelaphini* species together.

How, then, should we evaluate species selection? It is a logically possible process, which may have influenced the evolution of breeding systems, patterns of dispersal, and degree of ecological specialization, but is largely irrelevant to most of the morphological characteristics that are the subject matter of palaeontology.

Coevolution

If a trait of one species, A, has evolved because of the presence of a second species, B, and if a trait of species B has evolved because of the presence of A, then **coevolution** has occurred. In discussing coevolution, it is convenient to distinguish three cases, according to the nature of the ecological relations between the interacting species:

1. **Competition:** the presence of each species inhibits the population growth of the other.
2. **Exploitation:** the presence of species A stimulates the growth of B, and the presence of species B inhibits the growth of A. Examples are plant-herbivore, prey-predator, and host-parasite interactions.
3. **Mutualism:** the presence of each species stimulates the growth of the other.

Competition

If two species compete for, and are limited by, a single resource, then theory indicates that one or other will be eliminated (p. 21). If, however, they compete for a range of resources, it is possible that they will partition the resources between them, and that both will survive. Theoretical models of resource competition suggest that two similar species will usually evolve so as to take different resources.

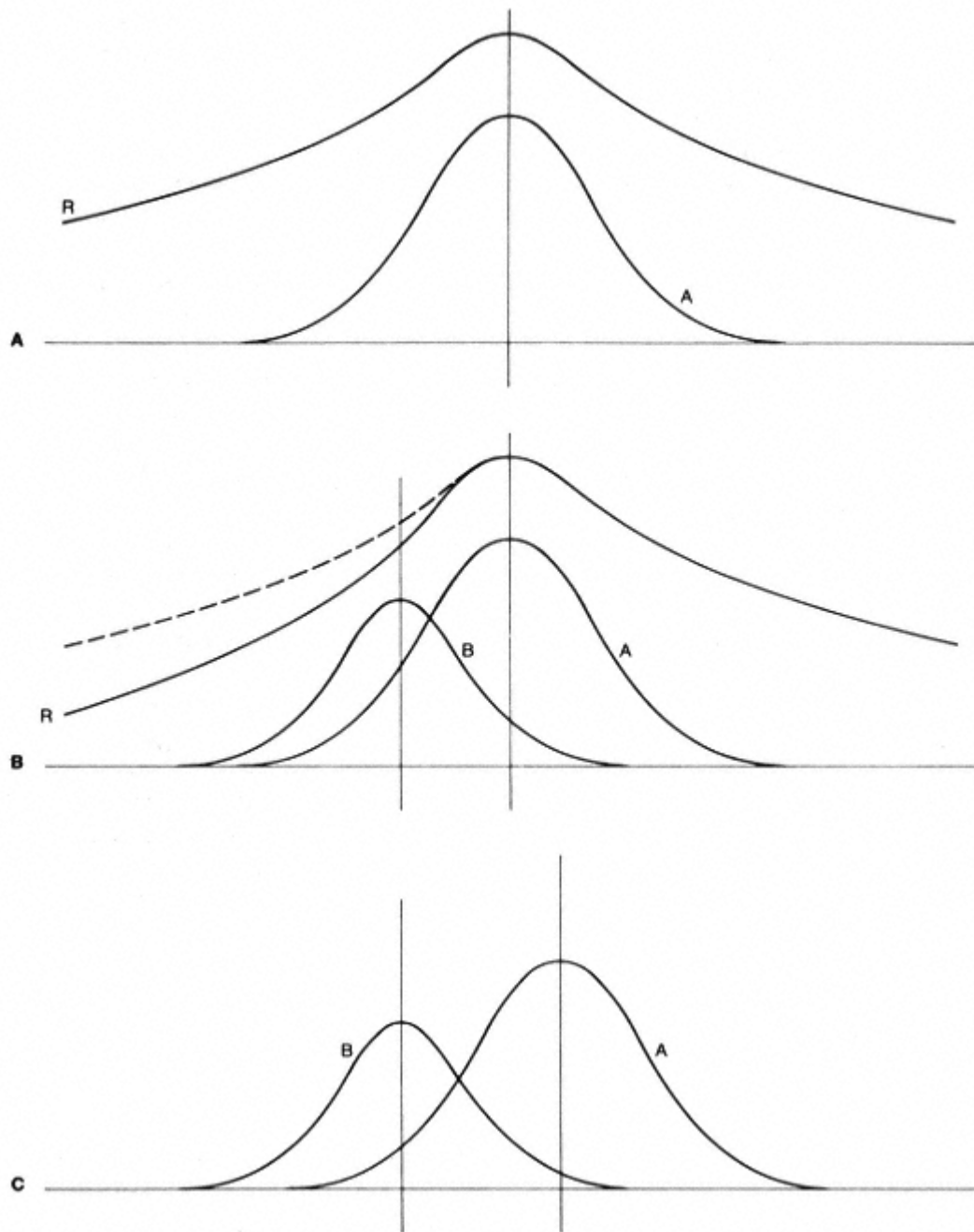

Figure 14.9

A model of character displacement. **A** Resource utilization of species A on its own, given available resources R. **B** Change in available resources, R, induced by the presence of species B; the original resource distribution is shown by the broken line. **C** New resource utilization by species A.

If this results in the two species becoming morphologically more different, the process is referred to as **character displacement**: note, however, that character displacement can occur for reasons other than resource competition. For example, selection for mating isolation.

A simple argument leading to this conclusion is illustrated in Fig. 14.9. Suppose that species A has, on its own, evolved an optimal phenotype for exploiting a given range of resources. The population will vary genetically, as all populations do, but individuals above and below the mean will have equal fitnesses: the population is under normalizing selection. Now suppose that species B, with an initially different resource utilization (below the mean of A in the illustration), is introduced. The effect will be to lower the resource availability, and hence the fitness, of A individuals below the mean. Hence species A will evolve away from species B: that is, character displacement will occur. Of course, the displacement will continue only until A has reached a new optimum, for the new range of resources that are available when species B is also present. For a more rigorous treatment of this problem, see Roughgarden (in Futuyma and Slatkin 1983).

Note that an essential assumption is that competing species have a significant impact on the availability of the resource. If, for example, species A and B were limited by their predators or parasites to a low population level, and so had no effect on the availability of their food, we would not expect to observe character displacement.

One of the clearest examples of character displacement concerns two species of marine mud snails, *Hydrobia ulvae* and *H. ventrosa*, in a channel, the Limfjord, in northern Denmark. Although the species have different salt tolerances, their ranges overlap. They feed by ingesting the substrate, and digesting the microorganisms attached to the mineral and detrital particles. Figure 14.10 shows that, when only one species is present, the shell size is the same in different populations. But, if both species are present, *H. ulvae* is larger than *H. ventrosa*. Also, in regions of overlap, the difference in body size is associated with a difference in the size of the ingested particles.

Exploitation.

Plant-Herbivore Interactions

Much of the information we have about the coevolution of plants and herbivores comes from a study of phytophagous insects. When a plant species is introduced into a new region, the herbivorous insects that attack it are usually local in origin. Some introduced plants are so different from the local flora that no native insects are able to attack them. For example, eucalyptus trees are virtually free of insect attack in California, although many insects feed on them in their native Australia. The same immunity is enjoyed by the prickly pear, *Opuntia*, introduced from America into Africa. More commonly, introduced plants do suffer from insect

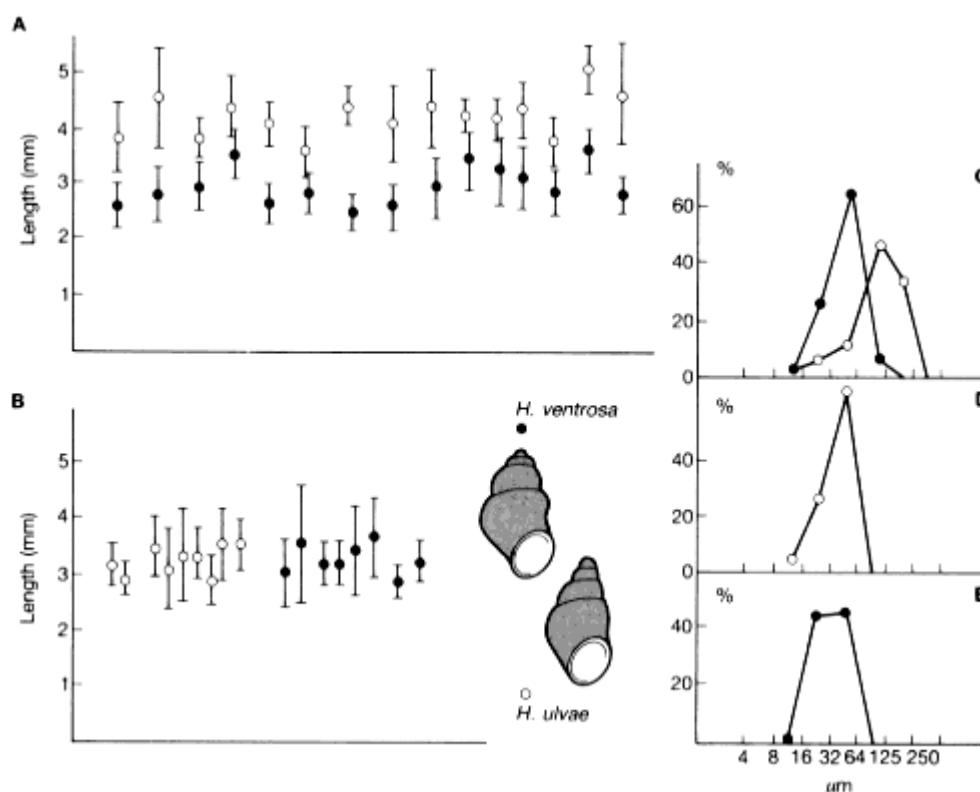

Figure 14.10

Shell lengths of two species of mud snails in the Limfjord, northern Denmark: **A** 15 localities with coexistence; **B** 17 localities with one species only; **C** size distribution of ingested food particles in coexisting populations; **D, E** size distribution of food particles in allopatric populations. (After Fenchel and Christiansen 1977.)

attack. Sugar cane, probably a native of New Guinea, has been introduced into many countries, the earliest being India in 1000 BC, and the most recent Honduras in 1840. The number of local insects that have colonized sugar cane in any region increases with the area over which the species is cultivated. Perhaps surprisingly, it does not correlate with the length of time since its introduction. This suggests that, in any locality, there is a limited number of insects capable of colonizing sugar cane, and that these move to the new host fairly quickly. The number of potential colonists will be greater if the region sampled is large, and if the introduced plant is not too different from plants already present. An example of the way in which a local insect may be pre-adapted to an introduced plant is the fact that the cabbage white butterflies of western Europe, *Pieris brassicae* and *P. rapae*, now attack the introduced garden nasturtium, which is taxonomically unrelated to the Cruciferae that are their natural hosts, but which shares with them the presence of mustard oils as a defence against phytophagy.

These facts suggest that introduced plants are colonized only by those insect species in some way pre-adapted to do so. It may be that, over a longer time-period, additional species would make the switch, but there is evidence that particular feeding niches on plants may remain unoccupied for long periods. Figure 14.11 shows the insect species feeding on bracken, *Pteridium aquilinum*, at three intensively studied sites at which bracken is native. These data strongly suggest that there are, at each site, unoccupied ecological niches, and hence that there are no local insects capable of making the switch.

The structural and chemical defences of plants have presumably evolved by

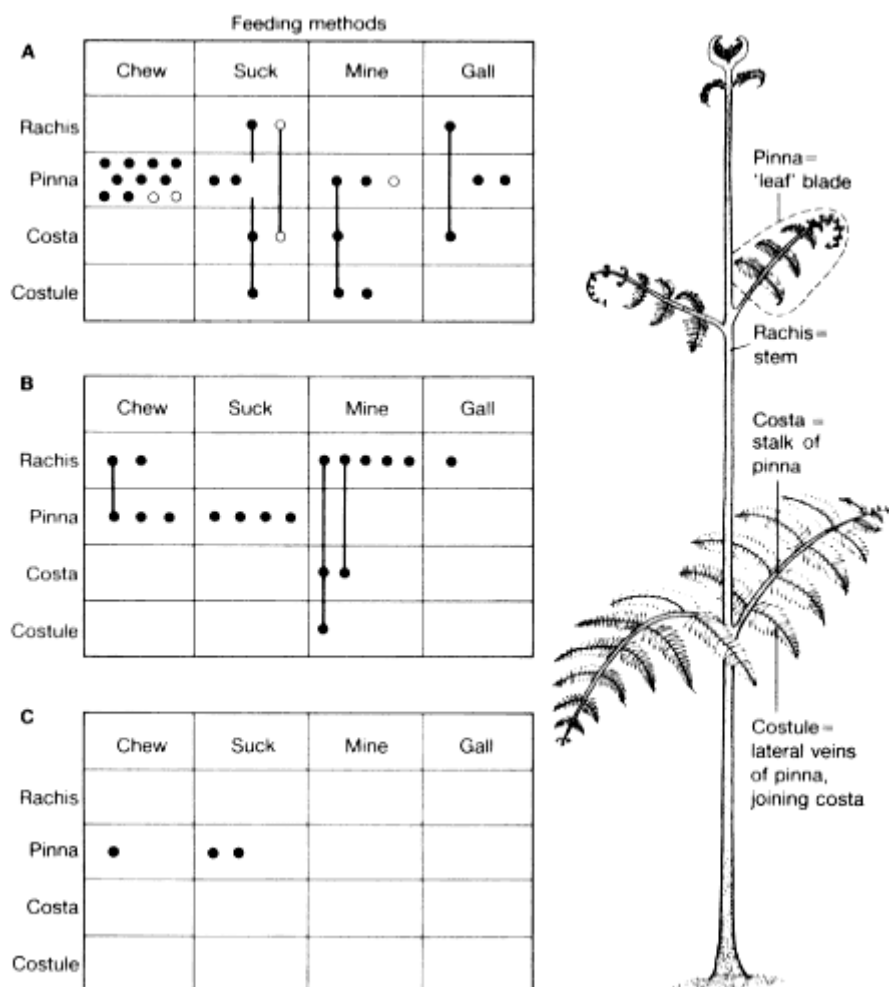

Figure 14.11 Feeding sites and feeding methods of insects attacking bracken. **A** Skipwith Common, Yorkshire, England; **B** Papua New Guinea; **C** Sierra Blanca, New Mexico. None of the sites have any insect species in common. Each dot represents one species; feeding sites of species exploiting more than one part of the frond are joined by lines. (After Strong *et al.* 1984.)

Table 4.4

Degree of host-specilization in insects collected in Umbelliferae differing in chemical composition (from Berenbaum 1981, quoted in Strong *et al.* 1984)

Host plant chemistry more	Proportion of		
	Extreme specialists, feeding on only 1-3 genera	Intermediate species, feeding on 4-20 genera	Polyphages, feeding on than three families
With angular and linear furanocouramarins	0.43	0.285	0.285
With linear furanocoumarins only	0.30	0.30	0.40
Without furanocoumarins	0.00	0.36	0.64

natural selection, but the facts so far quoted show little evidence of coevolution. The evidence is more consistent with the view that a local insect is either already capable of switching to the introduced plant, or it is not. More positive evidence of coevolution is given in Table 14.4. The data indicate that some Umbelliferae have evolved particularly toxic compounds (furanocoumarins), and that, in response, a few species of insects (for example, caterpillars of the moth family Oecophoridae and of the butterfly genus *Papilio*) have evolved the ability to cope with the toxins. This is evidence of the kind of arms race one would expect. Some of the ways in which insects overcome the toxins are remarkable. In direct sunlight, furanocoumarins cross-link and inactivate DNA; some caterpillars protect themselves by feeding within a rolled-up leaf.

One theoretical point is worth emphasizing. There is evidence that, at least in many cases, herbivores are limited by their predators and parasites, rather than by their food. However, it does not follow that herbivores are not an important selective force influencing the evolution of plants. A factor can be selectively significant without being density limiting.

Prey-Predator Interactions

The only attempt known to me to follow coevolution in the fossil record is Bakker's (in Futuyma and Slatkin 1983) study of mammalian herbivores and carnivores, and in particular of open-country species that escape, or catch their prey, by running. In many independent lines of evolution, both of herbivores and carnivores, high speed is achieved by the same morphological changes: in particular, by lengthening the distal relative to the proximal elements of the limb (that is, the foot relative to the femur), by straightening the limb, by reducing the number of elements in the foot from the primitive number of five, and by modifying the joints so as to confine movement to a single plane. Figure 14.12

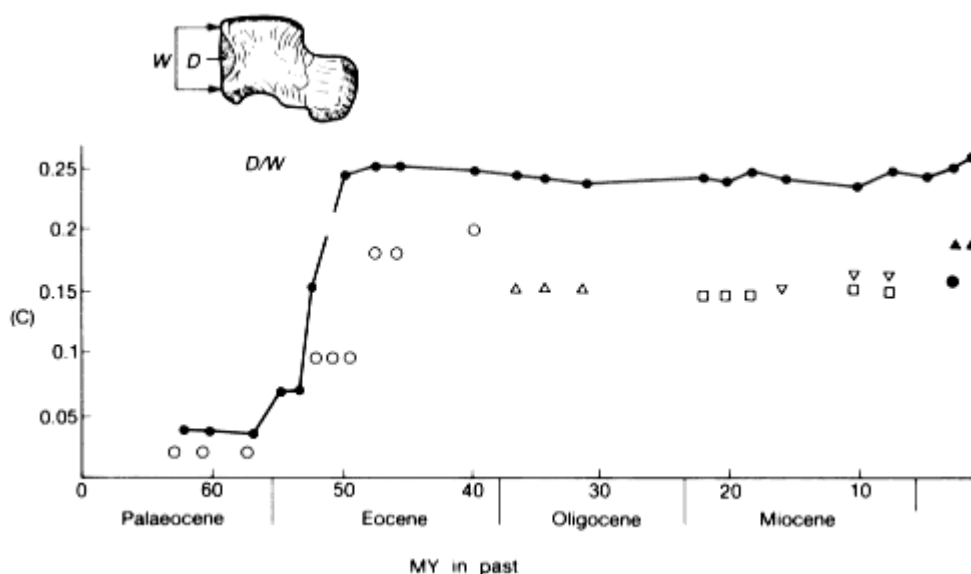

Figure 14.12

Coevolution of carnivores and ungulates. The index D/W measures the depth of the groove in the astragalus, which indicates the degree to which the limb was constrained to move in a single plane. The full line represents a series of ungulates: they are not a phylogenetic series. The single points are carnivores: \circ , mesonychids; \triangle , hyaenodontids; \square , amphicyonids; ∇ , borophagines; \bullet , hyaenids; and \blacktriangle , canines. (After Bakker, in Futuyma and Slatkin 1983.)

shows the progress of these changes, for one trait, in ungulates (which do not form a phylogenetic series), and in several carnivore lineages: other traits show a rather similar pattern. Bakker interprets these data as showing that the carnivores lagged behind the herbivores in the evolutionary race. He explains this in 'species selection' terms. The carnivores evolved more slowly because there were fewer species, and so fewer opportunities for species selection.

I do not think the data support this interpretation. They suggest that a sequence of separate carnivore lineages each evolved very rapidly, but to a degree of specialization less than that in herbivores, and then ceased to evolve. (It is not clear why, successively, one carnivore taxon went extinct, and was replaced by another.) The question to answer, therefore, is why did the carnivores not evolve such highly specialized limbs, and not why they evolved so slowly. A plausible answer is that carnivores use their limbs for things other than running (in particular, for digging lairs), whereas most ungulates do not. It is, in any case, relevant that a carnivore with a lesser degree of limb specialization can run as fast as a herbivore with a greater degree. One reason for this is that carnivores do not run in the same way as herbivores: they retain a more flexible backbone, and by arching their backbone they can lengthen their stride without lengthening their limbs.

The data that Bakker has summarized are fascinating. They suggest that there

has been an arms race, but one in which, for long periods, neither side was able to make further improvement. I do not think they support a species selection interpretation.

Host-Parasite Interactions

In Chapter 10, it was suggested that an arms race between parasites and their hosts is a major reason why populations are under continuing selection for change, and that this may in turn explain the superiority of sexual over asexual populations. There is, however, an older but still popular view that, in the words of Dubos (1965), 'Given enough time a state of peaceful coexistence eventually becomes established between any host and parasite'. In the only example of host-parasite coevolution so far discussed—the myxoma virus and its rabbit host—there is clear evidence that the parasite has evolved so as to become less virulent, although the situation is still far from one of 'peaceful coexistence'. Can we make any general prediction about whether we would expect a host and symbiont to evolve towards parasitism or mutualism?

One factor which we would certainly expect to affect the outcome is the mode of transmission (Fig. 14.13). If the symbiont is transmitted only to the offspring of the individual host it inhabits—**direct** transmission; Fig. 14.13A), we would expect evolution towards mutualism, because a parasite that reduces the fitness of its host also reduces its own fitness: there is no advantage to killing the goose that lays the golden eggs. In contrast, if transmission is **horizontal** (Fig. 14.13B, C), there may be selection for increased virulence, if greater virulence is associated with greater likelihood of transmission. If a host is typically infected by only a single parasite strain (Fig. 14.13B), then, as May and Anderson (1983) argued in their analysis of the myxoma virus, selection will favour parasite genotypes that produce an optimum compromise between a high rate of infection and keeping the host alive. If, on the other hand, a host is typically infected by several parasite strains (Fig. 14.13C), selection on the parasite will favour high infectivity at the expense of host survival: there is no point in keeping the goose alive if someone else is going to kill it.

Two examples will illustrate the relationship between virulence and mode of transmission. The first concerns the nematodes that attack figwasps (Herre 1993). Mature female figwasps enter the fig inflorescence, lay eggs, and die. If the female is infected by nematode parasites, these emerge from her body and lay eggs in the same fig. Hence, if only a single wasp enters a fig, any nematodes that infect her will produce offspring that infect her offspring: that is, infection is direct. But if several females infect a single fig, transmission is, in part, horizontal. Herre found that, in species with only one wasp female per inflorescence, the fertility of a female was not reduced by nematode infection, whereas in species in which several wasps enter a single inflorescence, there is a substantial reduction in

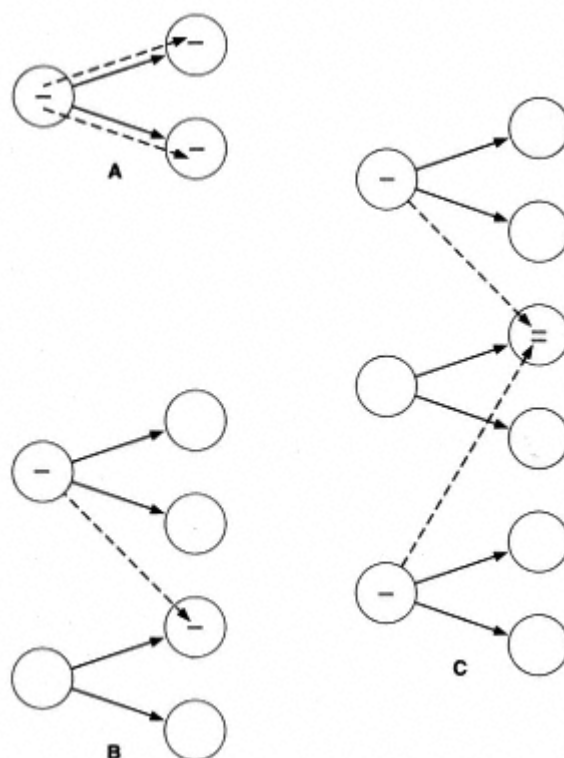

Figure 14.13

Direct and horizontal transmission of symbionts.
A Direct transmission. **B** Horizontal transmission.
C Horizontal transmission with more than one infection of a single host.

fertility. In this case, it is likely that the commensal situation is ancestral, and that parasitism has evolved in species with horizontal transmission.

Evolution has taken the opposite course in the ergot-producing fungi infecting grasses (Clay 1988). There are two sexual genera, *Balamsia* and *Epichloe*, producing horizontally transmitted spores. The ergot that they produce protects the plant against herbivores, but they sterilize the host, and so must be regarded as parasites. In contrast, some ergot-producing fungi in the genus *Acremonium* are asexual: their spores are directly transmitted in the host seed, and, as predicted by the theory, they do not sterilize their host.

There is a reasonable fit to the prediction of an association between vertical transmission and a commensal or mutualistic relationship, and between horizontal transmission and parasitism, although, as described in the next section, there are puzzling examples of mutualistic relationships in which transmission is horizontal. More generally, there is much support for the view that host-parasite interactions are an important cause both of genetic polymorphism, and of continuing evolutionary change.

Mutualism

The evolution of mutualism, in which both partners benefit from the relationship, has received less attention than that of competition and exploitation, although the recognition that symbiosis played a role in the origin of eukaryotes (Margulis 1970, 1981) has stimulated interest in other examples of symbiosis. The first point is that mutualism plays an important role in many ecosystems, as the following examples will show:

1. Nitrogen fixation. Plants cannot fix atmospheric nitrogen. Leguminous plants, however, form a symbiotic relationship with the nitrogen-fixing bacterium *Rhizobium*.
2. The ecosystem of deep-sea vents depends on symbiosis. Most ecosystems depend ultimately on photosynthesis for their energy. Even deep-sea organisms, in the absence of light, depend on the fall-out of dead organisms from the surface layers, which do depend on photosynthesis. In deep-sea vents, however, the sulphides emerging from the vents provide an alternative source of energy. The vestimentifera worm, *Riftia*, that inhabits these vents has no mouth or anus as an adult, and relies on symbiotic bacteria, housed in a special organ, which oxidize the sulphides. Both oxygen and sulphur are transported to these organs by a special haemoglobin. Other invertebrates inhabiting the vents also depend on symbiotic sulphur bacteria.
3. Coral reefs are built by coelenterates containing symbiotic dinoflagellate algae.
4. Many tropical plants, growing on mineral soils, depend on symbiosis with mycorrhizal fungi. There is a net flow of minerals from fungi to plants, and of carbon from plants to fungi, so the interaction can reasonably be regarded as mutualistic. Ericaceous plants (heathers, rhododendrons), growing on acid soils, depend on a more recently evolved group of mycorrhizal fungi.

The list, which is by no means exhaustive, shows the ecological importance of symbiosis. Surprisingly, despite the prediction discussed in the last section, transmission is often horizontal. For example, vestimentiferan worms must, as larvae, swallow sulphur bacteria, and luminous fish must swallow the bacteria that make them luminous, yet in both cases survival of the host depends on the symbiont. There is, therefore, a need for further research on the maintenance of mutualism, as opposed to parasitism, in such cases.

Two facts about mutualists were discussed by Law and Lewis (1983):

1. The taxonomic diversity is low. For example, only four species of *Rhizobium*-like bacteria, belonging to two genera, have been recognized, but they form nodules in 17500 plant species, belonging to 600 genera. Only two genera of dinoflagellates are known to live within marine invertebrates, but the latter belong to three phyla 棧nidaria, Mollusca, and Platyhelminthes. This extreme non-specificity of mutualistic inhabitants contrasts with a high degree of specificity in parasites.

2. Mutualists are often asexual. The asexual ergot-producing fungus *Acremonium*, mentioned in the last section is an example. A larger-scale example is the fact that the primitive (vesicular-arbuscular) mycorrhizal fungi associated with tropical plants are all asexual.

These two features of mutualists are clearly related: both suggest that there has been little pressure for evolutionary change. This is understandable. The host species, which gains from the presence of mutualists, will evolve so as to provide suitable conditions to encourage invasion by potential mutualists present in the environment. Hence different host species will converge in this respect, although they may diversify in other ways to meet external conditions. A single inhabitant species, therefore, will be able to live in many different hosts. (For a more formal treatment, see Law and Koptur 1986.)

The origin of a new mutualism is unique in being a process whereby a single organism plus symbiont can acquire a large increase in adaptive genetic information in a single step. Of course, it does not remove the necessity for natural selection to generate the adaptive information in the first place, and further selection, after the origin of the mutualism, will be required to co-adapt the two, originally separate, genetic systems. Yet the possibility of combining the structural or locomotory abilities of one partner with the biochemical abilities of the other is one that has been exploited repeatedly in evolution, particularly in the colonization of new habitats.

The Red Queen

In real ecosystems, a species interacts, not with one species of competitor or parasite, but with many. As each species evolves, it alters the environment of many others, and the environment of each species alters as others evolve. This led Van Valen (1973) to propose that, even in a constant physical environment, evolutionary change will continue indefinitely, as each species evolves to meet changes in others. He called this the Red Queen hypothesis, because the Red Queen said to Alice, 'here, you see, it takes all the running you can do to keep in the same place'.

Attempts to model the coevolution of many species in an unchanging physical environment face obvious difficulties. It is hard to reach any conclusion, other than that the Red Queen picture is plausible, but not necessary (Stenseth and Maynard Smith 1984). It is quite consistent with what we know of population biology that the species in a multi-species ecosystem should continue to evolve indefinitely. Unfortunately, it is equally consistent with what we know that evolution should gradually slow down and stop, when each species has reached a local selective optimum. We are therefore faced with two possibilities.

1. In the absence of physical changes (continental drift, ice ages, meteorites), evolution would gradually slow down and stop, as the evolution of RNA

molecules in a test-tube appears to do, when each species had reached a local optimum. That evolutionary change has, in fact, continued, for the past 3 billion years, must be explained by changes in the physical environment.

2. Even in the absence of physical change, coevolution would continue indefinitely. This is not to deny that physical changes occur, and affect evolution. It merely asserts that such changes are not necessary to maintain evolution.

I do not at present see any way, from ecological and genetical theory, to choose between these alternatives. It will be difficult to choose between them from a study of the fossil record, but that may be the only way.

Further Reading

On species and speciation:

Coyne, J.A. and Orr, H.A. (1989). Patterns of speciation in *Drosophila*. *Evolution* **43**, 362-81.

Mayr, E. (1963). *Animal species and evolution*. Harvard University Press.

Templeton, A.R. (1980). The theory of speciation via the founder principle. *Genetics* **94**, 1011-38.

Vrba, E.S. (ed.) (1985). *Species and speciation*. Transvaal Museum, Pretoria.

On patterns of evolution 棋 or two opposing views:

Simpson, G.G. (1944). *Tempo and mode in evolution*. Columbia University Press.

Stanley, S.M. (1979). *Macroevolution*. W.H. Freeman, San Francisco.

On coevolution:

Futuyma, D.J. and Slatkin, M. (ed.) (1983). *Coevolution*. Sinauer, Sunderland.

Margulis, M. and Fester, R. (ed.) (1991). *Symbiosis as a source of evolutionary innovation*. MIT Press, Cambridge, Mass.

Strong, D.R., Lawton, J.H., and Southwood, R. (1984). *Insects on plants*. Blackwell, Oxford.

Problems

1. Human brain volume has trebled in the last 4 Myr. Suppose that the heritability of brain volume is 0.5, the coefficient of variation (SD/mean) is 0.1, and the average generation time has been 15 years. What intensity of selection, I , would be needed to produce the observed change?

2. Suppose that you have estimates of the number of genera of artiodactyls, and of perissodactyls, at 10 approximately equally spaced times during the last 30 Myr. The overall trend has been an increase in the number of artiodactyl genera relative to perissodactyl. How could you test the null hypothesis that this change has been entirely a matter of chance?

3. S.M. Stanley reports that, in the history of the elephants during the past 5 Myr, three genera (*Mammuthus*, *Loxodonta*, and *Elephas*) appeared during the first 0.5 Myr, and that no further genera have appeared since that time. He interprets this as showing that evolution was rapid during the early evolution of the family, and has slowed down since.

Is there any other explanation of the observations? How could you distinguish between different explanations?

Computer Projects

1. Imaginary phylogenies. Write a program to generate data similar to those on which Fig. 14.5 was based. Assume random extinction and speciation, but a constant number of genera. Consider how you might distinguish between real data and stochastic phylogenies of this kind. One way in which real and simulated data may differ is that 'living fossils' are relatively rare in simulated data. How could you test this? If it is correct, how could it be explained? (It is not difficult to generate suitable data, but harder to find a neat way of representing the data graphically.)

**Chapter 15—
Reconstructing Evolutionary History**

How to construct a phylogenetic tree	<u>300</u>
The reliability of trees	<u>303</u>
What use are phylogenetic trees?	<u>305</u>
Further reading	<u>306</u>

Pre-literate people assign living organisms to natural kinds (cats, dogs, oak trees, and so on) and then group these kinds into higher taxonomic groups. Long before Darwin, this process of classification was a major preoccupation of biologists. Since Darwin, it has been increasingly accepted that classification should reflect evolutionary relationships. More precisely, a taxon should be **monophyletic**: that is, it should include all the descendants, and only the descendants, of some common ancestor. Although this is sometimes contested, it is clear that such a phylogenetic classification is the kind of classification needed by biologists.

Classification is not normally seen as a branch of genetics. However, since it relies increasingly on molecular data, it seems right to give a brief introduction here. I will concentrate on the logic of tree construction, which is similar whether one is using molecular or morphological data. There are, however, two points that need emphasizing about the use of sequence data. The first is that the choice of molecule depends on the group being classified. For a group of closely related organisms, one needs a rapidly evolving molecule that varies sufficiently within the group (for example, mitochondrial DNA). For a more distantly related group, one needs a slowly evolving molecule, such as the DNA coding for ribosomal RNA, so that resemblances between the more closely related members of the group are still recognizable. The second point concerns the likelihood of parallel changes occurring in different lineages. Morphologists can reasonably assume that the pentadactyl limb, or Aristotle's lantern of echinoderms, evolved just once. In contrast, the substitution, say, of an A by a G at a particular site in a gene could well occur independently in two different lineages. This matters, because to allow for such repeated events, or **homoplasies**, is a major difficulty in tree construction.

A necessary assumption in the construction of a phylogenetic tree is that the objects to be classified arose by a branching process. It is also usual to assume that all branches were dichotomous: that is, a single ancestral lineage split to give rise to two descendent lineages. If two such splits followed closely one after the other, it may in practice be impossible to decide which occurred first, but the (perhaps

unjustified) assumption is usually made that, if we knew enough, all splits would be seen to be dichotomous. More important, it is assumed that lineages split, but never rejoin: history is to be represented by a tree, not by a net. This assumption is not true of all objects one might wish to classify: it would not be sensible to construct a phylogenetic tree of the students attending a lecture, or of the cars in the car park. In particular, if there has been genetic recombination between lineages, a tree is an inappropriate representation.

Groups for which tree construction is justified include the following:

- (1) members of an asexual population;
- (2) members of different sexual species, provided that inter-species hybridization can be ruled out, or of higher taxa;
- (3) mitochondrial genes, either between species, or, if inheritance is strictly maternal, within species;
- (4) Y chromosomes;
- (5) chromosomal genes, provided that intragenic recombination has not occurred.

How to Construct a Phylogenetic Tree.

Given that tree construction is valid, how is it to be done? Figure 15.1 gives imaginary data for four traits, *A-D*, in four individuals, 1-4. The traits could, in principle, be morphological or molecular, but for the moment suppose that they represent synonymous substitutions in four codons within a gene. Figure 15.1B is a possible phylogenetic tree, generating the four genotypes from a common ancestor. Note the following points:

1. The tree is a **maximum parsimony** tree: that is, a tree containing the minimum number of steps, or changes, needed to generate the observations. For larger data sets, it is often the case that a number of alternative, equally parsimonious trees exist.
2. The tree contains five steps, although there are only four polymorphic sites. One site *A*, has changed twice: as explained above, such a repeated event is called a homoplasy.
3. At one site, one alternative allele (*B*) is present in only one individual. Such a site is said to be 'uninformative', because it contributes nothing to finding the most parsimonious tree: whatever tree is chosen, variation at an uninformative site can always be explained by a single event in the terminal branch leading to the unique individual.
4. The tree has been 'rooted' in a common ancestor. This is not justified by the data, which are explained equally well by the tree shown in Fig. 15.1B. In fact, the data only justify the 'unrooted' tree shown in Fig. 15.1C.

In practice, trees are usually constructed using one of many computer packages, each offering a number of methods. How should we choose an appropriate

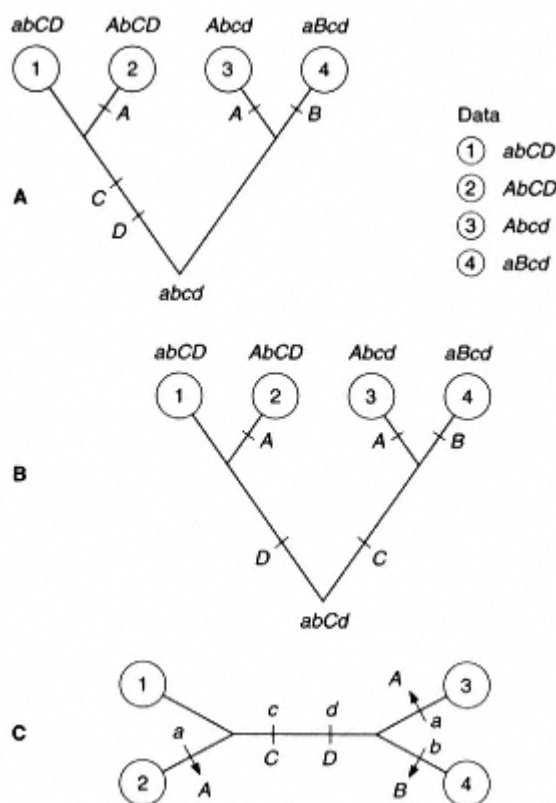

Figure 15.1

Constructing a phylogenetic tree. **A**, data, and a possible tree; **B**, an alternative tree with a different root; **C**, an unrooted tree, which is all that the data justify.

method? It seems natural to seek a tree that satisfies some 'optimization criterion'. A maximum parsimony tree does this. It seems sensible that a tree requiring a small number of evolutionary changes is more likely to be right than one requiring many changes. However, this need not be the case. Thus suppose that change *A*, which occurs twice in the tree in Fig. 15.1**A**, was not a single base change, but an intragenic inversion, with precisely the same break points. It is very unlikely that such a change could have occurred twice. If we insist that change *A* was unique, we are led to the tree in Fig. 15.2, which has six steps.

A second reason why maximum parsimony may give the wrong answer is illustrated in Fig. 15.3. The essential feature is that the tree has very different branch lengths. Imagine that all changes are synonymous transitions ($A \rightleftharpoons G$ or $T \rightleftharpoons C$). Eight typical sites, *a-h* are illustrated. Comparing taxa 3 and 4, there are three kinds of site:

1. Sites *a* and *b* are identical to the common ancestor, either because no change has occurred, or because two changes have occurred at the same site in the same branch (e.g. $A \rightarrow G$ and $G \leftarrow A$).

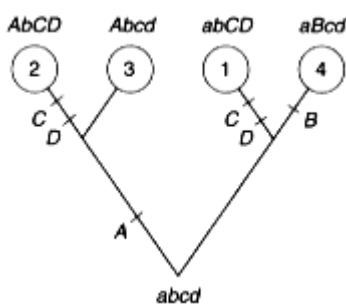

Figure 15.2
A tree that produces the genotypes listed in Figure 15.1, assuming that the change from *a* to *A*, or *vice versa*, was unique.

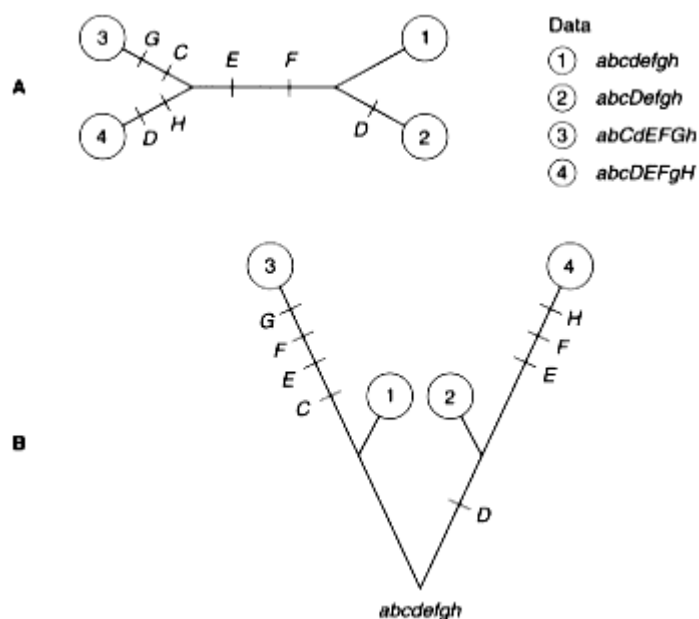

Figure 15.3
A tree with differing branch lengths. **A**, data, and the maximum parsimony tree; **B**, what actually happened. Because the branches leading to taxa 3 and 4 are longer (that is, more changes happened), and because some changes occurred independently in both branches, the maximum parsimony tree method leads to the wrong conclusion about the branching pattern.

2. Sites *c*, *d*, *g*, and *h* have changed in only one of the two branches. They are 'uninformative' in the sense described above, in that they do not influence the choice of the most parsimonious tree. However, they are not uninformative in a broader sense, because they tell us that taxa 3 and 4 are not closely related.

3. Sites *e* and *f* have changed in both branches. They are 'informative' but misleading, because they lead to the choice of the wrong tree.

Thus maximum parsimony may lead us to choose the wrong tree, either because not all changes are equally likely (e.g. synonymous versus non-synonymous changes), or because some branches are much longer than others. This has led to the idea that we should seek **maximum likelihood** tree. That is, we should first formulate some rules about how evolution has operated 棋 or example, that transversions are rarer than transitions. We then seek that tree which, if it is true, maximizes the probability of getting the observed data.

Both the parsimony and maximum likelihood methods have an 'optimization criterion'. The likelihood method has the additional advantage that it forces us to think about what assumptions about evolution are appropriate to the data. Both methods, however, have the drawback that they are expensive in computer time. To look at all possible trees, and choose the optimal one (so-called exhaustive search) is ruled out for more than about 15 taxa. This has led to the development of a number of algorithms, or search rules, which seek, in the vast number of possible trees, for a smaller number of candidate trees, which can be tested against the optimization criterion. Alternatively, all attempt at strict optimization can be abandoned, and an algorithm can be adopted because it seems sensible, and is known to give satisfactory results on small data sets, to which optimization criteria can also be applied. One such method is the 'neighbour-joining' algorithm. This calculates a 'genetic distance', allowing for the likelihood of different changes, between all pairs of strains. It then selects two nearest neighbours, and replaces them by a single genotype that is a plausible ancestor of the two neighbours. By repeating this process until only two genotypes remain, a tree is constructed.

We must now return to the problem of how a tree is to be rooted. For molecular data, the usual method is to include an 'outgroup' in the analysis (Fig. 15.4). An outgroup is a related taxon known (or believed on good grounds) to have a common ancestor more distantly in the past than the taxa being classified. Thus, returning to the imaginary data shown in Fig. 15.1, suppose that, in addition to taxa 1-4, we have a fifth taxon, 5, differing from all of them at four further sites ϵ - h . Because of these four differences, it is reasonable to assume that taxa 1-4 have a common ancestor more recently in the past than any of them do with taxon 5: that is, taxon 5 is an outgroup. For the sites varying within the taxa 1-4, taxon 5 has the genotype *abcd*. It is therefore parsimonious to assume that the common ancestor of taxa 1-4 also had this genotype, and to root the tree as in Fig. 15.1A. Of course, the root of the whole tree, including taxon 5, remains in doubt. Note that taxon 5 could have been identified as an outgroup by morphological rather than molecular data: for example, taxa 1-4 could be human, chimp, gorilla, and gibbon, and taxon 5 a baboon or macaque.

The Reliability of Trees

How reliable is an inferred tree? There are two kinds of error, systematic and random. A systematic error is one that would remain even if we had more data of

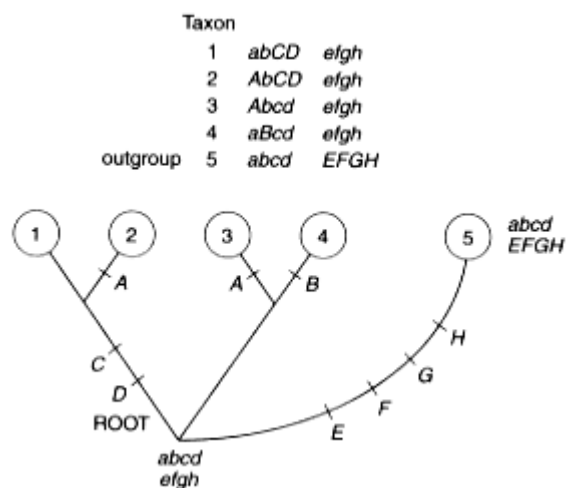

Figure 15.4
Rooting a tree.

the same kind. It arises because some inappropriate assumption has been made, explicitly or implicitly. Some possible sources of systematic error are:

1. There has been recombination or horizontal gene transfer *any* tree would be inappropriate.
2. Changes at different sites are not independent. This is particularly likely to be the case when using RNA molecules with secondary structure, because changes at one site in a hairpin loop will alter the likelihood of a change at the complementary site.
3. Excessive homoplasy. This is likely to be important when using maximum parsimony methods if branch lengths are very unequal, as illustrated in Fig. 15.3. Unequal branch lengths imply unequal rates of evolution, which in turn suggests that there has been directional selection: the difficulty is less likely to arise if changes have been neutral or nearly so.

Random errors arise because too few data are available. Suppose that a tree shows that man and chimp are more closely related than either is to the gorilla. How can one decide on the statistical significance of this conclusion? More generally, how can one decide on the significance of a particular branch point in a tree? The usual way of answering this question is the **bootstrap** method. Suppose, for example, there are 30 variable sites in the full data set. One constructs a new 'pseudo-sample' by sampling with replacement: that is, one chooses a site at random, adds it to the sample, and then replaces it in the full data set. One repeats this procedure until one has a new set of 30 sites. This new data set will contain some of the original sites once, some more than once, and some not at all. Having drawn such a sample, one constructs a tree, and notes whether it has the branch

point one is interested in. The 'bootstrap value' is the proportion of such trees that have the relevant branch point.

A high bootstrap value gives some confidence in the reality of the branch point. However, two warnings are necessary. First, the method gives no guarantee against systematic errors. Secondly, one should specify which branch point one is interested in before carrying out the test, because *some* branch point is likely to be preserved simply by chance.

What use are Phylogenetic Trees?

Three factors have made the construction of phylogenetic trees more reliable: the availability of molecular data, the use of computers to handle large bodies of data, and the development of a new theory of classification. But what can such trees tell us about the process of evolution? Some examples will help to make this clear:

1. The role of recombination. This is of particular importance in the study of the evolution of prokaryotes, because sexual fusion is never a requirement for reproduction, as it usually is in eukaryotes. The importance of recombination, therefore, is by no means obvious, and has in fact turned out to be very different in different kinds of bacteria. Phylogenetic analysis is useful in several ways. Suppose, for example, that sequences are available of several genes from a set of related strains. A phylogenetic tree can be constructed for each gene separately. If the trees are similar for the different genes, this suggests that recombination between strains has been infrequent. It is also possible to test for recombination by examining the sequences of the same gene from a set of strains. For example, the *recA* gene was sequenced from 15 strains of *Neisseria*, the genus to which the causative agents of gonorrhoea and bacterial meningitis belong. Thirty-nine synonymous third sites were polymorphic in the data set, each with two alleles. The most parsimonious tree had 18 homoplasies, compared to an expected number of 3.5 if there had been no horizontal transfer within the gene. There is therefore good reason to think that intragenic recombination has occurred. In such a case, the point of constructing a tree is not that it gives a correct picture of what has happened, but that it shows that no tree, representing a pure branching process, can be a correct picture.
2. The mechanism of speciation. Figure 8.9 (p. 153) superimposes a phylogeny of the deer mouse, *Peromyscus*, on a map of North America. This can tell us about the way in which geographical variation has arisen within a species, and can sometimes reveal incipient speciation.
3. The comparative method. Often, we try to identify the selective forces responsible for the evolution of some characteristic by comparing species. For example, in many primates, males are larger than females. Is this the result of competition between males for females, or an adaptation for defence against

predators? The first explanation is almost certainly correct, because the degree of sexual dimorphism in size and weapons is small in monogamous species, and large in polygynous ones. However, the conclusion depends on numbers; if only two primates were known, one monogamous and with no size dimorphism, and the other polygynous with a big size dimorphism, it would be unwise to draw any conclusion. What we need to know is the number of occasions on which the association between a particular trait (e.g. size dimorphism), and a particular ecological situation (e.g. polygyny) has evolved independently. There are problems in deciding on the relevant numbers. For example, there are several species of gibbon, all monogamous, and all with little difference in size between male and female. They should, therefore, count as only a single example of the coevolution of the two traits. Clearly, such decisions depend on an accurate phylogeny.

That the difficulty can be a real one is illustrated by Fig. 12.4, p. 232, showing that the chiasma frequency is higher in domestic animals, and supporting the theory that directional selection causes an increase in recombination rate. A weakness of the argument is that, of the seven domestic species, two were carnivores, four artiodactyls, and one a perissodactyl, whereas the wild species were marsupials, rodents, or primates. It would be good to have data on a zebra, an antelope, and a hunting dog. Clearly, inferences from the comparative method depend on reliable phylogenetic information. The matter is discussed further by Harvey and Pagel (1991).

Further Reading

Harvey, P.H. and Pagel, M.D. (1991). *The comparative method in evolutionary biology*. Oxford University Press.

Hillis, D.M., Moritz, C., and Mable, B.K. (ed.) (1996). *Molecular systematics* (2nd edn). Sinauer, Sunderland. (Particularly the chapter on phylogenetic inference.)

Ridley, M. (1986). *Evolution and classification*. Longman, New York.

Answers to Problems

Chapter 1

1. $26^{19} = 7.66 \times 10^6$.

2. (a) $P(\text{all 19 letters wrong}) = (25/26)^{19} = 0.475$, so $P(\text{at least one letter correct}) = 0.525$. (b) $19 \times (25/26)^{18} \times 1/26 = 0.361$.

3. $P(\text{a particular incorrect letter mutates to a correct one}) = 1/100 \times 1/25 = 0.0004$. Hence $P(\text{in all 10 copies, all letters remain incorrect}) = (1 - 0.0004)^{10} = 0.9268$. Hence $P(\text{at least one letter correct}) = 0.0732$.

4. $1/0.0732 = 14$ generations approximately.

5. For a particular copy, $P(19 \text{ are correct}) = P(18 \text{ remain correct}) \times P(19\text{th mutates to correct value}) = (99/100)^{18} \times 0.0004 = 0.000334$. Hence $P(\text{one copy out of 10 has all 19 correct}) = 0.00334$.

6. Perhaps it is the fact that the program has a representation of the optimum message, and determines the 'fitness' of actual messages by comparing them to the optimum. No analogous process occurs during natural selection.

Chapter 2

1. $\delta x = x(r\delta t - cx\delta t)$, or $dx/dt = rx(1 - cx/r)$. The carrying capacity $K = r/c$. Note that the carrying capacity is reached when births = deaths: that is, when $r = cx$. Referring to Box 2.1, this can be regarded as microscopic justification of the logistic equation.

2. (a) Probability of accurate replication $Q = 0.999^{100} = 0.9048$. (b) $(RQ - r)x_1 = R(1 - Q)x_0$, or $(Q - r/R)x_1 = (1 - Q)x_0$. If $x_0 + x_1 = 1$, $Q = 0.9048$ and $r/R = 1/1.2$, then $x = 0.429$. (c) If u is the per base error rate, then $Q > r/R$ requires $(1 - u)^{100} > 1/1.2$, or $u < 0.00182$.

3. Given randomness, the following should be true:

(i) The expected number of generations in which the copy number increases equals the number in which it decreases. For n generations, the variance of the number is $npq = n/4$.

(ii) Following an increase (or decrease), the copy number is equally likely to increase or decrease.

(iii) The change in copy number in a generation should be normally distributed, with mean 0 and variance $50p(1 - p)$, where p is the frequency in the preceding generation.

4. The expected number in the next generation is normally distributed, with mean 700 and standard deviation $\sqrt{(1000 \cdot 0.7 \cdot 0.3)} = 14.5$. To exceed 730 is to be just over twice the SD above the mean, which will happen with a probability of approximately 1/50. (A Poisson family-size distribution has been assumed.)
5. There are 1000 gene copies. The expected time to fixation of one copy by drift is $2N = 2000$ generations.
6. Whichever type is initially more abundant will eliminate the other.

Chapter 3

1. Not consistent (χ^2 with 1 df = 7.9, $P < 0.01$). There is an excess of homozygotes. This could be caused by selection, but a more likely explanation is that the mice do not come from a single random-mating population. If so, other loci should show a similar departure from the Hardy-Weinberg ratio.
2. Ginger, 0.0025; tortoiseshell, 0.095. Assumptions: equal gene frequencies in males and females, random mating.
3. No. The expected numbers are 243.9 of each homozygote, and 512.2 heterozygotes. Actual numbers would, of course, differ from these values by chance. But the difference between the expected numbers, and those expected from the Hardy-Weinberg ratio (250:500:250) is far too small to be detected.
4. Let the frequency of one allele, A , be p in males and P in females. Then the frequency of AA among the progeny is pP . The frequency of A among the progeny is $(p + P)/2$, and so the frequency of AA expected from the Hardy-Weinberg ratio is $(p + P)^2/4$. Hence (actual frequency of AA) - (frequency of AA expected from the Hardy-Weinberg ratio) = $pP - (p + P)^2/4 = -(p - P)^2/4$. Hence, if $p \neq P$, there is a deficiency of homozygotes, and therefore an excess of heterozygotes.
5. (a) 0.39 A:0.24 B:0.12 AB:0.25 O. (b) The mother must be BO ; the father is AA with probability $0.09/0.39 = 0.231$, and AO with probability 0.769. Hence the sib is A with probability $(0.231 \cdot 1/2) + (0.769 \cdot 1/2 \cdot 1/2) = 0.308$.
6. Type A , $R_0 = 2$, $r = 0.1386$; type B , $R_0 = 3$, $r = 0.1569$. (Remember that only one half of the seeds are female.) Since both the values of r are positive, the population is increasing, regardless of the frequencies of the two types. Type B is fitter.
7. (a) Since p and s are both small, we can use $p_n = p_0 e^{shn}$, where $s = 0.01$, $h = 1$, $p_0 = 1/100\,000$, and $p_n = 1/100$. Hence $e^{0.01n} = 1000$, or $n = 691$ generations. (b) Integrating $\dot{p}/dt = sp^2$ gives $st = \text{Const.} - 1/p$. When $t = 0$, $p = 1/100\,000$, and hence $st = 100\,000 - 1/p$, or $t \cong 10^7$ generations. The result is misleading for the following reason. It assumes that, if $p = 1/100\,000$, the frequency of homozygotes is 10^{10} . Now a very large population is unlikely to mate randomly, because most individuals will mate with others that were born reasonably close

to them (this may not be true for marine species with planktonic larvae), and therefore their mates will be more closely related to them than a random member of the species. Therefore, the frequency of homozygotes will be higher than predicted from the Hardy-Weinberg ratio. However, it is true that the initial increase of a rare favourable recessive will be very slow, unless inbreeding is common. The problem of structured populations is discussed further in Chapters 8 and 9.

Chapter 4

1. At the first locus, the heterozygosity is $2[(0.12 \times 0.7) + (0.7 \times 0.18) + (0.18 \times 0.12)] = 0.4632$; at the second locus, it is $2 \times 0.37 \times 0.63 = 0.4662$. It is zero at the other two loci. Hence average heterozygosity = 0.232.

2. (a) $26 \times 25/2 = 325$. (b) If we look at the 26 lethals in turn, the probability that the second is different from the first is 0.999; if so, the probability that the third is different from the first two is 0.998; hence the probability that all 26 are different is $0.999 \times 0.998 \times \dots \times 0.975 = 0.721$. (c) Probability that exactly one pair of alleles found = (probability that a particular pair are alleles) \times (number of pairs) \times (probability that remaining 24 are all different) = $(1/1000) \times (26 \times 25/2) \times 0.758 = 0.246$. (d) Suppose that an essential protein is coded for by two (or more) linked loci. If the frequency of non-functional recessives at each locus is low, there is almost no chance of finding individuals homozygous for non-functional alleles at both loci. Hence our estimate of the number of essential genes will not include proteins coded for by a gene family. But will the frequency of non-functional recessives be low? It will, provided that there is some difference between the loci, so that individuals lacking one or other of the proteins, although viable, are less fit than individuals with both loci functional. If the loci code for identical proteins, one of them is likely to be lost by the accumulation of mutations.

3. $u = psh$. $p = 10/2 \times 94 \times 0.75$. Fitness of heterozygotes = $27/108 \times 457/582 = 0.20$. Hence $s = 0.80$, and $u = 4.3 \times 10^{-5}$.

4. (a) $p = \sqrt[3]{(u/s)}$, or $u = p^2s$, where $p^2 = 1/10\,000$ and $s = 1$. Hence $u = 1/10\,000$. (b) if the relative fitnesses are 1:1- δ , then from Equation 4.5 $p = \delta/(1 + \delta)$. Since $p = 1/100$, $\delta = 1/99$.

6. $p(A) = 0.9091$; $W = 0.9545$, so load = 0.0455.

7. Fitness of homozygote = 0.889; $W = 0.90$, so load = 0.1.

8. At equilibrium, $0.75 + P = 1.5 - P$, or $P = 0.375$. If p is the frequency of A , then $(1 - p)^2 = 0.375$, or $p = 0.388$. The equilibrium is stable, because dark is fitter than pale when dark is rare, and pale is fitter than dark when pale is rare. The genetic load at equilibrium is zero, because all three genotypes have the same fitness.

9. Relative to M flies, the viability of $+^1/+^2$ is $467/2 \times 201 = 1.1617$, and of $+^1/+^1$ is $376/2 \times 197 = 0.9543$. Hence the relative viability of $+^1/+^1$ is 0.821.

10. If there are no cell deaths, one cell gives rise to 10^8 cells by $10^8 - 1$ cell divisions. If the back mutation rate = u , the probability of no back mutations in a tube is $(1 - u)^{10^8} = \exp(-10^8 u) = 0.72$, or $u = 3.28 \times 10^{-9}$.

Chapter 5

1. -0.02.

2. $-0.02 - 0.9 = -0.0131$.

3. Yes. Writing the frequencies of the four phenotypes as $p(AB)$, $p(Ab)$, $p(aB)$, and $p(ab)$, we expect $p(AB) p(ab) = p(Ab) p(aB)$ if there is linkage equilibrium.

4. (a) Zero. (b) Negative. Let the initial frequencies of the haplotypes be $p(AB)$, $p(Ab)$, $p(aB)$, and $p(ab)$, where $p(AB) p(ab) = p(Ab) p(aB)$. In case (a) D after one generation is $p(AB) p(ab) [(1+s)(1+t) - (1+s)(1+t)] = 0$. In case (b) $D = p(AB) p(ab) [1+s+t - (1+s)(1+t)] = -st p(AB) p(ab)$. It is an important result, due to Felsenstein, that, if a population starts in linkage equilibrium, and fitnesses are multiplicative (case a), it remains in linkage equilibrium. But if the population is exposed to directional selection, and fitnesses increase less steeply than in the multiplicative case, then negative linkage disequilibrium is produced.

Chapter 6.

1. (a) 6.5 10^6 ; (b) 2.44.

2. Heritability = $2.44/6$, so response = $1 - h^2 = 0.407$.

3. Sex is genetically determined, but there is no correlation between the sex of a child and a parent. So the broad-sense heritability = 1, and the narrow-sense heritability = 0.

4. If the half-sibs were raised apart, this implies a heritability of $4 - 0.3 = 1.2$, which is not possible. But if they are raised together, or in similar environments, a value of 0.3 is quite plausible.

5. 1.4.

6. $h^2 = 0.4$, and $S = 3$, so expected value of offspring is $18 + 0.4 \cdot 3 = 19.2$ bristles.

7. Total variance = 9, and $h^2 = 0.3$, so $V_A = 2.7$. Total difference $D = 16$. From Box 6.7, if initial gene frequencies are 0.5, number of loci $= D^2 / \delta V_A \cong 12$ loci.

8. 0.63ab:0.37AB. Note that this implies instability of the equilibrium shown in Table 6.5, because the frequencies have moved away from the equilibrium point. Usually, epistatic fitnesses give rise to alternative stable monomorphic states, with an unstable equilibrium between them. Stable polymorphic states, such as heterostyly and mimicry, are maintained by frequency-dependent fitnesses.

9. If there are n loci, and the effect per allele substitution is s , then the initial

variance is $n \cdot 2 \cdot 0.01 \cdot 0.99 = 0.0198d^2$. The maximum variance is reached when half the loci have $p = q = 0.5$; by this time the remaining loci will contribute little. Hence the maximum variance $n(2) \times 2 \cdot 0.5 \cdot d^2 = 0.25nd^2$. That is, the genetic variance is increased by a factor of 12.6. In practice, the increase would be less than this, because different loci would change at different rates, but it should still be detectable.

Chapter 7

1. (a) All R , or all S . (b) The unstable equilibrium, with R and S equally fit, occurs when $p(R) = 0.25$, $p(S) = 0.75$. If R is initially commoner than 0.25, it will increase. When $p(A) = 0.4$, $p(a) = 0.6$, and hence, with random mating, $p(R) = 0.36$. Hence the population will evolve to $p(R) = 1$, $p(a) = 1$.

2. The ESS is $p(R) = 0.25$, $p(S) = 0.75$. Therefore $p^2(a) = 0.75$, or $p(a) = 0.866$.

3. There are two ESSs: all C , or $M = (0.5A:0.5B)$. Note that $E(M, M) = 3.5$, and $R(C, M) = 2$, so C cannot invade M .

4. Let FA , FL , and FS be the strategies 'always escalate', 'escalate if larger, withdraw if smaller', and 'escalate if smaller, withdraw if larger', respectively. In a contest, an individual has a 50 per cent chance of being larger. (a) $E(FA, FA) = R/2 - C/2$; $E(FL, FA) = 1/2[PR - (1 - P)C]$. Hence FA is stable against invasion by FL provided that $R - C > PR - (1 - P)C$, or $(1 - P)R > PC$. This is possible provided that $P \neq 1$, and the reward is large relative to the cost. (b) $E(FS, FS) = R/2$; $E(FA, FS) = 1/2[RP - (1 - P)C] + R/2$. Hence FS is stable against invasion by FA provided that $RP - (1 - P)C < 0$, or $RP < (1 - P)C$. Hence the paradoxical strategy, 'escalate if smaller', can be an ESS, provided that $P \neq 1$, and costs are large relative to rewards. But I doubt whether such a paradoxical strategy has often evolved. Whenever the payoffs are such as to make it possible, the 'common-sense' strategy 'escalate if larger' is also an ESS. (c) The 'payoff' for death means the change in fitness caused by death. Hence C is the expected reproductive success of an animal that withdraws from the contest without fighting.

5. (a) The payoff matrix is:

	watch	don't watch
watch	4	4
don't watch	5	2.5

Hence the evolutionarily stable state is $3/5$ watch: $2/5$ don't watch. (b) Watchers always have a fitness of 4. Non-watchers have a fitness of 5 when rare, and 2.5 when common, so there must be a mixed ESS. Let p be the proportion of watchers at the ESS. Then the chance that a non-watcher will flock with four other non-watchers is $P = (1 - p)^4$. Now at the ESS watchers and non-watchers are equally fit, so $4 = 5(1 - P) + 2.5P$, or $P = 2/5$. Hence $p = 0.205$.

Chapter 8

1. There is a chance of $1/16$ that an F_2 individual will be homozygous for a particular lethal present in a grandparent, and $15/16$ that it is not. Since there are 12 lethals expected in the grandparents (4 genomes \times 3), the probability that an F_2 animal survives is $(15/16)^{12} = 0.461$.

2. (a) Yes. The chance that a particular locus is still heterozygous is $1/2 = 0.5$. Hence the chance that it is homozygous at all loci is $(15/16)^6 = 0.679$, or greater than one-half. (b) The chance that an F_4 plant is heterozygous at all six loci is $(1/16)^6 = 6 \times 10^{-8}$. The chance that it is heterozygous at five loci is $6 \times (1/16)^5 \times 15/16 = 5.36 \times 10^{-6}$. So the chance of a plant being as (or more) heterozygous as the one examined is 5.42×10^{-6} . This is the kind of thing that doesn't happen to me, so I would conclude that the simple theory does not apply, probably because there is selection favouring heterozygotes.

3. $N_e = 21.4$.

4. (a) $2s = 1/50$. (b) From Equation 3.6, the expected number of copies of a gene after 60 generations is $n_{60} = \exp(0.01 \times 60) = 1.822$. However, if n is the number of copies, given that it survives, and P is the probability that it does survive, then $n_{60} = nP + 0(1 - P)$ or $n = n_{60}/P = 1.822 \times 50 = 91$. (Note that this assumes that a gene that has survived for 60 generations is sure to be established.)

5. Taking a human generation as 20 years, the evolution rate is $0.15 \times 20 \times 10^6 = 3 \times 10^6$ substitutions per gene per generation. On the neutral theory, this should equal u , the neutral mutation rate. The expected proportion of the population homozygous is $1/(1 + 4Nu)$, or approximately 1 in 10^6 . The observed proportion is greater than 0.99. However, this discrepancy does not disprove the neutral theory, because the expected homozygosity is an equilibrium value, approached after N_e generations. The observations are consistent with the neutral theory if the human population has recently passed through a bottleneck of numbers.

Chapter 9

1. No. The genotype of this 'species' consists of those genes that happened to be present in the original hybrid.

2. Yes. A gene causing sib altruism in armadillos would spread if $b > c$, compared to the requirement $b > 2c$ in typical litter-producing mammals. So far as I know, altruism towards sibs has not been observed in armadillos. The explanation may be that the biology of armadillos is such that no mutations favouring sib altruism have occurred. This is to explain the absence of altruism by appealing to 'developmental constraints'. This may be correct, but unless one can point to specific features of armadillo biology that make sib altruism impossible, it is an unhelpful explanation.

3. (a) More than 3 (that is, 4; otherwise the subordinate would do better to leave, and one would not observe pairs). (b) None. Calculate the number N of genes transmitted that are IBD to the subordinate if she leaves, and if she stays. If she leaves, $N = 3$ (her own offspring) + $3/2$ (her dominant sib's offspring) = 4.5. If she stays, $N = 0$ (her own) + $10/2$ (her sib's) = 5. So it pays the subordinate to stay, even if she raises no eggs of her own (but it wouldn't if there was any appreciable doubt that the dominant bird was her full sib).

4. (a) Yes. The dominant would raise 5 offspring instead of $7/2 = 3.5$. (b) No. The dominant has an inclusive fitness of 5 if he drives his brother out, and $7/2 + 1/2 \cdot 7/2 = 5.25$ if he does not. (c) Yes. The dominant has an inclusive fitness of $7/2 + 1.4 \cdot 7/2 = 4.375$ if he allows his half-brother to stay, which is less than 5.

5. The female would not join her brother. If N is the number of genes IBD to her own that are transmitted to the next generation, then if she joins $N = 1/2$ (her own genes) + $1/2 \cdot 1/2$ (her brother's genes) = $3/4$, whereas $N = 1$ if she does not join. The male would accept his sister if she did join: from his point of view, $N = 1/2 + 1/2 \cdot 1/2 = 3/4$ if she joins, and $1/2$ if she does not.

6. $9/16$ of females comes from joint nests. If they do, their probability of being full sibs is $0.8 \cdot 0.2^2 = 0.68$. If they are not full sisters, their coefficient of relatedness is $1/2$. Hence $r = 7/16 \cdot 0.75 + 9/16(0.68 \cdot 0.75 + 0.32 \cdot r/2)$, or $r = 0.676$.

Chapter 13

Part A

1. Female bias (sons cost more).
2. No bias.
3. Male bias (male zygotes are cheaper).
4. No bias.
5. No bias (eggs cost just as much to lay even if they die).
6. Female bias (the colony is the unit of evolution, and is more likely to split into two if it contains more females).
7. Females produce two sons, or two daughters, with equal frequency: there are no mixed litters.

Part B

1. A single seed can found a population.
2. By suppressing male function, a cytoplasmic gene increases seed production, and hence its own transmission to the next generation.
3. In haplo-diploids, recessive genes are exposed to selection in males, on average once in three generations. Hence the load of deleterious recessives in an outbred population will be lower in haplo-diploids, and therefore inbreeding will be less harmful.

4. In a large plant, selfing between different flowers is more likely than in a small one.
5. Most animals have separate sexes. Allopolyploidy would mess up most sex-determining mechanisms. An alternative explanation is that tetraploid cells have twice the volume of diploid ones, and a doubling of cell volume would be more damaging in an animal than a plant.

Chapter 14

1. Number of generations = 2.67×10^5 . If volume increased by a fraction x per generation, then $(1+x)^{2.67 \times 10^5} = 3$, or $x = 0.4115 \times 10^{-5}$. Hence $S = 0.823 \times 10^5$ mean volume. Hence $I = 0.823 \times 10^4$.
2. A simple method is as follows. Did the ratio (number of artiodactyls/number of perissodactyls) increase in all nine time-intervals? The probability of a change in the same direction (up or down) in nine successive intervals, on the null hypothesis, is $1/256$.
3. It could be that taxonomists have placed any fossil they believe to be ancestral to *Loxodonta* in that genus, and similarly for the other two genera. If so, and if evolutionary divergence has proceeded at a uniform rate, the morphological differences between early representatives of the three genera should be less than between recent ones. To test this, you would have to devise a measure of morphological difference.

References

- Allee, W.C., Emerson, A.E., Park, O., Park, T., and Schmidt, K.P. (1949). *Principles of animal ecology*. W.B. Saunders, Philadelphia.
- Andersson, M. (1984). The evolution of eusociality. *Annual Review of Ecology and Systematics* **15**, 165-89.
- Arak, A. (1983). Sexual selection by male-male competition in natterjack toad choruses. *Nature* **306**, 261-2.
- Awise, J.C. (1986). Mitochondrial DNA and the evolutionary genetics of higher animals. *Philosophical Transactions of the Royal Society of London* **B312**, 325-42.
- Bell, G. (1982). *The masterpiece of nature*. University of California Press, Berkeley.
- Bendall, B.S. (ed.) (1983). *Evolution from molecules to men*. Cambridge University Press.
- Bennett, J. (1960). A comparison of selective methods and a test of the preadaptation hypothesis. *Heredity* **15**, 65-77.
- Boag, P.T. and Grant, P.R. (1981). Intense natural selection in a population of Darwin's finches (Geospizinae) in the Galapagos. *Science* **214**, 82-5.
- Bradbury, J.W. and Andersson, M. (ed.) (1976). *Sexual selection: testing the alternatives*. Wiley, New York.
- Brown, W.M., George, M., and Wilson, A.C. (1979). Rapid evolution in animal mitochondrial DNA. *Proceedings of the National Academy of Sciences, USA* **76**, 1967-71.
- Bull, J. (1983). *Evolution of sex determining mechanisms*. Benjamin Cummings, Menlo Park, California.
- Bulmer, M.G. (1980). *The mathematical theory of quantitative genetics*. Oxford University Press.
- Bumpus, H.C. (1899). The elimination of the unfit as illustrated by the introduced sparrow *Passer domesticus*. *Biological Lectures of the Marine Biological Laboratory, Woods Hole* **209**.
- Burt, A. and Bell, G. (1987). Mammalian chiasma frequencies as a test of two theories of recombination. *Nature* **326**, 803-5.
- Cavalier-Smith, T. (ed.) (1985). *The evolution of genome size*. Wiley, New York.
- Charlesworth, B. and Charlesworth, D. (1975). An experiment on recombinational load in *Drosophila melanogaster*. *Genetical Research, Cambridge* **25**, 267-74.
- Charlesworth, B. and Charlesworth D. (1979). The evolutionary genetics of sexual systems in flowering plants. *Proceedings of the Royal Society of London* **B205**, 513-30.
- Charnov, E.L. (1982). *The theory of sex allocation*. Princeton University Press.
- Clarke, J.M. and Maynard Smith, J. (1955). The genetics and cytology of *Drosophila subobscura*. XI. Hybrid vigour and longevity. *Journal of Genetics* **53**, 172-80.
- Clay, K. (1988). Clavicipitaceous fungal epiphytes of grasses: coevolution and the change from parasitism to mutualism. In *Coevolution of fungi with plants and animals*, (ed K.A. Pirozynski and D.L.

Hawksworth), pp. 79-105. Academic Press, London.

- Clayton, G. and Robertson, A. (1955). Mutation and quantitative variation *American Naturalist* **89**, 151-8.
- Clutton-Brock, T.H., Harvey, P.H., and Rudder, B. (1977). Sexual dimorphism, socioeconomic sex ratio and body weight in primates. *Nature* **269**, 797-800.
- Coyne, J.A. and Orr, H.A. (1989). Patterns of speciation in *Drosophila*. *Evolution* **43**, 362-81.
- Crow, J.F. (1986). *Basic concepts in population, quantitative and evolutionary genetics* W.H. Freeman, New York.
- Crow, J.F. and Kimura, M. (1970). *An introduction to population genetics theory* Harper and Row, New York.
- Cullis, C.A. (1983). Variable DNA sequences in flax. In *Genetic rearrangement*, (ed. K.F. Chater *et al.*), pp. 253-64. Croom Helm, London.
- Cunha, A.B. da (1949). Genetic analysis of the polymorphism of colour pattern in *Drosophila polymorpha*. *Evolution* **3**, 239-51.
- Darwin, C. (1859). *On the origin of species by means of natural selection or the preservation of favored races in the struggle for life* Murray, London.
- Dawkins, R. (1896). *The blind watchmaker*. Longman, Harlow.
- Dempster, E.R. (1955). Maintenance of genetic heterozygosity. *Cold Spring Harbor Symposia in Quantitative Biology* **20**, 25-32.
- Dobzhansky, Th. (1951). *Genetics and the origin of species*, (3rd edn). Columbia University Press, New York.
- Dobzhansky, Th., Spassky, B., and Tidwell, T. (1963). Genetics of natural populations. XXXII. Inbreeding and the mutational and balanced loads in natural populations of *D. pseudoobscura*. *Genetics* **48**, 361-73.
- Doolittle, W.F. and Sapienza, C. (1980). Selfish genes, the phenotype paradigm and genome evolution. *Nature* **284**, 601-3.
- Dover, G.A. and Flavell, R.B. (ed.) (1982). *Genome evolution*. Academic Press, London.
- Dubos, R. (1965). *Man adapting*. Yale University Press, New Haven.
- Eigen, M., Gardiner, W., Schuster, P., and Winkler-Oswatich, R. (1981). The origin of genetic information. *Scientific American* **244**, 88-118.
- Eldredge, N. (1985). *Time frames*. Simon and Schuster, New York.
- Eldredge, N. and Gould, S.J. (1972). Punctuated equilibria: an alternative to phyletic gradualism. In *Models in palaeobiology* (ed. T.J.M. Schopf), pp. 82-115. Freeman and Cooper, San Francisco.
- Falconer, D.S. (1981). *Introduction to quantitative genetics*, (2nd edn). Longman, London.
- Feldman, M.W., Christiansen, F.B., and Brooks, L.D. (1980). Evolution of recombination in a constant environment. *Proceedings of the National Academy of Sciences, USA* **77**, 4838-41.
- Fenchel, T. and Christiansen, F. (1977). In *Measuring selection in natural populations*, (ed. F. Christiansen and T. Fenchel), pp. 477-98. Springer-Verlag, New York.

Fenner, F. (1983). Biological control, as exemplified by smallpox eradication and myxomatosis. *Proceedings of the Royal Society of London* **B218**, 259-85.

Finnegan, D.J. (1985). Transposable elements in prokaryotes. *International Review of Cytology* **93**, 281-326.

Frankham, R., Briscoe, D.A., and Nurthen, R.K. (1978). Unequal crossing over at the rRNA locus as a source of quantitative genetic variation. *Nature* **272**, 80-1.

- Futuyma, D.J. (1986). *Evolutionary biology*, (2nd edn). Sinauer, Sunderland.
- Futuyma, D.J. and Slatkin, M. (ed.) (1983). *Coevolution*. Sinauer, Sunderland.
- Gale, J.S., Solomon, R., Thomas, W.T.B., and Zuberi, M.I. (1976). Variation in wild populations of *Papaver dubium*. XI. Further studies on direction of dominance. *Heredity* **36**, 417-22.
- Gilbert, W. (1978). Why genes in pieces? *Nature* **271**, 501.
- Gillespie, J.H. (1984). The molecular clock may be an episodic clock *Proceedings of the National Academy of Sciences, USA* **81**, 8009-13.
- Gillespie, J.H. (1987). Molecular evolution and the neutral allele theory *Oxford Surveys in Evolutionary Biology* **4**, 10-37.
- Gingerich, P.D. (1983). Rates of evolution: effects of time and temporal scaling *Science* **222**, 159-61.
- Givnish, T.J. (1982). Outcrossing versus ecological constraints in the evolution of dioecy *American Naturalist* **119**, 849-65.
- Gottlieb, L.D. (1984). Genetics and morphological evolution in plants *American Naturalist* **123**, 681-709.
- Grafen, A. (1985). A geometric view of relatedness. *Oxford Surveys in Evolutionary Biology* **2**, 28-89.
- Grafen, A. (1986). Split sex ratios and the evolutionary origins of eusociality *Journal of Theoretical Biology* **122**, 95-121.
- Haigh, J. (1978). The accumulation of deleterious genes in a population 櫻uller's ratchet. *Theoretical Population Biology* **14**, 251-67.
- Haldane, J.B.S. (1949). Disease and evolution. *La Ricerca Scientifica*, Supp. A, 3-11.
- Hamilton, W.D. (1967). Extraordinary sex ratios. *Science* **156**, 477-88.
- Hamilton, W.D. (1975). In *Biosocial anthropology*, (ed. R. Fox), pp. 133-55. Wiley, New York.
- Hartl, D.L. (1980). *Principles of population genetics*. Sinauer, Sunderland.
- Hartl, D.L. and Dykhuizen, D.E. (1984). The population genetics of *Escherichia coli*. *Annual Review of Genetics* **18**, 31-68.
- Harvey, P.H. and Pagel, M.D. (1991). *The comparative method in evolutionary biology*. Oxford University Press.
- Hasegawa, M., Kishino, H., and Taka-aki, Y. (1985). Dating of the human-ape splitting by a molecular clock of mitochondrial DNA. *Journal of Molecular Evolution* **32**, 160-74.
- Herre, E.A. (1993). Population structure and the evolution of virulence in nematode parasites of fig wasps. *Science* **259**, 1442-5.
- Hillis, D.M., Moritz, C., and Mable, B.K. (ed.) (1996) *Molecular systematics*, (2nd edn). Sinauer, Sunderland.
- Hochman, B. (1971). Analysis of chromosome 4 in *D. melanogaster*. *Genetics* **67**, 235-52.
- Hollingsworth, M.J. and Maynard Smith, J. (1955). The effects of inbreeding on rate of development and on fertility in *Drosophila subobscura*. *Journal of Genetics* **53**, 295-314.

Jones, J.S. and Yamazaki, T. (1974). Genetic background and the fitness of allozymes *Genetics* **78**, 1185-9.

Kan, Y.W. and Dozy, A.M. (1978). Polymorphism of DNA sequence adjacent to human β - globin structural gene: relationship to sickle mutation *Proceedings of the National Academy of Sciences, USA* **75**, 5631-5.

Kettlewell, H.B.D. (1955). Selection experiments on industrial melanism in the Lepidoptera *Heredity* **9**, 323-42.

- Kimura, M. (1968). Evolutionary rate at the molecular level *Nature* **217**, 624-6.
- Kimura, M. (1983). *The neutral theory of molecular evolution*. Cambridge University Press.
- King, J.L. and Jukes, T.H. (1969). Non-Darwinian evolution. *Science* **164**, 788-98.
- Kirkpatrick, M. (1982). Sexual selection and the evolution of female choice *Evolution* **36**, 1-12.
- Kondrashov, A.S. (1982). Selection against harmful mutations in large sexual and asexual populations. *Genetical Research, Cambridge* **40**, 325-32.
- Kreitman, M. (1983). Nucleotide polymorphism at the alcohol dehydrogenase locus of *Drosophila melanogaster*. *Nature* **304**, 412-17.
- Kummer, H., G鰏z, W., and Angst, W. (1974). Triadic differentiation: an inhibitory process protecting pair bonds in baboons. *Behaviour* **49**, 62-87.
- Lande, R. (1975). The maintenance of genetic variability by mutation in a polygenic character with linked loci. *Genetical Research, Cambridge* **26**, 221-35.
- Lande, R. (1981a). Models of speciation by sexual selection on polygenic traits *Proceedings of the National Academy of Sciences, USA* **78**, 3721-5.
- Lande, R. (1981b). The minimum number of genes contributing to quantitative variation between and within populations. *Genetics* **99**, 541-53.
- Langley, C.H., Ito, K., and Voelker, R.A. (1977). Linkage disequilibrium in natural populations of *Drosophila melanogaster*. Seasonal variation. *Genetics* **86**, 447-54.
- Law, R. and Koptur, S. (1986). On the evolution of non-specific mutualism *Biological Journal of the Linnaean Society* **27**, 251-67.
- Law, R. and Lewis, D.H. (1983). Biotic environments and the maintenance of sex ratio: some evidence from mutualistic symbioses. *Biological Journal of the Linnaean Society* **20**, 249-76.
- Levene, H. (1953). Genetic equilibrium when more than one ecological niche is available *American Naturalist* **87**, 311-13.
- Lewontin, R.C. (1974). *The genetic basis of evolutionary change*. Columbia University Press, New York.
- Li, W.H., Tanimura, M., and Sharp, P.M. (1987). An evaluation of the molecular clock hypothesis using mammalian DNA sequences. *Journal of Molecular Evolution* **25**, 330-42.
- Lively, C.M., Craddock, C., and Vrijenhoek, R.C. (1990). Red Queen hypothesis supported by parasitism in sexual and clonal fish *Nature* **344**, 864-6.
- Majerus, M.E.N., O'Donald, P., and Weir, J. (1983). Female mating preference is genetic *Nature* **300**, 521-3.
- Margulis, L. (1970). *Origin of eukaryotic cells*. Yale University Press, New Haven.
- Margulis, L. (1981). *Symbiosis in cell evolution*. W.H. Freeman, San Francisco.
- Margulis, L. and Fester, R. (ed.) (1991). *Symbiosis as a source of evolutionary innovation*. MIT Press, Cambridge, Mass.
- Mather, K. and Harrison, B.J. (1949). The manifold effects of selection *Heredity* **3**, 1-52.

May, R.M. and Anderson, R.M. (1983). Epidemiology and genetics in the coevolution of parasites and hosts. *Proceedings of the Royal Society of London* **B219**, 281-313.

Maynard Smith, J. (1956). Fertility, mating behaviour and sexual selection in *Drosophila subobscura*. *Journal of Genetics* **54**, 261-79.

Maynard Smith, J. (1966). Sympatric speciation *American Naturalist* **100**, 637-50.

Maynard Smith, J. (1974a). *Models in ecology*. Cambridge University Press.

- Maynard Smith, J. (1974b). The theory of games and the evolution of animal conflicts *Journal of Theoretical Biology* **47**, 209-21.
- Maynard Smith, J. (1978). *The evolution of sex*. Cambridge University Press.
- Maynard Smith, J. (1982). *Evolution and the theory of games*. Cambridge University Press.
- Maynard Smith, J. (1988). Selection for recombination in a polygenic model: the mechanism *Genetical Research, Cambridge* **51**, 59-63.
- Maynard Smith, J. (1995). Do bacteria have population genetics? In *Population genetics of bacteria*, (ed. S. Baumberg *et al.*), pp. 1-12. Cambridge University Press.
- Maynard Smith, J. and Brown, R.L.W. (1986). Competition and body size. *Theoretical Population Biology* **30**, 166-79.
- Maynard Smith, J. and Sondhi, K.C. (1960). The genetics of a pattern. *Genetics* **45**, 1039-50.
- Maynard Smith, J. and Szathmari, E. (1995) *The major transitions in evolution*. W.H. Freeman, Oxford.
- Mayr, E. (1963). *Animal species and evolution*. Harvard University Press.
- Metcalf, R.A. and Whitt, G.S. (1977a). Intra-nest relatedness in the social wasp *Polistes metricus*. *Behavioural Ecology and Sociobiology* **2**, 339-51.
- Metcalf, R.A. and Whitt, G.S. (1977b). Relative inclusive fitness in the social wasp *Polistes metricus*. *Behavioural Ecology and Sociobiology* **2**, 353-60.
- Michod, R.E. and Levin, B.R. (1988). *The evolution of sex: an examination of current ideas*. Sinauer, Sunderland.
- Mitton, J.B. and Grant, M.C. (1984). Associations among protein heterozygosity, growth rate and developmental homeostasis. *Annual Review of Ecology and Systematics* **15**, 479-99.
- Moll, R.H., Lindsey, M.F., and Robinson, H.F. (1964). Estimates of genetic variances and levels of dominance in maize. *Genetics* **49**, 411-23.
- Mukai, T. (1969). The genetic structure of natural populations of *Drosophila melanogaster*. VII. Synergistic interaction of spontaneous mutant polygenes controlling variability *Genetics* **61**, 749-61.
- Muller, H.J. (1932). Some genetic aspects of sex *American Naturalist* **66**, 118-38.
- Nee, S. (1987). The evolution of multicompartmental genomes in viruses *Journal of Molecular Evolution* **25**, 277-81.
- Nei, M. (1972). Genetic distance between populations. *American Naturalist* **106**, 283-92.
- Nei, M. (1975). *Molecular population genetics and evolution*. North Holland, Amsterdam.
- Nei, M. (1987). *Molecular evolutionary genetics*. Columbia University Press, New York.
- Nei, M. and Graur, D. (1984). Extent of protein polymorphism and the neutral mutation theory. *Evolutionary Biology* **17**, 73-118.
- Nei, M. and Koehn, R.K. (ed.) (1983). *Evolution of genes and proteins*. Sinauer, Sunderland.
- O'Brien, S.J. *et al.* (1985). Genetic basis for species vulnerability in the cheetah *Science* **227**, 1428-34.

- O'Donald, P. (1967). A general model of sexual and natural selection *Heredity* **31**, 145-56.
- Orgel, L.E. (1979). Selection *in vitro*. *Proceedings of the Royal Society of London* **B205**, 435-42.
- Orgel, L.E. and Crick, F.H.C. (1980). Selfish DNA: the ultimate parasite *Nature* **284**, 604-7.
- Packer, C., Herbst, L., Pusey, A.E., Bygott, J.D., Cairns, S.J., and Bergerhoff-Mulder, M. (1985). In *Reproductive success*, (ed. T.H. Clutton-Brock). University of Chicago Press.
- Peck, J.R. (1994). A ruby in the rubbish: beneficial mutations, deleterious mutations and the evolution of sex. *Genetics* **137**, 597-606.

- Perutz, M.F. (1983). Species adaptation in a protein molecule *Molecular Biology and Evolution* **1**, 1-28.
- Queller, D.C. (1985). Kinship, reciprocity and synergism in the evolution of social behaviour *Nature* **31B**, 366-7.
- Ridley, M. (1986). *Evolution and classification*. Longman, New York.
- Rose, M. and Charlesworth, B. (1980). A test of evolutionary theories of senescence *Nature* **287**, 141-2.
- Roughgarden, J. (1979). *Theory of population genetics and evolutionary ecology: an introduction*. MacMillan, New York.
- Schleger, G. and Dickie, M.M. (1971). Natural mutation rates in the house mouse. Estimates for five specific loci and dominant mutations *Mutation Research* **11**, 89-96.
- Seger, J. (1983). Partial bivoltinism may cause alternating sex ratio biases that favour eusociality *Nature* **301**, 59-62.
- Selander, R.K. (1976). In *Molecular Evolution*, (ed. F.J. Ayala), pp. 21-45. Sinauer, Sunderland.
- Selander, R.K. and Whittam, T.S. (1983). In *Evolution of genes and proteins*, (ed. M. Nei and R.K. Koehn). Sinauer, Sunderland.
- Sepkoski, J.J. Jr. (1984). A kinetic model of Phanerozoic taxonomic diversity. III. Postpalaeozoic families and mass extinctions *Palaeobiology* **10**, 246-67.
- Sheldon, P.R. (1987). Parallel gradualistic evolution of Ordovician trilobites from central Wales *Nature* **330**, 561-3.
- Sheppard, P.M. (1958). *Natural selection and heredity*. Hutchinson, London.
- Simpson, G.G. (1944). *Tempo and mode in evolution*. Columbia University Press, New York.
- Sinervo, B. and Lively, C.M. (1996). Lizards play rock-scissors-paper *Nature* **380**, 240-3.
- Slatkin, M. (1985). Gene flow in natural populations *Annual Review of Ecology and Systematics* **16**, 393-430.
- Sonneborn, T.M. (1970). Gene action on development. *Proceedings of the Royal Society B* **176**, 347-66.
- Stanley, S.M. (1979). *Macroevolution*. W.H. Freeman, San Francisco.
- Stenseth, N.C. and Maynard Smith, J. (1984). Coevolution in ecosystems: red queen evolution or stasis? *Evolution* **38**, 870-80.
- Stent, G.S. (1963). *Molecular biology of bacterial viruses*. W.H. Freeman, San Francisco.
- Strong, D.R., Lawton, J.H., and Southwood, R. (1984). *Insects on plants*. Blackwell, Oxford.
- Templeton, A.R. (1980). The theory of speciation via the founder principle *Genetics* **94**, 1011-38.
- Toro, M.A. and Charlesworth, B. (1982). An attempt to detect genetic variation in sex ratio in *Drosophila melanogaster*. *Heredity* **49**, 199-209.
- Trivers, R.L. (1971). The evolution of reciprocal altruism *Quarterly Review of Biology* **46**, 35-57.
- Turelli, M. (1986). In *Evolutionary processes and theory* (ed. S. Karlin and E. Nevo), pp. 607-28. Academic Press, New York.

Turner, J.R.G. (1977). In *Evolutionary Biology*, Vol. 10, (ed. M.K. Hecht, W.C. Steere, and B. Wallace), pp. 163-206. Plenum, New York.

Val, F.C. (1977). Genetical analysis of morphological differences between two interfertile species of Hawaiian *Drosophila*. *Evolution* **31**, 611-29.

- Van Valen, L. (1973). A new evolutionary law. *Evolutionary Theory* **1**, 1-30.
- Vrba, E.S. (1984). In *Living Fossils*, (ed. N. Eldredge and S.M. Stanley). Springer-Verlag, New York.
- Vrba, E.S. (ed.) (1985). *Species and speciation*. Transvaal Museum, Pretoria.
- Vrijenhoek, R.C. (1984). In *Population Biology and Evolution*, (ed. K. Woehrmann and V. Loeschke), pp. 217-31. Springer-Verlag, Berlin.
- Weismann, A. (1904). *On evolution*. Edward Arnold, London.
- White, M.J.D. (1978). *Modes of speciation*. W.H. Freeman, San Francisco.
- Williams, G.C. (1966). *Adaptation and natural selection*. Princeton University Press.
- Williams, G.C. (1975). *Sex and evolution*. Princeton University Press.
- Wilson, D.S. (1975). A theory of group selection. *Proceedings of the National Academy of Sciences, USA* **72**, 143-6.
- Wilson, D.S. (1980). *The natural selection of populations and communities*. Benjamin Cummings, Menlo Park, California.
- Wood, R.J. (1981). In *Genetic consequences of man-made change*, (ed. J.A. Bishop and L.H. Cooke), pp. 53-96. Academic Press, London.
- Wright, S. (1931). Evolution in Mendelian populations. *Genetics* **16**, 97-159.
- Wynne-Edwards, V.C. (1962). *Animal dispersion in relation to social behaviour*. Oliver and Boyd, Edinburgh.
- Yoo, B.H. (1980). Long-term selection for a quantitative character in large replicate populations of *Drosophila melanogaster*. I. Response to selection. *Genetical Research, Cambridge* **35**, 1-17.

Index

(Entries in **bold type** refer to definitions)

A.

Adalia bipunctata 260

Acrophenax 254

adaptive radiation 279-80

additive effects 94-5, 164

additive genetic model 96-108

adventitious embryony **229**

Aedes aegypti 254

age distribution 39

alcohol dehydrogenase 51-3

allelism of lethals 58-9

Allee, W.C. 18, 315

altruism

 between sibs 167-9

 evolution of 163-4

 reciprocal 167

Alu sequence 215-16

antelopes 284-5

amidase, evolution of 185-7

Anderson, R.M. 178, 181, 318

Anderson, M. 173, 263, 292

Angst, W. 318

Anguilla rostrata 152

anisogamy **229**

Antechinus 226

aphids 234

Aquilegia 273

Arak, A. 260, 315

asymmetric games 128-30

Australopithecus 116

Avise, J.C. 153, 160, 315

B

baboons 129

bacteriophage, *see* phage

Bakker, R.T. 290

Barrett, J.A. 198

Basidiomycetes, clamp connections in 228

Bell, G. 248, 315

Bendall, B.S. 223, 315

Bennett, J. 44-5, 315

Barenbaum, M. 290

binomial ditribution 25

binomial theorem 25

Biston betularia 42-4

bivalents 226

Boag, P.T. 49, 315

Bodmer, W.F. 223

bootstrap 304-5

bracken 289

Bradbury, J.M. 263, 315

Briscoe, D.A. 316

Brooks, L.D. 316

brother-sister mating 139-41

Brown, R.L.W. 132, 315

Brown, W.M. 152, 315

bryophytes 228

Bull, J. 263, 315

Bulmer, M.G. 106, 121, 315

Bumpus, H.C. 89, 315

Burt, A. 248, 315

C

canalization 102

carrying capacity 17-20

Cavalier-Smith, T. 202, 215

cell differentiation 10-11

and ploidy 228

central dogma 9-10, 12

centric fusion 220

centromeres 226-7

character displacement 287-8

Charlesworth, B. 50, 90, 118, 243, 315, 320

Charlesworth, D. 90, 243, 315

Charnov, E.L. 263, 315

cheetah 52

chiasmata 226

localized 226, 242

variance for number of 242, 248, 306

Christiansen, F. 288, 316

chromatids 225-6

chromosome

acrocentric 219

extraction scheme for 58

form, evolution of 219-23

heterosis in inversions 66-9

inversions in 54, 221-3

metacentric 219

number 219

translocations in 220

viability, in *Drosophila* 59-60, 63-4

cladocerans 234

Clarke, M.J. [105](#), [315](#)
Clarke, P.H. [185-7](#), [198](#)
classification [299](#)
Clay, K. [293](#), [315](#)
Clayton, G. [64](#), [315](#)
Cnemidophorus [230](#), [240-1](#)
Codium [228](#)
coefficient of inbreeding [142](#)
coefficient of kinship [142-3](#), [169](#)
coefficient of relatedness [142](#), [169-73](#)
coevolution [285-96](#)
coexistence, of competitors [17](#), [21](#)
collagen [207](#)
comparative method [305-6](#)
competition [21](#), [22](#), [285-7](#)
concerted evolution [203](#), [209-12](#)
cooperation, evolution of [164-73](#)
copia [213-14](#)
correlation coefficient [98-102](#), [109](#)
cortical inheritance [11](#)
covariance [98](#)
Coyne, J.A. [270](#), [296](#), [316](#)
creodonts [279](#)
Crick, F.H.C. [203](#), [319](#)
crossing-over [226](#)
 unequal [207-8](#), [210-12](#)
 within an inversion [221](#)
Crow, J.F. [45](#), [121](#), [316](#)
Cullis, C.A. [11](#), [316](#)
cultural inheritance [11](#)
Cunha, A.B. da [36](#), [316](#)

C-value paradox 201-2

Cyprinidae 209

cytoplasmic inheritance94

D

Daphnia 11

Darwin, C. 3-4, 8, 12, 17, 260, 316

Dawkins, R. 12-13, 77, 316

deletion 54

Demes 139, 173

Dempster, E.R. 70-2, 316

density-dependence 18-19, 72, 290

developmental constraints282-3

developmental homeostasis102

developmental noise94

Dickie, M.M. 61, 320

diffusion approximation26

dinoflagellates294

dioecy 140, 229, 255-8

DNA 4, 9-10

accuracy of replication24

content per nucleus 201-2

mitochondrial 151-4

rate of evolution 149

repetitive 203, 212-9

Dobzhansky, Th. 59, 66-7, 228, 316

Doolittle, W.F. 203, 316

Dover, G.A. 210, 223, 316

drift, genetic 24-7, 143-6

in structured populations 156-8

Drosophila

artificial selection in 50, 113-17

chromosome phylogeny in 222

electrophoretic mutants in 52, 61, 66, 68

meiosis in 220

mutations in natural populations 57-60

speciation in 270-1

D. heteroneura 272

D. mangabieri 231

D. melanogaster

accumulation of mutations in 62-3

alcohol dehydrogenase in 51

bobbed mutant in 212

copia in 213-14

hybrid dysgenesis in 214-15

insecticide resistance in 44

lethal mutations in 59-60

linkage disequilibrium in 87

longevity and fecundity in 118

ribosomal genes in 209-10

selection for sex ratio in 50

variation in isogenic line of 94

D. miranda 222

D. persimilis 222

D. polymorpha 36

D. pseudoobscura

chromosomal heterosis in 66-9

esterase-6 locus in 68

inversions in 222

viability of chromosome homozygotes in 59

D. subobscura

effects of inbreeding in 104-5

hybrid vigour in 105

selection for asymmetry in 50

sexual selection in 260-1

wing length in 95

D. sylvestris 272

Dubos, R. 292, 316

duplication 54, 207-9

Dykhuizen, D.E. 198, 317

E

Ectocarpus 228

effective population size 143-6

Eigen, M. 24, 27, 316

Eldredge, N. 275-6, 316

electrophoresis 50-1, 66

electrophoretic variation 51-3

mutation rate for 62

associated with inversions 67

at esterase-6 locus in *Drosophila* 68

absence of in inbred lines 141

selective neutrality of 146

in *E. coli* 194

endomitosis 230

enzymes

experimental evolution of 185-7

monomeric and dimeric 51, 52

environment

variability in space and time 70-5

coarse-grained 70-1

epistasis 81, 83, 87, 88, 96, 113, 242, 244

Escherichia coli 4, 188-9

logarithmic growth in 16

evolution of new gene functions in 186

population genetics of 194-5

ESS 125-36

in sexual populations 134-5

cooperative 165-6

and the sex ratio 251

and hermaphroditism 256

establishment of a new mutant 159-60

Eupagurus 219

evolution, *in vitro* 4-8

evolutionary game theory 125-36

evolutionary stable strategy, *see* ESS

exons 203-5

exploitation 285

extinction 280-1

F

Falconer, D.S. [97](#), [115](#), [121](#), [316](#)
family selection [44-5](#)
Feldman, M.W. [247](#), [316](#)
female preference [260](#)
Fenchel, T. [288](#), [316](#)
Fenner, F. [178](#), [316](#)
fertility in structural heterozygotes [220-1](#)
Fester, R. [296](#), [318](#)
fibrinopeptide [159](#), [251](#)
Finnegan, D.J. [198](#), [213](#), [316](#)
Fisher, R.A. [38-9](#), [70](#), [159](#), [251](#), [264](#)
Fisher's fundamental theorem [117](#)
fitness [36-40](#)

- inclusive [173-4](#)
- marginal [38](#)
- mean [117](#)
- multiplicative [56](#)
- neighbour-modulated [174](#)
- with overlapping generations [39-40](#)
- relative and absolute [37](#)
- synergistic effects on [56](#), [164-6](#), [237-8](#)

fixation, at a locus [147](#)
Flavell, R.B. [223](#), [316](#)
Fowler, K. [94](#)
Frankham, R. [212](#), [316](#)
frequency dependence, *see* selection, frequency-dependent
frozen niche hypothesis [240](#)
Fucus [228](#)
fungi [228](#)
Futuyuma, D.J. [52](#), [198](#), [296](#), [317](#)

G

Galapagos Island finches [49](#)

Gale, J.S. 107, 317
gametes, euploid and aneuploid 220-1
gametophyte **228**
Gardiner, W. 27, 316
Gaussian distribution 96-8, 107
gene amplification 11
gene conversion 206, 212
gene-environment interaction 95, 112
gene frequency 31
gene function, evolution of 185-7
gene pool approach 32-33, 145
genetic distance **270**
genetic drift 24-7, 143-6, 156-8
genetic load 56-7, 217
George, M. 315
Geospiza fortis 49
germ cells, primordial 9
germ line 9, 11
Gilbert, W. 204, 317
Gillespie, J.H. 150-1, 160, 317
Gingerick, P.D. 275, 317
Givnish, T.J. 258, 317
gonochorism **229**
goose, barred 150
Gottlieb, L.D. 272, 317
Gotz, W. 318
Gould, S.J. 275, 316
Grafen, A. 170, 173, 180, 317
Grant, M.C. 68, 319
Grant, P.R. 49, 319
Graur, D. 53, 319
group selection 173-7, 240, 284-5, 291

growth rate, and heterozygosity 69

H

habitat selection 74

haemoglobin 203-7

 adaptive changes in 150

 rate of evolution of 148

 restriction site polymorphism 88

 sickle cell 65-6

Haigh, J. 237, 317

Haldane, J.B.S. 69, 159, 274, 317

half-sibs 111-12

Hamilton, W.D. 169-74, 181, 254, 317

Hamilton's rule **169-73**

haplo-diploids, relatedness in **171-3**

Hardy-Weinberg ratio **31-6, 67**

Harrison, B.J. **114, 318**

Hartl, D.L. **45, 198, 317**

Harvey, P.H. **306, 316, 317**

Hasegawa, M. **152, 317**

hawk-dove game **125-8**

- asymmetric **128**

Heliconius, mimicry in **86-7**

heredity, defined **3-4**

heritability

- broad and narrow sense **111**
- realized **108, 111, 113-14**

hermaphroditism **229, 255-8**

- resource allocation in **257**
- and seed dispersal **258**

Herre, E.A. **292, 317**

heterokaryon **228**

heterosis **65-9**

heterostyly **84-5**

Hieracium **268**

hill-climbing **7, 274**

Hillis, D.M. **306, 317**

hitch-hiking **242, 245**

Hollingsworth, M.J. **104, 317**

homoplasmy **299, 300, 304-5**

horizontal transfer of genes **188, 207, 215, 219, 304**

host-parasite interactions **292-5**

hybrid dysgenesis **214-15, 218**

hybrid infertility **214**

hybrid inviability 214

hybrid vigour 105, 107

Hydrobia 287-8

I

identity by descent 98-100, 108, 141-3, 169-73

inbreeding 100-4, 139-43

 coefficient of 142

inbreeding depression 104-8, 255

information, genetic 9-12

insecticide resistance 43-5

insertion sequences 188, 190

insulin 148

intrinsic rate of increase 15, 20, 21, 39-40

introns 149, 203-5

inversions

 heterosis in 67-8

 in inbred lines 141

 intragenic and chromosomal 54

 paracentric and pericentric 220

 phylogeny of 222

island model 154-6

isogamy 229

isogenic line 63, 94

isolating mechanisms 269

 pre- and post-zygotic 270

isopondylida 209

Ito, K. 318

J

Jacana 258

Jacob, F. 186

Jeffreys, A.J. 204, 223

Jones, J.S. 68, 281, 317

Jukes, T.H. [146](#), [318](#)

K.

Kan, Y.W. [88](#), [317](#)

karyotype [217](#)

 evolution of [217-23](#)

Kettlewell, H.B.D. [43-4](#), [317](#)

Kimura, M. [45](#), [146](#), [150-1](#), [160](#), [318](#)

King, J.L. [146](#), [318](#)

kin selection [175](#), [191](#)

kinship, coefficient of [142](#)

Kirkpatrick, M. [261](#), [318](#)

Kishino, H. [317](#)

Klebsiella aerogenes [187](#)

Kondrashov, A.S. [237](#), [247](#), [318](#)

Koptur, S. [295](#), [317](#)

Kreitman, M. [51](#), [318](#)

Kummer, H. [129](#), [318](#)

L

Lacerta [230](#)

lactalbumen [209](#)

Lamarck, J.-B. [8](#)

Lamarckian inheritance [8-12](#), [45](#), [93](#)

Laminaria [228](#)

Lande, R. [119](#), [261-2](#), [272](#), [318](#)

Langley, C.H. [87](#), [318](#)

Law, R. [294-5](#), [318](#)

Lawton, J.H. [296](#), [320](#)

Lenski, R.E. [198](#)

Levene, H. [70-4](#), [318](#)

Levin, B.R. [198](#), [248](#), [319](#)

Lewis, D.H. [294](#), [318](#)

Lewontin, R.C. [76](#), [318](#)

Li, W.H. [150](#), [318](#)

Lindsey, M.F. [319](#)

linkage disequilibrium [81-90](#)

and normalizing selection [89-90](#)

and selection for recombination [244-8](#)

and sexual selection [261](#)

coefficient of [83](#)

in natural populations [87-8](#)

Linum [11](#)

lions, cooperation in [165](#)

Lively, C.M. [130](#), [234](#), [318](#), [320](#)

llama, haemoglobin of 150

local mate competition 254

logarithmic growth 16

logistic equation 17-19

Lotka, A.J. 16, 39

lysozyme 208

M

Majerus, M.E.N. 260, 318

Malecot, G. 159

Malthus, T.R. 17

Malthusian parameter 38

Margulis, M. 296, 318

Mather, K. 114, 318

mating, random 33-6, 62

mating table 34

May, R.M. 178, 181, 292, 318

Maynard Smith, J. 27, 50, 104, 105, 134, 135, 246, 248, 260, 295, 319

maximum likelihood 303

Mayr, E. 296, 319

mean fitness 117

meiosis 225-7

 achiasmate 226

 cost of 233

 in parthenogens 230-2

 in structural heterozygotes 220-1

meiotic drive 254

melanism, industrial 42-4

Metcalf, R.A. 175, 319

Michod, R.E. 248, 319

migration 154-8

mimicry 85-7

mismatch repair **61**

mitochondrial DNA 151-4

Mitton, J.B. 68, 319

Moble, B.K. 306, 317

Moll, R.H. 106-7, 319

monocotyledons 282-3

Monod, J. 186

monoecy **229**

monophyletic **299**

mouse

- chromosome evolution in 222
- coat colour mutants in 61
- growth rate 95

Mukai, T. 62, 63, 319

Muller, H.J. 57, 235-7, 319

Muller's ratchet 236-7, 241, 247

multiplicity of infection **198**

Muntiacus muntjac 219

mutation 7, **20**, 53-65

- back **68**
- balance between selection and 23, 55-7, 119-21
- base substitution 54
- caused by transposition 217
- deleterious 57-60, 63-4
- dominant, spread of 43-4
- equilibrium between drift and 146
- forward **60**
- frame-shift 54, 204, 214
- generation of variation by 64-5, 119-21
- lethal 57-9
- neutral 147
- rate of, at a locus 61-3

regulatory 217

synonymous 62, 149

mutational load 56-7

mutualism 285, 294-5

mycelium 228

myxoma virus 177-8, 292

N

natterjack toad 260

nature 93-6

natural selection 3-4, 7, 12, 18

Nee, S. 196, 319

Nei, M. 53, 76, 156, 159, 270, 319

Neisseria 305

Neo-Darwinism 11

net reproductive rate 39-40

neutral mutation theory 146-51

norm of reaction 95

normal distribution 96-8

Nurthen, R.K. 316

nurture 93-5

O

O'Brien, S.J. 52, 319

O'Donald, P. 261, 318, 319

Ogygiocarella 277

Opuntia 287

Orgel, L.E. 6, 203, 319

origin of life 24

Orr, H.A. 270, 296, 316

orthoselection 223

outcrossing 255

overdominance, true and associative 104, 106-7

overlapping generations 38-40

P

Packer, C. [165](#), [319](#)

Pagel, M.D. [317](#)

Papaver dubium [107](#)

Papilio

coevolution with insects [290](#)

mimicry in [86-7](#)

Parascaris [219](#)

parasites [69](#), [234-6](#), [292-3](#)

parental expenditure [254](#)

parsimony 300-4

parthenogenesis 229-34

apomictic 230

automictic 230

cyclical 234

distribution of 233-4

Peck, J.R. 239, 319

Peromyscus maniculatus 151-3, 305

Perutz, M.F. 151, 320

Phacops 276-7

phage 187

antibiotic resistance in 189

co-evolution with bacteria 189

lambda 189

lysogenic 187

lytic cycle in 187, 189

temperate 187, 189

virulent 187

Phillips, D.C. 223

phylogenetic trees 299-306

reliability of 303-5

rooting 300, 303-4

use of outgroup 303-4

phylogeny

and horizontal gene transfer 219

computer-generated 279

of chromosome order 222

of *Drosophila* 270

of haemoglobin 206

using mtDNA 152-4

Pieris 288

plant-herbivore interactions 287-90

plasmids **187**, 190-2

ColE1 191

conjugative **187**

drug resistance in 190

F 191-2

in natural populations 195

mobilizable **188**

self-transmissible **188**

pleiotropism 115, 171

Plethodon 217-18

Poeciliopsis 234-5, 240

Poisson distribution **25**, 26, 149, 159

Polistes metricus 175-6

polymorphism

electrophoretic 51-3

for restriction sites 88

frequency-dependent 128, 131, 134

in varied environment 70-5

protected **65**, 72

polyploidy **207**, 209, 274

polytypic species 74

population cage experiments 59, 66-9

population growth 15-17

with overlapping generations 39

population regulation 18-20, 38-9, 72, 117

prey-predator interactions 290-2

Primula 84, 86

prisoner's dilemma game 168

prophage **187**

proof-reading 24, **61**

proteins, rate of evolution of 148-9

Pseudomonas aeruginosa, [185-7](#), [191](#)

pseudogamy [241](#)

pseudogenes [149-204](#)

Pteridium aquilinum [289](#)

Pteridophytes [228](#)

punctuated equilibria [275-7](#), [281](#), [284](#)

Q

Q β replicase [4-6](#)

Queller, D.C. [170](#), [320](#)

R

rate of evolution [274-7](#)

recombination [13](#), [226-7](#)

 and evolution rate [235](#)

 and tree construction [305](#)

 evolution of [241-8](#)

Red Queen [295-6](#)

reinforcement hypothesis [269-71](#)

relatedness

 and cooperation [167-73](#)

 coefficient of [142](#)

 in haplodiploids [171-3](#)

relatives, resemblance between [97-100](#), [111](#)

replication accuracy [20-4](#), [196](#)

restriction endonuclease [53](#), [189](#)

restriction maps [87](#), [151](#)

restriction site polymorphism [87](#)

retrovirus [213](#), [216](#)

reverse transcription [10](#), [205](#), [213](#), [215](#)

Rhizobium [294](#)

ribosomal genes [11](#), [209-10](#)

Ridley, M. [306](#), [320](#)

RNA

accuracy of relication 24
evolution *in vitro* 4-6
messenger 10, 205
ribosomal 209-10, 299
Robertson, A. 64, 315
Robinson, H.F. 319
Rose, M. 118, 320
rotifers, parthenogenesis in 234
Roughgarden, J. 26, 45, 287, 320
Rubus 268
Rudder, B. 316
runaway process 263, 279

S

salamanders 217

Salmo 207-8

Salmonella typhimurium 188

Sapienza, C. 203, 316

Schleger, G. 61, 320

Schuster, P. 27, 316

Seger, J. 173, 320

Selander, R.K. 52, 199, 320

selection

artificial 49-50, 113-16

correlated responses to **115**

differential **103**

directional 103-8, 245, 275

distinguished from drift 26

family 44-5

frequency-dependent 20, 69-70, 74, 125-36

intensity **103**, 108

in trait groups 163-4

levels of 75-6, 225

limits to **113-16**

natural 3-4, 7, 12, 18

response **103**, 115

synergistic 164-5, 237-9, 247

selection, between groups, *see* group selection

selfing 107, 139-40, 255

and Muller's ratchet 237

self-sterility 84, 233

Sepkoski, J.J. Jr 280, 320

sex, cost of 230-33

and evolution rate 235

sex ratio 251-55
 in haplo-diploids 253
sexual dimorphism 70, 259
sexual selection 258-63
Sharp, P.M. 318
Sheldon, P.R. 277-8, 320
shifting balance theory 179-80
Shigella 188
Simpson, G.G. 275, 296, 320
Slatkin, M. 198, 296, 317, 320
Solomon, R. 317
soma 8-9
Sondhi, K.C. 50, 319
Sonneborn, T.M. 11, 320
Sorex araneus 220
Southwood, R. 296, 320
sparrows 88
Spassky, B. 316
speciation 267-74
 allopatric **268**
 by allopolyploidy 274
 role of repetitive DNA in 218
 sympatric **268**
species selection 284
Spirogyra 228
sporophyte **228**
Stanley, S.M. 275, 296, 320
stasis 275-7, 281
state space 21, 22
Stenseth, N.C. 295, 320
Stent, G.S. 16, 320
stepping-stone model 155

strategies

bourgeois [128](#)

in evolutionary games [125](#)

pure and mixed [125](#)

tit-for-tat [166](#)

Strong, D.R. [289-90](#), [296](#), [320](#)

substitution, at a locus [147](#)

sugar cane [288](#)

supergene [85-7](#)

syngamy [225](#)

Szathmari, E. [24](#), [319](#)

T

Taka-aki, Y. [317](#)

Tanimura, M. [318](#)

Templeton, A.R. [274](#), [296](#), [320](#)

Thomas, W.T.B. [317](#)

Tidwell, T. [316](#)

Toro, M.A. [50](#), [320](#)

trait group model [163-4](#)

transposable elements, *see* transposons

transposons [192-4](#), [203](#), [213](#), [216-19](#)

in *Drosophila* [213-15](#)

in mammals [215](#)

tree, phylogenetic, *see* phylogenetic trees

trends in evolution [277-9](#)

trilobites [276-7](#)

Trivers, R.L. [167](#), [181](#), [320](#)

Turelli, M. [120](#), [121](#), [320](#)

Turner, J.R.G. [90](#), [320](#)

U.

Ulva [228](#)

Umbelliferae, coevolution in [290](#)

V

Val, F.C. [272](#), [320](#)

Van Valen, L. [295](#), [321](#)

variance [95](#)

vegetative reproduction [230](#)

Vidua [268](#)

viruses

 myxoma [177-8](#)

 multicompartment [195-7](#)

Voelker, R.A. [318](#)

Volvocales, anisogamy in [229](#)

Vrba, E.S. [284](#), [296](#), [321](#)

Vrijenhoek, R.C. [240](#), [321](#)

W

Wahlund effect [35](#)

Wallace, A.R. [17](#)

war of attrition game [132](#)

Watanabe, T. [190](#)

Weir, T. [318](#)

Weismann, A. [8-9](#), [86](#), [321](#)

White, M.J.D. [223](#), [321](#)

Whitt, G.S. [175](#), [319](#)

Whittam, T.S. [199](#), [320](#)

Williams, G.C. [181](#), [248](#), [284](#), [321](#)

Wilson, A.C. [315](#)

Wilson, D.S. [163](#), [181](#), [321](#)

Winkler-Oswatisch, R. [27](#), [316](#)

Wood, R.J. [43](#), [321](#)

Wright, S. [154](#), [179-80](#), [321](#)

Wynne-Edwards, V.C. [173](#), [321](#)

X

Xenopus [206](#)

Y

Y chromosome [237](#), [300](#)

Yamazaki, T. [68](#), [317](#)

Yoo, B.H. [116](#), [321](#)

Z

Zuberi, M.I. [317](#)